

Part No.: RN0332R0107



English

# LED LCD TV User's Manual

Model Number.  
LED32B30RQ

Please register your product at [www.rca.com](http://www.rca.com)

Please keep your sales receipt and keep the record of the serial number and the date of purchase in order to receive warranty parts and service.

The serial number is located at the back of the TV.

**Serial Number / Número de serie de TV**

---

**Date of Purchase / Fecha de la compra**

---

Made for Today.  
[www.rca.com](http://www.rca.com)



## **CHILD SAFETY:**

It Makes A Difference How and Where  
You Use Your Flat Panel Display

Congratulations on your purchase! As you enjoy your new product, please keep these safety tips in mind:



### **THE ISSUE**

- The home theater entertainment experience is a growing trend and larger flat panel displays are popular purchases. However, flat panel displays are not always supported on the proper stands or installed according to the manufacturer's recommendations.
- Flat panel displays that are inappropriately situated on dressers, bookcases, shelves, desks, speakers, chests or carts may fall over and cause injury.

### **THIS MANUFACTURER CARES!**

- The consumer electronics industry is committed to making home entertainment enjoyable and safe.

### **TUNE INTO SAFETY**

- One size does NOT fit all. Follow the manufacturer's recommendations for the safe installation and use of your flat panel display.
- Carefully read and understand all enclosed instructions for proper use of this product.
- Don't allow children to climb on or play with furniture and television sets.
- Don't place flat panel displays on furniture that can easily be used as steps, such as a chest of drawers.
- Remember that children can become excited while watching a program, especially on a "larger than life" flat panel display. Care should be taken to place or install the display where it cannot be pushed, pulled over, or knocked down.
- Care should be taken to route all cords and cables connected to the flat panel display so that they cannot be pulled or grabbed by curious children.

### **WALL MOUNTING: IF YOU DECIDE TO WALL MOUNT YOUR FLAT PANEL DISPLAY, ALWAYS:**

- Use a mount that has been recommended by the display manufacturer and/or listed by an independent laboratory (such as UL, CSA, ETL).
- Follow all instructions supplied by the display and wall mount manufacturers.
- If you have any doubts about your ability to safely install your flat panel display, contact your retailer about professional installation.
- Make sure that the wall where you are mounting the display is appropriate. Some wall mounts are not designed to be mounted to walls with steel studs or old cinder block construction. If you are unsure, contact a professional installer.
- A minimum of two people are required for installation. Flat panel displays can be heavy.



## SEGURIDAD DE NIÑOS:

El Cómo y Dónde Usted Usar Su Monitor de Pantalla Plana Marca La Diferencia

¡Muchas gracias por su uso del presente producto! Cuando usted disfruta de su nuevo producto, por favor tenga en cuenta los consejos de seguridad:



### POSIBLES PROBLEMAS

- La experiencia de entretenimiento de cine en casa es una tendencia creciente y los grandes monitores de pantalla plana son muy populares. Sin embargo, los monitores de pantalla plana no se han instalado siempre en los soportes adecuados o instalado de acuerdo con las recomendaciones de fabricante.
- Los monitores de pantalla plana que se han instalado inadecuadamente en tocadores, estanterías, estantes, escritorios, oradores, baúles o carros se pueden caer y causar el daño corporal.

### ¡AL FABRICANTE LE IMPORTA!

- La industria electrónica del consumidor está comprometida a hacer el entretenimiento de casa agradable y seguro.

### AJUSTAR HASTA SEGURIDAD

- Un tamaño fijo NO es adecuado para todos. Siga las recomendaciones de fabricante para la instalación segura y el uso de su monitor de pantalla plana.
- Lea con cuidado y entienda todas las instrucciones adjuntas para el uso propio de este producto.
- No permita a los niños a subir al equipo o jugar con muebles y televisiones.
- No cloque los monitores de pantalla plana en el mueble que se puede usar fácilmente como escalón, así como una cómoda.
- Recuerde que los niños pueden llegar a ser excitados al ver una programación, especialmente en el monitor de pantalla plana "más grande que vida". El cuidado se tiene que empezar por poner o instalar el monitor donde no se puede empujar, detener al costado del camino ni echar abajo.
- El cuidado se tiene que empezar por encaminar todos los cordones y cables conectados al monitor de pantalla plana para que no se puedan tirar o agarrar por los niños curiosos.

### MONTAJE DE PARED: SI USTED DECIDE A MONTAR SU MONITOR DE PANTALLA PLANA A LA PARED, SIEMPRE:

- Use una montura que se ha recomendado por el fabricante de monitor y/o listado por un laboratorio independiente (como UL, CSA, ETL).
- Siga todas las instrucciones ofrecidas por el fabricante de monitor y montaje de pared.
- Si usted tiene cualquier duda sobre su habilidad para instalar seguramente su monitor de pantalla plana, contacte a su distribuidor para la instalación profesional.
- Compruebe que la pared adonde se está montando el monitor es adecuada. Algunos montajes de la pared no son diseñados para ser montados a paredes con tachones de acero o la vieja construcción de bloque de ceniza. Si usted está inseguro, contacte a un instalador profesional.
- Por lo menos dos personas se requieren para la instalación. Los monitores de pantalla plana puede ser pesados.

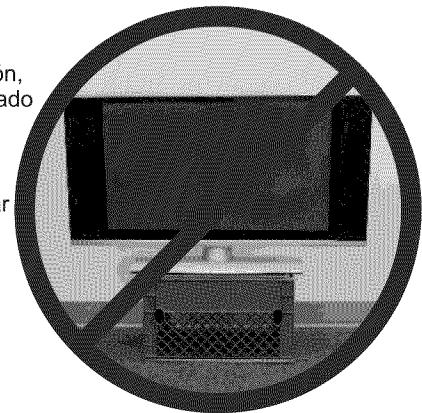

# Table of Contents

<b>Child Safety Guide</b> .....	1
<b>Caution and Warning</b> .....	5
<b>FCC Notice</b> .....	5
<b>Safety Precautions</b> .....	6,7
<b>Preparation for Your New TV</b> .....	8
Check Accessories .....	8
Setup TV Table Stand .....	8
Select TV Location .....	8
Connection and Using .....	8
<b>TV Stand Installation</b> .....	9
<b>TV Signal Connection</b> .....	10
<b>Cable Connections</b> .....	11
<b>Side Panel Connections</b> .....	12
Connecting AV Composite Video device (Good Video Quality) .....	12
Connecting YPbPr Component device (Better Video Quality) .....	13
Connecting HDMI device (Best Video Quality) .....	14
Connecting a Computer .....	15
How to Obtain Various Kinds of Input Sources .....	15
<b>TV Jacks Explanation</b> .....	16
<b>Bottom Keypad and Front Panel</b> .....	17
Bottom Side Keypad .....	17
Front Panel .....	17
<b>Remote Control Instructions</b> .....	18
Inserting Batteries in the Remote .....	18
Remote Control Reception Angle .....	18
<b>Learning about Remote Control</b> .....	19
Remote Control Buttons .....	19
<b>Initial Setup</b> .....	20
<b>Basic Operations</b> .....	21
Turning On and Off .....	21
Choosing TV Channel .....	21
Selecting Input Source .....	21
Channel Bar .....	22
Adjusting Volume .....	22
EPG (Electronic Program Guide) .....	22

# Table of Contents

<b>OSD Menu Operations</b> .....	23
Adjust the OSD Screen .....	23
Picture Menu .....	23
Sound Menu .....	25
Channel Menu .....	26
Parental Menu .....	27
Setup Menu.....	31
Others Menu .....	33
<b>Frequently Asked Questions (FAQs)</b> .....	34
<b>Troubleshooting</b> .....	35
<b>V-Chip Rating Explanations</b> .....	37
US V-Chip Rating System .....	37
Canadian English Rating System .....	37
Canadian French Rating System .....	38
<b>Wall Mounting Unit Specification</b> .....	39
<b>USB Media Play</b> .....	40
<b>Product Specification</b> .....	41
<b>Warranty Card</b> .....	42

# Caution and Warning



**CAUTION**  
**RISK OF ELECTRIC SHOCK**  
**DO NOT OPEN**



**Caution:** To reduce the risk of electric shock, do not remove cover or back. No user-serviceable parts inside. Refer servicing to qualified service personnel.



The lightning flash with arrowhead symbol, within an equilateral triangle is intended to alert the user to the presence of uninsulated dangerous voltage within the product enclosure that may be of sufficient magnitude to constitute a risk of electric shock.



The exclamation point within an equilateral triangle is intended to alert the user to the presence of important operating and maintenance (servicing) instructions in the literature accompanying the TV.

**WARNING: TO REDUCE THE RISK OF FIRE OR ELECTRIC SHOCK, DO NOT EXPOSE THIS APPLIANCE TO RAIN OR MOISTURE.**

**CAUTION: CHANGES OR MODIFICATIONS NOT EXPRESSLY APPROVED BY THE PARTY RESPONSIBLE FOR COMPLIANCE WITH THE FCC RULES COULD AVOID THE USERS AUTHORITY TO OPERATE THIS EQUIPMENT.**

## FCC Notice

### FCC Information

This equipment has been tested and found to comply with the limits for a Class B digital device, pursuant to Part 15 of the FCC rules. These limits are designed to provide reasonable protection against harmful interference in a residential installation. This equipment generates, uses and can radiate radio frequency energy and, if not installed and used in accordance with the instructions, may cause harmful interference to radio Communications. However, there is no Guarantee that interference will not occur in a particular installation. If this equipment does cause harmful interference to radio or television reception, which can be determined by turning the equipment off and on, the user is encouraged to try to correct the interference by one or more of the following measures:

- Reorient or relocate the receiving antenna.
- Increase the separation between the equipment and the receiver.
- Connect the equipment into an outlet on a circuit different from that to which the receiver is connected.
- Consult the dealer or an experienced radio/TV technician for help.

# Safety Precautions

1. Read these instructions.
2. Keep these instructions.
3. Heed all warnings.
4. Follow all instructions.
5. Do not use this apparatus near water. For example, do not use near a laundry tub, in a wet basement, or near a swimming pool, and the like.
6. Clean only with dry cloth.
7. Do not block any ventilation openings. Install in accordance with the manufacturer's instructions. Slots and openings in the cabinet back or bottom are provided for ventilation, to ensure reliable operation of the TV and to protect it from overheating. These openings must not be blocked or covered. The openings should never be blocked by placing the TV on a bed, sofa, rug, or other similar surface.
8. Do not install near any heat sources such as radiators, heat registers, stoves, or other apparatus (including amplifiers) that produce heat.
9. Do not defeat the safety purpose of the polarized or grounding-type plug. A polarized plug has two blades with one wider than the other. A grounding-type plug has two blades and a third grounding prong. The wide blade or the third prong is provided for your safety. If the provided plug does not fit into your outlet, consult an electrician for replacement of the obsolete outlet.
10. Protect the power cord from being walked on or pinched particularly at plugs, convenience receptacles, and the point where they exit from the apparatus.
11. Only use attachments/accessories specified by the manufacturer.
12. Use only with cart, stand, tripod, bracket, or table specified by the manufacturer, or sold with the apparatus. When a cart is used, use caution when moving the cart/apparatus combination to avoid injury from tip-over. A TV and cart combination should be moved with care. Quick stops, excessive force, and uneven surfaces may cause the TV and cart combination to overturn.
13. Unplug this apparatus during lightning storms or when unused for long periods of time. For added protection for this TV receiver during a lightning storm, or when it is left unused for long periods of time, unplug it from the wall outlet and disconnect antenna or cable system. This will prevent damage to the TV due to lightning and power line surges.
14. Refer all servicing to qualified service personnel. Servicing is required when the apparatus has been damaged in any way, such as power-supply cord or plug is damaged, liquid has been spilled or objects have fallen into the apparatus, the apparatus has been exposed to rain or moisture, does not operate normally, or has been dropped.
15. This TV should be operated only from the type of power supply indicated on the rating label. If customer is not sure the type of power supply in your home, consult your appliance dealer or local power company. For TV remote control battery power, refer to the operating instructions.
16. The TV set shall not be exposed to dripping or splashing. No objects filled with liquids, such as vases, shall be placed on the TV set.
17. Never push objects of any kind into this TV through openings as they may touch dangerous voltage or other electrical parts that could result in fire or electric shock. Never spill liquid of any kind into the TV.
18. Unplug the TV from the wall outlet before cleaning. Do not use liquid or aero cleaners. Use a damp cloth for cleaning.
19. This TV should never be placed near or over a radiator or heat resource. This TV should not be placed in a built-in installation such as a bookcase or rack unless proper ventilation is provided or the manufacturer's instructions have been adhered to.
20. Do not place this TV on an unstable cart, stand, tripod, bracket, or table. The TV may fall, causing serious injury to someone, and serious damage to the appliance.
21. Do not attempt to service this TV by yourself because opening or removing covers may expose you to dangerous high voltage or other hazards. Refer all servicing to qualified service personnel.
22. This device complies with Part 15 of the FCC Rules. Operation is subject to the following two conditions: (1) this device may not cause harmful interference, and (2) this device must accept any interference received, including interference that may cause undesired operation.



# Safety Precautions

23. **WARNING:** To prevent injury, this apparatus must be securely attached to the floor/wall in accordance with the installation instructions.
24. To reduce the risk of electric shock, the grounding of center pin of plug must be maintained.
25. If an outside antenna or cable system is connected to the TV, be sure the antenna or cable system is grounded to provide some protection against voltage surges and built-up static charges. Section 810 of the National Electrical Code, ANSI/NFPA NO.70, provides information with respect to proper grounding of the mast and supporting structure, grounding of the lead-in wire to an antenna discharge unit, size of grounding conductors, location of antenna discharge unit, connection to grounding electrodes, and requirements for the grounding electrodes. (See figure A)

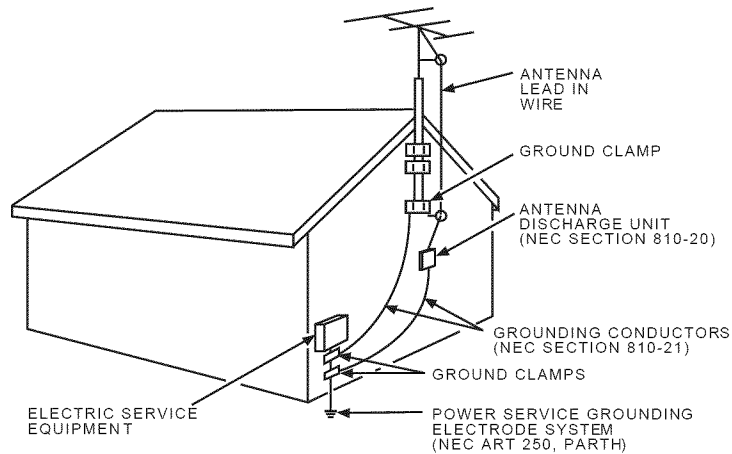

Figure A

## Safety Strap

**Caution:** Pushing, pulling or climbing on the TV may cause the TV falling. Do not let children climb or hang on the TV. Always place the TV on a sturdy, level, stable surface that can hold the weight of TV. And if possible, secure the TV according to the instruction below (Note: The fastening components such as screws are not supplied with TV).

- Step one: Insert the M6 mounting screws into the upper two wall mounting screw holes and fasten them (Figure B).
- Step two: Insert anchors to wall and connect the bolts and anchors with ropes or chains (Figure C).

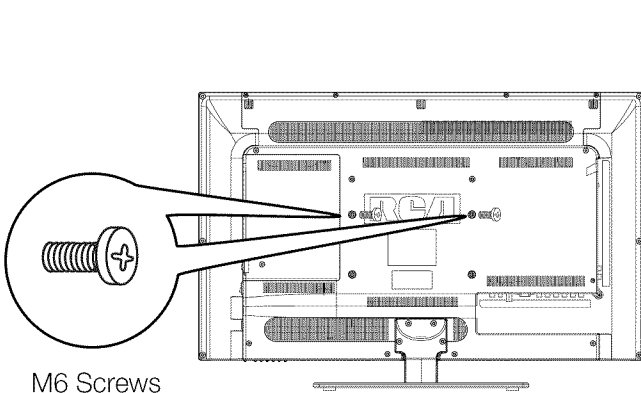

Figure B

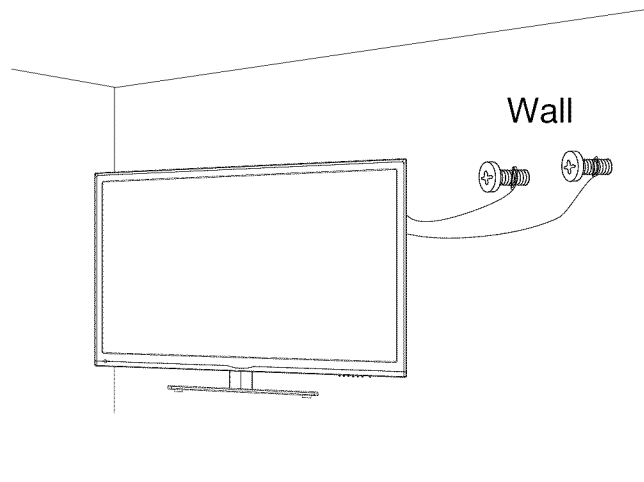

Figure C



# Preparation for Your New TV

## Before Turning On TV

### Check Accessories

Check the accessories that are packed with your TV.

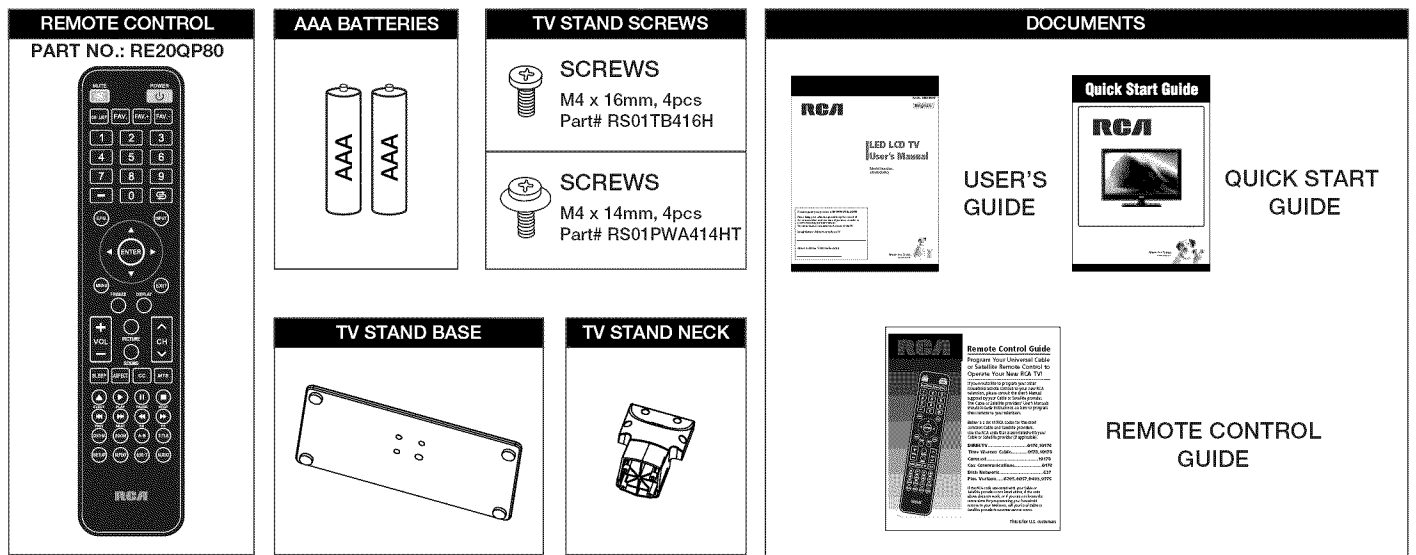

### Setup TV Table Stand

Please refer to TV Stand Installation guide in next page to carry out stand installing.

### Select TV Location

Select a flat, stable table to place your TV set. Please follow the Safety Instructions when placing the TV.

### Connection and Using

After placing your TV properly, you can connect the TV with power supply and cable components. For further information, see page 12 to page 15.

# TV Stand Installation

TV LED32B30RQ is packaged with the TV stand separated from the cabinet. To setup the TV table stand, please carry out the installation according to the instructions below.

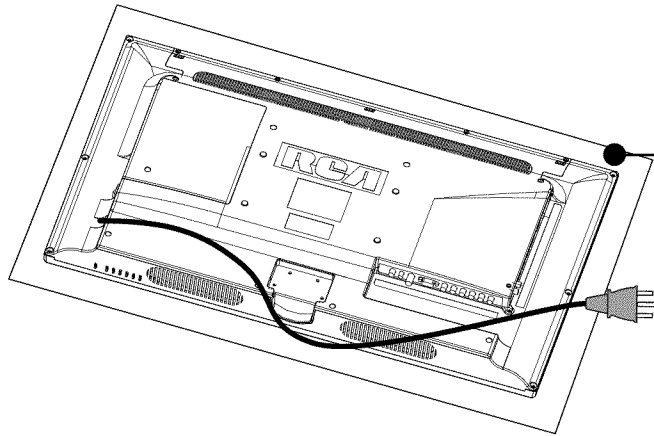

## Step One

Place the TV faced down on a soft cloth or cushion to prevent the panel from being damaged.

- The panel can be scratched easily, so please:
1. Choose an absolutely flat surface to place the TV on.
  2. Use soft cloth or cushion to face the TV panel.
- Do not put TV on the table directly.

Always unplug the AC cord first when installing/removing the stand.

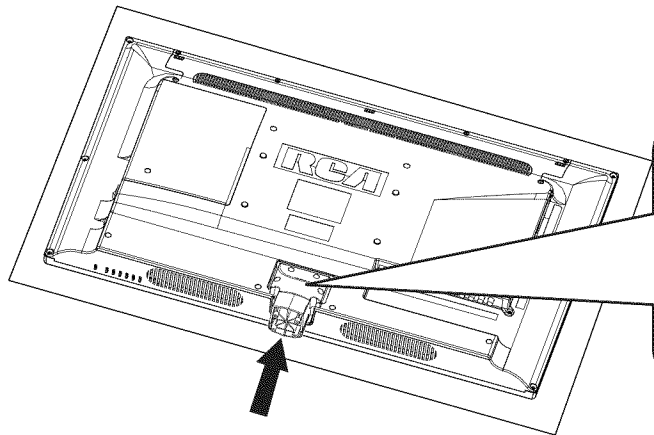

## Step Two

Take the neck. Please align the screw holes of the neck and the TV, and then insert the 4 screws into the 4 holes on the neck and tighten them.

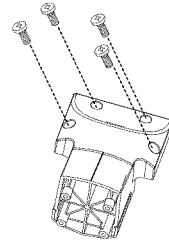

Pedestal Screws	Quantity	Part #
M4 x 16mm	4pcs	RS01TB416H

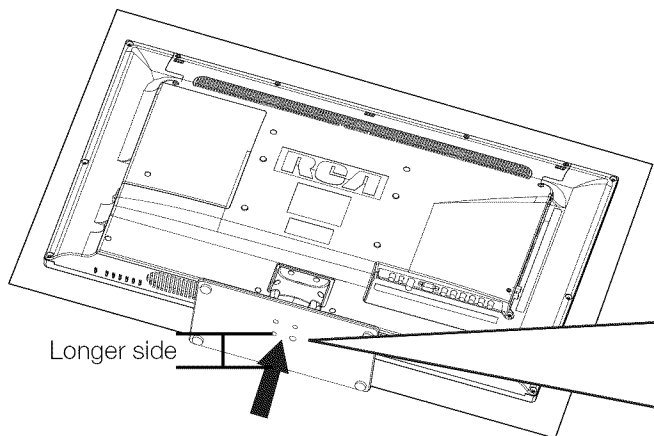

## Step Three

Take the base. Please align four holes of the base and four screwholes of the neck, insert the base to the neck, and then insert the 4 screws and tighten them.

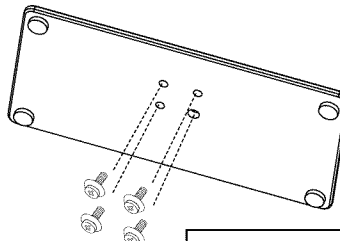

Pedestal Screws	Quantity	Part #
M4 x 14mm	4pcs	RS01PWA414HT

**Please take note of the base direction:**

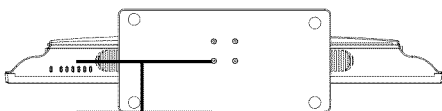

Longer side

The bottom view of the TV (Front cabinet faces down)

# TV Signal Connection

The first step in connecting your TV is obtaining the signal. Your TV LED32B30RQ has a side panel, which allows you to receive analog and/or digital television channels via ANT/CABLE jack.

Before connecting your TV, determine using an antenna or a cable service to obtain the signal.

## A. Antenna

Connect the antenna to TV via coaxial cable on ANT/CABLE jack of the side panel. You are ready to receive air local digital and analog channels.

## B. Cable TV service

Connect the cable TV wall jack to TV via coaxial cable on ANT/CABLE jack of the side panel. You are ready to receive off-air local digital and analog channels.

## C. Set-Top Box

If you use a set-top box, you may need to call your cable company or satellite service provider, which use a special connection, please refer to the user's guide of set-top box.

**Note:** Do not plug the AC cord until you have accomplished all the connections.

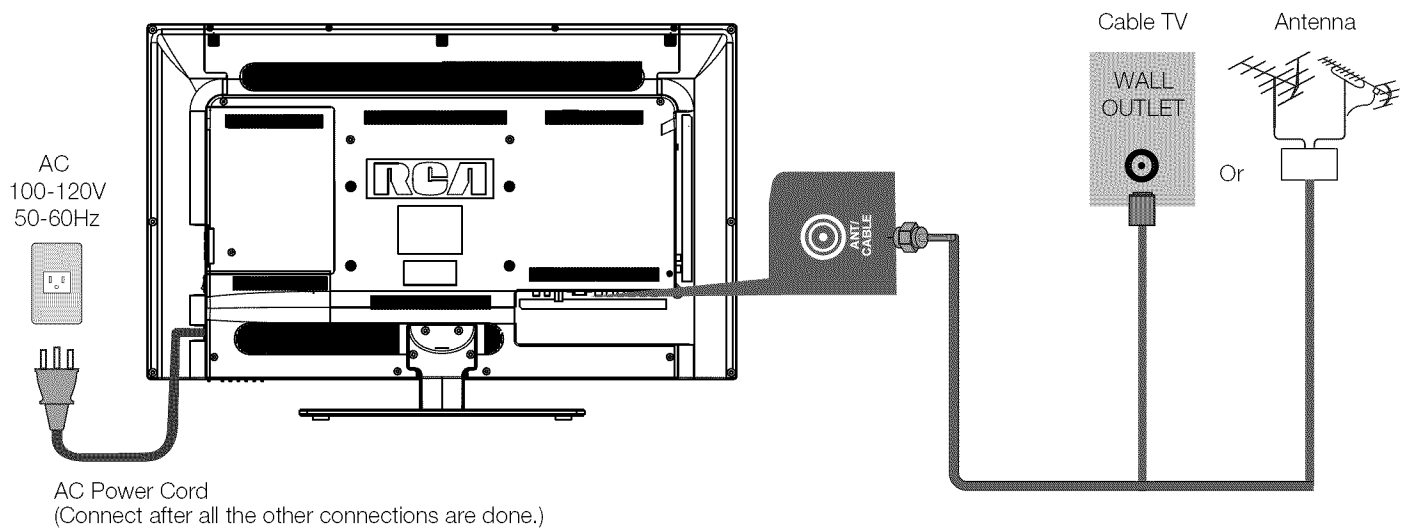

# Cable Connections

## Choose Your Connections

TV supports various connections to other devices (such as DVD, VCR, Set-top box, etc.). Please follow the table to choose the cables which adapt to your device.

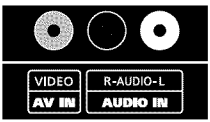
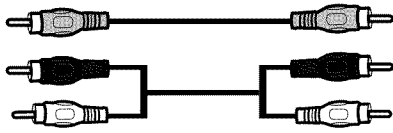
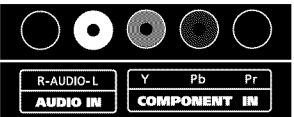
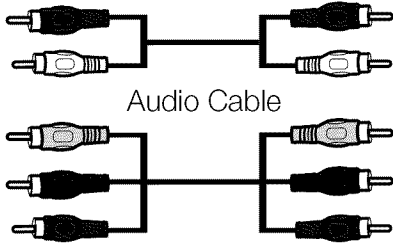
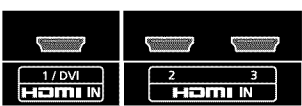
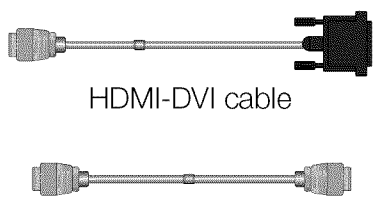
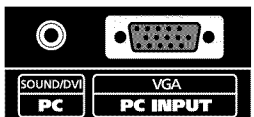
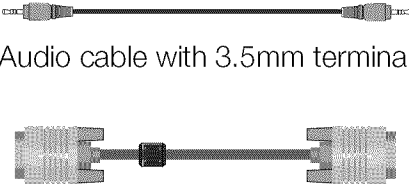
Jacks	Cables	Further Information
 <p>AV IN VIDEO, R-AUDIO-L</p>	 <p>Video/Audio cable</p>	Go to page 12
 <p>COMPONENT IN Y, Pb, Pr R-AUDIO-L</p>	 <p>Audio Cable COMPONENT video cable</p>	Go to page 13
 <p>HDMI IN 1/DVI, 2, 3</p>	 <p>HDMI-DVI cable HDMI cable</p>	Go to page 14
 <p>PC SOUND/DVI VGA VGA</p>	 <p>Audio cable with 3.5mm terminal VGA cable</p>	Go to page 15

**Note:**

HDMI, the HDMI logo, and High-Definition Multimedia Interface are trademarks or registered trademarks of HDMI Licensing LLC

**Caution:**

Unplug the AC cord when you connect other devices to TV.

# Side Panel Connections

## Connecting AV Composite device (Good Video Quality)

To connect a composite AV device, such as a DVD player, follow these steps:

1. Connect the VIDEO jack on the back of TV to the video output jacks of device via video cable (yellow).
2. Connect the R-AUDIO-L jacks on the back of TV to the audio output jacks of device via audio cable.

Notice the left channel jack and plugs are white and the right channel jack and plugs are red.

*Note: AV signal belongs to composite video. This kind of video signal has regular good display quality.*

### Composite Video Connection

The picture below is an example of a connection using the composite video jack.

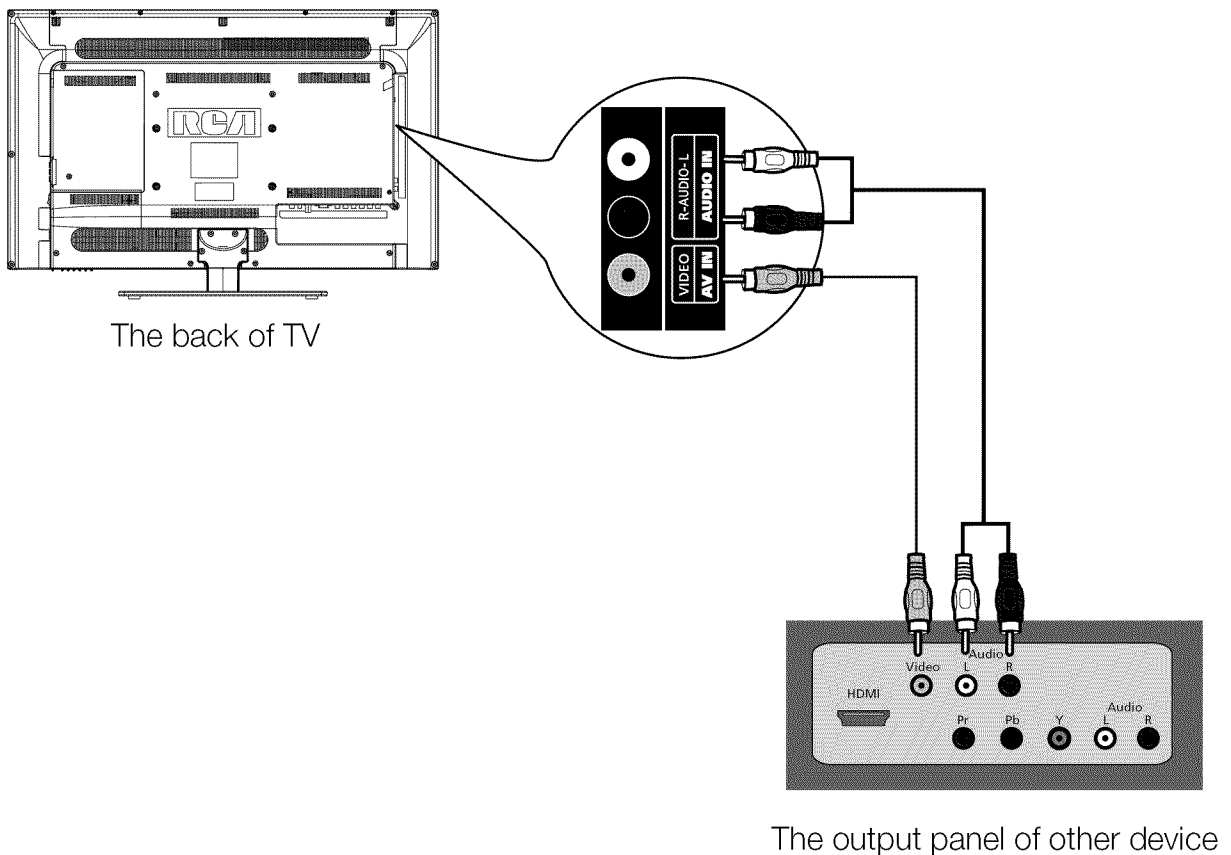

# Side Panel Connections

## Connecting YPbPr Component device (Better Video Quality)

To connect a component device, such as a DVD player, follow these steps:

1. Connect the COMPONENT IN Y/Pb/Pr jack on the side of TV to the video output jacks of device via video cable (green, blue and red).
2. Connect the AUDIO IN R-AUDIO-L jacks on the side of TV to the audio output jacks of device via audio cable.  
Notice the left channel jack and plugs are white and the right channel jack and plugs are red.

*Note: Y/Pb/Pr jacks are component video. This kind of video signal has better display quality.*

### Component Video Connection

The picture below is an example of a connection using the component video jack.

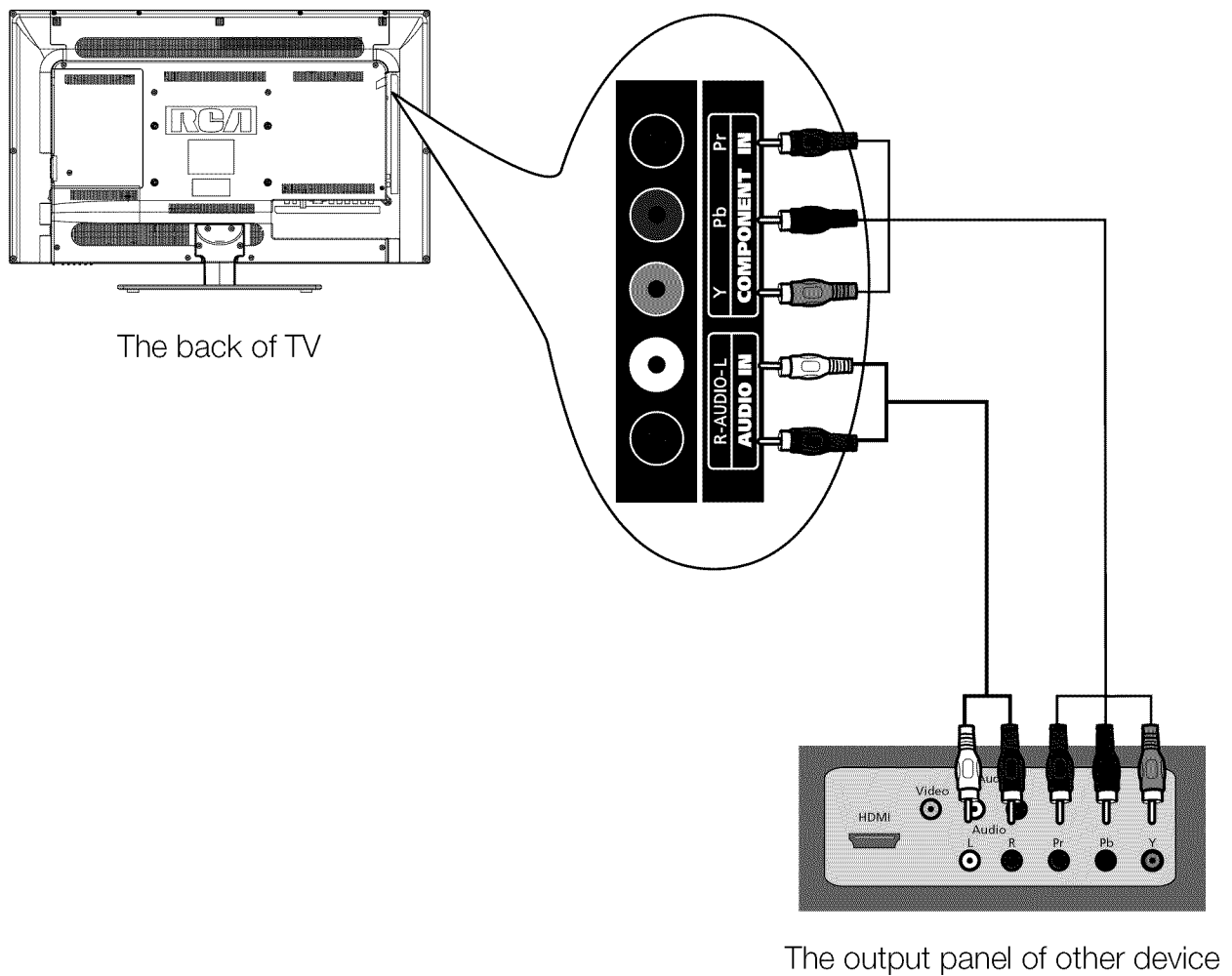

# Side Panel Connections

## Connecting HDMI device (Best Video Quality)

To connect a HDMI device, such as a DVD player, please Connect the HDMI 1/DVI, 2, or 3 jack on the back of TV to the output jacks of device via HDMI cable.

To connect a DVI device, such as a computer via DVI port of PC and HDMI jack of TV:

1. Connect the HDMI 1/DVI, 2, or 3 jack on the back of TV to the DVI port of PC via HDMI-DVI cable.
2. Connect the SOUND/DVI jack on the side of TV to the audio output jack of computer with audio cable (3.5mm stereo jack).

To connect a DVI device, other AV device via DVI port of device and HDMI jack of TV:

1. Connect the HDMI 1/DVI, 2, or 3 jack on the back of TV to the DVI port of device via HDMI-DVI cable.
2. Connect the SOUND/DVI jack on the back of TV to the audio output jack of device with audio cable (dual-channel RCA jacks to 3.5mm stereo jack).

*Note: 1. HDMI (High-Definition Multimedia Interface) is a compact audio/video interface for transmitting uncompressed digital data. It carries the audio and video signal via the same cable and has the best display quality.*

*2. HDMI-DVI cable transfers only video signal from DVI port of DVI device to HDMI jack of TV. For audio signal, please connect audio output to SOUND/DVI on TV back panel.*

## HDMI Connection

The picture below is an example of a connection using the HDMI video jack.

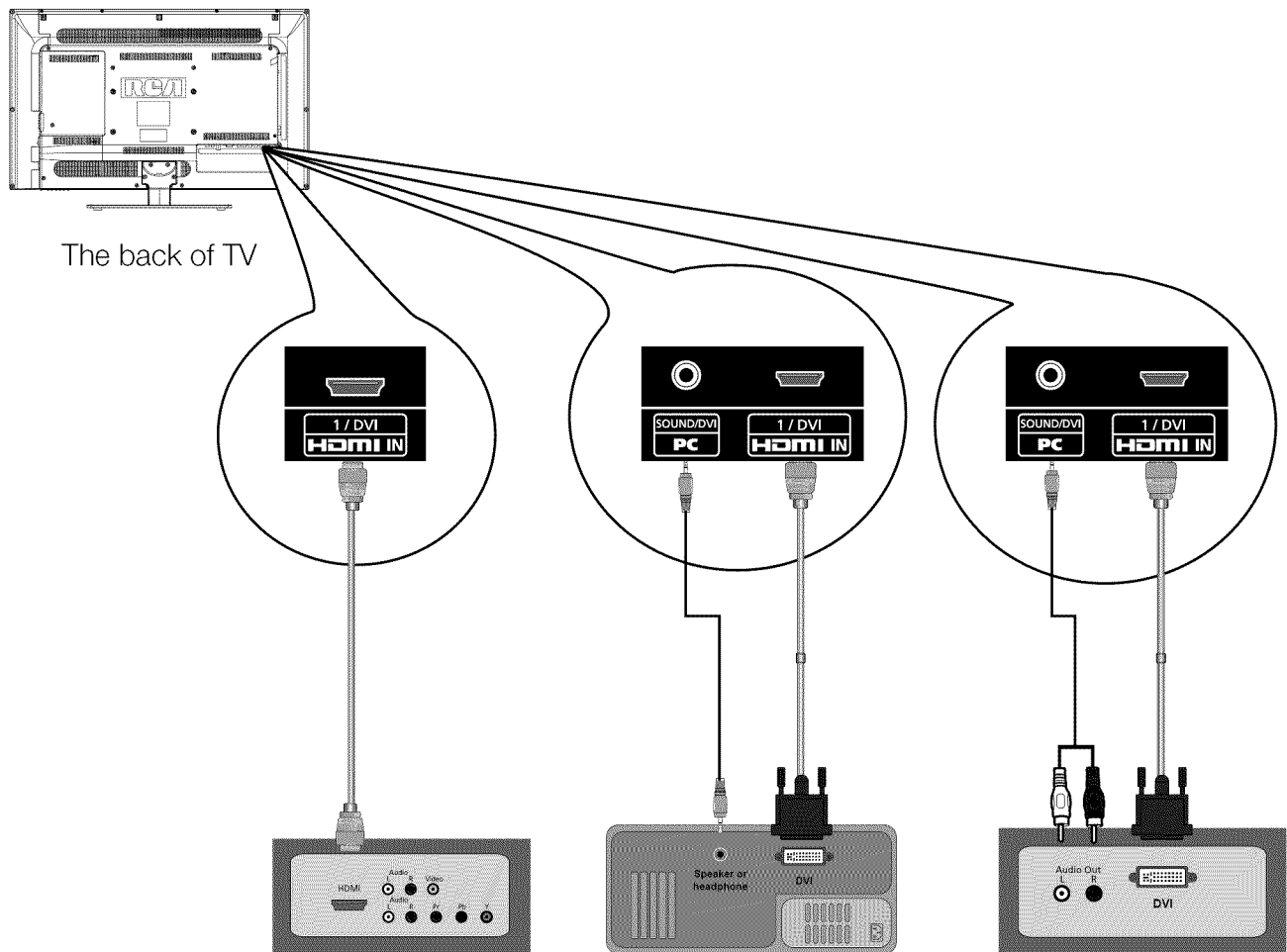

# Side Panel Connections

## Connecting a computer

To connect a computer, follow these steps:

1. Connect the PC INPUT VGA port on the back of TV to the VGA output jack of device via D-sub 15-pin cable.
2. Connect the SOUND/DVI jack on the back of TV to the audio output jack of computer with audio cable (3.5mm).

*Note: If you want to use your TV as a monitor, please notice that the maximum resolution for LED32B30RQ is 1366\*768. Please set the computer graphic correctly.*

## PC Connection

The picture below is an example of a connection using your TV as a PC monitor.

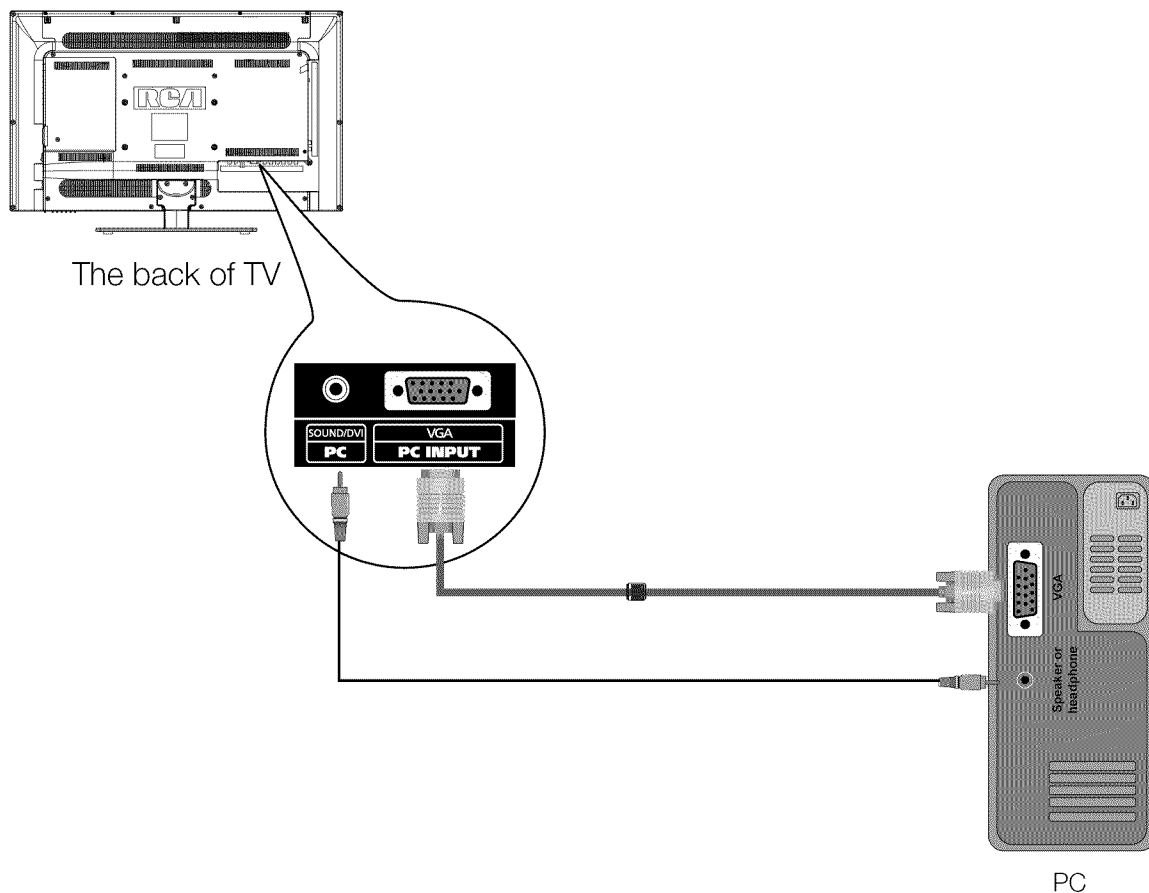

## How to Obtain Various Kinds of Input Sources

After connection is done, press INPUT button on remote control or TV top panel to choose the input source you need. See page 21, Basic Operation of TV.



# TV Jacks Explanation

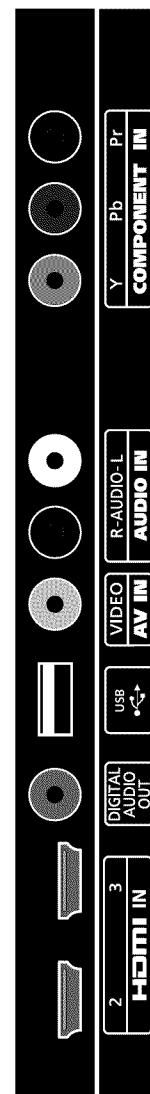
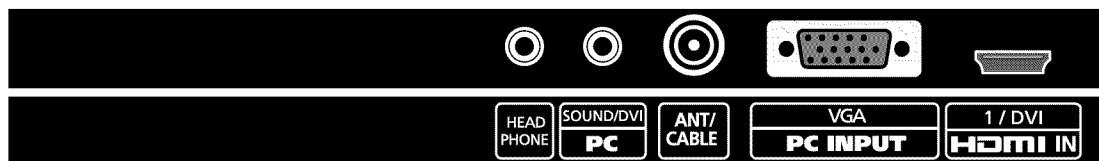
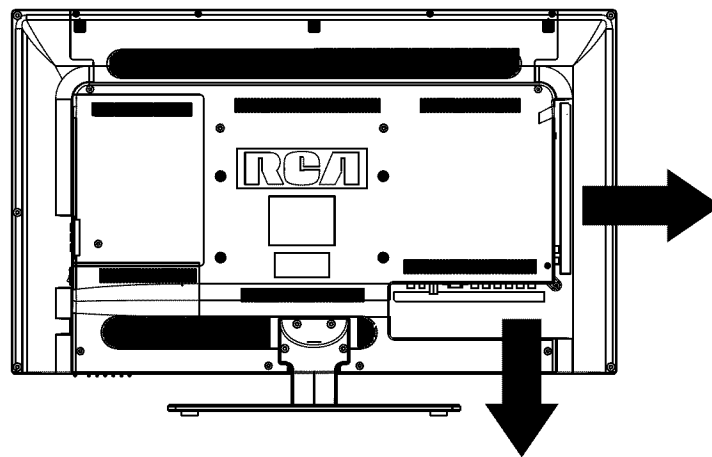

**HEAD PHONE:** Connect a 3.5mm headphone for personal audio.

**SOUND/DVI:** Use to obtain sound when a PC is connected to TV. Use 3.5mm stereo mini-pin cable to connect PC to TV.

**ANT/CABLE:** Connect to receive the signal from your antenna or cable via coaxial cable.

**PC INPUT VGA:** Connect your computer or other device with a VGA output to this jack using a 15-pin, D-sub cable.

**HDMI IN 1/DVI, 2, 3:** (High-Definition Multimedia Interface) It provides an uncompressed digital connection that carries both video and audio data by way of an integrated mini-plug cable.

**DIGITAL AUDIO OUT:** Connect a coaxial cable for digital audio output.

**USB:** Connect your USB storage device to enjoy music/photo files on your TV. (Also used for service purpose)

**AV IN VIDEO, R-AUDIO-L:** Connect an AV device that has composite video jacks, such as a VCR or a DVD player. To access device connected to these jacks, press the INPUT button on your remote; then press the up/down arrow to select AV. Press the ENTER button at last to confirm.

- **AUDIO-L:** Left audio channel connection. The left audio connector is usually white. For mono audio sources, be sure to use the left AUDIO INPUT.
- **AUDIO-R:** Right audio channel connection. The right audio connector is usually red.

**COMPONENT IN Y/Pb/Pr, R-AUDIO-L:** Connect a device that has component video jacks, such as a DVD player. To access device connected to the Y/Pb/Pr jack, press the INPUT button on your remote; then press the up/down arrow to select Component. Press the ENTER button at last to confirm.

- **Y/Pb/Pr (Component Video):** They provide good picture quality because the video signal is separated into three components. Use three video-grade or component video cables for the connection. When using Y/Pb/Pr, make sure you connect left and right audio cables to the Audio L and Audio R jacks.

**Note:** The VIDEO (AV), COMPONENT IN input (Y, Pb, Pr) share the same audio input jacks R-AUDIO-L.

# Bottom Keypad and Front Panel

## Bottom Side Keypad

If you cannot locate your remote, you can use the keypad buttons on your TV to operate many TV features.

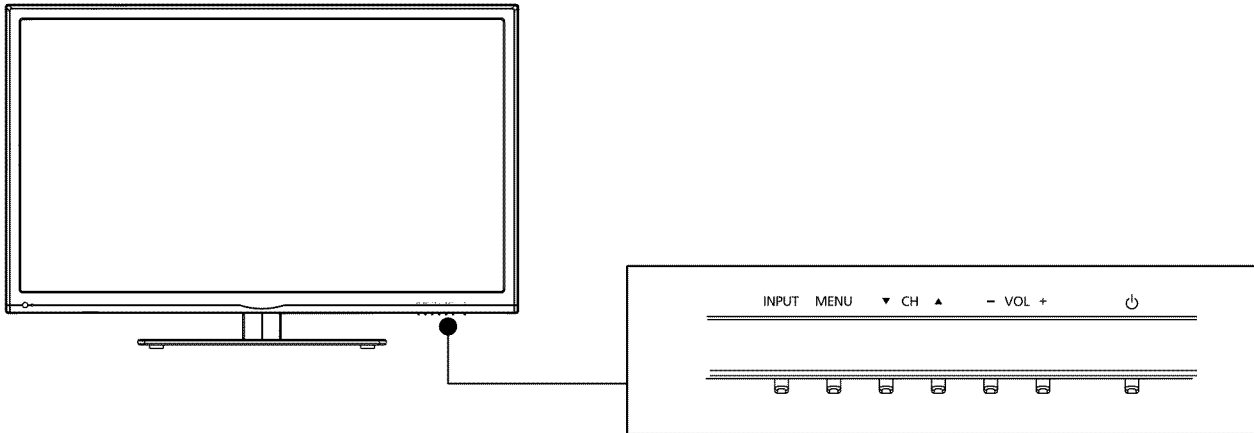

**INPUT:** Displays the Source Select List.

**MENU:** Displays the TV Main Menu.

**CH▲:** Scans up through the channel list. In the TV menu system, it acts like the up arrow on the remote control and can be used to select menu options.

**CH▼:** Scans down through the channel list. In the TV menu system, it acts like the down arrow on the remote control and can be used to select menu options.

**VOL+:** Increases the volume. In the TV menu system, it acts like the right arrow on the remote control and can be used to select menu options.

**VOL-:** Decreases the volume. In the TV menu system, it acts like the left arrow on the remote control and can be used to select menu options.

**POWER (⏻):** Turns the TV on and off.

## Front Panel

About remote control working distance and angel, see page 18.

Power/Standby Indicator: Light up in red when the TV is in standby mode. Light out when the TV is on.

Remote Control Sensor: Remote control IR sensor, which receives infrared ray sent by remote control.

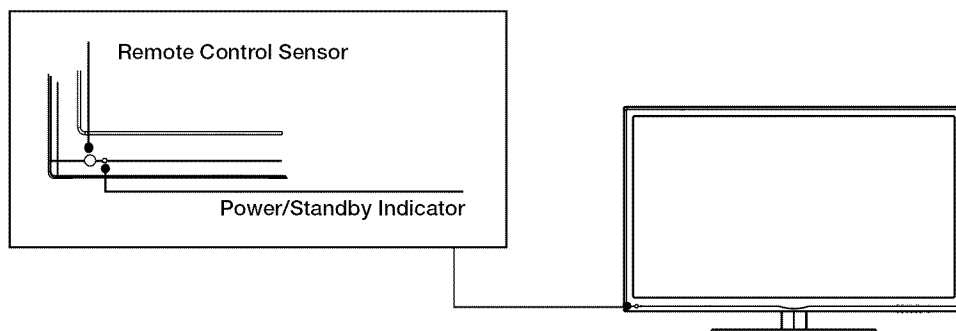

# Remote Control Instructions

## Inserting Batteries in the Remote

- Remove the cover of battery cabin on the back of the remote control by lifting the cover.
- Insert two AAA batteries, making sure the polarities (+ and -) are aligned correctly.
- Place the cover back.

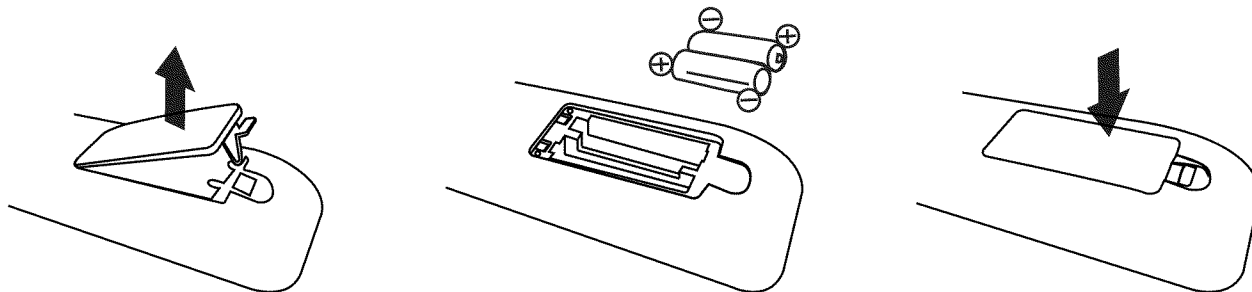

### If the remote control does not work, check these points:

- Are the polarities (+, -) correct?
- Are the batteries worn out?
- Is there an AC power failure?
- Is the power cord plugged in?
- Is there any interference or block near the remote control sensor?

### CAUTION:

- Used batteries should be recycled.
- Keep out of children's reach.
- DO NOT use new and old batteries together.
- Change both the batteries at the same time.
- When not using the remote control for a long time, remove the batteries from the unit.

## Remote Control Reception Angle

Use your remote control within the distance and angle range shown below.

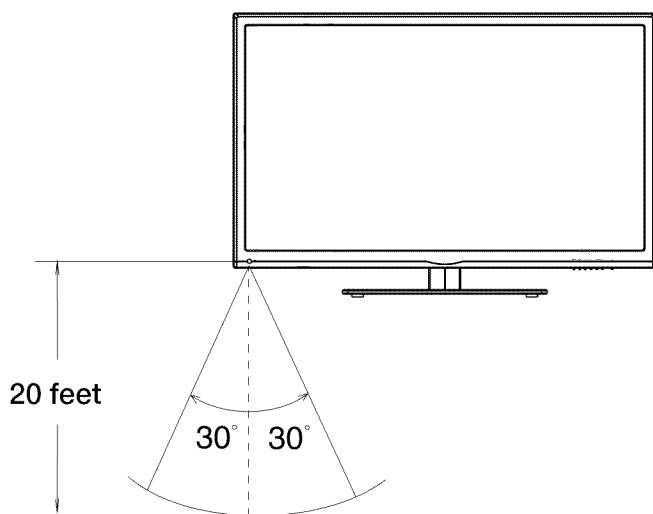

### Universal Remote Control Code List

For Universal Remote Control brands listed below, please use accompanying codes and refer to your Universal Remote Control User Manual for basic instruction for changing TV code to operate the TV model.

- Codes for DIRECTV: 0178, 10178
- Codes for Time Warner Cable: 0178, 10178
- Codes for Cox Communications: 0178
- Codes for Comcast: 10178
- Codes for Dish Network: 627
- Codes for Fios Verizon: 0205, 0057, 0493, 0775

# Learning about Remote Control

## Remote Control Buttons

**MUTE** (🔇): Reduces the TV volume to its minimum level. Press again to restore the volume.

**POWER** (🔌): Turns the TV on or off.

**CH.LIST**: Displays the channel list.

**FAV.:** Adds the current channel to your favorite list, or erases the current channel from your favorite list (if this channel is a favorite channel already).

**FAV.+** or **FAV.-** : Scans up or down through the current favorite channel list.

**Numeric Buttons:** Use these buttons to enter numbers.

**“—”:** To enter a digital channel with a sub-channel, enter the main channel; then, press this button to enter the sub-channel and press ENTER.

**Recall** (📄): Returns to the previous channel.

**EPG:** Shows Electronic Program Guide (see page 22).

**INPUT:** Accesses the available input channels (TV, AV, Component, HDMI 1/2/3, PC, Media). Use the arrows to highlight options, and press ENTER to select.

**Arrows** (⬅️/➡️/⬆️/⬇️): Uses the four arrows to highlight different items in the TV menu or change the value. The up/down arrow can also work as CH<sup>^</sup>/CH<sup>v</sup> button, and the left/right arrow can also work as VOL-/VOL+ button.

**ENTER:** Enter and confirm button.

**MENU:** Accesses the Main Menu, or return to the upper level of a sub-menu.

**FREEZE** : Freeze the current screen frame, press again to return to normal.

**DISPLAY:** Displays the Channel Bar (see page 22).

**EXIT:** Exits the current menu or function.

**VOL+** or **VOL-**: Increases or decreases the TV volume.

**CH<sup>^</sup>** or **CH<sup>v</sup>**: Scans up or down through the current channel list. Press once to change the channel up or down; press and hold to continue changing channels.

**PICTURE:** Switches between the preset picture mode (see page 23).

**SOUND:** Switches between the preset sound mode (see page 25).

**SLEEP:** Selects the sleep timer, after which the TV will shut off automatically.

**ASPECT:** Switches between the preset screen size mode (see page 24).

**CC:** Selects the closed caption.

**MTS:** Selects the multi-channel television sound.

**NOTE :** The keys not listed are for DVD control, they are not available for this TV model.



Remote control part number RE20QP80

# Initial Setup

If it is the first time you turn on your TV, or you have done Clear Channel List option (see page 30), the initial setup menu appears automatically.

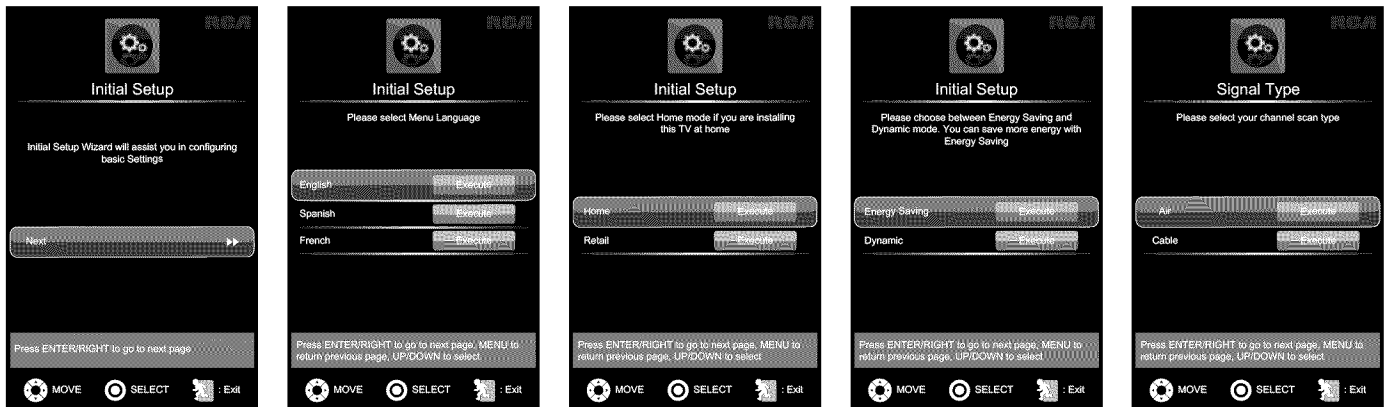

## Step One

Please select Menu Language, press the up/down arrow select the language you need.  
Available languages: English, Spanish and French.

## Step Two

Please select the TV installation mode, press the up/down arrow select the mode you need: Home, Retail.  
If you select Home mode, the next option is step three. If you select Retail mode, please refer the step four.

## Step Three

Please choose between Energy Saving and Dynamic mode. You can save more energy with Energy Saving.

## Step Four

To choose your TV tuner signal type, press the up/down arrow select the signal type: Air, Cable.  
Note: please select TV signal type according to the antenna or cable closed circuit TV you use.

## Step Five

If you accomplish the initial setup, the TV will search channels automatically.

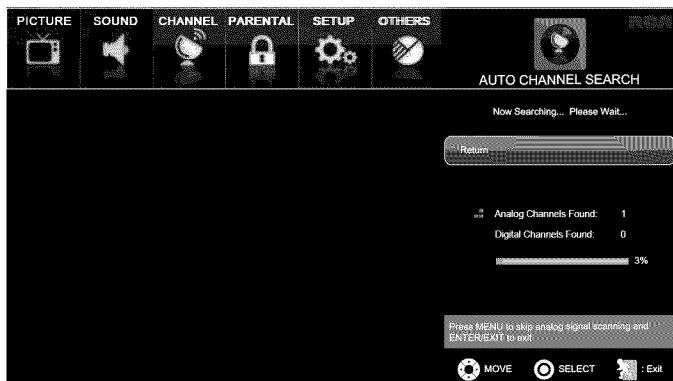

What to notice:

1. The channel search access starts from the Analog TV channel searching and ends at Digital TV channel searching.
2. The channels that have been found will be stored automatically.
3. You can press MENU button to skip analog/digital channel searching.
4. You can press ENTER/EXIT button to end the channel searching.

# Basic Operations

## Turning On and Off

Connect the AC cord to power the LED LCD TV. At this time the TV will enter standby mode and power indicator will turn red. Use Power button (⏻) on the top panel of TV or on the remote control to turn on the TV. After switching off the TV for 5 seconds, you can turn on TV again.

## Choosing TV Channel

### Tuning To Analog Channels

An analog channel has a channel number beginning with "A". Input the digital number with numeric buttons directly and press ENTER button to confirm.

For example, to watch analog channel "A51", press "5", "1", "ENTER" on remote control in sequence.

**Note:** Although there is no analog TV signal available in America, we reserve ATV functions for some expansible use.

### Tuning To Digital Channels

A digital channel has a channel number beginning with "D". Input the main digital number with numeric buttons directly, then press "—" button on remote control, and input the sub number at last.

For example, to watch analog channel "D31-1", press "3", "1", "—", "1", "ENTER" on remote control in sequence.

### Changing Channels Directly

You can use CH<sup>^</sup> button to increase channel number and CH<sup>v</sup> to decrease channel number. When no OSD (On Screen Display) is used, the up/down arrows can also work as CH<sup>^</sup>/CH<sup>v</sup> buttons.

## Selecting Input Source

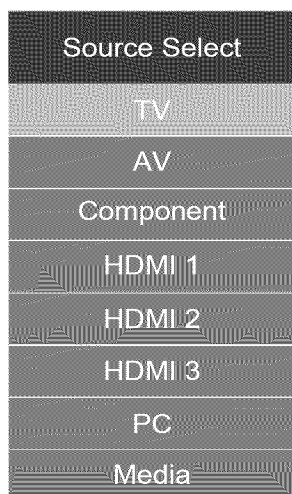

Press INPUT button on remote control to display Source Select list. Use up/down arrows to highlight the source you need and press ENTER to confirm.

# Basic Operations

## Channel Bar

Press the DISPLAY button on the remote control, the channel bar will appear on the top right corner of the screen. It displays the current channel's information. The following list describes the items on the channel bar.

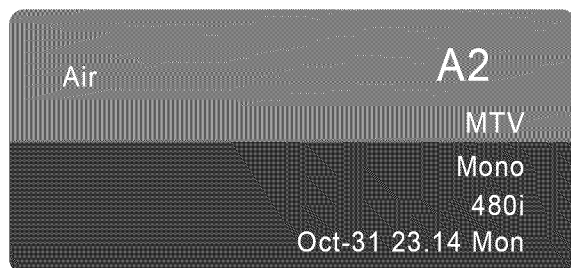

ATV



DTV

- A2/D50-1** If the channel is analog, A is displayed. If it's a digital channel, D is displayed. For example, in the pictures above, A2 is an analog channel, and D50-1 is a digital channel (-1 is a sub-channel number).
- MTV/KOCE-HD** Displays the channel label.
- Mono/English** Displays whether the current channel is being broadcasted in stereo or mono. If the current channel is digital, this space will be SAP (Second Audio Program) language.
- 480i/1080i** Displays the signal resolution.
- 16:9/CC/TV-PG** Displays the screen aspect ratio, closed caption and TV rating level of the current program or channel. These are only available for digital channels.
- Oct-31 23:14 Mon** Displays current date and time.

## Adjusting Volume

Press the VOL+/VOL- button on the remote control to adjust the volume. If you want to switch sound off, press MUTE (M). When OSD (On Screen Display) is not used, the arrows left/right can also work as VOL-/VOL+ buttons.

## EPG (Electronic Program Guide)

Press EPG button on the remote control, the electronic program guide will appear in the center of screen. The electronic program guide gives the TV program playing project. You can use left/right arrows to switch pages.

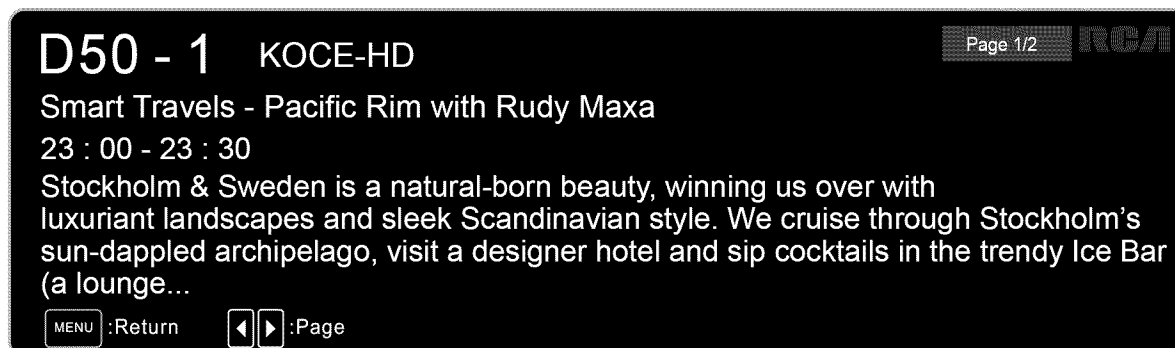

# OSD Menu Operations

## Adjust the OSD Screen

The OSD (On Screen Display) menu enables you to approach to the TV functions.

To use OSD menu system, press MENU button on remote control, then use left/right arrow to highlight an option from PICTURE, SOUND, CHANNEL, PARENTAL, SETUP or OTHERS and press ENTER/down button.

Press the up and down arrow to move to a different option within each menu. If necessary, press ENTER or right arrow to display the choices of the option you've highlighted. If available, use the text at the bottom of each screen for help. To return to the previous menu, press the MENU button.

To exit the OSD menu:

- Press the EXIT button. The menu will clear from the screen.
- Press the MENU button repeatedly until the menus disappear.

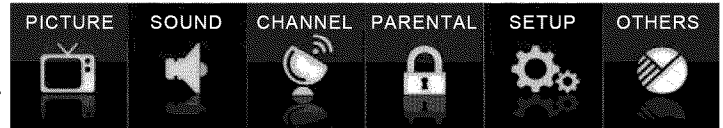

## Picture Menu

The Picture Menu contains menus and controls to configure the way the picture appears. The Picture Menu options apply to the video for the main TV and VIDEO INPUT selections. All picture options can be applied to each input.

Press MENU on the remote. Select Picture from the Main menu. Press the ENTER/down button to proceed to PICTURE menu.

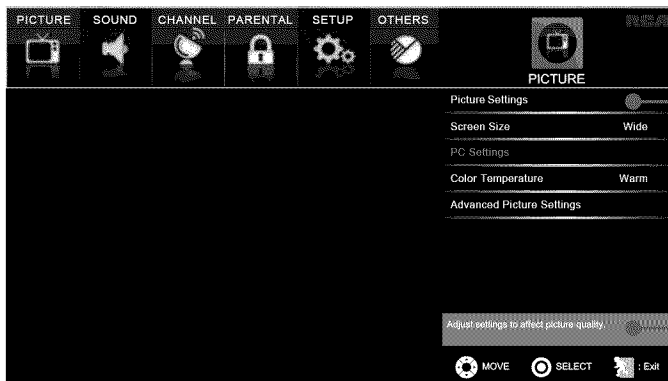

Use up/down to choose the function you need, press ENTER or right arrow to adjust or enter a sub-menu. The sub-menu image and explanation are shown below.

If available, use the text at the bottom of each screen for help.

## Picture Settings

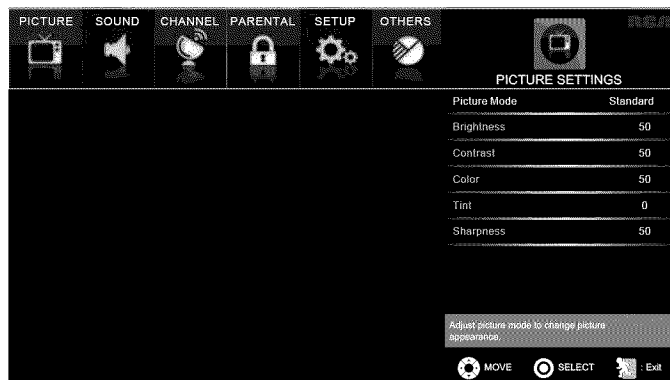

Picture Mode: Choose the preset visual mode of your TV: Standard, Movie, User, Dynamic, Power Saving. (Only in User mode you can adjust Brightness, Contrast, Color, Tint and Sharpness. Changes to Power Saving mode can decrease the power consumption.)

- Brightness: Adjust the brightness of picture.
- Contrast: Adjust the contrast of color.
- Color: Adjust the richness of color.
- Tint: Adjust the balance between red and green level (only available in NTSC signal).
- Sharpness: Adjust the sharpness level of picture.



# OSD Menu Operations

## Screen Size

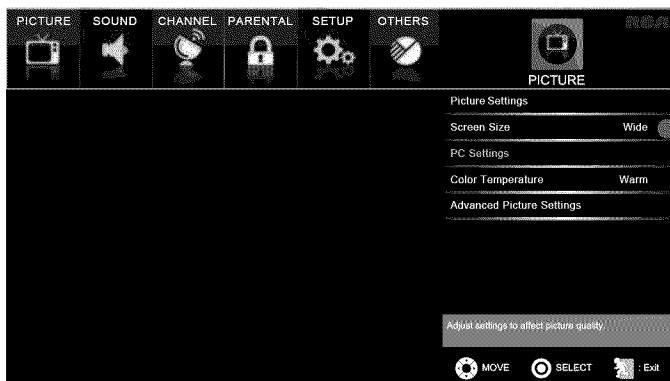

Screen Size: Select a screen aspect ratio. (Available ratio: Wide, Cinema, Zoom, and Normal.) Please choose the ratio that applies to your video signal format best.

## PC Settings (only available in PC mode)

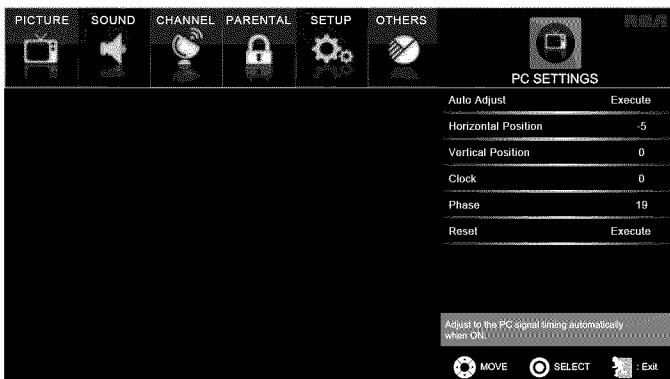

- Auto Adjust: Adjust the PC picture display automatically.
- Horizontal Position: Adjust the horizontal position of picture.
- Vertical Position: Adjust the vertical position of picture.
- Clock: Adjust the clock of picture.
- Phase: Adjust the phase of picture.
- Reset: Reset all the PC picture settings to factory default.

## Color Temperature

This option allows you to select one of three automatic color adjustments: Cool for a bluer palette of picture colors; Normal or Warm for a redder palette of color.

## Advanced Picture Settings (not available in PC mode)



- Dynamic Contrast: Set dynamic contrast Off/low/Medium/High.
  - Film Mode: Set film mode on/off.
  - Noise Reduction: Set noise reduction as Off/low/Medium/High.
  - MPEG Noise Reduction: Set MPEG noise reduction as Off/low/Medium or High.
- Note: Noise reduction helps to reduce the picture “static” or any type of interference. This feature is especially useful for providing a clearer picture in weak analog signal conditions. The MPEG Noise Reduction specifically works on video signal with MPEG coding.

# OSD Menu Operations

## Sound Menu

The Sound Menu lets you adjust audio output. To access the Sound Menu, press MENU on the remote, and then select SOUND from the Main Menu. Press ENTER/down button to proceed to SOUND menu.

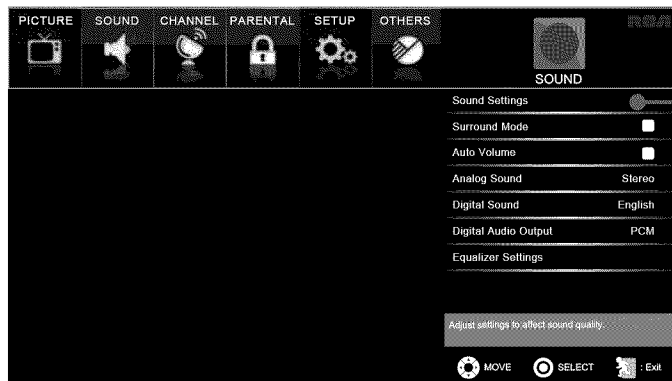

Use up/down to choose the function you need, press ENTER or right arrow to adjust or enter a sub-menu. The sub-menu image and explanation are shown below.

### Sound Settings

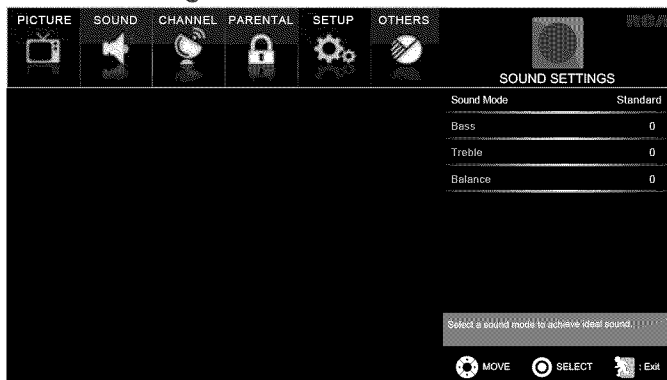

- Sound Mode: Choose the preset sound mode of your TV: Standard, Soft, User, Dynamic. Only in User mode you can adjust Bass, Treble, Balance.
- Bass: Adjust the bass component of TV sound.
- Treble: Adjust the treble component of TV sound.
- Balance: Adjust the balance between the left and right channel.

### Surround Mode

Creates a 3D sound surround from standard stereo material, with deep and rich enhancement.

### Auto Volume

Set auto volume control on/off.

### Analog Sound

Select analog TV audio sound type: Stereo, Mono or SAP (only available in TV mode).

### Digital Sound

Select digital TV audio language type: English, French or Spanish (only available for DTV channel).

### Digital Audio Output

Set the audio output type as Off, PCM or Raw. Please set this option according to your power amplifier.

# OSD Menu Operations

## Equalizer Settings

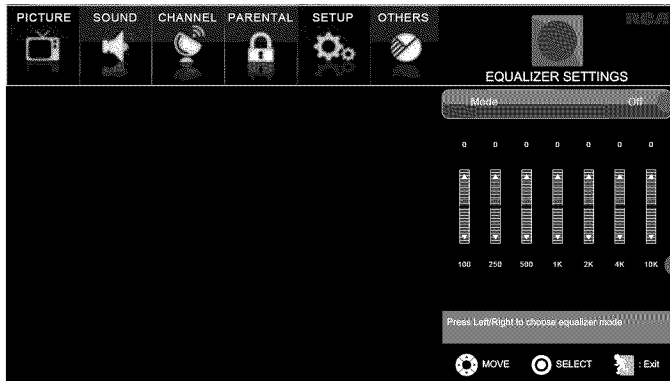

The seven-band graphic equalizer allows you to adjust the audio frequency settings. You can select one of the equalizer presets (Off, Pop, Rock, Jazz) or create your own personal preset (User).

Press the left or right arrow to select the frequency (100Hz, 250Hz, 500Hz, 1KHz, 2KHz, 4KHz, 10KHz) you want to adjust. Use the up or down arrow to adjust.

## Channel Menu

The Channel Menu enables you to search, view and edit channels. It is available in TV mode only.

Press MENU and choose CHANNEL from the Main menu. Press the ENTER/down button to proceed to CHANNEL menu.

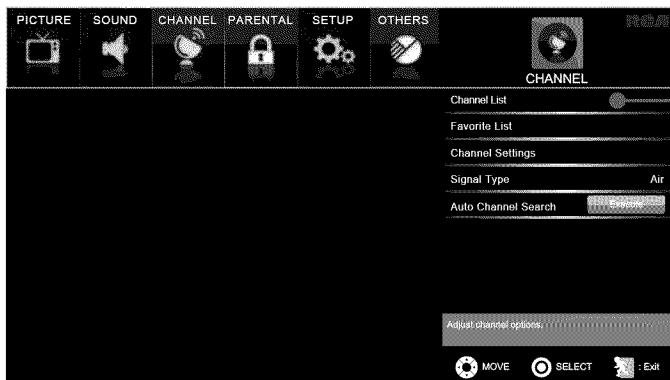

Use up/down to choose the function you need, press ENTER or right arrow to adjust or enter a sub-menu. The sub-menu image and explanation are shown below.

### Channel List

Displays a channel list. It shows the current channels.

### Favorite List

Displays a favorite channel list. It shows the current favorite channels.

### Channel Settings

Go to channel setting sub-menu (as shown below).



Enter a channel label to rename the current channel.

Set if the current channel is the favorite channel.

Set if the current channel is skipped.

Press up/down arrow to switch the channel you want to edit.

# OSD Menu Operations

## Signal Type

Select your TV signal type: Air or Cable.

## Auto Channel Search

Execute an auto channel search (see page 20).

## Parental Menu

The Setup Menu enables you to lock program with special content, panel key board and input source.

Press MENU and choose PARENTAL from the Main menu. Press the ENTER/down button to proceed to PARENTAL menu.

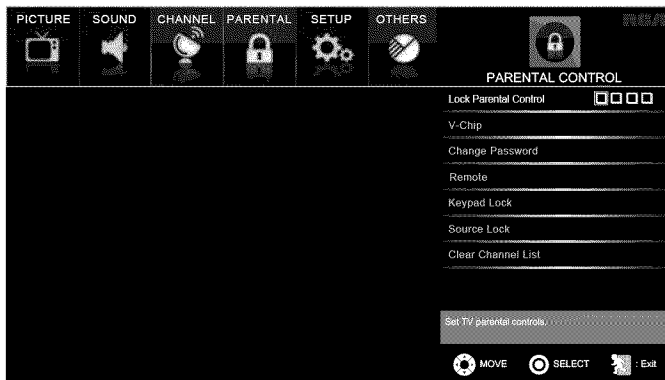

### Lock Parental Control

- When the Parental Control Menu is accessed from the Main Menu, you need to enter password to unlock the menu function. Please enter your four-digit password with numeric keys 0~9.

**Note:** The original password is "0000".

- After unlocking, the items in parental control menu can be used. Use arrow up/down to highlight the function you need and press ENTER or right arrow to use V-chip, Change Password, Keypad Lock and Source Lock, Clear Channel List sub-menu.

### V-Chip

Press ENTER or right arrow to enter V-chip sub-menu, the detail as follow:

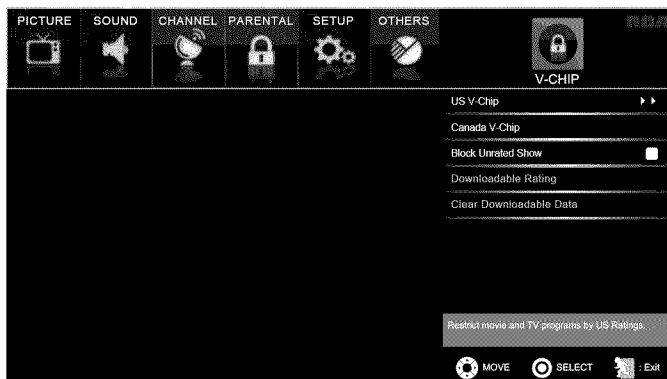

### US V-Chip

Press ENTER or right arrow to enter US V-Chip ratings menu, which contains two sub-menus: Movie Rating and TV rating. See next page for more details.

# OSD Menu Operations

## Movie Rating

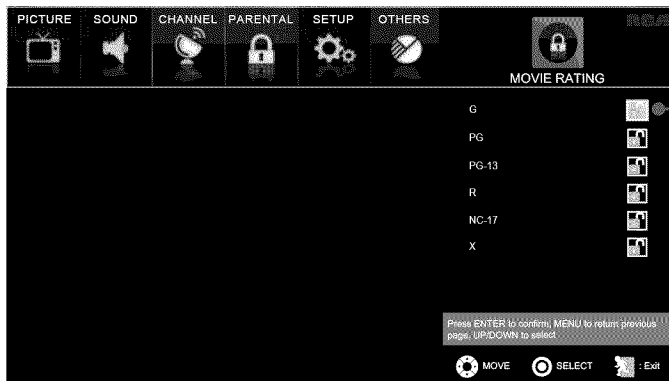

Use arrow keys to select the rating level you want to block, press ENTER to lock/unlock the rating level. If you have blocked a lower level rating, the higher ratings will be blocked too.

For example, when PG-13 is blocked, R, NC-17 and X will be blocked at the same time.

## TV Rating

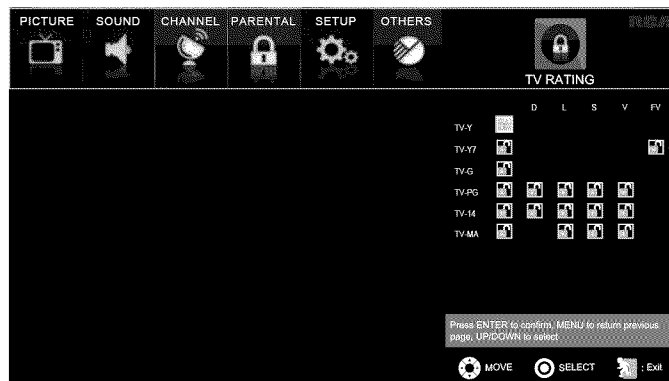

Similar with Movie Rating.

After adjusting, press MENU to return or press EXIT to exit the menu.

## TV Rating Overview

	Age-Based Ratings		Content Themes
TV-MA	Mature Audience Only	D	Sexually Explicit Dialogue
TV-14	Parents Strongly Cautioned	L	Adult Language
TV-PG	Parents Guidance Suggested	S	Sexual Situations
TV-G	General Audience	V	Violence
TV-Y7	Directed to Children 7 Years and Older	FV	Fantasy Violence
TV-Y	All Children		

For more rating explanation, see page 37.

# OSD Menu Operations

## Canada V-Chip

Press ENTER or right arrow to enter US V-Chip ratings menu, which contains two sub-menus: English Rating and French Rating.

### English Rating

Press ENTER or right arrow to enter English rating menu.

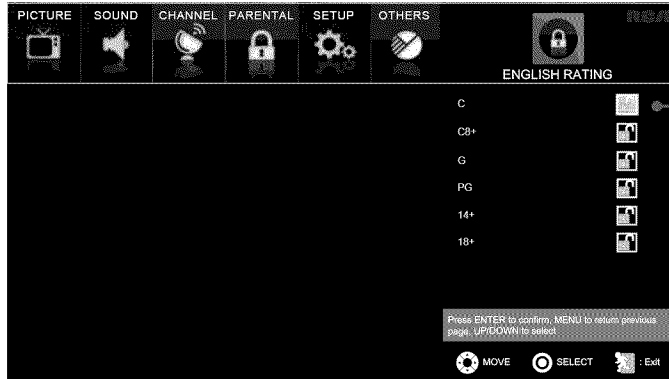

Use arrow keys to select the rating level you want to block, press ENTER to lock/unlock the rating level. If you have blocked a lower level rating, the higher ratings will be blocked too.

For example, when PG is blocked, 14+ and 18+ will be blocked at the same time.

### French Rating

Press ENTER or right arrow to enter French rating menu.

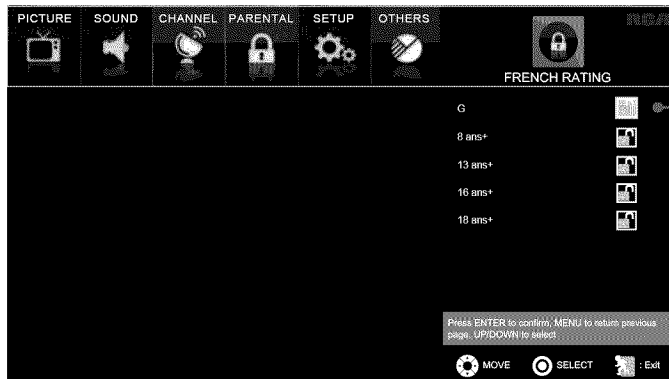

Similar with English Rating.

**Note:** These ratings are available only if the broadcaster is sending rating information.

## Block Unrated Show

Block all the unrated program.

## Downloadable Rating, Clear Downloadable Data

Activate or downloadable rating data, if available.

# OSD Menu Operations

## Change Password

Change the password of parental menu.

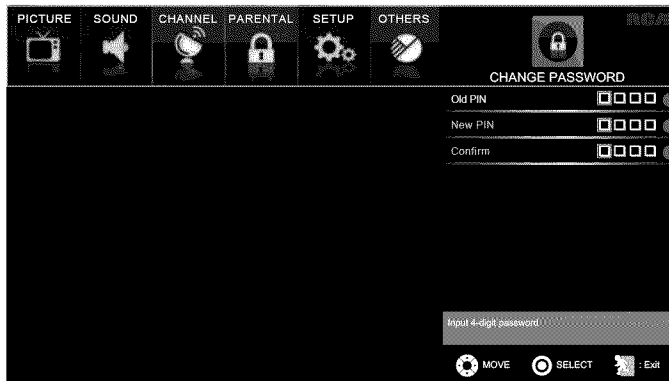

Input the old password.  
Input the new password.  
Input the new password again to confirm.

## Remote

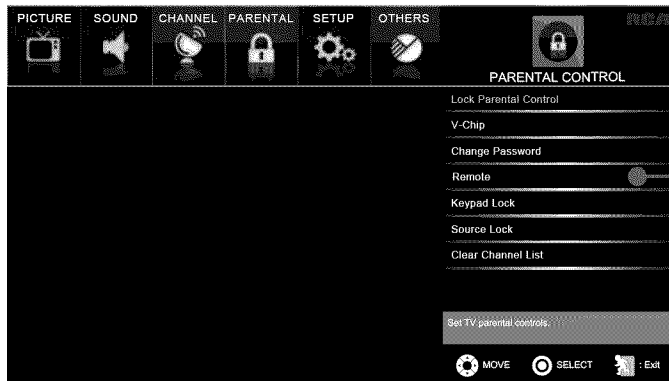

Select your Remote: Off, Remote1 or Remote2.  
This is for special purpose.

## Keypad Lock

Select this option to block or unblock the TV's side panel buttons so that they can't be used.

## Source Lock

This option allows you to lock or unlock the input source. The source blocked can not be chosen from input list unless you input the correct parental password.



Use up/down arrow to select the source, press ENTER to lock or unlock it.

## Clear Channel List

This option allows you to execute Clear Channel List function.

This function will reset the whole TV system to factory default (not only reset OSD menu).

# OSD Menu Operations

## Setup Menu

The Setup Menu lets you config the TV with your preferences.

Select SETUP from the Main Menu. Press ENTER/down button to proceed to SETUP menu.

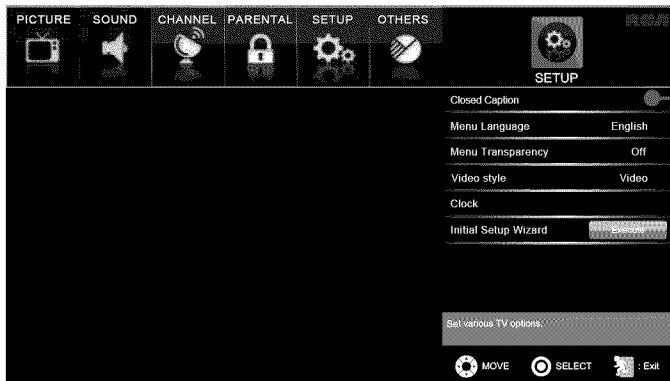

Use up/down to choose the function you need, press ENTER or right arrow to adjust or enter a sub-menu. The sub-menu image and explanation are shown below.

## Closed Caption

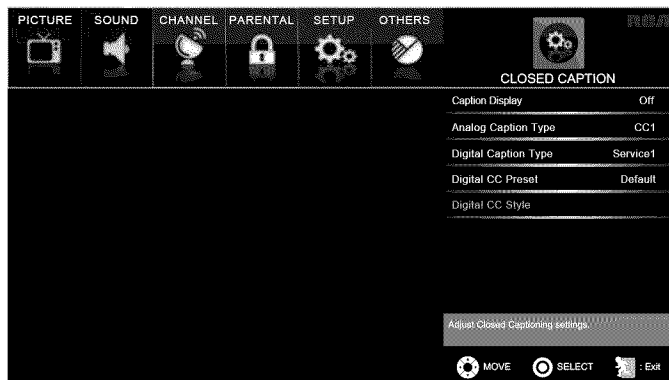

### Caption Display

Press left/right arrow to select caption display on or off.

### Analog Caption Type

Press left/right arrow to select analog closed caption type: CC1, CC2, CC3, CC4, TEXT1, TEXT2, TEXT3, TEXT4.

### Digital Caption Type

Press left/right arrow to select digital closed caption type: Service1, Service2, Service3, Service4, Service5, Service6.

### Digital CC Preset

Press left/right arrow to select digital closed caption preset: Default, Custom.

Only in custom mode you can adjust the digital closed caption style.

### Digital CC Style

Press left/right arrow to go to digital closed caption style sub-menu (see next page).



# OSD Menu Operations

## Digital CC Style

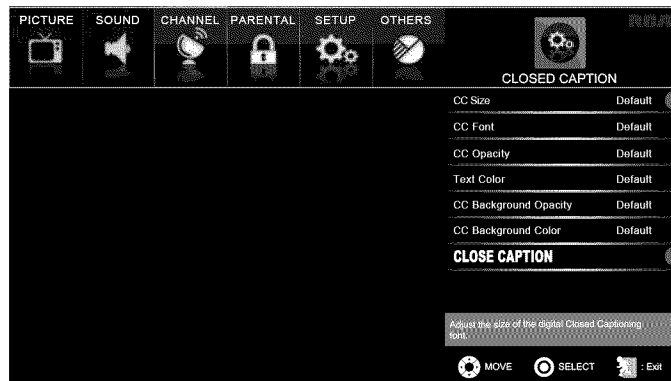

Select the item you want to adjust in Digital CC Style menu with up/down arrows.

After changing, you can preview the caption style here.

## Menu Language

To choose your menu language, press the left/right arrow until the language you need appears.  
Available languages: English, French and Spanish.

## Menu Transparency

To choose your menu transparency mode, press the left/right arrow until the transparency you need appears:  
Off, Low, Medium, High.

## Video Style

If you connect the HDMI/DVI port of PC to HDMI jack of the TV and the video signal is 1080p, please choose the compatible video style: Video, Graphic.

## Clock

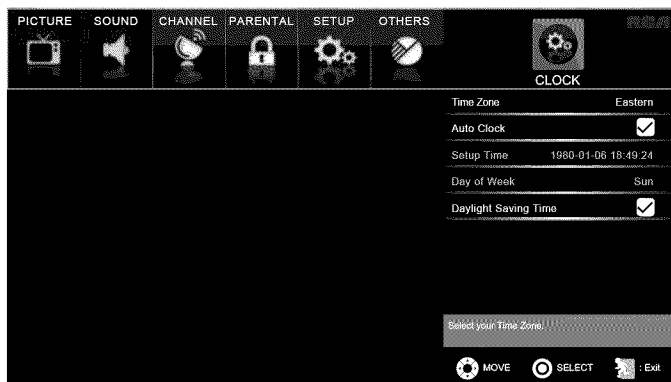

### Time Zone

Select your time zone: Eastern, Central, Mountain, Pacific, Alaska, Hawaii, Samoa, Newfoundland, Atlantic.

### Auto Clock

Select auto clock on/off. Auto clock helps you synchronize your TV time to standard time (from DTV signal).

### Setup Time

Set your TV time manually (needs to turn off auto clock).

### Day of Week

Displays what day it is (can't be adjusted, displays only).

### Daylight Saving Time

Set your daylight saving time on or off (needs to turn on auto clock).

## Initial Setup Wizard

To set the initial settings. (see page 20)

# OSD Menu Operations

## Others Menu

The Others Menu lets you config the TV with your preferences in other features.  
Choose OTHERS from the Main Menu. Press ENTER/down button to proceed to SETUP menu.

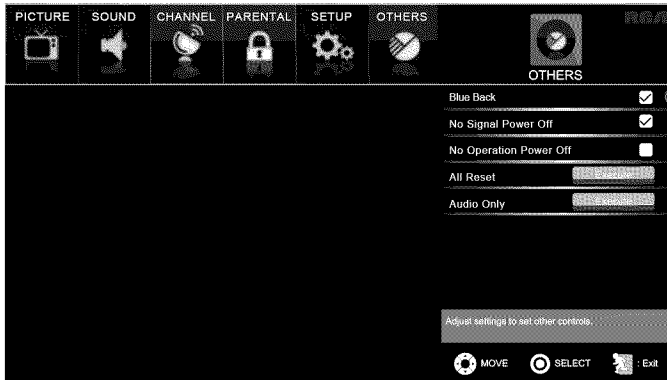

Use up/down to choose the function you need, press ENTER or right arrow to adjust or enter a sub-menu. The sub-menu image and explanation are shown below.

### Blue Back

Press ENTER button to select Blue Back on or off. If the Blue Back is turned on, the TV will display a blue background when there is no signal input.

### No Signal Power Off

Press ENTER button to select “No Signal Power Off” on or off. If it is turned on, the TV will shut off after 10-minute no signal time. We suggest you turn on this function when Blue Back is turned on. It may hurt the LCD panel if blue screen is on for too long.

Note: In PC mode, the monitor standby and power off settings depend on the No Signal Off time.

### No Operation Power Off

Press ENTER button to select “No Operation Power Off” on or off. If it is turned on, the TV will shut off after a 3-hour no operation time.

### All Reset

Press ENTER button to execute reset to TV system. All the settings will be reset to factory default.

### Audio Only

Press ENTER button to activate audio only mode. The TV will output only sound and the LCD panel will be turned off. To restore normal playing, hold POWER button for three seconds.

# Frequently Asked Questions (FAQs)

## **What's the most convenient way to view High Definition (HD) video?**

Connect an antenna to the TV Input jack to view free local digital channels. You may need to purchase an antenna. (See page 10 for more information about antenna setup).

Visit [www.antennaweb.org](http://www.antennaweb.org) for assistance in deciding what type of antenna to use to receive the local digital channels available to you. After entering your location, this mapping program tells you which local analog and digital stations are available using a certain antenna.

## **Are there other ways to view High Definition (HD) video?**

Besides using an antenna as mentioned above, you can also use a set-top box to receive digital video. Contact your cable service provider or satellite provider to purchase digital programming and have them connect the box to ensure you are viewing channels in the best way.

## **How do I tell an analog channel from a digital channel?**

Press the DISPLAY button to display the Channel Bar. Look at the top right corner of the screen. An "A" is displayed for an analog channel. A "D" is displayed for a digital channel.

*Note: Since the analog TV in America has been cut off, we reserve analog TV function only for some unexpected use.*

## **Why are there bars on my screen, and can I get rid of them?**

Most digital video is sent in a 16/9 format which fills your screen, but is sometimes sent in 4/3 which does not fill your screen. It depends on how the station or device connected to your TV is formatting the video. If there are bars on the screen, press the ASPECT button to try a different format that may eliminate the bars. Some bars can't be removed because of the way the format is sent by the broadcaster. The format changes as you press the ASPECT button and the format type is displayed at the bottom of the screen. For more information on screen formats, go to page 24.

## **Why does channel search find a lot of channels, but when I try to tune to them, there's nothing there?**

Some channels don't carry programming, such as video On Demand. When channels are unavailable, your TV screen is blank or appears like snow. You probably want to remove these channels from your channel list. Remove these in the Channel List Menu. Go to page 26 for more information.

## **Why does the first channel search take a long time?**

If you have both analog and digital channels, the TV is looking for all available channels in the channel list. If you do have digital channels, the TV is also searching for scrambled channels, non-scrambled channels, and each sub-channel of that digital channel.

# Troubleshooting

## Identifying Problems

If there are any problems when using the product, please consult the list below. If the list does not solve the problem, call our Customer Service Center immediately.

### TV Problems

The TV can't be turned on.

- Make sure the AC cord is plugged in.
- Check the wall outlet, make sure the AC output works normally and stably.
- The side panel may be locked (disabled). Use the remote control to turn on the TV.
- Select the Keypad Lock function in the PARENTAL Menu and press ENTER to uncheck the locking status.

There is no picture or sound but the TV is on and there is a "No Signal" sign on screen.

- Are you trying to use an input source with no device connected to it? For using other video/audio device, make sure the external device works normally first, then press INPUT and choose the right input source.
- The Signal Type option may be set incorrectly. Go to page 20 for detailed instructions.
- The channel may be blank. Try to search the channel again or change another channel.

The sound is fine, but the picture is poor.

- If you can only get black and white pictures from external device that you've connected to your TV, maybe it is due to the video cables is not connected well, or they are connected wrongly. Check the connection stability first, then check the correctness. For AV input, the yellow video cable connects to the yellow Video In jack on the side of your TV. For Component input, the three Y, Pb, Pr video cables (red, blue, and green) should be connect to the corresponding input jacks on the side of your TV.
- Check the antenna connections. Make sure all of the cables are firmly connected to the TV jack on side of your TV.
- Try adjusting the color features to improve.

There is no sound, but the picture is fine.

- The sound might be muted. Try pressing the MUTE button to restore sound.
- For using AV or Component, remember to connect the device's left and right audio output correctly. The left channel cable is white and the right channel cable is red. Please match the cables and jacks according to their colors.
- The sound settings may not be set correctly. Go to page 25 for more information.
- If your audio source has only one jack or is a (mono) audio source, make sure you have plugged the connection into the Audio In L jack (white) on the TV.

The buttons on the top panel don't work.

- The side panel may be locked (disabled). Use the remote control to turn on the TV.
- Select the Keypad Lock function in the PARENTAL Menu and press ENTER to uncheck the locking status.
- Unplug the TV from the AC power for 10 minutes and then plug it back. Turn the TV on and try again.

The TV turns off unexpectedly.

- The electronic protection circuit may have been activated because of a power surge. Wait 30 seconds and then turn the TV on again. If this happens frequently, the voltage in your house may be abnormal. If the other electronic equipment in your home can't work normally, consult a qualified service personnel.

# Troubleshooting

Can't select a certain channel.

- The channel may be blocked or not approved in the PARENTAL Menu.
- The channel may be skipped in channel list in CHANNEL Menu. Check the blocking and skipping status of channel.

The stereo sound performance is bad.

- It may be a weak station. Use the SOUND Menu and set Analog Sound as Mono.

A black box appears on the screen.

- Closed captioning might be on. Check Closed Caption in the SETUP menu. Go to page 32 for more instructions.

Problems with the HDMI Connection.

- Make sure the HDMI device (DVD, video gamer, etc.) is turned on and the cables are firmly connected. If problems still occur, turn off your device and reconnect it. Reset the power by unplugging the power cord and plugging it again.
- If a "No Signal" message appears on screen, the HDMI device isn't responding. Contact the manufacturer of the HDMI device for further assistance.
- If you have black bars on each side of your picture (which means the TV can not display a full-screen image), the device you connected might have a switch or a menu option allowing you to change the picture quality output that will fix this. Choose either 720p or 1080i.

The Remote control doesn't work.

- Something might be blocking between the remote control and the remote sensor on the front panel of the TV. Make sure there is a clear path.
- The remote may not be aimed directly at the TV.
- The batteries in the remote may be weak, dead, or installed incorrectly. Put new batteries in the remote.

You are experiencing problems with V-Chip/Parental Controls.

- If the rating limits don't work, you must lock the settings. Go to the Main Menu (press MENU on your remote), select PARENTAL to check the settings.

What else can I do?

If you've been through the Troubleshooting section and nothing has fixed your problem, try rebooting your TV. Note that after a reboot, you may need to run your TV through the setup process again. To reboot, unplug the power cord from the wall outlet or power strip. Keep your TV unplugged for about 5 minutes. Then plug in the TV and turn it on. See if the problem is fixed. If the problem remains, then please visit the Customer Support Menu at [www.rca.com](http://www.rca.com) or updated FAQs or contact RCA Customer Support at the support number provided in your Warranty card.

# V-Chip Rating Explanations

## US V-Chip Rating System

**TV-MA (Mature Audience Only):** Specifically designed to be viewed by adults and may be unsuitable for children under 17. It contains one or more of the following content themes: crude indecent language (L), explicit sexual activity (S), or graphic violence (V).

**TV-14 (Parents Strongly Cautioned):** Contains some material that many parents would find unsuitable for children under 14. Parents are strongly urged to exercise greater care in monitoring this program and are cautioned against letting children under the age of 14 watch unattended. This program contains one or more of the following content themes: intensely suggestive dialogue (D), strong coarse language (L), intense sexual situations (S), or intense violence (V).

**TV-PG (Parental Guidance Suggested) :** Contains material that parents may find unsuitable for younger children. Many parents may want to watch it with their younger children. The program contains one or more of the following content themes: some suggestive dialogue (D), infrequent coarse language (L), some sexual situations (S), or moderate violence (V).

**TV-G (Parental Audience):** Most parents would find this program suitable for all ages. It contains little or no sexual dialogue (D) or situations (S), no strong language (L), and little or no violence (V).

**TV-Y7 (Directed to Children 7 years and older):** Designed for children age of 7 and above. It may be more appropriate for children who have acquired the developmental skills needed to distinguish between make believe and reality. Themes and elements in this program may include mild fantasy violence (FV) or comedic violence, or may frighten children under the age of 7.

**TV-Y (All Children):** Themes and elements in this program are designed for a young audience, including children ages 2-6. It is not expected to frighten younger children.

## Canadian English V-Chip Rating System

**18+ (Adult):** Programming intended for adults 18 and older. It may contain elements of violence, language, and sexual content which could make it unsuitable for viewers under 18. Violence Guidelines: May contain violence integral to the development of the plot, character or theme, intended for adult audiences. Other Content Guidelines: May contain graphic language and explicit portrayals of nudity and/or sex.

**14+ (Viewer 14 and over):** Programming contains themes or contents which may not be suitable for viewers under the age of 14. Parents are strongly cautioned to exercise discretion in permitting viewing by pre-teens and early teens. Violence Guidelines: May contain intense scenes of violence. Could deal with mature themes and societal issues in a realistic fashion. Other Content Guidelines: May contain scenes of nudity and/or sexual activity. There could be frequent use of profanity.

**PG (Parental Guidance):** Programming intended for a general audience but which may not be suitable for younger children (under the age of 8). Parents may consider some content inappropriate for unsupervised viewing by children aged 8-13. Violence Guidelines: Depictions of conflict and/or aggression will be limited and moderate; may include physical, fantasy, or supernatural violence. Other Content Guidelines: May contain infrequent mild profanity, or mildly suggestive language. Could also contain brief scenes of nudity.

**G (General Audience):** Programming considered acceptable for all ages groups. While not designed specifically for children, it is understood younger viewers may be part of the audience. Violence Guidelines: Will contain very little violence, either physical or verbal or emotional. Will be sensitive to themes which could frighten a younger child, will not depict realistic scenes of violence which minimize or gloss over the effects of violent acts. Other Content Guidelines: There may be some inoffensive slang, no profanity and no nudity.

# V-Chip Rating Explanations

**C8+ (Children 8 and older):** Programming generally considered acceptable for children 8 years and over to watch on their own. Violence Guidelines: Violence will not be portrayed as the preferred, acceptable, or only way to resolve conflict or encourage children to imitate dangerous acts which they may see on television. Any realistic depictions of violence will be infrequent, discreet, of low intensity and will show the consequences of the acts. Other Content Guidelines: There will be no profanity, nudity or sexual content.

**C (Children):** Programming intended for children under age of 8. Violence Guidelines: Careful attention is paid to themes which could threaten children's sense of security and well being. There will be no realistic scenes of violence. Depictions of aggressive behavior will be infrequent and limited to portrayals that are clearly imaginary, comedic or unrealistic in nature. Other Content Guidelines: There will be no offensive language, nudity or sexual content.

## Canadian French V-Chip Rating System

**18+ (Adult):** Programming is for adults only. This program contains sustained violence or extremely violent scenes.

**16+ (Viewer 16 and over):** Programming is not suitable for those under age 16. This program contains frequent scenes of violence or intensely violent scenes.

**13+ (Viewer 13 and over):** Programming may not be suitable for children under the age of 13. This program either contains several violent scenes or one or more scenes that are violent enough to affect them. Viewing in the company of an adult is therefore strongly recommended for children under the age of 13.

**8+ (Viewer 8 and over):** Not recommended for young children. This program is suitable for most audiences, but it contains mild or occasional violence that could upset young children. Viewing in the company of an adult is therefore recommended for young children (under the age of 8) who do not distinguish between reality and imagination.

**G (General Audience):** This program is suitable for audiences of all ages. It contains no violence, or any violence that it does contain is either minimal or is presented in a humorous manner, as a caricature, or in an unrealistic way.

# Wall Mounting Unit Specification

Model	Unit Dimension (unit:mm)	Screw
LED32B30RQ	VESA 200 x 100	M6 screws, length 14mm

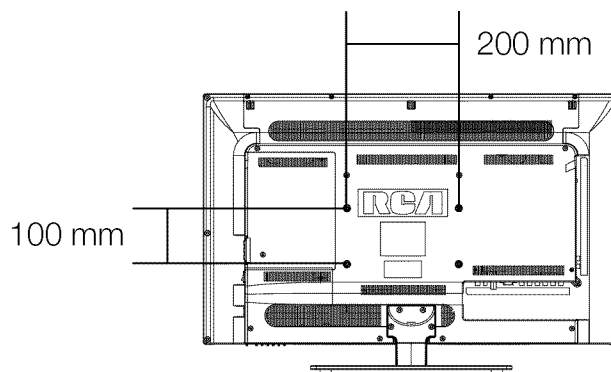

## Note:

- A. The wall mount is not contained in the accessories sold with television. We only provide the installing specifications but not the wall mount itself. If you need the mount, please consult with the local dealer for a VESA wall mount.
- B. We strongly suggest to set the wall mount with equipments of specification we ordered. If not, inappropriate installing may cause damage to device or people.

## Warnings:

1. Do not set up the wall mount by yourself. Please contact qualified professionals for installation.
2. The TV should not be mounted on walls or surfaces which have an angle more than 10 degrees with vertical direction. Otherwise the TV set may fall.
3. The walls for mounting must have enough strength to hold the whole weight of TV set. For example, concrete wall and brickwork are eligible. Do not place the mount on soft walls such as earth walls and plasterboard.
4. If spare parts of different specifications (such as screws) are used during mounting, consult with qualified professionals to make sure these parts are safe and effective.
5. Before attaching the base to wall, ensure the holes for anchors are in keeping with the installing rules. Otherwise there may exist some potential problems.
6. Do not place any heating source under your television. Or else, it can cause fire.
7. Do not place the TV near anything dripping. Transducers and high voltage wires should be kept far away from the apparatus too. Or else, it may cause creepage, electric shock or bad resonance.
8. Do not place TV in a location where collision or vibration is liable to happen.
9. In order to avoid unexpected falling of the TV set, do not put any strong force on TV or wall mount after installing.
10. Be sure to unplug the TV before installing. Keep anything hard or sharp away from the screen panel to prevent the scuffing.
11. After installing, if there is any need to move the cabinet, please contact the qualified professionals.



# USB Media Play

With USB Media Play, you can enjoy music and photo files stored in a USB storage device on your RCA TV.

## Connecting a USB storage device

- Connect a USB storage device to the USB port in the back of the TV.
- Press “INPUT” and select “Media”.
- “USB Media Play” menu will appear.

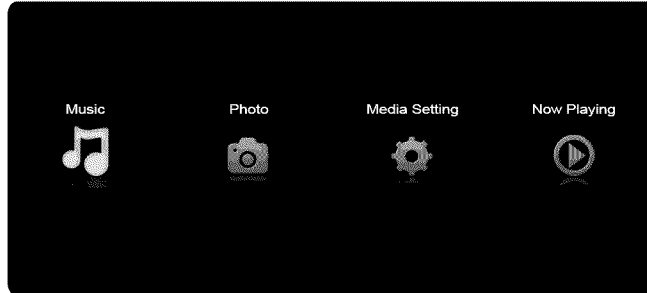

## Playing back Music files

- Press arrow (◀/▶) to select “Music” and press “ENTER”.
- The file or folder list will show up. Press arrow (▲/▼) to select a file or folder. Press “ENTER” to playback the music file you selected.

## Playing back Photo files

- Press arrow (◀/▶) to select “Photo” and press “ENTER”.
- The file or folder list will show up. Press arrow (▲/▼) to select a file or folder. Press “ENTER” , and you will be given several options to view photo files.
- You can directly open and playback the file. view thumbnails for photo preview, or play slideshow.

## Media setting for Slideshow and Music playback

- Press arrow (◀/▶) to select “Media Setting” and press “ENTER”.
- In “Media Setting”, you can set various options for Slideshow and Music Playback.

## Media Support Specification

Supported Files	
• Photo	JPG/JPEG files
• Music	MP3 (8~320kbps) files
Supported USB storage/file system format	
• USB Storage	USB flash drive
• File System format	FAT32

### Caution:

Do not turn off the TV or disconnect USB storage device while the TV is playing back picture or music. This may result in loss of data or damage to the USB storage device, and RCA is not responsible for any damage to, or loss of, data on the USB storage device.

# Product Specification

Model		LED32B30RQ
Diagonal Display Size		32 inches
Television System		American TV standard ATSC/NTSC system
Channel Coverage		VHF: 2~13    UHF: 14~69    CATV: 1~135
Temperature		Storage Temperature is -20°C ~ +60°C (-4°F ~ +140°F)
		Operating Temperature is 0°C ~ +50°C (+32°F ~ +122°F)
Humidity		Storage Humidity: Less than 85% RH (No condensation)
		Operating Humidity: Less than 80% RH (No condensation)
Power Supply		AC 100-120V, 50-60Hz
Connection Interface	RF Input	Cable/Antenna x 1
	HDMI	3
	Component	3 x 1 + Audio R, L (RCA)
		(Component sound is shared with AV)
	AV-IN (Composite)	Video + Audio R, L (RCA)
	PC Input	RGB 15pin x 1, Stereo 3.5mm x 1
	Audio Output	Digital Audio Out x 1 (Coaxial)
Headphone 3.5mm x 1		
Resolution		1366 x 768
Component/HDMI mode		480i, 480p, 720p, 1080i
Dimensions	With stand	29.3"W x 19.6"H x 6.9"D
	Without stand	29.3"W x 17.7"H x 3.2"D
Weight	With stand	14.3LBS (6.5KGS)
	Without stand	11.2LBS (5.1KGS)
Power Consumption		less than 76W

**Notice: Specifications are subject to change without notice.**

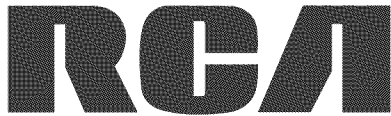

Made for Today.  
www.rca.com

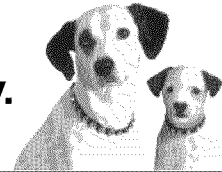

## Limited Warranty for USA and Mexico

### Coverage – Labor

For a period of 12 months from date of purchase of your RCA product, we will pay an authorized RCA service center the labor charge to repair any defects in materials or workmanship in your television. If your television is unrepairable we will provide you with a refurbished unit of the same or better model.

### Coverage – Parts

For a period of 12 months from date of purchase of your RCA product, we will pay an authorized RCA service center for the new, or at our option, refurbished replacement parts needed to repair any defects in material or workmanship in your television. If your television is unrepairable we will provide you with a refurbished unit of the same or better model.

### Coverage–LED LCD Panel

For a period of 12 months from date of purchase of your RCA product, we will pay an authorized RCA service center for the new, or at our option, refurbished LED LCD panel needed to repair any defects in material or workmanship in your television. If your television is unrepairable we will provide you with a refurbished unit of the same or better model.

### How to Obtain Service

- For assistance (U.S.A) - if you purchased RCA product in U.S.A, please call 1-888-977-6722.  
Or visit [www.rca.com](http://www.rca.com)
- For assistance (Mexico) - if you purchased RCA product in Mexico, please call 01-800-8233858  
Or visit [www.rca.com](http://www.rca.com)

[Mexico service center address]

Servicios Computacionales de México, S.A. de C.V.  
Francisco Díaz Covarrubias # 33, Ciudad Satélite  
C.P. 53100, Naucalpan, México

The service representative will review your options for service. As a convenience we offer three ways to obtain warranty service. You may mail your product to the address provided by the service representative, you may take your product to an authorized service center, or you may request in home service (servicer will determine if product is serviceable in home or must be taken back to local service center for repair). Service representative will supply instructions for preferred service. At the time of service proof of purchase such as original receipt, will be required. Only 37" LCD size and above are applicable for in-home-service.

## Items Not Covered By Limited Warranty

Your limited warranty does not cover the following items:

- Un-installation, installation and adjustment of customer controls and operating instruction.
- Batteries and customer replacement fuses.
- Damage due to misuse, abuse, negligence or neglect including but, not limited to, damage resulting from exposure to moisture, humidity or salt.
- Inability to receive a signal due to problems not caused by the product.
- Damage to the product due to images burnt into the screen.
- Product purchased or serviced outside of Country of Original Purchase.
  - i.e. Purchased USA can not be serviced in Mexico/Purchased in Mexico can not be serviced in USA.
- Product modified or incorporated into other products.
- Damage due to acts of nature, including but not limited to, lightning damage or flooding.
- Service calls which do not involve any defect in materials or workmanship.

### Commercial Use Excluded

This limited warranty only applies to products used for personal use and does not cover any product used for institutional, commercial or rental purposes.

## LIMITATION OF WARRANTY

THIS LIMITED WARRANTY IS THE SOLE AND EXCLUSIVE WARRANTY APPLICABLE TO THIS PRODUCT. ON CORP US, INC., THE MANUFACTURER OF THIS PRODUCT, DISCLAIMS ALL OTHER WARRANTIES, EXPRESSED OR IMPLIED (INCLUDING ALL IMPLIED WARRANTIES OF MERCHANTABILITY OR FITNESS FOR A PARTICULAR PURPOSE). NO VERBAL OR WRITTEN INFORMATION GIVEN BY ON CORP US, INC., ITS AGENTS, INDEPENDENT CONTRACTORS, SALES REPRESENTATIVES, EMPLOYEES, RETAIL DEALERS, WHOLESALE DISTRIBUTORS OR ANY OTHER THIRD PARTY SHALL CREATE A WARRANTY OR INCREASE, EXPAND OR MODIFY THE SCOPE OF THIS LIMITED WARRANTY.

THIS LIMITED WARRANTY PROVIDES THE SOLE AND EXCLUSIVE REMEDY FOR THE CONSUMER OF REPAIR OR REPLACEMENT OF THE PRODUCT. ON CORP US, INC. SHALL NOT BE LIABLE FOR SPECIAL, INCIDENTAL OR CONSEQUENTIAL DAMAGES ARISING OUT OF THE USE OF THE PRODUCT OR ARISING OUT OF A BREACH EXPRESSED OR IMPLIED WARRANTY ON THIS PRODUCT.

THIS LIMITED WARRANTY AND THE DISCLAIMERS CONTAINED HEREIN ARE GOVERNED BY THE LAWS OF THE STATE OF INDIANA. EXCEPT TO THE EXTENT PROHIBITED BY APPLICABLE LAW, ANY IMPLIED WARRANTY OF MERCHANTABILITY OR FITNESS FOR A PARTICULAR PURPOSE IS LIMITED TO APPLICABLE LIMITED WARRANTY PERIOD(S) SET FORTH ABOVE.

THIS WARRANTY GIVES YOU SPECIFIC LEGAL RIGHTS AND YOU ALSO MAY HAVE OTHER RIGHTS THAT VARY FROM STATE TO STATE.



Hecho para Hoy.  
www.rca.com

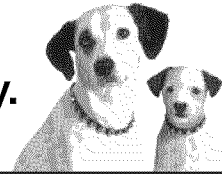

## Garantía limitada para EE.UU y México.

### **Cobertura-Trabajo**

Durante un período de 12 meses desde la fecha de compra de su producto RCA, pagaremos a un centro autorizado de servicio de RCA el cargo de mano de obra para reparar cualquier defecto en materiales o mano de obra en el televisor. Si su televisor es irreparable que le proporcionará una unidad reacondicionada del mismo modelo o superior.

### **Cobertura / Recambios**

Durante un período de 12 meses desde la fecha de compra de su producto RCA, pagaremos a un centro autorizado de servicio de RCA para un reemplazar ya sea con partes nuevas o reacondicionadas, o a nuestra opción, para reparar cualquier defecto del material o mano de obra en el televisor. Si su televisor es irreparable que le proporcionará una unidad reacondicionada del mismo modelo o superior.

### **Panel de Cobertura-LED LCD**

Durante un período de 12 meses desde la fecha de compra de su producto RCA, pagaremos un centro autorizado de servicio de RCA para un reemplazar la pantalla LCD, ya sea con pantalla nueva o reacondicionada, o a nuestra opción, para reparar cualquier defecto del material o mano de obra en la pantalla de su televisor. Si su televisor es irreparable que le proporcionará una unidad reacondicionada del mismo modelo o superior.

### **Cómo Obtener Servicio**

Para asistencia en Estados Unidos (E.U.A) si compró un aparato RCA en E.U.A. favor de llamar al: 1-888-977-6722 o visite: [www.rca.com](http://www.rca.com)

Para asistencia en México: si compró un aparato RCA en México, favor de llamar al: 01-800-823-3858, o visite: [www.rca.com](http://www.rca.com)

(Centro de Servicio en México)

Servicios Computacionales de México, S.A. de C.V.  
Francisco Díaz Covarrubias # 33, Ciudad Satélite  
C.P. 53100, Naucalpan, México

El representante de Servicio revisará sus opciones para el servicio.

Para su comodidad le ofrecemos tres formas de obtener servicio de garantía. Usted puede enviar su producto a la dirección proporcionada por el representante de servicio, usted puede llevar su producto a un centro de servicio autorizado, o puede solicitar en el servicio a domicilio (administrador determinará si el producto se encuentre en funcionamiento en casa o debe ser llevado de vuelta a servicio local técnico para su reparación). El representante del Servicio le proporcionará las instrucciones para el servicio preferido. Se requiere del comprobante de compra original. Sólo se les dará servicio a Domicilio a Televisores de 37 " pulgadas de tamaño y más grandes.

## Elementos no cubiertos por la garantía limitada Su garantía limitada no cubre los siguientes temas:

- Un-instalación, montaje y ajuste de controles del cliente e instrucciones de funcionamiento.
- Las pilas y los fusibles de repuesto al cliente.
- Daños por uso indebido, abuso, negligencia o descuido incluyendo pero no limitado a, los daños derivados de la exposición a la humedad, la humedad o la sal.
- Incapacidad para recibir la señal debido a los problemas que no son causadas por el producto.
- Daños en el producto debido a las imágenes de grabadas en la pantalla.
- Productos comprados o prestar servicios fuera del país de compra original.  
Ej: Comprado en Estados Unidos no puede prestar servicios en Mexico/  
Comprado en Mexico no puede prestar servicios en Estados Unidos.
- Productos modificados o incorporados a otros productos.
- Daños debidos a fenómenos de la naturaleza, incluyendo pero no limitado a, daños por rayos o inundaciones.
- Las llamadas de servicio que no impliquen cualquier defecto en materiales o mano de obra.

### Uso Comercial Exclusión

Esta garantía limitada sólo se aplica a los productos utilizados para uso personal o, y no cubre todos los productos utilizados con fines institucionales, comerciales o de alquiler.

## LIMITACIÓN DE GARANTÍA

ESTA GARANTÍA LIMITADA ES EL ÚNICO Y EXCLUSIVO DE GARANTÍA APLICABLE A ESTE PRODUCTO. EN CORP EE.UU., Inc., el fabricante de este producto, rechaza cualquier otra garantía, expresada o implicada (INCLUYENDO TODAS LAS GARANTÍAS IMPLÍCITAS DE COMERCIALIZACIÓN O IDONEIDAD PARA UN PROPÓSITO PARTICULAR). NO información verbal o escrita por parte CORP DE EE.UU., Inc., sus agentes, contratistas independientes, representantes de ventas, empleados, comerciantes minoristas, mayoristas o cualquier otro tercero DEBERÁN crear una garantía ni aumentar. Ampliar o modificar el alcance de esta garantía limitada. Esta GARANTÍA LIMITADA DEL ÚNICO Y EXCLUSIVO REMEDIO PARA EL CONSUMIDOR DE REPARACIÓN O REEMPLAZO DEL PRODUCTO. EN CORP EE.UU., Inc. no será responsable por daños especiales, incidentales o consecuentes resultantes DEL USO DEL PRODUCTO O DERIVADOS DE UNA VIOLACIÓN garantía expresa o implícita de este producto. ESTA GARANTÍA LIMITADA Y RESPONSABILIDADES contenida en él se rige por las Leyes del Estado de Indiana. SALVOPROHIBIDO POR LA LEY APLICABLE, CUALQUIER GARANTÍA IMPLÍCITA DE COMERCIALIZACIÓN O IDONEIDAD PARA UN PROPÓSITO PARTICULAR ESTARÁ LIMITADA A LIMITADA período de garantía (S) mencionado anteriormente. Esta garantía le otorga derechos legales específicos y USTED TAMBIÉN PUEDE TENER OTROS DERECHOS, QUE PUEDEN VARIAR DE ESTADO.

ON Corp US, Inc.  
10920 Via Frontera, Ste 540  
San Diego, CA 92127, U.S.A.  
©2012 ON Corporation

RCA is a trademark of RCA Trademark Management SAS  
used under license to ON Corporation.

RCA es una marcade RCA Trademark Management SAS  
usada bajo licencia de ON Corporation.