

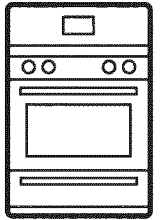

Electrolux



.....
EN GAS RANGE

.....
USE AND CARE GUIDE

Table of contents

Finding information	2
IMPORTANT SAFETY INSTRUCTIONS	3-6
Features	7
Surface Cooking	8-10
• Cookware	8
• Before setting surface burners	8-9
• Setting surface burners	10
• Home canning	10
• Surface burner positions	10
Oven Cooking	11-12
• Oven racks	11
• Luxury Glide™ oven racks	12
Setting Oven Controls	13-36
• Oven control display and keys	13
• Setting the clock	14
• Changing clock display mode	14
• Changing oven temperature display mode (°F/°C)	15
• Changing between 12-hour energy saving or continuous bake mode settings	15
• Adjusting tone volume	16
• Oven control lock	16
• Timer	17
• Fast preheat	18
• Bake	19-20
• Cook time	21
• Setting cook time with end time	22
• Broil	23-24
• Conv bake	25-26
• Conv convert	27
• Conv roast	28-29
• Keep warm	30
• Slow cook	31
• My favorite	32
• Adjusting the oven temperature	33
• Sabbath mode	34-35
• Restoring control to factory default settings	36
• Interior oven light	36
Self-Clean	37-39
Care & Cleaning	40-45
• Cleaning recommendations	40
• Cleaning cooktop and parts	41
• Aluminum foil and oven liners	42
• Changing oven light	42
• Removing the oven door	43
• Replacing the oven door	44
• Special door care instructions	45
Solutions to Common Problems	46-48
Notes	49-50
Warranty	51

Please read and save this guide

Thank you for choosing Electrolux, the premium brand in home appliances. This *Use & Care Guide* is part of our commitment to customer satisfaction and product quality throughout the service life of your new appliance.

We view your purchase as the beginning of a relationship. To ensure our ability to continue serving you, please use this page to record important product information.

Record your purchase

Purchase date

Electrolux model number

Electrolux serial number

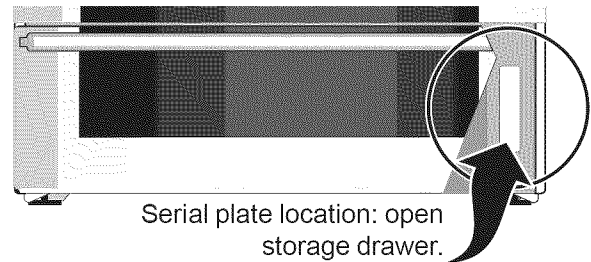

NOTE

Registering your product with Electrolux enhances our ability to serve you. You can register online at www.electroluxappliances.com or by dropping your Product Registration Card in the mail.

Questions?

For toll-free telephone support in the U.S. and Canada:

1-877-4ELECTROLUX (1-877-435-3287)

For online support and Internet production information visit www.electroluxappliances.com

Recognize safety symbols, words and labels

Safety items throughout this manual are labeled with a WARNING or CAUTION based on the risk type as described below:

WARNING

This symbol alerts you to situations that may cause serious body harm, death or property damage.

CAUTION

This symbol alerts you to situations that may cause bodily injury or property damage.

Read all of the following safety instructions before using this appliance:

WARNING

If the information in this manual is not followed exactly, a fire or explosion may result causing property damage, personal injury or death.

For your safety:

- Do not store or use gasoline or other flammable vapors and liquids in the vicinity of this or any other appliance.
- Installation and service must be performed by a qualified installer, servicer or the gas supplier.

What to do if you smell gas:

- Do not try to lite any appliance.
- Do not touch any electrical switch; do not use any phone in your building.
- Immediately call your gas supplier from a neighbor's phone. Follow the gas supplier's instructions.
- If you cannot reach your gas supplier, call the fire department.

WARNING

Do not store items of interest to children in the cabinets above a range or on the backguard of a range. Children climbing on the range to reach items could be seriously injured.

Save these instructions for future reference.

WARNING

- **Never use this appliance as a space heater to heat or warm the room.** Doing so may result in carbon monoxide poisoning.
- **Never cover any slots, holes or passages in the oven bottom or cover an entire rack with materials such as aluminum foil.** Doing so blocks air flow through the oven and may cause carbon monoxide poisoning. Aluminum foil linings may trap heat, causing a fire hazard.
- **Stepping, leaning or sitting on the doors or drawers of this range can result in serious injuries and also cause damage to the range.** Do not allow children to climb or play around the range. The weight of a child on an open door may cause the range to tip, resulting in serious burns or other injury.
- **Do not use the oven or Warmer oven/Lower Oven (if equipped) for storage.**

WARNING

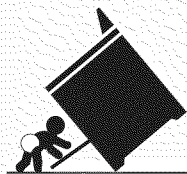

Tip Over Hazard

- A child or adult can tip the range and be killed.
- Verify the anti-tip device has been installed to floor or wall.
- Ensure the anti-tip device is re-engaged when the range is moved to floor or wall.
- Do not operate the range without the anti-tip device in place and engaged.
- Failure to follow these instructions can result in death or serious burns to children and adults.

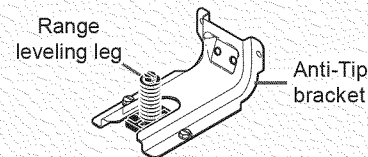
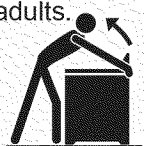

To check if the anti-tip bracket is installed properly, use both arms and grasp the rear edge of range back. Carefully attempt to tilt range forward. When properly installed, the range should not tilt forward.

Refer to the anti-tip bracket **installation instructions** supplied with your range for proper installation.

- **Remove all tape and packaging before using the range.** Destroy the carton and plastic bags after unpacking the range. Never allow children to play with packaging material.
- **Proper Installation—Be sure your appliance is properly installed and grounded by a qualified technician in accordance with the National Fuel Gas Code ANSI Z223- latest edition, or in Canada CAN/CGA B149.1 and CAN/GGA B149.2, and the National Electrical Code ANSI/NFPA No.70-latest edition, or in Canada CSA Standard C22.1, Canadian Electrical Code, Part 1, and local code requirements.** Install only per installation instructions provided in the literature package for this range.

Ask your dealer to recommend a qualified technician and an authorized repair service. Know how to disconnect the power to the range at the circuit breaker or fuse box in case of an emergency.

- **User servicing—Do not repair or replace any part of the appliance unless specifically recommended in the manuals.** All other servicing should be done only by a qualified technician. This may reduce the risk of personal injury and damage to the range.
- **Never modify or alter the construction of a range by removing leveling legs, panels, wire covers, anti-tip brackets/screws, or any other part of the product.**
- **Air curtain or other overhead range hoods, which operate by blowing a downward air flow on to a range, shall not be used in conjunction with gas ranges other than when the hood and range have been designed, tested and listed by an independent test laboratory for use in combination with each other.**
- **Storage in or on Appliance—Flammable materials should not be stored in an oven, warmer drawer, near surface burners or in the storage drawer.** This includes paper, plastic and cloth items, such as cookbooks, plasticware and towels, as well as flammable liquids. Do not store explosives, such as aerosol cans, on or near the range.
- **Remove the oven door from any unused range if it is to be stored or discarded.**

IMPORTANT

Do not attempt to operate the range during a power failure. If the power fails, always turn off the range. If the range is not turned off and the power resumes, the range will begin to operate again. Once the power resumes, reset the clock and oven function.

- **Do not leave children alone—Children should not be left alone or unattended in the area where appliance is in use.** They should never be allowed to sit or stand on any part of the appliance.
- **DO NOT TOUCH SURFACE BURNERS, AREAS NEAR THESE BURNERS, OVEN BURNERS OR INTERIOR SURFACES OF THE OVEN.** Both surface and oven burners may be hot even though flames are not visible. Areas near surface burners may become hot enough to cause burns. During and after use, do not touch, or let clothing or other flammable materials touch these areas until they have had sufficient time to cool. Among these areas are the cook top, surfaces facing the cook top, the oven vent openings and surfaces near these openings, oven door and window.
- **Wear proper apparel—Loose-fitting or hanging garments should never be worn while using the appliance.** Do not let clothing or other flammable materials contact hot surfaces.
- **Do not use water or flour on grease fires—Smother the fire with a pan lid, or use baking soda, a dry chemical or foam-type extinguisher.**
- **When heating fat or grease, watch it closely.** Fat or grease may catch fire if allowed to become too hot.
- **Use only dry potholders - Moist or damp potholders on hot surfaces may result in burns from steam.** Do not let potholders touch hot heating elements. Do not use a towel or other bulky cloth instead of a potholder.
- **Do not heat unopened food containers - Buildup of pressure may cause container to burst and result in injury.**

Important instructions for using your cooktop

WARNING

Use Proper Flame Size—Adjust flame size so it does not extend beyond the edge of the utensil. The use of undersized utensils will expose a portion of the burner flame to direct contact and may result in ignition of clothing. Proper relationship of utensil to flame will also improve efficiency.

- **Know which knob controls each surface burner.** Place a pan of food on the burner before turning it on, and turn the burner off before removing the pan.
- **Always turn knob to the full LITE position when igniting top burners.** Visually check that burner has lit. Then adjust the flame so it does not extend beyond the edge of the utensil.
- **Utensil Handles Should Be Turned Inward and Not Extend Over Adjacent Surface Burners**—To reduce the risk of burns, ignition of flammable materials, and spillage due to unintentional contact with the utensil, the handle of the utensil should be positioned so that it is turned inward, and does not extend over adjacent surface burners.
- **Never leave surface burners unattended at high heat settings**—Boilovers cause smoking and greasy spillovers that may ignite, or a pan that has boiled dry may melt.
- **Protective Liners**—Do not use aluminum foil to line surface burner pans, or oven bottom, except as suggested in this manual. Improper installation of these liners may result in risk of electric shock, or fire.
- **Glazed cooking utensils**—Only certain types of glass, glass/ceramic, ceramic, earthenware, or other glazed utensils are suitable for cook top service without breaking due to the sudden change in temperature. Check the manufacturer's recommendations for cook top use.

Important instructions for using your oven

- **Use care when opening oven door or lower oven drawer (if equipped)**—Stand to the side of the range when opening the door of a hot oven. Let hot air or steam escape before you remove or replace food in the oven.
- **Keep Oven Vent Ducts Unobstructed.** The oven vent is located below the backguard. Touching the surfaces in this area when the oven is operating may cause severe burns. Also, do not place plastic or heat-sensitive items on or near the oven vent. These items could melt or ignite.
- **Placement of oven racks.** Always place oven racks in desired location while oven is cool. If rack must be moved while oven is hot use extreme caution. Use potholders and grasp the rack with both hands to reposition. Do not let potholders contact the hot heating elements in the oven. Remove all utensils from the rack before moving.
- **Do not use the broiler pan without insert.** The broiler pan and insert allows dripping fat to drain and be kept away from the high heat of the broiler.
- **Do not cover the broiler insert with aluminum foil. Exposed fat and grease could ignite.**
- **Cold temperatures** can damage the electronic control. When using the appliance for the first time, or when the appliance has not been used for an extended period of time, be certain the unit has been in temperatures above 32°F (0°C) for at least 3 hours before turning on the power to the appliance.

Important Safety Notice

The California Safe Drinking Water and Toxic Enforcement Act requires the Governor of California to publish a list of substances known to the state to cause cancer, birth defects or other reproductive harm, and requires businesses to warn customers of potential exposure to such substances.

Important cleaning instructions

- **Clean the range regularly to keep all parts free of grease that could catch fire.** Pay particular attention to the area underneath each surface element. Do not allow grease to accumulate.
- **Kitchen cleaners and aerosols—Always follow the manufacturer's recommended directions for use.** Be aware that excess residue from cleaners and aerosols may ignite causing damage and injury.

Self cleaning ovens

- **Clean in the self-cleaning cycle only the parts listed in this Use & Care Manual.** Before self cleaning the oven, remove the broiler pan and any utensils or foods from the oven.
- **Do not use oven cleaners—**No commercial oven cleaner or oven liner protective coating of any kind should be used in or around any part of the oven.
- **Do not clean door gasket—**The door gasket is essential for a good seal. Care should be taken not to rub, damage or move the gasket.
- The health of some birds is extremely sensitive to the fumes given off during the self-cleaning cycle of any range. Move birds to another well-ventilated room.

Conversion to L.P. Gas

WARNING

- Personal injury or death from electrical shock may occur if the conversion to L.P. gas is not made by a qualified installer or electrician.
- Any additions, changes or conversions required in order for this appliance to satisfactorily meet the application needs must be made by a qualified technician.

This appliance allows for conversion to Liquefied Petroleum (L.P.) Gas.

If L.P. conversion is needed, contact your local L.P. Gas provider for assistance. The L.P. conversion kit is provided with this appliance and is located on the lower REAR (back side) panel of the range. Before installing the kit be sure to read the L.P. Installation Instructions and follow them carefully when making the installation.

Grounding Instructions

For personal safety, this appliance must be properly grounded. For maximum safety, the power cord must be plugged into an electrical outlet that is correctly polarized and properly grounded. If a 2-prong wall receptacle is the only available outlet, it is the personal responsibility of the consumer to have it replaced with a properly grounded 3-prong wall receptacle installed by a qualified electrician.

Grounding type
wall receptacle

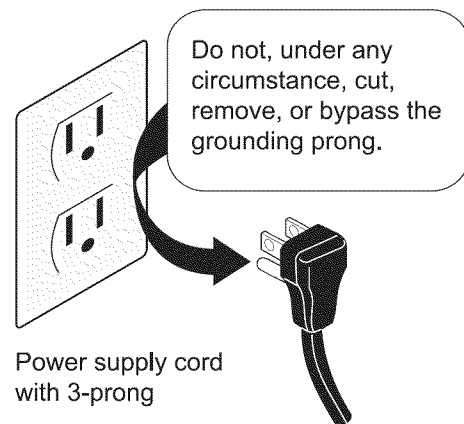

WARNING

- Avoid fire hazard or electrical shock. Do not use an adapter plug, an extension cord, or remove grounding prong from electrical power cord. Failure to follow this warning can cause serious injury, fire or death.
- This appliance is equipped with a 3-prong grounding plug for your protection against shock hazard and should be plugged directly into a properly grounded receptacle. **Do not** cut or remove the grounding prong from this plug.

See the **INSTALLATION INSTRUCTIONS** packaged with this appliance for complete installation and grounding instructions.

Range features

Your gas range features include:

1. Membrane touch control panel
2. Oven digital control display, timer and oven controls
3. Sure-2-fit™ cobalt blue self-cleaning oven interior
4. Self-clean oven door latch
5. Automatic interior oven door light switch
6. Interior oven light
7. Perfect-Convect³™ convection fan system
8. Extendable Luxury-Glide™ telescoping interior oven rack(s)
9. Interior oven racks (not shown, types may vary by model)
10. Large 1-piece metal upper & lower oven door handles
11. Color coordinated or stainless steel oven exterior panels & trim
12. Full-width tinted oven door window glass
13. Storage drawer
14. Easy-to-clean upswept cooktop.
15. Gas cooktop
16. Leveling legs & anti-tip bracket (included)
17. Broiler pan
18. Broiler pan insert

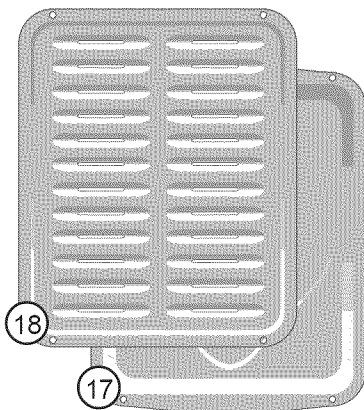
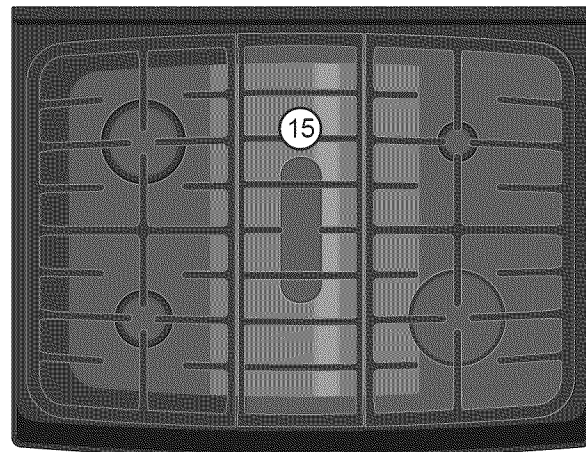
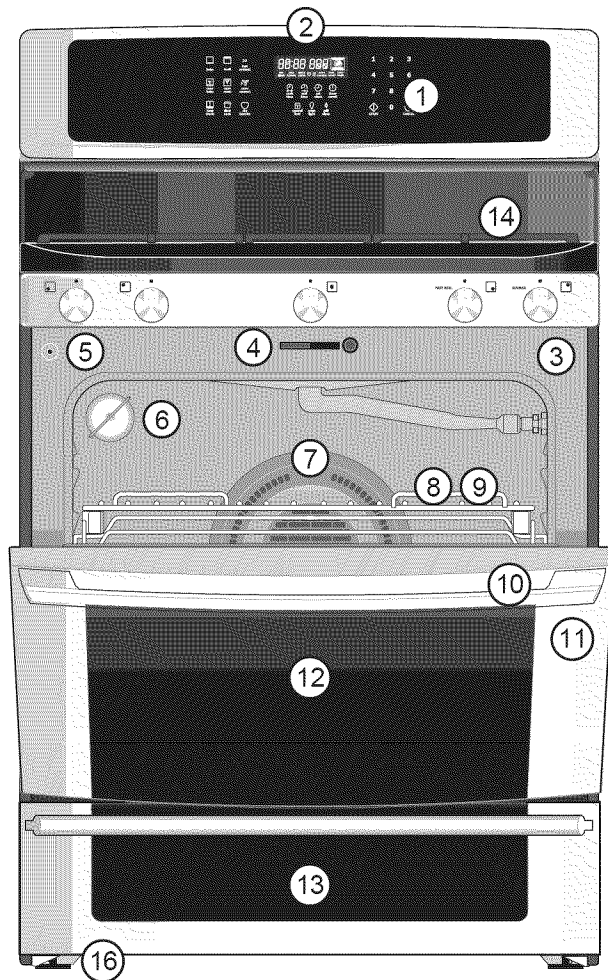

Cookware

Using proper cookware

The size and type of cookware used will influence the setting needed for best cooking results. Cookware should have flat bottoms that make good contact with the entire burner grate surface. Check for flatness by rotating a ruler across the bottom of the cookware.

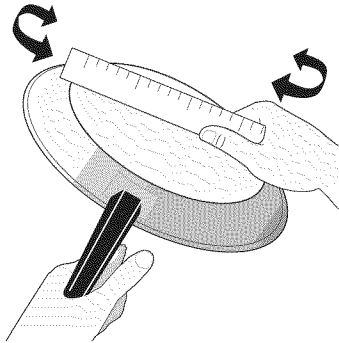

Cookware should always:

- Have flat bottoms.
- Have tight fitting lids.
- Be well-balanced.
- Be made of material that conducts heat well.
- Be easy to clean.

Cookware material types

The cookware material determines how evenly and quickly heat is transferred from the surface burner to the pan bottom. The most popular materials available are:

- **Aluminum** - Excellent heat conductor. Some types of food will cause it to darken (Anodized aluminum cookware resists staining & pitting).
- **Copper** - Excellent heat conductor but discolors easily.
- **Stainless steel** - Slow heat conductor with uneven cooking results. Is durable, easy to clean and resists staining.
- **Cast iron** - A poor heat conductor however will retain heat very well. Cooks evenly once cooking temperature is reached.
- **Porcelain-enamel on metal** - Heating characteristics will vary depending on base material.
- **Glass** - Slow heat conductor.

Before setting surface burners

Check burner cap placement before operating the surface burners

CAUTION

- To prevent flare-ups and avoid creation of harmful by-products, **do not** use the cooktop without all burner caps properly installed to insure proper ignition and gas flame size.
- Do not use the surface burners without the burner caps and burner grates properly installed. Missing pieces or improper installation may lead to spills, burns, or damage to your range and cookware.

It is **very important** to be sure that all surface burner caps and burner grates are properly installed and in the correct locations **BEFORE** operating the cooktop burners.

Remember:

- Always keep surface burner caps in place whenever using a surface burner.
- When placing the burner caps, be sure that all burner caps are seated firmly and rest level on top of burner heads.
- For proper flow of gas and ignition of burners **DO NOT** allow spills, food, cleaning agents or any other material to enter the gas orifice port opening.

Before setting surface burners (con't)

On round style burners, the burner cap lip (*Figure 1,*) should fit snug into the center of burner head and rest level. Refer to *Figures 2 and 3* for correct and incorrect burner cap placement. Once in place, you may check the fit by gently sliding the burner cap from side to side (*Figure 4*) to be sure it is centered and firmly seated. When the burner cap lip makes contact inside the center of the burner head you will be able to hear the burner cap click. Please note that the burner cap should NOT move off the center of the burner head when sliding from side to side.

Check and be sure that all **oval** style burner caps are correctly in place on oval burner heads.

Installing burner grates

Make sure the burner grates are properly placed on the cooktop before using the surface burners. The grates are designed to rest inside the recess on the cooktop.

To install burner grates, place grates flat-side down and align into the cooktop recess. Grates should rest flush against each other and against the sides of the recess (see *Figure 5*).

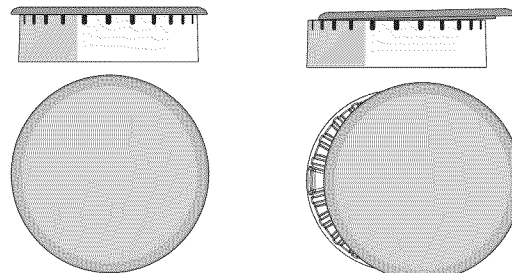

Correct burner cap placement
Fig. 2

Incorrect burner cap placement
Fig. 3

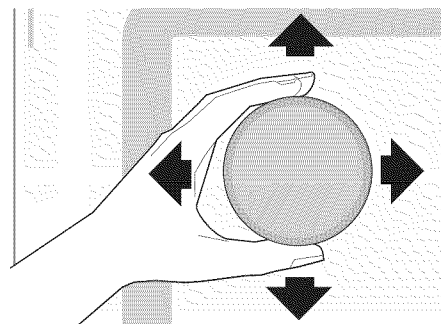

Fig. 4

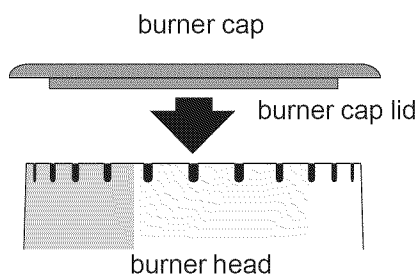

Fig. 1

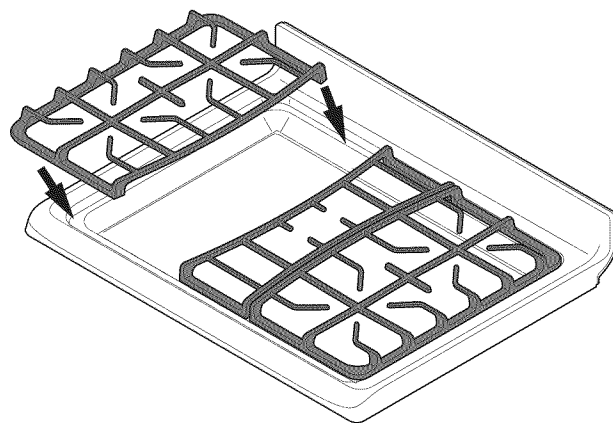

Fig. 5

10 Surface Cooking

Setting surface burners

1. Push the desired gas surface control knob in and turn counterclockwise out of the OFF position (*Figure 1*).
2. Turn knob to ☆ (lite) position. Visually check that the needed burner has lit.
3. To adjust, turn counterclockwise to a flame size setting that best fits your need.

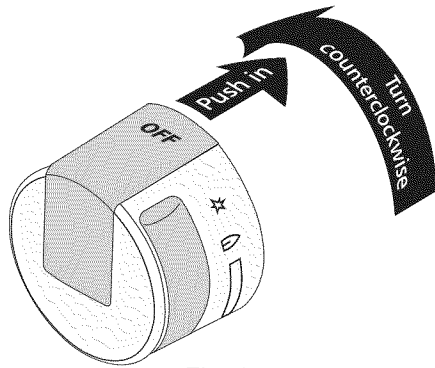

Fig. 1

Home canning

Be sure to read and observe all the following points when home canning using your appliance. **Review the latest online information available for home canning, such as the U.S. Department of Agriculture or the National Center for Home Food Preservation (NCHFP).**

- Use only quality flat bottom canners when home canning. Use a straight-edge to check canner bottom.
- Start with hot tap water **to bring water to boil more quickly.**
- Use the highest heat seating when first bringing the water to a boil. Once boiling is achieved, reduce heat to lowest possible setting to maintain that boil.
- Make sure the diameter of the canner does not exceed 1 inch beyond the burner grate

Surface burner positions

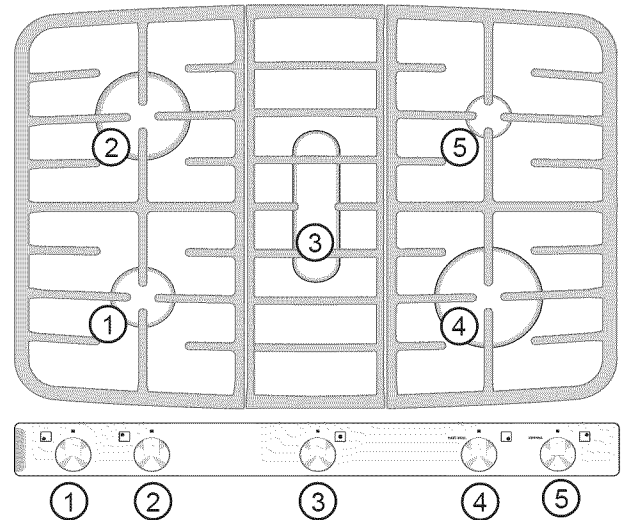

1. Standard burner -9.5K BTU- best for most surface cooking requirements.
2. Medium burner -12K BTU- best for most surface cooking requirements.
3. Oval center burner -10K BTU- best for griddles.
4. Fast Boil™ burner -18,000 BTU - best for bringing large quantities of liquid to boil or when preparing large quantities of food.
5. Perfect Simmer™ burner -5,000 BTU- best for simmering delicate sauces, melting chocolates, etc.

Oven vent location

The oven vent is located below the backguard. When the oven is on, warm air is released through this vent. This venting is necessary for proper air circulation and provides good baking results in the oven. **DO NOT BLOCK THIS VENT.**

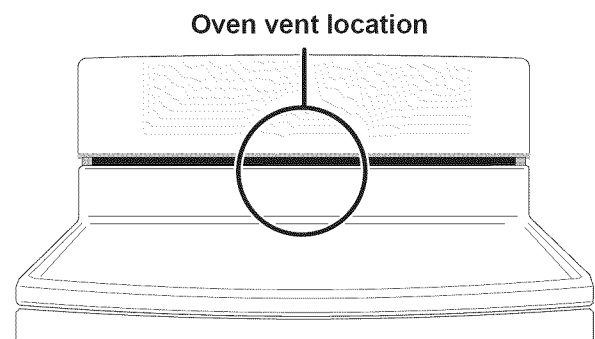

Oven racks

CAUTION

Always use potholders or oven mitts when removing food or adjusting the oven racks. Wait until the oven has completely cooled if possible. Oven racks may be **HOT** and may cause burns.

Air circulation in the oven

For best air circulation when baking, allow a space of 2-4 inches (5-10 cm) around the cookware for proper air circulation. Be sure pans and cookware do not touch each other, the oven door, sides or back of the oven cavity.

Hot air must be able to circulate around cookware for even heat to reach the food.

Removing and replacing flat or offset oven racks

- **To remove** - pull the oven rack straight forward until it reaches the stop position. Lift up front of oven rack slightly and slide out.
- **To replace** - place the oven rack on the rack guides on the oven walls. Tilt the front of the rack upward slightly and slide the oven rack back into place.

Types of oven racks

Your appliance may be equipped with any one or more of the following oven rack types:

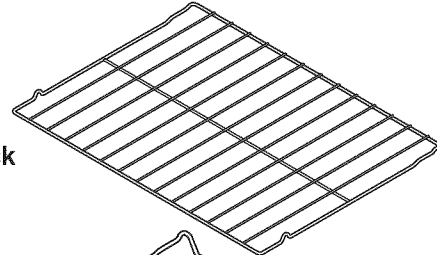

Flat oven rack

Fig. 2

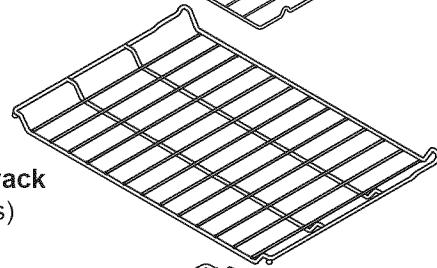

Offset oven rack

(some models)

Fig. 3

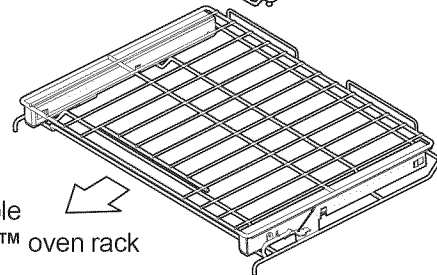

Fully extendable **Luxury-Glide™** oven rack

Fig. 4

Flat oven racks may be used for most cooking needs and may be placed in most oven rack positions.

The **offset oven rack** (some models, see Figure 3) provides additional stepdown positions from the standard flat rack design. The offset design positions the base of the rack about 1/2 of a rack position lower than the flat rack and may be used in most oven rack positions.

The fully extendable **Luxury-Glide™** oven rack (see Figure 4) allows you to effortlessly extend your food away from the oven. See **Removing and Replacing the Luxury-Glide™ Oven Racks** for instructions.

Luxury Glide™ oven racks

➔ IMPORTANT

Remove **ALL oven racks** before starting a self-clean cycle. If oven racks are left inside the oven during a cleaning cycle, the slide ability of the **Luxury-Glide™** oven racks may be damaged and all of the oven racks will lose their shiny finish. Clean oven racks according to the instructions provided in the **Care & Cleaning** section.

The fully extendable **Luxury-Glide™** rack makes food preparation easier. This oven rack has glide tracks that allow the rack to be pulled away from the oven without rubbing the sides of the oven wall.

Removing and replacing the Luxury-Glide™ oven racks

To remove - Using one hand, reach through handle opening and lift up on the release lever located across the lower front of the rack as shown in Figure 1.

While holding up the release lever, pull the glide rack out of the oven until the stop position is reached (see Figure 2). Using both hands, grasp the upper and lower portions of the glide rack. Lift up the front of the rack slightly and continue to pull the rack away from the oven (see Figure 3). Be sure to grasp both upper and lower rack portions together when removing or handling the glide rack. The rack portions move independently and are difficult to handle unless held together.

To replace - grasp both upper and lower portions of glide rack, lift and hold the rack level between the oven cavity walls. Tilt the front of the rack upward slightly and slide the rack completely into position. Some force may be necessary to make sure the oven rack has snapped completely into place.

➔ IMPORTANT

To prevent possible damage to the oven, **DO NOT** attempt to close the oven door until all the oven racks are fully positioned back inside the oven cavity.

Luxury-Glide™ extendable oven rack

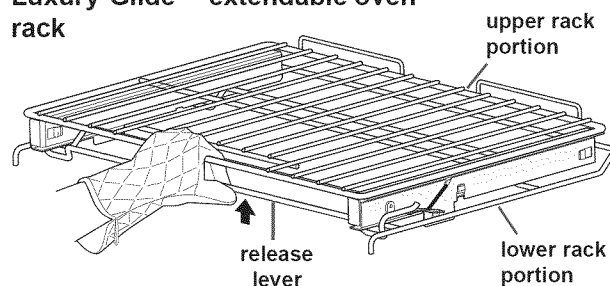

Fig. 1

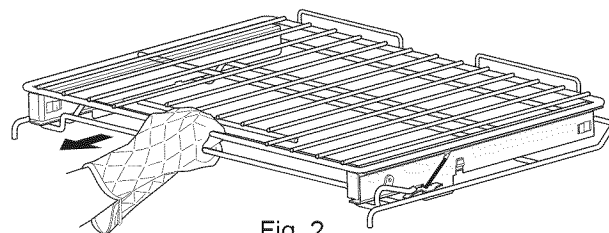

Fig. 2

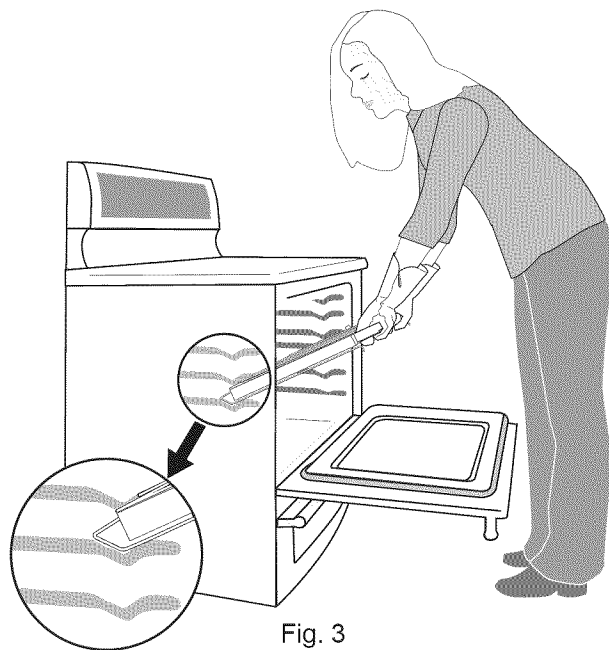
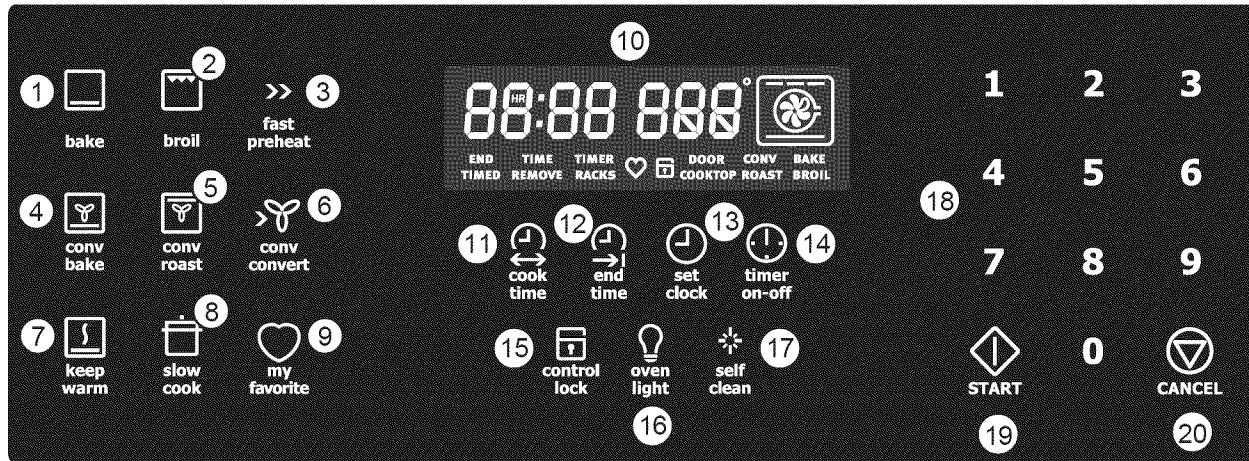

Fig. 3

Oven control display and keys



- | | |
|-----------------------|---------------------|
| 1. Bake | 11. Cook Time |
| 2. Broil | 12. End Time |
| 3. Fast Preheat | 13. Set Clock |
| 4. Convection Bake | 14. Oven Timer |
| 5. Convection Roast | 15. Control Lock |
| 6. Convection Convert | 16. Oven Light |
| 7. Keep Warm | 17. Self-clean |
| 8. Slow Cook | 18. Numeric Key Pad |
| 9. My Favorite | 19. Start |
| 10. Oven display | 20. Cancel |

Minimum & maximum control settings

Feature	Min. temp	Max. temp
Fast Preheat	170°F / 76°C	550°F / 288°C
Bake	170°F / 76°C	550°F / 288°C
Broil	400°F / 204°C	550°F / 288°C
Conv Bake	300°F / 148°C	550°F / 288°C
Conv Roast	300°F / 148°C	550°F / 288°C
Keep Warm	150°F / 66°C	190°F / 88°C
Slow Cook	Lo (225°F / 108°C)	Hi (275°F / 135°C)

Minimum & maximum time settings

Feature	Min. time	Max. time
Timer	1 min	11 hr 59 min
Clock 12 hr	1:00 hr	11 hr 59 min
Clock 24 hr	0:00 hr	23 hr 59 min
Cook time 12 hr	1 min	11 hr 59 min
End time 12 hr	1:00 hr	12 hr 59 min
End time 24 hr	0:00 hr	23 hr 59 min
Clean duration	(2 hr)	(4 hr)

14 Setting Oven Controls



Setting the clock

When the appliance is powered up for the first time or when the electric supply to the appliance has been interrupted, the display will **flash** "12:00" (Figure 1).



Fig. 1

To set the clock for 1:30:

Step	Example	Press
1.	Press set clock .	
2.	Enter 130 using the numeric keypad.	130
3.	Press START to accept.	

NOTES

- Be sure to set the clock with the **correct** time of day before using the oven, especially cooking with added time instructions.
- The clock cannot be adjusted when the oven is cooking, when the timer is active or during self-clean.
- If an invalid time of day is entered, the control will sound a triple beep (error tone). Re-enter a valid time of day and press **START**. If **CANCEL** is pressed the clock will set for **12:00**.

Changing clock display mode

The oven control is factory preset to display the time of day with a 12-hour clock setting. The display can be changed to provide the time of day using a 24-hour clock display or the clock display may be turned OFF.

When the clock display is turned OFF, the clock continues to run in the background on the previously chosen 12-hour or 24-hour mode.

To change clock display modes:





Step	Example	Press
1.	Press and hold set clock for 6 seconds.	
2.	Press set clock to toggle between "12 Hr dAY", "24 Hr dAY" or "CLO OFF" display choices. Release keypad when the desired mode appears (Figures 1, 2 and 3).	 
3.	Press START to accept.	



Fig. 1



Fig. 2



Fig. 3

NOTE

- The clock display mode cannot be modified when the oven is active with any cooking function or during self-clean.

Changing oven temperature display mode (°F or °C)

The oven control is factory preset to display oven temperatures with Fahrenheit (°F) values. The control may be changed to display either Fahrenheit or Celsius (°C) temperatures.

To change the temperature display mode:



Example	
Step	Press
1. Press and hold broil key for 6 seconds. Release when "F" or "C" appears in display.	
2. Press broil to toggle between "F" or "C" temperature display choices. Release key when desired mode appears in display (Figures 1 and 2).	
3. Press START to accept.	



Fig. 1



Fig. 2

NOTE

The temperature display mode cannot be modified when the oven is active or once self-clean is set.

Changing between 12-Hour Energy Saving or continuous bake mode settings

The oven control is factory preset for a 12-Hour Energy Saving mode. This setting automatically turns the oven off after 11 hours and 59 minutes of continuous cooking. The control may be set to override this feature.

To change between 12-Hour Energy Saving or continuous bake settings:



Example	
Step	Press
1. Press and hold timer on-off key for 6 seconds.	
2. Press timer on-off to choose between "12 Hr OFF" (Figure 3) or "StAY On" (Figure 4). Release key.	
3. Press START to accept.	



Fig. 3



Fig. 4

NOTE

Changing between the 12-Hour Energy Saving or continuous bake mode will not change how the cooktop controls operate.

16 Setting Oven Controls

Adjusting tone volume

A tone will sound when a key is pressed and at the end of a cycle (**timer**, **cook time** or **end time**). The factory audio setting is preset to the highest level (5). The control may be adjusted for lower levels 1 through 5, or OFF.

To adjust audio tone level:



Example	
Step	Press
1. Press and hold end time for 6 seconds (AUD will appear on left side of display window) then release keypad.	
2. To toggle through the available audio levels press and continue to press end time . When the level you prefer is displayed release the keypad. Level 5 is the highest setting - <i>Fig. 1</i> -, 1 is the lowest setting - <i>Fig. 2</i> - and AUD OFF - <i>Fig. 3</i> -will provide a silent control setting.	
3. Press START to accept.	



Fig. 1

Fig. 2



Fig. 3

NOTE

When the control is set for **Aud OFF**, error tones will remain audible.

Oven control lock

The control lock will lock the oven controls and the oven door. This feature does **not lock** the cooktop controls.

Examples

Step	Press
------	-------

To activate the control lock:

Press and hold **control lock** key for 3 seconds. "**door Loc**" will appear in the display until the oven door is locked.



To cancel control lock:

Press and hold **control lock** key for 3 seconds. Once the oven door is unlocked, the "**door Loc**" message will no longer display (*Figure 1*).



Fig. 1

NOTES

- To avoid possible damage to the oven door locking mechanism, do not attempt to force the oven door open when the **door Loc** message is displayed.
- If an oven control key is pressed when oven lock is active, the oven will sound an error tone (triple beep) indicating the function is not available until the control lock feature is turned off.



Timer

The timer may be used to help time cooking or food preparation times without interfering with any active cooking process. When the timer countdown reaches less than 1 minute, the display will show time remaining in seconds. When the time runs out the timer will beep, "End" will flash in the display.

Timer settings:

- Minimum set time: 1 minute
- Maximum set time: 11 hours 59 minutes

How to set the timer for 5 minutes:

Example	
Step	Press
1. Press timer on-off .	
2. Enter 5 minutes using numeric keypad.	5
3. Press start .	

To cancel an active timer at anytime, press the **timer on-off** keypad.

NOTES

- The timer **does not** start or stop the cooking process. The timer may be started alone or with any other active oven feature.
- The timer will display hours and minutes until 1 hour remains. When less than 1 hour remains, the display will count down in minutes and seconds. Once the timer has less than 1 minute remaining, only seconds will display.
- If both the oven and timer are active, the timer information will display by default. To momentarily display information for any other active oven feature, press the corresponding key once for the other feature.

18 Setting Oven Controls

Fast preheat

Use the fast preheat option for single rack baking to quickly bring the oven to baking temperature. The fast preheat option must be set using the **bake** or **conv bake** feature. Fast preheat may be set with **cook time** or cook time with an **end time**. The following oven temperature settings apply for fast preheat:





- Factory default temperature: 350°F/176°C
- Minimum fast preheat setting: 170°F / 77°C
- Maximum fast preheat setting: 550°F / 288°C



For best results

- **Recommended for single oven rack cooking ONLY.** Use oven rack position 2 or 3.
- For batter and dough-based baked goods such as cakes, pastries, and breads, use the standard bake function for best results.

To set fast preheat using the default oven temperature:

Example	
Step	Press
1. Press bake or conv bake .	 or 
2. Press fast preheat .	
3. Press START .	

When activated, the oven will begin preheating and "**PRE**" will appear in the display (-Fig. 1-).







Fig. 1

A tone will sound indicating the oven has finished preheating. Place prepared food inside oven using a **single** oven rack.

To stop preheating at any time press **CANCEL**.

How to set fast preheat with the oven temperature set for 425°F/ 218°C):

Example	
Step	Press
1. Press bake or conv bake	 or 
2. Enter 4 2 5 using numeric keypads	425
3. Press fast preheat	
4. Press START	

To stop **fast preheat** at any time press **CANCEL**.



NOTES

- To change temperature settings **after** fast preheat has started, press **bake** key, enter the desired temperature with the numeric keypad, and press **START** to accept.
- To change cooktime settings **after** fast preheat has started, press **cooktime** key, enter the desired time with the numeric keypad, and press **START** to accept.



IMPORTANT

Once the oven has fully preheated, the **fast preheat** feature will perform like **bake** and continue to bake until cancelled.

Bake

Use **bake** to cook most food items that require normal cooking temperatures. Bake may be set with the following options:

- Fast preheat
- Cook time and Cook time with end time setting

The following oven temperature settings apply to the **bake** feature:

- Factory default bake setting: 350°F / 176°C
- Minimum bake setting: 170°F / 77°C
- Max. bake setting: 550°F / 288°C

To set the oven for **bake** at the factory default oven temperature of 350°F (176°C):



Example	
Step	Press
1. Press bake . The default oven temperature of 350°F will appear in the display.	
2. Press START (Figure 1).	



Fig. 1



Once **bake** is active the oven will begin preheating. When the oven reaches set temperature the control will sound a tone indicating the oven is ready.

To stop **bake** at any time press **CANCEL**.

CAUTION

- Always use pot holders or oven mitts when working with a hot oven. When cooking, the oven interior, oven racks and cooktop will become **hot** enough to cause burns.
- **Do not cook foods directly on the oven bottom.** To avoid damaging the oven interior and surfaces, always cook foods in the oven using cookware positioned on an oven rack.

To set **bake** with the oven temperature set for 425°F / 218°C):

Example	
Step	Press
1. Press bake	
2. Enter 4 2 5 using numeric keypad	425
3. Press START	

To stop **bake** at any time press **CANCEL**.

NOTES

- A **cook time** setting may be added any time after starting **bake**. Refer to the **cook time** section for complete instructions.
- If **bake** is active without a **cook time** setting, the oven will remain on for 12 hours before automatically turning off unless cancelled. If you wish to **bake** for longer than 12 hours, see "Changing between 12-Hour Energy Saving or continuous **bake** mode settings" for instructions.

20 Setting Oven Controls

Bake (cont'd)



For best results

- Fully preheat the oven before baking items like cookies, biscuits and breads.
- When using any single rack, position the rack so that the food is in the center of the oven.
- For best results when baking cakes using 2 oven racks, place the Luxury Glide™ rack in position 4 and a flat rack in position 2 (Figure 1).
- If using two flat racks, place racks in positions 2 and 5 (Figure 1).
- When baking using 2 oven racks, position cookware as shown in *Figure 2*. Allow at least 2 inches (5 cm) of space between cookware for proper air circulation.
- Dark or dull pans absorb more heat than shiny bakeware, resulting in dark or overbrowning of foods. It may be necessary to reduce the oven temperature or cook time to prevent overbrowning of some foods. Dark pans are recommended for pies. Shiny pans are recommended for cakes, cookies, and muffins.
- Use the convection bake function for cookies.

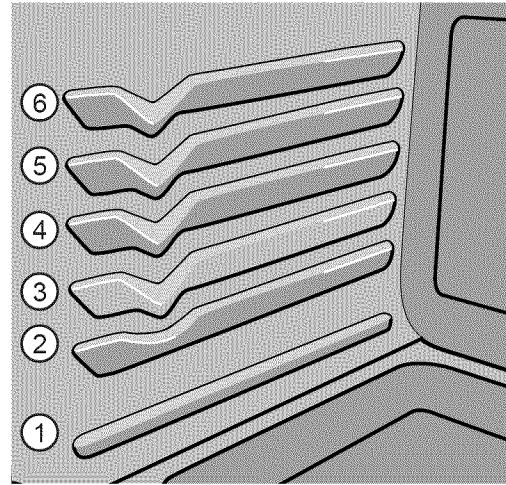

Fig. 1

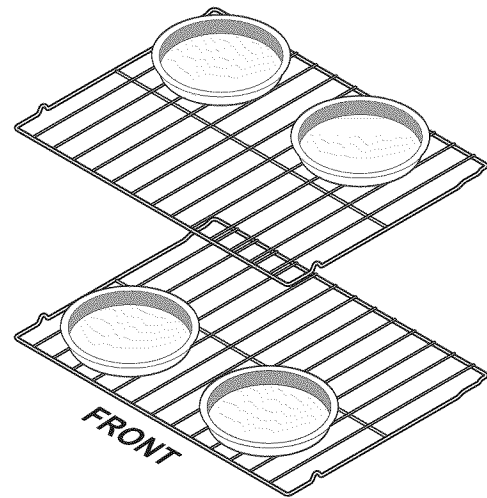

Fig. 2

Cook time

The cook time feature is used when a recipe calls for a specific temperature and cook time. Following the recipe's suggested cook time can help ensure the best possible results.

The maximum cook time setting is 11 hours, 59 minutes. Cook time instructions may be set with the following features:

- Bake
- Conv bake
- Conv roast
- Slow cook
- Keep warm
- Fast preheat
- My favorite

To bake for 30 minutes with the oven default temperature setting of 350°F (176°C):





Example	
Step	Press
1. Press cook time .	
2. Enter 30 using numeric keypads.	30
3. Press START .	
4. Press bake .	
5. Press START (Figure 1).	



Fig. 1

Once active, the oven display will show "TIMED" and "BAKE" (Figure 1). The oven will cook at the set temperature for 30 minutes and then automatically shut-off.

When the cook time runs out:

"End" will appear in the display window and the oven will shut-off automatically (Figure 2). The control will beep 3 times every 30 seconds until the cancel keypad is pressed.

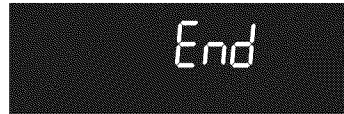

Fig. 2

To stop cooking at any time press **CANCEL**.

WARNING

FOOD POISONING HAZARD. Do not let food sit for more than one hour before or after cooking. Doing so can result in food poisoning or sickness.

NOTES

- When cooking with a cook time setting, press the active **cook time** key once to momentarily display any remaining cook time.
- When cooking with cook time settings, the cook time may be removed at anytime by setting a new cook time of **0:00**.
- **Cook time** settings cannot be added to the broil or self-clean features.

Setting cook time with end time

Adding a cook time with a specific end time gives the same benefits as the cook time option in addition to controlling exactly when the cooking process will begin and end.

Cook time and end time instructions may be set with the following features:

- Bake
- Conv bake
- Conv roast
- Slow cook
- Keep warm

▶ IMPORTANT

Before setting **end time** instructions, be sure the time of day is correct.

To set the oven to bake at 375°F (191°C) for 50 minutes and to automatically shut-off at 5:30:







Example	
Step	Press
1. Press cook time .	
2. Enter 50 minutes using numeric keypads.	50
3. Press START .	
4. Press end time .	
5. Enter 530 using numeric keypads.	530
6. Press start .	
7. Press bake (Figure 1).	
8. Enter 375 using numeric keypads.	375
9. Press START to activate.	



Fig. 1

Once **START** is pressed, the oven will calculate the delayed start time. Once the delayed start time has passed, the oven will automatically turn on and heat to the set temperature. The oven will continue to maintain this temperature during the set cook time until reaching the set end time.

When the cook time runs out:

"**End**" will appear in the display window and the oven will shut-off automatically (Figure 2). The control will beep 3 times every 30 seconds as a reminder until the **CANCEL** keypad is pressed.



Fig. 2

To stop cooking at any time press **CANCEL**.

⚠ CAUTION

Use caution when preparing foods with **cook time** or **end time** instructions. Foods that can easily spoil such as milk, eggs, fish, meat or poultry, should be chilled in the refrigerator first. Even when chilled, they should not stand in the oven for more than 1 hour before cooking begins, and should be removed promptly when done.

🗨 NOTES

- An **end time** setting may be set with **fresh clean**. Refer to the fresh clean section for details on how to select different clean cycle times.
- The **end time** setting may be added to the **fast preheat**, **conv bake** or **conv convert** features. An **end time** setting cannot be added to **broil**.
- Once the **end time** feature has started the cooking process, press the **cook time** keypad once to display any cook time remaining.

Broil

Use the broil feature to cook meats that require direct exposure to radiant heat for optimum browning results.

The following oven temperature settings apply to the broil feature:

- Factory default temperature: **550°F / 288°C**
- Min. broil setting: **400°F / 205°C**
- Max. broil setting: **550°F / 288°C**

WARNING

Should an oven fire occur, **close the oven door**. If the fire continues, throw baking soda on the fire or use a fire extinguisher. **Do not** put water or flour on the fire. Flour may be explosive and water can cause a grease fire to spread and cause personal injury.

CAUTION

- **Always** use **pot holders** or **oven mitts** when working with a hot oven. When broiling, the oven interior, oven racks and cooktop will become **hot** enough to cause burns.
- **Do not** use the broiler pan without the insert.
- **Do not** cover the broil pan/insert with aluminum foil; the exposed grease could ignite.
- To prevent food from contacting the broil element and to prevent grease splattering, **do not** use the roasting rack when broiling.

For best results

- For optimum browning results, allow the oven to preheat **5-6 minutes** before placing meat in the oven.
- To avoid burning food, watch the food carefully when broiling and turn meat when needed.
- Use the recommended pans and oven rack positions for the type and amount of meat being prepared. See *Broiling Table* on the next page.

To set broil with the factory default temperature setting of **550°F / 288°C**:



Example	
Step	Press
1.	Place the broiler insert on the broiler pan, then place the meat on the insert. Remember to follow all warnings and cautions.
2.	Arrange the interior oven rack to rack position recommendations. See <i>Figures 3 and 4 on the next page</i> . Be sure to place the pan with meat directly under broil element.
3.	Press broil . 
4.	Press START . 
5.	Turn meat when desired doneness for first side is obtained.



Fig. 1

Once activated, the oven display will show "BROIL" (*Figure 1*) and will broil at the set temperature until cancelled.

To stop broil at anytime press **CANCEL**.

24 Setting Oven Controls

Broil (con't)

The broil pan insert has slots that allow grease and fat from the meat to drain into the broil pan. Place prepared meat on broil pan insert and then place onto broiler pan as shown in *Figure 1*.

Recommended broiling times

Use the broiling table (*Figure 3*) for approximate recommended broiling times for the types of meats listed. Increase or decrease broiling times, or move the broiling pan to a different rack position to suit for doneness.

If the food you are broiling is not listed in the table, follow the instructions provided in your recipe and watch the item closely.

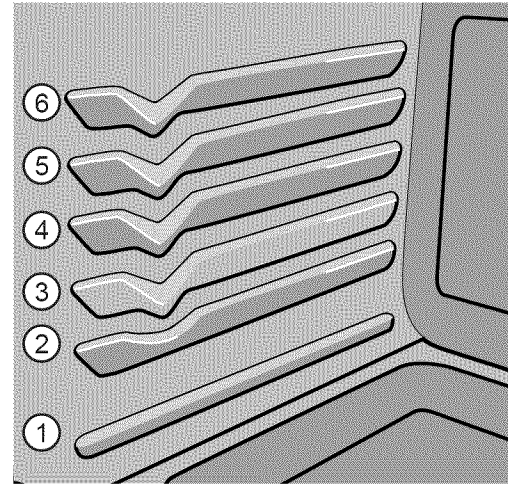

Fig. 2

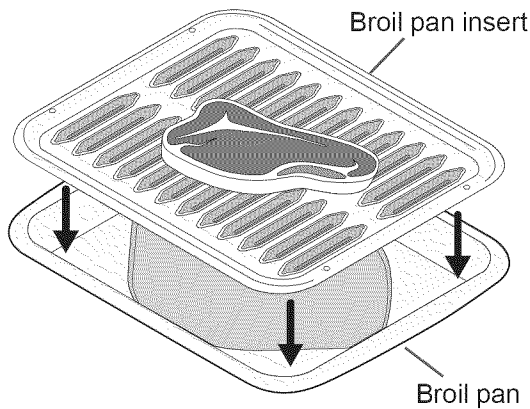

Fig. 1

Broiling Table

Food	Rack position	Temp	Cook time in minutes		Doneness
			1st side	2nd side	
Steak 1" thick	5th or 6th*	550°F	8	6	Medium
Steak 1" thick	5th or 6th*	550°F	10	8	Medium-well
Steak 1" thick	5th or 6th*	550°F	12	8	Well
Pork chops 3/4" thick	5th	550°F	12	8	Well
Chicken-bone in	4th	450°F	25	15	Well
Chicken-boneless	5th	450°F	12	8	Well
Fish	5th	500°F	as directed		Well
Shrimp	4th	550°F	as directed		Well
Hamburger 1" thick	6th*	550°F	17	10	Medium
Hamburger 1" thick	5th	550°F	14	12	Well

*Use the off-set rack (if provided) when using oven rack position 6.

Fig. 3

Conv bake

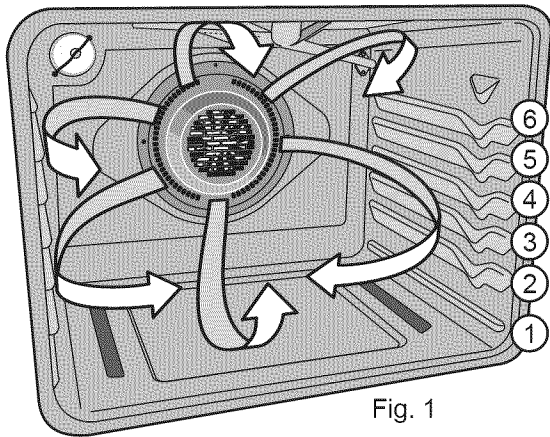

Fig. 1

Convection (conv) bake uses a fan to circulate the oven heat evenly and continuously (*Figure 1*). The improved heat distribution allows for even cooking with excellent results. Multiple rack cooking may slightly increase cook times for some food types, but the overall result will be time saved.

The conv bake feature should only be used when your recipe instructions have been written especially for convection baking.

If your recipe instructions are for baking and you wish to use conv bake, follow the **conv convert** option instructions. The conv convert option will automatically adjust the oven temperature so that convection baking will provide the best possible results.

Benefits of conv bake:

- **Superior multiple oven rack performance.**
- Foods cook more evenly.
- No special pans or bakeware required.

Conv bake may be set with the following options:

- Conv convert
- Fast preheat
- Cook time or cook time with end time settings

The following temperature settings apply to the conv bake feature:

- Factory default setting: 350°F/176°C
- Min. bake setting : 300°F / 148°C
- Max. bake setting: 550°F / 288°C

To set conv bake with the factory default temperature setting of 350°F (176°C):

Example	
Step	Press
Preheat the oven if needed.	
1. Press conv bake .	
2. Press START .	

When activated, the control display will show "**CONV BAKE**" (*Figure 2*) and the oven will begin heating. Once the oven reaches the set temperature a tone will sound indicating the oven is ready.



Fig. 2

To stop conv bake at anytime press **CANCEL**.

NOTE

The convection fan will not run during the first 6 minutes of cooking. This is normal. The fan will begin to run as the oven approaches the target temperature.

Conv bake (cont'd)



For best results

- Fully preheat the oven before baking items like cookies, biscuits and breads.
- When using any single rack, position the rack so that the food is in the center of the oven.
- For best results when baking cakes using 2 oven racks, place racks in positions 2 and 4 (*Figure 1*). Use the Luxury Glide™ rack in position 4.
- If using two flat racks, place racks in positions 2 and 5 (*Figure 1*).
- When baking using 2 oven racks, position cookware as shown in *Figure 2*. Allow at least 2 inches (5 cm) of space between cookware for proper air circulation.
- Cookies and biscuits should be baked on pans with no sides or very low side to allow heated air to circulate around the food.
- Food items baked on pans with a dark finish will cook faster.
- Use the radiant bake function for cakes.

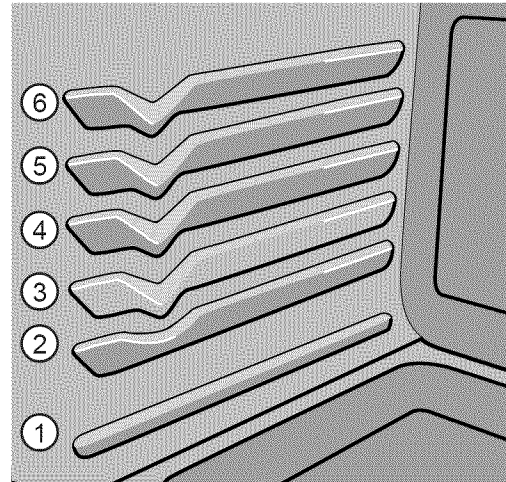

Fig. 1

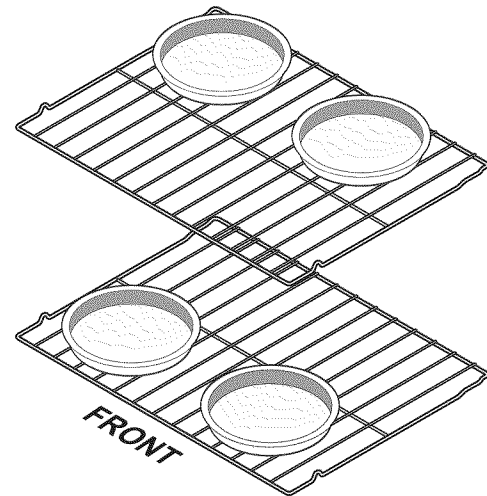

Fig. 2

Conv convert

The convection (conv) convert feature allows you to convert any normal baking recipe into a convection bake recipe. The control uses the normal recipe settings and adjusts to a lower temperature for convection baking. Conv convert must be used with conv bake. Conv convert may be set with cook or end time instructions.

Benefits of conv convert:

- Superior multiple oven rack performance.
- Some foods cook faster, saving time and energy.
- No special pans or bakeware required.

To set conv convert with the factory default oven temperature of 350°F (176°C):



Example	
Step	Press
1. Press conv bake .	
2. Press conv convert .	



Fig. 1





When activated, the control display will show "CONV BAKE" (Figure 1) and the oven will begin heating. Once the oven reaches the set temperature a tone will sound indicating the oven is ready.

To stop conv convert at anytime press **CANCEL**.

NOTES

- When using **conv convert**, cook time reductions may vary depending on the oven set temperature.
- **Conv convert reduces original temperatures by 25°F (14°C).**
- The conv convert feature will work best if the **cook time** is 20 minutes or longer. If a cooktime is set that is less than 20 minutes, the feature will not provide a "CF" (check food) message.

To set conv convert for 30 minutes with a temperature setting of 375°F (191°C):

Example	
Step	Press
1. Press cook time .	
2. Enter 30 using numeric keypad.	30
3. Press START .	
4. Press conv bake .	
5. Enter 375 using numeric keypad.	375
6. Press conv convert .	

When conv convert is used with cook time or end time settings, the conv convert feature will display a "CF" for **check food** when the cook time is 75% complete (Figure 2). At this time the oven control will provide 1 long tone at regular intervals until the set cook time has finished or conv convert is canceled.

To stop conv convert at anytime press **CANCEL**.



Fig. 2



For best results

- Follow the rack placement and pan position recommendations in the **Convection Bake** section of this Use and Care Guide.

Conv roast

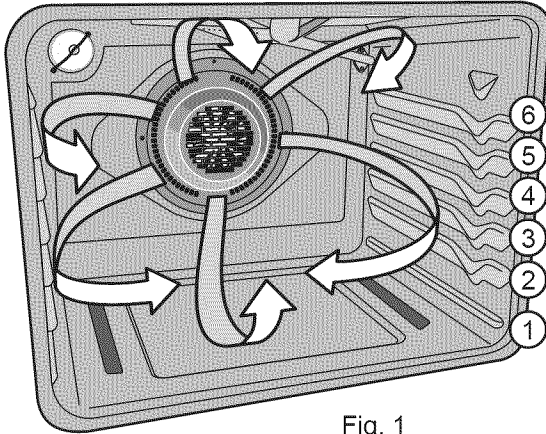

Fig. 1

How conv roast works

Convection (conv) roast combines a cook cycle with the convection fan and element to rapidly roast meats and poultry. Heated air circulates around the meat from all sides, sealing in juices and flavors. Meats cooked with this feature are crispy and brown on the outside while staying moist inside. There is no need to reduce the oven temperature when using conv roast.

Conv roast may be set with the following options:

- Cook time
- Cook time with end time

The following oven temperature settings apply for conv roast:

- Factory default temperature: 350°F / 176°C
- Min. conv roast setting: 300°F / 148°C
- Max. conv roast setting: 550°F / 288°C



Benefits of conv roast:

- Superior multiple oven rack performance.
- Some foods will cook faster, saving time and energy.

NOTE

The convection fan will not run during the first 6 minutes of cooking. This is normal. The fan will begin to run as the oven approaches the target temperature.

To set conv roast with the factory default oven temperature setting of 350°F (176°C):

Example	
Step	Press
1. Press conv roast .	
2. Press START	

When activated, the control display will show "**CONV ROAST**" and the oven will begin heating. Once the oven reaches the set temperature a tone will sound indicating the oven is ready



Fig. 2

To stop conv roast at anytime press **CANCEL**.



For best results

- Preheating for conv roast will not be necessary for most meats and poultry.
- Place food items on rack positions 1, 2, or 3, keeping food in center of the oven cavity (see *Figure 1*).
- Since **conv roast** cooks faster, reduce cook times by 25% from the recommended time of your recipe (check the food at this time). Then if needed, increase cook time until the desired doneness is obtained.
- Place food items using the recommended rack positions for the type of food being prepared.
- Be sure to carefully follow your recipe's temperature and time recommendations or refer to the conv roast recommendations for additional information. *See Figure 2 on the next page.*
- Do not cover foods when dry roasting - covering will prevent the meat from browning properly.

Conv roast (cont'd)

When preparing meats for conv roast, you should use the broiler pan and insert. The broiler pan will catch grease spills and the insert will help prevent grease splatters.

1. Place oven rack on bottom or next to the bottom oven rack position.
2. Place the insert on the broiler pan.
3. Be sure the insert is securely seated on top of the broiler pan. **Do not** use the broiler pan without the insert. **Do not** cover the insert with aluminum foil.
4. Place meat (fat side up) on insert (*Figure 1*). Place prepared food on oven rack and slide into the oven.

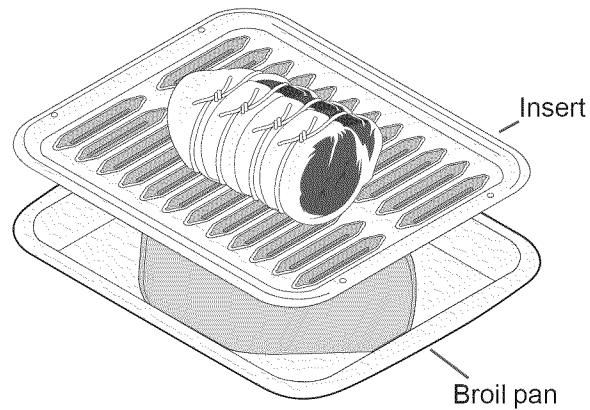

Fig. 1

Conv Roast Setting Suggestions

Meat	Weight	Oven temp	Internal temp	Minute per lb.	
Beef	Standing rib roast	4 to 6 lbs.	350°F	*	25-30
	Rib eye roast	4 to 6 lbs.	350°F	*	25-30
	Tenderloin roast	2 to 3 lbs.	400°F	*	15-25
Poultry	Turkey, whole**	12 to 16 lbs.	325°F	180°F	8-10
	Turkey, whole**	16 to 20 lbs.	325°F	180°F	10-15
	Turkey, whole**	20 to 24 lbs.	325°F	180°F	12-16
	Chicken	3 to 4 lbs.	350°F -375°F	180°F	12-16
Pork	Ham roast, fresh	4 to 6 lbs.	325°F	160°F	30-40
	Shoulder blade roast	4 to 6 lbs.	325°F	160°F	20-30
	Loin	3 to 4 lbs.	325°F	160°F	20-25
	Pre-cooked ham	5 to 7 lbs.	325°F	160°F	30-40

Fig. 2

* For beef: medium 160°F, well done 170°F.

** Stuffed turkey requires additional roasting time. Shield legs and breast with foil to prevent overbrowning and drying of the skin.

Keep warm

Use the keep warm feature to keep hot foods warm. Keep warm may be set with the following options:

- Cook time
- Cook time with end time



The following temperature settings apply to the keep warm feature:

- Auto-suggest (default) setting: 170°F / 76°C
- Minimum keep warm setting: 150°F / 66°C
- Maximum keep warm setting: 190°F / 88°C



WARNING

- **FOOD POISONING HAZARD. Do not let food sit for more than one hour before or after cooking. Doing so may cause bacteria to grow which can result in food poisoning or sickness.**
- To prevent food from contacting the broil element and to prevent grease splattering, **do not** use the roasting rack when broiling.

To set keep warm with the default setting:

Example	
Step	Press
1. Press KEEP WARM	
2. Press START	

To set keep warm with a setting of 150°F:

Example	
Step	Press
1. Press KEEP WARM	
2. Enter 150 using numeric keypad.	150
3. Press START	

If changing cooking times, select the **cook time** or **end time** keys needed to make the changes.

To end keep warm at any time, press **CANCEL**.

Temperature selection

See the recommended settings chart below for keep warm. If a particular food is not listed, use the default temperature of 170°F. If more crispness is desired, remove the lid or aluminum foil from the food. Most foods can be kept at serving temperatures at 170°F. When a combination of foods are to be kept warm (for example a meat with 2 vegetables and rolls) use 170°F.

Keep Warm Recommended Food Settings	
Food Item	Heating Level
Hot Beverages	190°F
Fried Foods	190°F
Vegetables	170°F
Soups (Cream) & Stews	170°F
Sauces & Gravies	170°F
Meats	170°F
Eggs	150°F
Dinner Plates with Food	150°F
Casseroles	150°F
Breads/Pastries	150°F

Slow cook

The slow cook feature is used to cook foods slowly using lower temperatures. The cooking results will be much like that of a slow cooker. This feature is ideal when roasting beef, pork or poultry.

Slow cook may be set with the following options:

- Cook time
- Cook time with end time

The following temperature settings apply to the slow cook feature:

- High: 275°F / 134°C use for cooking 4 to 5 hours
- Low: 225°F / 108°C use for cooking 8 to 9 hours



For best results

- Completely thaw all frozen foods before cooking.
- When using a single oven rack, place in oven rack position 2 or 3.
- Position multiple racks to accommodate size of cooking utensils when cooking multiple food items.
- Add any cream or cheese sauces during the last hour of cooking.
- **Do not frequently open** the oven door or leave the oven door open when checking food items. The more heat that is lost, the longer the food will need to cook.
- Cover foods to keep them moist or use a loose or vented cover to allow foods to turn crisp or brown.
- Roasts may be left uncovered so browning can occur. Cook times will vary depending on the weight, fat content, bone & the shape of the roast.
- Preheating the oven is not necessary.

To set slow cook with low setting:



Example	
Step	Press
1. Position oven racks and cookware in oven. Close the oven door.	
2. Press slow cook key. Hi will appear in the oven display indicating the default setting is for high (<i>Figure 1</i>). If a low setting is needed, press slow cook again to select the Lo setting (<i>Figure 2</i>) and release.	
3. Press START .	



Fig. 1



Fig. 2

To stop **slow cook** at any time press **CANCEL**.

To add or change any cook settings after slow cook has started:

- Press **slow cook** key. To change the setting, press the **slow cook** key again to toggle between the Hi or Lo setting and release. Press **START** to accept change.
- If changing cooking times, select the **cook time** or **end time** keys to make the needed changes.

NOTE

Slow cooking meats may result in the exterior of meats becoming dark; this is normal.





32 Setting Oven Controls

My favorite

The **my favorite** feature may be used to store and recall a favorite recipe setting. This feature will only store or recall one favorite recipe at a time.

My favorite feature may be used with **bake, cook time, conv bake, conv roast** and **keep warm** cooking features. This feature will not work with any other feature including end time, broil or self clean.



To save and store my favorite recipe settings (example shown to bake for 30 minutes with oven temperature of 325°F):

Example	
Step	Press
1. Press cook time .	
2. Enter 3 0 minutes using numeric keypads.	30
3. Press START .	
4. Press bake .	
5. Enter 3 2 5 oven temperature using numeric keypads.	325
6. Press START .	
7. To store, press and hold my favorite keypad for 3 seconds.	

If at this time you do not wish to start the oven with the newly stored recipe, be sure to press **CANCEL**.



To use a saved favorite recipe setting:

Example	
Step	Press
1. Press my favorite key. The favorite icon will appear in the display (Figure 1).	
2. Press START .	

To erase a favorite recipe setting:

Example	
Step	Press
Press my favorite and hold until the favorite icon disappears from the display (Figure 1).	



Fig. 1

NOTES

- If you do not wish the oven to automatically start the recipe when saving **my favorite**, be sure to press **CANCEL** for the last step.
- **my favorite** feature stores or recalls only one recipe at any time.
- If a different favorite recipe is needed, you may record a new recipe over the old. Or, any previously stored recipe may be erased before recording a new recipe by following the steps provided "To erase favorite recipe setting."

Adjusting the oven temperature

Your appliance has been factory calibrated and tested to ensure accurate baking temperatures. For the first few uses, follow your recipe times and temperature recommendations carefully. If you think the oven is cooking **too hot** or **too cool** for your recipe times, the control may be adjusted so the oven cooks hotter or cooler than the temperature displayed.



The oven temperature may be increased +35°F (+19°C) or decreased -35°F (-19°C) from the factory default settings.



For best results

Do not use oven thermometers such as those found in grocery stores to check the temperature settings inside your oven. These oven thermometers could vary as much as 20° to 40° from actual temperatures.

How to offset the oven temperature by +30°F:

Example	
Step	Press
1. Press and hold bake for 6 seconds. Release when acceptance tone sounds. "UPO" should appear in left side of display.	
2. Enter 3 0 using numeric keypad (Figure 1).	30
3. To accept change, press START .	

How to offset the oven temperature by -30°F:



Example	
Step	Press
1. Press and hold bake for 6 seconds. Release when acceptance tone sounds. "UPO" should show in left side of display.	
2. Enter 3 0 using numeric keypad (Figure 1).	30
3. Press bake to toggle to minus (Figure 2).	
4. To accept change, press START .	



Fig. 1



Fig. 2-

NOTE

Oven temperature adjustments made will not affect the broil or self-cleaning feature temperatures.

34 Setting Oven Controls

Sabbath mode

(for use on the Jewish Sabbath & Holidays)



For further assistance, guidelines for proper usage and a complete list of models with the Sabbath feature, please visit the web at <http://www.star-k.org>.

This appliance provides special settings for use when observing the Jewish Sabbath/Holidays. Sabbath mode disables all audible tones or visual display changes on the oven control. **BAKE** and **cooktop** heating are the only cooking features available while in the Sabbath mode.

You must first set the **BAKE** feature and temperature(s) needed for the oven and the **COOK TIME** option (if needed) before setting the Sabbath mode. Any settings made prior to setting the Sabbath mode will be visible in the displays. The **COOK TIME** option, if set prior to the Sabbath mode, will give one audible alert at the end of **COOK TIME**.

The Sabbath mode will override the factory preset 12-hour Energy Saving mode and the appliance will stay on until the cooking features are cancelled. If any of the cooking features are cancelled when the appliance is in the Sabbath mode, no audible or visual indicators will be available to verify the cancellation.

If the oven interior lights are needed, be sure to activate them prior to setting the Sabbath mode. Once the oven light is turned ON and the Sabbath mode is active, the oven light will remain on until the Sabbath mode is turned off and the oven lights are turned off. The oven door will not activate the interior oven lights when the oven door is opened or closed.

It is recommended that any oven temperature modification made within an active Sabbath mode be followed with 2 presses of the **START** key. This will ensure the oven remains ON even if an attempt is made to set the oven temperature outside of its temperature range. If the oven temperature is set outside of the temperature range, the oven will default to the nearest available temperature. Try to set the desired oven temperature again.

To set the oven for the Sabbath feature:

Example	
Step	Press
1. Be sure the clock is set with the correct time of day.	
2. Press bake .	
3. Enter desired temperature.	325
4. Press START .	
5. Enter cook time or end time settings, if needed. If not needed, skip this step and continue to step 6. Refer to the cook time or end time instructions.	
6. To enter Sabbath mode, press and hold both the cook time and end time keys together for 3 seconds. A beep will sound. Release the keys.	+

Once properly set in Sabbath mode, SAb will show in the oven display (*Figure 1*) until the Sabbath mode is cancelled.





Fig. 1

➔ IMPORTANT

Remember the oven will shut-off after completing a **cook time** or **end time** and therefore may only be used once during the Sabbath/Jewish Holidays. The maximum **cooktime** setting is 11 hours and 59 minutes.

Canceling Sabbath mode

To cancel Sabbath mode:

Example	
Step	Press
Press and hold both the cook time and end time keys for 3 seconds. A beep will sound. Release the keys.	 + 

All previously-set features in the oven will automatically cancel once Sabbath mode has ended.

NOTES

- The only keys available once the range is set to Sabbath mode are:

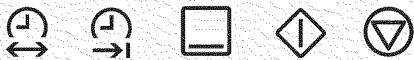

- You may change the oven temperature once baking has started.
 - Press **bake**.
 - Enter the desired temperature.
 - Press **START**.
- Remember that the oven control **will no longer beep or display any further changes** once the oven is set for the Sabbath feature.

WARNING

FOOD POISONING HAZARD. Do not let food sit for more than one hour before or after cooking. Doing so can result in food poisoning or sickness.

What to do after a power failure or power interruption when Sabbath feature is active:

Should a power failure or interruption occur during the Sabbath Holidays, the appliance will SHUT OFF. SF will appear in the control display, indicating a Sabbath mode failure (*Figure 1*). Sabbath failure mode will remain and the oven will not work until Sabbath mode is cancelled (see "To cancel Sabbath mode" section).



Fig. 1

After Sabbath mode is cancelled, Sabbath mode settings may be entered again (See "To set the oven for the Sabbath feature" section).

36 Setting Oven Controls

Restoring control to factory default settings

Your appliance is set with a number of predetermined oven control settings. Over time, you may make changes to the original factory settings.

The following functions or features have user-programmable options or adjustments that may have been changed from the default settings:

- Clock 12-hour or 24-hour display mode.
- 12-Hour Energy Savings or continuous bake mode.
- Tone volume.
- Oven temperature display mode (F° or C°).
- Any oven temperature adjustment made.
- Any saved "my favorite."

▶ IMPORTANT

Before restoring, please be aware that **any previous changes** made to the oven control settings will be erased once the **START** keypad is pressed. This includes any temperature offset made for the oven when baking.

To restore to factory default settings:



Example	
Step	Press
1. Press and hold the number 7 key for 6 seconds. A beep will sound and "rST P S" will appear in the display (<i>Figure 1</i>).	7
2. Press START to accept.	



Fig. 1

Interior oven light

The interior oven light will automatically turn ON when the oven door is opened.

Press  keypad to turn the interior oven light ON and OFF whenever the oven door is closed. The interior light key will not work during a self-clean cycle.

The interior oven light is located at the upper left rear wall of the oven interior and is covered with a glass shield held in place with a wire holder. The glass shield must be in place whenever the oven is in use.

To change the interior oven light, see "Changing the oven light" in the **Care & Cleaning** section.

Before starting self-clean

Adhere to the following precautions before starting a self-clean cycle:

- Remove **all items** from the oven and cooktop, including **food, cookware, utensils, plastic** and **any aluminum foil**. Aluminum foil will not withstand high temperatures generated during the self-clean cycle.
- Remove **all oven racks and accessories** from the oven interior to avoid possible damage. If the oven racks are not removed they may discolor. The Luxury Glide™ oven rack must be removed before starting self-clean to avoid damaging the glide ability of the rack. "Remove racks" will flash in the display for several seconds as reminder to remove the racks before starting a self-clean cycle (Figure 1).



Fig. 1

- Be sure the **oven vent area is clear**.
- Remove **all items** from the storage drawer.
- Be sure the oven light shield is in place. Turn off the oven light.
- **Remove any excess spills or loose debris.** Spills on the oven bottom should be wiped-up and removed **before starting self-clean**. To clean, use hot, soapy water and a cloth. Large food spillovers can cause heavy smoke or a fire during self-clean. Spills that have a high sugar or acid content (such as milk, tomatoes, sauerkraut, fruit juices or pie filling) may leave a dull spot even after self-cleaning.
- **Do not clean the oven door gasket** (Figure 2). Do not use any cleaning materials on the oven door gasket. Doing so may damage the gasket. The woven material of the oven door gasket is essential for a good seal. Care should be taken not to rub, damage or remove the door gasket.
- **Do not** use commercial oven cleaners or protective coatings of any kind inside oven. Residue from oven cleaners may damage the porcelain during the next self-clean cycle.



For best results

Clean any soil from the oven exterior. Clean using soap and water before starting a self-clean cycle. If soils are not removed, they may burn on due to the high temperatures during self-clean.

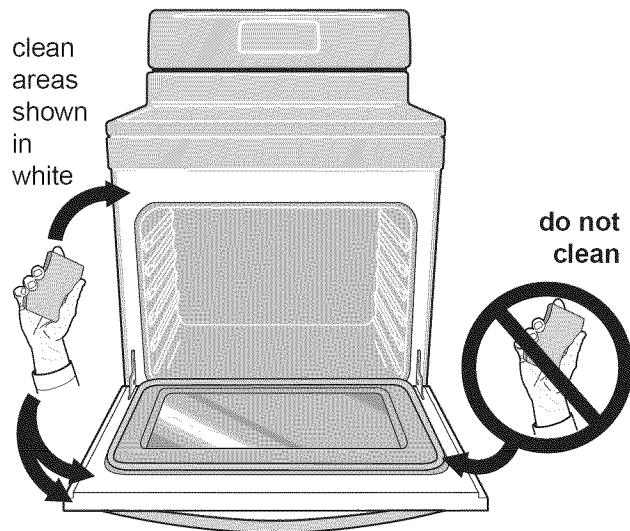

Fig. 2

⚠ WARNING

- **Do not touch** the oven during the self-clean cycle.
- **Keep children away from oven** during the self-clean cycle.
- Failure to follow these instructions can result in burns.

⚠ CAUTION

- The health of some birds is extremely sensitive to the fumes given off during the self-clean cycle of any range. Move birds to another well-ventilated room.
- **DO NOT** line the oven walls, oven racks, oven bottom or any other part of the range with aluminum foil. Doing so will stop heat distribution, produce poor baking results and may cause permanent damage to the oven interior. Aluminum foil will melt to a hot oven surface during self-clean.

Setting self-clean

A self-cleaning oven automatically cleans itself using much higher temperatures than those used for cooking. The self-clean feature eliminates soils completely or reduces them to a fine powdered ash that you can later easily wipe away with a damp cloth.

The self-clean function provides 3 different clean time settings for self-cleaning. Set clean for 2 hours for light, 3 hours for normal or 4 hours for heavier soils.

To start self-clean:

Example	
Step	Press

1. The oven should be empty and **all oven racks** removed. Remove all items from the cooktop. Be sure the oven door is **completely** closed.
2. Press **self clean** once for a 3-hour clean time (*Figure 1*); twice for a 4-hour clean time (*Figure 2*) or 3 times for a 2-hour clean time (*Figure 3*).
3. Press **START**.

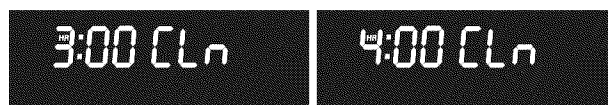

Fig. 1



Fig. 2



Fig. 3

Once active, the door lock motor will begin locking the oven door. "**door Loc**" (*Figure 4*) will appear in the display. **DO NOT** try to open the oven door when the "**door Loc**" message is on (allow about 15 seconds for the oven door to completely lock). **DO NOT** force the oven door open. This could damage the door locking system. Once the oven door is locked the "**door Loc**" message will turn off and "**CLn**" (*Figure 5*) will remain in the display for the entire self-clean cycle.

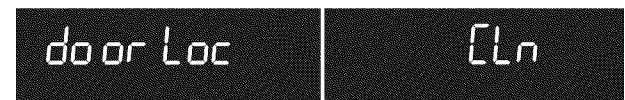

Fig. 4



Fig. 5

When the self clean cycle has finished:

1. The time of day and "**Hot**" will show in the display (*Figure 6*).
2. Once the oven has cooled (about 1 hour) and "**Hot**" is no longer displayed, the "**door OPn**" message will appear (*Figure 7*). When this message turns OFF the door has finished unlocking.



Fig. 6



Fig. 7

3. When the oven is cool, wipe away any residue or powdered ash from the oven interior using a damp cloth or paper towel.

NOTES

- A self-clean cycle will not start if the **control lock** feature is active.
- When the self-clean feature is active, you may check the amount of clean time remaining by pressing the **self-clean** keypad once.
- If a self-clean cycle was started but did not finish due to a power failure, your oven may not have completely cleaned.

Setting self-clean (cont'd)

To cancel self-clean:

1. Press the **cancel**  key.
2. If the self-clean cycle has heated the oven to a high temperature, "**Hot**" (Figure 1) will show in the display. Allow enough time for the oven to cool and for the "**door OPn**" message to display (Figure 2). When this message turns OFF the oven door may be opened.



Fig. 1

Fig. 2

Starting self-clean after cancelling:

If a self-clean cycle was cancelled **using the cancel key** before the oven was finished cleaning, you may wish to set for another self-clean cycle.

If self-clean was cancelled shortly after being started, and the oven interior did not reach high self-clean temperatures, the next clean cycle may be set as soon as the oven door unlocks from the cancelled clean cycle.

If the oven became hot enough from the cancelled self-clean cycle, you may be required to wait up to 4 hours before the control will allow another self-clean cycle to start.

Restarting a self-clean cycle after a power outage:

If the self-clean cycle was interrupted by a power failure, your oven may not be thoroughly cleaned. Another self-clean cycle may be needed. Once power is restored, the oven has cooled and the oven door has unlocked, set to clean for another cycle.

Setting repeated self-clean cycles

If attempting to set repeating self-clean cycles, the control may display the messages "**CLEAn**" then "**dELAY**" followed by the length of time before the next self-clean may be set.





For example, if the message displayed reads "**4:00**", and the time is 12:00 o'clock, the control will not allow self-clean to be set again until after 4:00 o'clock.

Setting delayed self-clean

You may wish to set your appliance to perform a self-clean cycle later (up to 12 hours later). The **end time** key will determine when the cleaning will stop.

You will need to set the **end time** far enough to allow for the type of clean cycle you choose, whether for 2, 3, or 4 hours. Remember to add 30 to 40 additional minutes of cooling time before using the oven for cooking.

Setting for a heavy (4 hour) self-clean cycle to end at 8:00 o'clock:

Example	
Step	Press
1. Be sure the clock is set with the correct time of day. Remove all oven racks. Remove all items from the cooktop. Be sure the oven door is completely closed.	
2. Press end time .	
3. Enter 8 0 0 using the numeric keypad.	800
4. Press START .	
5. Press self clean .	
6. Press self clean again.	
7. Press START .	

Press **CANCEL** at any time to stop self-clean.

CAUTION

To avoid possible burns use caution when opening the oven door after the self-clean cycle is finished. The oven may still be **VERY HOT**. **Stand to the side of the oven** when opening the door to allow hot air or steam to escape.

Cleaning Recommendations

Surface	Type Cleaning Recommendation
<ul style="list-style-type: none"> • Control knobs (some models) • Painted body parts • Painted decorative trim • Aluminum, plastic or vinyl trim 	<p>For general cleaning, use hot, soapy water and a cloth. For more difficult soils and built-up grease, apply a liquid detergent directly onto soil. Leave on soil for 30-60 minutes. Rinse with a damp cloth and dry. Do not use abrasive cleaners these surfaces; they can scratch. To remove control knobs, turn to OFF position; grasp firmly and pull straight off the shaft. To replace knobs after cleaning, line up the flat sides of both knob and shaft; then push knob into place.</p>
<ul style="list-style-type: none"> • Control panel • Control key pad membrane • Decorative trim (some models) 	<p>Before cleaning the control panel, turn all controls off, activate control lock (some models) and if needed remove knobs from panel (some models). Do not use abrasive cleaners on controls or trim; they can scratch. Clean using hot, soapy water and a dishcloth. Be sure to squeeze excess water from dishcloth before wiping control panel; especially when wiping around the controls area. Excess water in or around the controls may cause damage to the appliance. When rinsing, use clean water and a dishcloth and be sure to squeeze excess water from dishcloth before wiping the control panel.</p>
<ul style="list-style-type: none"> • Stainless Steel (some models) 	<p>Clean stainless with warm soapy water using a clean sponge or cloth. Rinse with clean water and dry with soft clean cloth. Do not use harsh scrubbing cleaners. Only use kitchen cleaners especially made for cleaning stainless steel. Always be sure to rinse cleaners from the surface as bluish stains may occur during heating that cannot be removed.</p>
<ul style="list-style-type: none"> • Porcelain enamel parts • Broiler pan and broiler pan insert 	<p>Gentle scrubbing with a soapy no-scratch cleaning pad will remove most spots. Rinse with a 1:1 solution of clear water and ammonia. If necessary, cover difficult spots with an ammonia-soaked paper towel for 30 to 40 mins. Rinse with clean water and a damp cloth, and then scrub with a soap-filled no-scratch cleaning pad. Rinse and wipe dry with a clean cloth. Do not allow food spills with high sugar or acid content (milk, tomatoes, sauerkraut, fruit juices or pie filling) to remain on surfaces; they may cause a dull spot even after cleaning.</p>
<ul style="list-style-type: none"> • Oven interior 	<p>Remove excessive spillovers from oven cavity bottom before starting self-clean. Clean any soils from oven frame and door liner outside the oven door gasket. For important preparation information be sure to read all the instructions in the self-cleaning section.</p>
<ul style="list-style-type: none"> • Oven racks 	<p>Do not clean oven racks in oven during the self-clean cycle. Remove and clean using a mild, abrasive cleaner following manufacturer's instructions. Thoroughly rinse and dry.</p>
<ul style="list-style-type: none"> • Oven door 	<p>Use soap & water to thoroughly clean the top, sides and front of the oven door. Rinse well. You may use a glass cleaner on the outside glass of the oven door. Do not immerse the door in water. Do not spray or allow water or glass cleaner to enter the door vents. To avoid scratches, do not use oven cleaners, cleaning powders or any harsh abrasive cleaning materials on the outside of the oven door. Do not clean the oven door gasket. On self-cleaning models the oven door gasket is made of a woven material which is essential for a good seal. Care should be taken not to rub, damage or remove this gasket.</p>
<ul style="list-style-type: none"> • Burner heads, caps, grates & cooktop 	<p>See "Cleaning cooktop and parts" in the Care and Cleaning section.</p>

Cleaning cooktop and parts

CAUTION

- **Do not** remove any parts from the cooktop until they have completely cooled and are safe to handle. **DO NOT** attempt to clean the cooktop whenever the cooktop or burner heads are still hot.
- To avoid possible burns **DO NOT** attempt to operate the surface burners without the burner caps.
- Any additions, changes or conversions required in order for this appliance to satisfactorily meet the application needs must be made by an authorized qualified Agency.

IMPORTANT

- **Do not** use spray oven cleaners on the cooktop.
- Before placing burner grates onto cooktop, turn grates over to identify rear of grate and place all the grates to the rear of the cooktop.
- For proper gas flow and ignition of the burners, **DO NOT allow spills, food, cleaning agents or any other material to enter the gas orifice opening.**
- **The cooktop is not removable.** Do not attempt to remove or lift the cooktop.
- When placing the burner caps on the cooktop, be sure the **burner caps** are **seated firmly** on top of burner heads. Refer to “Before setting surface burners” in the “Surface Cooking” Section.

The cooktop is designed to make cleaning easier. The gas burners are sealed so cleanup is easy when spillovers are cleaned immediately.

Cooktop

If a spill occurs on the recessed or contoured areas, blot with an absorbent cloth. Rinse with a clean, damp cloth and wipe dry. Do not use harsh abrasive cleaners on the cooktop. They can scratch the porcelain. Completely rinse any cleaners used on the porcelain cooktop may become damaged during future heating.

Burner grates

The burner grates are dishwasher safe and may be cleaned in the dishwasher. Remove any excessive soils before placing in the dishwasher.

Burner caps

To remove the burner caps for cleaning, lift the burner cap off the burner head. Clean heavy soils with an absorbent cloth. Rinse with a clean, damp cloth and thoroughly dry the bottom and inside of the cap. Do not use harsh abrasive cleaners; they can scratch the porcelain on the cap. Do not clean burner caps in dishwasher. Refer to “Before setting surface burners” in the “Surface Cooking” Section.

Burner heads

Lift the burner cap from the burner head. The surface burner heads are secured to the cooktop and must be cleaned in place.

For proper gas flow it may be necessary to clean the burner heads and slots. To clean, first use a clean **DAMP** cloth to soak up any spills. Remove any food from between the burner slots using a small nonabrasive brush like a toothbrush. Afterwards wipe using a damp cloth. For stubborn soils located in the slots, use a small-gauge wire or needle to clean.

Should you experience ignition problems it may be that an ignition port hole is partially blocked with soil. (See *Figure 1*) . With the burner head in place, use a small wire gauge needle or the end of a paper clip to clear the ignition port or ports.

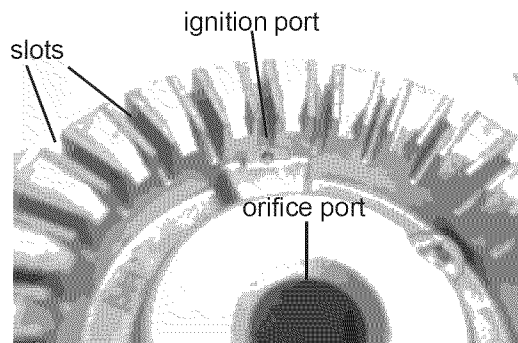

Fig. 1 - Cooktop burner head

Aluminum foil and oven liners

Do not use oven bottom liners or use aluminum foil to cover the oven racks.

CAUTION

Protective liners—Do not use aluminum foil to line the oven bottom, except as suggested in the manual. Improper installation of these liners may result in a risk of electrical shock, or fire.

Using a liner in the oven restricts the heat and air flow needed to obtain the best possible cooking results for any oven.



During self-clean the oven temperature can become hot enough to melt aluminum cooking utensils or aluminum foil if left in the oven. This could result in **permanent damage** to the oven interior and porcelain finish.

Changing the oven light

CAUTION

Be sure the range is unplugged and all parts are COOL before replacing oven light. Wear a leather glove for protection against possible broken glass or burns.

The oven lights are located at the rear of the oven cavity and are covered with a glass shield held by a wire holder (*Figure 1*). The glass shield protects the light bulb and must be in place whenever the oven is in use.

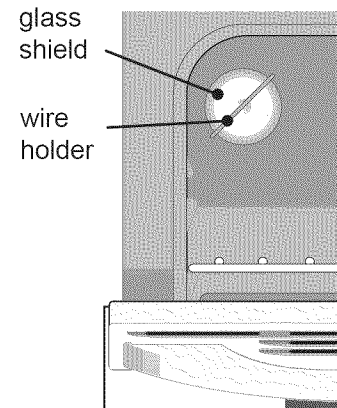

Fig. 1

To replace interior oven light bulb:

1. Turn electrical power off at the main source or unplug the range.
2. Press wire holder to one side to release the glass shield that covers the light bulb.
3. Replace light with a new 40 watt appliance bulb.
4. Replace glass shield over bulb and snap wire holder back into place.
5. Turn power on at main source (or plug the appliance in).
6. The clock will then need to be reset. To reset, see Setting clock in this Use & Care Guide.

Removing the oven door

⚠ CAUTION

To prevent possible burns, do not attempt to remove the oven door until the oven has completely cooled.

➔ IMPORTANT

The oven door is heavy. Be careful when removing and lifting the door. Do not lift the oven door by the handle.

1. Open oven door completely (*Figure 1*).
2. Pull the hinge locks on both left and right hinges down from the oven frame completely towards the oven door (*Figure 2*). A tool such as a small flat-blade screwdriver may be required.
3. Firmly grasp both sides of oven door along the door sides (Do not use the oven door handle).
4. Close the door to the broil stop position. The oven door will stop into this position just before fully closing.
5. With the oven door in the broil stop position (*Figure 3*), lift and carefully pull the oven door away from the oven frame. To avoid finish damage, be careful not to allow the oven door hinges to contact the oven front frame.

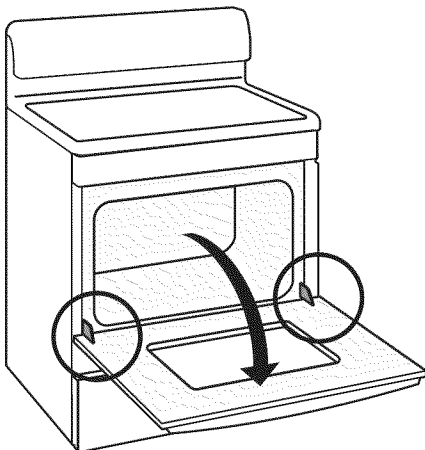

Fig. 1

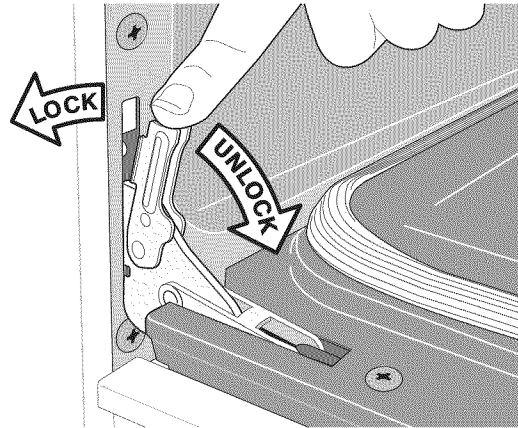

Fig. 2

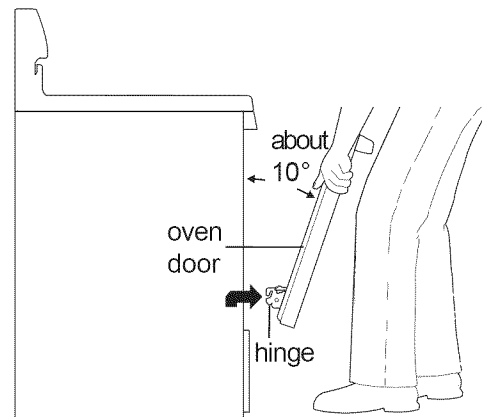

Fig. 3

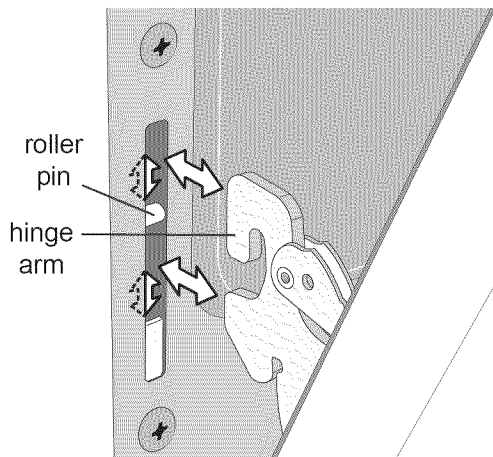

Fig. 4

Replacing the oven door

To replace oven door:

1. Firmly grasp both sides of oven door along the door sides (Do not use the oven door handle).
2. Holding the oven door at the same angle as the removal position (See "Removing the oven door" section), carefully line up and insert both door hinge arms between the pins located on each side of the oven door frame (Figure 1).
3. With both door hinge arms in place, open the oven door (Figure 2).
4. Push the door hinge locks up towards and into the oven frame for both left and right oven door hinges to the locked position (Figure 3).
5. Close the oven door.

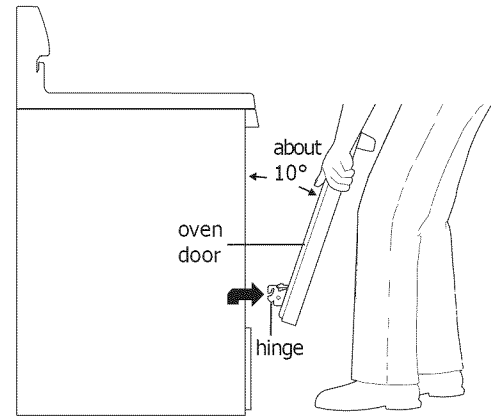

Fig. 1

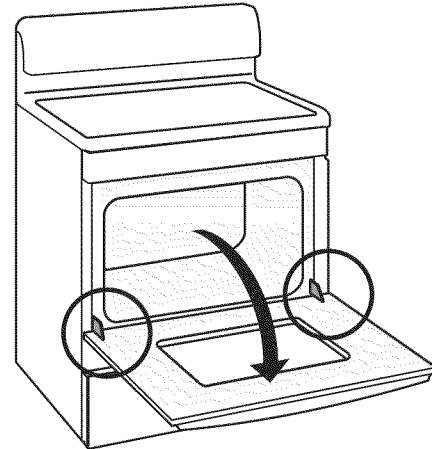

Fig. 2

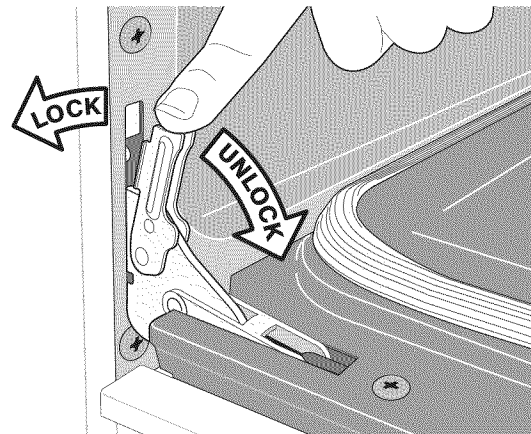

Fig. 3

Special door care instructions

IMPORTANT

Most oven doors contain glass that can break. Read the following recommendations:

- **Do not** close the oven door until all the interior oven racks are fully inserted and retracted to the back of the oven.
- Do not hit the glass with pots, pans, or any other object. The oven door glass may break or even break at a later time unexpectedly.
- Scratching, hitting, jarring or stressing the oven door glass may weaken its structure causing an increased risk of breakage at a later time.
- You may use a glass cleaner on the outside of the oven door glass. **Do not spray** or allow water or the cleaner to enter or drip down into the oven door vents. Spray cleaner on cloth first and then wipe the oven door clean.
- **Do not** use strong oven cleaners, powders or any harsh abrasive cleaning materials on the outside of the oven door or glass.
- **Never clean** the oven door gasket.

Before you call for service, review the following list. It may save you time & expense. The list includes common occurrences that are not the result of defective workmanship or materials in this appliance.

Before you call	
Problem	Solution
Appliance is not level	<ul style="list-style-type: none"> • Be sure floor is level, strong & stable enough to adequately support range. • If floor is sagging or sloping, contact a carpenter to correct the situation. • Poor installation. Place oven rack in center of oven. Place a level on the oven rack. Adjust leveling legs at base of appliance until the oven rack is level. • Kitchen cabinet alignment may make range appear not level. Be sure cabinets are square & have sufficient room for appliance clearance.
Cannot move appliance easily. Appliance must be accessible for service	<ul style="list-style-type: none"> • Cabinets not square or are built in too tightly. Contact builder or installer to make appliance accessible. • Carpet interferes with appliance. Provide sufficient space so appliance can be lifted over carpet.
Entire appliance does not operate	<ul style="list-style-type: none"> • The time of day is not set. The time of day must first be set in order to operate the oven. See "Setting clock" in the Setting Oven Controls section. • Make sure cord/plug is plugged correctly into outlet. • Service wiring is not complete. Contact your dealer, installing agent or authorized service agent. • Electrical power outage. Check house lights to be sure. Call your local electric company for service.
Oven does not operate	<ul style="list-style-type: none"> • Be sure the oven controls are set properly for the desired cooking feature. See Setting Oven Controls in this Use & Care Guide or read the instructions "Entire appliance does not operate" in this checklist.
Oven light does not work	<ul style="list-style-type: none"> • Replace or tighten bulb. See "Changing oven light" section in this Use & Care Guide.
Oven control panel beeps & displays any F code error (for example F10)	<ul style="list-style-type: none"> • Oven control has detected a fault or error condition. Press CANCEL to clear the display & stop beeping. Try the bake or broil feature again. If the F code error repeats, remove power supply to appliance, wait 5 minutes and then repower the appliance and set clock for the time of day. Try the bake or broil feature again. If the fault recurs, record fault and call for service.

Before you call

Problem	Solution
Oven smokes excessively during broiling	<ul style="list-style-type: none">• Control not set properly. Follow broiling instructions under Setting Oven Controls.• Make sure oven door is opened to broil stop position.• Meat too close to the broil element. Reposition the broil rack to provide proper clearance between the meat & the element. Preheat the broil element for searing.• Meat not properly prepared. Remove excess fat from meat. Cut remaining fatty edges to prevent curling, but do not cut into lean.• Insert on broiler pan wrong side up & grease not draining. Always place grid on the broiler pan with ribs up & slots down to allow grease to drip into pan (some models).• Grease has built up on oven surfaces. Regular cleaning is necessary when broiling frequently. Old grease or food spatters cause excessive smoking.
Flames inside oven or smoking from oven vent	<ul style="list-style-type: none">• Excessive spillovers in oven. For example this will happen for pie spillovers or large amounts of grease left on the oven bottom. Wipe up excessive spillovers before starting oven. If flames or excessive smoke are present see "About broiling" in the Setting Oven Controls section.
Poor baking results	<ul style="list-style-type: none">• Many factors affect baking results. Make sure the proper oven rack position is used. Center food in the oven and space pans to allow air to circulate. Allow the oven to preheat to the set temperature before placing food in the oven. Try adjusting the recipe's recommended temperature or baking time. If you feel the oven is too hot or cool, see "Adjusting Oven Temperature" in the Setting Oven Controls section of this Use & Care Guide.

Before you Call

Problem

Solution

Surface burners do not light

- Surface control knob has not been completely turned to  (lite). Push in and turn the surface control knob to lite until burner ignites and then turn control knob to desired flame size.
- Burner ports are clogged. With the burners OFF, use a small-gauge wire or needle to clean ports. See “Cleaning cooktop and parts” in the **Care and Cleaning** section for complete instructions.
- Appliance power cord is disconnected from outlet. Be sure power cord is securely plugged into the electrical outlet.
- Electrical power outage.

Surface burner flame is orange.

- Dust particles in main line. Allow the burner to operate a few minutes until flame turns blue
- In coastal areas, a slightly orange flame is unavoidable due to salt air.

Surface burner flame burns half way around.

- Burner ports are clogged. With the burner OFF, clean ports by using a small-gauge wire or needle.
- Moisture is present after cleaning. Lightly fan the flame and allow burner to operate until flame is full. Dry the burners thoroughly and follow instructions under “Cleaning cooktop and parts” in the **Care and Cleaning** section.

Your appliance is covered by a one year limited warranty. For one year from your original date of purchase, Electrolux will repair or replace any parts of this appliance that prove to be defective in materials or workmanship when such appliance is installed, used, and maintained in accordance with the provided instructions. In addition, the glass cooktop or radiant surface element of your appliance (excluding built-in and free-standing range appliances) is covered by a two through five year limited warranty. During the 2nd through 5th years from your original date of purchase, Electrolux will provide a replacement glass cooktop or radiant surface element for your appliance which has proven to be defective in materials or workmanship when such appliance is installed, used, and maintained in accordance with the provided instructions.

Exclusions

This warranty does not cover the following:

1. Products with original serial numbers that have been removed, altered or cannot be readily determined.
2. Product that has been transferred from its original owner to another party or removed outside the USA or Canada.
3. Rust on the interior or exterior of the unit.
4. Products purchased "as-is" are not covered by this warranty.
5. Products used in a commercial setting.
6. Service calls which do not involve malfunction or defects in materials or workmanship, or for appliances not in ordinary household use or used other than in accordance with the provided instructions.
7. Service calls to correct the installation of your appliance or to instruct you how to use your appliance.
8. Expenses for making the appliance accessible for servicing, such as removal of trim, cupboards, shelves, etc., which are not a part of the appliance when it is shipped from the factory.
9. Service calls to repair or replace appliance light bulbs, air filters, water filters, other consumables, or knobs, handles, or other cosmetic parts.
10. Labor or in-home service costs during the additional limited warranty periods beyond the first year from your original date of purchase.
11. Pickup and delivery costs; your appliance is designed to be repaired in the home.
12. Surcharges including, but not limited to, any after hour, weekend, or holiday service calls, tolls, ferry trip charges, or mileage expense for service calls to remote areas, including the state of Alaska.
13. Damages to the finish of appliance or home incurred during transportation or installation, including but not limited to floors, cabinets, walls, etc.
14. Damages caused by: services performed by unauthorized service companies; use of parts other than genuine Electrolux parts or parts obtained from persons other than authorized service companies; or external causes such as abuse, misuse, inadequate power supply, accidents, fires, or acts of God.

DISCLAIMER OF IMPLIED WARRANTIES; LIMITATION OF REMEDIES

CUSTOMER'S SOLE AND EXCLUSIVE REMEDY UNDER THIS LIMITED WARRANTY SHALL BE REPAIR OR REPLACEMENT AS PROVIDED HEREIN. **CLAIMS BASED ON IMPLIED WARRANTIES, INCLUDING WARRANTIES OF MERCHANTABILITY OR FITNESS FOR A PARTICULAR PURPOSE, ARE LIMITED TO ONE YEAR OR THE SHORTEST PERIOD ALLOWED BY LAW, BUT NOT LESS THAN ONE YEAR.** ELECTROLUX SHALL NOT BE LIABLE FOR CONSEQUENTIAL OR INCIDENTAL DAMAGES SUCH AS PROPERTY DAMAGE AND INCIDENTAL EXPENSES RESULTING FROM ANY BREACH OF THIS WRITTEN LIMITED WARRANTY OR ANY IMPLIED WARRANTY. SOME STATES AND PROVINCES DO NOT ALLOW THE EXCLUSION OR LIMITATION OF INCIDENTAL OR CONSEQUENTIAL DAMAGES, OR LIMITATIONS ON THE DURATION OF IMPLIED WARRANTIES, SO THESE LIMITATIONS OR EXCLUSIONS MAY NOT APPLY TO YOU. THIS WRITTEN WARRANTY GIVES YOU SPECIFIC LEGAL RIGHTS. YOU MAY ALSO HAVE OTHER RIGHTS THAT VARY FROM STATE TO STATE.

If You Need Service

Keep your receipt, delivery slip, or some other appropriate payment record to establish the warranty period should service be required. If service is performed, it is in your best interest to obtain and keep all receipts. Service under this warranty must be obtained by contacting Electrolux at the addresses or phone numbers below.

This warranty only applies in the USA, Puerto Rico and Canada. In the USA and Puerto Rico, your appliance is warranted by Electrolux Major Appliances North America, a division of Electrolux Home Products, Inc. In Canada, your appliance is warranted by Electrolux Canada Corp. Electrolux authorizes no person to change or add to any obligations under this warranty. Obligations for service and parts under this warranty must be performed by Electrolux or an authorized service company. Product features or specifications as described or illustrated are subject to change without notice.

USA

1-877-435-3287

Electrolux Major Appliances North America
10200 David Taylor Drive
Charlotte, NC 28262

Canada

1-800-265-8352

Electrolux Canada Corp.
5855 Terry Fox Way
Mississauga, Ontario, Canada L5V 3E4

www.electrolux-store.com

