

FRIGIDAIRE

All about the

Use & Care

of your

TABLE OF CONTENTS

Important Safety Instructions.....	2-4	Warranty	21
Operating Instructions	5-16	Notes	22
Care and Cleaning	17-18	Français.....	23
Avoid Service	19-20	Español	45

IMPORTANT SAFETY INSTRUCTIONS

WARNING

Please read all instructions before using this washer.

Recognize safety symbols, words and labels

Safety items throughout this manual are labeled with a WARNING or CAUTION based on the risk type as described below:

Definitions

 This is the safety alert symbol. It is used to alert you to potential personal injury hazards. Obey all safety messages that follow this symbol to avoid possible injury or death.

DANGER

DANGER indicates an imminently hazardous situation which, if not avoided, will result in death or serious injury.

WARNING

WARNING indicates a potentially hazardous situation which, if not avoided, could result in death or serious injury.

CAUTION

CAUTION indicates a potentially hazardous situation which, if not avoided, may result in minor or moderate injury.

IMPORTANT

IMPORTANT indicates installation, operation or maintenance information which is important but not hazard-related.

Product Record

Record Your Model and Serial Numbers

The model and serial numbers of your washer are found on the serial plate located at the back of the tub opening under the washer lid. Record and retain these numbers.

Model Number _____

Serial Number _____

Purchase Date _____

Read all instructions before using this appliance. This book contains valuable information about:

- Operation
- Care
- Service

Keep it in a safe place.

This *Use and Care Guide* provides general operating instructions for your washer. It also contains information about features for several other models. Your washer may not have every feature included. Use the washer only as instructed in this *Use & Care Guide*.

NOTE

The instructions appearing in this *Use and Care Guide* are not meant to cover every possible condition and situation that may occur. Common sense and caution must be practiced when installing, operating and maintaining any appliance.

Save these instructions for future reference.

IMPORTANT SAFETY INSTRUCTIONS



WARNING

To reduce the risk of fire, electrical shock, or injury to persons when using this washer, comply with the basic warnings listed below. Failure to comply with these warnings could result in serious personal injuries. You can be killed or seriously injured if you don't follow these Important Safety Instructions:

PREVENT FIRE

- Do not wash items that have been previously cleaned in, soaked in, or spotted with gasoline, cleaning solvents, kerosene, cooking oils, waxes, etc. Do not store these items on or near the washer. These substances give off vapors or chemical reactions that could ignite or explode.
- Do not put oily or greasy rags or clothing on top of the washer. These substances give off vapors that could ignite the materials.
- Do not add gasoline, cleaning solvents, or other flammable or explosive substances to the wash water. These substances give off vapors that could ignite or explode.
- Under certain conditions, hydrogen gas may be produced in a hot water system that has not been used for 2 weeks or more. **HYDROGEN GAS IS EXPLOSIVE.** If the hot water system has not been used for such a period, before using the washer, turn on all hot water faucets and let the water flow from each for several minutes. This will release any accumulated hydrogen gas. Hydrogen gas is flammable; do not smoke or use an open flame during this time.
- Do not store or use gasoline or other flammable vapors or liquids in the vicinity of this or any other appliance.
- Failure to comply with these warnings could result in fire, explosion, serious bodily injury and/or damage to the rubber or plastic parts of the washer.
- Do not continue to use the washer if you hear squeaking, grinding, rubbing or other unusual noises. This could be a sign of mechanical breakdown and lead to fire or serious injury. Contact a qualified technician immediately.

PROTECT CHILDREN

- Do not allow children to play on or in the washer. Close supervision of children is necessary when the washer is used near children. As children grow, teach them the proper, safe use of all appliances.
- Destroy the carton, plastic bag and other packing materials after the washer is unpacked. Children might use them for play. Cartons covered with rugs, bedspreads or plastic sheets can become airtight chambers.
- Keep laundry products out of children's reach. To prevent personal injury, observe all warnings on product labels.
- Before the washer is removed from service or discarded, remove the washer lid to prevent accidental entrapment.
- Failure to comply with these warnings could result in serious personal injuries.

IMPORTANT SAFETY INSTRUCTIONS

PREVENT INJURY

- To prevent shock hazard and assure stability during operation, the washer must be installed and electrically grounded by a qualified service person in accordance with local codes. Installation instructions are packed in the washer for installer's reference. Refer to **INSTALLATION INSTRUCTIONS** for detailed grounding procedures. If the washer is moved to a new location, have it checked and reinstalled by a qualified service person.
- To prevent personal injury or damage to the washer, the electrical power cord of the washer must be plugged into a properly grounded and polarized 3-prong outlet. The third grounding prong must never be removed. Never ground the washer to a gas pipe. Do not use an extension cord or an adaptor plug.
- Follow package directions when using laundry products. Incorrect usage can produce poisonous gas - resulting in serious injury or death.
- Do not combine laundry products for use in same load unless specified on the label.
- Do not mix chlorine bleach with ammonia or acids such as vinegar.



WARNING

FIRE/ELECTRICAL SHOCK HAZARD

Avoid fire hazard or electrical shock. Do not use an adaptor plug or extension cord or remove grounding prong from electrical power cord. Failure to follow this warning can cause serious injury, fire or death.

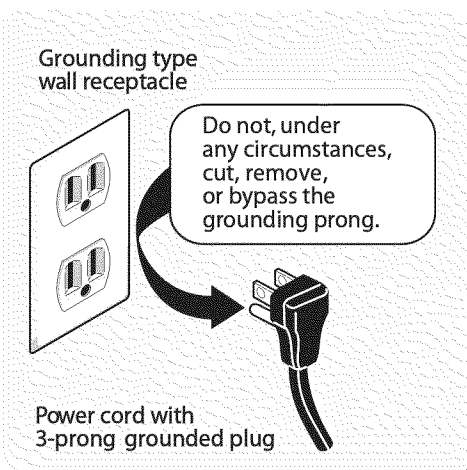

PREVENT INJURY AND DAMAGE TO THE APPLIANCE

To prevent serious personal injury and damage to the washer:

- All repairs and servicing must be performed by an authorized servicer unless specifically recommended in this *Use & Care Guide*. Use only authorized factory parts.
- Do not tamper with controls.
- Do not install or store the washer where it will be exposed to the weather.
- Do not install on carpet. Install washer on a solid floor. It may be necessary to reinforce the floor to prevent vibration or movement.
- Do not sit on, step on or stand on the washer. Do not rest heavy loads on top. The washer is not meant to support weight.
- To reduce the risk of electric shock, disconnect this appliance from the power supply before attempting any user maintenance. Canceling a cycle or turning the power off at the console does not disconnect this appliance from the power supply.
- To prevent injury, do not reach into the washer while parts are moving. Before loading, unloading or adding items, push in the cycle selector knob to stop the cycle. Allow the wash tub to coast to a complete stop before reaching inside.
- This washer is equipped with an electrical overload protector. The washer motor will stop if it becomes overheated.
- Failure to comply with these warnings could result in serious personal injuries.



WARNING

HARMFUL VAPOR HAZARD

Do not use or mix liquid chlorine bleach with other household chemicals such as toilet cleaners, rust removers, acid or products containing ammonia. These mixtures can produce dangerous fumes which can cause serious injury or death.



Washing Procedures

WARNING

To reduce the risk of fire, electric shock or injury to persons, read these **IMPORTANT SAFETY INSTRUCTIONS** in this **Use and Care Guide** before operating your washer.

1 Sort laundry into loads that can be washed together.

- Sort items by recommended cycle and water temperature.
- Separate white, light and colorfast items from dark and non-colorfast items.
- Separate items that shed lint from items that attract lint. Casual, synthetic, knit, and corduroy items will pick up lint from towels, rugs, and bedspreads.
- Separate heavily soiled items from lightly soiled items.
- Separate lacy, sheer, loosely knit, or delicate items from durable items.
- Do not machine wash items containing fiberglass. Small particles of fiberglass left in the drum may transfer to fabrics in other loads and cause skin irritation and/or damage to fabrics.

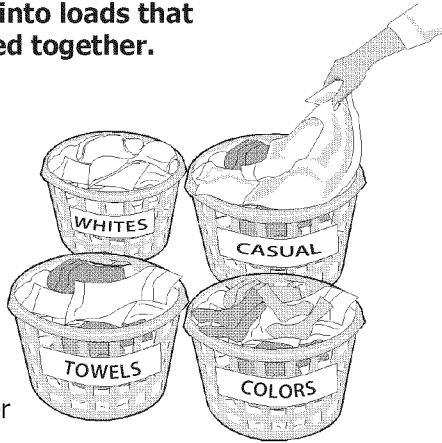

2 Prepare items for washing.

- Empty pockets.

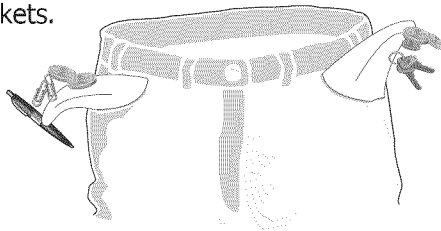

- Brush off lint and dirt. Shake out rugs and beach towels.
- Close zippers, fasten hooks, button buttons, tie strings and sashes, and remove non-washable trims and ornaments.
- Mend rips and tears to prevent further damage during washing.
- Turn knit items inside out to prevent pilling.

- Place delicate and small items such as bras, hosiery and baby socks in a mesh bag.

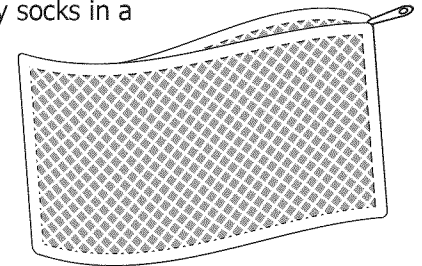

(Mesh bag not included.)

3 Pretreat stains and heavy soil.

- See **Stain Removal Guide** in this guide for safe, successful stain removal instructions.

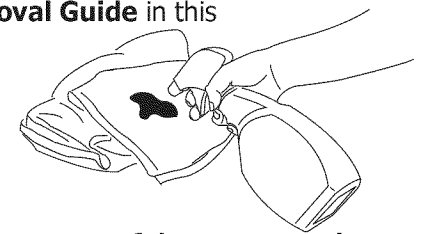

4 Add a measured amount of detergent to the wash tub before adding the laundry load.



For best results

Use a low-sudsing, high efficiency detergent to prevent oversudsing. Look for this symbol on the detergent label: 

- Follow detergent manufacturer's directions. The amount required depends on type of detergent, load size and soil level, and water hardness.

5 If desired, add liquid bleach to bleach dispenser.

- Before adding the wash load, add liquid bleach to bleach dispenser located in left front corner under the lid:

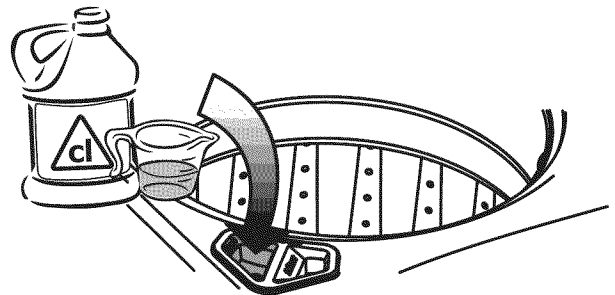

- Refer to bleach manufacturer's directions for quantity to add.
- Then add 1 cup (240 ml) water to flush the dispenser.
- Do not use powdered bleach in the bleach dispenser. Add powdered bleach to the empty tub.

OPERATING INSTRUCTIONS

Washing Procedures, continued

6 Add laundry load to washer.

- For best washing performance, dry load level should not be higher than the upper row of holes in the wash tub. Do not overload the washer.

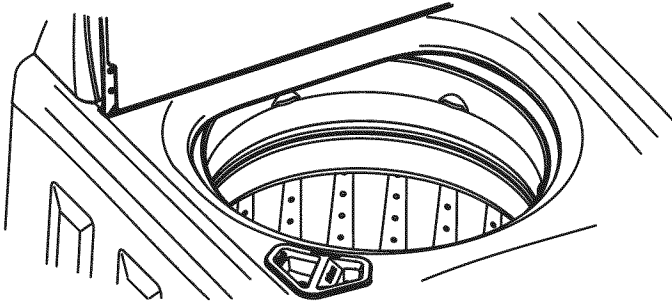

- Combine large and small items in a load. Load large items first. Large items should not be more than half the total wash load.
- When washing a single heavy item, add 1 or 2 towels to balance the load.

7 If desired, add liquid fabric softener to fabric softener dispenser.

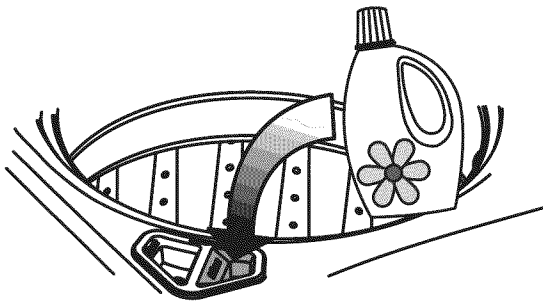

- Add liquid softener to the dispenser, following fabric softener label directions. DO NOT use granular detergent in this dispenser.
- DO NOT fill above the maximum fill line.
- Turn fabric softener option on.
- Do not use bleach in this dispenser.

NOTE

To prevent staining, do not overfill the "FABRIC SOFTENER" chamber or pour liquid fabric softener directly on the wash load.

Other Wash Products

- Water conditioner, detergent booster and enzyme products may be added with the detergent.

IMPORTANT

Use of multi-product (detergent plus softener) sheets or color-absorbing sheets **NOT** recommended. They could disable your machine and result in unwarranted repair costs.

8 Select the appropriate cycle and settings for the load.

- Turn the cycle selector knob in either direction to select the cycle desired.
- The estimated cycle time will be displayed.
- A suitable water temperature, soil level, spin speed and options will automatically be indicated for the cycle selected. See the "Washer Settings Chart" for more details.
- To change the water temperature, soil level, spin speed and water level, press the **temp**, **soil**, **spin speed** or **water level** buttons to scroll to the desired settings.
- To select or delete an option, press **options**; then, while the indicator is blinking, press **select**. The indicator will light when the option has been selected. It will no longer be lighted when the option has been deleted.

NOTE

If a setting is not available for the cycle selected, the indicator will not light.

Washing Procedures, continued

- Adjustments made to a cycle will be remembered and recalled each time that cycle is selected in the future.

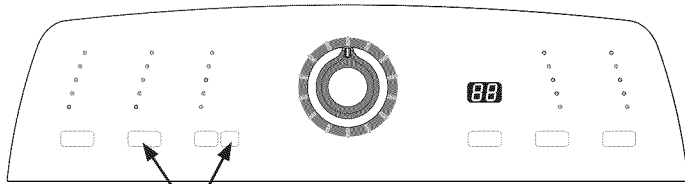

To return to factory settings, press these two buttons at the same time and hold until the signal sounds.

9 Start the cycle.

- Close the washer lid. The washer will not operate with the lid open.
- Push in or turn the cycle selector knob or turn any option knob to "wake" the washer. You will hear three beeps to indicate washer is ready to operate.
- After making your selections, push in the selector knob to start the cycle. You will hear one beep and the washer lid will lock.
- Select **delay start** to delay the beginning of the cycle, if desired.
- To add a forgotten item to the wash tub, push in the cycle selector knob to pause the cycle. You will hear two beeps. After the lock releases, lift the lid and add the item. Close the lid and push in the selector knob again, continuing the current cycle.
- To cancel a running cycle, push in and hold the cycle selector until the washer discontinues running.
- A signal will sound at the end of the cycle if the chime option has been selected.

10 Remove items when the cycle is completed.

- For your safety, the lid is locked during the operation of the washer. It will unlock at the cycle end after the tub has come to a complete stop.

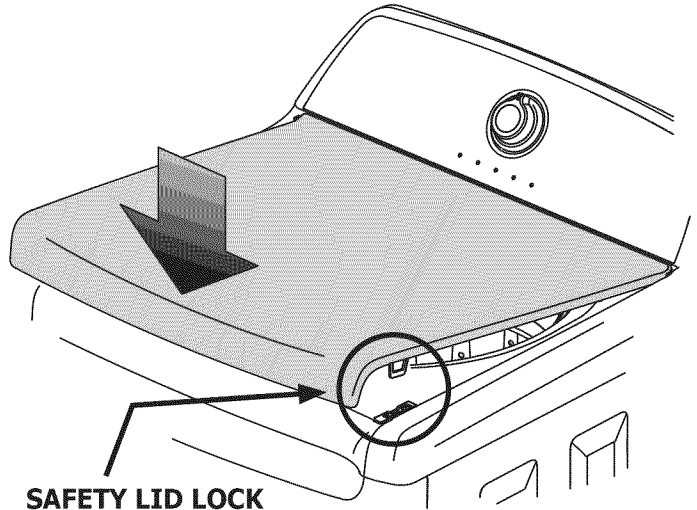

SAFETY LID LOCK

- To open the lid during cycle operation, push in the cycle selector knob to pause the cycle. You will hear two beeps. Wait for the lid lock to release. **Do not force open the locked lid.**

CAUTION

To avoid serious personal injury, do not operate washer if safety lid lock is missing, damaged or operating improperly.

- Place washed items in automatic dryer, line dry, or dry flat as directed by fabric care label. Excess wrinkling, color transfer or odors may develop in items left in the washer after the cycle has ended.



For best results

Follow the fabric care label instructions on items to be washed.

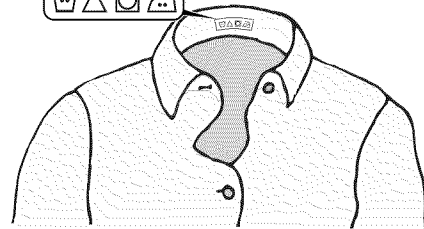

OPERATING INSTRUCTIONS

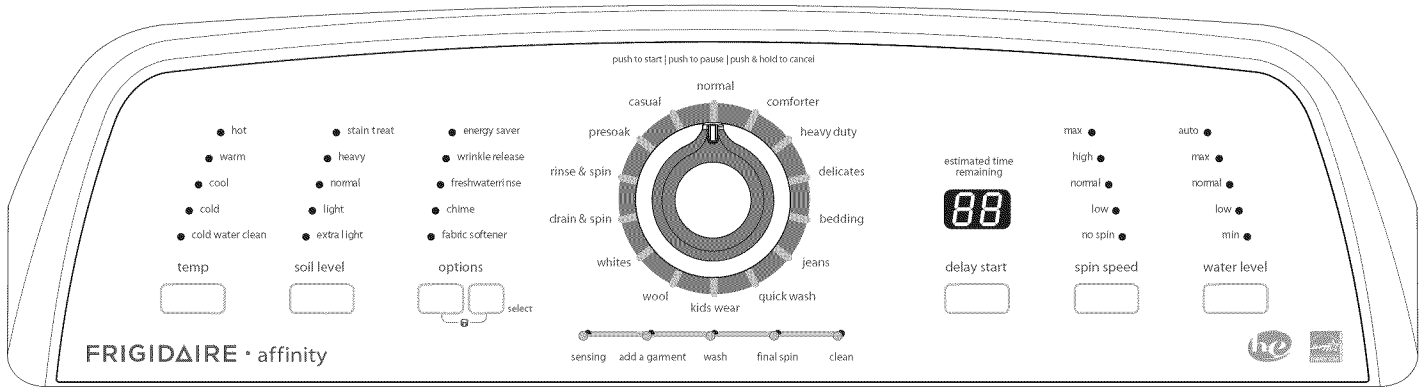

This manual covers many models and not all cycles, options, or features listed are available on every model. Consoles shown above for reference only. Your model may differ.

Cycle Selection

Turn the cycle selector in either direction to the cycle desired.



Once a cycle is running, turning the selector knob to another selection will not change the cycle. If cycle selection change is attempted after the cycle starts, the indicator lights will flash and a signal will beep, but the original cycle will continue.

NOTE

To change the cycle selection once the cycle has begun, push in and hold the cycle selector knob to cancel the current cycle, make the new selection and push in the selector knob again to restart the washer.

normal

Use this load for light to normally soiled cottons, towels, shirts, denims and mixed loads.

comforter

Add one large comforter or two light-duty sleeping bags to the **comforter** cycle. Press the item(s) to the bottom of the tub as much as possible to prevent them from floating as the tub fills with water.

heavy duty

Use this cycle for heavily soiled, durable garments - ex. towels, sports gear, or fabric tote bags. For best soil and stain removal, use the hottest water safe for the fabrics being washed.

delicates

Use this cycle for lightly soiled knits and delicates which require gentle washing.

bedding

This cycle is designed for large items such as blankets, sheets, mattress pads, duvet covers and similar items.

jeans

Select this specialty cycle for washing an entire load of lightly to normally soiled denim jeans or similarly-colored cotton khakis.

Cycle Selection, continued

quick wash

Quickly wash a small, lightly soiled.

kids wear

Wash normally-soiled kids wear and baby wear with this specialty cycle.

wool

Designed for a small load of machine-washable woolen items, the **wool** cycle uses gentle washing action along with cold rinses to eliminate shrinking and damage to wool. You may use an  wool detergent approved for automatic washers.

whites

Use this cycle for white fabrics and lightly colored clothing. Refer to fabric care label for use of liquid chlorine bleach. Hot water is recommended to ensure optimal bleach activation. For peak rinsing performance and to avoid chlorine residues on your laundry add **fresh rinse** to this cycle.

drain & spin

Use the **drain & spin** cycle anytime you want to drain water from the washer and spin out the load.

rinse & spin

Select **rinse & spin** for loads that need a cold water rinse or to add fabric softener that may have been omitted in a regular cycle.

presoak

Use this cycle to soak heavily soiled and stained items before washing. Any temperature except hot may be selected, but cold water is recommended with this cycle as warmer water may set some stains. Use the amount of detergent recommended for a normal wash cycle. If desired, use a bleach or a soaking agent safe for the fabric. The washer will drain at the end of the cycle.

NOTE

Follow **presoak** with a complete wash cycle suitable for the load using a half dose of detergent.

casual

Use this cycle for poly blends with a permanent press or no-iron finish.

Cycle Settings



For best results

Follow the fabric care label instructions on items to be washed.

Appropriate wash water temperature, soil level, spin speed, water level and options will automatically be displayed for each cycle. The settings can be modified before the cycle is started. Make modifications according to fiber content, colorfastness and soil level. Modifications for each cycle will be remembered and recalled each time that cycle is selected in the future.

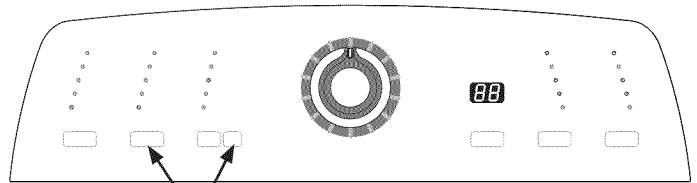

To return to factory settings, press these two buttons at the same time and hold until the signal sounds.

If changes are attempted after the cycle starts, the lights will flash and a signal will beep, but the cycle will continue.

NOTE

To change the settings once the cycle has begun, push in the cycle selector knob to pause the cycle, make the new selections and push in the selector knob again to restart the washer.

OPERATING INSTRUCTIONS

Cycle Settings, continued

Wash Water Temperature

To change the preset temperature, press the **temp** button to scroll to the desired setting. To protect your fabrics, the temperature range from low to high settings may be different depending on cycle selected.

The water heater setting and its distance from the washer, water usage in other parts of the home, and seasonally low ground water temperature in some geographic areas can affect water temperature.

hot

Use this setting for heavily soiled white or colorfast cottons and blends.

warm

Use this setting for normally soiled white or colorfast cottons or blends.

cool

Use this setting for normally soiled sheets, casual items and washable woolens.

cold

Some warm water will automatically blend with cold tap supply to achieve **cold**. Use this setting for lightly soiled non-colorfast items, knits, delicates, and hand washables.

cold water clean

Wash and rinse temperatures are equivalent to temperature of cold tap supply. Use this selection for fabrics and colors that are prone to dye transfer. For use with cold water  detergents.

Soil Level

Adjust duration of agitation time based on the soil level of each load. **Heavy, normal, light, extra light** soil levels are available. **Stain treat** gives your cycle the agitation time of a **heavy** selection plus the added benefit of a mid agitation soak.

Spin Speed

Max, high, normal and **low** spin speeds are available for most cycles. The spin speed and/or duration of final spin may vary from model to model and cycle to cycle.

Increasing the spin speed will extract more water, decrease drying time and conserve energy. Decreasing the spin speed will reduce wrinkling.

Select **low** spin speed to gently spin items that should be line dried.

Use **no spin** to omit the final spin at the end of the cycle. The load will be very wet. Remove items from the wash drum to drip dry or select a **drain & spin** or **rinse & spin** cycle to remove excess water at a more convenient time.

Water Level

Press the **water level** button to select a water level appropriate for the load size. For best results, DO NOT overload. Add items loosely to the tub. The dry load should not be higher than the top row of holes in the wash tub. There should be enough water in the tub for items to move freely.

NOTE

Water level is automatically calculated by the washer in the **auto** setting. The washer will perform a dry load sensing procedure before adding water to the tub. The **sensing** indicator light will be lit.



Cycle Options

To select an option, press **options** until the indicator for the desired option flashes, then press **select**. If an option is not available for a cycle, the indicator will not light. Follow the same steps to delete an option.

Occasionally, a setting and option in the same cycle will conflict with each other, like **energy saver** and **fresh water rinse**. When this happens, the option selected first will cause the conflicting option to not be selectable.

energy saver

The **energy saver** option reduces water temperature to save energy, lowers water usage slightly and also extracts more water to reduce drying time.

wrinkle release

Wrinkle release adds a deep rinse with warm water to relax existing wrinkles and then lowers the speed of the final spin to prevent setting new ones.

freshwater rinse

Use this option when additional rinsing is desired to remove excess dirt and detergent. It is recommended for heavily soiled loads or if household members have sensitive skin.

chime

A signal will sound at the end of the cycle if this option is selected.

fabric softener

You must turn the fabric softener switch to the "on" position for correct operation of the fabric softener dispenser. See *Care and Cleaning* for dispenser cleaning procedures.

delay start

Press **delay start** to select a wash time convenient to your schedule or during off peak energy hours. The delay time selected will be displayed and begin counting down when you push in the cycle selector knob to start the unit.

NOTE

To change options once the cycle has begun, push in the cycle selector knob to pause the cycle, make the new selections and push in the selector knob again to restart the washer.

- energy saver
- wrinkle release
- freshwater rinse
- chime
- fabric softener

options



estimated time remaining



delay start



OPERATING INSTRUCTIONS

Other Features

Control Lock

To avoid having someone accidentally start or stop the washer, press **options** and **select** at the same time and hold for 10 seconds. If you attempt to activate the washer while it is locked, the display will flash and error beeps will sound. To remove the control lock, press **options** and **select** again.

Estimated Time Remaining

The estimated cycle duration will be displayed before you start the cycle and time remaining will be displayed after you start the cycle. Out-of-balance situations during spins may occasionally lengthen actual cycle times.

Load Size Sensing

Water level is automatically calculated by the washer in the auto setting. The washer will perform a dry load sensing procedure to determine load size before adding water to the tub. If your model has status lights, the sensing indicator will be lit.

Status Lights

The following indicators may be lighted during the cycle:

- sensing
- add a garment
- wash
- final spin
- clean

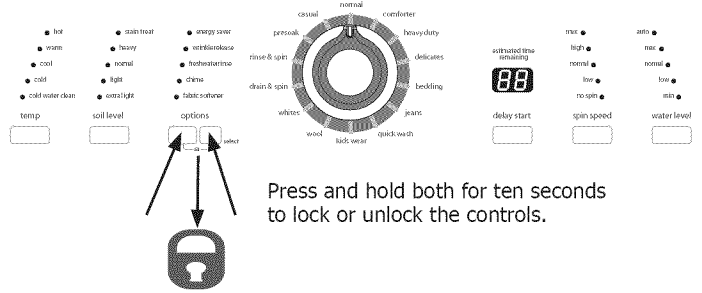

Press and hold both for ten seconds to lock or unlock the controls.

estimated time remaining

45





OPERATING INSTRUCTIONS

Washer Settings Chart

These Temperatures, Soil levels, Spin Speeds, Water levels and Options are available with the following cycles:

	casual	normal	comforter	heavy duty	delicates	bedding	jeans	quick wash	kids wear	wool	whites	drain & spin	rinse & spin	presoak	
temp¹															
hot		✓	✓	✓		✓	✓		✓		✓				
warm	✓	✓	✓	✓	✓	✓	✓	✓	✓	✓	✓			✓	
cool	✓	✓	✓	✓	✓	✓	✓	✓	✓	✓	✓			✓	
cold	✓	✓	✓	✓	✓	✓	✓	✓	✓	✓	✓			✓	
cold water clean	✓	✓	✓	✓	✓	✓	✓	✓	✓	✓	✓		✓	✓	
soil level															
stain treat		✓	✓	✓		✓	✓		✓		✓				
heavy	✓	✓	✓	✓		✓	✓		✓	✓	✓				
normal	✓	✓	✓	✓	✓	✓	✓		✓	✓	✓				
light	✓	✓			✓	✓	✓	✓	✓	✓	✓				
extra light	✓	✓			✓		✓	✓	✓	✓	✓				
spin speed															
max		✓	✓	✓		✓		✓			✓	✓	✓		
high	✓	✓	✓	✓		✓	✓	✓	✓		✓	✓	✓		
normal	✓	✓	✓	✓	✓	✓	✓		✓		✓	✓	✓		
low	✓	✓			✓		✓		✓	✓	✓	✓	✓		
no spin	✓	✓			✓					✓		✓	✓	✓	
water level															
auto	✓	✓	✓	✓	✓	✓	✓	✓	✓	✓	✓		✓	✓	
max	✓	✓	✓	✓	✓	✓	✓	✓	✓	✓	✓		✓	✓	
normal	✓	✓	✓	✓	✓	✓	✓	✓	✓	✓	✓		✓	✓	
low	✓	✓	✓	✓	✓	✓	✓	✓	✓	✓	✓		✓	✓	
min	✓	✓	✓	✓	✓	✓	✓	✓	✓	✓	✓		✓	✓	
options															
energy saver	✓	✓	✓			✓	✓				✓				
wrinkle release	✓	✓	✓	✓	✓	✓	✓	✓	✓	✓	✓				
freshwater rinse	✓	✓	✓	✓	✓	✓	✓	✓	✓	✓	✓				
chime	✓	✓	✓	✓	✓	✓	✓	✓	✓	✓	✓	✓	✓	✓	
fabric softener	✓	✓	✓	✓	✓	✓	✓	✓	✓	✓	✓		✓		
delay start	✓	✓	✓	✓	✓	✓	✓	✓	✓	✓	✓	✓	✓	✓	

✓ = Available selections.  = Cycle defaults.  = Non-modifiable presets.

OPERATING INSTRUCTIONS

Safe Stain Removal Procedures

To reduce the risk of fire or serious injury to persons or property, comply with the basic warnings listed below:

- Read and comply with all instructions on stain removal products.
- Keep stain removal products in their original labeled containers and out of children's reach.
- Thoroughly wash any utensils used.
- Do not combine stain removal products, especially ammonia and chlorine bleach. Dangerous fumes can result.
- Never wash items which have been previously cleaned in, washed in, soaked in or spotted with gasoline, dry cleaning solvents or other flammable or explosive substances because they give off vapors that could ignite or explode.
- Never use highly flammable solvents, such as gasoline, inside the home. Vapors can explode on contact with flames or sparks.

For Successful Stain Removal:

- Remove stains promptly.
- Determine the kind of stain, then follow the recommended treatment in the stain removal chart on the next page.
- To pretreat stains, use a prewash product, liquid detergent, or a paste made from powder detergent and water.
- Use cold water on unknown stains as hot water can set stains.
- Consult care label instructions for treatments to avoid on specific fabrics.
- Check for colorfastness by testing stain remover products on an inside seam.
- Rinse and wash items after stain removal.

WARNING

HARMFUL VAPOR HAZARD

Do not use or mix liquid chlorine bleach with other household chemicals such as toilet cleaners, rust removers, acid or products containing ammonia. These mixtures can produce dangerous fumes which can cause serious injury or death.



Stain Removal Suggestions

STAIN	TREATMENT
Adhesive tape, chewing gum, rubber cement	Apply ice. Scrape off excess. Place stain face down on paper towels. Saturate with pre-wash stain remover or nonflammable dry cleaning fluid.
Baby formula, dairy products, egg	Use product containing enzymes to pretreat or soak stains. Soak for 30 minutes or more. Wash.
Beverages (coffee, tea, soda, juice, alcoholic beverages)	Pretreat stain. Wash using cold water and bleach safe for fabric.
Blood	Rinse with cold water. Rub with bar soap. Or, pretreat or soak with product containing enzymes. Wash using bleach safe for fabric.
Candle wax, crayon	Scrape off surface wax. Place stain face down between paper towels. Press with warm iron until wax is absorbed. Replace paper towels frequently. Treat remaining stain with prewash stain remover or nonflammable dry cleaning fluid. Hand wash to remove solvent. Wash using bleach safe for fabric.
Chocolate	Pretreat or soak in warm water using product containing enzymes. Wash using bleach safe for fabric.
Collar or cuff soil, cosmetics	Pretreat with prewash stain remover or rub with bar soap.
Dye transfer on white fabric	Use packaged color remover. Wash using bleach safe for fabric.
Grass	Pretreat or soak in warm water using product containing enzymes. Wash using bleach safe for fabric.
Grease, oil, tar (butter, fats, salad dressing, cooking oils, car grease, motor oils)	Scrape residue from fabric. Pretreat. Wash using hottest water safe for fabric. For heavy stains and tar, apply nonflammable dry cleaning fluid to back of stain. Replace towels under stain frequently. Rinse thoroughly. Wash using hottest water safe for fabric.
Ink	Some inks may be impossible to remove. Washing may set some inks. Use prewash stain remover, denatured alcohol or nonflammable dry cleaning fluid.
Mildew, scorch	Wash with chlorine bleach if safe for fabric. Or, soak in oxygen bleach and hot water before washing. Badly mildewed fabrics may be permanently damaged.
Mud	Brush off dry mud. Pretreat or soak with product containing enzymes.
Mustard, tomato	Pretreat with prewash stain remover. Wash using bleach safe for fabric.
Nail polish	May be impossible to remove. Place stain face down on paper towels. Apply nail polish remover to back of stain. Repeat, replacing paper towels frequently. Do not use on acetate fabrics.
Paint, varnish	WATER BASED: Rinse fabric in cool water while stain is wet. Wash. Once paint is dry, it cannot be removed. OIL BASED AND VARNISH: Use solvent recommended on can label. Rinse thoroughly before washing.
Perspiration	Use prewash stain remover or rub with bar soap. Rinse. Wash using nonchlorine bleach in hottest water safe for fabric.
Rust, brown or yellow discoloration	Use rust remover safe for fabric. Do not use chlorine bleach because it may intensify discoloration.
Shoe polish	LIQUID: Pretreat with a paste of powder detergent and water. PASTE: Scrape residue from fabric. Pretreat with prewash stain remover or nonflammable dry cleaning fluid. Rinse. Rub detergent into dampened area. Wash using bleach safe for fabric.
Tomato	Pretreat with prewash stain remover. Wash using bleach safe for fabric.
Urine, vomit, mucus, feces	Pretreat or soak in product containing enzymes. Wash using bleach safe for fabric.
Wine	Pretreat or soak in cold water. Wash in hottest water and bleach safe for fabric

OPERATING INSTRUCTIONS

Common Washing Problems

Many washing problems involve poor soil and stain removal, residues of lint and scum, and fabric damage. For satisfactory washing results, follow these suggestions provided by The Soap and Detergent Association.

PROBLEM	POSSIBLE CAUSES	SOLUTIONS	PREVENTIVE MEASURES
Blue stains	<ul style="list-style-type: none"> Undiluted liquid detergent or fabric softener dispensed directly onto fabric. 	<ul style="list-style-type: none"> If caused by detergent, mix 1 cup (240 ml) white vinegar with 1 quart (.95 L) water in a plastic container. Soak item 1 hour. Rinse. If caused by fabric softener, rub stains with bar soap. Wash. 	<ul style="list-style-type: none"> Add detergent to empty tub. Do not pour on dry load. Avoid overfilling fabric softener compartment of dispenser.
Discoloration, graying	<ul style="list-style-type: none"> Not enough detergent. Wash water temperature too low. Incorrect sorting. 	<ul style="list-style-type: none"> Rewash with correct amount of detergent and hottest water safe for fabric. Add bleach safe for fabric. 	<ul style="list-style-type: none"> Sort items by soil level and color. Use correct amount of detergent, hottest water and bleach safe for fabric.
Greasy, oily stains	<ul style="list-style-type: none"> Not enough detergent. Undiluted liquid fabric softener poured directly on fabric. 	<ul style="list-style-type: none"> Treat with prewash stain remover or liquid detergent. Increase detergent and water temperature. Rewash. Rub fabric softener stains with bar soap. 	<ul style="list-style-type: none"> Use correct amount of detergent and hottest water safe for fabric. Do not pour liquid fabric softener directly on fabric. See Operating Your, step 5.
Holes, tears, or snags	<ul style="list-style-type: none"> Incorrect use of chlorine bleach. Unfastened zippers, hooks, buckles. Rips, tears and broken threads. Overloading the washer. Degradation of fabric. 	<ul style="list-style-type: none"> May be irreversible if rips, tears and seams cannot be mended. 	<ul style="list-style-type: none"> Never pour chlorine bleach directly on fabric. Check condition of items before washing. See Operating Your, steps 2 and 5.
Lint	<ul style="list-style-type: none"> Incorrect sorting. Tissues left in pocket. Overloading the washer. Not enough detergent. Undissolved detergent has left a residue resembling lint. Static cling is attracting lint. Load washed too long. 	<ul style="list-style-type: none"> Reduce load size. Rewash using correct water temperature, water level, and amount of detergent. Add nonprecipitating water conditioner to wash water to remove detergent residue. Add liquid fabric softener to final rinse. Dry load in dryer. Remove lint with lint brush or roller. 	<ul style="list-style-type: none"> See Washing Procedures, steps 1 and 2. Do not overload washer. Use correct temperature and amount of detergent, water and wash time.
Pilling (Fibers ball up and cling to fabric.)	<ul style="list-style-type: none"> Pilling is normal with synthetic and permanent press fabrics. This is due to abrasion from normal wear. 	<ul style="list-style-type: none"> Use a lint brush or shaver to remove pills. 	<ul style="list-style-type: none"> Use fabric softener in the washer to lubricate fibers. When ironing, use spray starch or fabric finish on collars and cuffs. Turn items inside out to reduce abrasion.
Residue or powder on dark items; Stiff, harsh fabrics.	<ul style="list-style-type: none"> Undissolved detergent. Some granular detergents can combine with hard water minerals to form a residue. Overloading the washer. 	<ul style="list-style-type: none"> Rewash load. 	<ul style="list-style-type: none"> Increase water temperature using hottest water safe for fabric. Do not overload washer. Use liquid detergent or use nonprecipitating water conditioner with powder detergent.
Wrinkling	<ul style="list-style-type: none"> Overloading the washer. Incorrect wash cycle for wash load. 	<ul style="list-style-type: none"> Reduce load size. Rinse in cold water with liquid fabric softener using the casual or delicate cycle. 	<ul style="list-style-type: none"> Do not overload washer. Remove items from washer as soon as cycle is completed. Use liquid fabric softener.
Yellow buildup of body soil on synthetic fabrics	<ul style="list-style-type: none"> Agitation time too short. Wash water temperature too low. Not enough detergent. 	<ul style="list-style-type: none"> Soak in detergent booster or product containing enzymes. Wash in hottest water safe for fabric using casual cycle. Increase detergent. Add bleach safe for fabric or treat with color remover. 	<ul style="list-style-type: none"> Select correct wash cycle. Use correct amount of detergent. Wash synthetics frequently using hot or warm water.
Yellow or brown rust stains	<ul style="list-style-type: none"> Iron or manganese in water supply, water pipes, or water heater. 	<ul style="list-style-type: none"> To restore discolored load of whites, use rust remover safe for fabric. Do not use chlorine bleach to remove rust stains. It may intensify discoloration. 	<ul style="list-style-type: none"> Use nonprecipitating water softener. Before washing, run hot water for a few minutes to clear lines. Drain water heater occasionally. For an ongoing problem, install an iron filter in your water supply system.

Cleaning Instructions

NOTE

Fabric softener may build up in the dispenser well. Residue should be removed once or twice a month.

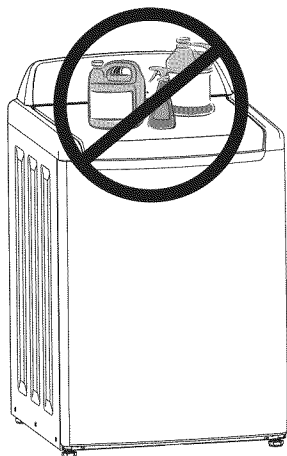
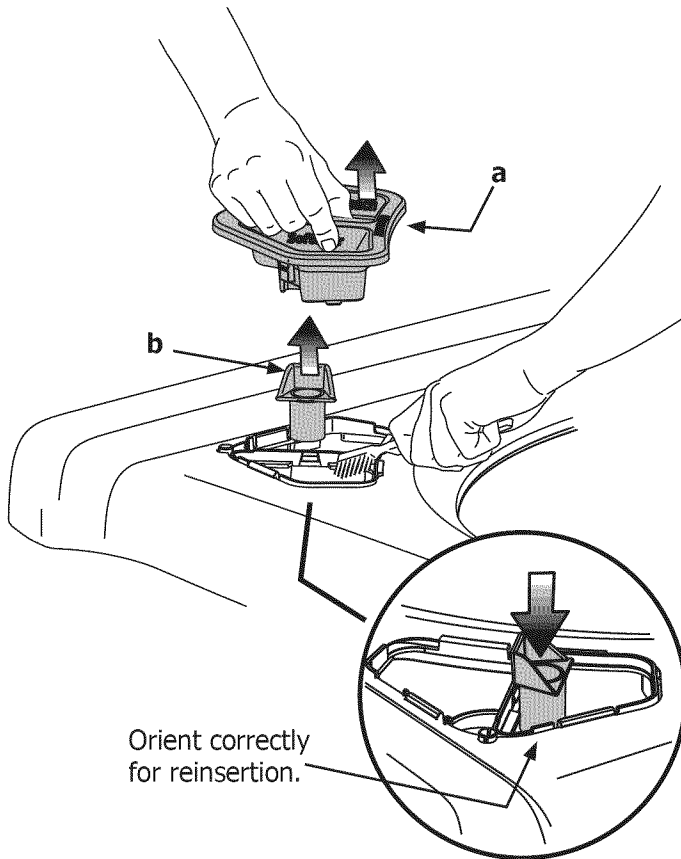

IMPORTANT

Do not store or place laundry products on top of washer at any time. They can damage the finish or controls.

INSIDE

- Remove items from the washer as soon as the cycle ends. Excess wrinkling, color transfer, and odors may develop in items left in the washer.
- Dry the washer top, the area around the lid opening, and the underside of the lid. These areas should always be dry before the lid is closed.
- Before cleaning the washer interior, unplug the electrical power cord to avoid electrical shock hazards.
- When extremely soiled items have been washed, a dirty residue may remain on the tub. Remove this by wiping the tub with a nonabrasive household cleanser. Rinse thoroughly with water.
- The base plate or tub may become stained from fabric dye. Clean these parts with a nonabrasive household cleanser. This prevents dye transfer to future loads.

FABRIC SOFTENER DISPENSER

- Remove the dual chamber insert (a) from the bleach and fabric softener dispenser by pinching at the chamber divider and lifting upward. Also remove the siphon cap (b).
- Rinse the insert and cap with a combination of $\frac{3}{4}$ cup liquid chlorine bleach and 1 gallon hot tap water to remove any buildup. Large amounts of fabric softener residue may indicate improper dilution or more frequent cleaning is required. Rinse well with tap water.
- For the dispenser well, use a small brush to clean the recesses. Remove all residue.
- Replace the siphon cap and insert by pressing it in place until you hear a slight click.

OUTSIDE

- When washing is completed, wipe top and sides of washer with a damp cloth. Turn water faucets off to prevent pressure build-up in the hoses.
- Clean the cabinet with mild soap and water. Never use harsh, gritty or abrasive cleansers.
- If the cabinet becomes stained, clean with diluted chlorine bleach (1 part bleach to 8 parts water). Rinse several times with clear water.
- Remove glue residue from tape or labels with a mixture of warm water and mild detergent. Or, touch residue with the sticky side of tape.
- Before moving the washer, place a strip of cardboard or thin fiberboard under the front leveling legs to prevent damage to the floor.

CARE AND CLEANING

Winterizing Instructions

➔ IMPORTANT

If the washer is stored in an area where freezing can occur or moved in freezing temperatures, follow these winterizing instructions to prevent damage to the washer:

- 1 Turn off water supply faucets.
- 2 Disconnect hoses from water supply and drain water from hoses.
- 3 Plug electrical cord into a properly grounded electrical outlet.
- 4 Add 1 gallon (3.8 L) nontoxic recreational vehicle (RV) antifreeze to empty wash tub. Close lid.
- 5 Select the **drain & spin** cycle. Start the cycle and let the washer drain for 1 minute to drain out all the water. Not all of the RV antifreeze will be expelled.
- 6 Stop the cycle, unplug electrical power cord, dry off tub interior and close the lid.
- 7 Store washer in an upright position.
- 8 To remove antifreeze from washer after storage, run empty washer through a complete cycle using detergent. **Do not add wash load.**



AVOID SERVICE CHECKLIST

Before calling for service, review this list. It may save both time and expense. The list includes common occurrences that are not the result of defective workmanship or materials in this washer.

OCCURRENCE	POSSIBLE CAUSE	SOLUTION
NOISE		
Rattling and clanking noise.	Foreign objects such as coins or safety pins may be in tub or pump.	Stop washer and check drum. If noise continues after washer is restarted, objects may be in pump. Call your authorized servicer.
	Belt buckles and metal fasteners are hitting wash tub.	To prevent unnecessary noise and damage to tub, fasten fasteners and turn items inside out.
Thumping sound.	Heavy wash loads may produce a thumping sound. This is usually normal. If sound continues, washer is probably out of balance.	Stop washer and redistribute wash load.
Squealing sound or hot rubber odor.	Washer is overloaded.	Do not overload washer. Stop washer and reduce load.
Vibrating noise.	Washer is not resting firmly on floor.	Move washer so it rests firmly on floor. Adjust leveling legs. See INSTALLATION INSTRUCTIONS for details.
	Shipping bolt has not been removed during installation.	See INSTALLATION INSTRUCTIONS for removing shipping bolt.
	Wash load unevenly distributed in tub.	Stop washer and rearrange wash load.
OPERATING		
Washer does not start.	Washer lid is open.	Close washer lid. The washer will not operate when the lid is open.
	Electrical power cord may not be plugged in or connection may be loose.	Make sure plug fits tightly in wall outlet.
	House fuse blown, circuit breaker tripped, or a power outage has occurred.	Reset circuit breaker or replace fuse. Do not increase fuse capacity. If problem is a circuit overload, have it corrected by a qualified electrician. If problem is a power outage, call local electric company.
	Water supply faucets are not turned on.	Turn on water supply faucets.
	Motor is overheated. Washer motor will stop if it becomes overheated.	Wait for the motor to cool down before attempting to restart.
Washer won't spin.	Lid is not completely closed.	Close washer lid. The washer will not operate when the lid is open.
Residue left in drum.	Heavily soiled items.	Wipe tub with a nonabrasive household cleanser, then rinse. Shake or brush excess dirt and sand from items before washing

AVOID SERVICE CHECKLIST

OCCURRENCE	POSSIBLE CAUSE	SOLUTION
WATER		
Wash load too wet after spin.	Washer is overloaded.	Do not overload washer. See Washing Procedures.
	Load is out of balance.	Rearrange load to allow proper spinning.
	Drain hose is kinked.	Straighten drain hose.
Water does not enter washer or it enters slowly.	Washer lid is open.	Close washer lid. The washer will not operate when the lid is open.
	Water supply is not adequate in area.	Check another faucet in the house. Wait until water supply and pressure increase.
	Water supply faucets are not completely open.	Fully open hot and cold faucets.
	Water is being used elsewhere in the house.	Water pressure must be at least 10 psi (69 kPa). Avoid running water elsewhere while washer is filling.
	Water inlet hoses are kinked.	Straighten hoses.
Water level does not cover load.	Improper water level selection (for models with water level/load size control).	Select higher water level/load size.
	Washer is overloaded.	Do not overload washer.
Warm or hot water is not hot enough.	Hot water heater is set too low or is a distance from washer.	Measure hot water temperature at nearby faucet with candy or meat thermometer. Water temperature should be at least 120°F (50°C). Adjust water heater as necessary.
	Hot water is being used elsewhere in the house.	Avoid using hot water elsewhere before or during washer use. There may not be enough hot water available for proper cleaning. If problem persists, your hot water system may be unable to support more than 1 use at a time.
Water in washer does not drain or drains slowly.	Drain hose is kinked or clogged.	Clean and straighten the drain hose.
Water leaks.	Loose fill hose connection at faucet or washer.	Check and tighten hose connections. Ensure rubber sealing washers are installed.
	House drain pipes are clogged.	Unclog drain pipes. Contact plumber if necessary.
Incorrect wash and rinse temperatures.	Hot and cold water hoses are connected to wrong supply faucets.	Connect hot water hose to hot water faucet and cold water hose to cold water faucet.
Water is entering washer but tub does not fill.	Drain hose standpipe is incorrect height.	Standpipe must be a minimum of 33" (83.82 cm) high to prevent siphoning. See INSTALLATION INSTRUCTIONS.
Water is present in tub after wash cycle is complete.	Lid lock malfunction.	Do not bypass lid lock. Call your authorized servicer.
The drain and spin cycles did not occur.	Lid lock malfunction.	Do not bypass lid lock. Call your authorized servicer.

MAJOR APPLIANCE WARRANTY INFORMATION

For the applicable warranty period as set forth below, as measured from your original date of purchase, Electrolux will repair or replace any parts of this appliance that prove to be defective in materials or workmanship when such appliance is installed, used and maintained in accordance with the provided instructions.

Warranty Periods:

- All parts — One year including labor
- Wash tub — Functional life of the product (excluding labor)
- Wash tub drive motor, non-cosmetic defects — Ten years (excluding labor)

Exclusions

This warranty does not cover the following:

1. Products with original serial numbers that have been removed, altered or cannot be readily determined.
2. Product that has been transferred from its original owner to another party or removed outside the USA or Canada.
3. Rust on the interior or exterior of the unit.
4. Products purchased "as-is" are not covered by this warranty.
5. Food loss due to any refrigerator or freezer failures.
6. Products used in a commercial setting.
7. Service calls which do not involve malfunction or defects in materials or workmanship, or for appliances not in ordinary household use or used other than in accordance with the provided instructions.
8. Service calls to correct the installation of your appliance or to instruct you how to use your appliance.
9. Expenses for making the appliance accessible for servicing, such as removal of trim, cupboards, shelves, etc., which are not a part of the appliance when it is shipped from the factory.
10. Service calls to repair or replace appliance light bulbs, air filters, water filters, other consumables, or knobs, handles, or other cosmetic parts.
11. Surcharges including, but not limited to, any after hour, weekend, or holiday service calls, tolls, ferry trip charges, or mileage expense for service calls to remote areas, including the state of Alaska.
12. Damages to the finish of appliance or home incurred during installation, including but not limited to floors, cabinets, walls, etc.
13. Damages caused by: services performed by unauthorized service companies; use of parts other than genuine Electrolux parts or parts obtained from persons other than authorized service companies; or external causes such as abuse, misuse, inadequate power supply, accidents, fires, or acts of God.

DISCLAIMER OF IMPLIED WARRANTIES; LIMITATION OF REMEDIES

CUSTOMER'S SOLE AND EXCLUSIVE REMEDY UNDER THIS LIMITED WARRANTY SHALL BE PRODUCT REPAIR OR REPLACEMENT AS PROVIDED HEREIN. CLAIMS BASED ON IMPLIED WARRANTIES, INCLUDING WARRANTIES OF MERCHANTABILITY OR FITNESS FOR A PARTICULAR PURPOSE, ARE LIMITED TO ONE YEAR OR THE SHORTEST PERIOD ALLOWED BY LAW, BUT NOT LESS THAN ONE YEAR. ELECTROLUX SHALL NOT BE LIABLE FOR CONSEQUENTIAL OR INCIDENTAL DAMAGES SUCH AS PROPERTY DAMAGE AND INCIDENTAL EXPENSES RESULTING FROM ANY BREACH OF THIS WRITTEN LIMITED WARRANTY OR ANY IMPLIED WARRANTY. SOME STATES AND PROVINCES DO NOT ALLOW THE EXCLUSION OR LIMITATION OF INCIDENTAL OR CONSEQUENTIAL DAMAGES, OR LIMITATIONS ON THE DURATION OF IMPLIED WARRANTIES, SO THESE LIMITATIONS OR EXCLUSIONS MAY NOT APPLY TO YOU. THIS WRITTEN WARRANTY GIVES YOU SPECIFIC LEGAL RIGHTS. YOU MAY ALSO HAVE OTHER RIGHTS THAT VARY FROM STATE TO STATE.

IF YOU NEED SERVICE

Keep your receipt, delivery slip, or some other appropriate payment record to establish the warranty period should service be required. If service is performed, it is in your best interest to obtain and keep all receipts. Service under this warranty must be obtained by contacting Electrolux at the addresses or phone numbers below.

This warranty only applies in the USA and Canada. In the USA, your appliance is warranted by Electrolux Major Appliances North America, a division of Electrolux Home Products, Inc. In Canada, your appliance is warranted by Electrolux Canada Corp. Electrolux authorizes no person to change or add to any obligations under this warranty. Obligations for service and parts under this warranty must be performed by Electrolux or an authorized service company. Product features or specifications as described or illustrated are subject to change without notice.

USA

1.800.944.9044

Electrolux Major Appliances
10200 David Taylor Drive
Charlotte, NC 28262



Electrolux

Canada

1.800.265.8352

Electrolux Canada Corp.
5855 Terry Fox Way
Mississauga, Ontario, Canada
L5V 3E4

