

Use & Care Guide
Manual de Uso y Cuidado
English / Español

Models/Modelos: 790.9760*, 790.9763*

Kenmore[®]

Double Oven Electric Range

Estufa de eléctrica con un doble horno

* = Color number, número de color

P/N 318205227B (1301)
Sears Brands Management Corporation
Hoffman Estates, IL 60179 U.S.A.
www.kenmore.com
www.sears.com



Table of Contents

Appliance Warranty.....	2
Product Record	2
Serial Plate Location	2
IMPORTANT SAFETY INSTRUCTIONS	3-5
Range Features.....	6
Before Setting Surface Controls.....	7
Setting Surface Controls.....	8-9
Surface Cooking	10

Before Setting the Oven Controls	10-11
Control Pad Features	12
Setting Oven Controls	13-19
Adjusting the Oven Temperature	20
Self-Cleaning.....	21-22
General Care & Cleaning.....	23-26
Before You Call.....	27-28
Protection Agreements.....	29
Sears Service.....	30

Kenmore Limited Warranty

When installed, operated and maintained according to all instructions supplied with the product, if this appliance fails due to a defect in material and workmanship within one year from the date of purchase, call 1-800-4-MY-HOME® to arrange for free repair.

This warranty applies for only 90 days from the date of purchase if this appliance is ever used for other than private family purposes.

This warranty covers only defects in material and workmanship. Sears will NOT pay for:

1. Cracks in a ceramic glass cooktop that are not a result of thermal shock.
2. Stains and scratches on a ceramic glass cooktop resulting from accident or improper operation or maintenance.
3. Expendable items that can wear out from normal use, including but not limited to filters, belts, light bulbs, and bags.
4. A service technician to instruct the user in correct product installation, operation or maintenance.
5. A service technician to clean or maintain this product.
6. Damage to or failure of this product if it is not installed, operated or maintained according to the all instructions supplied with the product.
7. Damage to or failure of this product resulting from accident, abuse, misuse or use for other than its intended purpose.
8. Damage to or failure of this product caused by the use of detergents, cleaners, chemicals or utensils other than those recommended in all instructions supplied with the product.
9. Damage to or failure of parts or systems resulting from unauthorized modifications made to this product.

Disclaimer of implied warranties; limitation of remedies

Customer's sole and exclusive remedy under this limited warranty shall be product repair as provided herein. Implied warranties, including warranties of merchantability or fitness for a particular purpose, are limited to one year or the shortest period allowed by law. Sears shall not be liable for incidental or consequential damages. Some states and provinces do not allow the exclusion or limitation of incidental or consequential damages, or limitation on the duration of implied warranties of merchantability or fitness, so these exclusions or limitations may not apply to you.

This warranty applies only while this appliance is used in the United States or Canada.

This warranty gives you specific legal rights, and you may also have other rights which vary from state to state.

Sears Brands Management Corporation, Hoffman Estates, IL 60179 - Sears Canada Inc., Toronto, Ontario, Canada M5B 2B8

Product Record

In this space below, record the date of purchase, model and serial number of your product. You will find the model and serial number printed on the serial plate.

Model No. _____

Serial No. _____

Date of purchase _____

Save these instructions and your sales receipt for future reference.

Please carefully read and save these instructions

This Use & Care Manual contains general operating instructions for your appliance and feature information for several models. Your product **may not** have all the described features. The graphics shown are representative. The graphics on your appliance may not look exactly like those shown. Common sense and caution must be practiced when installing, operating and maintaining any appliance.

Serial Plate Location

You will find the model and serial number printed on the serial plate. The serial plate is located as shown.

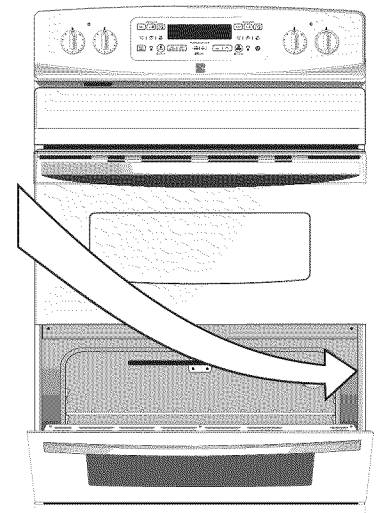

IMPORTANT SAFETY INSTRUCTIONS

Read all instructions before using this appliance.

This manual contains important safety symbols and instructions. Please pay attention to these symbols and follow all instructions given.

⚠ WARNING This symbol will help alert you to situations that may cause serious bodily harm, death or property damage.

⚠ CAUTION This symbol will help alert you to situations that may cause bodily injury or property damage.

- Remove all tape and packaging before using the appliance. Destroy the carton and plastic bags after unpacking the appliance. Never allow children to play with packaging material.
- Proper Installation. Be sure your appliance is properly installed and grounded by a qualified technician in accordance with National Electrical Code ANSI/NFPA No.70 (USA) or CSA C22.1, PART 1 (Canada)-latest edition and local code requirements. Install only per installation instructions provided in the literature package for this appliance.
- In case of an emergency, know how to disconnect the electrical power to the appliance at the circuit breaker or fuse box.
- User Servicing. Do not repair or replace any part of the appliance unless specifically recommended in the manuals. All other servicing should be done only by a qualified technician to reduce the risk of personal injury and damage to the appliance. Sears Parts & Repair is the recommended repair service for this appliance.
- Never modify or alter the construction of an appliance by removing panels, wire covers or any other part of the product.
- Remove the oven door from any unused appliance if it is to be stored or discarded.

⚠ WARNING Tip Over Hazard

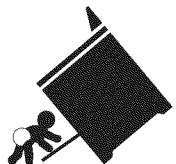

- A child or adult can tip the range and be killed.
- Verify the anti-tip device has been installed to floor or wall.
- Ensure the anti-tip device is re-engaged to floor or wall when the range is moved.
- Do not operate the range without the anti-tip device in place and engaged.
- Failure to follow these instructions can result in death or serious burns to children and adults.



Range
Leveling
Leg

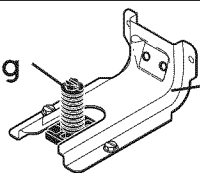

Anti-Tip
Bracket

To check if the anti-tip bracket is installed properly, use both arms and grasp the rear edge of range back. Carefully attempt to tilt range forward. When properly installed, the range should not tilt forward.

Refer to the anti-tip bracket installation instructions supplied with your range for proper installation.

⚠ WARNING Stepping, leaning, sitting or pulling down on the door of this appliance can result in serious injuries and may also cause damage to the appliance. Do not allow children to climb or play around the appliance.

• Storage on Appliance. Flammable materials should not be stored near surface units. This includes paper, plastic and cloth items, such as cookbooks, plasticware and towels, as well as flammable liquids. Do not store explosives, such as aerosol cans, on or near the appliance. Flammable materials may explode and result in fire or property damage.

⚠ WARNING Do not use the ovens for storage.

⚠ CAUTION Do not store items of interest to children in the cabinets above an appliance. Children climbing on the appliance to reach items could be seriously injured.

• Do not leave children alone. Children should not be left alone or unattended in the area where an appliance is in use. They should never be allowed to sit or stand on any part of the appliance.

IMPORTANT SAFETY INSTRUCTIONS

- **DO NOT TOUCH SURFACE UNITS OR AREAS NEAR THESE SURFACES.** Surface units may be hot even though they are dark in color. Areas near surface units may become hot enough to cause burns. During and after use, do not touch, or let clothing or other flammable materials touch these areas until they have had sufficient time to cool. Among these areas are the cooktop and areas facing the cooktop.
- **Wear Proper Apparel.** Loose-fitting or hanging garments should never be worn while using the appliance. Do not let clothing or other flammable materials contact hot surfaces.

⚠ WARNING Never use your appliance for warming or heating the room.

- **Do Not Use Water or Flour on Grease Fires.** Smother the fire with a pan lid, or use baking soda, a dry chemical or foam-type extinguisher.
- **When heating fat or grease, watch it closely.** Fat or grease may catch fire if allowed to become too hot.
- **Use Only Dry Potholders.** Moist or damp potholders on hot surfaces may result in burns from steam. Do not let the potholders touch hot heating surface units. Do not use a towel or other bulky cloth instead of a potholder.
- **Do Not Heat Unopened Food Containers.** Buildup of pressure may cause the container to burst and result in injury.

IMPORTANT—Do not attempt to operate the appliance during a power failure. If power fails, always turn off the appliance. If the appliance is not turned off and the power resumes, it will begin to operate again. Once the power resumes, reset the clock and oven function.

IMPORTANT INSTRUCTIONS FOR USING YOUR COOKTOP

- **Know which knob controls each surface heating unit.** Place a pan of food on the unit before turning it on, and then turn the unit off before removing the pan.
- **Use proper pan size.** This appliance is equipped with one or more surface units of different sizes. Select utensils having flat bottoms large enough to cover the surface unit. The use of undersized utensils will expose a portion of the

surface heating unit to direct contact and may result in ignition of clothing. Proper relationship of utensil to the surface unit will also improve efficiency.

- **Utensil handles should be turned inward and not extend over adjacent surface units.** To reduce the risk of burns, ignition of flammable materials, and spillage due to unintentional contact with the utensil.
- **Never leave surface burners unattended at high heat settings—Boilovers cause smoking and greasy accumulations that may ignite, or a pan that has boiled dry may melt.**
- **Glazed cooking utensils—Only certain types of glass, glass/ceramic, ceramic, earthenware, or other glazed utensils are suitable for rangetop service without breaking due to the sudden change in temperature.** Check the manufacturer's recommendations for cooktop use.
- **When flaming foods under a ventilating hood, turn the fan on.**

IMPORTANT INSTRUCTIONS FOR USING YOUR OVEN

- **Use Care When Opening an Oven Door—Stand to the side of the appliance when opening the door of a hot oven.** Let hot air or steam escape before you remove or replace food in the oven.
- **Keep Oven Vent Ducts Unobstructed.** The upper oven is vented at the back of the cooktop and the lower oven at the center trim. Touching the surfaces in this area when the oven is operating may cause severe burns. Also, do not place plastic or heat-sensitive items near the oven vent. These items could melt or ignite.
- **Placement of Oven Racks.** Always place oven racks in desired location while oven is cool. Remove all utensils from the rack before removing rack. If rack must be moved while oven is hot, use extreme caution. Use pot holders and grasp the rack with both hands to reposition. Do not let pot holders contact the hot oven element or interior of the oven.
- **Do not use the broiler pan without its insert.** The broiler pan and grid allow dripping fat to drain and be kept away from the high heat of the broiler.

IMPORTANT SAFETY INSTRUCTIONS

- Do not cover the broiler grid or oven bottom with aluminum foil. Exposed fat and grease could ignite.
- Do not touch a hot oven light bulb with a damp cloth. Doing so could cause the bulb to break. Disconnect the appliance or shut off the power to the appliance before removing and replacing the bulb.
- Protective liners—Do not use aluminum foil to line the oven bottom. Only use aluminum foil as recommended in this manual. Improper installation of these liners may result in risk of electric shock, or fire.

SELF-CLEANING OVEN MODELS

- Clean in the self-cleaning cycle only the parts of the appliance listed in this Use & Care Guide. Before using the self-cleaning cycle of the appliance, remove the broiler pan and any utensils stored in the appliance.
- Do not clean the oven door gasket. The door gasket is essential for a good seal. Care should be taken not to rub, damage or move the gasket.
- Do not use oven cleaners. No commercial oven cleaner or oven liner protective coating of any kind should be used in or around any part of the appliance

⚠ CAUTION The health of some birds is extremely sensitive to the fumes given off during the self-clean cycle of any oven. Move birds to another well ventilated room.

IMPORTANT INSTRUCTIONS FOR CLEANING YOUR OVEN

- Clean the appliance regularly to keep all parts free of grease that could catch fire. Exhaust fan ventilation hoods and grease filters should be kept clean. Do not allow grease to accumulate. Greasy deposits in the fan could catch fire. Refer to the hood manufacturer's instructions for cleaning.
- Clean Ventilating Hoods Frequently—Grease should not be allowed to accumulate on the hood or filter. Follow manufacturer's instructions for cleaning.

FOR CERAMIC GLASS COOKTOPS

- Do not clean or operate a broken cooktop—If cooktop should break, cleaning solutions and spillovers may penetrate the broken cooktop and create a risk of electric shock. Contact a qualified technician immediately.
- Clean cooktop glass with caution—If a wet sponge or cloth is used to wipe spills on a hot cooking area, be careful to avoid a steam burn. Some cleaners can produce harmful fumes if applied to a hot surface.
- Avoid scratching the cooktop glass with sharp objects.

IMPORTANT SAFETY NOTICE

The California Safe Drinking Water and Toxic Enforcement Act requires the Governor of California to publish a list of substances known to the state to cause cancer, birth defects or other productive harm, and requires businesses to warn customers of potential exposure to such substances.

SAVE THESE INSTRUCTIONS FOR FUTURE REFERENCE.

Range Features

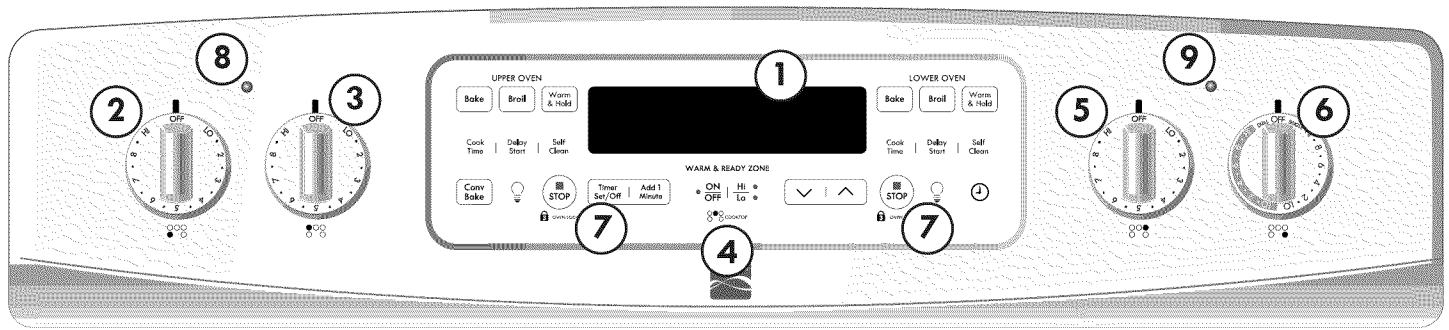

Your electric range includes:

1. Electronic Oven Control with Timer
2. Left Front Element Control Knob & Indicator Light
3. Left Rear Element Control Knob & Indicator Light
4. Warm & Ready Zone Control Pads & Indicator Light
5. Right Rear Element Control Knob & Indicator Light
6. Right Front Dual Element Control Knob & Indicator Light
7. Oven Lockout Controls
8. Hot Surface Indicator Light
9. Element ON Indicator Light
10. One Piece Handle
11. Self-Cleaning Convection Interior Oven
12. Oven Self-Clean Door Latch
13. Oven Broil Element
14. Oven Interior Light
15. Self-Clean Oven
16. Adjustable Oven Rack
17. Full width Oven Door with Large Window
18. Leveling Legs and Anti-Tip Bracket (included)
19. 6" Single Radiant Element
20. Warm & Ready Zone Element
21. 9" single Radiant Element
22. 6"-9" Double Radiant Element
23. Ceramic Glass Smoothtop

NOTE: The features of your range may vary according to model type & color.

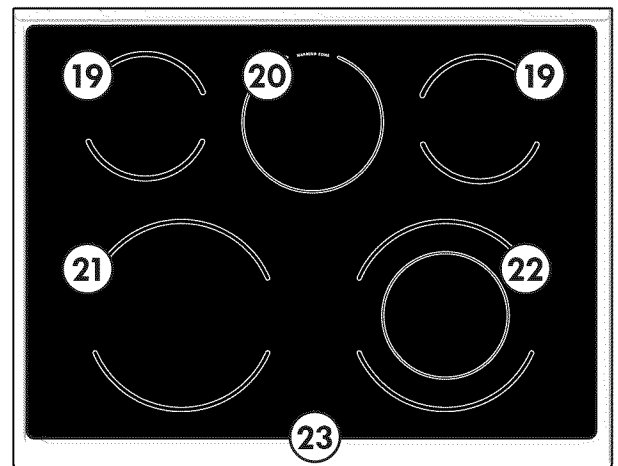
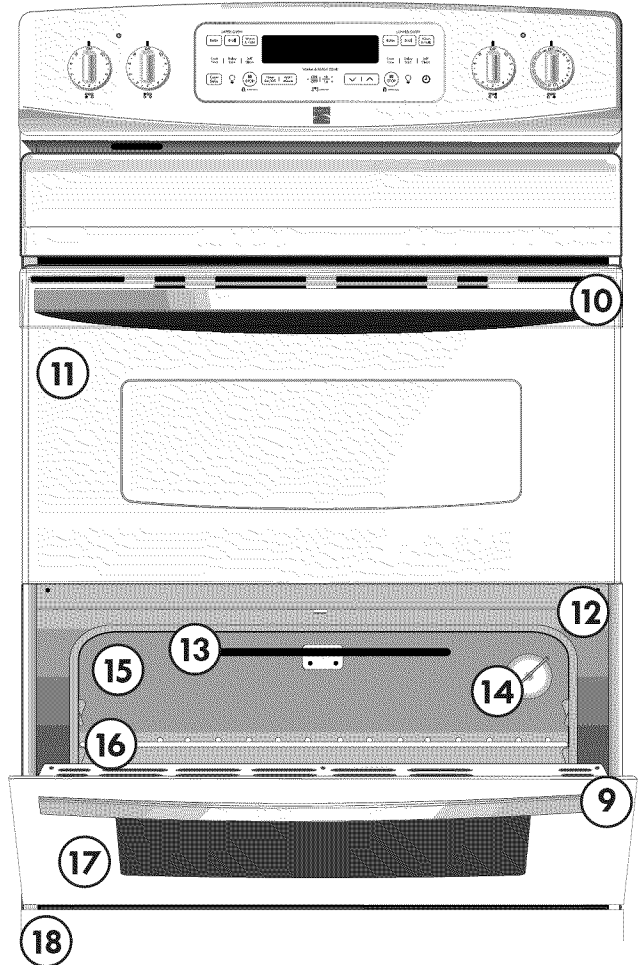

Before Setting Surface Controls

About the Ceramic Glass Cooktop

The ceramic cooktop has radiant surface elements located below the surface of the glass. The design of the ceramic cooktop outlines the area of the surface element underneath. **Make sure** the diameter of the pan matches the diameter of the element outline on the cooktop (See Figure 1). Heat is transferred up through the surface of the cooktop to the cookware. Only flat-bottom cookware should be used. The type and size of cookware, the number of surface elements in use and their settings, are all factors that will affect the amount of heat that will spread to areas beyond the surface elements.

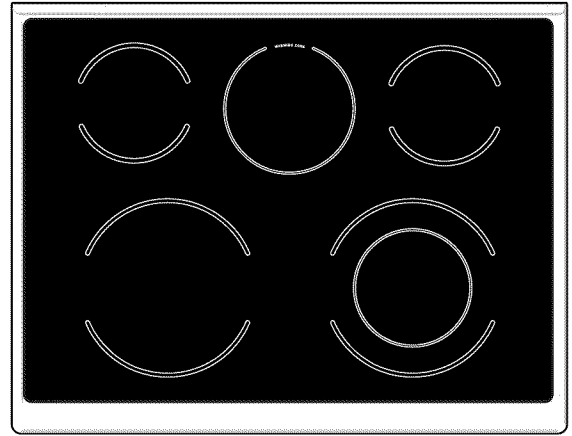

Figure 1

CAUTION The areas surrounding the elements may become hot enough to cause burns.

About the Radiant Surface Elements

The element temperature rises gradually and evenly. As the temperature rises, the element will glow red. To maintain the selected setting, the element will cycle on and off. The heating element retains enough heat to provide a uniform and consistent heat during the off cycle. **For efficient cooking, turn off the element several minutes before cooking is complete.** This will allow residual heat to complete the cooking process.

Locations of the Radiant Surface Elements and Controls

Your range is equipped with radiant surface burners with different wattage ratings. The ability to heat food quicker and in larger volumes increases as the element wattage increases. The radiant surface elements are located on the cooktop as follows:

- Two 6 inch radiant elements located at both right & left rear positions.
- One dual 6 or 9 inch radiant element located at the right front position.
- One 9 inch radiant elements located at the left front position.
- a Warmer Zone located at the center rear position.

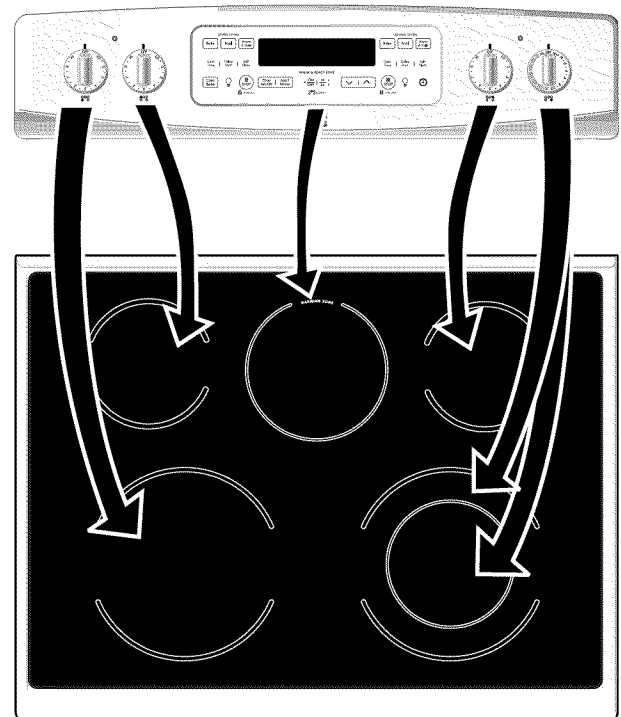

Figure 2

Note: Please read detailed instructions for ceramic glass cooktop cleaning in the **General Care & Cleaning** section and **Before You Call** checklist section of this Use and Care Guide.

Note: Radiant elements have a limiter that allows the element to cycle on and off, even at the HI setting. This helps to prevent damage to the ceramic glass cooktop. Cycling at the HI setting is normal and can also occur if the cookware is too small for the radiant element or if the cookware bottom is not flat (Refer to page 10 for correct cookware instructions).

Note: (White glass cooktops only) Due to the high intensity of heat generated by the surface elements, the glass surface will turn to a pale green when the element is first turned off. This phenomenon is normal and the glass will come back to its original white color after it has completely cooled down.

CAUTION Radiant surface elements may appear to have cooled after they have been turned off. The glass surface may still be hot and burns may occur if the glass surface is touched before it has cooled sufficiently.

CAUTION Do not place plastic items such as salt and pepper shakers, spoon holders or plastic wrappings on top of the range when it is in use. These items could melt or ignite. Potholders, towels or wooden spoons could catch fire if placed too close to the surface elements.

Setting Surface Controls

Surface Cooking Settings

Use the chart (Figure 1) to determine the correct setting for the kind of food you are preparing. The Simmer settings are used to simmer and keep larger quantities of foods warm such as stews and soups. The lower Simmer settings are ideal for delicate foods and melting chocolate or butter.

Note: The size and type of cookware used will influence the setting needed for best cooking results.

Recommended Settings for Single and Dual Surface Elements	
Setting*	Type of Cooking
HIGH (Hi)	Start most foods, bring water to a boil, pan broiling
MEDIUM HIGH (5-8)	Continue a rapid boil, fry, deep fat fry
MEDIUM (5)	Maintain a slow boil, thicken sauces and gravies, steam vegetables
MEDIUM LOW (2 - 4)	Keep foods cooking, poach, stew
LOW (Lo - 2)	Keep warm, melt, simmer

*The suggested settings are based on cooking in medium thickness aluminum pans with lids. Settings may vary when using other types of pans.

Operating Single Radiant Surface Elements

The cooktop has single radiant surface elements at 2 locations; the right rear and the left rear (Figure 2) element positions.

To Operate the Single Surface Elements:

1. Place correctly sized cookware on the radiant surface element.
2. Push in and turn the surface control knob in either direction to the desired setting (Figure 3). Turn the knob to adjust the setting if desired. Start most cooking operations on a higher setting and then turn to a lower setting to finish cooking. Each surface element provides a constant amount of heat at each setting. A glowing red surface heating area extending beyond the bottom edge of the cookware indicates the cookware is **too small** for the surface heating area.
3. When cooking has completed, turn the surface control knob to OFF before removing the cookware.

Note: The Element On Indicator light will turn on when the surface element is turned on and will turn off when the surface element is turned off. The Hot Surface indicator light will turn on when the glass cooktop is hot and will continue to glow until the glass cooktop has cooled down to a moderate level. The light may remain on even though the controls are turned OFF.

Note: See above, Figure 1 for recommended control settings.

CAUTION Radiant surface elements may appear to have cooled after they have been turned off. A hot surface indicator light will come on and will continue to glow until the glass cooktop has cooled down to a moderate level. **The glass surface may still be hot and burns may occur if the glass surface is touched before the indicator light has turned off.**

CAUTION Do not place plastic items such as salt and pepper shakers, spoon holders or plastic wrappings on top of the range when it is in use. These items could melt or ignite. Potholders, towels or wooden spoons could catch fire if placed too close to the surface elements.

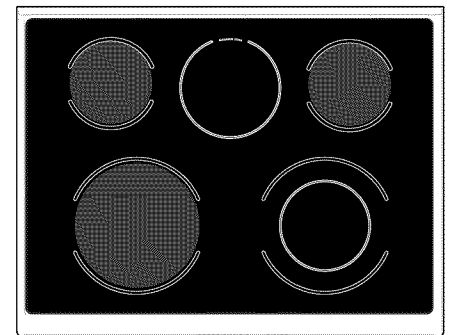

Figure 2

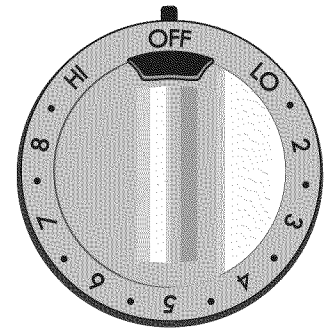
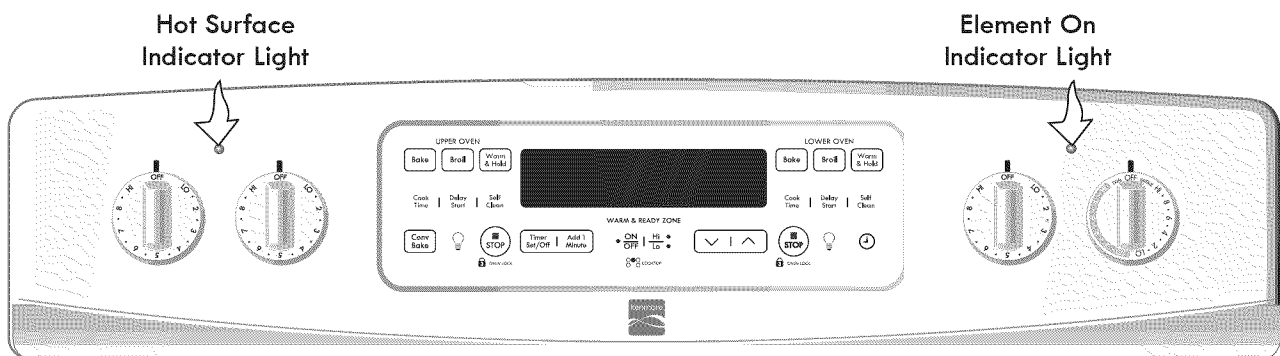

Figure 3



Setting Surface Controls (cont'd)

Operating the Dual Surface Radiant Element

The cooktop is equipped with a dual radiant surface elements located at the right front (See Figure 3 & 4) position. "Single and Dual" on the control knob are used to indicate which coil of the dual radiant element will heat. "Single" indicates that only the inner coil will heat (Figures 1 & 3). "Dual" indicates that both inner and outer coils will heat (Figures 2 & 4). You may switch from either coil setting at any time during cooking.

To Operate the Dual Surface Element:

1. Place correctly sized cookware on the dual surface element.
2. Push in and turn the control knob counterclockwise (See Figure 1) for smaller cookware or clockwise (See Figure 2) for larger cookware.
3. Turn the knob to adjust the setting if needed. Start most cooking operations on a higher setting and then turn to a lower setting to finish cooking. Each surface element provides a constant amount of heat at each setting. A glowing red surface heating area extending beyond the bottom edge of the cookware indicates the cookware is too small for the surface heating area.
4. When cooking has completed, turn the surface control knob to OFF before removing the cookware.

Note: The Element On Indicator light will turn on when the surface element is turned on and will turn off when the surface element is turned off. The Hot Surface indicator light will turn on when the glass cooktop is hot and will continue to glow until the glass cooktop has cooled down to a moderate level. The light may remain on even though the controls are turned OFF.

Note: See "Recommended Settings for Single and Dual Surface Elements" for recommended control settings.

Operating the Warm & Ready™ Zone

The Warm & Ready™ zone radiant element is located at the center rear position (Figure 6). The purpose of the Warmer Zone is to keep hot cooked foods at serving temperature. Use the Warmer Zone to keep cooked foods hot such as: vegetables, gravies, casseroles, soups, stews, breads, pastries and oven-safe dinner plates. Always start with hot food. It is not recommended to heat cold food on the Warmer Zone.

CAUTION The Warmer Zone will not glow red when it is hot, but becomes hot enough to cause burns. Always use potholders or oven mitts when removing food from the warmer zone as cookware and plates will be hot.

All food placed on the warmer zone should be covered with a lid to maintain quality. For best results, when warming pastries or breads, the cover should have an opening to allow moisture to escape. **Do not use plastic wrap or aluminum foil to cover food. Plastic or aluminum may melt onto the surface.**

Use only plates, utensils and cookware recommended by the item manufacturer for oven and cooktop use on the Warmer Zone.

To Set the Warmer Zone Control:

1. Place correctly sized cookware on the Warm & Ready™ zone surface element.
2. Touch the ON/OFF pad (Figure 5) at the Warm & Ready zone control position. The ON/OFF indicator light will flash. Note: If no Hi/Lo pad is not touched within 5 seconds, the request to power the Warm & Ready zone ON will clear.
3. At the Warm & Ready Zone control position, touch the Hi/Lo pad once to set the zone at Lo level or touch Hi/Lo pad twice to set the zone at Hi level.
4. When it is time to serve food, touch the ON/OFF pad once to turn off the Warm & Ready Zone. The ON/OFF indicator light will turn OFF.

CAUTION Radiant surface elements may appear to have cooled after they have been turned off. The glass surface may still be hot and burns may occur if the glass surface is touched before it has cooled sufficiently.

CAUTION Do not place aluminum foil or plastic items such as salt and pepper shakers, spoon holders or plastic wrappings on top of the range when it is in use. These items could melt or ignite. Potholders, towels or wooden spoons could catch fire if placed too close to the surface elements or burners.



Figure 1

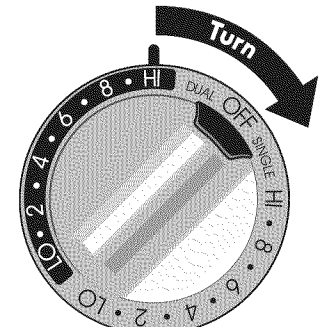

Figure 2

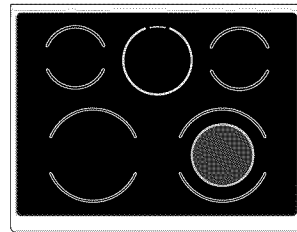

Figure 3

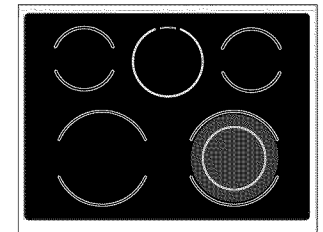

Figure 4

WARM & READY ZONE



Figure 5

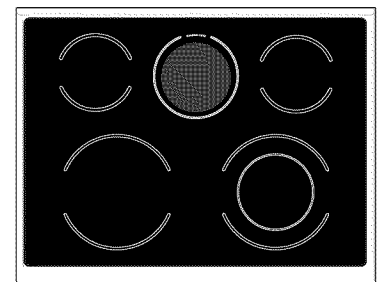

Figure 6

Surface Cooking

Selecting Surface Cooking Cookware

Cookware should have flat bottoms that make good contact with the entire surface heating element. Check for flatness by rotating a ruler across the bottom of the cookware (See Figure 1). Be sure to follow the recommendations for using cookware as shown in Figure 2.

Note: The size and type of cookware used will influence the setting needed for best cooking results.

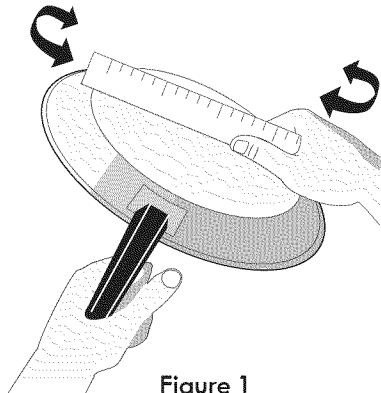

Figure 1

Correct

- Flat bottom and straight sides.
- Tight fitting lids.
- Weight of handle does not tilt pan. Pan is well balanced.
- Pan sizes match the amount of food to be prepared and the size of the surface element.
- Made of a material that conducts heat well.
- Easy to clean.
- Always match pot diameter to element surface diameter.

Incorrect

- Curved and warped pan bottoms.
- Pan overhangs element by more than one-half inch.
- Pan is smaller than element.
- Heavy handle tilts pan.

Figure 2

Cookware Material types

The cookware material determines how evenly and quickly heat is transferred from the surface element to the pan bottom. The most popular materials available are:

ALUMINUM - Excellent heat conductor. Some types of food will cause it to darken (Anodized aluminum cookware resists staining & pitting). If aluminum pans slide across the ceramic glass cooktop, they may leave metal marks which will resemble scratches. Remove these marks immediately.

COPPER - Excellent heat conductor but discolors easily. May leave metal marks on ceramic glass (see Aluminum above).

STAINLESS STEEL - Slow heat conductor with uneven cooking results. Is durable, easy to clean and resists staining.

CAST IRON - A poor heat conductor however will retain heat very well. Cooks evenly once cooking temperature is reached. Not recommended for use on ceramic cooktops.

PORCELAIN-ENAMEL on METAL - Heating characteristics will vary depending on base material. Porcelain-enamel coating must be smooth to avoid scratching ceramic cooktops.

GLASS - Slow heat conductor. Not recommended for ceramic cooktop surfaces because it may scratch the glass.

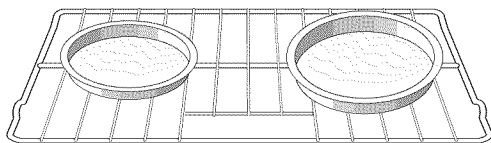

1 Oven Rack

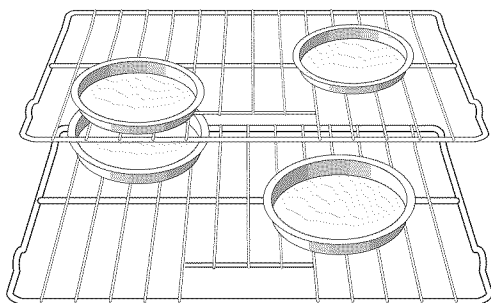

Multiple Oven Racks

Before Setting the Oven Controls

Air Circulation in the Oven

If using 1 rack, place in center of oven. If using multiple racks, stagger cookware as shown.

For best air circulation and baking results allow 2-4" (5-10 cm) around the cookware for proper air circulation and be sure pans and cookware do not touch each other, the oven door, sides or back of the oven cavity. The hot air must circulate around the pans and cookware in the oven for even heat to reach around the food.

Before Setting the Oven Controls

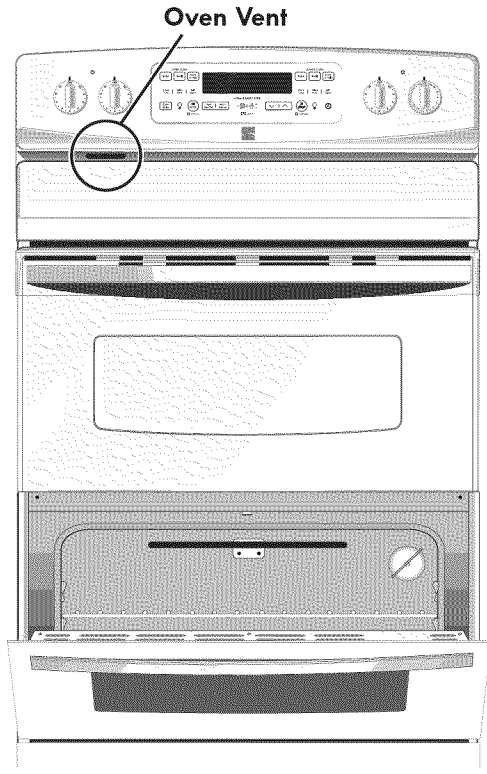

Oven Vent Location

See illustration on left side for venting location of each oven. When the oven is on, warm air is released through the vent. This venting is necessary for proper air circulation in the oven and good baking results. Steam or moisture may appear near the oven vent, this is normal. **Do not block the oven vent.**

Removing & Replacing Oven Racks

To remove an oven rack, pull the rack forward until it stops. Lift up front of rack and slide out.

To replace an oven rack, fit the rack onto the guides on the oven walls. Tilt the front of the rack upward and slide the rack back into place.

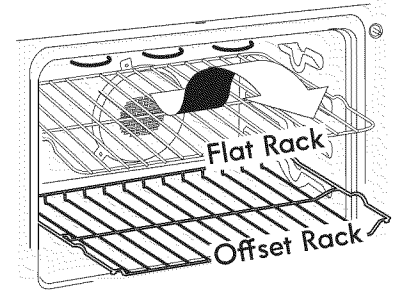

Arranging Oven Racks & Supports

Always arrange oven racks when the oven is cool (Prior to operating the oven).

Food	Rack Positions	
	Lower	Upper
Broiling meats, chicken or fish	3	3
Baking		
To bake on: 1 rack	2	2
2 racks	1 & 3	1 & 3
Frozen pies, angel food cake, yeast, bread, casseroles, small cuts of meat or poultry	1 or 2	1 or 2
Turkey, roast or ham	1	1

Note: Always use oven mitts when removing food.

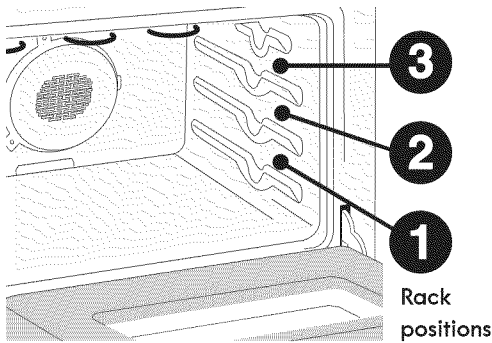

Note: It is recommended not to introduce food into the oven until the preheat cycle time is complete. During the preheat cycle, both the bake and the broil elements are cycling which may cause unsatisfactory cooking performance or premature scorching of food if placed in oven prior to completion of the preheat cycle.

Types of oven racks

Your range may be equipped with one or more of the oven racks styles shown;

- Flat handle oven rack (Figure 1).
- Offset oven rack (Figure 2).

CAUTION Always use pot holders or oven mitts when adjusting the oven racks. Wait until the oven has completely cooled if possible. Oven racks may be HOT and may cause burns.

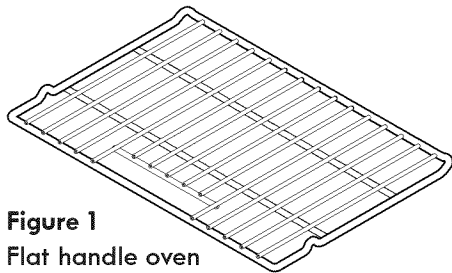

Figure 1
Flat handle oven rack

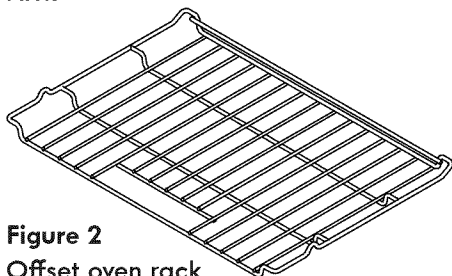

Figure 2
Offset oven rack

The Flat Oven Handle Rack has an handle to facilitate the sliding of the rack when large amount of foods weight on it (See Figure 1).

The Offset Oven Rack is used to maximize cooking space (See Figure 2). The offset rack can be used in the lower rack position to roast large cuts of meat and poultry.

Control Pad Features

READ THE INSTRUCTIONS CAREFULLY BEFORE USING THE OVEN. For satisfactory use of your oven, become familiar with the various features and functions of the oven as described below. **Detailed instructions for each feature and function follow later in this Use & Care Guide.**

NOTICE: The instructions contained in this document only refer to the upper oven operations. These instructions can also be applied to the lower oven by selecting the same functions (except convection bake) on the right hand side of the control panel.

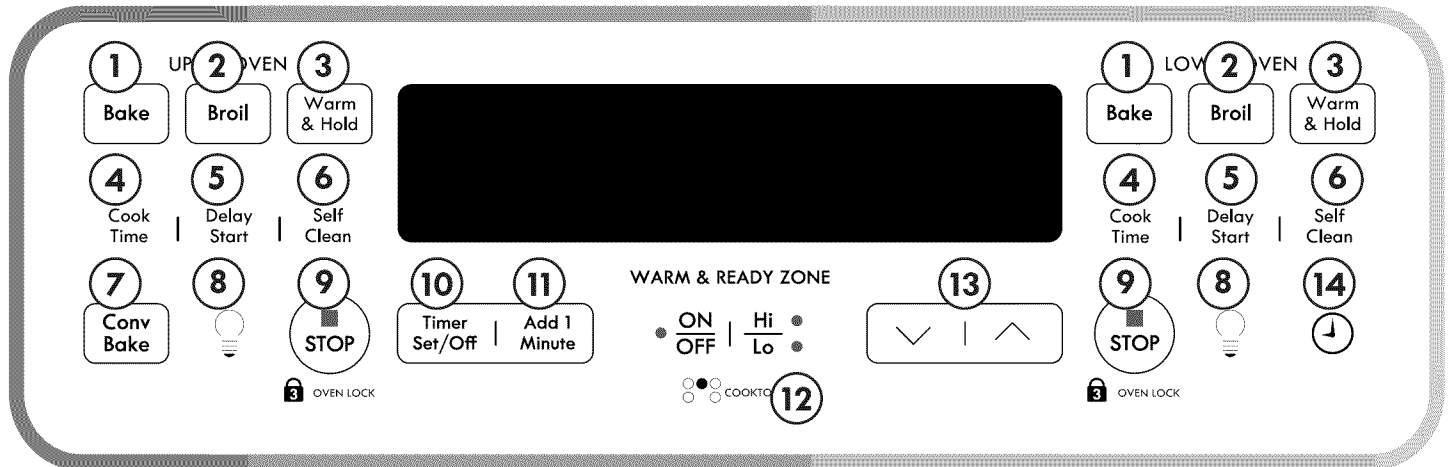

Oven Control Keypads

1. **Bake** - Used to start normal bake function.
2. **Broil** - Used to select the broil function.
3. **Warm & Hold** - Used to set the Warm & Hold function.
4. **Cook Time** - Used to enter the length of the cook time desired.
5. **Delay Start** - Used to set the desired start time for baking. May be used with COOK TIME to program a delayed timed bake or clean cycle.
6. **Self Clean or Flex Clean** (some models) - Used to set a 2 to 4 hours Self-Clean cycle.
7. **Conv Bake** - Used to select the Convection feature (available with the upper oven only)
8. **Oven Light** - Used to turn oven light ON and OFF.
9. **STOP** - Used to cancel any oven function previously entered except Clock and Timer. Also used to lockout oven functions and door.
10. **Timer Set/Off** - Used to set or cancel Timer. The minute timer does not start or stop cooking.
11. **Add 1 Minute** - Used to add additional minutes to Timer.
12. **Warm & Ready Zone** - Used to set the Warm & Ready Zone feature.
13. **Up and Down Arrow** - Used along with the function pads to select oven temperature, cook time, start time (when programming an automatic start time), time of day, clean time and minute timer.
14. **Clock Set** - Used to set the time of day.

Temperature Visual Display

Your oven is equipped with a temperature visual display. When a cooking mode is set, the actual temperature will be shown in the display and will rise as the unit preheat. When the unit has reached its target temperature, a chime will sound to remind you to place the food in the oven. This feature will be active with the modes: BAKE and CONV BAKE (upper oven only).

For a silent control panel:

The DELAY START pad controls the Silent Control Panel feature. The Silent Control Panel feature allows the oven control to be operated without sounds or beeps whenever necessary. If desired the control can be programmed for silent operation and later returned to operating with all the normal sounds and beeps.

To change control from normal sound operation to silent control operation

1. Press and hold DELAY START pad for 6 seconds. A beep will sound, "-- --" will appear, "DELAY" will flash in the display. After 6 seconds, a beep will sound and "SP" (speaker) or "- -" will appear in the display.
2. Press ^ or v pad to switch between normal sound operation and silent operation mode. If "SP" appears, the control will operate with normal sounds and beeps. If "- -" appears, the control is in the silent operation mode.
3. Wait 5 seconds to accept the change or press STOP pad to reject the change.

Note: The control will always beep at the end of a minute timer and will beep when a set temperature has been reached, even if the control is set to silent operation.

Setting Oven Controls



Note: The time of day **must** first be set in order to operate the oven.

To Set the Clock



The  pad is used to set the clock. The clock may be set for 12 or 24 hour time of day operation. The clock has been preset at the factory for the 12 hour operation. When the appliance is first plugged in, or when the power supply to the appliance has been interrupted, the timer in the display will flash.

Press **STOP** pad to get the timer and ovens ready to use.

To set the clock

1. Press  pad. "CLO" and the current time of day will appear in the display.
2. Press  or  pad to set the correct time of day. Wait 5 seconds to accept the change or press **STOP** pad to reject the change. The new time of day will appear in the display.



Changing Between 12 or 24 Hour Time of Day Display:

1. Press and hold  pad for 6 seconds. "CLO" and the current time of day will appear in the display. A beep will sound and "12h" or "24h" will appear in the display.
2. Press  or  pad to switch between the 12 and 24 hour time of day display. The display will show either "12h" or "24h".
3. Wait 5 seconds to accept the change or press **STOP** pad to reject the change.
4. Reset the correct time as described in **To set the Clock** above. Please note that if the 24 hour time of day mode was chosen, the clock will now display time from 0:00 through 23:59 hours.

To Set the Minute Timer

The **TIMER SET/OFF** pad controls the Timer feature. The Timer serves as an extra timer in the kitchen that will beep when the set time has run out. It does not start or stop cooking. The Timer feature can be used during any of the other oven control functions, except during a self clean operation.

To set the Timer

1. Press **TIMER SET/OFF** pad. "-- --" will appear and "TIMER" will flash in the display.
2. Press  or  pad to set the desired time in the display. Wait 5 seconds and the time will begin to count down with the set time and "TIMER" will stay in the display.
3. When the set time has run out, "End" and "TIMER" will show in the display. The clock will sound with 3 beeps every 7 seconds until **TIMER SET/OFF** pad is pressed.

To cancel the Minute Timer before the set time has run out: Press **TIMER SET/OFF** pad. The display will return to the time of day.



To Set Add 1 Minute Feature

The **ADD 1 MINUTE** pad is used to set the Add 1 Minute feature. When the Add 1 Minute pad is pressed, 1 minute is added to the Kitchen Timer feature if this feature is already active. If the Kitchen Timer feature is not active and the **ADD 1 MINUTE** pad is pressed, the Kitchen Timer feature will become active and will begin counting down from 1 minute.

Temperature Conversion (Fahrenheit / Celsius)

The **BROIL** pad controls the Fahrenheit or Celsius temperature display modes. The oven control can be programmed to display temperatures in Fahrenheit or Celsius. The oven has been preset at the factory to display in Fahrenheit. Note: both ovens will be changed at the same time.

To change display from Fahrenheit to Celsius or Celsius to Fahrenheit

1. Press **BROIL** pad and hold for 6 seconds. A beep will sound, "---" will appear and "BROIL" will flash in the display. After 6 seconds a beep will be heard and "F" or "C" will appear in the display. If "F" appears, the display is set to show temperatures in Fahrenheit. If "C" appears, the display is set to show temperatures in Celsius.
2. Press  or  pad to switch between Fahrenheit or Celsius display modes. The display will show either "F" or "C".
3. Wait 5 seconds to accept the change or press **STOP** pad to reject the change.

To Operate the Oven Light(s)

The interior oven light(s) will automatically turn ON when the oven door is opened. Press  to turn the interior light(s) ON and OFF whenever the door is closed.

Setting Oven Controls



Note: The time of day must first be set in order to operate the oven.

To Set or Change the Temperature for Baking

The **BAKE** pad controls normal baking. The oven can be programmed to bake at any temperature from 170°F to 550°F.

Note: The upper and lower oven may have different preheat times.



To Set the Controls for Normal Baking:

1. Arrange interior oven racks.
2. Press **BAKE** pad, "--" will appear, "BAKE" will flash in the display.
3. Press  or  pad to set the desired temperature. The desired temperature will appear and "BAKE" continue flashing in the display.
4. Wait 5 seconds. "BAKE" will stop flashing, the oven icon and the actual oven temperature will appear in the display. A beep will sound once the oven temperature reaches the desired baking temperature.

5. Place food in oven

Pressing **STOP** pad will cancel the Bake feature at any time.

To Change the Oven Temperature after Baking has Started:

1. After the oven has already been set to bake and the oven temperature needs to be changed, press **BAKE** pad. The current setting will appear and "BAKE" start flashing in the display.
2. Press  or  pad to increase or decrease the set temperature.
3. Wait 5 seconds. "BAKE" will stop flashing and remain in the display. A beep will sound once the oven temperature reaches the desired baking temperature.



Note: If the oven was recently heated from prior cooking and has remained heated, the bake element symbol may not show in the display immediately and a chime will sound to show the temperature has already been reached.

Note: While the upper oven is preheating the convection fan will be activated to allow the oven to reach its target temperature faster and improved the heat distribution.

To Set Control for Continuous Bake or 12 Hour Energy Saving

The **TIMER SET/OFF** pad controls the Continuous Bake or 12 Hour Energy Saving Features. The oven control has a factory preset built-in 12 Hour Energy Saving feature that will shut off the oven if the oven control is left on for more than 11 hours and 59 minutes. The oven can be programmed to override this feature for Continuous Baking.

To set control for continuous baking:

1. Press and hold **TIMER SET/OFF** pad for 6 seconds. A beep will sound, "-- --" will appear and **TIMER** will flash in the display. After 6 seconds, "12h" or "- h" will appear in the display and the control will beep once.
2. Press  or  pad to switch between the 12 Hour Energy Saving and continuous bake features. Note: "12h" in the display indicates the control is set for the 12 Hour Energy Saving mode and "- h" indicates the control is set for the Continuous Bake feature.
3. Wait 5 seconds to accept the change (display will return to time of day) or press **STOP** pad to reject the change.

To Set Control for Oven Lockout

The **STOP** pad controls the Oven Lockout feature. The Oven Lockout feature automatically locks the oven doors and prevents the Oven from being turned on. It does not disable the clock, Kitchen Timer or the interior oven lights. The ovens can be locked individually.

To activate the Oven Lockout feature

Make sure the oven doors are closed. Press and hold **STOP** pad for 3 seconds. After 3 seconds a beep will sound, "DOOR", "LOCKED" will flash, "Loc" and  will appear in the display. Once the oven door is locked the "DOOR" and "LOCKED" indicator will stop flashing and remain in the display.

To reactivate normal oven operation





Press and hold **STOP** pad for 3 seconds. A beep will sound. The oven icon, "LOC" and  will disappear from the display. "DOOR" and "LOCKED" will flash in the display until the oven door has completely unlocked. The appliance is again fully operational. **Note:** Because you can set the oven lockout individually, one oven can be used when the other one is locked out.

Setting Oven Controls

To Set the Timed Bake Feature

The **COOK TIME** pad control the Timed Bake feature. Timed Bake allows the oven to be set to cook for a specific length of time and shut off automatically. The oven will shut off and will beep when the countdown is finished. This feature can be used with Bake and Convection (lower oven only) modes.

To Program the Oven to Begin Baking Immediately and To Shut Off Automatically (Timed Bake):

1. Be sure that the clock shows the correct time of day.
2. Arrange interior oven rack(s) and place the food in the oven.
3. Press **BAKE** pad, "BAKE" will flash and "- - -" will appear in the display.
4. Press  or  pad to set the desired temperature. "BAKE" will continue to flash and desired temperature will appear in the display.
5. Wait 5 seconds, "BAKE" stop flashing and remain in the display.
6. Press **COOK TIME** pad. "TIMED" start flashing and "-- --" will appear in the display.
7. Press the  or  pad until the desired baking time appears in the display.
Note: Baking time can be set for any amount of time between 1 minute to 11 hours and 59 minutes.
8. Wait 5 seconds, the display returns to the time of day.

Note: After the Timed Bake feature has been activated, press **COOK TIME** pad to display the bake time remaining in the Timed Bake mode. Once Timed Bake has started baking, a beep will sound when the oven temperature reaches the set temperature.

Press **STOP** pad when baking has finished or at any time to cancel the Timed Bake feature.





When the set bake time runs out:

1. "End" will appear in the display and the oven will shut off automatically.
2. The control will beep 3 times. The control will continue to beep 3 times every 30 seconds until **STOP** pad is pressed.

To Set the Delayed Bake Feature

The **DELAY START** pad control the Delayed Bake feature. The automatic timer of the Delayed Bake will turn the oven **ON** at the time you select in advance. **Note:** If your clock is set for normal 12 hour display mode the Delayed Bake or Delayed Convection cycle can never be set to start more than 12 hours in advance. If a 12-24 hours delay is needed, set the control for 24 hours time of day display mode.

To Program Oven for a Delayed Start Time:

1. Be sure that the clock is set with the correct time of day.
2. Arrange interior oven rack(s) and place the food in the oven.
3. Press **BAKE** pad. "BAKE" will flash and "- - -" will appear in the display.
4. Press  or  pad until the desired temperature appears. "BAKE" will continue to flash and the desired temperature will appear in the display.
5. Wait 5 seconds, "BAKE" will stop flashing and remain in the display and the current temperature is shown.
6. Press **DELAY START** pad. "DELAY" start flashing and "-- --" will appear in the display.
7. Press the  or  pad until the desired start time appears in the display.
8. Wait 5 seconds, the current time of day will appear in the display.

Note: If it is desired to have the oven shut off automatically after a set time; enter a **COOK TIME** at this step.

9. When the desired start time is reached, the oven icon will appear in the display and the oven will start to bake at the previously selected temperature.

Press **STOP** pad when baking has completed or at any time to cancel the Delayed Bake feature.

When the set bake time runs out:

1. "End" will appear in the display and the oven will shut off automatically.
2. The control will beep 3 times. The control will continue to beep 3 times every 30 seconds until **STOP** pad is pressed.

⚠ CAUTION Use caution with the Timed Bake and Delayed Start features. Foods that can easily spoil such as milk, eggs, fish, meat or poultry, should be chilled in the refrigerator first. Even when chilled, they should not stand in the oven for more than 1 hour before cooking begins, and should be removed promptly when cooking is completed.

Setting Oven Controls

Oven Baking

For best cooking results, heat the oven before baking cookies, breads, cakes, pies or pastries, etc. There is no need to preheat the oven for roasting meat or baking casseroles.

The cooking times and temperatures needed to bake a product may vary slightly from your previously owned appliance.

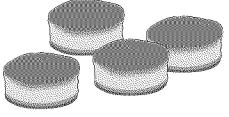
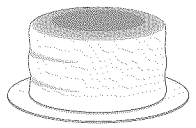
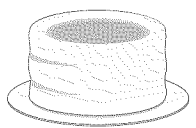
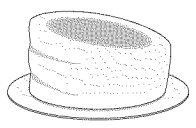
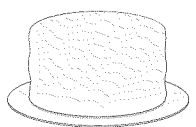
Baking Problems and Solutions Chart		
Baking Problems	Causes	Corrections
<p>Cookies and biscuits burn on the bottom.</p> 	<ul style="list-style-type: none"> • Cookies and biscuits put into the oven before the preheating time is completed. • Oven rack overcrowded. • Dark pan absorbs heat too fast. 	<ul style="list-style-type: none"> • Allow oven to preheat to the selected temperature before placing food in oven. • Choose pan sizes that will permit 5.1cm to 10.2cm (2" to 4") of air space on all sides when placed in the oven. • Use a medium-weight aluminum baking sheet.
<p>Cakes too dark on top or bottom.</p> 	<ul style="list-style-type: none"> • Cakes put into the oven before preheating time is completed. • Rack position too high or low. • Oven too hot. 	<ul style="list-style-type: none"> • Allow oven to preheat to the selected temperature before placing food in the oven. • Use proper rack position for baking needs. • Set oven temperature 25°F/12°C lower than recommended.
<p>Cakes not done in the center.</p> 	<ul style="list-style-type: none"> • Oven too hot. • Incorrect pan size. • Pan not centered in oven. 	<ul style="list-style-type: none"> • Set oven temperature 25°F/12°C lower than recommended. • Use pan size suggested in recipe. • Use proper rack position and place pan so there is 5.1cm to 10.2cm (2" to 4") of space on all sides of pan.
<p>Cakes not level.</p> 	<ul style="list-style-type: none"> • Range not level. • Pan too close to oven wall or rack overcrowded. • Pan warped. 	<ul style="list-style-type: none"> • Place a marked glass measuring cup filled with water on the center of the oven rack. If the water level is uneven, refer to the installation instructions for leveling the range. • Be sure to allow 5.1cm to 10.2cm (2" to 4") of clearance on all sides of each pan in the oven. • Do not use pans that are dented or warped.
<p>Foods not done when cooking time is up.</p> 	<ul style="list-style-type: none"> • Oven too cool. • Oven overcrowded. • Oven door opened too frequently. 	<ul style="list-style-type: none"> • Set oven temperature 25°F/12°C higher than suggested and bake for the recommended time. • Be sure to remove all pans from the oven except the ones to be used for baking. • Open oven door only after shortest recommended baking time.

Setting Oven Controls

Broil

Broiling is a method for cooking meat, fish, poultry and other food by direct heat under the broil element of the oven. Be sure you center your broiler pan directly under the broil element for best results. Arrange oven rack while oven is still cool, position the rack as needed.

Note: The broiler pan and insert are **not** supplied with this appliance. To purchase them, call Sears at 1-800-4-MY-HOME (1-800-469-4663) and order broiler pan kit 5304442087.

⚠ WARNING Should an oven fire occur, close the oven door and turn off the oven. If the fire continues, throw baking soda on the fire or use a fire extinguisher. **DO NOT** put water or flour on the fire. Flour may be explosive and water can cause a grease fire to spread and cause personal injury.

To set the oven to broil:

1. Arrange the interior oven rack.
2. Press **BROIL** pad. "---" will appear and "**BROIL**" will flash in the display.
3. Press **▲** or **▼** until the desired broiling temperature appears in the display.
4. Wait 5 seconds, "**BROIL**" will stop flashing and the oven icon will appear in the display. The oven will begin to broil. The desired temperature will stay in the display.
5. Preheat the broil element for 5 minutes.
6. Place your broiler pan insert on your broiler pan. Then place the food on the broiler pan insert. **DO NOT** use your broiler pan without the insert. **DO NOT** cover your broiler insert with foil. The exposed grease could ignite.
7. Place your broiler pan on the rack. Be sure to center your broiler pan directly under the broiler element. **Make sure the oven door is in the broil stop position.**
8. Broil on one side until food is browned; turn and cook on the second side. Season and serve. **Note:** Always pull the rack out to the stop position before turning or removing food.
9. To cancel broiling press **STOP** pad.

Note: The broil temperature setting may be changed at any time.

Preheating

Preheating the oven is suggested when searing rare steaks. (Remove your broiler pan before preheating. Foods will stick if placed on hot metal.) To preheat, set the control(s) to **BROIL** as instructed in the Owner's Guide. Wait for the element to become red-hot, usually about 5 minutes. Preheating is not necessary when broiling meats well-done.

Determine Broiling Times

Broiling times vary, so watch the food closely. Time not only depends on the distance from element, but on the thickness and aging of meat, fat content and doneness preferred. The first side usually requires a few minutes longer than second. Frozen meats also require additional time.

Broiler Clean-Up Tips (not supplied with appliance):

To make cleaning easier, line the bottom of the broiler pan with aluminum foil. **DO NOT** cover the broiler grid with foil. To prevent grease from baking on, remove the broiler pan from the oven as soon as cooking is completed. Use hot pads because the broiler pan is extremely hot. Pour off grease. Soak the pan in **HOT**, soapy water. Clean the broiler pan as soon as possible after each use. If necessary, use soap-filled steel wool pads. Heavy scouring may scratch the grid.

Not supplied
with appliance

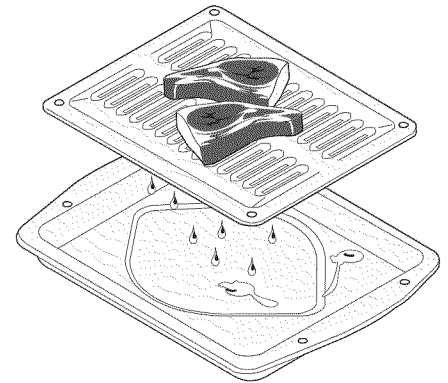

Note: Broiler pan and its insert allow dripping grease to drain and be kept away from the high heat of the broiler. **DO NOT** use the pan without its insert. **DO NOT** cover the insert with foil. The exposed grease could ignite.

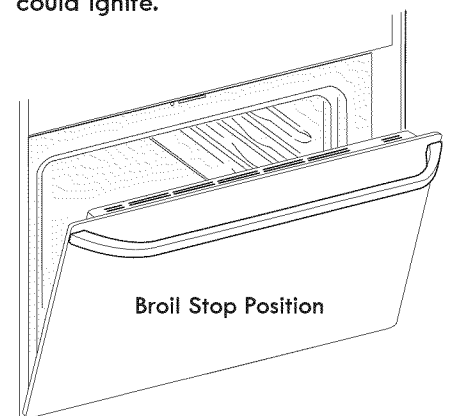

Setting Oven Controls

Setting the Warm & Hold™ Feature

The **Warm & Hold** pad turns ON the Serve Warm & Hold feature and will maintain an oven temperature of 170°F (76°C). The **Warm & Hold** feature will keep oven baked foods warm for serving up to 3 hours after cooking has finished. After 3 hours the **Warm & Hold** feature will shut the oven OFF automatically. The **Warm & Hold** feature may be used without any other cooking operations or can be used after cooking has finished using **TIMED BAKE** or **DELAY TIMED BAKE**. Do not use the **Warm & Hold** feature to heat cold food.

To set Warm & Hold:

1. Arrange interior oven racks and place food in oven.
2. Press **WARM & HOLD** pad. "WARM" will flash and "- -" will appear in the display.
Note: If no pad is touched within 25 seconds the request to turn ON Keep Warm feature will be cancelled.
3. Press the **▲** or **▼** pad, "WARM" will stop flashing, "Hld" and the oven icon will appear in the display.
4. To turn the Keep Warm OFF at any time press **STOP** pad.
Note: The Keep Warm feature will automatically turn OFF after 3 hours.

To set Warm & Hold to turn ON automatically:

1. Arrange interior oven racks and place food in oven. Set the oven properly for **Timed Bake** or **Delayed Timed Bake**.
2. Press **WARM & HOLD** pad. "WARM" will flash and "- -" will appear in the display.
Note: If no pad is touched within 25 seconds the request to turn ON the Keep Warm feature and all functions previously programmed will be cleared.
3. Press the **▲** or **▼** pad, "WARM" will stop flashing and remain in the display. Also temperature will appear in the display.
4. When the Time Bake has finished, the keep warm mode will turn ON automatically. The desired temperature, "BAKE" and "TIMED" will disappear. "Hld" will appear. The oven icon will remain in the display.
Note: The Keep Warm feature will automatically turn OFF after 3 hours.

Pressing **STOP** pad at any time will stop all oven baking operations.

Setting Convection- Upper Oven Only

The **CONV BAKE** pad controls the Convection feature. Use the Convection feature when cooking speed is desired. The oven can be programmed for Convection at any temperature between 170°F (77° C) to 550°F (288° C).

Convection uses a fan to circulate the oven's heat evenly and continuously within the oven. This improved heat distribution allows for fast, even cooking and browning results. It also gives better baking results when using 2 or 3 racks at the same time. Breads and pastries brown more evenly. Convection cooks most foods faster and more evenly than conventional baking.

Note: This feature is only available in the upper oven.

General Convection Instructions

1. When using Convection, check food at minimum cooktime.
2. Preheating is not necessary when cooking casseroles with Convection.
3. When using Convection with a single rack, place oven rack in position 2 or 3. If cooking on multiple racks, place the oven racks in positions 2 and 4.

To set the oven for Convection

1. Arrange interior oven racks.
2. Press **CONV BAKE** pad, "UPPER" and "BAKE" will flash and "- -" will appear in the display.
3. Press **▲** or **▼** pad to set the desired temperature. "UPPER" and "BAKE" will continue to flash and desired temperature will appear in the display.
4. Wait 5 seconds, "UPPER" and "BAKE" will stop flashing and remain in the display and the actual oven temperature will appear in the display. The convection fan icon will start spinning in the display. A beep will sound once the oven temperature reaches the desired baking temperature.
5. Place food in oven.

Note: The convection fan will start AS SOON AS the oven is set for Convection.

Press **STOP** to cancel Convection Bake at any time.

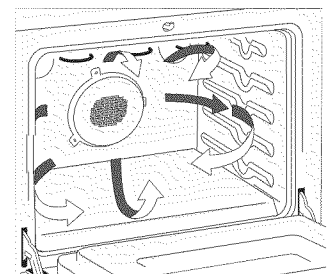

Air circulation during Convection



Setting Oven Controls

To Set the Sabbath Feature (for use on the Jewish Sabbath & Holidays)





The **COOK TIME** and **DELAY START** pads are used to set the Sabbath feature. The Sabbath feature may only be used with the **BAKE** pad. The oven temperature may be set higher or lower after setting the Sabbath feature (the oven temperature adjustment feature should be used only during Jewish Holidays), however the display will not visibly show or provide any audible tones indicating whether the change occurred correctly. Once the oven is properly set using Bake with the Sabbath feature active, the oven will remain continuously ON until cancelled. This will override the factory preset 12-Hour Energy Saving feature.

If the oven light will be needed during the Sabbath, press  before activating the Sabbath feature.

Once the oven light is turned ON and the Sabbath feature is active, the oven light will remain ON until the Sabbath feature is turned OFF. If the oven light needs to be OFF, be sure to turn the oven light OFF before activating the Sabbath feature.

IMPORTANT NOTES: It is not advised to attempt to activate any other program feature other than **BAKE** while the Sabbath feature is active. ONLY the following key pads will function after setting the Sabbath feature; , , **BAKE** & **STOP**. ALL OTHER KEYPADS will not function once the Sabbath feature is properly activated.

To Program the Oven to Begin Baking Immediately & activate the Sabbath feature:

1. Be sure that the clock is set with the correct time of day.
2. Place the food in the oven.
3. Press **BAKE**. "---" will appear, "BAKE" will flash in the display.
4. Press the  or  pad until the desired temperature appears. "BAKE" will flash in the display.
5. Wait 5 seconds, "BAKE" stop flashing, the oven icon and the actual oven temperature will appear in the display.
6. If you desire to set the oven control for a **Timed Bake** or **Delayed Start Bake** do so at this time. If not, skip this step and continue to step 8. Refer to the **Timed Bake** (complete steps 6-8)/ **Delayed Start Bake** (complete steps 6-8) section for complete instructions. Remember the oven will shut down after using **Timed Bake** or **Delayed Timed Bake** and therefore may only be used once during the Sabbath/Jewish Holidays. The maximum **Delayed Timed Bake** time is 11 hours & 59 minutes.
7. The oven will turn ON and begin heating.
8. Press and hold both the **COOK TIME** and **DELAY START** pads for at least 3 seconds. **SAb** will appear in the display. Once **SAb** appears in the display the oven control will no longer beep when a keypad is pressed or display any further changes. The oven is properly set for the Sabbath feature.
Note: You may change the oven temperature once baking has started by pressing **BAKE** pad, the  or  pads for the temperature you want (for Jewish Holidays only). Remember that the oven control will no longer beep when a keypad is pressed or display any further changes once the oven is set for the Sabbath feature.
9. The oven may be turned OFF at any time by first pressing **STOP** pad (this will turn the oven OFF).
10. To turn off the Sabbath mode, press and hold both the **COOK TIME** and **DELAY START** pads for at least 3 seconds.

Should you experience a power failure or interruption, the oven will shut off. When power is returned the oven will not turn back on automatically. If your food was nearly fully cooked, you may allow the trapped heat in the oven to finish the cooking process. Otherwise, you should remove the food when the power failure occurs, because you may only start the oven once during the Sabbath/Jewish Holidays. After the Sabbath observance turn OFF the Sabbath feature and the oven may be used with all normal functions.

After the Sabbath observance turn OFF the Sabbath feature by pressing **COOK TIME** and **DELAY START**. **SAb** will disappear from the display and the oven may be used with all normal functions.

For further assistance, guidelines for proper usage, and a complete list of models with the Sabbath feature, please visit the web at <http://www.star-k.org>.

Adjusting the Oven Temperature

Your oven thermostat has been precisely set at the factory. This setting may differ from your previous oven, however, so your recipe times may not give you the results you expect. If you think that the oven is cooking too hot or cool for your recipe times, you can adjust the thermostat so that the oven cooks hotter or cooler than the temperature displayed.

Note: Upper and lower oven can be adjusted independently.

To Adjust Oven Temperature:

1. Press and hold upper or lower oven **BAKE** pad for 6 seconds. The preset adjustment number will appear and "UPPER" or "LOWER" will flash in the display.
2. To increase the temperature use the **▲** pad to enter the desired change. The temperature may be increased as much as 35°F (19°C). To decrease the temperature use the **▼** pad to enter the desired change. The temperature may be decreased as much as 35°F (19°C).
3. Wait 5 seconds to accept the temperature change and the display will return to the time of day. Press **STOP** pad to reject the change if necessary.

Note: Oven temperature adjustment made will not change the Broil and the Self-Cleaning feature temperatures.

Self-Cleaning

CAUTION During the self-cleaning cycle, the outside of the oven can become very hot to the touch. **DO NOT** leave small children unattended near the appliance.

CAUTION The health of some birds is extremely sensitive to the fumes given off during the self-clean cycle of any wall oven. Move birds to another well ventilated room.

CAUTION **DO NOT** line the oven walls, racks, bottom or any other part of the appliance with aluminum foil. Doing so will destroy heat distribution, produce poor baking results and cause permanent damage to the interior (aluminum foil will melt to the interior surface of the oven).

CAUTION **DO NOT** force the oven door open. This can damage the automatic door locking system. Use caution when opening the door after the Self-Cleaning cycle is completed. The oven may still be **VERY HOT**.



Note: See additional cleaning information for the oven door in the **General Care & Cleaning** section.

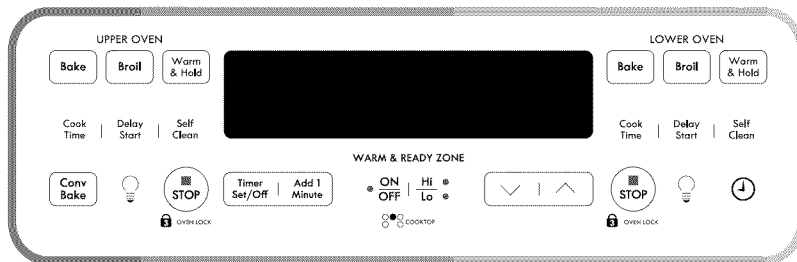

Self-Cleaning Oven

A Self-Cleaning oven cleans itself with high temperatures (well above cooking temperatures) which eliminate soils completely or reduces them to a fine powdered ash you can wipe away with a damp cloth.

Adhere to the following cleaning precautions:

- Allow the oven to cool before cleaning.
- Wear rubber gloves when cleaning any exterior parts of the oven manually.
- **DO NOT** use oven cleaners or oven protective coatings in or around any part of the oven interior.
- **DO NOT** clean the oven door gasket. The woven material of the oven door gasket is essential for a good seal. Care should be taken not to rub, damage or remove the gasket.
- **DO NOT** use any cleaning materials on the oven door gasket. Doing so could cause damage.
- **Remove all utensils and any aluminum foil. These items cannot withstand high cleaning temperatures.**
- Oven racks do not have to be removed, but remaining in the oven during the Self-Clean will turn them slightly blue and dull their finish. If left in, after the cycle is complete and the oven has cooled, rub the sides of the oven racks with wax paper or a cloth containing a small amount of salad oil (this will make the racks glide easier into the rack position).
- **Remove any excessive spillovers in the oven cavity before starting the Self-Cleaning cycle. To clean, use hot, soapy water and a cloth. Large spillovers can cause heavy smoke or fire when subjected to high temperatures. DO NOT allow food spills with a high sugar or acid content (such as milk, tomatoes, sauerkraut, fruit juices or pie filling) to remain on the surface as they may leave a dull spot even after cleaning.**
- Clean any soil from the oven frame, the door liner outside the oven door gasket and the small area at the front center of the oven bottom. These areas heat sufficiently to burn soil on. Clean with soap and water. **DO NOT** hand clean the oven door gasket.

NOTE: Prior to setting the Self-Clean cycle, any spills remaining on the oven bottom should be removed.

CAUTION The oven bake and broil elements may appear to have cooled after they have been turned OFF. The elements may still be hot and burns may occur if these elements are touched before they have cooled sufficiently.

Self-Cleaning

What to Expect during Cleaning

While the oven is in operation, the oven heats to temperatures much higher than those used in normal cooking. Sounds of metal expansion and contraction are normal. Odor is also normal as the food soil is being removed. Smoke may appear through the oven vent.





If heavy spillovers are not wiped up before cleaning, they may flame and cause more smoke and odor than usual. This is normal and safe and should not cause alarm. If available, use an exhaust fan during the self-cleaning cycle.

Self-Clean Cycle time length

For satisfactory results, use a 2 hour Self-Clean cycle for light soils and a 3 hour cycle for average or a 4 hour cycle for heavy soils. **NOTE:** The kitchen area should be well ventilated using an open window, ventilation fan or exhaust hood during the Self-Clean cycle. This will help eliminate the normal odors associated with the Self-Clean cycle.

To Set the Controls for a Self-Clean Cycle or a Delayed Start Self-Clean Cycle

(Note: If you do not want to set a Delayed Self-Clean Cycle, skip steps 2 & 3.)

1. Be sure that the clock is set with the correct time of day and the oven door is closed.
2. Press **DELAY START**. "DELAY" will flash.
3. Press and hold the  pad to scroll to the time to start the delayed Self-Clean cycle. Release the pad when the desired time is displayed.
4. Press **SELF CLEAN** or **FLEX CLEAN** (some models). "CLN - - -" appears in the display.
5. Press the  or  once. "3 00" appears in the display for a 3 hour cycle. To change to a 2 hour cycle press . "2 00" appears in the display or to select a 4 hour cycle press . "4 00" appears in the display.
As soon as the controls are set, the motor driven lock will begin to close automatically and the "DOOR" and "LOCKED" indicator light will appear. **DO NOT** open the oven door while the light is flashing (it takes about 15 seconds for the oven door to lock).
6. "CLn" will appear in the display during the Self-Clean cycle and the "DOOR" and "LOCKED" light will glow until the Self-Cleaning cycle is complete or cancelled and the oven temperature has cooled.

When the Self-Clean Cycle is Completed

1. The time of day or "Hot" will appear in the display window and the "Clean" and "DOOR" and "LOCKED" light will continue to glow.
2. Once the oven has cooled down for about 1 HOUR and the "DOOR" and "LOCKED" light has gone out, the oven door can be opened.

NOTE: When the oven is cool, wipe away any residue or powdered ash with a damp cloth or paper towel.

Stopping or Interrupting a Self-Cleaning Cycle

If it becomes necessary to stop or interrupt a Self-Cleaning cycle:

1. Press **STOP**.
2. The time of day or "Hot" will appear in the display window, "DOOR" and "LOCKED" light will continue to glow.
3. Once the oven has cooled down for about 1 HOUR and the "DOOR" and "LOCKED" light has gone out, the oven door can be opened.
4. Restart the Self-Clean cycle once all conditions have been corrected.

⚠ CAUTION To avoid possible burns use care when opening the oven door after the Self-Cleaning cycle. Stand to the side of the oven when opening the door to allow hot air or steam to escape.

⚠ CAUTION **DO NOT** force the oven door open. This can damage the automatic door locking system. Use caution and avoid possible burns when opening the door after the Self-Cleaning cycle has completed. The oven may still be VERY HOT.

General Care & Cleaning

Cleaning Various Parts of Your Oven

Before cleaning any part of the oven, be sure all controls are turned OFF and the oven is COOL. REMOVE SPILLOVERS AND HEAVY SOILING AS SOON AS POSSIBLE. REGULAR CLEANINGS NOW WILL REDUCE THE EXTENT AND DIFFICULTY OF MAJOR CLEANING LATER.

Surfaces	How to Clean
Aluminum (Trim Pieces) & Vinyl	<p>Use hot, soapy water and a cloth. Dry with a clean cloth. Do not scour or use all-purpose cleaners, ammonia, powdered cleaners or commercial oven cleaner. They can scratch and discolor aluminum.</p> <p>Before cleaning the control panel, turn all controls to OFF and remove the control knobs. To remove, pull each knob straight off the shaft. Clean using hot, soapy water and a dishcloth. Rinse with a clean water using a dishcloth. Be sure to squeeze excess water from the cloth before wiping the panel; especially when wiping around the controls. Excess water in or around the controls may cause damage to the appliance. To replace knobs after cleaning, line up the flat sides of both the knob and the shaft; then push the knob into place.</p>
Painted and Plastic Control Panel, Body Parts, and Decorative Trim	<p>For general cleaning, use hot, soapy water and a cloth. For more difficult soils and built-up grease, apply a liquid detergent directly onto the soil. Leave on soil for 30 to 60 minutes. Rinse with a damp cloth and dry. DO NOT use abrasive cleaners on any of these materials; they can scratch.</p> <p>To remove control knobs, turn to the OFF position; grasp firmly and pull straight off the shaft. To replace knobs after cleaning, line up the flat sides of both the knob and the shaft; then push the knob into place.</p>
Stainless Steel, Chrome Control Panel, Decorative Trim	<p>Clean stainless steel with hot, soapy water and a dishcloth. Rinse with clean water and a cloth. Do not use cleaners with high concentrations of chlorides or chlorines. Do not use harsh scrubbing cleaners. Only use kitchen cleaners that are especially made for cleaning stainless steel. Always be sure to rinse the cleaners from the surface as bluish stains may occur during heating that cannot be removed.</p>
Porcelain Enamel Broiler Pan and Insert (some models), Door Liner, Body Parts	<p>Gentle scouring with a soapy scouring pad will remove most spots. Rinse with a 1:1 solution of clear water and ammonia. If necessary, cover difficult spots with an ammonia-soaked paper towel for 30 to 40 minutes. Rinse with clean water and a damp cloth, and then scrub with a soap-filled scouring pad. Rinse and wipe dry with a clean cloth. Remove all cleaners or the porcelain may become damaged during future heating. DO NOT use spray oven cleaners on the cooktop.</p>
Oven Racks	<p>This range comes with lubricated porcelain oven racks, which can remain in the oven during the self-clean cycle. Do not clean this vegetable oil lubrication off the racks. It is important that the sides of the oven racks always have a light coating of vegetable oil. To maintain optimal rack performance, re-apply a thin layer of vegetable oil to the sides of the rack after every self-clean cycle or when the rack becomes difficult to slide.</p>
Oven Door	<p>Use soap & water to thoroughly clean the top, sides and front of the oven door. Rinse well. You may use a glass cleaner on the outside glass of the oven door. DO NOT immerse the door in water. DO NOT spray or allow water or the glass cleaner to enter the door vents.</p> <p>DO NOT clean the oven door gasket. The oven door gasket is made of a woven material, on Self-Cleaning models, which is essential for a good seal. Care should be taken not to rub, damage or remove this gasket.</p>

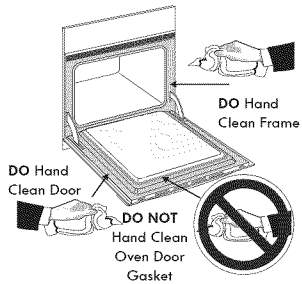
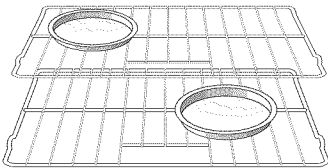

General Care & Cleaning

Ceramic Glass Cooktop Cleaning & Maintenance

IMPORTANT Consistent and proper cleaning is essential to maintaining your Ceramic glass cooktop.

Prior to using your cooktop for the first time, apply the recommended CookTop® Cleaning Creme to the ceramic surface (on the web visit www.sears.com for replacement cooktop cleaner, item number 40079). Buff with a **non-abrasive** cloth or **no-scratch** cleaning pad. This will make cleaning easier when soiled from cooking. The special cooktop cleaning cream leaves a protective finish on the glass to help prevent scratches and abrasions.

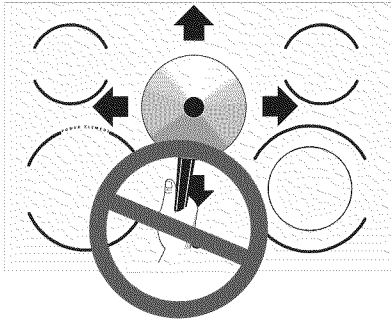

Sliding aluminum or copper clad bottom pans on the cooktop can cause metal markings on the cooktop surface. These marks should be removed **immediately** after the cooktop has cooled using the cooktop cleaning cream. Metal marks can become permanent if not removed prior to future use.

Cookware (cast iron, metal, ceramic or glass) with rough bottoms can mark or scratch the cooktop surface. **Do not slide anything metal or glass** across the cooktop. **Do not** use your cooktop as a cutting board or work surface in the kitchen. **Do not** cook foods directly on the cooktop surface without a pan. **Do not** drop heavy or hard objects on the glass cooktop, because they may cause it to crack.

Cleaning Recommendations for the Ceramic Glass Cooktop

CAUTION Before cleaning the cooktop, be sure the controls are turned to **OFF** and the cooktop is **COOL**.

WARNING **DO NOT** use a cooktop cleaner on a hot cooktop. The fumes can be hazardous to your health, and can chemically damage the ceramic glass surface.

For light to moderate soil:

Apply a few drops of CookTop® Cleaning Creme directly to the cooktop. Use a paper towel or use a **non-abrasive** plastic type **no-scratch** pad to clean the entire cooktop surface. Make sure the cooktop is cleaned thoroughly, leaving no residue.

For heavy, burned on soil:

Apply a few drops of CookTop® Cleaning Creme directly to the soiled area. Rub the soiled area using a **non-abrasive** plastic type **no-scratch** pad, applying pressure as needed. Do not use the pad you use to clean the cooktop for any other purpose. If soils remain, carefully scrape soils with a metal razor blade scraper, holding scraper at a 30 degree angle to the surface. Remove loosened soils, then apply a few drops of cleaning cream and buff surface clean.

IMPORTANT NOTE: Damage to the ceramic glass cooktop may occur if you use an abrasive type scratch pad. Only use cleaning products that have been specifically designed for ceramic glass cooktop.

Plastic or foods with a high sugar content:

These types of soils need be removed immediately if spilled or melted onto the ceramic cooktop surface. Permanent damage (such as pitting of the cooktop surface) may occur if not removed **immediately**. After turning the surface elements **OFF**, use a razor blade scraper or a metal spatula with a mitt and scrape the soil from the hot surface (as illustrated).

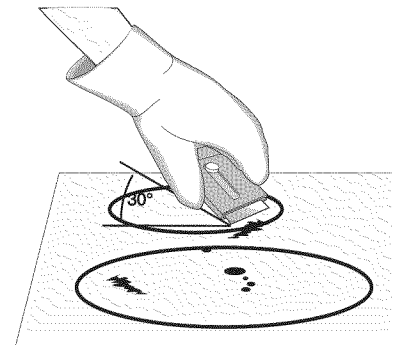

General Care & Cleaning

Ceramic Glass Cooktop Cleaning & Maintenance

Do not use the following on the ceramic glass cooktop:

- Do not use abrasive cleaners and scouring pads, such as metal and some nylon pads. They may scratch the cooktop, making it more difficult to clean.
- Do not use harsh cleaners, such as chlorine bleach, ammonia or oven cleaners, as they may etch or discolor the cooktop.
- Do not use dirty sponges, cloths or paper towels, as they can leave soil or lint on the cooktop which can burn and cause discoloration.

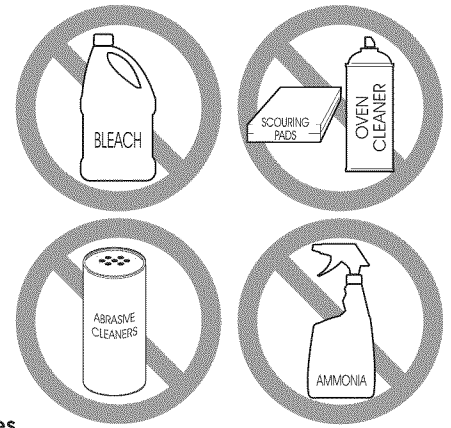

Special Caution for Aluminum Foil and Aluminum Cooking Utensils

- **Aluminum foil**
Use of aluminum foil will damage the cooktop. Do not use under any circumstances.
- **Aluminum utensils**
Since the melting point of aluminum is much lower than that of other metals, care must be taken when aluminum pots or pans are used. Pans that boil dry may permanently damage cooktop by breaking, fusing to, or marking it.

Care and Cleaning of Stainless Steel (Stainless Steel models only)

Some models are equipped with stainless steel exterior parts. Special care and cleaning are **required** for maintaining the appearance of stainless parts. Please refer to the table provided at the beginning of the **General Care & Cleaning** section in this Use & Care Guide.

Changing the Oven Light

On some models an interior oven light will turn on automatically when the oven door is opened. The oven light may be turned on when the door is closed by pushing  located on the control panel. On some models, the lamp is covered with a glass shield held in place by a wire holder. **THE GLASS SHIELD MUST BE IN PLACE WHENEVER THE OVEN IS IN USE.**

To replace the light bulb:

CAUTION: BE SURE THE OVEN IS COOL.

1. Turn the power off at the main source.
2. Wear a leather-faced glove for protection against possible broken glass.
3. Replace bulb with 40-watt appliance bulb only.
4. For models with glass shield, press holder on one side to release glass shield, change bulb and be sure to replace the glass shield.

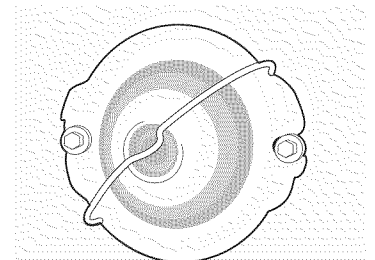

General Care & Cleaning

Door Hinge locations with oven door fully open

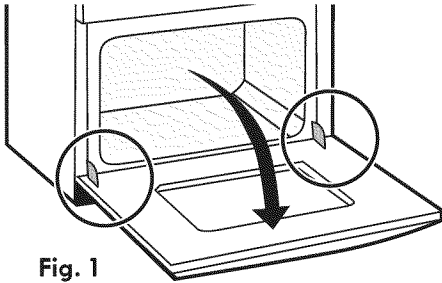

Fig. 1

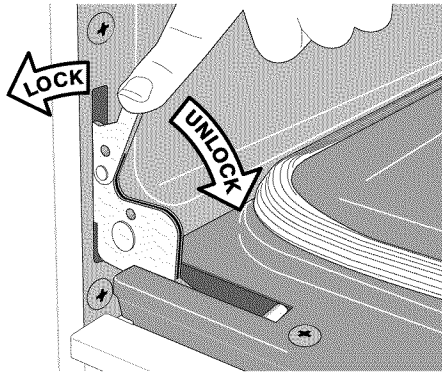

Fig. 2

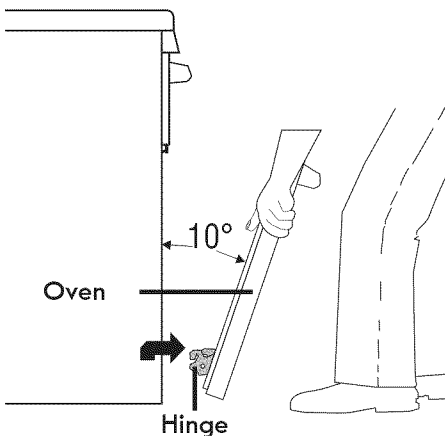

Fig. 3

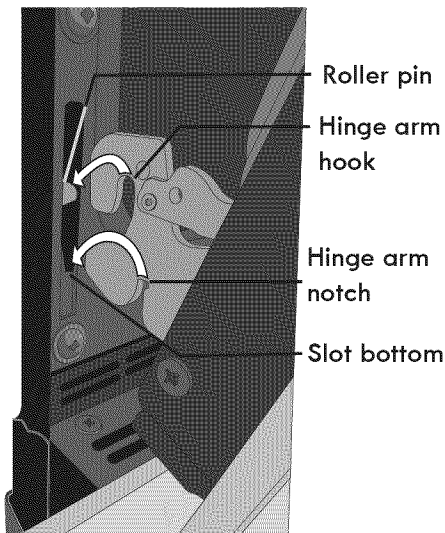

Fig. 4

Removing and Replacing the Lower Oven Lift-Off Door

CAUTION The door is heavy. For safe, temporary storage, lay the door flat with the inside of the door facing down.

To Remove Oven Door:

1. Open oven door completely (horizontal with floor - See Fig. 1).
2. Pull the door hinge locks on both left and right door hinges down from the oven frame completely towards the oven door (See Fig. 2). A tool such as a small flat-blade screwdriver may be required.
3. Firmly grasp both sides of oven door along the door sides (Do not use the oven door handle - See Fig. 3).
4. Close the door to the broil stop position (the oven door will stop into this position just before fully closing).
5. With the oven door in the broil stop position, lift the oven door hinge arms over the roller pins located on each side of the oven frame (See Fig. 4).

To Replace Oven Door:

1. Firmly grasp both sides of oven door along the door sides (Do not use the oven door handle - See Fig. 3).
2. Holding the oven door at the same angle as the removal position, seat the hook of the hinge arm over the roller pins located on each side of the oven door frame (See Fig. 4). The hook of the hinge arms must be fully seated onto the roller pins.
3. Fully open the oven door (horizontal with floor - See Fig. 1).
4. Push the door hinge locks up towards and into the oven frame on both left and right oven door hinges (See Fig. 2) to the locked position.
5. Close the oven door.

Special Door Care Instructions - Most oven doors contain glass that can break.

Read the following recommendations:

1. Do not close the oven door until all the oven racks are fully in place.
2. Do not hit the glass with pots, pans, or any other object.
3. Scratching, hitting, jarring or stressing the glass may weaken its structure causing an increased risk of breakage at a later time.

Before You Call

Solutions to Common Problems

Before you call for service, review this list. It may save you time and expense. The list includes common occurrences that are not the result of defective workmanship or materials in this appliance.

OCCURRENCE	POSSIBLE CAUSE/SOLUTION
Oven Control Beeps and Displays any F code error (ex.: F11).	Electronic control has detected a fault condition. Press STOP/CLEAR to clear the display and stop the beeping. Reprogram the oven. If a fault reoccurs, record the fault number. Press STOP/CLEAR and call Sears or another qualified servicer.
"d-O" is displayed.	The door was left open and controls set for self-cleaning cycle. Close the door and push STOP pad .
Faulty installation. Bad cooking results. Range not leveled.	1- Place oven rack in center of oven. 2- Place a level or a marked glass measuring cup filled with water on the center of the oven rack. 3- If the water level is uneven, adjust the leveling legs of the unit (refer to the installation instructions for leveling the range). 4- If the level is still uneven, contact an installing agent to adjust the cabinet cutout flooring. Kitchen cabinet misalignment may make oven appear to be not level. Be sure cabinets are square and level. Contact cabinet maker to correct problem.
Surface unit does not heat.	No power to the appliance. Check steps under "Entire Range or Oven Does Not Operate" in this Before you Call checklist. Incorrect control setting. Make sure the correct control is on for the surface unit to be used.
Surface units too hot or not hot enough.	Incorrect control setting. Make sure the correct control is on for the surface unit to be used. Lightweight or warped pans used. Use only flat, evenly balanced, medium or heavyweight cookware. Flat pans heat better than warped pans. Cookware materials and weight of the material affect heating. Heavy- and medium-weight pans heat evenly. Because lightweight pans heat unevenly, foods may burn easily.
Metalmarks.	Sliding or scraping of metal utensils on cooktop surface. Do not slide metal utensils on cooktop surface. Use a ceramic-glass cooktop cleaning cream to remove the marks. "Cooktop Cleaning - Ceramic Glass Cooktop Models" section under General Cleaning.
Scratches or abrasions on cooktop surface.	Coarse particles such as salt or sand between cooktop and utensils can cause scratches. Be sure cooktop surface and bottoms of utensils are clean before usage. Small scratches do not affect cooking and will become less visible with time. Cleaning materials not recommended for ceramic-glass cooktop have been used. See "Cooktop Cleaning - Ceramic Glass Cooktop Models" section under General Cleaning. Cookware with rough bottom has been used. Use smooth, flat-bottomed cookware.
Brown streaks or specks.	Boilovers are cooked onto surface. Use razor blade scraper to remove soil. "Cooktop Cleaning - Ceramic Glass Cooktop Models" section under General Cleaning.
Areas of discoloration with metallic sheen.	Mineral deposits from water and food. Remove using a ceramic-glass cooktop cleaning cream. Use cookware with clean, dry bottoms.
Entire oven does not operate.	When the oven is first plugged in, or when the power supply to the oven has been interrupted, the display will flash. The oven cannot be programmed until the clock is set. Be sure electrical cord is securely connected into the electrical junction box. Cord/plug is not installed and/or connected. Cord is not supplied with oven. Contact Sears or another qualified servicer. Service wiring not complete. Contact Sears or another qualified servicer. Power outage. Check house lights to be sure. Call your local electric company. Short in cord/plug. Replace cord/plug. Controls are not set properly. See instructions under Setting Oven Controls to set the controls. House fuse has blown or circuit breaker has tripped immediately following installation. House fuse may not be fully engaged. Check fuse and screw or engage circuit breaker securely. House fuse has blown or circuit breaker has tripped after the oven has been installed and previously operating. Call Sears or another qualified servicer.

Before You Call

Solutions to Common Problems

OCCURRENCE	POSSIBLE CAUSE/SOLUTION
Oven smokes excessively during broiling.	Oven door is closed. Door should be open during broiling.
	Meat too close to the broiler unit. Reposition the rack to provide more clearance between the meat and the broiler. Preheat broil element for quick searing operation.
	Meat not properly prepared. Remove excess fat from meat. Slash remaining fatty edges to prevent curling, but do not cut into the lean.
	Grid on broiler pan wrong side-up. Grease does not drain into broiler pan. Always place the grid on the broiler pan with the ribs up and the slots down to allow grease to drip into the pan.
	Broiler pan used without grid or grid cover with foil. DO NOT use the broiler pan without the grid or cover the grid with foil.
	Oven needs to be cleaned. Grease has built up on oven surfaces. Regular cleaning is necessary when broiling frequently. Old grease or food spatters cause excessive smoking.
Poor baking results.	Many factors affect baking results. See Baking for hints, causes and corrections. See Adjusting Oven Temperature .
Oven light does not work.	Burned-out or loose bulb. Follow the instructions under Changing Oven Light to replace or tighten the bulb.
Fan noise during cooking operation.	A cooling fan may automatically turn on and off to cool internal parts. This is normal, and the fan may continue to run even after oven is turned off.
Self-cleaning cycle does not work.	Make sure the oven door is closed.
	Controls not set properly. Follow instructions.
	Self-cleaning cycle was interrupted. Stop time must be set 2-4 hours past the start time. Follow steps under "Stopping or Interrupting a Self-Cleaning Cycle" in this Use & Care Guide.
Soil not completely removed after self-cleaning cycle is completed.	Failure to clean bottom, from top of oven, frame of oven or door area outside oven seal. These areas are not in the self-cleaning area, but get not enough to burn on residue. Clean these areas before the self-cleaning cycle is started. Burned on residue can be cleaned with a stiff nylon brush and water or a nylon scrubber. Be careful not to damage the oven gasket.
	Excessive spillovers in oven. Set the self-clean cycle for longer cleaning time.
Flames inside oven or smoke from vent.	Excessive spillovers in oven. This is normal, especially for high oven temperatures, pie spillovers or for large amounts of grease on bottom of oven. Wipe up excessive spillovers.

PROTECTION AGREEMENTS

Master Protection Agreements

Congratulations on making a smart purchase. Your new Kenmore® product is designed and manufactured for years of dependable operation. But like all products, it may require preventive maintenance or repair from time to time. That's when having a Master Protection Agreement can save you money and aggravation.

The Master Protection Agreement also helps extend the life of your new product. Here's what the Agreement* includes:

- Parts and labor** needed to help keep products operating properly **under normal use**, not just defects. Our coverage goes **well beyond the product warranty**. No deductibles, no functional failure excluded from coverage – **real protection**.
- Expert service** by a force of more than **10,000 authorized Sears service technicians**, which means someone you can trust will be working on your product.
- Unlimited service calls and nationwide service**, as often as you want us, whenever you want us.
- «No-lemon» guarantee** – replacement of your covered product if four or more product failures occur within twelve months.
- Product replacement** if your covered product can't be fixed.
- Annual Preventive Maintenance Check** at your request – no extra charge.
- Fast help by phone** – we call it **Rapid Resolution** – phone support from a Sears representative on all products. Think of us as a «talking owner's manual».
- Power surge protection** against electrical damage due to power fluctuations.
- \$250 Food Loss Protection** annually for any food spoilage that is the result of mechanical failure of any covered refrigerator or freezer.
- Rental reimbursement** if repair of your covered product takes longer than promised.
- 10% discount** off the regular price of any non-covered repair service and related installed parts.

Once you purchase the Agreement, a simple phone call is all that it takes for you to schedule service. You can call anytime day or night, or schedule a service appointment online.

The Master Protection Agreement is a risk free purchase. If you cancel for any reason during the product warranty period, we will provide a full refund. Or, a prorated refund anytime after the product warranty period expires. Purchase your Master Protection Agreement today!

Some limitations and exclusions apply. For prices and additional information in the U.S.A. call 1-800-827-6655.

* Coverage in Canada varies on some items. For full details call Sears Canada at 1-800-361-6665.

Sears Installation Service

For Sears professional installation of home appliances, garage door openers, water heaters, and other major home items, in the U.S.A. or Canada call 1-800-4-MY-HOME®.

Acuerdos maestros de protección

Enhorabuena por haber hecho una compra inteligente. Su nuevo producto Kenmore® está diseñado y fabricado para brindarle años de funcionamiento fiable. Pero, como cualquier producto, puede necesitar mantenimiento preventivo o reparaciones periódicas. Es por eso que tener un Acuerdo maestro de protección podría ahorrarle dinero y molestias.

El Acuerdo maestro de protección también sirve para prolongar la durabilidad de su nuevo producto. El acuerdo* incluye lo siguiente:

- Piezas y mano de obra** necesarias para contribuir a mantener el funcionamiento adecuado de los productos **utilizados en condiciones normales de uso**, no sólo en caso de defectos de los productos. Nuestra cobertura va **mucho más allá que la garantía del producto**. No se aplican deducibles ni exclusiones por fallas del funcionamiento: es decir, **verdadera protección**.
- Servicio técnico por expertos** (más de **10000 técnicos autorizados de Sears**), lo cual significa que quien repare o realice el mantenimiento de su producto será un profesional de confianza.
- Servicio técnico a escala nacional y número ilimitado de llamadas de solicitud de servicio técnico**: se puede poner en contacto con nosotros cuantas veces lo desee y cuando lo desee.
- Garantía «sin sorpresas»**: se reemplaza el producto cubierto por el acuerdo si ocurren cuatro o más fallas del producto en un periodo de 12 meses.
- Reemplazo del producto**: en caso de que no se pueda reparar el producto cubierto por el acuerdo.
- Revisión anual preventiva de mantenimiento del producto**: puede solicitarla en cualquier momento, sin costo alguno.
- Rápida asistencia telefónica**, la cual denominamos **Solución rápida**: es decir, asistencia telefónica a través de cualquiera de nuestros representantes de Sears, sobre cualquiera de nuestros productos. Piense en nosotros como en un «manual parlante del usuario».
- Protección contra fallas eléctricas**, contra daños debidos a fluctuaciones de la corriente eléctrica.
- \$250 al año para cubrir cualquier posible deterioro de alimentos** que haya tenido que desechar debido a una falla mecánica de cualquiera de nuestros refrigeradores o congeladores cubiertos por este acuerdo.
- Devolución de gastos de alquiler de electrodomésticos** si la reparación de su producto asegurado toma más que el tiempo prometido.
- 10% de descuento** aplicable tanto a los costos del servicio de reparación, como de las piezas instaladas relacionadas que no hayan quedado cubiertos por este acuerdo.

Una vez que haya realizado el pago de este acuerdo, bastará una simple llamada telefónica para concertar una visita de servicio. Puede llamar a cualquier hora del día o de la noche, o bien concertar una visita de servicio por Internet.

La adquisición del Acuerdo maestro de protección es una inversión exenta de riesgos. Si por cualquier motivo decide cancelar dicho acuerdo durante el periodo de garantía del producto, le haremos un reintegro total del valor. O bien un importe proporcional si cancela el acuerdo en cualquier otro momento posterior al vencimiento del periodo de garantía del producto. ¡Adquiera hoy mismo su Acuerdo maestro de protección!

Algunas limitaciones y exclusiones podrían aplicarse. Para solicitar precios e información adicional, llame al 1-800-827-6655 (en los EE.UU.).

* La cobertura en Canadá varía en el caso de algunos artículos. Para obtener detalles completos al respecto, llame al 1-800-361-6665 de Sears de Canadá.

Servicio de instalación de Sears

Para solicitar la instalación por profesionales de Sears de electrodomésticos, abridores de puertas de garaje, calentadores de agua y otros artículos de uso prioritario en el hogar, llame al 1-800-4-MY-HOME en los EE.UU. o Canadá.

Get it fixed, at your home or ours!

Your Home

For troubleshooting, product manuals and expert advice:



www.managemylife.com

For repair – **in your home** – of **all** major brand appliances, lawn and garden equipment, or heating and cooling systems, **no matter who made it, no matter who sold it!**

For the replacement parts, accessories and owner's manuals that you need to do-it-yourself.

For Sears professional installation of home appliances and items like garage door openers and water heaters.

1-800-4-MY-HOME[®] (1-800-469-4663)

Call anytime, day or night (U.S.A. and Canada)

www.sears.com www.sears.ca

Our Home

For repair of carry-in items like vacuums, lawn equipment, and electronics, call anytime for the location of your nearest

Sears Parts & Repair Service Center

1-800-488-1222 (U.S.A.)

www.sears.com

1-800-469-4663 (Canada)

www.sears.ca

To purchase a protection agreement on a product serviced by Sears:

1-800-827-6655 (U.S.A.)

1-800-361-6665 (Canada)

Para pedir servicio de reparación a domicilio, y para ordenar piezas:

1-888-SU-HOGAR[®]

(1-888-784-6427)

www.sears.com

Au Canada pour service en français:

1-800-LE-FOYER^{MC}

(1-800-533-6937)

www.sears.ca

The Sears logo, consisting of the word "sears" in a lowercase, serif font.

® Registered Trademark / TM Trademark of KCD IP, LLC in the United States, or Sears Brands, LLC in other countries

® Marca Registrada / TM Marca de Fábrica de KCD IP, LLC en Estados Unidos, o Sears Brands, LLC in otros países

^{MC} Marque de commerce / ^{MD} Marque déposée de Sears Brands, LLC