



OWNER'S MANUAL

300 W SMART SOUND BAR

Please read this manual carefully before operating your set and retain it for future reference.

NB3730A (NB3730A, S33A1-D)

NB3732A (NB3732A, S33A1-D)

Safety Information



CAUTION: TO REDUCE THE RISK OF ELECTRIC SHOCK DO NOT REMOVE COVER (OR BACK) NO USER-SERVICEABLE PARTS INSIDE REFER SERVICING TO QUALIFIED SERVICE PERSONNEL.

This lightning flash with arrowhead symbol within an equilateral triangle is intended to alert the user to the presence of uninsulated dangerous voltage within the product's enclosure that may be of sufficient magnitude to constitute a risk of electric shock to persons.



The exclamation point within an equilateral triangle is intended to alert the user to the presence of important operating and maintenance (servicing) instructions in the literature accompanying the product.



WARNING: This product contains chemicals known to the State of California to cause cancer and birth defects or other reproductive harm. *Wash hands after handling.*

WARNING: TO PREVENT FIRE OR ELECTRIC SHOCK HAZARD, DO NOT EXPOSE THIS PRODUCT TO RAIN OR MOISTURE.

CAUTION: The apparatus shall not be exposed to water (dripping or splashing) and no objects filled with liquids, such as vases, shall be placed on the apparatus.

WARNING: Do not install this equipment in a confined space such as a book case or similar unit.

CAUTION: Do not block any ventilation openings. Install in accordance with the manufacturer's instructions.

Slots and openings in the cabinet are provided for ventilation and to ensure reliable operation of the product and to protect it from over heating. The openings shall be never be blocked by placing the product on a bed, sofa, rug or other similar surface. This product shall not be placed in a built-in installation such as a bookcase or rack unless proper ventilation is provided or the manufacturer's instruction has been adhered to.

CAUTION concerning the Power Cord

Most appliances recommend they be placed upon a dedicated circuit;

That is, a single outlet circuit which powers only that appliance and has no additional outlets or branch circuits. Check the specification page of this owner's manual to be certain. Do not overload wall outlets. Overloaded wall outlets, loose or damaged wall outlets, extension cords, frayed power cords, or damaged or cracked wire insulation are dangerous. Any of these conditions could result in electric shock or fire. Periodically examine the cord of your appliance, and if its appearance indicates damage or deterioration, unplug it, discontinue use of the appliance, and have the cord replaced with an exact replacement part by an authorized service center. Protect the power cord from physical or mechanical abuse, such as being twisted, kinked, pinched, closed in a door, or walked upon. Pay particular attention to plugs, wall outlets, and the point where the cord exits the appliance. To disconnect power from the mains, pull out the mains cord plug. When installing the product, ensure that the plug is easily accessible.

This device is equipped with a portable battery or accumulator.

Safety way to remove the battery from the equipment: Remove the old battery or battery pack, follow the steps in reverse order than the assembly. To prevent contamination of the environment and bring on possible threat to human and animal health, the old battery or the battery put it in the appropriate container at designated collection points. Do not dispose of batteries or battery together with other waste. It is recommended that you use local, free reimbursement systems batteries and accumulators. The battery should not be exposed to excessive heat such as sunshine, fire or the like.

IMPORTANT SAFETY INSTRUCTIONS

1. Read these instructions.
2. Keep these instructions.
3. Heed all warnings.
4. Follow all instructions.
5. Do not use this apparatus near water.
6. Clean only with dry cloth.
7. Do not block any ventilation openings. Install in accordance with the manufacturer's instructions.
8. Do not install near any heat sources such as radiators, heat registers, stoves, or other apparatus (including amplifiers) that produce heat.
9. Do not defeat the safety purpose of the polarized or grounding-type plug. A polarized plug has two blades with one wider than the other. A grounding type plug has two blades and a third grounding prong. The wide blade or the third prong are provided for your safety. If the provided plug does not fit into your outlet, consult an electrician for replacement of the obsolete outlet.
10. Protect the power cord from being walked on or pinched particularly at plugs, convenience receptacles, and the point where they exit from the apparatus.
11. Only use attachments/accessories specified by the manufacturer.
12. Use only with the cart, stand, tripod, bracket, or table specified by the manufacturer, or sold with the apparatus. When a cart is used, use caution when moving the cart/apparatus combination to avoid injury from tip-over.



13. Unplug this apparatus during lightning storms or when unused for long periods of time.
14. Refer all servicing to qualified service personnel. Servicing is required when the apparatus has been damaged in any way, such as power-supply cord or plug is damaged, liquid has been spilled or objects have fallen into the apparatus, the apparatus has been exposed to rain or moisture, does not operate normally, or has been dropped.

FCC Compliance Statement

This device complies with part 15 of the FCC rules. Operation is subject to the following two conditions:

- (1) This device may not cause harmful interference, and
- (2) This device must accept any interference received, including interference that may cause undesired operation.

NOTE: This equipment has been tested and found to comply with the limits for a Class B digital device, pursuant to Part 15 of the FCC Rules. These limits are designed to provide reasonable protection against harmful interference in a residential installation. This equipment generates, uses, and can radiate radio frequency energy and, if not installed and used in accordance with the instructions, may cause harmful interference to radio communications. However, there is no guarantee that interference will not occur in a particular installation.

If this equipment does cause harmful interference to radio or television reception, which can be determined by turning the equipment off and on, the user is encouraged to try to correct the interference by one or more of the following measures:

- Reorient or relocate the receiving antenna.
- Increase the separation between the equipment and receiver.
- Connect the equipment into an outlet on a circuit different from that to which the receiver is connected.
- Consult the dealer or an experienced radio/TV technician for help.

CAUTION: Any changes or modifications not expressly approved by the party responsible for compliance could void the user's authority to operate this equipment.

FCC RF Radiation Exposure Statement : This equipment complies with FCC radiation exposure limits set forth for an uncontrolled environment. This equipment should be installed and operated with minimum distance 20 cm between the radiator and your body. End users must follow the specific operating instructions for satisfying RF exposure compliance. This transmitter must not be co-located or operating in conjunction with any other antenna or transmitter.

FCC Radio Frequency Interference Requirements

This device is restricted to indoor use due to its operation in the 5.15 to 5.25 GHz frequency range. FCC requires this product to be used indoors for the frequency range 5.15 to 5.25 GHz to reduce the potential for harmful interference to co-channel Mobile Satellite systems. High power radars are allocated as primary users of the 5.25 to 5.35 GHz and 5.65 to 5.85 GHz bands. These radar stations can cause interference with and/or damage this device. This device cannot be co-located with any other transmitter.

CAUTION: Regulations of the FCC and FAA prohibit airborne operation of radio-frequency wireless devices because their signals could interfere with critical aircraft instruments.

Responsible Party :

LG Electronics USA, Inc. 1000 Sylvan Avenue
Englewood Cliffs, NJ 07632

TEL. : +1-800-243-0000

Table of Contents

1 Getting Started

- 3 Safety Information
- 8 Introduction
 - 8 – About the “ \emptyset ” symbol display
- 9 Front Panel
- 9 Rear Panel
- 10 Remote Control
- 11 Mounting the main unit on a wall

2 Connecting

- 13 Speaker Connection
 - 13 – Wireless connection
- 14 Connecting to Your TV
 - 14 – HDMI Connection
 - 14 – What is SIMPLINK?
 - 15 – ARC (Audio Return Channel) function
 - 15 – Resolution Setting
 - 16 – Optical digital audio connection
- 17 Connections with external device
 - 17 – OPTICAL IN connection
- 17 Connecting to your Home Network
 - 17 – Wired network connection
 - 18 – Wired network setup
 - 19 – Wireless network connection
 - 20 – Wireless network setup

3 System Setting

- 23 Initial Setup
- 24 Settings
 - 24 – Adjust the setup settings
 - 25 – [NETWORK] menu
 - 26 – [DISPLAY] menu
 - 27 – [LANGUAGE] menu
 - 28 – [AUDIO] menu
 - 29 – [OTHERS] menu
- 30 Sound Effect

4 Operating

- 31 Home Menu Display
 - 31 – Using [HOME] menu
 - 31 – Using the Smart Share
- 32 Playing the Linked Devices
 - 32 – Playing a USB device
 - 33 – Playing a file on a network server
- 34 Using Home Network Server for PC
 - 34 – Installing Nero MediaHome 4 Essentials
 - 34 – Sharing files and folders
 - 35 – About Nero MediaHome 4 Essentials
 - 35 – System requirements
- 36 General Playback
 - 36 – Basic operations for video and audio content
 - 36 – Basic operations for photo content
 - 37 – Resume playback
- 38 On-Screen Display
 - 38 – To control video playback
 - 39 – To control photo view
- 40 Viewing information from Gracenote Media Database
- 41 Advanced Playback
 - 41 – Repeat playback
 - 41 – Repeating a specific portion
 - 41 – Playing from selected time
 - 42 – Selecting a subtitle language
 - 42 – Hearing a different audio
 - 42 – Changing the TV Aspect Ratio
 - 43 – Changing Subtitle Code Page
 - 43 – Changing the Picture Mode
 - 43 – Viewing content information
 - 44 – Changing content list view
 - 44 – Selecting a subtitle file
 - 45 – Listening to music during slide show
 - 45 – Setting the [3D] option
- 46 Advanced Features
 - 46 – Wi-Fi Direct™
- 47 Using Bluetooth technology
 - 47 – Listening to music stored on the Bluetooth devices
- 48 Using the Premium
- 49 Using the LG Smart World
 - 49 – Signing in
 - 50 – Searching online content

50 Using the My Apps Menu

5 Troubleshooting

- 51 Troubleshooting
- 51 – General
- 52 – Network
- 53 – Picture
- 53 – Sound
- 53 – Customer Support
- 53 – Open Source Software Notice

6 Appendix

- 54 Controlling a TV with the Supplied Remote Control
- 54 – Setting up the remote to control your TV
- 55 Network Software Update
- 55 – Network update notification
- 55 – Software update
- 57 Additional Information
- 57 – File requirement
- 59 – About DLNA
- 59 – Certain system requirements
- 60 Audio Output Specifications
- 61 Trademarks and Licenses
- 64 Specifications
- 65 Maintenance
- 65 – Handling the unit
- 65 Important Information relating to Network Services

Some of the content in this manual may differ from your unit depending on the software of the unit or your service provider.

1

2



3

4

5

6

Introduction

Term	Symbol	Description
Note		Indicates special notes and operating features.
Caution		Indicates cautions for preventing possible damages from abuse.

About the “⊘” symbol display

“⊘” may appear on your TV display during operation and indicates that the function explained in this owner’s manual is not available on that specific media.

Front Panel

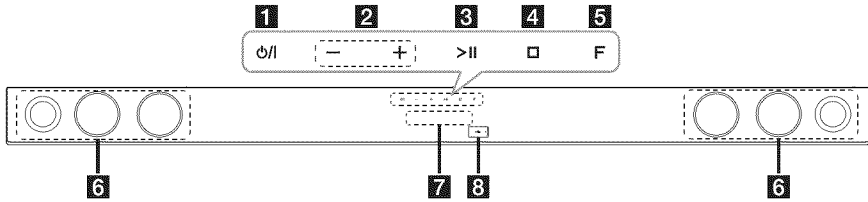

- 1** (Standby/On)
- 2** - / + (Volume)
Adjusts speaker volume.
- 3** (Play / Pause)
- 4** (Stop)
- 5** **F** (Function)
Press it repeatedly to select other function.
- 6** Speakers
- 7** Display window
- 8** USB Port



Note

Open USB cover by using your finger to connect USB.

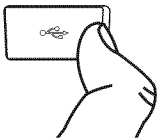

Caution

Precautions in using the touch buttons

- Use the touch buttons with clean and dry hands.
- In a humid environment, wipe out any moisture on the touch buttons before using.
- Do not press the touch buttons hard to make it work.
- If you apply too much strength, it can damage the sensor of the touch buttons.
- Touch the button that you want to work in order to operate the function correctly.
- Be careful not to have any conductive material such as metallic object on the touch buttons. It may cause the unit to malfunction.

Rear Panel

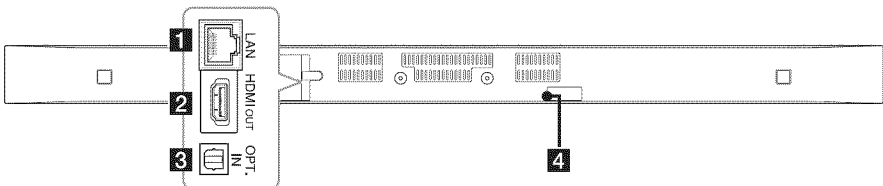

- 1** LAN connector
- 2** HDMI OUT connector
- 3** OPT. IN connector
- 4** DC IN connector

Remote Control

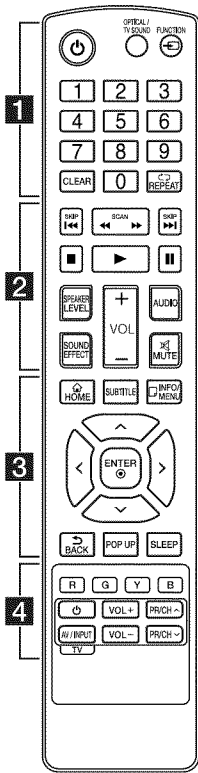

Battery Installation

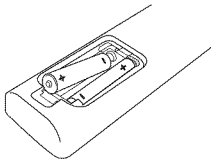

Remove the battery cover on the rear of the Remote Control, and insert two R03 (size AAA) battery with **+** and **-** matched correctly.

..... **1**

⏻ (Power): Switches the unit ON or OFF.

OPTICAL/TV SOUND:

Changes input mode to optical directly.

FUNCTION (↶): Changes input mode.

0-9 numerical buttons: Selects numbered options in a menu.

CLEAR: Removes a mark on the search menu or a number when setting the password.

REPEAT (↺): Repeats a desired section or sequence.

..... **2**

⏮/⏭ (SCAN): Searches backward or forward.

⏮/⏭ (SKIP): Goes to the next or previous chapter/title/file.

■ (Stop): Stops playback.

▶ (Play): Starts playback.

⏸ (Pause): Pauses playback.

SPEAKER LEVEL: Sets the sound level of desired speaker.

SOUND EFFECT: Selects a sound effect mode.

VOL +/-: Adjusts speaker volume.

AUDIO: Selects an audio language or audio channel.

MUTE (🔇): Mute the unit.

..... **3**

HOME (🏠): Displays or exits the [Home Menu].

SUBTITLE: Selects a subtitle language.

INFO/MENU (ℹ): Displays or exits On-Screen Display.

Direction buttons: Selects an option in the menu.

ENTER (⊙): Acknowledges menu selection.

BACK (⏪): Exits the menu or resumes playback.

POP UP: Displays a pop-up menu, if available.

SLEEP: Sets the system to turn off automatically at a specified time.

..... **4**

Colored (R, G, Y, B) buttons: They are used as shortcut buttons for specific menus.

TV Control Buttons: See page 54.

Mounting the main unit on a wall

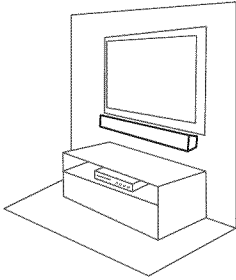

You can mount the main unit on a wall. Prepare screws and bracket.

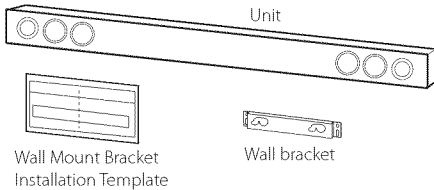

1. Match the TV's BOTTOM EDGE of Wall Mount Bracket Installation Template with the bottom of TV and attach to the position.

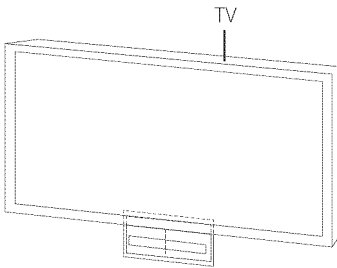

2. When you mount it on a wall (concrete), use the wall plugs (Not supplied). You should drill some holes. A guide sheet (Wall Mount Bracket Installation Template) is supplied to drill. Use the sheet to check the point to drill.

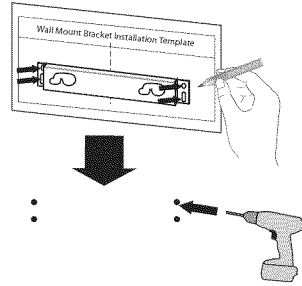

Note

Screws and Wall Plugs are not supplied for mounting the unit. We recommend the Hilti (HUD-1 6 x 30) for the mounting.

3. Remove the Wall Mount Bracket Installation Template.
4. Fix it with screws (not supplied) as shown in the illustration below.

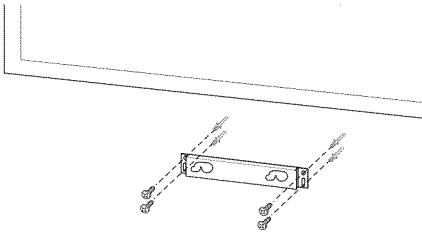

5. Hang the main unit onto the bracket as shown below.

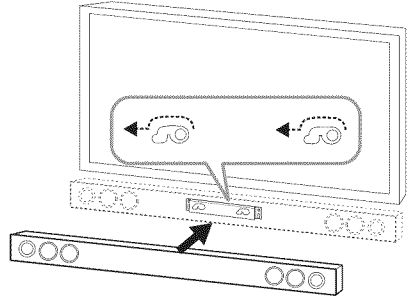

Caution

- Do not install this unit upside down. It can damage the parts of this unit or be the cause of personal injury.
- Do not hang onto the installed unit and avoid any impact to the unit.
- Secure the unit firmly to the wall so that it does not fall off. If the unit falls off, it may result in an injury of a person or damage to the product.
- When the unit is installed on a wall, please make sure that a child does not pull any of connecting cables, as it may cause it to fall.

Note

Detach the unit from the bracket as shown below.



Speaker Connection

Wireless connection

LED indicator of wireless subwoofer

LED Color	Operation
Yellow	The wireless subwoofer is receiving the signal of the unit.
Yellow (blink)	The wireless subwoofer is trying to connect.
Red	The Wireless subwoofer is in standby mode.
Off (No display)	The Wireless subwoofer is turned off.

Initial setting of an ID for the wireless subwoofer

1. Connect the power cord of the Wireless subwoofer to the outlet.
2. Turn on the main unit : The main unit and wireless subwoofer will be automatically connected.

Setting an ID for the wireless subwoofer

When the unit is manufactured, the ID is already set. If interference occurs or you use a new wireless subwoofer, an ID should be set again.

1. Press **HOME** (🏠).
2. Use **</>** to select the [Settings] and press **ENTER** (⊙). The [Settings] menu appears.
3. Use **^/v** to select [AUDIO] option then press **>** to move to the second level.

4. Use **^/v** to select the [Connect wireless speakers] option then press **ENTER** (⊙) or **>** to move to the third level.
The [Wireless Speaker Connection Guide] appears.
5. Press **PAIRING** button on the subwoofer.
- If you see the yellow LED indicator light, pairing was successful.
6. Select [Speaker test] for wireless speaker connection test by using **ENTER** (⊙).

Note

- If there is a strong electromagnetic wave product nearby, interference may occur. Put the unit (Wireless subwoofer and main unit) away from there.
- If you operate main unit then wireless subwoofer sound within a few seconds in standby mode.
- Set the distance between this unit and subwoofer Receiver within 10 m (32 ft.).
- Optimum performance can be implemented only when the unit and the Wireless subwoofer within distance of 2 m (6 ft.) to 10 m (32 ft.) is used since communication failure may occur if longer distance is used.
- It takes a few seconds (and may take longer) for the Wireless Transmitter and subwoofer to communicate with each other.

Connecting to Your TV

HDMI Connection

If you have a HDMI TV or monitor, you can connect it to this unit using a HDMI cable (Type A, High speed HDMI™ cable with Ethernet). Connect the HDMI jack on the unit to the HDMI jack on a HDMI compatible TV or monitor.

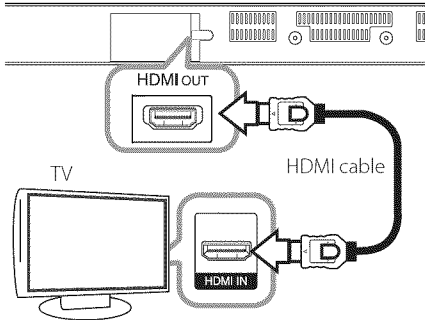

Set the TV's source to HDMI (refer to TV's Owner's manual).

Additional Information for HDMI

- When you connect a HDMI or DVI compatible device, make sure of the followings:
 - Try switching off the HDMI/DVI device and this unit. Next, switch on the HDMI/DVI device and leave it for around 30 seconds, then switch on this unit.
 - The connected device's video input is set correctly for this unit.
 - The connected device is compatible with 720 x 480p, 1280 x 720p, 1920 x 1080i or 1920 x 1080p video input.
- Not all HDCP-compatible HDMI or DVI devices will work with this unit.
 - The picture will not be displayed properly with non-HDCP device.

Note

- If a connected HDMI device does not accept the audio output of the unit, the HDMI device's audio sound may be distorted or may not output.
- When you use HDMI connection, you can change the resolution for the HDMI output. (Refer to "Resolution Setting" on page 15)
- Select the type of video output from the HDMI OUT jack using [HDMI Color Setting] option on the [Settings] menu (see page 27).
- Changing the resolution when the connection has already been established may result in malfunctions. To solve the problem, restart the unit.
- When the HDMI connection with HDCP is not verified, TV screen is changed to black screen. In this case, check the HDMI connection, or disconnect the HDMI cable.
- If there are noises or lines on the screen, please check the HDMI cable (length is generally limited to 4.5 m(15 ft.)).

What is SIMPLINK?



Some functions of this unit are controlled by the TV's remote control when this unit and LG TV's with SIMPLINK are connected through HDMI connection.

Controllable functions by LG TV's remote control :
Power on/off, volume up/down, etc.

Refer to the TV owner's manual for the details of SIMPLINK function.

LG TV's with SIMPLINK function has the logo as shown above.

Note

Depending on the state of the unit, some SIMPLINK operation may differ from your purpose or not work.

ARC (Audio Return Channel) function

The ARC function enables an HDMI capable TV to send the audio stream to HDMI OUT of the unit.

To use this function:

- Your TV must support the HDMI-CEC and ARC function and the HDMI-CEC and ARC must be set to On.
- The setting method of HDMI-CEC and ARC may differ depending on the TV. For details about ARC function, refer to your TV manual.
- You must use the HDMI cable (Type A, High Speed HDMI™ cable with Ethernet).
- You must connect the HDMI OUT on the unit with HDMI IN of the TV that supports ARC function using an HDMI cable.
- You can connect only one Sound bar to TV compatible with ARC.



Note

To active [SIMPLINK/ARC] function, set this option to [On]. (page 29)

Resolution Setting

The unit provides several output resolutions for HDMI OUT jack. You can change the resolution using [Settings] menu.

1. Press **HOME** (🏠).
2. Use **</>** to select the [Settings] and press **ENTER** (⊙). The [Settings] menu appears.
3. Use **^/v** to select [DISPLAY] option then press **>** to move to the second level.
4. Use **^/v** to select the [Resolution] option then press **ENTER** (⊙) to move to the third level.

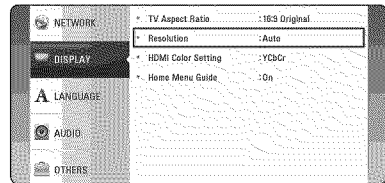

5. Use **^/v** to select the desired resolution then press **ENTER** (⊙) to confirm your selection.

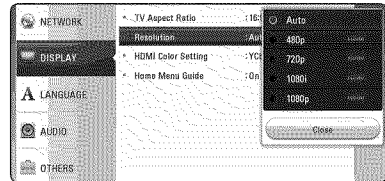

Note

- If your TV does not accept the resolution you have set on the unit, you can set resolution to 480p as follows:
 1. Press **HOME** (⏠) to disappear the HOME menu.
 2. Press **■** (Stop) for more than 5 seconds.
- If you select a resolution manually and then connect the HDMI jack to TV and your TV does not accept it, the resolution setting is set to [Auto].
- If you select a resolution that your TV does not accept, the warning message will appear. After resolution change, if you cannot see the screen, please wait 20 seconds and the resolution will automatically revert back to the previous resolution.

Optical digital audio connection

You can enjoy the sound from your TV with a optical digital audio connection.

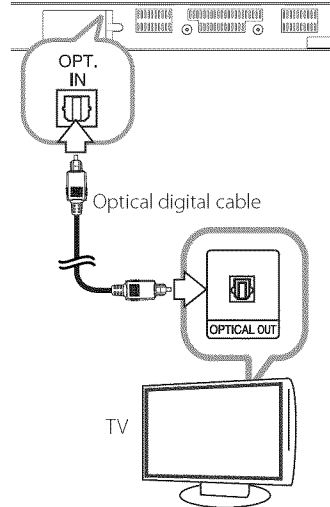

Connect the optical output jack of your TV into the OPT. IN jack on the unit. And then select the [OPTICAL] option by pressing **FUNCTION** (↔). Or press **OPTICAL/TV SOUND** to select directly.

Connections with external device

OPTICAL IN connection

You can enjoy the sound from your component with a digital optical connection through the speakers of this system.

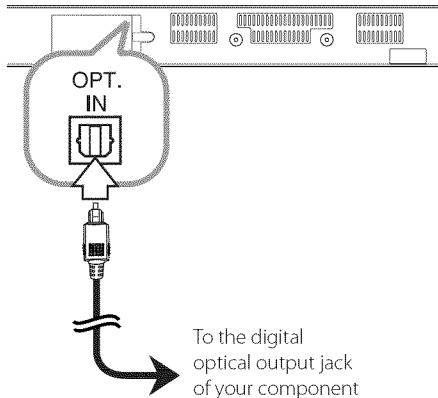

Connect the optical output jack of your component into the OPT. IN jack on the unit. And then select the [OPTICAL] option by pressing **FUNCTION** (←→). Or press **OPTICAL/TV SOUND** to select directly.

You can also use the **F** (Function) button on the front panel to select the input mode.

Connecting to your Home Network

This unit can be connected to a local area network (LAN) via the LAN port on the rear panel or the internal wireless module.

By connecting the unit to a broadband home network, you have access to services such as software updates and online content services.

Wired network connection

Using a wired network provides the best performance, because the attached devices connect directly to the network and are not subject to radio frequency interference.

Please refer to the documentation for your network device for further instructions.

Connect the unit's LAN port to the corresponding port on your Modem or Router using a commercially available LAN or Ethernet cable.

! Note

- When plugging or unplugging the LAN cable, hold the plug portion of the cable. When unplugging, do not pull on the LAN cable but unplug while pressing down on the lock.
- Do not connect a modular phone cable to the LAN port.
- Since there are various connection configurations, please follow the specifications of your telecommunication carrier or internet service provider.
- If you want to access content from DLNA servers, this unit must be connected to the same local area network through a router.
- To set your PC as a DLNA server, install the supplied Nero MediaHome 4 on your PC. (page 34)

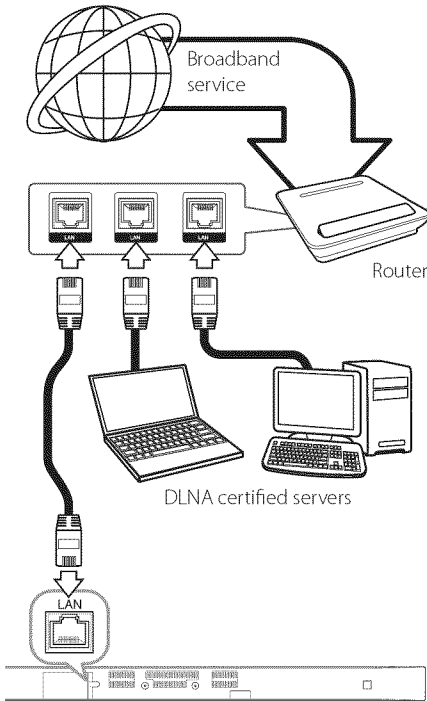

Wired network setup

If there is a DHCP server on the local area network (LAN) via wired connection, this unit will automatically be allocated an IP address. After making the physical connection, a small number of home networks may require the unit's network setting to be adjusted. Adjust the [NETWORK] setting as follow.

Preparation

Before setting the wired network, you need to connect the broadband internet to your home network.

1. Select [Connection Setting] option in the [Settings] menu then press **ENTER** (⊙).

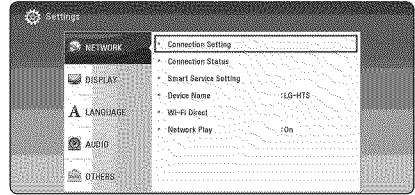

2. Read the preparations for the network settings and then press **ENTER** (⊙) while [Start] is highlighted.

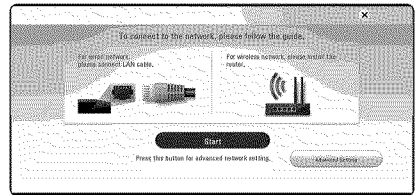

Network will automatically be connected to the unit.

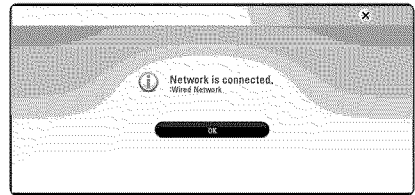

Advanced Setting

If you want to set the network settings manually, use \wedge / \vee to select [Advanced Setting] on the [Network Setting] menu and press **ENTER** (⊙).

1. Use \wedge / \vee to select [Wired] and press **ENTER** (⊙).

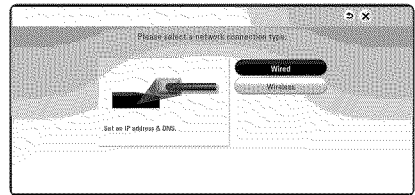

- Use $\wedge/\vee/</>$ to select the IP mode between [Dynamic] and [Static]. Normally, select [Dynamic] to allocate an IP address automatically.

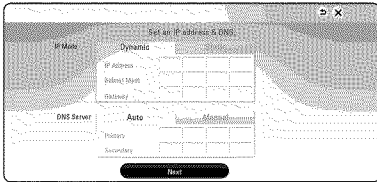

Note

If there is no DHCP server on the network and you want to set the IP address manually, select [Static] then set [IP Address], [Subnet Mask], [Gateway] and [DNS Server] using $\wedge/\vee/</>$ and numerical buttons. If you make a mistake while entering a number, press **CLEAR** to clear the highlighted part.

- Select [Next] and press **ENTER** (⊙) to apply network settings.

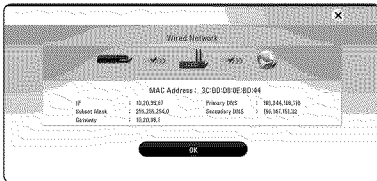

Network connection status is displayed on the screen.

- Press **ENTER** (⊙) while [OK] is highlighted to finish the wired network settings.

Wireless network connection

Another connection option is to use an Access Point or a wireless router. The network configuration and connection method may vary depending on the equipment in use and the network environment.

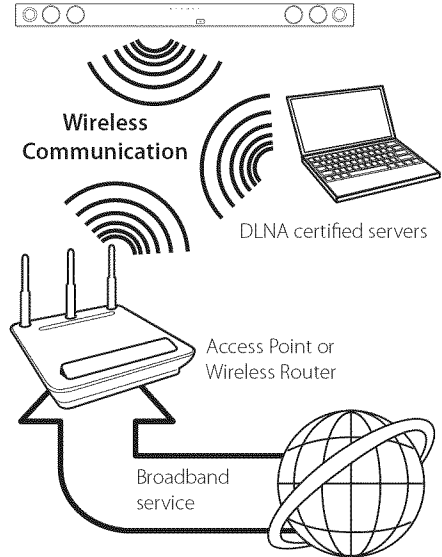

Refer to the setup instructions supplied with your access point or wireless router for detailed connection steps and network settings.

For best performance, a direct wired connection from this unit to your home network's router or cable/DSL modem is always the best option. If you choose to use the wireless option, please note that performance can sometimes be affected by other electronic devices in the home.

Wireless network setup

For the wireless network connection, the unit needs to be set up for network communication. This adjustment can be done from the [Settings] menu. Adjust the [NETWORK] setting as follow. Setting up the access point or the wireless router is required before connecting the unit to the network.

Preparation

Before setting the wireless network, you need to:

- connect the broadband internet to the wireless home network.
- set the access point or wireless router.
- note the SSID and security code of the network.

1. Select [Connection Setting] option in the [Settings] menu then press **ENTER** (⊙).
2. Read the preparations for the network settings and then press **ENTER** (⊙) while [Start] is highlighted.

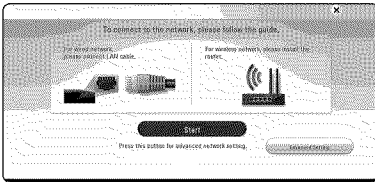

If wired network is not connected to the unit, all available networks are displayed on the screen.

3. Use \wedge/\vee to select a desired SSID of wireless network and press **ENTER** (⊙).

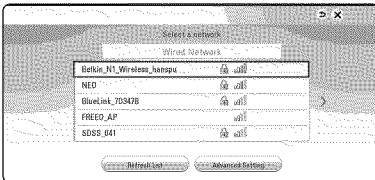

If you have security on your access point, you need to input the security code as necessary.

Note

If you use other characters than the english alphabet or digits for the SSID name of your access point or wireless router, it may be displayed differently.

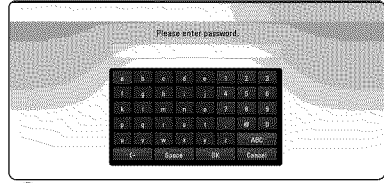

Note

- WEP security mode generally have 4 keys available on an access point setting. If your access point or wireless router use WEP security, enter the security code of the key "No.1" to connect on your home network.
 - An Access Point is a device that allows you to connect to your home network wirelessly.
4. Use $\wedge/\vee/\lt;/\gt$ to select the IP mode between [Dynamic] and [Static]. Normally, select [Dynamic] to allocate an IP address automatically.

Note

If there is no DHCP server on the network and you want to set the IP address manually, select [Static] then set [IP Address], [Subnet Mask], [Gateway] and [DNS Server] using $\wedge/\vee/\lt;/\gt$ and numerical buttons. If you make a mistake while entering a number, press **CLEAR** to clear the highlighted part.

5. Select [Next] and press **ENTER** (⊙) to apply network settings.

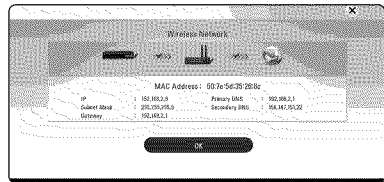

Network connection status is displayed on the screen.

6. Select [OK] and press **ENTER** (⊙) to complete the network connection.

Advanced Setting

If you want to set the network settings manually, use \wedge/\vee to select [Advanced Setting] on the [Network Setting] menu and press **ENTER** (⊙).

1. Use \wedge/\vee to select [Wireless] and press **ENTER** (⊙).

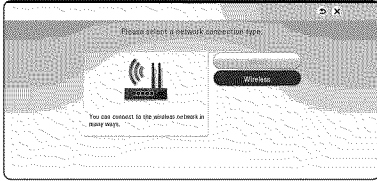

[AP List] - Scans all available access points or wireless routers within range and display them as a list.

[Network name (SSID)] – Your access point may not be broadcasting its network name (SSID). Check your access point settings through your computer and either set your access point to broadcast SSID, or manually enter the network name in [Network name(SSID)].

[PBC] – If your access point or wireless router that supports the PBC (Push Button Configuration) method, select this option and press the Push Button on your access point within 120 counts. You do not need to know the network name (SSID) and security code of your access point.

[PIN] – If your access point supports the PIN Code configuration method based on WPS(Wi-Fi Protected Setup), select this option and note the code number on the screen. And then, enter the PIN number on a setting menu of your access point to connect. Refer to the documentation for your network device.

2. Follow the instructions of each connection method on the screen.



Note

To use PBC and PIN network connection, security mode of your access point must be set to OPEN or AES.

Notes on network connection

- Many network connection problems during set up can often be fixed by re-setting the router or modem. After connecting the unit to the home network, quickly power off and/or disconnect the power cable of the home network router or cable modem. Then power on and/or connect the power cable again.
- Depending on the internet service provider (ISP), the number of devices that can receive internet service may be limited by the applicable terms of service. For details, contact your ISP.
- Our company is not responsible for any malfunction of the unit and/or the internet connection feature due to communication errors/malfunctions associated with your broadband internet connection, or other connected equipment.
- Some internet content may require a higher bandwidth connection.
- Even if the unit is properly connected and configured, some internet content may not operate properly because of internet congestion, the quality or bandwidth of your internet service, or problems at the provider of the content.
- Some internet connection operations may not be possible due to certain restrictions set by the Internet service provider (ISP) supplying your broadband Internet connection.
- Any fees charged by an ISP including, without limitation, connection charges are your responsibility.
- A 10 Base-T or 100 Base-TX LAN port is required for wired connection to this unit. If your internet service does not allow for such a connection, you will not be able to connect the unit.
- You must use a Router to use xDSL service.
- A DSL modem is required to use DSL service and a cable modem is required to use cable modem service. Depending on the access method of and subscriber agreement with your ISP, you may not be able to use the internet connection feature contained in this unit or you may be limited to the number of devices you can connect at the same time. (If your ISP limits subscription to one device, this unit may not be allowed to connect when a PC is already connected.)

- The use of a “Router” may not be allowed or its usage may be limited depending on the policies and restrictions of your ISP. For details, contact your ISP directly.
- The wireless network operate at 2.4 GHz radio frequencies that are also used by other household devices such as cordless telephone, **Bluetooth®** devices, microwave oven, and can be affected by interference from them.
- Turn off all unused network equipment in your local home network. Some devices may generate network traffic.
- For better reception, place the unit from the access point as close as possible.
- In some instances, placing the access point or wireless router at least 0.45 m (1.5 ft.) above the floor may improve the reception.
- The reception quality over wireless depends on many factors such as type of the access point, distance between the unit and access point, and the location of the unit.
- Set your access point or wireless router to Infrastructure mode. Ad-hoc mode is not supported.

Initial Setup

When you turn on the unit for the first time, the initial setup wizard appears on the screen. Set the display language and network settings on the initial setup wizard.

1. Press **⏻** (Power).

The initial setup wizard appears on the screen.

2. Use **⏮/⏪/⏩/⏭** to select a display language and press **ENTER** (**⏏**).

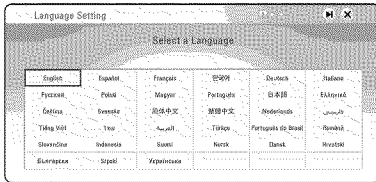

3. Read and prepare the preparations for the network settings and then press **ENTER** (**⏏**) while [Start] is highlighted.

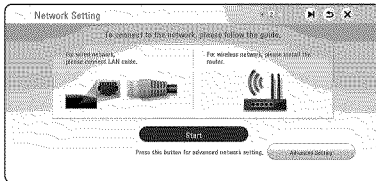

If wired network is connected, the network connection setting will automatically be finished.

4. All available networks are displayed on the screen. Use **⏮/⏪** to select [Wired Network] or desired SSID of wireless network and press **ENTER** (**⏏**).

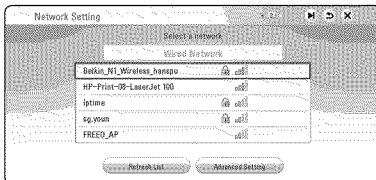

If you have security on your access point, you need to input the security code as necessary.

5. Use **⏮/⏪/⏩/⏭** to select the IP mode between [Dynamic] and [Static]. Normally, select [Dynamic] to allocate an IP address automatically.

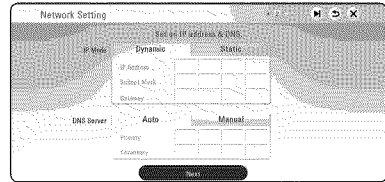

6. Select [Next] and press **ENTER** (**⏏**) to apply network settings.

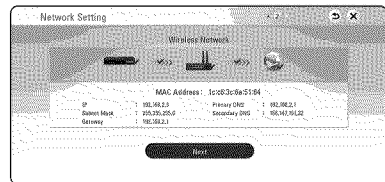

Network connection status is displayed on the screen.

For details on network settings, refer to “Connecting to your Home Network” on page 17.

7. Select [Next] and press **ENTER** (⊙).
8. You can listen to TV sound through HTS Speaker automatically when TV is turned on. TV and HTS should be connected with optical cable. Press **▲** to move and press **</>** to select [On] or [Off]. Select [Next] and press **ENTER** (⊙).

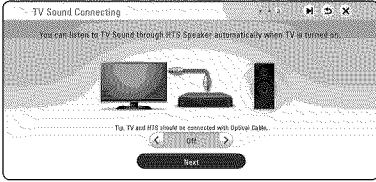

9. Check all the settings that you have set in the previous steps.

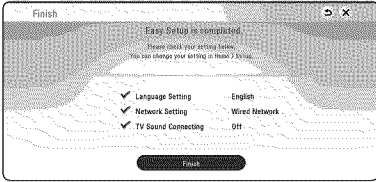

Press **ENTER** (⊙) while [Finish] is highlighted to finish the initial setup settings. If there is any settings to be changed, use **▲/▼/</>** to select **↶** and press **ENTER** (⊙).

Settings

Adjust the setup settings

You can change the settings of the unit in the [Settings] menu.

1. Press **HOME** (🏠).

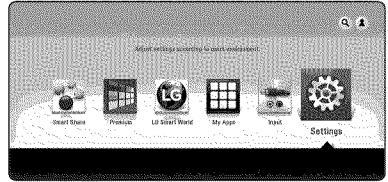

2. Use **</>** to select the [Settings] and press **ENTER** (⊙). The [Settings] menu appears.

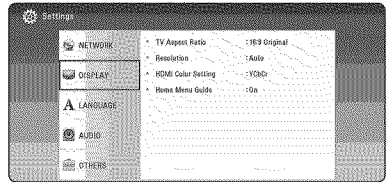

3. Use **▲/▼** to select the first setup option, and press **>** to move to the second level.

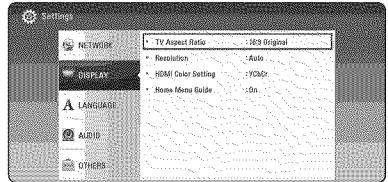

4. Use **▲/▼** to select a second setup option, and press **ENTER** (⊙) to move to the third level.

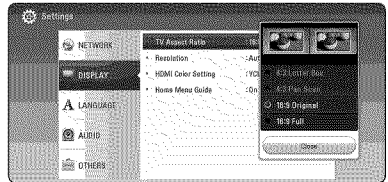

5. Use **▲/▼** to select a desired setting, and press **ENTER** (⊙) to confirm your selection.

[NETWORK] menu

The [NETWORK] settings are needed to use the software update and online content services.

Connection Setting

If your home network environment is ready to connect, the unit needs to be set up via wireless or wired connection for network communication. (See "Connecting to your Home Network" on page 17.)

Connection Status

If you want to check the network status on this unit, select the [Connection Status] options and press **ENTER** (⊙) to check whether a connection to the network and the internet have been established.

Smart Service Setting

[Country Setting]

Select your area for displaying proper online content service.

[Initialize]

- [Deactivate Netflix]
Deactivates your unit. To activate the Netflix again, contact to the service provider.
- [Netflix ESN]
Display its unique Netflix ESN (Electronic Serial Number) that allows you to use the Netflix streaming.
- [Deactivate Vudu]
Deactivates your unit. To activate the Vudu again, contact to the service provider.

Device Name

You can make a network name using virtual keyboard. This unit will be recognised by the name you are entering on your home network.

Wi-Fi Direct

This unit is a Wi-Fi Direct™ certified device. Wi-Fi Direct™ is the technology that enables devices to connect each other without connecting to an Access point or a router. Set this option to [On] for activating the Wi-Fi Direct™ mode. Refer to page 46 for the device connection.

Network Play

This function allows you to control the playback of media streamed from DLNA media server by a DLNA certified smartphone. Most DLNA certified smartphone has a function to control the playback media on your home network. Set this option to [On] for allowing your smartphone to control this unit. Refer to instructions of your DLNA certified smartphone or the application for more detailed information.

! Note

- This unit and the DLNA Certified Smartphone must be connected to the same network.
- To use the [Network Play] function using a DLNA certified smartphone, press **HOME** (🏠) to display the home menu before connecting to this unit.
- While controlling the unit using the [Network Play] function, the remote control may not work.
- Available file formats described on page 57 are not always supported on [Network Play] function.

[DISPLAY] menu

TV Aspect Ratio

Select a TV aspect ratio option according to your TV type.

[4:3 Letter Box]

Select when a standard 4:3 TV is connected. Displays theatrical images with masking bars above and below the picture.

[4:3 Pan Scan]

Select when a standard 4:3 TV is connected. Displays pictures cropped to fill your TV screen. Both sides of the picture are cut off.

[16:9 Original]

Select when a 16:9 wide TV is connected. The 4:3 picture is displayed with an original 4:3 aspect ratio, with black bars appearing at the left and right sides.

[16:9 Full]

Select when a 16:9 wide TV is connected. The 4:3 picture is adjusted horizontally (in a linear proportion) to fill the entire screen.



Note

You cannot select [4:3 Letter Box] and [4:3 Pan Scan] option when the resolution is set to higher than 720p.

Resolution

Sets the output resolution of the HDMI video signal. Refer to page 15 for details about the resolution setting.

[Auto]

If the HDMI OUT jack is connected to TVs providing display information (EDID), automatically selects the resolution best suited to the connected TV.

[480p]

Outputs 480 lines of progressive video.

[720p]

Outputs 720 lines of progressive video.

[1080i]

Outputs 1080 lines of interlaced video.

[1080p]

Outputs 1080 lines of progressive video.

HDMI Color Setting

Select the type of output from the HDMI OUT jack. For this setting, please refer to the manuals of your display device.

[YCbCr]

Select when connecting to a HDMI display device.

[RGB]

Select when connecting to a DVI display device.

Home Menu Guide

This function allows you to display or delete the guide bubble on the [HOME] menu. Set this option to [On] for displaying guide.

[LANGUAGE] menu

Display Menu

Select a language for the [Settings] menu and on-screen display.

[AUDIO] menu

Each file has a variety of audio output options. Set the unit's Audio options according to the type of audio system you use.

! Note

Since many factors affect the type of audio output, see "Audio Output Specifications" on page 60 for details.

Digital Output

[PCM Stereo] (HDMI only)

Select if you connect this unit's HDMI OUT jack to a device with two-channel digital stereo decoder.

[PCM Multi-Ch] (HDMI only)

Select if you connect this unit's HDMI OUT jack to a device with multi-channel digital decoder.

[DTS Re-Encode] (HDMI only)

Select if you connect this unit's HDMI OUT jack to a device with DTS decoder.

[Bit Stream] (HDMI only)

Select if you connect this unit's HDMI OUT jack to a device with LPCM, Dolby Digital, Dolby Digital Plus, DTS decoder.

! Note

- When [Digital Output] option is set to [PCM Multi-Ch], the audio may output as PCM Stereo if the PCM Multi-Ch information is not detected from HDMI device with EDID.
- This setting is not available on the input signal from an external device.

DRC (Dynamic Range Control)

This function allows you to listen to a movie at a lower volume without losing clarity of sound.

[Auto]

The dynamic range of the Dolby Digital and Dolby Digital Plus are operated as same as the [On] mode.

[On]

Compress the dynamic range of the Dolby Digital, Dolby Digital Plus audio output.

[Off]

Turns off this function.

Connect wireless speakers

You can set up wireless connection manually, when your connection is not completed. Refer to page 13.

HD AV Sync

Sometimes Digital TV encounters a delay between picture and sound. If this happens you can compensate by setting a delay on the sound so that it effectively 'waits' for the picture to arrive: this is called HD AV Sync. Use <> to scroll up and down through the delay amount, which you can set at anything between 0 and 300 ms.

[OTHERS] menu

DivX® VOD

ABOUT DIVX VIDEO: DivX® is a digital video format created by DivX, LLC, a subsidiary of Rovi Corporation. This is an official DivX Certified® device that plays DivX video. Visit divx.com for more information and software tools to convert your files into DivX videos.

ABOUT DIVX VIDEO-ON-DEMAND: This DivX Certified® device must be registered in order to play purchased DivX Video-on-Demand (VOD) movies. To obtain your registration code, locate the DivX VOD section in your device setup menu. Go to vod.divx.com for more information on how to complete your registration.

[Register]

Displays the registration code of your unit.

[Deregister]

Deactivate your unit and display the deactivation code.



Note

All the downloaded videos from DivX® VOD with this player's registration code can only be played on this unit.

Auto Power Off

The screen saver appears when you leave the unit in Stop mode for about five minutes. If you set this option to [On], the unit automatically turns off within 20 minutes since the Screen Saver is displayed. Set this option to [Off] to leave the screen saver until the unit is operated by the user.

TV Sound Connecting

You can listen to TV sound through this unit's speaker automatically when TV is turned on. TV and this unit should be connected with optical cable.

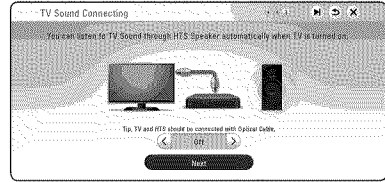

Press **▲** to move and press **</>** to select [On] or [Off]. Select [Next] and press **ENTER** (⊙).

Initialize

[Factory Set]

You can reset the unit to its original factory settings.



Note

If you reset the unit to its original factory settings using [Factory Set] option, you have to set all the activation for the online services and network settings again.

Software

[Information]

Displays the current software version.

[Update]

You can update the software by connecting the unit directly to the software update server (page 55).

SIMPLINK/ARC

- The SIMPLINK function allows you to control this unit with LG TV's remote control.
- The ARC function enables an HDMI capable TV to send the audio stream to HDMI OUT of this player.

Set this option to [On] for activating [SIMPLINK/ARC] function. (page 14)

Sound Effect

You can select a sound mode that suits you and the contents you are playing. Press **SOUND EFFECT** repeatedly until the desired mode appears on the front panel display or the TV screen. The displayed items for the equalizer may be different depending on sound sources and effects.

[Natural]: You can enjoy comfortable and natural sound.

[Bypass]: Software with multichannel surround audio signals is played according to the way it was recorded.

[Bass Blast]: Reinforce the bass sound effect from front left and right speaker and subwoofer.

[Loudness]: Improves bass and treble sound.

[User EQ]: You can adjust the sound by raising or lowering the level of specific frequency.

[3D SOUND]: 3D Sound features deliver sound creating a wider spot so you can enjoy more immersive and cinematic surround sound.

Setting the [User EQ]

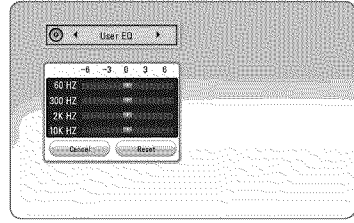

1. Use \wedge/\vee to select the desired frequency.
2. Use $</>$ to select the desired level.

Select [Cancel] option then press **ENTER** (Ⓢ) to cancel the setting.

Select [Reset] option then press **ENTER** (Ⓢ) to reset the all adjustments.

Home Menu Display

Using [HOME] menu

The home menu appears when you press **HOME** (🏠). Use **▲/▼/◀/▶** to select a category and press **ENTER** (⊙).

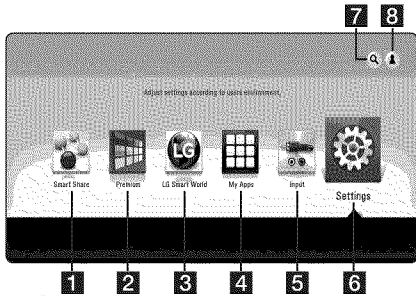

Note

Depending on the region, the [LG Smart World], [My Apps] service and [Search] function may not be available.

- 1** [Smart Share] - Displays Smart Share menu.
- 2** [Premium] - Displays the Premium home screen. (page 48)
- 3** [LG Smart World] - Displays LG Apps titles provided to the unit. (page 49)
- 4** [My Apps] - Displays the [My Apps] screen. (page 50)
- 5** [Input] - Changes input mode.
- 6** [Settings] - Adjusts the system settings.
- 7** [Search] - Searches for desired LG Apps and other content.
- 8** [Log In] - Displays login menu.

Using the Smart Share

You can play video, photo and audio content on the unit by connecting a USB device or using home network (DLNA).

1. Press **HOME** (🏠) to display the home menu.
2. Select [Smart Share] and press **ENTER** (⊙).

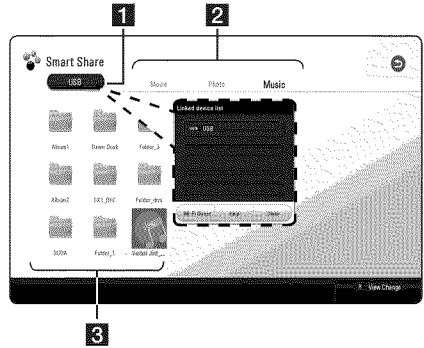

- 1** Displays all linked devices.
- 2** Displays video, photo or audio content.
- 3** Displays the file or folder on linked device.

Playing the Linked Devices

Playing a USB device

MOVIE MUSIC PHOTO

This unit can play video, audio and photo files contained on a USB device.

1. Connect a USB device on the unit.

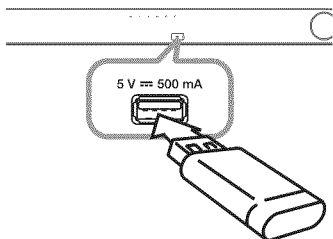

When you connect the USB device on the HOME menu, the unit plays an audio file contained in the USB storage device automatically. If the USB storage device is containing various types of files, a menu for the file type selection will appear.

File loading may takes few minutes depending on the number of content stored in the USB storage device. Press **ENTER** (⊙) while [Cancel] is selected to stop loading.

2. Press **HOME** (🏠).
3. Select [Smart Share] and press **ENTER** (⊙).

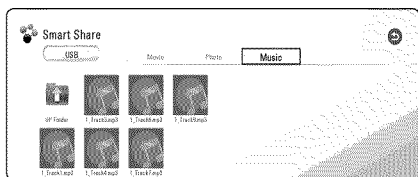

4. Select the desired linked device in the category.
5. Select [Movie], [Photo] or [Music].
6. Select a file using **▲/▼/◀/▶**, and press **▶(Play)** or **ENTER** (⊙) to play the file.

Notes on USB device

- This unit supports USB flash drive/external HDD formatted in FAT32 and NTFS when accessing files (music, photo, movie).
- This unit can support up to 4 partitions of the USB device.
- Do not extract the USB device during operation (play, etc.).
- A USB device which requires additional program installation when you have connected it to a computer, is not supported.
- USB device: USB device that supports USB1.1 and USB2.0.
- Video, audio and photo files can be played. For details of operations on each file, refer to relevant pages.
- Regular back up is recommended to prevent data loss.
- If you use a USB extension cable, USB HUB or USB Multi-reader, the USB device may not be recognized.
- Some USB device may not work with this unit.
- Digital camera and mobile phone are not supported.
- USB Port of the unit cannot be connected to PC. The unit cannot be used as a storage device.

Playing a file on a network server

MOVIE MUSIC PHOTO

This unit can play video, audio and photo files located in a DLNA server through your home network.

1. Check the network connection and settings (page 17).
2. Press **HOME** (🏠).
3. Select [Smart Share] and press **ENTER** (⊙).

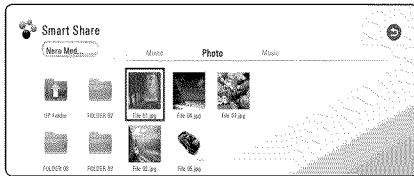

4. Select a DLNA media server in the category.
5. Select [Movie], [Photo] or [Music].
6. Select a file using **▲/▼/◀/▶**, and press **▶**(Play) or **ENTER** (⊙) to play the file.

! Note

- The file requirements are described on page 57.
- Thumbnails of files with unsupported format will be displayed, but cannot be played on this unit.
- The subtitle file name and video file name have to be the same and located at the same folder.
- The playback and operating quality may be affected by your home network condition.
- You may experience connection problems depending on your server's environment.
- To set your PC as a DLNA server, install the supplied Nero MediaHome 4 on your PC. (page 34)

Using Home Network Server for PC

DLNA stands for Digital Living Network Alliance, which allows users to access video, photo and audio files stored in server and enjoy them on TV via home networking.

Before connecting to PC to play a file, Nero MediaHome 4 Essentials program should be installed on your PC.

Installing Nero MediaHome 4 Essentials

Windows

Start up your computer, and insert the supplied CD-ROM disc into your computer's CD-ROM drive. An installation wizard will walk you through the quick and uncomplicated installation process. To install Nero MediaHome 4 Essentials, proceed as follows:

1. Close all Microsoft Windows programs and exit any anti-virus software that may be running.
2. Insert the supplied CD-ROM disc into your computer's CD-ROM drive.
3. Click [Nero MediaHome 4 Essentials].
4. Click [Run] to start installation.
5. Click [Nero MediaHome 4 Essentials]. The installation is prepared and the installation wizard appears.
6. Click the [Next] button to display the serial number input screen. Click [Next] to go to the next step.
7. If you accept all conditions, click [I accept the License Conditions] check box and click [Next]. Installation is not possible without this agreement.
8. Click [Typical] and click [Next]. The installation process is started.
9. If you want to take part in the anonymous collection of data, select the check box and click the [Next] button.
10. Click the [Exit] button to complete the installation.

MAC OS X

1. Start up your computer, and insert the supplied CD-ROM disc into your computer's CD-ROM drive.
2. Browse the CD-ROM drive and open the "MediaHome_4_Essentials_MAC" folder.
3. Double-click the "Nero MediaHome.dmg" image file. The Nero MediaHome window is opened.
4. In the Nero MediaHome window, drag the Nero MediaHome icon either to the Applications folder within the window or to any other desired location.
5. You can now start the application by double-clicking the Nero MediaHome icon in the location you dragged it to.

Sharing files and folders

On your computer, you must share the folder containing video, audio and/or photo content to play them on this unit.

This part explains the procedure for selecting the shared folders on your computer.

1. Double-click the "Nero MediaHome 4 Essentials" icon.
2. Click [Network] icon on the left and define your network name in the [Network name] field. The Network name you enter will be recognized by your unit.
3. Click [Shares] icon on the left.
4. Click [Local Folders] tab on the [Shares] screen.
5. Click [Add] icon to open the [Browse Folder] window.
6. Select the folder containing the files you want to share. The selected folder is added to the list of shared folders.
7. Click [Start Server] icon to start the server.



Note

- If the shared folders or files are not displayed on the unit, click the folder on the [Local Folders] tab and click [Rescan Folder] at the [More] button.
- Visit www.nero.com for more information and software tools.

About Nero MediaHome 4 Essentials

Nero MediaHome 4 Essentials is a software for sharing video, audio and photo files stored on your computer to this unit as a DLNA-compatible digital media server.

Note

- The Nero MediaHome 4 Essentials CD-ROM is designed for PCs and should not be inserted in this unit or in any product other than a PC.
- The supplied Nero MediaHome 4 Essentials CD-ROM is a customized software edition only for sharing files and folders to this unit.
- The supplied Nero MediaHome 4 Essentials software does not support following functions: Transcoding, Remote UI, TV control, Internet services and Apple iTunes.
- The supplied Nero MediaHome 4 Essentials software can be downloaded at
 - Windows : <http://www.nero.com/download.php?id=nmhlgewin>
 - Mac OS : <http://www.nero.com/download.php?id=nmhlgemac>
- This manual explains operations with the English version of Nero MediaHome 4 Essentials as examples. Follow the explanation referring to the actual operations of your language version.

System requirements

Windows PC

- Windows® XP (Service Pack 2 or higher), Windows Vista® (no Service Pack required), Windows® 7 (no Service Pack required), Windows® XP Media Center Edition 2005 (Service Pack 2 or higher), Windows Server® 2003
- Windows Vista® 64-bit edition (application runs in 32-bit mode)
- Windows® 7 64-bit edition (application runs in 32-bit mode)
- Hard drive space: 200 MB hard drive space for a typical installation of Nero MediaHome stand-alone
- 1.2 GHz Intel® Pentium® III or AMD Sempron™ 2200+ processors
- Memory: 256 MB RAM
- Graphics card with at least 32 MB video memory, minimum resolution of 800 x 600 pixels, and 16-bit color settings
- Windows® Internet Explorer® 6.0 or higher
- DirectX® 9.0c revision 30 (August 2006) or higher
- Network environment: 100 Mb Ethernet, WLAN

Macintosh

- Mac OS X 10.5 (Leopard) or 10.6 (Snow Leopard)
- Macintosh computer with an Intel x86 processor
- Hard drive space: 200 MB hard drive space for a typical installation of Nero MediaHome stand-alone
- Memory: 256 MB RAM

General Playback

Basic operations for video and audio content

To stop playback

Press ■ (Stop) during playback.

To pause playback

Press || (Pause) during playback.
Press ► (Play) to resume playback.

To play frame-by-frame (Video)

Press || (Pause) during video playback.
Press || (Pause) repeatedly to play Frame-by-Frame playback.

To scan forward or backward

Press ◀◀ or ▶▶ to play fast forward or fast reverse during playback.

You can change the various playback speeds by pressing ◀◀ or ▶▶ repeatedly.

To slow down the playing speed

While the playback is paused, press ▶▶ repeatedly to play various speeds of slow motion.

To skip to the next/previous title/file

During playback, press ◀◀◀ or ▶▶▶ to go to the next title/file or to return to the beginning of the current title/file.

Press ◀◀◀ twice briefly to step back to the previous title/file.

In the file list menu of a server, there may have many types of content in a folder together. In this case, press ◀◀◀ or ▶▶▶ to go to the previous or next content with same type.

Basic operations for photo content

To play a slide show

Press ► (Play) to start slide show.

To stop a slide show

Press ■ (Stop) while slide show.

To pause a slide show

Press || (Pause) while slide show.
Press ► (Play) to re-start the slide show.

To skip to the next/previous photo

While viewing a photo in full screen, press < or > to go to the previous or next photo.

Resume playback

MOVIE MUSIC

The unit records the point where you pressed the ■ (Stop) depending on a file.

If "■ (Resume Stop)" appears on the screen briefly, press ▶ (Play) to resume playback (from the scene point).

If you press ■ (Stop) twice, "■ (Complete Stop)" appears on the screen. The unit will clear the stopped point.



Note

The resume point may be cleared when a button is pressed (for example ⏻ (Power)).

On-Screen Display

You can display and adjust various information and settings about the content.

To control video playback

MOVIE

You can control playback and set options while watching videos.

During playback, press **INFO/MENU** (□).

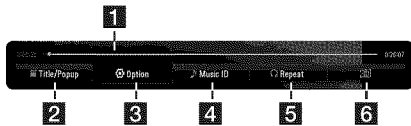

1 **Progress bar** - Displays the current position and total playing time.

2 **[Title/Popup]** - Displays the title or the popup menu, if available.

3 **[Option]** - Displays playback information.

4 **[Music ID]** - When connected to the network, can provide information about the current song during video playback.

5 **[Repeat]** - Repeats a desired section or sequence. (page 41)

6 **[3D]** - Adjusts the 3D setting. (page 45)

Displaying content information on-screen

MOVIE

1. During playback, press **INFO/MENU** (□).
2. Select an [Option] using **</>**, and press **ENTER** (⊙).

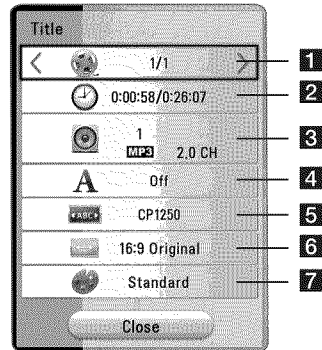

1 **Title** – Current title number/total number of titles

2 **Time** – Elapsed playing time/total playback time

3 **Audio** – Selected audio language or channel

4 **Subtitle** – Selected subtitle.

5 **Code Page** – Selected subtitle code.

6 **TV Aspect Ratio** – Selected TV aspect ratio

7 **Picture Mode** – Selected picture mode

! Note

- If no button is pressed for a few seconds, the on-screen display disappears.
- A title number cannot be selected on some files.
- Available items may differ depending on titles.

To control photo view

Controls playback and sets options while viewing pictures in full screen.

You can control playback and set options while viewing pictures in full screen.

While viewing pictures, press **INFO/MENU** (□).

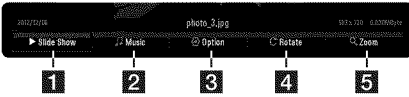

- 1** [Slideshow] - Starts or pause slide show.
- 2** [Music] - Select the background music for the slide show (page 45).
- 3** [Option] - Displays slide show options.
- 4** [Rotate] - Rotates the photo clockwise.
- 4** [Zoom] - Displays the [Zoom] menu.

Setting the slide show option

You can use various options during viewing a photo in full screen.

1. While viewing pictures, press **INFO/MENU** (□).
2. Select an [Option] using **</>**, and press **ENTER** (⊙)

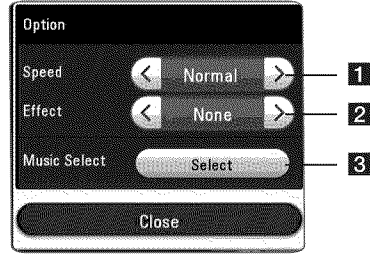

- 1** [Speed] - Use **</>** to select a delaying speed between photos in a slide show.
- 2** [Effect] - Use **</>** to select a transition effect between photos in a slide show.
- 3** [Music Select] - Select the background music for the slide show (page 45).

Viewing information from Gracenote Media Database

The unit can access the Gracenote Media Database and loads the music information so that Title name, Artist Name, Genre and other text information can be displayed on the list.

Music file

Select a music file using $\wedge / \vee / < / >$ and press **INFO/MENU** (□). You can also check the information while listening to music by using **INFO/MENU** (□).

The unit accesses to Gracenote Media Database for the music information.

Movie file

Select a music file by using $\wedge / \vee / < / >$ and press **INFO/MENU** (□).

The player accesses to Gracenote Media Database for the music information.

Note

- The unit must be connected to the broadband internet for accessing the Gracenote Media Database.
- If the music information is not in the Gracenote Media Database, message appears on the screen.
- Depending on the cases, it will takes a few minutes to load music information from the Gracenote Media Database.
- Information may be displayed in broken letters, if the language you selected is not available on the Gracenote Media Database.
- This function is not available for on-line content and content in DLNA servers.
- LG is a licensee of Gracenote technology and is not responsible or liable for information from the Gracenote Media Database.
- Files that users made for their only private purposes cannot be supported in this feature because they are not in the Gracenote Media Database.
- Supported music file extensions : mp3, wma, m4a

Advanced Playback

Repeat playback

MUSIC MOVIE

Video files

During playback, press **REPEAT** (↺↻) to select a desired repeat mode.

A-B – Selected portion will be repeated continually.

Title – The current title will be played back repeatedly.

All – All the titles or files will be played back repeatedly.

Off – Returns to normal playback.

To return to normal playback, press **CLEAR**.

Audio files

During playback, press **REPEAT** (↺↻) repeatedly to select a desired repeat mode.

1 – The current file will be played back repeatedly.

A – All the files will be played back repeatedly.

A ↻ – All the files will be played back repeatedly in random order.

↻ – The files will be played back in random order.

To return to normal playback, press **CLEAR**.

! Note

This function may not work on some titles.

Repeating a specific portion

MOVIE

This unit can repeat a portion you have selected.

1. During playback, press **REPEAT** (↺↻) to select [A-B] and press **ENTER** (⊙) at the beginning of the portion you wish to repeat.

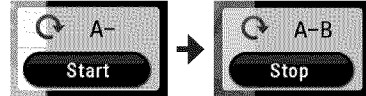

2. Press **ENTER** (⊙) at the end of the portion. Your selected portion will be repeated continually.
3. To return to normal playback, press **CLEAR**.

! Note

- You cannot select a portion less than 3 seconds.
- This function may not work on some title.

Playing from selected time

MOVIE

1. During playback, press **INFO/MENU** (□).
2. Select an [Option] using </>, and press **ENTER** (⊙).
3. Select the [Time] option and then input the required start time in hours, minutes, and seconds from left to right.

For example, to find a scene at 2 hours, 10 minutes, and 20 seconds, enter "21020".

Press </> to skip the playback 60 seconds forward or backward.

4. Press **ENTER** (⊙) to start playback from selected time.

! Note

- This function may not work on some titles.
- This function may not work depending on the file type and ability of the DLNA server.

Selecting a subtitle language

MOVIE

1. During playback, press **INFO/MENU** (□).
2. Select an [Option] using </>, and press **ENTER** (⊙).
3. Use \wedge/\vee to select the [Subtitle] option.
4. Use </> to select desired subtitle language.
By pressing **ENTER** (⊙), you can set various subtitle options.
5. Press **BACK** (⏪) to exit the On-Screen display.

Hearing a different audio

MOVIE

1. During playback, press **INFO/MENU** (□).
2. Select an [Option] using </>, and press **ENTER** (⊙).
3. Use \wedge/\vee to select the [Audio] option.
4. Use </> to select desired audio language or audio channel.

! Note

Immediately after you have switched sound, there may be a temporary discrepancy between the display and actual sound.

Changing the TV Aspect Ratio

MOVIE

You can change the TV aspect ratio setting during playback.

1. During playback, press **INFO/MENU** (□).
2. Select an [Option] using </>, and press **ENTER** (⊙).
3. Use \wedge/\vee to select the [TV Aspect Ratio] option.
4. Use </> to select desired option.
5. Press **BACK** (⏪) to exit the On-Screen display.

! Note

Even if you change the value of the [TV Aspect Ratio] option in On-Screen display, the [TV Aspect Ratio] option in the [Settings] menu is not changed.

Changing Subtitle Code Page

MOVIE

If the subtitle is displayed in broken letter, you can change the subtitle code page to view the subtitle file properly.

1. During playback, press **INFO/MENU** (□).
2. Select an [Option] using </>, and press **ENTER** (⊙).
3. Use \wedge/\vee to select the [Code Page] option.
4. Use </> to select desired code option.

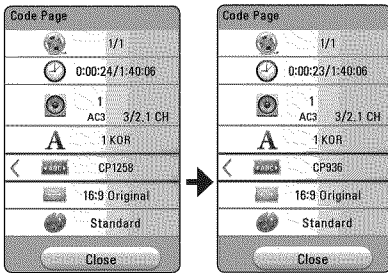

5. Press **BACK** (⏪) to exit the On-Screen display.

Changing the Picture Mode

MOVIE

You can change the [Picture mode] option during playback.

1. During playback, press **INFO/MENU** (□).
2. Select an [Option] using </>, and press **ENTER** (⊙).
3. Use \wedge/\vee to select the [Picture Mode] option.
4. Use </> to select desired option.
5. Press **BACK** (⏪) to exit the On-Screen display.

Setting the [User setting] option

1. During playback, press **INFO/MENU** (□).
2. Select an [Option] using </>, and press **ENTER** (⊙).
3. Use \wedge/\vee to select the [Picture Mode] option.
4. Use \wedge/\vee to select the [Picture Mode] option.
5. Use </> to select the [User setting] option, and press **ENTER** (⊙).

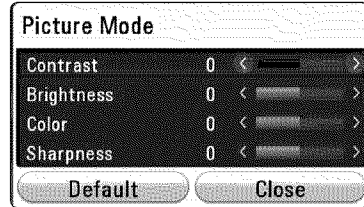

6. Use \wedge/\vee / \wedge/\vee to adjust the [Picture Mode] options.

Select [Default] option then press **ENTER** (⊙) to reset the all video adjustments.

7. Use \wedge/\vee / \wedge/\vee to select the [Close] option, and press **ENTER** (⊙) to finish setting.

Viewing content information

MOVIE

The unit can display the content information.

1. Select a file using \wedge/\vee / \wedge/\vee .
2. Press **INFO/MENU** (□) to display the option menu.

The file information appears on the screen.

During video playback, you can display the file information by pressing **POP UP**.

! Note

The information displayed on the screen may not correct comparing actual content information.

Listening to music during slide show

PHOTO

You can display photo files while listening to audio files.

1. While viewing a photo in full screen, press **INFO/MENU** (□) to display the option menu.
2. Select an [Option] using </>, and press **ENTER** (⊙).
3. Use ^/∨ to select [Music Select] option, and press **ENTER** (⊙) to display the [Music Select] menu.
4. Use ^/∨ to select a device, and press **ENTER** (⊙).

Available device may differ depending on the location of the current photo file.

Photo location	Available Device
USB	USB
DLNA server	DLNA server

5. Use ^/∨ to select a file or a folder you wish to play.

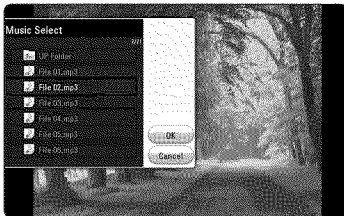

Select [MP Folder] and press **ENTER** (⊙) to display the upper directory.

! Note

When selecting audio file from a server, folder selection is not available. Only file selection is available.

6. Use > to select [OK], and press **ENTER** (⊙) to complete music selection.

Setting the [3D] option

MOVIE

This function allows you to play 3D content in case of file encoded in 3D.

1. During playback, press **INFO/MENU** (□).
2. Select [3D] using </>, and press **ENTER** (⊙).
3. Use ^/∨/</> to select desired options.

You can adjust 3D's depth and distance on the [3D Setting] option.

On [3D Setting], select [Init] option then press **ENTER** (⊙) to reset the all adjustments.

Advanced Features

Wi-Fi Direct™

Connecting to a Wi-Fi Direct™ certified device

MOVIE MUSIC PHOTO

This unit can play movie, music and photo files located in a Wi-Fi Direct™ certified device. The Wi-Fi Direct™ technology make the unit to be directly connected to a Wi-Fi Direct™ certified device without connecting to a network device such as an access point.

On Wi-Fi Direct™ certified device

1. Turn on the Wi-Fi Direct™ certified device and run its Wi-Fi Direct function.
2. Run DLNA application on the device.

On your unit

3. Select [NETWORK] option in the [Settings] menu then press **ENTER** (⊙).
4. Select [Wi-Fi Direct] option, and press **ENTER** (⊙).

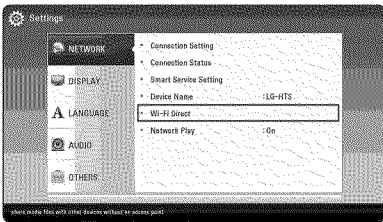

5. Select a Wi-Fi Direct™ device on the list using \wedge / \vee , and press **ENTER** (⊙).

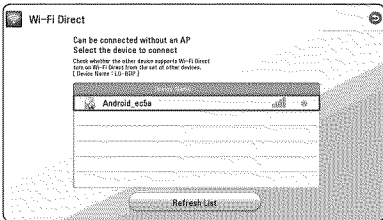

Wi-Fi Direct™ connection will be proceeded. follow the procedure on the screen.

If you want to rescan available Wi-Fi Direct™ device, select the [Refresh List] and press **ENTER** (⊙).

To select a server from the device list, files or folders must be shared by DLNA server from the connected Wi-Fi Direct™ device.

6. Select [Movie], [Photo] or [Music] using $\wedge / \vee / < / >$, and press **ENTER** (⊙).

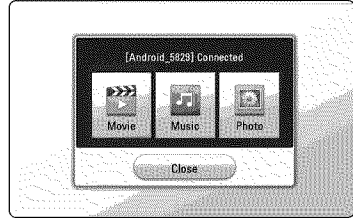

7. Select a file using $\wedge / \vee / < / >$, and press **ENTER** (⊙) to play the file.

! Note

- For the purpose of the better transmission, placing the unit from the Wi-Fi Direct™ certified server as close as possible.
- This unit can connect only 1 device at a time. Multiple connection is not available.
- If you try to connect wireless network while a device is connected by Wi-Fi Direct™ function, Wi-Fi Direct™ connection will be force disconnected.
- If this unit and a Wi-Fi Direct™ device are connected to the different local area network, Wi-Fi Direct™ connection may not available.
- If a Wi-Fi Direct™ certified device is not in Wi-Fi direct standby mode, this product cannot find the device.
- When you connect a Wi-Fi Direct™ certified device to your unit, PIN network connection is not supported.

Using Bluetooth technology

About Bluetooth

Bluetooth® is wireless communication technology for short range connection.

The available range is within 10 meters. (The sound may be interrupted when the connection interfered by the other electronic wave or you connect the bluetooth in the other rooms.)

Connecting individual devices under **Bluetooth®** wireless technology does not incur any charges. A mobile phone with **Bluetooth®** wireless technology can be operated via the Cascade if the connection was made via **Bluetooth®** wireless technology.

Available Devices : Mobile phone, MP3, Laptop, PDA (This units be supported the Stereo Headset.)

Bluetooth Profiles

In order to use Bluetooth wireless technology, devices must be able to interpret certain profiles. This unit is compatible with following profile.

A2DP (Advanced Audio Distribution Profile)

Listening to music stored on the Bluetooth devices

Pairing your unit and Bluetooth device

Before you start the pairing procedure, make sure the Bluetooth feature is turned on in to your Bluetooth device. Refer to your Bluetooth device's user guide. Once a pairing operation is performed, it does not need to be performed again.

1. Select the Bluetooth function by using the **FUNCTION** (⊕).
Appears "BT READY" in display window.
2. Operate the Bluetooth device and perform the pairing operation. When searching for this unit with the Bluetooth device, a list of the devices found may appear in the Bluetooth device display depending on the type of Bluetooth device. Your unit appears as "LG-HTS".
3. When this unit successfully paired with your Bluetooth device, Bluetooth LED of this unit lights up and "BT PAIRED" appears in the display window.

Note

Depending on the Bluetooth device type, some device have a different pairing way.

4. Listen to music.
To play a music stored on your Bluetooth device, refer to your Bluetooth device's user guide.

Note

If you change the function of the unit, the Bluetooth function is disconnected, operate pairing again.

! Note

- The sound may be interrupted when the connection interfered by the other electronic wave.
- You cannot control the Bluetooth device with this unit.
- Pairing is limited one Bluetooth device per one unit and multi-pairing is not supported.
- Although the distance between your Bluetooth and the set is less than 10 m, there are obstacles between both, your Bluetooth device cannot be connected.
- Depending on the type of the device, you may not be able to use the Bluetooth function.
- When not connected the Bluetooth, "BT READY" appears on the display window.
- The Electrical malfunction due to devices using same frequency such as Medical equipment, Microwaves or wireless LAN devices, the connection will be disconnected.
- If the gotten away of the distance between Bluetooth and the unit, the sound quality is lower and lower the connection will disconnect when the space between the Bluetooth and the unit gets out of the operating range of Bluetooth.
- The device with Bluetooth wireless technology is disconnected, if you turn off the main unit or put the device away from the main unit more than 10 m.

Using the Premium

You can use various content services via Internet with the Premium feature.

1. Check the network connection and settings (page 17).
2. Press **HOME** (🏠).
3. Select the [Premium] using \langle / \rangle , and press **ENTER** (⊙).

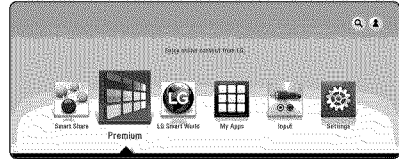

4. Select an online service using $\wedge / \vee / \langle / \rangle$, and press **ENTER** (⊙).

! Note

- For detailed information of each service, contact to the content provider or visit support link of the service.
- The content of Premium services and service related information, including user interface, is subject to changes. Please refer to the web site of each service for most up-to-date information.
- Using Premium features with wireless network connection may result in improper streaming speed by interference from household devices that are using radio frequencies.
- For the first time to access [Premium] or [LG Smart World] feature, current country setting appears. If you want to change the country setting, select [Edit] and press **ENTER** (⊙).

Using the LG Smart World

You can use the LG application services on this unit via Internet. You can easily find and download various applications from LG Smart World.

1. Check the network connection and settings (page 17).
2. Press **HOME** (🏠).
3. Select the [LG Smart World], and press **ENTER** (⊙).

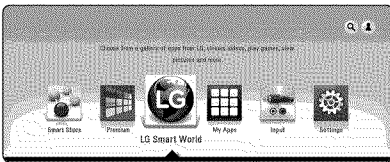

4. Select a category using \langle / \rangle , and press **ENTER** (⊙).
5. Use $\wedge / \vee / \langle / \rangle$ to select an application, and press **ENTER** (⊙) to display the information.
6. Press **ENTER** (⊙) while [Install] icon is highlighted. The application will be installed to the unit.

To install an application to the unit, user needs to sign in. Refer to page 49 for more information of signing in.

7. Press yellow (Y) colored button to display the [My Apps] screen.
8. Select the installed application and press **ENTER** (⊙) to execute it.

! Note

- Depending on the region, the [LG Smart World], [My Apps] service and [Search] function may not be available.
- To install a paid application, you need to be a paid member. Visit www.lgappstv.com for more information.

Signing in

To use the [LG Smart World] feature, you need to sign in with your account.

1. On the [LG Smart World] or [My Apps] screen, press red (R) colored button.
2. Fill the [ID] and [Password] field using the virtual keyboard.

If you do not have an account, press red (R) colored button to register.

3. Use $\wedge / \vee / \langle / \rangle$ to select [OK], and press **ENTER** (⊙) to sign in with your account.

If you select the [Auto Sign In] check box, your ID and password are remembered and automatically signed in without entering them.

! Note

- If you want to sign in with other account, press red (R) colored button on [LG Smart World] or [My Apps] screen, and select [Change User] option.
- To view the information of your account and applications, press red (R) colored button on [LG Apps] or [My Apps] screen, and select [Account Setting] option.

Searching online content

If you are having difficulties finding specific content from online services, you can use the all-in-one search function by entering keywords in the [Search] menu.

1. Press **HOME** (🏠).
2. Select the [Search] icon on the home menu using $\wedge/\vee/\lt;/\gt$, and press **ENTER** (⊙).
The [Search] menu appears on the screen with virtual keyboard.
3. Use $\wedge/\vee/\lt;/\gt$ to select letters then press **ENTER** (⊙) to confirm your selection on the virtual keyboard.
4. When you finish entering the keyword, select [OK] and press **ENTER** (⊙) to display search result.
5. Use $\wedge/\vee/\lt;/\gt$ to select a desired content, and press **ENTER** (⊙) to move to the selected content directly.

! Note

- Depending on the region, the [LG Smart World], [My Apps] service and [Search] function may not be available.
- The [Search] function does not search content in every online services. It works only in certain online services.

Using the My Apps Menu

You can move or delete an installed application in the [My Apps] menu.

1. Press **HOME** (🏠).
2. Select the [My Apps], and press **ENTER** (⊙).

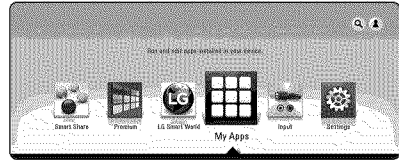

Move an application

1. Select an application, and press green (G) colored button to display the options.
2. Use \wedge/\vee to select [Move], and press **ENTER** (⊙).
3. Use $\wedge/\vee/\lt;/\gt$ to select a position you want to move to, and press **ENTER** (⊙).

Delete an application

1. Select an application, and press green (G) colored button to display the options.
2. Use \wedge/\vee to select [Delete], and press **ENTER** (⊙).
3. Use $\lt;/\gt$ to select [Yes], and press **ENTER** (⊙) to confirm.

! Note

Depending on the region, the [LG Smart World], [My Apps] service and [Search] function may not be available.

Troubleshooting

General

Symptom	Cause & Solution
The Power does not turned on.	<ul style="list-style-type: none"> • Plug the power cord into the wall outlet securely.
The connected USB storage device is not recognized.	<ul style="list-style-type: none"> • Try using different USB cable, some USB cables may not support enough current for normal USB operation. • If you use a USB extension cable or USB HUB, the USB devices may not be recognized. • A USB device which requires additional program installation when you have connected it to a computer is not supported. • This unit supports only USB Flash Drive and USB External HDD with FAT32 or NTFS format.
Cannot play video, photo or audio files.	<ul style="list-style-type: none"> • The files are not recorded in a format that the unit can play. • The unit does not support the codec of the video file.
The remote control does not work properly.	<ul style="list-style-type: none"> • The remote control is not pointed at the remote sensor of the unit. • The remote control is too far from the unit. • There is an obstacle in the path of the remote control and the unit. • The batteries in the remote control are exhausted.
The unit is plugged in, but the power will not turn on or off.	<p>You can reset the unit as follows.</p> <ul style="list-style-type: none"> • Unplug the power cord, wait at least five seconds, and then plug it in again.
The unit is not operating normally.	

Network

Symptom	Cause & Solution
Streaming video services (such as YouTube™, etc.) are often stopped or “buffer” during playback.	<ul style="list-style-type: none"> Your broadband service speed may not be fast enough to stream video services. Contact your Internet Service Provider (ISP) and increase the broadband speed is recommended.
Media servers are not displayed on the device list.	<ul style="list-style-type: none"> The firewall or anti-virus software on your media server is running. Turn off the firewall or anti-virus software running on your media server. The unit is not connected to the local area network that your media server is connected.
Cannot connect the unit to the access point or wireless LAN router.	<ul style="list-style-type: none"> The wireless communication may be interrupted from household devices that are using radio frequencies. Move the unit away from them.
Access point is not displayed on the “Access point name” list.	<ul style="list-style-type: none"> The access point or wireless LAN router may not broadcast its SSID. Set your access point to broadcast its SSID through your computer. Your network device such as access point may not set with available frequency range and channel that this unit can support. Try setting the frequency range and channel on the network device setting.

Picture

Symptom	Cause & Solution
There is no picture.	<ul style="list-style-type: none"> • Select the appropriate video input mode on the TV so the picture from the unit appears on the TV screen. • Connect the video connection securely. • Check the [HDMI Color Setting] in the [Settings] menu is set to the appropriate item that conforms to your video connection. • Your TV may not support the resolution you have set on the unit. Change the resolution that your TV accepts. • The unit's HDMI OUT jack is connected to a DVI device that does not support copyright protection.
Picture noise appears	<ul style="list-style-type: none"> • You are playing a file recorded in a colour system that is different from your TV. • Set the resolution which your TV accepts.

Sound

Symptom	Cause & Solution
There is no sound or the sound is distorted.	<ul style="list-style-type: none"> • The unit is in scan, slow motion, or pause mode. • The sound volume is low. • Check the wireless speaker connection. (page 13)

Customer Support

You can update the unit using the latest software to enhance the products operation and/or add new features. To obtain the latest software for this unit (if updates have been made), please visit <http://www.lg.com/global/support> or contact LG Electronics customer care center.

Open Source Software Notice

To obtain the corresponding source code under GPL, LGPL and other open source licenses, please visit <http://opensource.lge.com>. All referred license terms, warranty disclaimers and copyright notices are available to download with the source code.

Controlling a TV with the Supplied Remote Control

You can control your TV using the buttons below.

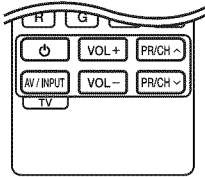

By pressing	You can
(TV POWER)	Turn the TV on or off.
AV/INPUT	Switch the TV's input source between the TV and other input sources.
VOL +/-	Adjust the volume of the TV
PR/CH ^ / V	Scan up or down through memorized channels.

Note

Depending on the unit being connected, you may not be able to control your TV using some of the buttons.

Setting up the remote to control your TV

You can operate your TV with the supplied remote control.

If your TV is listed in the table below, set the appropriate manufacturer code.

1. While holding down (TV POWER) button, and press the manufacturer code for your TV with the numerical buttons (see the table below).

Manufacturer	Code number
LG	1(Default), 2
Zenith	1, 3, 4
GoldStar	1, 2
Samsung	6, 7
Sony	8, 9
Hitachi	4

2. Release the (TV POWER) button to complete setting.

Depending on your TV, some or all buttons may not function on the TV, even after entering the correct manufacturer code. When you replace the batteries of the remote, the code number you have set may be reset to the default setting. Set the appropriate code number again.

Network Software Update

Network update notification

From time to time, performance improvements and/or additional features or services may be made available to units that are connected to a broadband home network. If there is new software available and the unit is connected to a broadband home network, the unit will inform you about the update as follows.

Option 1:

1. The update menu will appear on the screen when you turn off the unit.
2. Use **</>** to select a desired option and then press **ENTER (⊙)**.

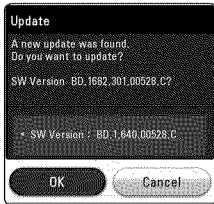

[OK]	Starts the software update.
[Cancel]	Exits the update menu and turns the power off.

Option 2:

If the software update is available from the update server, the "Update" icon appears in the Home menu. Press blue **(B)** colored button to start the update procedure.

Software update

You can update the unit using the latest software to enhance the products operation and/or add new features. You can update the software by connecting the unit directly to the software update server.

! Note

- Before updating the software in your unit, remove USB Device from the unit.
- Before updating the software in your unit, turn the unit off and then turn it back on.
- **During the software update procedure, do not turn off the unit or disconnect AC power, or do not press any button.**
- If you cancel the update, turn off the power and turn it on for stable performance.
- This unit cannot be updated to previous software version.

1. Check the network connection and settings (page 17).
2. Select [Software] option in the [Settings] menu then press **ENTER (⊙)**.
3. Select [Update] option, and press **ENTER (⊙)**.

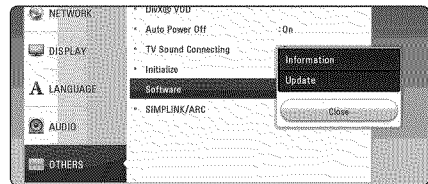

The unit will check for the newest update.

! Note

- Pressing **ENTER (⊙)** while checking for the update will end the process.
- If there is no update available, the Message, "No update is found." appears. Press **ENTER (⊙)** to return to the [Home Menu].

4. If newer version exists, the message "Do you want to download it?" appears.
5. Select [OK] to start update. (Selecting [Cancel] will end the update.)
6. The unit starts downloading the newest update from the server. (Downloading will takes several minutes depending on your home network condition)
7. When downloading is completed, the message, "Download is complete. Do you want to update?" appears.
8. Select [OK] to start updating. (Selecting [Cancel] will end the update and downloaded file will not be re-usable. To update software the next time, the software update procedure has to be started from the beginning again.)

**Caution**

Do not turn off the power during the software update.

9. When update is completed, the power will be turned off automatically in a few seconds.
10. Turn the power back on. The system now operates with the new version.

**Note**

The Software Update function may not work properly depending on your internet environment. In this case, you can obtain the latest software from the authorized LG Electronics Service Center then update your unit. Refer to "Customer Support" on page 53.

Additional Information

File requirement

Video files

File Location	File Extension	Codec Format	Audio Format	Subtitle
USB	“.avi”, “.mpg”, “.mpeg”, “.mkv”, “.mp4”, “.asf”, “.wmv”, “.m4v” (DRM free), “.vob”, “.3gp”, “.mov”, “.trp”, “.m2t”, “.mpe”, “.m1v”, “.m2v”, “.wm”	XVID, MPEG1 SS, H.264/MPEG-4 AVC, MPEG2 PS, MPEG2 TS, VC-1 SM (WMV3)	Dolby Digital, DTS, MP3, WMA, AAC, AC3	SubRip (.srt / .txt), SAMI (.smi), SubStation Alpha (.ssa/.txt), MicroDVD (.sub/.txt), VobSub (.sub), SubViewer 1.0 (.sub), SubViewer 2.0 (.sub/.txt), TMPlayer (.txt), DVD Subtitle System (.txt)
DLNA	“.avi”, “.mpg”, “.mpeg”, “.mkv”, “.mp4”, “.asf”, “.wmv”, “.m4v” (DRM free), “.mov”, “.trp”, “.m2t”, “.mpe”, “.m1v”, “.m2v”	XVID, MPEG1 SS, H.264/MPEG-4 AVC, MPEG2 PS, MPEG2 TS, VC-1 SM (WMV3)	Dolby Digital, DTS, MP3, WMA, AAC, AC3	SubRip (.srt / .txt), SAMI (.smi), SubStation Alpha (.ssa/.txt), MicroDVD (.sub/.txt), SubViewer 1.0 (.sub), SubViewer 2.0 (.sub/.txt), TMPlayer (.txt), DVD Subtitle System (.txt)

Audio files

File Location	File Extension	Sampling Frequency	Bitrate	Note
USB	“.mp3”, “.wma”, “.wav”, “.m4a” (DRM free), “.flac”	within 32 - 48 kHz (WMA), within 16 - 48 kHz (MP3)	within 32 - 192 kbps (WMA), within 32 - 320 kbps (MP3)	Some wav files are not supported on this unit.
DLNA	“.mp3”, “.wma”, “.wav”, “.m4a” (DRM free)	within 32 - 48 kHz (WMA), within 16 - 48 kHz (MP3)	within 32 - 192 kbps (WMA), within 32 - 320 kbps (MP3)	Some wav files are not supported on this unit.

Photo files

File Location	File Extension	Recommended Size	Note
USB, DLNA	“.jpg”, “.jpeg”, “.png”, “.gif”	Less than 4,000 x 3,000 x 24 bit/pixel Less than 3,000 x 3,000 x 32 bit/pixel	Progressive and lossless compression photo image files are not supported.

- Supplied bundle DLNA server for Macintosh edition has limitations in file compatibility, such as ASF, WMA and WMV.

Note

- The file name is limited to 180 characters.
- Maximum files/Folder: Less than 2000 (total number of files and folders)
- Depending on the size and number of the files, it may take several minutes to read the content on the media.
- File compatibility may differ depending on the server.
- Because the compatibility on DLNA server are tested on the bundle DLNA server (Nero MediaHome 4 Essentials Windows edition) environment, file requirements and playback functions may differ depending on media servers.
- The file requirements on page 57 are not always compatible. There may have some restrictions by file features and media server's ability.
- Playing video subtitle files are only available on DLNA media server created by supplied Nero MediaHome 4 Essentials software on this unit package.
- The files from removable media such as USB drive etc. on your media server may not be shared properly.
- This unit cannot support the ID3 Tag embedded MP3 file.
- The total playback time of audio file indicated on the screen may not correct for VBR files.
- HD video files contained on the USB 1.0/1.1 may not played properly. USB 2.0 are recommended to play back HD video files.
- This unit supports H.264/MPEG-4 AVC profile Main, High at Level 4.1. A file with higher level may not be supported.
- This unit does not support files that are recorded with GMC*¹ or Qpel*².

*1 GMC – Global Motion Compensation

*2 Qpel – Quarter pixel

Note

- A "avi" file which is encoded "WMV 9 codec" is not supported.
- This unit supports UTF-8 files even it contains Unicode subtitle content. This unit can not support the pure Unicode subtitle files.
- Depending on the types of file or ways of recording, it may not play back.
- To be playback a video file, video file name and Subtitle file name must be the same.
- When you play a video file with a extension such as ".ts", ".m2ts", ".mts", ".tp", ".Trp" or ".m2t", your unit may not support subtitle files.
- The total playback time of audio file indicated on the screen may not correct for VBR files.
- Video / Audio codec compatibility may differ depending on video file.

About DLNA

This Player is a DLNA Certified digital media player that can display and play video, photo and audio content from your DLNA-compatible digital media server (PC and Consumer Electronics).

The Digital Living Network Alliance (DLNA) is a cross-industry organization of consumer electronics, computing industry and mobile device companies. Digital Living provides consumers with easy sharing of digital media through your home network.

The DLNA certification logo makes it easy to find products that comply with the DLNA Interoperability Guidelines. This unit complies with DLNA Interoperability Guidelines v1.5.

When a PC running DLNA server software or other DLNA compatible device is connected to this player, some setting changes of software or other devices may be required. Please refer to the operating instructions for the software or device for more information.

Certain system requirements

For high definition video playback:

- High definition display that has HDMI input jack.
- HDMI or HDCP capable DVI input on your display device is required for some content (as specified by disc authors).

Audio Output Specifications

Jack/Setting Source	HDMI OUT			
	PCM Stereo	PCM Multi-Ch	DTS Re-encode *3	Bit Stream *1*2
Dolby Digital	PCM 2ch	PCM 5.1ch	DTS	Dolby Digital
Dolby Digital Plus	PCM 2ch	PCM 5.1ch	DTS	Dolby Digital Plus
Dolby TrueHD	PCM 2ch	PCM 5.1ch	DTS	Dolby TrueHD
DTS	PCM 2ch	PCM 5.1ch	DTS	DTS
DTS-HD	PCM 2ch	PCM 5.1ch	DTS	DTS-HD
Linear PCM 2ch	PCM 2ch	PCM 2ch	DTS	Linear PCM 2ch
Linear PCM 5.1ch	PCM 2ch	PCM 5.1ch	DTS	Linear PCM 5.1ch
Linear PCM 7.1ch	PCM 2ch	PCM 5.1ch	DTS	Linear PCM 7.1ch

*1 The secondary and interactive audio may not be included in the output bitstream if [Digital Output] option is set to [Bit Stream]. (Except LPCM Codec : the output always include interactive and secondary audio.)

*2 This unit automatically selects the HDMI audio according to the decoding capability of the connected HDMI device even though [Digital Output] option is set to [Bit Stream].

*3 If the [Digital Output] option is set to [DTS re-encode], the audio output is limited to 48 kHz and 5.1Ch.

- If the audio format of the digital output does not match the capabilities of your receiver, the receiver will produce a strong, distorted sound or no sound at all.
- Multi-channel Digital Surround Sound via digital connection can only be obtained if your receiver is equipped with a Digital Multi-channel decoder.
- This setting is not available on the input signal from an external device.

Trademarks and Licenses



The terms HDMI and HDMI High-Definition Multimedia Interface, and the HDMI logo are trademarks or registered trademarks of HDMI Licensing LLC in the United States and other countries.



Manufactured under license from Dolby Laboratories. Dolby and the double-D symbol are trademarks of Dolby Laboratories.



Manufactured under license under U.S. Patent Nos: 5,956,674; 5,974,380; 6,487,535 & other U.S. and worldwide patents issued & pending. DTS, the Symbol, & DTS and the Symbol together are registered trademarks & DTS 2.0 Channel is a trademark of DTS, Inc. Product includes software. © DTS, Inc. All Rights Reserved.



DivX®, DivX Certified® and associated logos are trademarks of Rovi Corporation or its subsidiaries and are used under license.



DLNA®, the DLNA Logo and DLNA CERTIFIED® are trademarks, service marks, or certification marks of the Digital Living Network Alliance.



The Wi-Fi CERTIFIED Logo is a certification mark of the Wi-Fi Alliance.



The Wi-Fi Protected Setup Mark is a trademark of the Wi-Fi Alliance.



Bluetooth® wireless technology is a system which allows radio contact between electronic devices within a max. range of 10 meters.

Connecting individual devices under **Bluetooth**® wireless technology does not incur any charges. A mobile phone with **Bluetooth**® wireless technology can be operated via the Cascade if the connection was made via **Bluetooth**® wireless technology.

The **Bluetooth**® word mark and logos are owned by the **Bluetooth**® SIG, Inc. and any use of such marks by LG Electronics is under license.

Other trademarks and trade names are those of their respective owners.

Cinavia Notice

This product uses Cinavia technology to limit the use of unauthorized copies of some commercially-produced film and videos and their soundtracks. When a prohibited use of an unauthorized copy is detected, a message will be displayed and playback or copying will be interrupted.

More information about Cinavia technology is provided at the Cinavia Online Consumer Information Center at <http://www.cinavia.com>. To request additional information about Cinavia by mail, send a postcard with your mailing address to: Cinavia Consumer Information Center, P.O. Box 86851, San Diego, CA, 92138, USA.

This product incorporates proprietary technology under license from Verance Corporation and is protected by U.S. Patent 7,369,677 and other U.S. and worldwide patents issued and pending as well as copyright and trade secret protection for certain aspects of such technology. Cinavia is a trademark of Verance Corporation. Copyright 2004-2012 Verance Corporation. All rights reserved by Verance. Reverse engineering or disassembly is prohibited.



Gracenote®, Gracenote logo and logotype, and the “Powered by Gracenote” logo are either registered trademarks or trademarks of Gracenote, Inc. in the United States and/or other countries.

Music recognition technology and related data are provided by Gracenote®.

Portions of the content is copyright © Gracenote or its providers.

Gracenote® End User License Agreement

This application or device contains software from Gracenote, Inc. of Emeryville, California (“Gracenote”). The software from Gracenote (the “Gracenote Software”) enables this application to perform disc and/or file identification and obtain music-related information, including name, artist, track, and title information (“Gracenote Data”) from online servers or embedded databases (collectively, “Gracenote Servers”) and to perform other functions. You may use Gracenote Data only by means of the intended End-User functions of this application or device.

You agree that you will use Gracenote Data, the Gracenote Software, and Gracenote Servers for your own personal non-commercial use only. You agree not to assign, copy, transfer or transmit the Gracenote Software or any Gracenote Data to any third party. YOU AGREE NOT TO USE OR EXPLOIT GRACENOTE DATA, THE GRACENOTE SOFTWARE, OR GRACENOTE SERVERS, EXCEPT AS EXPRESSLY PERMITTED HEREIN.

You agree that your non-exclusive license to use the Gracenote Data, the Gracenote Software, and Gracenote Servers will terminate if you violate these restrictions. If your license terminates, you agree to cease any and all use of the Gracenote Data, the Gracenote Software, and Gracenote Servers. Gracenote reserves all rights in Gracenote Data, the Gracenote Software, and the Gracenote Servers, including all ownership rights. Under no circumstances will Gracenote become liable for any payment to you for any information that you provide. You agree that Gracenote, Inc. may enforce its rights under this Agreement against you directly in its own name.

The Gracenote service uses a unique identifier to

track queries for statistical purposes. The purpose of a randomly assigned numeric identifier is to allow the Gracenote service to count queries without knowing anything about who you are. For more information, see the web page for the Gracenote Privacy Policy for the Gracenote service.

The Gracenote Software and each item of Gracenote Data are licensed to you “AS IS.” Gracenote makes no representations or warranties, express or implied, regarding the accuracy of any Gracenote Data from in the Gracenote Servers. Gracenote reserves the right to delete data from the Gracenote Servers or to change data categories for any cause that Gracenote deems sufficient. No warranty is made that the Gracenote Software or Gracenote Servers are error-free or that functioning of Gracenote Software or Gracenote Servers will be uninterrupted. Gracenote is not obligated to provide you with new enhanced or additional data types or categories that Gracenote may provide in the future and is free to discontinue its services at any time.

GRACENOTE DISCLAIMS ALL WARRANTIES EXPRESS OR IMPLIED, INCLUDING, BUT NOT LIMITED TO, IMPLIED WARRANTIES OF MERCHANTABILITY, FITNESS FOR A PARTICULAR PURPOSE, TITLE, AND NON-INFRINGEMENT. GRACENOTE DOES NOT WARRANT THE RESULTS THAT WILL BE OBTAINED BY YOUR USE OF THE GRACENOTE SOFTWARE OR ANY GRACENOTE SERVER. IN NO CASE WILL GRACENOTE BE LIABLE FOR ANY CONSEQUENTIAL OR INCIDENTAL DAMAGES OR FOR ANY LOST PROFITS OR LOST REVENUES.

© Gracenote, Inc. 2009

Specifications

General	
Power requirements	AC 100 V - 240 V, 50 / 60 Hz
Power consumption	DC 25 V  33 W
Dimensions (W x H x D)	1 038 mm x 71 mm x 49 mm (40.9 inches x 2.8 inches x 1.9 inches)
Net Weight (Approx.)	2.5 kg (5.5 lbs)
Operating temperature	5 °C to 35 °C (41 °F to 95 °F)
Operating humidity	5 % to 90 %

Inputs/Outputs	
HDMI OUT (Video/Audio)	19 pin (Type A, HDMI™ Connector) x 1
DIGITAL OPTICAL IN (Audio)	3 V (p-p), Optical jack x 1

Amplifier	
Total	300 W
Front	80 W x 2 (4 Ω, THD 10 %)
Subwoofer	140 W (3 Ω, THD 10 %)

Wireless subwoofer	
Power requirements	AC 120 V, 60 Hz
Power consumption	40 W
Type	1 Way 1 speaker
Impedance	3 Ω
Rated input power	140 W
Max. input power	280 W
External dimensions (WxHxD)	196 mm x 390 mm x 297 mm (7.7 inches x 15.4 inches x 11.7 inches)
Net Weight	5.54 kg (12.2 lbs)

System	
Signal system	Standard NTSC color TV system
LAN port	Ethernet jack x 1, 10BASE-T / 100BASE-TX
Wireless LAN (internal antenna)	IEEE 802.11b/g/n (2.4 GHz band)
Bus Power Supply (USB)	DC 5 V  500 mA

- Design and specifications are subject to change without notice.

Maintenance

Handling the unit

When shipping the unit

Please save the original shipping carton and packing materials. If you need to ship the unit, for maximum protection, re-pack the unit as it was originally packed at the factory.

Cleaning the unit

To clean the player, use a soft, dry cloth. If the surfaces are extremely dirty, use a soft cloth lightly moistened with a mild detergent solution. Do not use strong solvents such as alcohol, benzine, or thinner, as these might damage the surface of the unit.

Keeping the exterior surfaces clean

- Do not use volatile liquids such as insecticide spray near the unit.
- Wiping with strong pressure may damage the surface.
- Do not leave rubber or plastic products in contact with the unit for a long period of time.

Maintaining the unit

The unit is a high-tech, precision device. If the optical pick-up lens and disc drive parts are dirty or worn, the picture quality could be diminished. For details, please contact your nearest authorized service center.

Important Information relating to Network Services

All information, data, documents, communications, downloads, files, text, images, photographs, graphics, videos, webcasts, publications, tools, resources, software, code, programs, applets, widgets, applications, products and other content ("Content") and all services and offerings ("Services") provided or made available by or through any third party (each a "Service Provider") is the sole responsibility of the Service Provider from whom it originated.

The availability of and access to Content and Services furnished by the Service Provider through the LGE Device are subject to change at any time, without prior notice, including, but not limited to the suspension, removal or cessation of all or any part of the Content or Services.

Should you have any inquiry or problem related to the Content or Services, you may refer to the Service Provider's website for the most up-to-date information. LGE is neither responsible nor liable for customer service related to the Content and Services. Any question or request for service relating to the Content or Services should be made directly to the respective Content and Service Providers.

Please note that LGE is not responsible for any Content or Services provided by the Service Provider or any changes to, removal of, or cessation of such Content or Services and does not warrant or guaranty the availability of or access to such Content or Services.

