

If you have questions or comments, contact us.

1-800-4-DEWALT • www.dewalt.com

INSTRUCTION MANUAL

# DEWALT®

DW716  
12" (305 mm) Double Bevel Compound Miter Saw

DEWALT Industrial Tool Co., 701 Joppa Road, Baltimore, MD 21286

(AUG09) Part No. N039235 DW716 Copyright © 2005, 2008, 2009 DEWALT

The following are trademarks for one or more DEWALT power tools: the yellow and black color scheme; the "D" shaped air intake grill; the array of pyramids on the handgrip; the kit box configuration; and the array of lozenge-shaped humps on the surface of the tool.

### Definitions: Safety Guidelines

The definitions below describe the level of severity for each signal word. Please read the manual and pay attention to these symbols.

**▲ DANGER:** Indicates an imminently hazardous situation which, if not avoided, **will** result in **death or serious injury**.

**▲ WARNING:** Indicates a potentially hazardous situation which, if not avoided, **could** result in **death or serious injury**.

**▲ CAUTION:** Indicates a potentially hazardous situation which, if not avoided, **may** result in **minor or moderate injury**.

**NOTICE:** Indicates a practice **not related to personal injury** which, if not avoided, **may** result in **property damage**.

IF YOU HAVE ANY QUESTIONS OR COMMENTS ABOUT THIS OR ANY DEWALT TOOL, CALL US TOLL FREE AT: 1-800-4-DEWALT (1-800-433-9258)

### IMPORTANT SAFETY INSTRUCTIONS

**▲ WARNING:** When using electric tools, basic safety precautions should always be followed to reduce risk of fire, electric shock, and personal injury, including the following:

#### READ ALL INSTRUCTIONS

#### Double Insulation

Double insulated tools are constructed throughout with two separate layers of electrical insulation or one double thickness of insulation between you and the tool's electrical system. Tools built with this insulation system are not intended to be grounded. As a result, your tool is equipped with a two prong plug which permits you to use extension cords without concern for maintaining a ground connection.

**NOTE:** Double insulation does not take the place of normal safety precautions when operating this tool. The insulation system is for added protection against injury resulting from a possible electrical insulation failure within the tool.

**▲ CAUTION:** WHEN SERVICING USE ONLY IDENTICAL REPLACEMENT PARTS. Repair or replace damaged cords.

#### Polarized Plugs

Polarized plugs (one blade is wider than the other) are used on equipment to reduce the risk of electric shock. When provided, this plug will fit in the polarized outlet only one way. If the plug does not fit fully in the outlet, reverse the plug. If it still does not fit, contact a qualified electrician to install the proper outlet. Do not change the plug in any way.

#### Safety Instructions For All Tools

This miter saw accepts the DEWALT worklight and laser attachments.

**▲ WARNING:** To reduce the risk of eye injury, ALWAYS use eye protection when operating the miter saw.

- **KEEP GUARD IN PLACE** and in working order.
- **REMOVE ADJUSTING KEYS AND WRENCHES.** Form habit of checking to see that keys and adjusting wrenches are removed from spindle before turning tool on. Tools, scrap pieces, and other debris can be thrown at high speed, causing injury.
- **KEEP WORK AREA CLEAN.** Cluttered areas and benches invite accidents.
- **DO NOT USE THE MACHINE IN A DANGEROUS ENVIRONMENT.** The use of power tools in damp or wet locations or in rain can cause shock or electrocution. Keep your work area well-lit to avoid tripping or placing arms, hands, and fingers in danger.
- **KEEP CHILDREN AWAY.** All visitors should be kept at a safe distance from work area. Your shop is a potentially dangerous environment.
- **MAKE WORKSHOP CHILDPROOF** with padlocks, master switches, or by removing starter keys. The unauthorized start-up of a machine by a child or visitor may result in injury.
- **DON'T FORCE TOOL.** It will do the job better and be safer at the rate for which it was designed.
- **USE RIGHT TOOL.** Don't force tool or attachment to do a job for which it was not designed. Using the incorrect tool or attachment may result in personal injury.
- **WEAR PROPER APPAREL.** No loose clothing, gloves, neckties, rings, bracelets, or other jewelry to get caught in moving parts. Non-slip footwear is recommended. Wear protective hair covering to contain long hair. Air vents may cover moving parts and should also be avoided.

• **ALWAYS USE SAFETY GLASSES.** Everyday eyeglasses are NOT safety glasses. Also use face or dust mask if cutting operation is dusty. **ALWAYS WEAR CERTIFIED SAFETY EQUIPMENT:**

- ANSI Z87.1 eye protection (CAN/CSA Z94.3)
- ANSI S12.6 (S3.19) hearing protection
- NIOSH/OSHA/MSHA respiratory protection
- **SECURE THE WORKPIECE.** Use clamps or a vise to hold the workpiece on the table and against the fence or when your hand will be dangerously close to the blade within 6" (152 mm). It is safer than using your hand and it frees both hands to operate tool.
- **DON'T OVERREACH.** Keep proper footing and balance at all times. Loss of balance may cause personal injury.
- **MAINTAIN TOOLS WITH CARE.** Keep tools sharp and clean for best and safest performance. Follow instructions for lubricating and changing accessories. Poorly maintained tools and machines can further damage the tool or machine and/or cause injury.
- **TURN THE MACHINE "OFF", AND DISCONNECT THE MACHINE FROM THE POWER SOURCE** before installing or removing accessories, before adjusting or changing set-ups, when making repairs or changing locations. An accidental start-up can cause injury. Do not touch the plug's metal prongs when unplugging or plugging in the cord.
- **REDUCE THE RISK OF UNINTENTIONAL STARTING.** Make sure that the switch is in the "OFF" position before plugging in the power cord.
- **USE PROPER EXTENSION CORD.** Make sure your extension cord is in good condition. If your product is equipped with a cordset, use only 3-wire extension cords that have 3-prong grounding-type plugs and 3-pole receptacles that accept the tool's plug. When using an extension cord, be sure to use one heavy enough to carry the current your product will draw. An undersized cord will cause a drop in line voltage resulting in loss of power and overheating. The following table shows the correct size to use depending on cord length and nameplate ampere rating. If in doubt, use the next heavier gauge. The smaller the gauge number, the heavier the cord.

Ampere Rating		Minimum Gauge for Cord Sets				
		Volts	Total Length of Cord in Feet (meters)			
More Than	Not More Than	120V	25 (7.6)	50 (15.2)	100 (30.5)	150 (45.7)
		240V	50 (15.2)	100 (30.5)	200 (61.0)	300 (91.4)
		AWG				
0	6		18	16	16	14
6	10		18	16	14	12
10	12		16	16	14	12
12	16		14	12	Not Recommended	

- **CHECK FOR DAMAGED PARTS.** Before further use of the tool, a guard or other part that is damaged should be carefully checked to determine that it will operate properly and perform its intended function—check for alignment of moving parts, binding of moving parts, breakage of parts, mounting and any other conditions that may affect its operation. A guard or other part that is damaged should be properly repaired or replaced. Do not use tool if switch does not turn it on and off.
- **USE RECOMMENDED ACCESSORIES.** Use only accessories that are recommended by the manufacturer for your model. Accessories that may be suitable for one tool may be hazardous when used on another tool. Consult the instruction manual for recommended accessories. The use of improper accessories may cause risk of injury to persons.
- **NEVER STAND ON TOOL.** Serious injury could occur if the tool is tipped or if the cutting tool is unintentionally contacted.
- **NEVER LEAVE TOOL RUNNING UNATTENDED. TURN POWER OFF.** Don't leave tool until it comes to a complete stop. Serious injury can result.
- **DO NOT OPERATE ELECTRIC TOOLS NEAR FLAMMABLE LIQUIDS OR IN GASEOUS OR EXPLOSIVE ATMOSPHERES.** Motors in these tools may spark and ignite fumes.
- **STAY ALERT, WATCH WHAT YOU ARE DOING, AND USE COMMON SENSE. DO NOT USE THE MACHINE WHEN YOU ARE TIRED OR UNDER THE INFLUENCE OF DRUGS OR ALCOHOL.** A moment of inattention while operating power tools may result in injury.

#### Additional Safety Rules For Miter Saws

**▲ WARNING:** Do not allow familiarity (gained from frequent use of your saw) to replace safety rules. Always remember that a careless fraction of a second is sufficient to inflict severe injury.

- **DO NOT OPERATE THIS MACHINE** until it is completely assembled and installed according to the instructions. A machine incorrectly assembled can cause serious injury.
- **OBTAIN ADVICE** from your supervisor, instructor, or another qualified person if you are not thoroughly familiar with the operation of this machine. Knowledge is safety.
- **STABILITY.** Make sure the miter saw is placed on a secure supporting surface and does not slip or move during use. If the mobility kit is installed, raise the moveable caster(s) so saw is in its stationary position.
- **FOLLOW ALL WIRING CODES** and recommended electrical connections to prevent shock or electrocution. Protect electric supply line with at least a 15 ampere time-delay fuse or a circuit breaker."
- **MAKE CERTAIN** the blade rotates in the correct direction. The teeth on the blade should point in the direction of rotation as marked on the saw.
- **TIGHTEN ALL CLAMP HANDLES,** knobs and levers prior to operation. Loose clamps can cause parts or the workpiece to be thrown at high speeds.
- **BE SURE** all blade and blade clamps are clean, recessed sides of blade clamps are against blade and arbor screw is tightened securely. Loose or improper blade clamping may result in damage to the saw and possible personal injury.
- **ALWAYS USE A SHARP BLADE.** Check the blade to see if it runs true and is free from vibration. A dull or a vibrating blade can cause damage to the machine and/or serious injury."
- **DO NOT OPERATE ON ANYTHING OTHER THAN THE DESIGNATED VOLTAGE** for the saw. Overheating, damage to the tool and personal injury may occur.
- **DO NOT WEDGE ANYTHING AGAINST THE FAN** to hold the motor shaft. Damage to tool and possible personal injury may occur.
- **DO NOT** force cutting action. Stalling or partial stalling of motor can cause damage. To the machine or blade and/or serious injury.
- **ALLOW THE MOTOR TO COME TO FULL SPEED** prior to starting cut. Starting the cut too soon may cause damage to the machine or blade and/or serious injury."
- **NEVER CUT FERROUS METALS** (Those with any iron or steel content) or masonry. Either of these can cause the carbide tips to fly off the blade at high speeds causing serious injury.
- **DO NOT USE ABRASIVE WHEELS.** The excessive heat and abrasive particles generated by them may damage the saw and cause personal injury.
- **NEVER** have any part of your body in line with the path of the saw blade. Personal injury will occur.
- **NEVER** apply blade lubricant to a running blade. Applying lubricant could cause your hand to move into the blade resulting in serious injury.
- **DO NOT** place either hand in the blade area when the saw is connected to the power source. Inadvertent blade activation may result in serious injury.
- **DO NOT PERFORM FREE-HAND OPERATIONS** (workpiece not supported by table and fence). Hold the work firmly against the fence and table. Free-hand operations on a miter saw could cause the workpiece to be thrown at high speeds, causing serious injury.
- **NEVER REACH AROUND** or behind the saw blade. A blade can cause serious injury.
- **DO NOT** reach underneath the saw unless it is unplugged and turned off. Contact with saw blade may cause personal injury.
- **SECURE THE MACHINE TO A STABLE SUPPORTING SURFACE.** Vibration can possibly cause the machine to slide, walk, or tip over, causing serious injury.
- **USE ONLY CROSSCUT SAW BLADES** recommended for miter saws. For best results, do not use carbide tipped blades with hook angles in excess of 7 degrees. Do not use blades with deep gullets. These can deflect and contact the guard, and can cause damage to the machine and/or serious injury.
- **USE ONLY BLADES OF THE CORRECT SIZE AND TYPE** specified for this tool to prevent damage to the machine and/or serious injury.
- **INSPECT BLADE FOR CRACKS** or other damage prior to operation. A cracked or damaged blade can come apart and pieces can be thrown at high speeds, causing serious injury. Replace cracked or damaged blades immediately.
- **CLEAN THE BLADE AND BLADE CLAMPS** prior to operation. Cleaning the blade and blade clamps allows you to check for any damage to the blade or blade clamps. A cracked or damaged blade or blade clamp can come apart and pieces can be thrown at high speeds, causing serious injury.

- **DO NOT** use lubricants or cleaners (particularly spray or aerosol) in the vicinity of the plastic guard. The polycarbonate material used in the guard is subject to attack by certain chemicals.
- **ALWAYS USE THE KERF PLATE AND REPLACE THIS PLATE WHEN DAMAGED.** Small chip accumulation under the saw may interfere with the saw blade or may cause instability of workpiece when cutting.
- **USE ONLY BLADE CLAMPS** specified for this tool to prevent damage to the machine and/or serious injury.
- **CLEAN THE MOTOR AIR SLOTS** of chips and sawdust. Clogged motor air slots can cause the machine to overheat, damaging the machine and possibly causing a short which could cause serious injury.
- **KEEP ARMS, HANDS, AND FINGERS** away from the blade to prevent severe cuts. Clamp all workpieces that would cause your hand to be within 6" (152 mm) of the saw blade.
- **NEVER LOCK THE SWITCH IN THE "ON" position.** Severe personal injury may result.
- **TURN OFF THE MACHINE** and allow the blade to come to a complete stop before raising the arm and prior to cleaning the blade area, removing debris in the path of the blade, before servicing or adjusting tool. A moving blade can cause serious injury.
- **PROPERLY SUPPORT LONG OR WIDE WORKPIECES.** Loss of control of the workpiece can cause injury.
- **NEVER** cross arms in front of blade while using tool. Always make a dry run (unpowered) before making a finish cut so that you can check the path of the blade or severe personal injury may result.
- **ADDITIONAL INFORMATION** regarding the safe and proper operation of power tools (i.e. a safety video) is available from the Power Tool Institute, 1300 Summer Avenue, Cleveland, OH 44115-2851 ([www.powertoolinstitute.com](http://www.powertoolinstitute.com)). Information is also available from the National Safety Council, 1121 Spring Lake Drive, Itasca, IL 60143-3201. Please refer to the American National Standards Institute ANSI O1.1 Safety Requirements for Woodworking Machines and the U.S. Department of Labor OSHA 1910.213 Regulations.

**⚠ WARNING:** Do not connect unit to electrical power source until complete instructions are read and understood.

**⚠ WARNING:** Always wear proper personal hearing protection that conforms to ANSI S12.6 (S3.19) during use. Under some conditions and duration of use, noise from this product may contribute to hearing loss.

**⚠ WARNING:** NEVER MAKE ANY CUT UNLESS THE MATERIAL IS SECURED ON THE TABLE AND AGAINST THE FENCE.

**⚠ WARNING:** Some dust created by power sanding, sawing, grinding, drilling, and other construction activities contains chemicals known to cause cancer, birth defects or other reproductive harm. Some examples of these chemicals are:

- lead from lead-based paints,
- crystalline silica from bricks and cement and other masonry products, and
- arsenic and chromium from chemically-treated lumber (CCA).

Your risk from these exposures varies, depending on how often you do this type of work. To reduce your exposure to these chemicals: work in a well ventilated area, and work with approved safety equipment, such as those dust masks that are specially designed to filter out microscopic particles.

• Avoid prolonged contact with dust from power sanding, sawing, grinding, drilling, and other construction activities. Wear protective clothing and wash exposed areas with soap and water. Allowing dust to get into your mouth, eyes, or lay on the skin may promote absorption of harmful chemicals.

**⚠ WARNING:** Use of this tool can generate and/or disburse dust, which may cause serious and permanent respiratory or other injury. Always use NIOSH/OSHA approved respiratory protection appropriate for the dust exposure. Direct particles away from face and body.

For your convenience and safety, the following warning labels are on your miter saw.

#### ON MOTOR HOUSING:

**⚠ WARNING:** FOR YOUR OWN SAFETY, READ INSTRUCTION MANUAL BEFORE OPERATING SAW.

WHEN SERVICING, USE ONLY IDENTICAL REPLACEMENT PARTS.

ALWAYS WEAR EYE PROTECTION.

DO NOT EXPOSE TO RAIN OR USE IN DAMP LOCATIONS.

#### ON MOVING FENCES:

ALWAYS ADJUST FENCE PROPERLY BEFORE USE. CLAMP SMALL PIECES BEFORE CUTTING. SEE MANUAL.



ALWAYS ADJUST FENCE PROPERLY BEFORE USE. CLAMP SMALL PIECES BEFORE CUTTING. SEE MANUAL.  
AJUSTE LA GUÍA DEBIDAMENTE ANTES DE UTILIZAR LA HERRAMIENTA. ASEGURE LAS PIEZAS PEQUEÑAS ANTES DE CORTARLAS. CONSULTA EL MANUAL.  
TOUTOUMPAR RÉGLER LE GUIDE AVANT D'UTILISER L'OUTIL. CLAMPETTES LES PETITS OBJETS AVANT DE LES SCIER. CONSULTEZ LE GUIDE D'UTILISATION.

#### ON GUARD:

**DANGER - KEEP AWAY FROM BLADE.**

#### ON UPPER GUARD:

PROPERLY SECURE BRACKET WITH BOTH SCREWS BEFORE USE.

#### ON TABLE: (2 PLACES)

**⚠ WARNING:** FOR YOUR OWN SAFETY, READ INSTRUCTION MANUAL BEFORE OPERATING MITER SAW. KEEP HANDS OUT OF PATH OF SAW BLADE. DO NOT OPERATE SAW WITHOUT GUARDS IN PLACE. CHECK LOWER GUARD FOR PROPER CLOSING BEFORE EACH USE. ALWAYS TIGHTEN ADJUSTMENT KNOBS BEFORE USE. DO NOT PERFORM ANY OPERATION FREEHAND. NEVER REACH IN BACK OF SAW BLADE. NEVER CROSS ARMS IN FRONT OF BLADE. TURN OFF TOOL AND WAIT FOR SAW BLADE TO STOP BEFORE MOVING WORKPIECE, CHANGING SETTINGS OR MOVING HANDS. DISCONNECT POWER BEFORE CHANGING BLADE OR SERVICING. TO REDUCE THE RISK OF INJURY, RETURN CARRIAGE TO THE FULL REAR POSITION AFTER EACH CROSSCUT OPERATION. THINK! YOU CAN PREVENT ACCIDENTS.

#### ON BASE: (2 PLACES)



### Electrical Connection

Be sure your power supply agrees with the nameplate marking. 120 volts, AC means that your saw will operate on alternating current. The switch is susceptible to failure if direct current is used. A voltage decrease of 10 percent or more will cause a loss of power and overheating. All DEWALT tools are factory tested. If this tool does not operate, check the power supply.

### Accessories

**⚠ WARNING:** Since accessories, other than those offered by DEWALT, have not been tested with this product, use of such accessories with this tool could be hazardous. To reduce the risk of injury, only DEWALT, recommended accessories should be used with this product.

Recommended accessories for use with your tool are available for purchase from your local dealer or authorized service center. If you need assistance in locating any accessory for your tool, please contact DEWALT Industrial Tool Co., 701 East Joppa Road, Baltimore, MD 21286, call 1-800-4-DEWALT (1-800-433-9258) or visit our website [www.dewalt.com](http://www.dewalt.com).

#### OPTIONAL ACCESSORIES (FIG. 1)

The following accessories, designed for your saw, may be helpful. In some cases, other locally obtained work supports, length stops, clamps, etc., may be more appropriate. Use care in selecting and using accessories.

##### Laser Guide System: DW7187

Laser is available at extra cost from DEWALT Service Centers and your home improvement retailer. Instructions for installation are included with the accessory. Read and follow all directions for safe installation and use (not shown).

##### Extension, Work Support: DW7080

Used to support long overhanging workpieces, the work support is user assembled. Your saw table is designed to accept two work supports, one on each side.

##### Adjustable Length Stop: DW7051

Requires the use of one work support. It is used to make repetitive cuts of the same length from 0 to 42" (0-107 cm).

##### Clamp: DW7082

Used for firmly clamping workpiece to the saw table for precision cutting.

FIG. 1

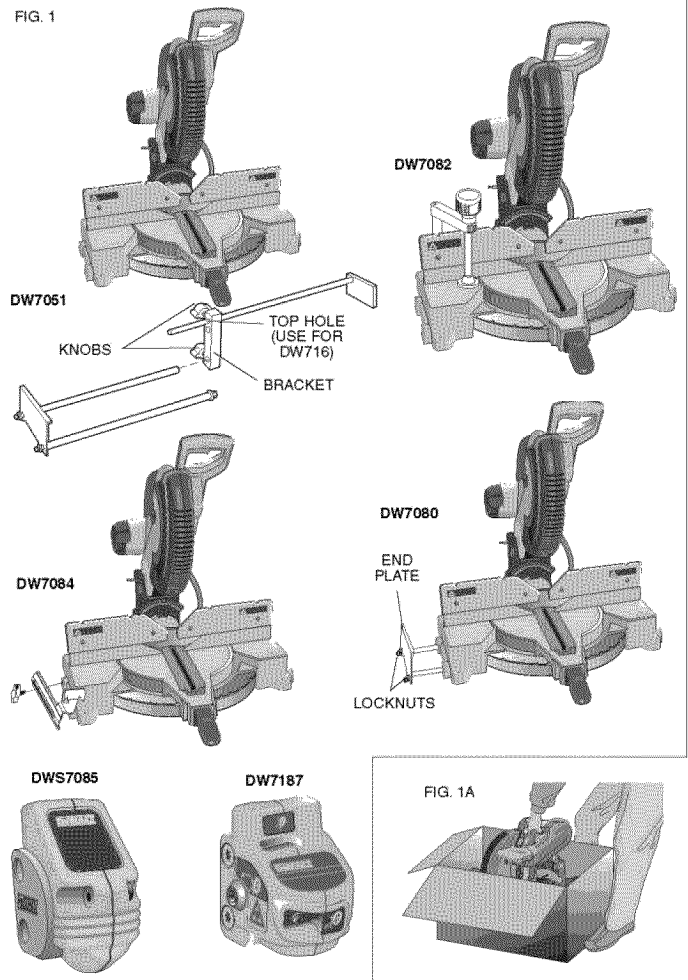

FIG. 2

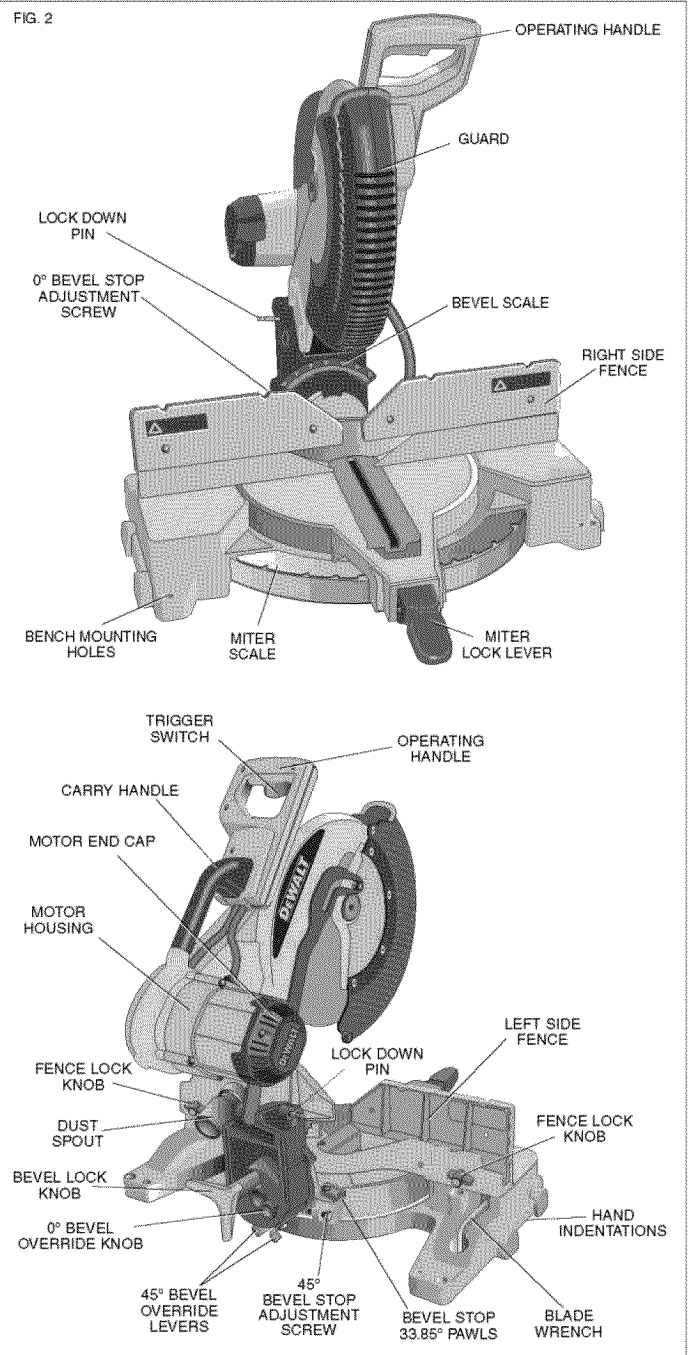

FIG. 3

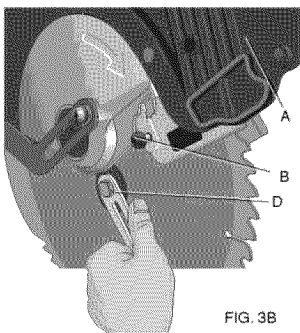

FIG. 3A

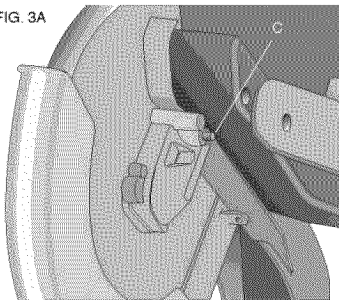

FIG. 3B

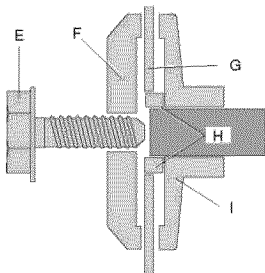

FIG. 4

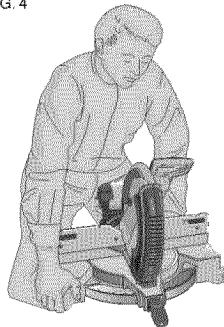

FIG. 5

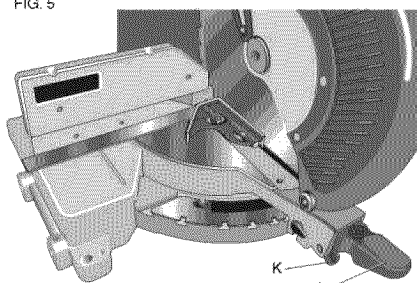

FIG. 6

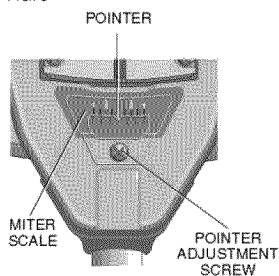

FIG. 7

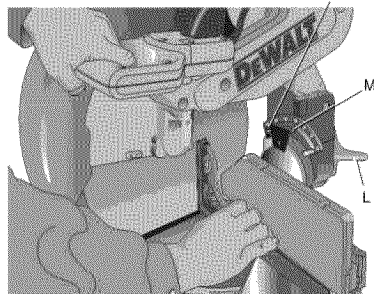

FIG. 8

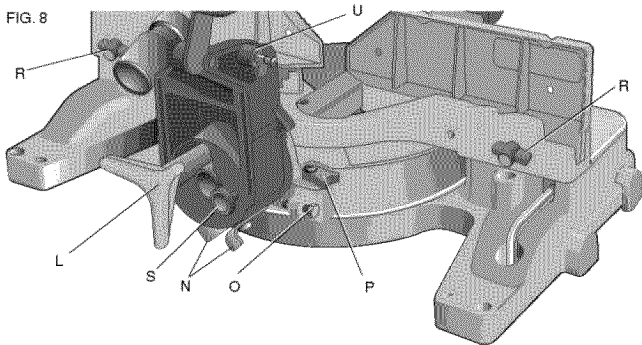

FIG. 9

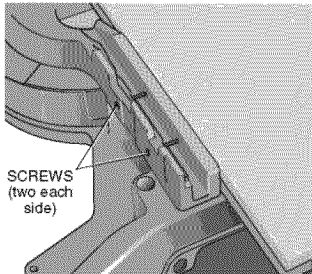

FIG. 10

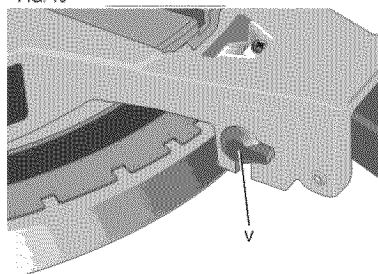
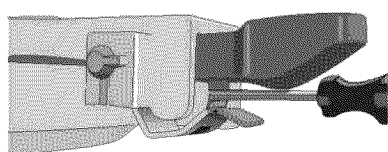

FIG. 11

**Dust Bag: DW7053 (Included with some models)**

Equipped with a zipper for easy emptying, the dust bag will capture the majority of the sawdust produced (not shown).

**Crown Molding Fence: DW7084**

Used for precision cutting of crown molding.

**Kerf Plate Blank: DW7055**

Used to limit back side tear out of material or as a replacement kerf plate (not shown).

**Miter Saw LED Worklight System: DWS7085**

Lighting used for greater visibility and cutting alignment during operation. Easy to install.

**SAW BLADES:** ALWAYS USE 12" (305 mm) SAW BLADES WITH 1" (25.4 mm) ARBOR HOLES. SPEED RATING MUST BE AT LEAST 4800 RPM. Never use a smaller diameter blade. It will not be guarded properly. Use crosscut blades only! Do not use blades designed for ripping, combination blades or blades with hook angles in excess of 7°.

BLADE DESCRIPTIONS		
APPLICATION	DIAMETER	TEETH
<b>Construction Saw Blades</b> ( <i>thin kerf with anti-stick rim</i> )		
General Purpose	12" (305 mm)	40
Fine Crosscuts	12" (305 mm)	60
<b>Woodworking Saw Blades</b> ( <i>provide smooth, clean cuts</i> )		
Fine crosscuts	12" (305 mm)	80
Non-ferrous metals	12" (305 mm)	96
<b>NOTE:</b> For cutting non-ferrous metals, use only saw blades with TCG teeth designed for this purpose.		

**Unpacking Your Saw**

Check the contents of your miter saw carton to make sure that you have received all parts. In addition to this instruction manual, the carton should contain:

1. One No. DW716 miter saw.
2. One DEWALT 12" (305 mm) dia. saw blade
3. One blade wrench in wrench pocket shown in Figure 2.
4. One DW7053 dustbag (some models).

**Specifications****CAPACITY OF CUT**

50° miter left and right

48° bevel left and right

0° miter

Max. Height 3.6" (91.5 mm) Result Width 7.2" (183 mm)

Max. Width 7.9" (200.7 mm) Result Height 2.9" (73.7 mm)

45° miter

Max. Height 3.6" (91.5 mm) Result Width 4.9" (125 mm)

Max. Width 5.5" (140 mm) Result Height 2.9" (73.7 mm)

45° bevel - Left

Max. Height 2.3" (58.4 mm) Result Width 7.4" (188 mm)

Max. Width 7.9" (200.7 mm) Result Height 1.9" (48.3 mm)

45° bevel - Right

Max. Width 7.9" (200.7 mm) Result Height 1.1" (28 mm)

Max. Height 1.6" (40.6 mm) Result Width 7.1" (180.3 mm)

Your saw is capable of cutting baseboard moldings 0.9" (22.9 mm) thick by 6" (152 mm) tall on a 45° right or left miter.

**NOTE:** Your saw is capable of cutting the following once a special set-up procedure is followed (see **Special Cuts**).

0° miter height 1.5" (38.1 mm)

width 10" (255 mm)

45° miter

height 1.5" (38.1 mm)

width 7.5" (190.5 mm)

**DRIVE****120 Volt Motor**

1675 Watts (max in)

3600 RPM

Multi-V Belt

Automatic Electric Brake

15 Amp Motor

Cut Helical Gears

Roller Bearings

Carbide Blade

**Familiarization**

Your miter saw is fully assembled in the carton. Open the box and lift the saw out by the convenient carrying handle, as shown in Figure 1A. Place the saw on a smooth, flat surface such as a workbench or strong table. Examine Figure 2 to become familiar with the saw and its various parts. The section on adjustments will refer to these terms and you must know what and where the parts are.

**CAUTION:** Pinch Hazard. To reduce the risk of injury, keep thumb underneath the handle when pulling the handle down. The lower guard will move up as the handle is pulled down which could cause pinching. The handle is placed close to the guard for special cuts.

Press down lightly on the operating handle and pull out the lock down pin, as shown in Figure 2. Gently release the downward pressure and hold the arm allowing it to rise to its full height. Use the lock down pin when carrying the saw from one place to another. Always use the carrying handle to transport the saw or the hand indentations shown in Figure 2 and 4.

**Bench Mounting**

Holes are provided in all four feet to facilitate bench mounting, as shown in Figure 2. (Two different sized holes are provided to accommodate different sizes of screws. Use either hole, it is not necessary to use both.) Always mount your saw firmly to a stable surface to prevent movement. To enhance the tool's portability, it can be mounted to a piece of 1/2" (12.7 mm) or thicker plywood which can then be clamped to your work support or moved to other job sites and reclamped.

**NOTE:** If you elect to mount your saw to a piece of plywood, make sure that the mounting screws don't protrude from the bottom of the wood. The plywood must sit flush on the work support. When clamping the saw to any work surface, clamp only on the clamping bosses where the mounting screw holes are located. Clamping at any other point will surely interfere with the proper operation of the saw.

**CAUTION:** To prevent binding and inaccuracy, be sure the mounting surface is not warped or otherwise uneven. If the saw rocks on the surface place a thin piece of material under one saw foot until the saw sits firmly on the mounting surface.

**IMPORTANT SAFETY INSTRUCTIONS****Changing or Installing a New Saw Blade (Fig. 3)**

**WARNING:** To reduce the risk of serious personal injury, turn off the tool and disconnect it from the power source before attempting to move it, change accessories or make any adjustments except as written in laser adjustment instructions.

**CAUTION:**

- Never depress the spindle lock button while the blade is under power or coasting.
- Do not cut ferrous metal (containing iron or steel) or masonry or fiber cement product with this miter saw.

**Removing the Blade**

1. Unplug the saw.
2. Raise the arm to the upper position and raise the lower guard (A) as far as possible.
3. Loosen, but do not remove guard bracket screw (B) until the bracket can be raised far enough to access the blade screw. Lower guard will remain raised due to the position of the guard bracket screw.
4. Depress the spindle lock button (C) while carefully rotating the saw blade by hand until the lock engages.
5. Keeping the button depressed, use the other hand and the wrench provided (D) to loosen the blade screw. (Turn clockwise, left-hand threads.)
6. Remove the blade screw (E), outer blade clamp (F), and blade (G). The 1" (25.4mm) blade adapter (H), if used, and the inner blade clamp (I), may be left on the spindle.

**NOTE:** For blades with a blade hole of 5/8" (15.88 mm), the 1" (25.4 mm) blade adapter is not used.

FIG. 12

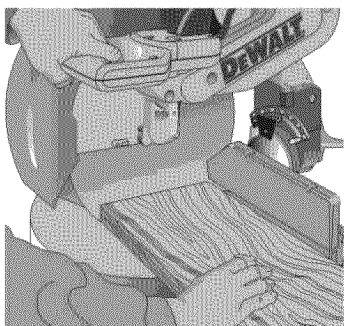

PROPER CUT

FIG. 12A

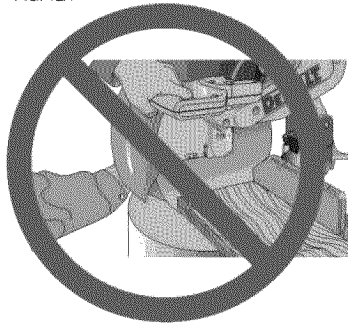

IMPROPER CUT

FIG. 13

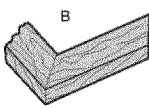
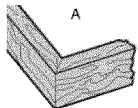

FIG. 14

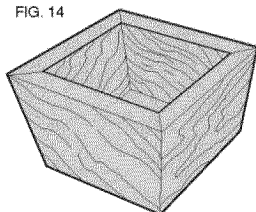
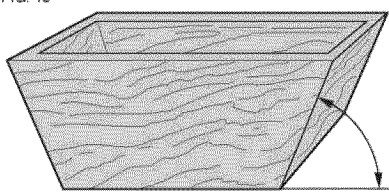
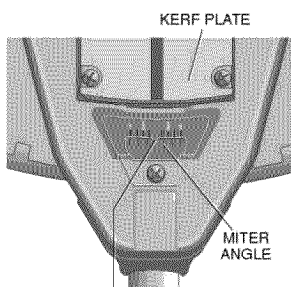

FIG. 15



ANGLE "A"

FIG. V1



CENTER MARK ON VERNIER SCALE  
ALIGNS WITH DESIRED WHOLE  
ANGLE ON MITER SCALE  
(24° RIGHT MITER)

FIG. V2

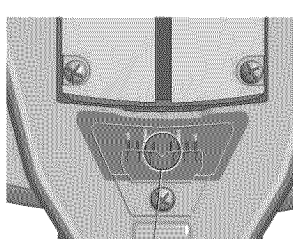

1/4° VERNIER MARK ALIGNS WITH  
CLOSEST WHOLE DEGREE MARK ON  
MITER SCALE (24-1/4° RIGHT MITER)

FIG. 16

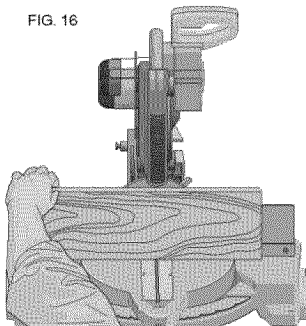
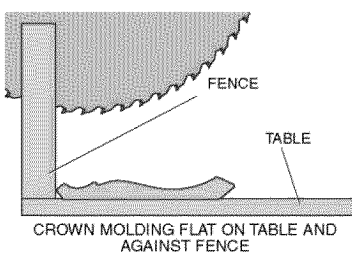
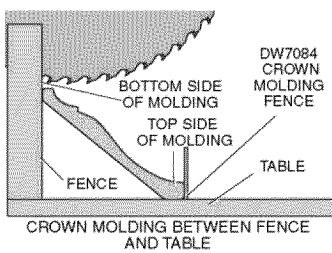

FIG. 17



CROWN MOLDING FLAT ON TABLE AND  
AGAINST FENCE

FIG. 17A



CROWN MOLDING BETWEEN FENCE  
AND TABLE

FIG. 18

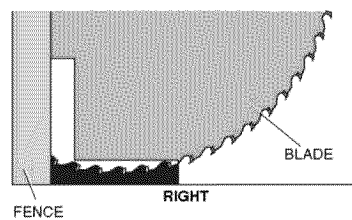

RIGHT

FIG. 18A

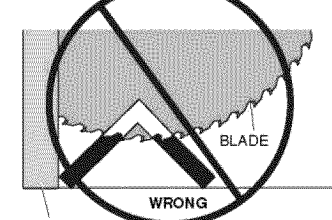

WRONG

FIG. 19

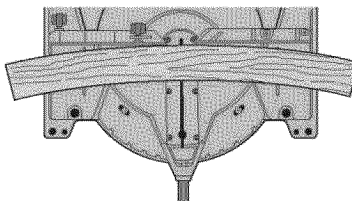

RIGHT

FIG. 19A

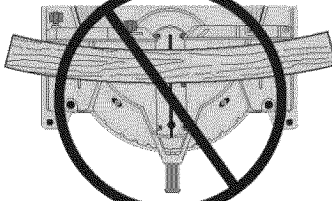

WRONG

## Installing a Blade

1. Unplug the saw.
2. With the arm raised, the lower guard held open and the guard bracket raised, place the blade on the spindle, onto the blade adapter [if using a blade with a 1" (25.4 mm) diameter blade hole] and against the inner blade clamp with the teeth at the bottom of the blade pointing toward the back of the saw.
3. Assemble the outer blade clamp onto the spindle.
4. Install the blade screw and, engaging the spindle lock, tighten the screw firmly with wrench provided. (Turn counterclockwise, left-hand threads.)

**NOTE:** When using blades with a 5/8" (15.88 mm) diameter blade hole, the blade adapter will not be used and should be stored in a safe place for future use.

5. Return the guard bracket to its original position and firmly tighten the guard bracket screw to hold bracket in place.

### ⚠ WARNING:

- The guard bracket must be returned to its original position and the screw tightened before activating the saw.
- Failure to do so may allow the guard to contact the spinning saw blade resulting in damage to the saw and severe personal injury.

## Transporting the Saw

**⚠ WARNING:** To reduce the risk of serious personal injury, turn off the tool and disconnect it from the power source before attempting to move it, change accessories or make any adjustments except as written in laser adjustment instructions.

**⚠ WARNING:** To reduce the risk of serious personal injury, ALWAYS lock the miter lock handle, bevel lock handle, lock down pin and fence adjustment knobs before transporting saw.

In order to conveniently carry the miter saw from place to place, a carrying handle has been included on the top of the saw arm and hand indentations in the base, as shown in Figures 2, 4.

## Adjustments

**⚠ WARNING:** To reduce the risk of serious personal injury, turn off the tool and disconnect it from the power source before attempting to move it, change accessories or make any adjustments except as written in laser adjustment instructions.

**NOTE:** Your miter saw is fully and accurately adjusted at the factory at the time of manufacture. If readjustment due to shipping and handling or any other reason is required, follow the steps below to adjust your saw.

Once made, these adjustments should remain accurate. Take a little time now to follow these directions carefully to maintain the accuracy of which your saw is capable.

### MITER SCALE ADJUSTMENT (FIG. 5)

Place a square against the saw's fence and blade. (Do not touch the tips of the blade teeth with the square. To do so will cause an inaccurate measurement.) Unlock miter lock lever (J) and swing the miter arm until the miter latch locks it at the 0 miter position. Do not lock miter lock lever (J). If the saw blade is not exactly perpendicular to the fence, loosen the three screws that hold the miter scale to the base and move the scale left or right until the blade is perpendicular to the fence, as measured with the square. Retighten the three screws. Pay no attention to the reading of the miter pointer at this time.

### MITER POINTER ADJUSTMENT (FIG. 5, 6)

To unlock, lift the miter lock lever (J) up and squeeze the miter latch (K) to move the miter arm to the zero position. With the miter lock lever unlocked allow the miter latch to snap into place as you rotate the miter arm to zero. Observe the pointer and miter scale through the viewing opening shown in Figure 6. If the pointer does not indicate exactly zero, loosen the screw holding the pointer in place, reposition the pointer and tighten the screw.

### BEVEL SQUARE TO TABLE (FIG. 7)

To align the blade square to the rotary table, lock the arm in the down position. Place a square against the blade taking care to not have the square on top of a tooth. Loosen the bevel lock knob (L) and ensure the arm is firmly against the 0° bevel stop. Move the 0° bevel stop adjusting screw (T) as necessary so that the blade is at 0° bevel to the table.

### BEVEL POINTER (FIG. 7)

If the bevel pointer (M) does not indicate zero, loosen the screw that holds it in place and move the pointer as necessary. Do not remove the steel plate in front of the bevel pointer. This plate prevents wood resin from accumulating on the bevel scale during use.

### ADJUSTING THE BEVEL STOP TO 45° LEFT OR RIGHT (FIG. 8)

**NOTE:** Adjust the 45° bevel angles only after performing the 0° bevel angle and pointer adjustment. Ensure the 45° bevel override levers (N) are pushed inward to obtain an accurate adjustment.

To adjust the right 45° bevel angle, loosen the bevel lock knob (L) and pull the bevel stop override knob (S) to override the 0° bevel stop. When the saw is fully to the right, if the pointer does not indicate exactly 45°, turn the right bevel stop screw (O) until the pointer indicates 45°.

To adjust the left 45° bevel stop, first loosen the bevel lock knob (L) and tilt the head to the left. If the pointer does not indicate exactly 45°, turn the left bevel stop screw until the pointer reads 45°.

### ADJUSTING THE BEVEL STOP TO 33.85° (FIG. 8)

**NOTE:** Adjust the 33.85° bevel angles only after performing the 0° bevel angle and pointer adjustment.

To set the 33.85° bevel angle, flip out the stop pawls (P). Loosen the bevel lock knob (L) and tilt the head to the left. If the pointer does not indicate exactly 33.85°, turn the screw contacting the pawl until the pointer reads 33.85°.

To adjust the right 33.85° bevel angle, flip out the stop pawl. Loosen the bevel lock knob (L) and pull the bevel stop override button (S) to override the 0° bevel stop. When the saw is fully to the right, if the pointer does not indicate exactly 33.85°, turn the screw contacting the pawl until the pointer indicates 33.85°.

### FENCE ADJUSTMENT

**⚠ WARNING:** To reduce the risk of serious personal injury, turn off the tool and disconnect it from the power source before attempting to move it, change accessories or make any adjustments except as written in laser adjustment instructions.

In order that the saw can bevel to a full 48° left or right, the fences can be adjusted to provide clearance. To adjust a fence, loosen the plastic knob (Figure 8, R), and slide the fence outward. Make a dry run with the saw turned off and check for clearance. Adjust the fence to be as close to the blade as practical to provide maximum workpiece support, without interfering with arm up and down movement. Tighten knob securely. When the bevel operations are complete, don't forget to relocate the fence.

**NOTE:** The guide groove of the fences can become clogged with sawdust. If you notice that it is becoming clogged, use a stick or some low pressure air to clear the guide groove.

### AUTOMATIC ELECTRIC BRAKE

Your saw is equipped with an automatic electric blade brake which stops the saw blade within 5 seconds of trigger release. This is not adjustable.

On occasion, there may be a delay after trigger release to brake engagement. On rare occasions, the brake may not engage at all and the blade will coast to a stop.

If a delay or "skipping" occurs, turn the saw on and off 4 or 5 times. If the condition persists, have the tool serviced by an authorized DEWALT service center.

Always be sure the blade has stopped before removing it from the kerf. The brake is not a substitute for guards. Ensure your own safety by giving the saw your complete attention.

FIG. 20

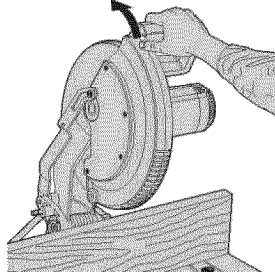
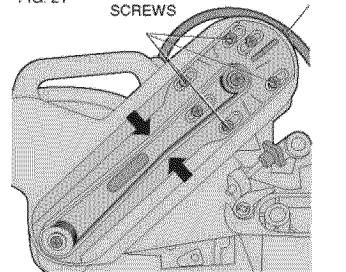

FIG. 21



## GUARD ACTUATION AND VISIBILITY

**▲ CAUTION:** Pinch Hazard. To reduce the risk of injury, keep thumb underneath the handle when pulling the handle down. The lower guard will move up as the handle is pulled down which could cause pinching.

The blade guard on your saw has been designed to automatically raise when the arm is brought down and to lower over the blade when the arm is raised.

The guard can be raised by hand when installing or removing saw blades or for inspection of the saw. NEVER RAISE THE BLADE GUARD MANUALLY UNLESS THE SAW IS TURNED OFF.

**NOTE:** Certain special cuts of large material will require that you manually raise the guard. Refer to **Cutting Large Material** under *Special Cuts*.

The front section of the guard is louvered for visibility while cutting. Although the louvers dramatically reduce flying debris, they are openings in the guard and safety glasses should be worn at all times when viewing through the louvers.

## MITER LOCK ADJUSTMENT (FIG. 11)

The miter lock rod should be adjusted if the table of the saw can be moved when the miter lock handle is locked down. To adjust, put the miter lock handle in the up position. Using a slotted screwdriver, adjust the lock rod in 1/8 clockwise turn increments to increase the lock force. To ensure the miter lock is functioning properly, re-lock miter lock handle to a non-detent miter angle.

## Brushes

**▲ WARNING:** To reduce the risk of serious personal injury, turn off the tool and disconnect it from the power source before attempting to move it, change accessories or make any adjustments accept as written in laser adjustment instructions.

Inspect carbon brushes regularly by unplugging tool, removing the motor end cap (Fig. 2), lift the brush spring and withdraw the brush assembly. Keep brushes clean and sliding freely in their guides. Always replace a used brush in the same orientation in the holder as it was prior to its removal. Carbon brushes have varying symbols stamped into their sides, and if the brush is worn down to approximately 1/2" (12.7 mm), the spring will no longer exert pressure and they must be replaced. Use only identical DEWALT brushes. Use of the correct grade of brush is essential for proper operation of electric brake. New brush assemblies are available at DEWALT service centers. The tool should be allowed to "run in" (run at no load) for 10 minutes before use to seat new brushes. The electric brake may be erratic in operation until the brushes are properly seated (worn in). Always replace the brush inspection cap after inspection or servicing the brushes.

While "running in" DO NOT TIE, TAPE, OR OTHERWISE LOCK THE TRIGGER SWITCH ON. HOLD BY HAND ONLY.

## Controls

Your compound miter saw has several main controls, which will be discussed briefly here. For more information on these controls, see the respective sections later in the manual.

### MITER CONTROL (FIG. 5)

The miter lock/adjustment lever and trigger allows you to miter your saw 50° left and right. To miter the saw, unlock miter lock lever (J) by pulling upward, squeeze the detent trigger (K) and set the miter angle desired on the miter scale. Lock miter lock handle by pressing downward. Override the detent trigger by rotating knob (Fig. 10, V).

### TRIGGER SWITCH (FIG. 2)

The trigger switch turns your saw on and off. A hole is provided in the trigger for insertion of a padlock to secure the saw.

### BEVEL LOCK (FIG. 8)

The bevel lock knob (L) allows you to bevel the saw 48° left or right. To loosen the handle and adjust the bevel setting, turn the handle counterclockwise, the saw head bevels easily to the left or to the right once the 0° bevel override knob (S) is pulled. To tighten, turn the handle clockwise. Bevel degree markings are on the bottom front of the saw arm (Fig. 7, M).

### 0° BEVEL OVERRIDE (FIG. 8)

The bevel stop override (S) allows you to bevel the saw to the right past the 0° mark. The saw will automatically stop at 0° when brought up from the left. To move past 0° to the right, pull the bevel stop knob. The stop knob can be locked out by pulling the knob out and rotating it 180°.

### 45° BEVEL STOP OVERRIDES (FIG. 8)

The bevel stop overrides (N) are held secure with their attachment screw to prevent inadvertent movement. Use the bit on the blade wrench to loosen the attachment screw. This allows the slides, to be pulled outward and the saw head to pivot past the 45° mark. Be sure to retighten the attachment screw when finished.

### 33.85° BEVEL STOPS (FIG. 8)

The two pawls (P) are used to stop the saw head bevel setting at 33.85°. This setting is used primarily for cutting crown moldings laid flat on the table.

### HEAD DOWNLOCK PIN (FIG. 8)

To lock the saw head in the down position, push the head down, push the pin (U) in and release the saw head. This will hold the saw head safely down for moving the saw from place to place. To release, press the saw head down and pull the pin out.

## OPERATION

**▲ WARNING:** To reduce the risk of serious personal injury, turn off the tool and disconnect it from the power source before attempting to move it, change accessories or make any adjustments accept as written in laser adjustment instructions.

**▲ WARNING:** Always use eye protection. All users and bystanders must wear eye protection that conforms to ANSI Z87.1 (CAN/CSA Z94.3).

Plug the saw into any household 60 Hz power source. Refer to the nameplate for voltage. Be sure the cord will not interfere with your work.

### SWITCH

To turn the saw on, depress the trigger switch. To turn the tool off, release the switch. Allow the blade to spin up to full operating rpm before making the cut. Release the trigger switch and allow the brake to stop the blade before raising the saw head. There is no provision for locking the switch on, but a hole is provided in the trigger for insertion of a padlock to lock the saw off.

### CUTTING WITH YOUR SAW

**NOTE:** Although this saw will cut wood and many non-ferrous materials, we will limit our discussion to the cutting of wood only. The same guidelines apply to the other materials. **DO NOT CUT FERROUS (IRON AND STEEL) MATERIALS OR MASONRY WITH THIS SAW.** Do not use any abrasive blades.

### CROSSCUTS

Cutting of multiple pieces is not recommended but can be done safely by ensuring that each piece is held firmly against the table and fence. A crosscut is made by cutting wood across the grain at any angle. A straight crosscut is made with the miter arm at the zero degree position. Set the miter arm at zero, hold the wood on the table and firmly against the fence. Turn on the saw by squeezing the trigger.

**▲ CAUTION:** Always use a work clamp to maintain control and reduce the risk of workpiece damage and personal injury.

When the saw comes up to speed (about 1 second) lower the arm smoothly and slowly to cut through the wood. Let the blade come to a full stop before raising arm.

Miter crosscuts are made with the miter arm at some angle other than zero. This angle is often 45° for making corners, but can be set anywhere from zero to 50° left or right. After selecting the desired miter angle, be sure to lock miter lock lever. Make the cut as described above.

To cut through an existing pencil line on a piece of wood, match the angle as close as possible. Cut the wood a little too long and measure from the pencil line to the cut edge to determine which direction to adjust the miter angle and recut. This will take some practice, but it is a commonly used technique.

### BEVEL CUTS

A bevel cut is a crosscut made with the saw blade at a bevel to the wood. In order to set the bevel, loosen the bevel clamp knob and move the saw to the left as desired. (It is necessary to move the fence to allow clearance). Once the desired bevel angle has been set, tighten the bevel clamp knob firmly.

Bevel angles can be set from 48° right to 48° left and can be cut with the miter arm set between zero and 50° right or left. At some extreme angles, the right or left side fence might have to be removed. To remove the left or right fence, unscrew the knobs several turns and slide the fence out.

### QUALITY OF CUT

The smoothness of any cut depends on a number of variables. Things like material being cut, blade type, blade sharpness and rate of cut all contribute to the quality of the cut.

When smoothest cuts are desired for molding and other precision work, a sharp (60 tooth carbide) blade and a slower, even cutting rate will produce the desired results.

Ensure that material does not creep while cutting, clamp it securely in place. Always let the blade come to a full stop before raising arm.

If small fibers of wood still split out at the rear of the workpiece, stick a piece of masking tape on the wood where the cut will be made. Saw through the tape and carefully remove tape when finished.

For varied cutting applications, refer to the list of recommended saw blades for your saw and select the one that best fits your needs. Refer to **Saw Blades** under *Optional Accessories*.

### BODY AND HAND POSITION (FIG. 12)

Proper positioning of your body and hands when operating the miter saw will make cutting easier, more accurate and safer. Never place hands near cutting area. Place hands no closer than 6" (152 mm) from the blade. Hold the workpiece tightly to the table and the fence when cutting. Keep hands in position until the trigger has been released and the blade has completely stopped. ALWAYS MAKE DRY RUNS (UNPOWERED) BEFORE FINISH CUTS SO THAT YOU CAN CHECK THE PATH OF THE BLADE. DO NOT CROSS HANDS, AS SHOWN IN FIGURE 12A.

Keep both feet firmly on the floor and maintain proper balance. As you move the miter arm left and right, follow it and stand slightly to the side of the saw blade. Sight through the guard louvers when following a pencil line.

### CLAMPING THE WORKPIECE

**▲ WARNING:** To reduce the risk of serious personal injury, turn off the tool and disconnect it from the power source before attempting to move it, change accessories or make any adjustments accept as written in laser adjustment instructions.

**▲ WARNING:** A workpiece that is clamped, balanced and secure before a cut may become unbalanced after a cut is completed. An unbalanced load may tip the saw or anything the saw is attached to, such as a table or workbench. When making a cut that may become unbalanced, properly support the workpiece and ensure the saw is firmly bolted to a stable surface. Personal injury may occur.

**▲ WARNING:** The clamp foot must remain clamped above the base of the saw whenever the clamp is used. Always clamp the workpiece to the base of the saw—not to any other part of the work area. Ensure the clamp foot is not clamped on the edge of the base of the saw.

**▲ CAUTION:** Always use a work clamp to maintain control and reduce the risk of workpiece damage and personal injury.

If you cannot secure the workpiece on the table and against the fence by hand, (irregular shape, etc.) or your hand would be less than 6" (152 mm) from the blade, a clamp or other fixture must be used.

For best results use the DW7082 clamp made for use with your saw. It is available for purchase at your local retailer or DEWALT service center.

Other aids such as spring clamps, bar clamps or C-clamps may be appropriate for certain sizes and shapes of material. Use care in selecting and placing these clamps. Take time to make a dry run before making the cut. The left or right fence will slide from side to side to aid in clamping.

### TO INSTALL CLAMP (SOLD SEPARATELY)

1. Insert it into the hole behind the fence. The clamp should be facing toward the back of the miter saw. The groove on the clamp rod should be fully inserted into the base. Ensure this groove is fully inserted into the base of the miter saw. If the groove is visible, the clamp will not be secure.
2. Rotate the clamp 180° toward the front of the miter saw.
3. Loosen the knob to adjust the clamp up or down, then use the fine adjust knob to firmly clamp the workpiece.

**NOTE:** Place the clamp on the opposite side of the base when beveling. ALWAYS MAKE DRY RUNS (UNPOWERED) BEFORE FINISH CUTS TO CHECK THE PATH OF THE BLADE. ENSURE THE CLAMP DOES NOT INTERFERE WITH THE ACTION OF THE SAW OR GUARDS.

**▲ WARNING:** A workpiece that is clamped, balanced and secure before a cut may become unbalanced after a cut is completed. An unbalanced load may tip the saw or anything the saw is attached to, such as a table or workbench. When making a cut that may become unbalanced, properly support the workpiece and ensure the saw is firmly bolted to a stable surface.

**▲ WARNING:** The clamp foot must remain clamped above the base of the saw whenever the clamp is used. Always clamp the workpiece to the base of the saw—not to any other part of the work area. Ensure the clamp foot is not clamped on the edge of the base of the saw.

### SUPPORT FOR LONG PIECES

**▲ WARNING:** To reduce the risk of serious personal injury, turn off the tool and disconnect it from the power source before attempting to move it, change accessories or make any adjustments accept as written in laser adjustment instructions.

ALWAYS SUPPORT LONG PIECES.

Never use another person as a substitute for a table extension; as additional support for a workpiece that is longer or wider than the basic miter saw table or to help feed, support or pull the workpiece.

For best results, use the DW7080 extension work support to extend the table width of your saw. Available from your dealer at extra cost. Support long workpieces using any convenient means such as sawhorses or similar devices to keep the ends from dropping.

### CUTTING PICTURE FRAMES, SHADOW BOXES AND OTHER FOUR-SIDED PROJECTS

To best understand how to make the items listed here, we suggest that you try a few simple projects using scrap wood until you develop a "FEEL" for your saw.

Your saw is the perfect tool for mitering corners like the one shown in Figure 14. Sketch A in Figure 13 shows a joint made by using the bevel adjustment to bevel the edges of the two boards at 45° each to produce a 90° corner. For this joint the miter arm was locked in the zero position and the bevel adjustment was locked at 45°. The wood was positioned with the broad flat side against the table and the narrow edge against the fence. The cut could also be made by mitering right and left with the broad surface against the fence.

### CUTTING TRIM MOLDING AND OTHER FRAMES

Sketch B in Figure 13 shows a joint made by setting the miter arm at 45° to miter the two boards to form a 90° corner. To make this type of joint, set the bevel adjustment to zero and the miter arm to 45°. Once again, position the wood with the broad flat side on the table and the narrow edge against the fence.

The two sketches in Figure 13 are for four side objects only.

As the number of sides changes, so do the miter and bevel angles. The chart below gives the proper angles for a variety of shapes.

- EXAMPLES -	
NO. SIDES	ANGLE MITER OR BEVEL
4	45°
5	36°
6	30°
7	25.7°
8	22.5°
9	20°
10	18°

(The chart assumes that all sides are of equal length.) For a shape that is not shown in the chart, use the following formula. 180° divided by the number of sides equals the miter (if the material is cut vertically) or bevel angle (if the material is cut laying flat).

### CUTTING COMPOUND MITERS

A compound miter is a cut made using a miter angle and a bevel angle at the same time. This is the type of cut used to make frames or boxes with slanting sides like the one shown in Figure 15.

**NOTE:** If the cutting angle varies from cut to cut, check that the bevel clamp knob and the miter lock knob are securely tightened. These knobs must be tightened after making any changes in bevel or miter.

The chart (Table 1) will assist you in selecting the proper bevel and miter settings for common compound miter cuts. To use the chart, select the desired angle "A" (Figure 15) of your project and locate that angle on the appropriate arc in the chart. From that point follow the chart straight down to find the correct bevel angle and straight across to find the correct miter angle.

Set your saw to the prescribed angles and make a few trial cuts. Practice fitting the cut pieces together until you develop a feel for this procedure and feel comfortable with it.

**Example:** To make a four-sided box with 26° exterior angles (Angle A, Figure 15), use the upper right arc. Find 26° on the arc scale. Follow the horizontal intersecting line to either side to get miter angle setting on saw (42°). Likewise, follow the vertical intersecting line to the top or bottom to get the bevel angle setting on the saw (18°). Always try cuts on a few scrap pieces of wood to verify settings on saw.



## Patent Notification

Manufactured under one or more of the following U.S. patents:

6,431,040	5,582,089
6,427,570	5,375,495
D454,577	5,285,708
5,819,619	5,199,343

Other patents pending.

## Troubleshooting Guide

BE SURE TO FOLLOW SAFETY RULES AND INSTRUCTIONS

TROUBLE!	WHAT'S WRONG?	WHAT TO DO
<i>Saw will not start</i>	<ol style="list-style-type: none"> <li>1. Saw not plugged in</li> <li>2. Fuse blown or circuit breaker tripped</li> <li>3. Cord damaged</li> <li>4. Brushes worn out</li> </ol>	<ol style="list-style-type: none"> <li>1. Plug in saw.</li> <li>2. Replace fuse or reset circuit breaker.</li> <li>3. Have cord replaced by authorized service center.</li> <li>4. Have brushes replaced by authorized service center or replace them yourself. Refer to <b>Brushes</b>.</li> </ol>
<i>Saw makes unsatisfactory cuts</i>	<ol style="list-style-type: none"> <li>1. Dull blade</li> <li>2. Blade mounted backwards</li> <li>3. Gum or pitch on blade</li> <li>4. Incorrect blade for work being done</li> </ol>	<ol style="list-style-type: none"> <li>1. Replace blade. Refer to <b>Changing or Installing a New Saw Blade</b>.</li> <li>2. Turn blade around. Refer to <b>Changing or Installing a New Saw Blade</b>.</li> <li>3. Remove blade and clean with turpentine and coarse steel wool or household oven cleaner.</li> <li>4. Change the blade type. Refer to <b>Saw Blades</b>.</li> </ol>
<i>Blade does not come up to speed</i>	<ol style="list-style-type: none"> <li>1. Extension cord too light or too long</li> </ol>	<ol style="list-style-type: none"> <li>1. Replace with adequate size cord. Refer to <b>Use Proper Extension Cord</b> under <b>Important Safety Instructions</b>.</li> </ol>
<i>Machine vibrates excessively</i>	<ol style="list-style-type: none"> <li>2. Low house current</li> </ol> <ol style="list-style-type: none"> <li>1. Saw not mounted securely to stand or work bench</li> <li>2. Stand or bench on uneven floor</li> <li>3. Damaged saw blade</li> </ol>	<ol style="list-style-type: none"> <li>2. Contact your electric company.</li> <li>1. Tighten all mounting hardware. Refer to <b>Bench Mounting</b>.</li> <li>2. Reposition on flat level surface. Refer to <b>Familiarization</b>.</li> <li>3. Replace blade. Refer to <b>Changing or Installing a New Saw Blade</b>.</li> </ol>
<i>Does not make accurate miter cuts</i>	<ol style="list-style-type: none"> <li>1. Miter scale not adjusted correctly</li> <li>2. Miter pointer not adjusted correctly</li> <li>3. Workpiece is not perpendicular to table</li> <li>4. Workpiece moving</li> </ol>	<ol style="list-style-type: none"> <li>1. Check and adjust. Refer to <b>Miter Scale Adjustment</b> under <b>Adjustments</b>.</li> <li>2. Check and adjust. Refer to <b>Miter Pointer Adjustment</b> under <b>Adjustments</b>.</li> <li>3. Check and adjust fence. Refer to <b>Fence Adjustment</b> under <b>Adjustments</b>.</li> <li>4. Clamp workpiece securely to fence or glue 120 grit sandpaper to fence with rubber cement.</li> </ol>
<i>Material pinches blade</i>	<ol style="list-style-type: none"> <li>1. Cutting bowed material</li> </ol>	<ol style="list-style-type: none"> <li>1. Refer to <b>Bowed Material</b> under <b>Special Cuts</b>.</li> </ol>

**TABLE 1: COMPOUND MITER CUT**

(POSITION WOOD WITH BROAD FLAT SIDE ON THE TABLE AND THE NARROW EDGE AGAINST THE FENCE)

