

SONY®

4-163-319-13(1)

Digital HD Video Camera Recorder

HANDYCAM®

Operating Guide

HDR-AX2000

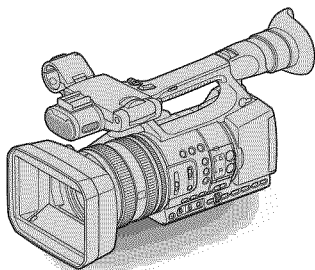

Getting Started 15



Recording/
Playback 25

Editing 56

Using the Menu 65

Connecting with a
Computer 81

Troubleshooting 83

Additional Information 95

Quick Reference 109

Spanish Quick Guide/
Guía rápida en español 118

AVCHD



InfoLITHIUM L

PROGRESSIVE



HDMI™
HIGH DEFINITION MULTIMEDIA INTERFACE

CLASS 4

CLASS 4

Owner's Record

The model and serial numbers are located on the bottom. Record the serial number in the space provided below. Refer to these numbers whenever you call upon your Sony dealer regarding this product.

Model No. HDR-AX2000 _____

Serial No. _____

Model No. AC- _____

No. _____

WARNING

To reduce fire or shock hazard, do not expose the unit to rain or moisture.

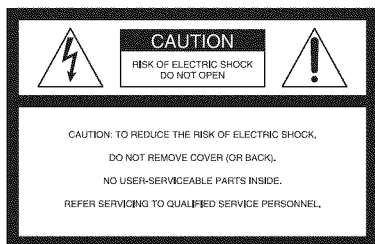

This symbol is intended to alert the user to the presence of uninsulated "dangerous voltage" within the product's enclosure that may be of sufficient magnitude to constitute a risk of electric shock to persons.



This symbol is intended to alert the user to the presence of important operating and maintenance (servicing) instructions in the literature accompanying the appliance.

IMPORTANT SAFETY INSTRUCTIONS

SAVE THESE INSTRUCTIONS.
DANGER - TO REDUCE THE RISK OF FIRE
OR ELECTRIC SHOCK,
CAREFULLY FOLLOW THESE
INSTRUCTIONS.

- Read these instructions.
- Keep these instructions.
- Heed all warnings.
- Follow all instructions.
- Do not use this apparatus near water.
- Clean only with dry cloth.
- Do not block any ventilation openings. Install in accordance with the manufacturer's instructions.
- Do not install near any heat sources such as radiators, heat registers, stoves, or other apparatus (including amplifiers) that produce heat.
- Do not defeat the safety purpose of the polarized or grounding-type plug. A polarized plug has two blades with one wider than the other. A grounding type plug has two blades and a third grounding prong. The wide blade or the third prong are provided for your safety. If the provided plug does not fit into your outlet, consult an electrician for replacement of the obsolete outlet.
- Protect the power cord from being walked on or pinched particularly at plugs, convenience receptacles, and the point where they exit from the apparatus.
- Only use attachments/accessories specified by the manufacturer.
- Use only with the cart, stand, tripod, bracket, or table specified by the manufacturer, or sold with the apparatus. When a cart is used, use caution when moving the cart/apparatus combination to avoid injury from tip-over.



- Unplug this apparatus during lightning storms or when unused for long periods of time.

IMPORTANT SAFETY INSTRUCTIONS (Continued)

- Refer all servicing to qualified service personnel. Servicing is required when the apparatus has been damaged in any way, such as power-supply cord or plug is damaged, liquid has been spilled or objects have fallen into the apparatus, the apparatus has been exposed to rain or moisture, does not operate normally, or has been dropped.
- If the shape of the plug does not fit the power outlet, use an attachment plug adaptor of the proper configuration for the power outlet.

Read this first

Before operating this unit, please read this manual thoroughly, and retain it for future reference.

To handle the recorded images on your computer

Refer to “Help” on the supplied CD-ROM “Content Management Utility.”

CAUTION

Replace the battery with the specified type only. Otherwise, fire or injury may result.

Excessive sound pressure from earphones and headphones can cause hearing loss.

Do not expose the batteries to excessive heat such as sunshine, fire or the like.

Battery pack

If the battery pack is mishandled, the battery pack can burst, cause a fire or even chemical burns. Observe the following cautions.

- Do not disassemble.
- Do not crush and do not expose the battery pack to any shock or force such as hammering, dropping or stepping on it.
- Do not short circuit and do not allow metal objects to come into contact with the battery terminals.
- Do not expose to high temperature above 60°C (140°F) such as in direct sunlight or in a car parked in the sun.
- Do not incinerate or dispose of in fire.
- Do not handle damaged or leaking lithium ion batteries.
- Be sure to charge the battery pack using a genuine Sony battery charger or a device that can charge the battery pack.
- Keep the battery pack out of the reach of small children.
- Keep the battery pack dry.
- Replace only with the same or equivalent type recommended by Sony.
- Dispose of used battery packs promptly as described in the instructions.

AC Adaptor

- Use the nearby wall outlet when using the AC Adaptor. Disconnect the AC Adaptor from the wall outlet (wall socket) immediately if any malfunction occurs while using your camcorder.
- Do not use the AC Adaptor placed in a narrow space, such as between a wall and furniture.
- Even if your camcorder is turned off, AC power (house current) is still supplied to it while connected to the wall outlet (wall socket) via the AC Adaptor.

For customers in the U.S.A. and CANADA

RECYCLING LITHIUM-ION BATTERIES

Lithium-Ion batteries are recyclable. You can help preserve our environment by returning your used rechargeable batteries to the collection and recycling location nearest you.



For more information regarding recycling of rechargeable batteries, call toll free 1-800-822-8837, or visit <http://www.rbrc.org/>

Caution: Do not handle damaged or leaking Lithium-Ion batteries.

Read this first (Continued)

For customers in the U.S.A.

UL is an internationally recognized safety organization.

The UL Mark on the product means it has been UL Listed.

If you have any questions about this product, you may call:

Sony Customer Information Center
1-800-222-SONY (7669).

The number below is for the FCC related matters only.

Regulatory Information

Declaration of Conformity

Trade Name: SONY

Model No.: HDR-AX2000

Responsible Party: Sony Electronics Inc.

Address: 16530 Via Esprillo, San Diego, CA
92127 U.S.A.

Telephone Number: 858-942-2230

This device complies with Part 15 of the FCC Rules.

Operation is subject to the following two conditions:

(1) This device may not cause harmful interference, and (2) this device must accept any interference received, including interference that may cause undesired operation.

However, there is no guarantee that interference will not occur in a particular installation. If this equipment does cause harmful interference to radio or television reception, which can be determined by turning the equipment off and on, the user is encouraged to try to correct the interference by one or more of the following measures:

- Reorient or relocate the receiving antenna.
- Increase the separation between the equipment and receiver.
- Connect the equipment into an outlet on a circuit different from that to which the receiver is connected.
- Consult the dealer or an experienced radio/TV technician for help.

The supplied interface cable must be used with the equipment in order to comply with the limits for a digital device pursuant to Subpart B of Part 15 of FCC Rules.

For the State of California, USA only

Perchlorate Material - special handling may apply. See

www.dtsc.ca.gov/hazardouswaste/perchlorate

Perchlorate Material: Lithium battery contains perchlorate.

CAUTION

You are cautioned that any changes or modifications not expressly approved in this manual could void your authority to operate this equipment.

Note

This equipment has been tested and found to comply with the limits for a Class B digital device, pursuant to Part 15 of the FCC Rules.

These limits are designed to provide reasonable protection against harmful interference in a residential installation. This equipment generates, uses, and can radiate radio frequency energy and, if not installed and used in accordance with the instructions, may cause harmful interference to radio communications.

Representative plug of power supply cord of countries/regions around the world.



A Type
(American
Type)



B Type
(British Type)



BF Type
(British Type)



B3 Type
(British Type)



C Type (CEE
Type)



SE Type (CEE
Type)



O Type (Ocean
Type)

The representative supply voltage and plug type are described in this chart.

Depend on an area, Different type of plug and supply voltage are used.

Attention: Power cord meeting demands from each country shall be used.

- For only the United States

Use a UL Listed, 1.5-3 m (5-10 ft.), Type SPT-2 or NISPT-2, AWG no. 18 power supply cord, rated for 125 V 7 A, with a NEMA 1-15P plug rated for 125 V 15 A."

Europe

Countries/regions	Voltage	Frequency (Hz)	Plug type
Austria	230	50	C
Belgium	230	50	C
Czech	220	50	C
Denmark	230	50	C
Finland	230	50	C
France	230	50	C
Germany	230	50	C
Greece	220	50	C
Hungary	220	50	C
Iceland	230	50	C
Ireland	230	50	C/BF
Italy	220	50	C
Luxemburg	230	50	C
Netherlands	230	50	C
Norway	230	50	C
Poland	220	50	C
Portugal	230	50	C
Romania	220	50	C
Russia	220	50	C
Slovak	220	50	C
Spain	127/230	50	C
Sweden	230	50	C
Switzerland	230	50	C
UK	240	50	BF

Asia

Countries/regions	Voltage	Frequency (Hz)	Plug type
China	220	50	A
Hong Kong	200/220	50	BF
India	230/240	50	C
Indonesia	127/230	50	C
Japan	100	50/60	A
Korea (rep)	220	60	C
Malaysia	240	50	BF
Philippines	220/230	60	A/C
Singapore	230	50	BF
Taiwan	110	60	A
Thailand	220	50	C/BF
Vietnam	220	50	A/C

Read this first (Continued)

Oceania

Countries/regions	Voltage	Frequency (Hz)	Plug type
Australia	240	50	O
New Zealand	230/240	50	O

North America

Countries/regions	Voltage	Frequency (Hz)	Plug type
Canada	120	60	A
USA	120	60	A

Central America

Countries/regions	Voltage	Frequency (Hz)	Plug type
Bahamas	120/240	60	A
Costa Rica	110	60	A
Cuba	110/220	60	A/C
Dominican (rep)	110	60	A
El Salvador	110	60	A
Guatemala	120	60	A
Honduras	110	60	A
Jamaica	110	50	A
Mexico	120/127	60	A
Nicaragua	120/240	60	A
Panama	110/220	60	A

South America

Countries/regions	Voltage	Frequency (Hz)	Plug type
Argentina	220	50	C/BF/O
Brazil	127/220	60	A/C
Chile	220	50	C
Colombia	120	60	A
Peru	220	60	A/C
Venezuela	120	60	A

Middle East

Countries/regions	Voltage	Frequency (Hz)	Plug type
Iran	220	50	C/BF
Iraq	220	50	C/BF
Israel	230	50	C
Saudi Arabia	127/220	50	A/C/BF
Turkey	220	50	C
UAE	240	50	C/BF

Africa

Countries/regions	Voltage	Frequency (Hz)	Plug type
Algeria	127/220	50	C
Congo (dem)	220	50	C
Egypt	220	50	C
Ethiopia	220	50	C
Kenya	240	50	C/BF
Nigeria	230	50	C/BF
South Africa	220/230	50	C/BF
Tanzania	230	50	C/BF
Tunisia	220	50	C

Notes on use

Types of memory cards you can use in your camcorder

- You can use the following memory cards for this camcorder: “Memory Stick PRO Duo” (Mark2) media, “Memory Stick PRO-HG Duo” media, SD memory cards, SDHC memory cards, SDXC memory cards (Speed Class 4 or faster is required for each SD card). However, operation with all memory cards is not assured.
- “Memory Stick PRO Duo” media of up to 32 GB and SD cards of up to 64 GB have been verified to operate with your camcorder.
- In this manual, “Memory Stick PRO Duo” (Mark2) media and “Memory Stick PRO-HG Duo” media are called “Memory Stick PRO Duo” media. SD memory card, SDHC memory card and SDXC memory card are called SD card.
- See page 95 for the recordable time of memory cards.

Notes

- A MultiMedia Card cannot be used with this camcorder.
- Movies recorded on SDXC memory cards cannot be imported to or played back on computers or A/V devices not supporting the exFAT* file system by connecting the camcorder to these devices with the USB cable. Confirm in advance that the connecting equipment is supporting the exFAT system. If you connect an equipment not supporting the exFAT system and the format screen appears, do not perform the format. All the data recorded will be lost.
- * The exFAT is a file system that is used for SDXC memory cards.

Size of memory card you can use with your camcorder

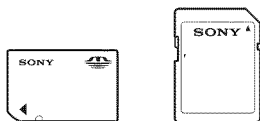

- “Memory Stick PRO Duo” media, half the size of “Memory Stick,” or standard size SD cards can be used for this camcorder.
- Do not attach a label or the like on memory card or memory card adaptor. Doing so may cause a malfunction.

Using the camcorder

- Do not hold the camcorder by the following part.

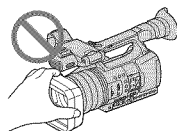

Lens hood

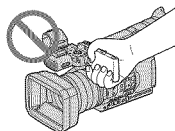

LCD panel

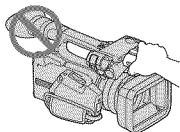

Internal microphone

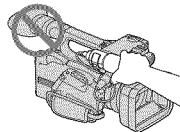

Microphone (sold separately) or Microphone holder

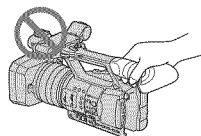

Viewfinder

Notes

- The camcorder is not dustproof, dripproof or waterproof. See “About handling of your camcorder” (p. 101).
- Connect cables to your camcorder with their terminals placed the correct way. Squeezing the terminals into your camcorder’s jacks may damage them or results in a malfunction of your camcorder.

Read this first (Continued)

About menu items, LCD panel, viewfinder, and lens

- A menu item that is grayed out is not available under the current recording or playback conditions.
- The LCD screen and the viewfinder are manufactured using extremely high-precision technology, so over 99.99% of the pixels are operational for effective use. However, there may be some tiny black points and/or bright points (white, red, blue, or green in color) that appear constantly on the LCD screen and/or the viewfinder. These points are normal results of the manufacturing process and do not affect the recording in any way.

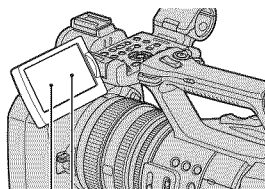

Black point

White, red, blue or green point

Do not expose your camcorder's viewfinder, lens, or LCD screen to the sun or strong light source for extended periods.

- Intense light sources, especially the sun will converge on the viewfinder or lens and damage the internal parts of your camcorder. Avoid sunlight or other strong light sources when storing your camcorder. Protect this device by always closing the lens cover or by placing it in its bag when not in use.

About temperature of your camcorder and battery pack

- Your camcorder has a protective function that disables recording or playback if the temperature of your camcorder or battery

pack is beyond the safely operable range. In this case, a message appears on the LCD screen or in the viewfinder (p. 92).

On recording

- In order to stabilize memory card operation, it is recommended that you format the memory card when you use it with your camcorder for the first time. All data recorded on the memory card will be erased by formatting, and can not be recovered. Save important data on the memory card on other media such as a computer, before formatting the memory card.
- Before starting to record, test the recording function to make sure the picture and sound are recorded without any problems.
- Compensation for the loss of the content of recordings or the loss of recording opportunities cannot be provided, even if recording or playback is not possible due to a malfunction of the camcorder, storage media, etc., or even if images or sounds are distorted due to the limits of the capabilities of the camcorder.
- TV color systems differ depending on the countries/regions. To view your recordings on a TV, you need an NTSC system-based TV.
- Television programs, films, video tapes, and other materials may be copyrighted. Unauthorized recording of such materials may be contrary to the copyright laws.
- Because of the way that the image device (CMOS sensor) reads out image signals, the following phenomena may occur.
 - The subjects passing by the frame rapidly might appear crooked depending on the recording conditions. (This phenomenon may be notable in displays having high motion resolution.)
 - Horizontal lines appear on the screen during recording under fluorescent lights. The phenomena can be reduced by adjusting the shutter speed (p. 32).
 - Images on the screen look horizontally divided when a subject is lighted with a flash. The phenomena can be reduced by using a slower shutter speed.

On playing back movies

- Your camcorder is compatible with MPEG-4 AVC/H.264 High Profile for high definition image quality (HD) recording. Therefore, you cannot play back images recorded with high definition image quality (HD) on your camcorder with the following devices;
 - Other AVCHD format compatible devices which are not compatible with High Profile
 - Devices which are not compatible with the AVCHD format
- Movies made using this camcorder may not play back normally on devices other than this camcorder. Also, movies recorded on other devices may not play back properly on this camcorder.
- Standard (SD) image quality movies recorded on SD memory cards cannot be played on AV equipment of other manufacturers.

Discs recorded with high definition image quality (HD)

- This camcorder captures high definition footage in the AVCHD format. DVD media containing AVCHD footage should not be used with DVD based players or recorders, as the DVD player/recorder may fail to eject the media and may erase its contents without warning.

Save all your recorded image data

- To prevent your image data from being lost, save all your recorded images on external media periodically. It is recommended that you save the image data on a computer using the supplied application software.

Format the recording media using [MEDIA FORMAT] if images are not recorded or played back properly

- If you continue recording and deleting images on a memory card for a long time, the files on that memory card may be

fragmented. As a result, you may not be able to record and save images properly. If this happens, save images on a separate recordable media, such as a disc or computer, then format the memory card (p. 62).

Note on disposal/transfer

- Even if you delete all data or format the memory card on your camcorder or computer, you may not delete data from the memory card completely. When you transfer the memory card or your camcorder, it is recommended that you delete the data completely using commercially available data deletion software to prevent the recovery of your data. Also, when you dispose of the memory card, it is recommended that you destroy the actual body of the memory card.

About the operation of the camcorder

- You can operate the camcorder using the SEL/PUSH EXEC dial/◀/▶ buttons (p. 22), ▲/▼/◀/▶/EXEC buttons (p. 65), and the touch panel. However, you cannot use the touch panel to make some settings such as the MENU items.

About this manual

- The images of the LCD screen and the viewfinder used in this manual for illustration purposes are captured using a digital still camera, and therefore may appear different.
- The on-screen displays in each local language are used for illustrating the operating procedures. Change the screen language before using your camcorder if necessary (p. 23).
- Design and specifications of recording media and other accessories are subject to change without notice.

Table of Contents

IMPORTANT SAFETY INSTRUCTIONS	3
Read this first	5

Getting Started

Step 1: Checking supplied items	15
Step 2: Attaching the lens hood with lens cover	16
Step 3: Charging the battery pack	17
Step 4: Turning the power on and holding your camcorder properly	19
Step 5: Adjusting the LCD panel and viewfinder	20
Step 6: Setting the date and time	22
Changing the language setting.....	23
Step 7: Inserting a memory card	23







Recording/Playback

Recording	25
Selecting the recording format.....	27
Changing the settings of your camcorder recordings	29
Adjusting the zoom.....	29
Adjusting the focus manually	30
Adjusting the image brightness	31
Adjusting to natural color (White balance)	33
Customizing the picture quality (Picture profile)	35
Audio setup	39
Recording with the SMOOTH SLOW REC function.....	41
Assigning the functions to the ASSIGN buttons	43
Playback	45
Viewing still images.....	47
Changing/checking the settings in your camcorder	49
Changing the screen.....	49
Displaying recording data (Data code).....	49
Displaying the settings in your camcorder (Status check)	50
Connecting a monitor or a TV	51

Editing

Operating the MODE menu	56
Protecting recorded images (Protect)	57
Using the Playlist of movies	58
Creating the Playlist	58
Playing the Playlist	58
Capturing still images from a movie	59
Dividing a movie	60
Deleting movies and still images	61
Formatting the memory card	62
Preventing data on the memory card from being recovered	63
Repairing the image database file	64

Using the Menu

<i>Operating the menu</i>	65
Menu items	67
 (CAMERA SET) menu	69
Settings to adjust your camcorder to the recording conditions (GAIN SET/ BACK LIGHT/STEADYSHOT, etc.)	
 (REC/OUT SET) menu	73
Recording settings, input and output settings (REC FORMAT/VIDEO OUT, etc.)	
 (AUDIO SET) menu	75
Settings for the audio recording (AUDIO LIMIT/XLR SET, etc.)	
 (DISPLAY SET) menu	77
Display settings of the display and the viewfinder (MARKER/VF BACKLIGHT/ DISPLAY OUTPUT, etc.)	
 (OTHERS) menu	80
Settings while recording or other basic settings (AREA SET/BEEP, etc.)	

Connecting with a Computer

Saving images with a computer	81
-------------------------------------	----

Table of Contents (Continued)

Troubleshooting

Troubleshooting	83
Warning indicators and messages	92

Additional Information

Recording time of movies	95
Using your camcorder abroad	97
File/folder structure on the memory card	98
Maintenance and precautions	99
About the AVCHD format	99
About the memory card.....	99
About the "InfoLITHIUM" battery pack.....	100
About x.v.Color	101
About handling of your camcorder	101
Specifications	105

Quick Reference

Identifying parts and controls	109
Wireless Remote Commander.....	113
Screen indicators	114
Index	115

Spanish Quick Guide/Guía rápida en español

118

Step 1: Checking supplied items

Make sure that you have following items supplied with your camcorder. The number in the parentheses indicates the number of that item supplied.

- Memory cards are not included. See pages 9 and 99 for types of memory cards that you can use on your camcorder.

AC Adaptor (AC-L100C) (1) (p. 17)

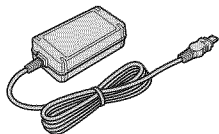

Power cord (mains lead) (1) (p. 17)

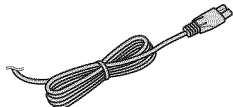

Wireless Remote Commander (RMT-845) (1) (p. 113)



A button-type lithium battery is already installed.

Component video cable (1) (p. 51)



A/V connecting cable (1) (p. 51)

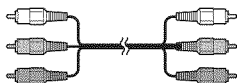

USB cable (1) (p. 81)

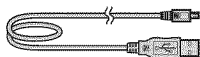

Large eyecup (1) (p. 21)



Rechargeable battery pack (NP-F570) (1) (p. 17, 100)



Lens hood with lens cover (1) (p. 16)
This lens hood is pre-mounted.

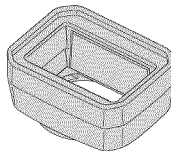

CD-ROM "Content Management Utility" (1)
Operating Guide (1)

Step 2: Attaching the lens hood with lens cover

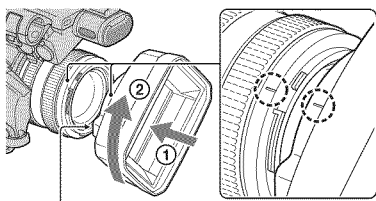

PUSH (lens hood release) button

Align the marks on the lens hood to those on the camcorder, and turn the lens hood in the direction of the arrow ② until it is locked.

To remove the lens hood with lens cover

Turn the lens hood in the opposite direction to the arrow ② in the illustration while pressing the PUSH (lens hood release) button.

💡 Tips

- If you attach or remove a 72mm (2 7/8 in.) PL filter or MC protector, remove the lens hood with lens cover.

To open or close the shutter of the lens hood with lens cover

Move the lens cover lever to OPEN to open the lens cover, and move the lever to CLOSE to close the lens cover.

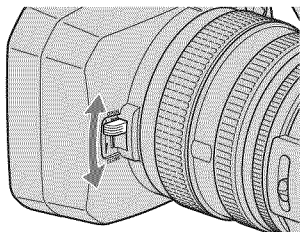

Step 3: Charging the battery pack

You can charge the “InfoLITHIUM” battery pack (L series) with the supplied AC Adaptor.

Notes

- You cannot use batteries other than the “InfoLITHIUM” battery pack (L series) (p. 100).

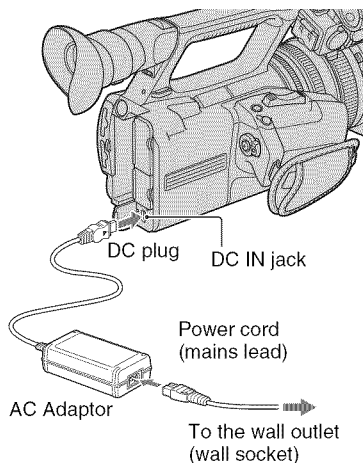

- 1 Press the battery pack against the back of your camcorder and slide it down.

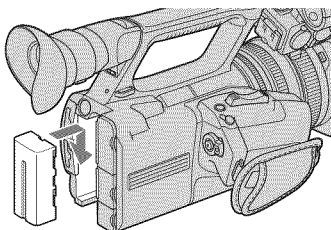

- 2 With the ► mark on the DC plug facing outwards, connect the DC plug to the DC IN jack on your camcorder.

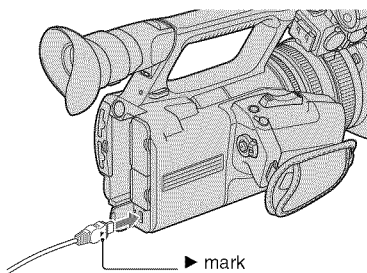

- 3 Connect the power cord (mains lead) to the AC Adaptor.
- 4 Connect the power cord (mains lead) to the wall outlet (wall socket).

Step 3: Charging the battery pack (Continued)

5 Set the POWER switch to OFF (CHG).

The CHG lamp lights up and charging starts.

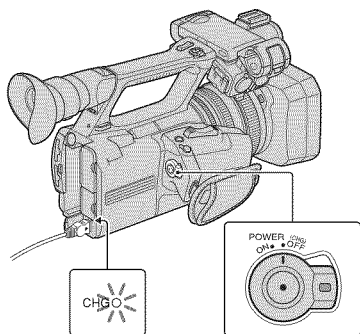

After charging the battery

The CHG lamp turns off when the battery is fully charged. Disconnect the AC Adaptor from the DC IN jack.

Tips

- You can check the remaining battery life with the status check function (p. 50).

To remove the battery pack

Slide the POWER switch to OFF (CHG). Push the BATT RELEASE (battery release) button and remove the battery pack.

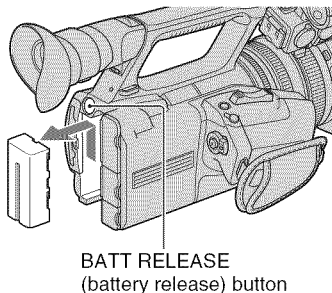

To store the battery pack

If the battery pack is not in use for a while, run down the battery and store it. See page 101 for details on storage of the battery pack.

Charging time

Approximate time (min.) required when you fully charge a fully discharged battery pack.

Battery pack	Charging time
NP-F570 (supplied)	260
NP-F770	370
NP-F970	485

Notes

- You cannot use the NP-F330 battery pack with your camcorder.

On the battery pack

- Before changing the battery pack, slide the POWER switch to OFF (CHG).
- The CHG lamp flashes during charging, or the Battery Info (p. 50) will not be correctly displayed under the following conditions.
 - The battery pack is not attached correctly.
 - The battery pack is damaged.
 - The battery pack is worn-out.

- The battery pack is too cold.
Remove the battery pack and put it in a warm place.
- The battery pack is too hot.
Remove the battery pack and put it in a cool place.
- The power will not be supplied from the battery as long as the AC Adaptor is connected to the DC IN jack of your camcorder, even when the power cord (mains lead) is disconnected from the wall outlet (wall socket).

On the charging time

- Time measured with the camcorder at 25 °C (77 °F). 10 °C to 30 °C (50 °F to 86 °F) is recommended.

Using an outside power source

You can use the AC Adaptor to obtain the AC power. While you are using the AC Adaptor, the battery pack will not lose its charge even when it is attached to your camcorder.

Connect your camcorder as shown in “Step 3: Charging the battery pack” on page 17.

On the AC Adaptor

- Do not short-circuit the DC plug of the AC Adaptor or battery terminal with any metallic objects. This may cause a malfunction.

Step 4: Turning the power on and holding your camcorder properly

To record or play back, set the POWER switch to ON.

When you use your camcorder for the first time, the [CLOCK SET] screen appears (p. 22).

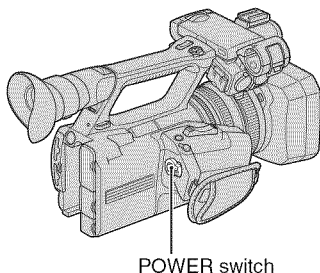

- 1 Slide the POWER switch to ON while pressing the green button.

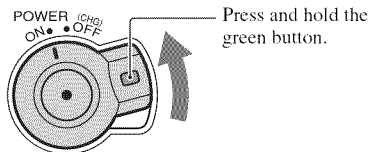

Notes

- The current date and time appear on the LCD screen for a few seconds when you turn on your camcorder after you set the date and time with [CLOCK SET] (p. 22).

Step 4: Turning the power on and holding your camcorder properly (Continued)

2 Hold the camcorder properly.

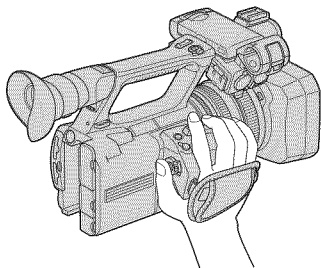

3 Ensure a good grip, then fasten the grip belt.

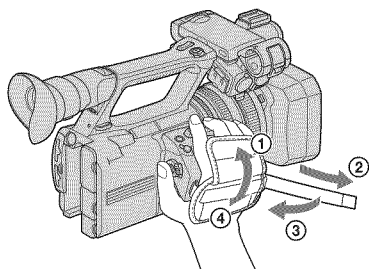

To turn off the power

Slide the POWER switch to OFF (CHG).

Notes

- If warning messages appear on the screen, follow the instructions (p. 93).

Step 5: Adjusting the LCD panel and viewfinder

LCD panel

Open the LCD panel 180 degrees (①), then rotate it to the best angle to record or play back (②).

① Open 180 degrees.

② 90 degrees (max.)

② 180 degrees (max.)

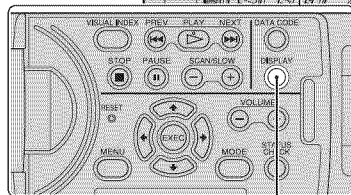
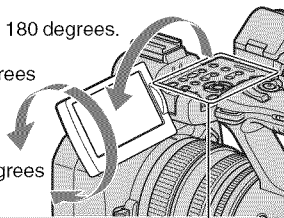



DISPLAY button

Tips

- Images are displayed as mirror images on the LCD screen, but are recorded as normal images.

To turn off the LCD backlight to make the battery last longer

Press and hold the DISPLAY button for a few seconds until  appears.

This setting is practical when you use your camcorder in bright conditions or when you want to save battery power. The recorded picture will not be affected by the setting. To turn on the LCD backlight, press and hold the DISPLAY button for a few seconds until  disappears. Also, you can turn on the LCD backlight by turning on/off the camcorder.

Tips

- You can adjust the brightness of the LCD screen from [LCD BRIGHT] (p. 78).

Viewfinder

You can view picture using the viewfinder to save the battery, or when the picture on the LCD screen is not clear.

Viewfinder lens adjustment lever

Move it until the picture becomes clear.

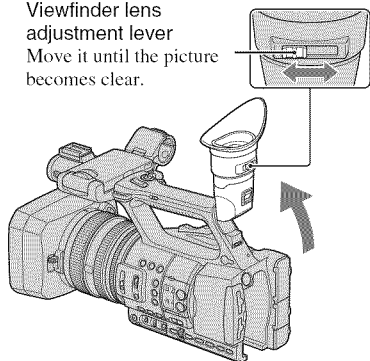

Notes

- You may see primary colors shimmering in the viewfinder when you move your line of sight. This is not a malfunction. The shimmering colors will not be recorded on the memory card.

Tips

- You can adjust the brightness of the viewfinder backlight from [VF BACKLIGHT] (p. 79).
- To display images both on the LCD display and in the viewfinder, set [VF POWERMODE] to [ON] (p. 79).

When the picture in the viewfinder is hard to see

If you cannot see the picture in the viewfinder clearly under bright circumstances, use the supplied large eyecup. To attach the large eyecup, stretch it slightly and align it with the eyecup groove in the viewfinder. You can attach the large eyecup facing either the right or left side.

Notes

- Do not remove the pre-attached eyecup.

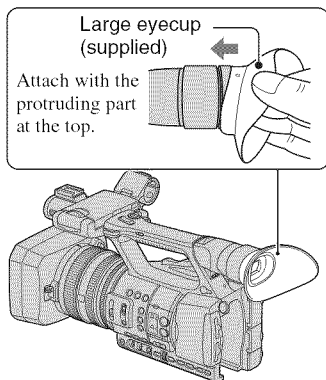

Step 6: Setting the date and time

Set the date and time when using your camcorder for the first time. If you do not set the date and time, [CLOCK SET] screen appears every time you turn on your camcorder.

💡 Tips

- If you do not use your camcorder for **about 3 months**, the built-in rechargeable battery gets discharged and the date and time settings may be cleared from the memory. In that case, charge the rechargeable battery and then set the date and time again (p. 103).

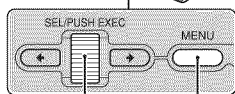
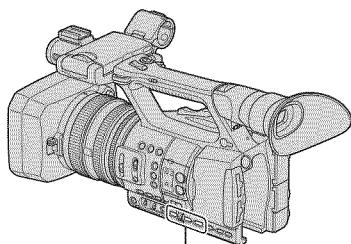

SEL/PUSH EXEC dial

MENU button

Skip to step 4 when you set the clock for the first time.

1 Press the MENU button.

2 Select (OTHERS) by turning the SEL/PUSH EXEC dial, then press the dial.

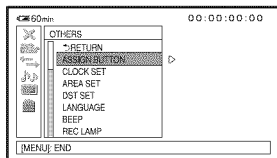

3 Select [CLOCK SET] by turning the SEL/PUSH EXEC dial, then press the dial.

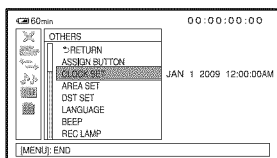

4 Select your area by turning the SEL/PUSH EXEC dial, then press the dial.

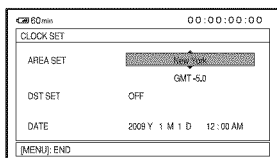

5 Set [DST SET]/[SUMMERTIME], [Y] (year), [M] (month), [D] (day), hour and minute, by turning the SEL/PUSH EXEC dial, then press the dial.

Step 7: Inserting a memory card

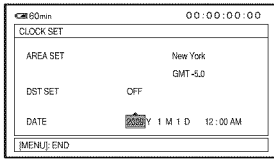

The clock starts.

- Set [DST SET]/[SUMMERTIME] to [ON] to move the time forward 1 hour.
- You can set any year up to the year 2037.
- For midnight, set it to 12:00 AM. For midday, set it to 12:00 PM.

💡 Tips

- The date and time are automatically recorded on the selected memory card, and can be displayed during playback (DATA CODE button, p. 49).

Changing the language setting

You can change the on-screen displays to show messages in a specified language. Press the MENU button and select  (OTHERS) with the SEL/PUSH EXEC dial. Select the screen language in [LANGUAGE] (p. 80).

- 1 Open the cover in the direction of the arrow.

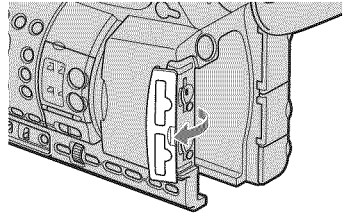

- 2 Orient the memory card's notched corner as shown in the illustration, and insert into the memory card slot until it clicks.

Memory card slot A and its access lamp

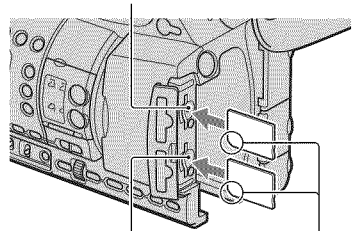

Memory card slot B and its access lamp

Insert with the notched corner first, and facing down.

🔔 Notes

- If you insert a memory card into the slot in the wrong direction, the memory card, the memory card slot, or image data may be damaged.
- When you insert a new memory card in standby mode, the [Create a new Image

Step 7: Inserting a memory card (Continued)

Database File.] screen appears. Follow the screen indication, and touch [YES].

To eject the memory card

Lightly push the memory card once.

🔊 Notes

- When the access lamp is lit or flashing in red, your camcorder is reading/writing data. Do not shake or knock your camcorder, turn the power off, eject the memory card, or remove the battery pack. Otherwise, image data may be damaged.
- If [Failed to create a new Image Database File. It may be possible that there is not enough free space.] appears in step 2, format the memory card (p. 62).
- When inserting or ejecting the memory card, be careful to prevent the memory card from popping out and dropping.

Selecting the memory card slot to be used for recording

Press the A or B button of the memory card slot where the memory card you want to record on is inserted. The lamp of the selected slot lights up in green.

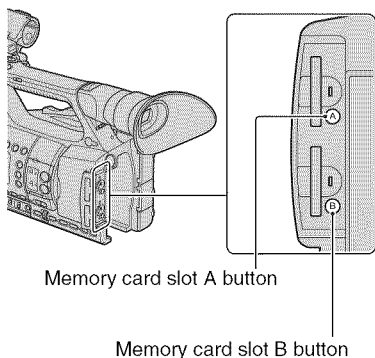

🔊 Notes

- You can only select a slot that already has a memory card inserted.
- While movies are being recorded on the memory card, you cannot switch the slot even if you press the memory card slot A/B buttons.

💡 Tips

- When only one slot has a memory card inserted, the slot that has the memory card is selected automatically.
- If the memory card is fully recorded during recording, the camcorder continues recording automatically on the memory card inserted in the other slot (Relay recording, p. 26).

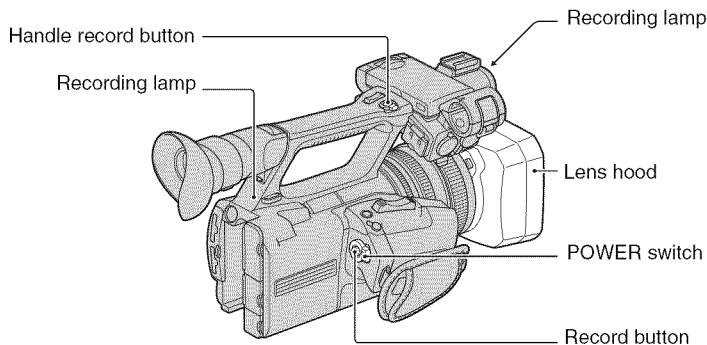

Your camcorder records movies on memory cards. Do the following steps to record movies.

- This camcorder can record movies in either high definition image quality (HD) or standard definition image quality (SD). The factory setting is high definition image quality (HD) ([REC FORMAT], p. 27).

⚙ Notes

- When the access lamp is lit or flashing in red, your camcorder is writing data on the memory card. Do not shake or knock your camcorder, or remove the battery pack or the AC Adaptor.
- See page 95 on the recording time of movies.
- Your camcorder can record movies for about 13 hours continuously.
- If a movie file exceeds 2 GB during recording, the camcorder divides the file and create a new file automatically.
- The menu settings, the PICTURE PROFILE settings, and the settings made by the AUTO/MANUAL switch are stored in your camcorder when you turn the POWER switch to OFF. The access lamp lights up while the settings are being stored. If you remove the battery pack or the AC Adaptor before turning off the power, the settings may return to the default settings.

1 Open the shutter of the lens hood.

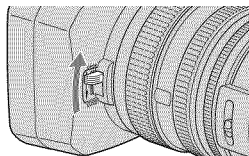

2 Slide the POWER switch to ON while pressing the green button.

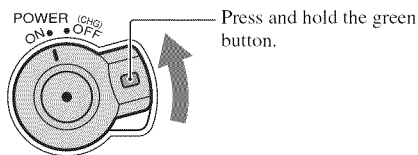

3 Press the record button or the handle record button.

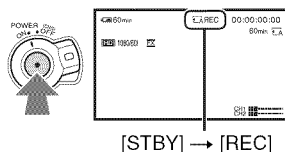

The recording lamp lights up during recording.

To stop the movie recording, press the record button or the handle record button again.

Tips

- When recording in high definition image quality (HD), the aspect ratio is fixed to 16:9. When recording in standard definition image quality (SD), you can switch the aspect ratio to 4:3 ([**HSD**] WIDE REC), p. 73).
- You can change the screen display during recording (p. 49).
- Indicators displayed on the screen during recording are shown on page 114.
- The recording lamp can be set to stay off ([REC LAMP], p. 80).
- For low angle recording, the handle record button is convenient. Release the HOLD lever to enable the handle record button. It might be helpful if you set the LCD panel face up or close it after turning it face down, or lift the viewfinder up during the low angle recording.
- You can capture still images from the movies you recorded (p. 59).

To continue recording on memory cards, one after another (Relay recording)

Insert memory cards each in both slots A and B, so the camcorder switches memory card A (or B) just before space on the other one runs out, and continues recording on the next memory card automatically.

Insert a recordable memory card.

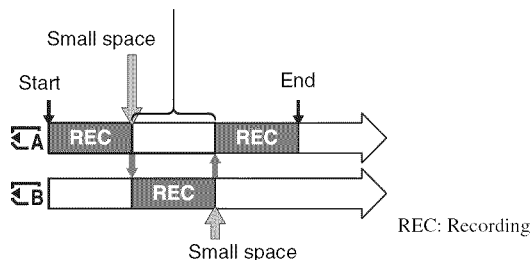

Notes

- Do not eject the memory card that is currently being used for recording. Replace only the memory card whose slot lamp is off.
- Even if you press the memory card slot button, A or B, while recording movies, you cannot switch the slot currently being used.
- When the remaining recording time of the memory card being used is less than 1 minute and the other slot has a recordable memory card inserted, [A → B] or [B → A] appears on the camcorder screen. The indicator turns off when the memory card is switched.
- If you start recording on a memory card with the remaining recording time of less than 1 minute, the camcorder may not be able to relay-record. To relay-record without fail, make sure that the memory card has more than 1 minute when you start recording.
- Seamless playback of relay-recorded movies with this camcorder is not possible.
- You can re-combine relay-recorded movies using the supplied application software (Windows only).

Selecting the recording format

You can select the recording format (bit-rate, image quality, image size, frame rate, scanning system). In the default setting, [HD 1080/60i FX] is selected.

To change the setting

Press MENU → select (REC/OUT SET) → [REC FORMAT] with the SEL/PUSH EXEC dial.

Recording (Continued)

Setting value	Description
[HD] 1080/60i FX	<ul style="list-style-type: none">• Bit-rate FX: max. 24 Mbps FH: approx. 17 Mbps (average) HQ: approx. 9 Mbps (average) LP: approx. 5 Mbps (average)
[HD] 1080/60i FH	
[HD] 1080/60i HQ	<ul style="list-style-type: none">• Image quality HD: High definition image quality SD: Standard definition image quality
[HD] 1080/60i LP	
[HD] 1080/30p FX	<ul style="list-style-type: none">• Image size FX: 1920×1080 FH: 1920×1080 HQ: HD recording 1440×1080 SD recording 720×480 LP: 1440×1080
[HD] 1080/30p FH	
[HD] 1080/24p FX	<ul style="list-style-type: none">• Frame rate either 24, 30, or 60
[HD] 1080/24p FH	
[HD] 1080/24p FX	<ul style="list-style-type: none">• Scanning system i: interlace p: progressive pSCAN: Records images of progressive scanning system as interlace signal (60i).
[SD] 480/60i HQ	
[SD] 480/30p SCAN HQ	
[SD] 480/24p SCAN HQ	

Setting value

If you select [**[HD]** 1080/60i **FX**], for example, movies are recorded with following format.

- HD: High definition image quality. SD is standard definition image quality.
- 1080: Effective scanning lines
- 60: Frame rate
- i: Scanning system
- FX: Recording mode

🔔 Notes

- The recording mode is fixed to FX or FH with the progressive scanning system.

Changing the settings of your camcorder recordings

Adjusting the zoom

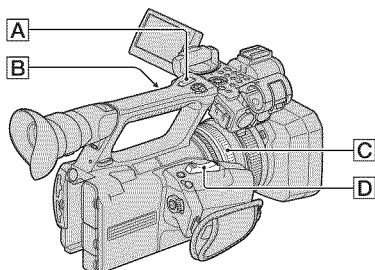

Using the power zoom lever

Move the power zoom lever **D** slightly for a slower zoom. Move it further for a faster zoom.

Wide view: (Wide angle)

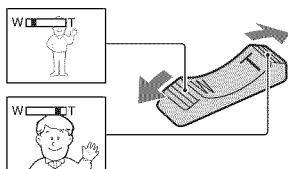

Close view: (Telephoto)

💡 Tips

- The minimum distance required between your camcorder and the subject for focus is about 1 cm (about 13/32 in.) for wide angle and about 80 cm (about 2 5/8 feet) for telephoto.
- The focus may not be adjusted at certain zoom positions if the subject is within 80 cm (about 2 5/8 feet) from your camcorder.
- Be sure to keep your finger on the power zoom lever **D**. If you move your finger off the power zoom lever **D**, the operation sound of the power zoom lever **D** may also be recorded.

Using the handle zoom

- ① Set the handle zoom switch **B** to VAR or FIX.

💡 Tips

- When you set the handle zoom switch **B** to VAR, you can zoom in or out at variable speed.
- When you set the handle zoom switch **B** to FIX, you can zoom in or out at fixed speed set in [HANDLE ZOOM] (p. 71).

- ② Press the handle zoom lever **A** to zoom in or out.

⚠ Notes

- You cannot use the handle zoom lever **A** when the handle zoom switch **B** is set to OFF.
- You cannot change the zoom speed of the power zoom lever **D** with the handle zoom switch **B**.

Using the zoom ring

You can zoom at the desired speed by turning the zoom ring **C**. Fine adjustment is also possible.

⚠ Notes

- Turn the zoom ring **C** at a moderate speed. If you turn it too fast, the zoom speed may lag behind the zoom ring rotation speed, or the operation sound of the zoom may also be recorded.

Adjusting the focus manually

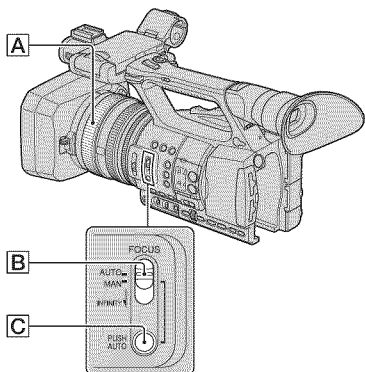

You can adjust the focus manually for different recording conditions.

Use this function in the following cases.

- To record a subject behind a window covered with raindrops.
- To record horizontal stripes.
- To record a subject with little contrast between the subject and its background.
- When you want to focus on a subject in the background.

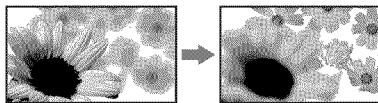

- To record a stationary subject using a tripod.

1 During recording or standby, set the FOCUS switch **B** to MAN.

appears.

2 Rotate the focus ring **A** and adjust the focus.

changes to when the focus cannot be adjusted any farther. changes to when the focus cannot be adjusted any closer.

Tips

For focusing manually

- It is easier to focus on the subject when you use the zoom function. Move the power zoom lever towards T (telephoto) to adjust the focus, and then, towards W (wide angle) to adjust the zoom for recording.
- When you want to record a close-up image of a subject, move the power zoom lever towards W (wide angle) to fully magnify the image, then adjust the focus.

To restore automatic adjustment

Set the FOCUS switch **B** to AUTO.

disappears and the automatic focus adjustment is restored.

Using automatic focus temporarily (Push auto focus)

Record the subject while pressing and holding the PUSH AUTO button **C**.

If you release the button, the setting returns to manual focusing.

Use this function to shift the focus on one subject to another. The scenes will shift smoothly.

Tips

- The focal distance information (for when it is dark and hard to adjust the focus) appears for about 3 seconds in the following cases. (It will not be displayed correctly if you are using a conversion lens (sold separately)).
 - When you set the FOCUS switch **B** to MAN and appears on the screen
 - When you rotate the focus ring while is displayed on the screen.

Using the expanded focus (Expanded focus)

[EXPANDED FOCUS] is assigned to the ASSIGN 7 button (p. 43).

Press the ASSIGN 7 button.

[EXPANDED FOCUS] appears and the center of the screen is magnified by about 2.0 times. It will be easier to confirm the focus setting during manual focusing. The screen returns to the original size when you press the button again.

Notes

- Even though the image appears expanded on the screen, the recorded image is not expanded.

Tips

- You can select a type of an expanded image displayed during the expanded focus ([EXPANDED FOCUS TYPE], p. 78).

Focusing on a distant subject (Focus infinity)

Slide the FOCUS switch **B** to INFINITY and hold it there.

▲ appears on the screen.

To return to manual focus mode, release the FOCUS switch **B**. This function enables you to set focus on a distant subject even when the focus is automatically set on a close subject.

Notes

- This function is only available during the manual focus. It is not available during the automatic focus.

Adjusting the image brightness

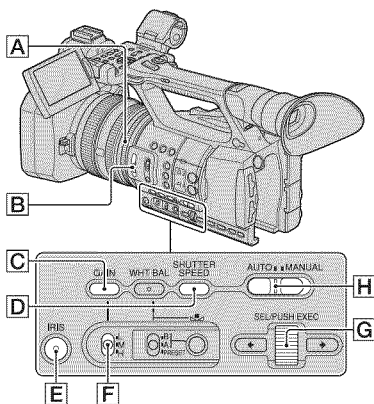

You can adjust the image brightness by adjusting the iris, gain or shutter speed, or by reducing the light volume with the ND filter **B**.

Notes

- You cannot use the back light function and the spotlight function when iris, gain and shutter speed are adjusted manually.
- [AE SHIFT] is not effective temporarily while you adjust the iris, gain and shutter speed all manually.

Adjusting the iris

You can manually adjust the iris to control the volume of the light entering the lens. By adjusting the iris, you can change or close (**CLOSE**) the aperture of the lens, which is expressed as an F value between F1.6 and F11. The volume of the light increases the more that you open the aperture (decreasing F value). The volume of the light decreases the more that you close the aperture (increasing F value). The current F value appears on the screen.

- ① During recording or standby, set the AUTO/MANUAL switch **H** to MANUAL.

Changing the settings of your camcorder recordings (Continued)

- ② When the iris is automatically adjusted, press the IRIS button **[E]**.

[A] next to the iris value disappears, or the iris value appears on the screen.

- ③ Adjust the iris with the iris ring **[A]**. When you assign [PUSH AUTO IRIS] to one of the ASSIGN buttons, you can automatically adjust the iris while pressing and holding that ASSIGN button. See page 43 for details on the ASSIGN button.

Tips

- The F value becomes close to F3.4 as the zoom position changes from W to T even when you open the aperture by setting the F value lower than F3.4, such as F1.6.
- The range of focus, an important effect of the aperture, is called the depth of field. The depth of field gets shallower as the aperture is opened, and deeper as the aperture is closed. Use the aperture creatively to obtain the desired effect in your photography.
- This is handy for making the background blurred or sharp.

To adjust the iris automatically

Press the IRIS button **[E]**, or set the AUTO/MANUAL switch **[H]** to AUTO.

The iris value disappears, or **[A]** appears next to the iris value.

Notes

- When you set the AUTO/MANUAL switch **[H]** to AUTO, other manually adjusted items (gain, shutter speed, white balance) also become automatic.

Adjusting the gain

You can adjust the gain manually when you do not want to use the AGC (automatic gain control).

- ① During recording or standby, set the AUTO/MANUAL switch **[H]** to MANUAL.
- ② When the gain is automatically adjusted, press the GAIN button **[C]**.

[A] next to the gain value disappears, or the gain value appears on the screen.

- ③ Set the gain switch **[F]** to H, M or L. The gain value set for the selected gain switch position appears on the screen. You can set the gain value for each gain switch position from [GAIN SET] of the  (CAMERA SET) menu (p. 69).

To adjust the gain automatically

Press the GAIN button **[C]**, or set the AUTO/MANUAL switch **[H]** to AUTO. The gain value disappears, or **[A]** appears next to the gain value.

Notes

- When you set AUTO/MANUAL switch **[H]** to AUTO, other manually adjusted items (iris, shutter speed, white balance) also become automatic.

Tips

- When you record high definition image quality (HD) movies with the gain set to [-6dB] and play them back with the data code, the gain value is displayed as [---].

Adjusting the shutter speed

You can manually adjust and fix the shutter speed. You can make a moving subject look still or emphasize the movement of a moving subject by adjusting the shutter speed.

- ① During recording or standby, set the AUTO/MANUAL switch **[H]** to MANUAL.
- ② Press the SHUTTER SPEED button **[D]** until the shutter speed value is highlighted.
- ③ Change the shutter speed displayed on the screen by turning the SEL/PUSH EXEC dial **[G]**. You can adjust the shutter speed in a range of 1/4 second through 1/10000 second.

The denominator of the set shutter speed appears on the screen. For example,

[100] appears on the screen when you set the shutter speed to 1/100 second. The larger the value on the screen, the faster the shutter speed.

- ④ Press the SEL/PUSH EXEC dial **G** to lock the shutter speed.
To readjust the shutter speed, do steps ② to ④.

💡 Tips

- You can set a shutter speed between 1/3 second and 1/10000 second with the frame rate of 24p or 24p SCAN.
- It is difficult to focus automatically at a lower shutter speed. Manual focusing with your camcorder attached to a tripod is recommended.
- When recording under fluorescent lamps, sodium lamps, or mercury lamps, the picture may flicker or change colors, or may have horizontal bands of noise. You may be able to improve the situation by adjusting the shutter speed.

To adjust the shutter speed automatically

Press the SHUTTER SPEED button **D** twice, or set the AUTO/MANUAL switch **H** to AUTO.

The shutter speed value disappears, or **A** appears next to the shutter speed value.

🔊 Notes

- When you set the AUTO/MANUAL switch **H** to AUTO, other manually adjusted items (iris, gain, white balance) also become automatic.

Adjusting the volume of light (ND filter)

You can record the subject clearly by using the ND filter **B** when the recording environment is too bright.

The ND filters 1, 2 and 3 reduce the volume of light to about 1/4, 1/16 and 1/64, respectively.

If **ND1** flashes during the iris automatic adjustment, set the ND filter to 1. If **ND2** flashes during the iris automatic adjustment, set the ND filter to 2. If **ND3**

flashes during the iris automatic adjustment, set the ND filter to 3. The ND filter indicator will stop flashing and remain on the screen.

If **NDOFF** flashes, set the ND filter to OFF. The ND filter icon will disappear from the screen.

🔊 Notes

- If you change the ND filters **B** during recording, the movie and sound may be distorted.
- When adjusting the iris manually, the ND filter icon does not flash even if the light volume should be adjusted with the ND filter.
- If the camcorder cannot detect the ND filter position (OFF/1/2/3), **ND** flashes on the screen. Make sure that the ND filter is set correctly.

💡 Tips

- While recording a bright subject, diffraction may occur if you close the aperture further down, resulting in a fuzzy focus (this is a common phenomenon with video cameras). The ND filter **B** suppresses this phenomenon and gives better recording results.

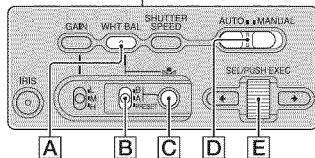
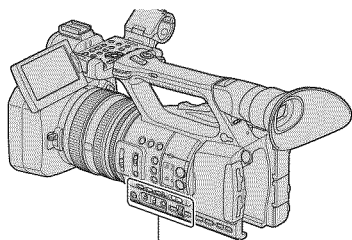

Adjusting to natural color (White balance)



You can adjust and fix the white balance according to the lighting conditions of

Changing the settings of your camcorder recordings (Continued)

recording environment.

You can store white balance values in memory A ( A) and memory B ( B), respectively. Unless a white balance is readjusted, values will remain even after the power has been turned off.



When you select PRESET, [OUTDOOR] or [INDOOR] is selected, according to which one you previously set with [WB PRESET] in the  (CAMERA SET) menu.

1 During recording or standby, set the AUTO/MANUAL switch  to MANUAL.

2 Press the WHT BAL button .









3 Set the white balance memory switch  to any one of PRESET/A/B.

Select A or B for recording with the white balance setting stored in memory A or B.



Indicator	Shooting conditions
 A (Memory A)	• White balance values adjusted for light sources can be stored in memory A and memory B. Follow the steps in "To save the adjusted white balance value in memory A or B" (p. 34).
 B (Memory B)	
 Outdoor ([OUTDOOR])	• Recording neon signs or fireworks • Recording sunset/sunrise, just after sunset or just before sunrise • Under daylight color fluorescent lamps

Indicator	Shooting conditions
 Indoor ([INDOOR])	• Under the lighting conditions that change in many ways, such as a party hall • Under strong light, such as in a photography studio • Under sodium lamps or mercury lamps

To save the adjusted white balance value in memory A or B

- ① Set the white balance memory switch to A ( A) or B ( B) in step 3 of "Adjusting to natural color (White balance)."
- ② Capture a white subject, such as white paper, full-screen in the same lighting condition as the one in which the subject is.
- ③ Press the  (one push) button .  A or  B starts flashing rapidly. It will stay on when the white balance adjustment is completed and the adjusted value is stored in  A or  B.

Notes

- When a white balance adjustment value has not been obtained successfully,  A or  B turns from rapid flashing to slow flashing. Adjust the subject appropriately and set the shutter speed to auto or around 1/60, then try adjusting the white balance again.
- It may take a long time to adjust the white balance, depending on the recording conditions. If you want to perform a different operation before completing the adjustment, set the white balance memory switch  to another position to temporarily suspend white balance adjustment.

To adjust the white balance automatically

Press the WHT BAL button **A** or set the AUTO/MANUAL switch **D** to AUTO.

Notes

- When you set the AUTO/MANUAL switch **D** to AUTO, other manual adjusted items (iris, gain, and shutter speed) also become automatic.

Customizing the picture quality (Picture profile)

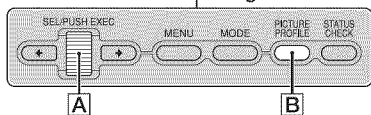
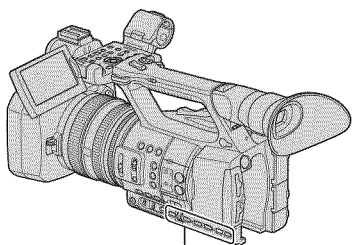

You can customize the picture quality by adjusting picture profile items such as [GAMMA] and [DETAIL].

Connect your camcorder to a TV or monitor, and adjust the picture quality while observing the picture on the TV or monitor screen.

Picture quality settings for different recording conditions have been stored in [PP1] through [PP6] as default settings.

Notes

- When you set [x.v.Color] in the  (CAMERA SET) menu to [ON], the picture profile will be disabled.

Picture profile number	Recording condition
PP1	You can assign your own setting
PP2	You can assign your own setting.
PP3	Appropriate setting to record people
PP4	Appropriate setting to record film-like pictures
PP5	Appropriate setting to record sunset
PP6	Appropriate setting to record black and white pictures

1 During standby, press the PICTURE PROFILE button **B**.

2 Select a picture profile number with the SEL/PUSH EXEC dial **A**.

You can record with the settings of the selected picture profile.

3 Select [OK] with the SEL/PUSH EXEC dial **A**.

To cancel the picture profile recording

Select [OFF] in step **2** with the SEL/PUSH EXEC dial **A**.

To change the picture profile

You can change the settings stored in [PP1] through [PP6].

- Press the PICTURE PROFILE button **B**.

Changing the settings of your camcorder recordings (Continued)

- ② Select the PICTURE PROFILE number with the SEL/PUSH EXEC dial **A**.
- ③ Select [SETTING] with the SEL/PUSH EXEC dial **A**.
- ④ Select an item to be adjusted with the SEL/PUSH EXEC dial **A**.
- ⑤ Adjust the picture quality with the SEL/PUSH EXEC dial **A**.
- ⑥ Repeat steps ④ and ⑤ to adjust other items.
- ⑦ Select [↩ RETURN] with the SEL/PUSH EXEC dial **A**.
- ⑧ Select [OK] with the SEL/PUSH EXEC dial **A**.
A picture profile indicator appears.

GAMMA

To select a gamma curve.

Item	Description and settings
[STANDARD]	Standard gamma curve
[CINEMATONE1]	Gamma curve 1 for producing tone of film camera images
[CINEMATONE2]	Gamma curve 2 for producing tone of film camera images

COLOR MODE

To set type and level of colors.

Item	Description and settings
[TYPE]	Selects a type of colors. [STANDARD] : Standard colors [CINEMATONE1]: Film camera image-like colors good with [GAMMA] set to [CINEMATONE1] [CINEMATONE2]: Film camera image-like colors good with [GAMMA] set to [CINEMATONE2]
[LEVEL]	Sets a color level when you set [TYPE] to the settings other than [STANDARD]. 1 (close to color settings of [STANDARD]) to 8 (color settings of the selected type)

COLOR LEVEL

To set the color level.

Item	Description and settings
	-7 (light) to +7 (dark), -8: black and white

COLOR PHASE

To set the color phase.

Item	Description and settings
	-7 (greenish) to +7 (reddish)

WB SHIFT

To set items for the white balance shift.

Item	Description and settings
[LB[COLOR TEMP]]	Sets a color temperature offset value. -9 (bluish) to +9 (reddish)
[CC[MG/GR]]	Sets a color correct offset value. -9 (greenish) to +9 (magentish)

Changing the settings of your camcorder recordings (Continued)

DETAIL

To set items for the detail.

Item	Description and settings
	Sets the detail level. -7 to +7

SKINTONE DETAIL

To adjust the detail of skintone areas to reduce wrinkles.

Item	Description and settings
[ON/OFF]	Suppresses details in skin-tone areas to reduce wrinkles. Select [ON] when you want to use this function. You can also select other areas.
[LEVEL]	Sets the adjustment level. 1 (less adjust the detail) to 8 (more adjust the detail)
[COLOR SEL]	Sets color items for the detail adjustment. [PHASE] : Sets the color phase. 0 (purple) → 32 (red) → 64 (yellow) → 96 (green) → 127 (blue) [RANGE] : Sets the color range. 0 (selects no color), 1 (narrow: selects a single color) to 31 (wide: selects multiple colors in similar color phases and saturation) The detail will not be adjusted when you set [RANGE] to 0. [SATURATION] : Sets the color saturation. 0 (selects a light color) to 31 (selects a deep color)

COPY

To copy the settings of the picture profile to another picture profile number.

RESET

To reset the picture profile to the default setting.

To copy the picture profile setting to another picture profile number

See page 35 for the location of the buttons.

- 1 Press the PICTURE PROFILE button **B**.
- 2 Select the picture profile number that you want to copy from with the SEL/PUSH EXEC dial **A**.
- 3 Select [SETTING] → [COPY] with SEL/PUSH EXEC dial **A**.
- 4 Select the number of the picture profile that you want to copy to with the SEL/PUSH EXEC dial **A**.
- 5 Select [YES] with the SEL/PUSH EXEC dial **A**.
- 6 Select [↵ RETURN] → [OK] with the SEL/PUSH EXEC dial **A**.

To reset the picture profile settings

You can reset the picture profile settings by each picture profile number. You cannot reset all picture profile settings at once. See page 35 for the location of the buttons.

- 1 Press the PICTURE PROFILE button **B**.
- 2 Select the number of the picture profile that you want to reset with the SEL/PUSH EXEC dial **A**.
- 3 Select [SETTING] → [RESET] → [YES] → [↵ RETURN] → [OK] with the SEL/PUSH EXEC dial **A**.

Audio setup

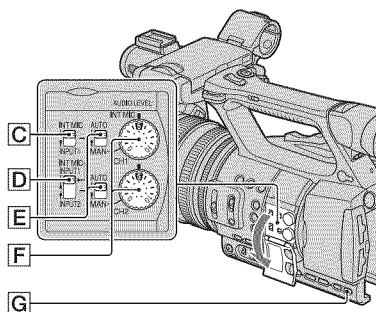
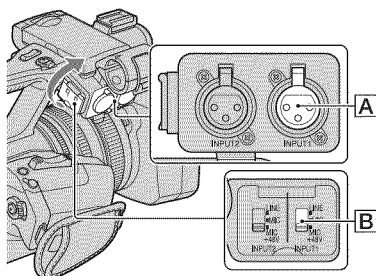

Channel setting

- 1 Select input sources with the CH1 (INT MIC/INPUT1) switch **C** and the CH2 (INT MIC/INPUT1/INPUT2) switch **D**. See the table below for the recording channels.

Changing the settings of your camcorder recordings (Continued)

When the CH1 switch is set to INT MIC

CH2 switch position	Input channel and source
INT MIC	Internal microphone (L) → CH1
	Internal microphone (R) → CH2*
INPUT1	Internal microphone (mono) → CH1
	XLR INPUT1 → CH2**
INPUT2	Internal microphone (mono) → CH1
	XLR INPUT2 → CH2**

When the CH1 is set to INPUT1

CH2 switch position	Input channel and source
INT MIC	XLR INPUT1 → CH1
	Internal microphone (mono) → CH2**
INPUT1	XLR INPUT1 → CH1
	XLR INPUT1 → CH2**
INPUT2	XLR INPUT1 → CH1
	XLR INPUT2 → CH2**

* The recording level of channel 2 is synchronized with that of channel 1 when only the internal microphone is used. The recording level of channel 2 is controlled with the CH1 (AUDIO LEVEL) dial and the CH1 (AUTO/MAN) switch.

** You can adjust the recording levels of channel 1 and channel 2 separately.

② Set the INPUT1 switch **[B]** to an appropriate position for the microphone connected to the INPUT1 jack **[A]**.

LINE: For inputting sound from an audio device

MIC: For inputting sound from an external microphone that does not support the +48V power source.

MIC+48V: For inputting sound from a device that supports the +48V power source.

When you connect a microphone to the INPUT2 jack, set the INPUT2 switch to an appropriate position for that microphone.

⚙ Notes

- Do not operate the INPUT1/INPUT2 switches during recording to prevent noise from being recorded.
- When you connect a device that supports the +48V power source to the INPUT1 or INPUT2 jack, set the INPUT1/INPUT2 switches to MIC prior to connecting the device. When you disconnect the device, set the INPUT1/INPUT2 switch to MIC first, then disconnect it.
- When you connect a microphone that does not support the +48V power source to the INPUT1 or INPUT2 jack, set the INPUT1/INPUT2 switch to MIC. If you use it with the INPUT1/INPUT2 switch set to MIC+48V, it may be damaged or the recorded sound may be distorted.

Adjusting the volume

You can adjust the volume of an internal microphone or a microphone connected to the INPUT1/INPUT2 jacks.

💡 Tips

- See page 39 on the CH1 (INT MIC/INPUT1) and the CH2 (INT MIC/INPUT1/INPUT2) switches.
- ① Set the AUTO/MAN (CH1/CH2) switch **[E]** of the channel to be adjusted to MAN.
M₁ appears on the screen.
- ② Turn the AUDIO LEVEL dial **[F]** to adjust the volume during recording or standby.

To restore automatic adjustment

Set the AUTO/MAN (CH1/CH2) switch **E** of the manually adjusted channel to AUTO.

💡 Tips

- To check other audio settings, press the STATUS CHECK button **G**.
- For other settings, see the  (AUDIO SET) menu (p. 75).

Setting the headphone sound

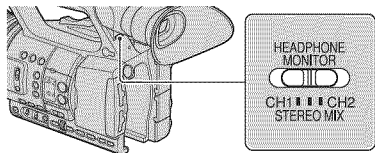

You can select the channel, CH1 or CH2, to output from the headphone.

See [HEADPHONE OUT] on the sound at STEREO MIX (p. 75).

Recording with the SMOOTH SLOW REC function

Fast moving subjects and actions, which cannot be captured under the general recording conditions, can be recorded in smooth moving slow-motion.

This is useful for recording fast actions such as a golf or tennis swing.

1 Press the MODE button.

2 On the LCD screen, select [CAMERA] → [SMOOTH SLOW REC].

3 Select the image quality.

4 Press the record button.

An about 6-second movie is stretched to about 24 seconds and recorded as a slow-motion movie.

Recording ends when [Recording...] disappears from the screen.

To cancel [SMOOTH SLOW REC], press the MODE button.

To change the setting

Press the MENU button, and select the setting to be changed.

■ [HD] REC MODE

You can select the record mode from [1080/60i FX], [1080/60i FH], [1080/60i HQ], or [1080/60i LP] for smooth slow recording.

■ TIMING

You can use this to select when recording starts in relation to when the record button (handle record button) is pressed.

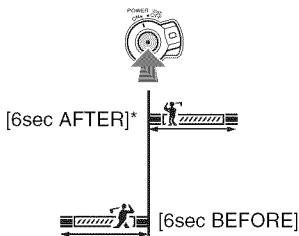

* The default setting is [6sec AFTER].

📌 Notes

- Sounds cannot be recorded.
- The shutter speed is automatically set to 1/250 second when you start [SMOOTH SLOW REC]. (You cannot set a slower shutter speed than 1/250 second.)
- The recording time may be shorter, depending on recording conditions.
- The image quality is lower than with the regular recording.

Changing the settings of your camcorder recordings (Continued)

- The camcorder does not perform relay recording with memory cards during [SMOOTH SLOW REC]. If the space on the memory card is insufficient, the camcorder records movies only as long as there is space available.
- The time of the movie recorded using [SMOOTH SLOW REC] is recorded after being converted to slow-motion, not the time when the movie is actually shot.
- Progressive recording is not available for [SMOOTH SLOW REC]. The progressive setting is changed to the interlace setting automatically.
- Even if you change the record mode with [**HD** REC MODE], the record mode of the standard definition image quality (SD) does not change.

Assigning the functions to the ASSIGN buttons

Some functions can be assigned to the ASSIGN buttons for use. You can assign a single function to any one of the ASSIGN 1 to 7 buttons.

Functions you can assign to the ASSIGN buttons

The buttons in parentheses indicate that the functions are assigned to the buttons by default.

- EXPANDED FOCUS (p. 31) (ASSIGN 7 button)
- PUSH AUTO IRIS (p. 31)
- IRIS RING ROTATE (p. 69)
- AE SHIFT (p. 70) (ASSIGN 5 button)
- BACK LIGHT (p. 70)
- SPOTLIGHT (p. 70)
- STEADYSHOT (p. 71)
- D.EXTENDER (p. 72)
- FADER (p. 72)
- COLOR BAR (p. 72)
- ZEBRA (p. 77) (ASSIGN 4 button)
- PEAKING (p. 77)
- MARKER (p. 77)
- REC LAMP (p. 80)
- VISUAL INDEX (p. 45) (ASSIGN 6 button)
- MODE (p. 56)

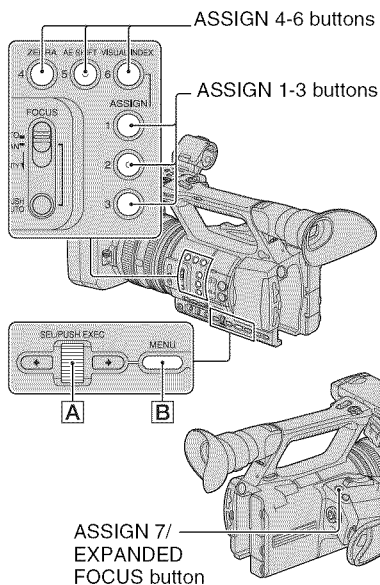

1 Press the MENU button **[B]**.

2 Select **[OTHERS]** → **[ASSIGN BUTTON]** with the SEL/PUSH EXEC dial **[A]**.

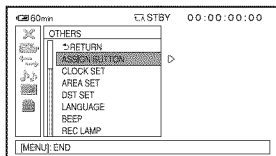

3 Select the ASSIGN button to which you want to assign a function with the SEL/PUSH EXEC dial **[A]**.

Assigning the functions to the ASSIGN buttons (Continued)

- [-----] appears if no function is assigned to the ASSIGN button.

4 Select the function that you want to assign with the SEL/PUSH EXEC dial **A**.

5 Select [OK] with the SEL/PUSH EXEC dial **A**.

6 Select [↵ RETURN] with the SEL/PUSH EXEC dial **A**.

7 Press the MENU button **B** to hide the menu screen.

Playback

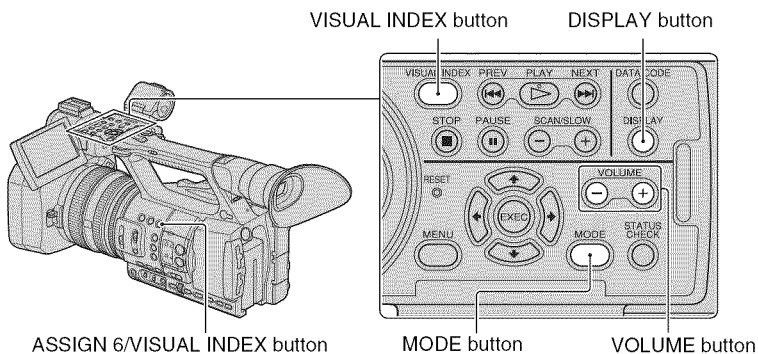

You can playback movies as follows:

1 Slide the POWER switch to ON.

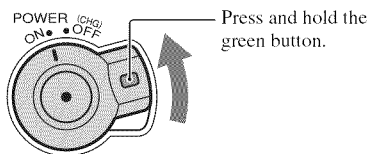

2 Press the VISUAL INDEX button.

The VISUAL INDEX screen appears after a few seconds.

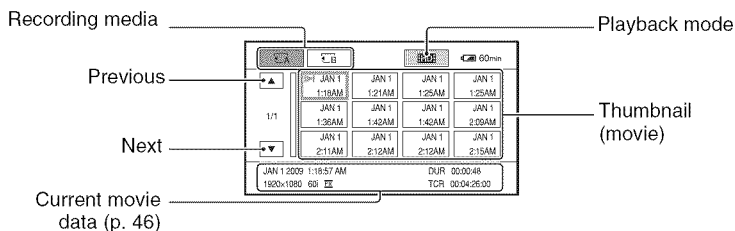

You can display the VISUAL INDEX screen also by pressing the MODE button, followed by touching [PLAY] → [VISUAL INDEX] on the screen.

You can turn on or off the time and date display on the thumbnails by pressing the DISPLAY button.

3 Play back movies.

- ① Touch the recording media you want to play back.

A: Memory card A

B: Memory card B

- ② Touch the playback mode, and select the desired image quality of movies.

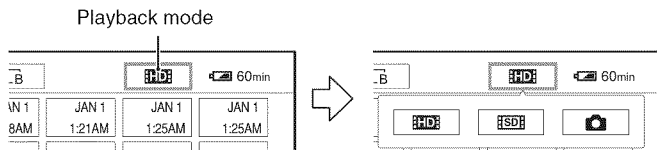

HD: High definition image quality (HD)

SD: Standard definition image quality (SD)

- ③ Touch twice the thumbnail of the movie you want to play back.

The first touch will show the information on the movie at the lower part of the screen.

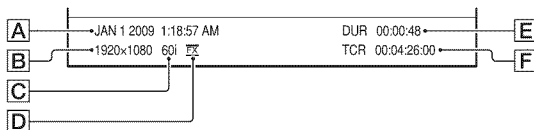

A Date and time of recording started

B Resolution

C Frame rate

D Record mode

E Duration

F Time code of recording started

Time code will not be displayed correctly when you play back the memory card with no time code, or the memory card with time code that your camcorder does not support.

- **▶▶** appears with the movie that has been most recently played back or recorded. If you touch the movie with **▶▶**, you can continue playback from the previous time.

Your camcorder starts playing the selected movie.

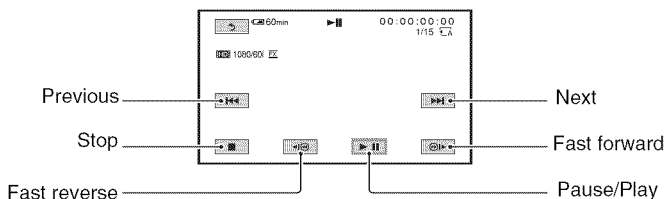

Notes

- You may not be able to play back movies recorded on other camcorders.

Tips

- When playback from the selected movie reaches the last movie, the screen returns to the VISUAL INDEX screen.
- Touch / during pause to play back movies slowly.
- As you repeat touching / during playback, movies are played back as fast as about 5 times → about 10 times → about 30 times → about 60 times.
- Reduced-size images which enable you to view many movies at the same time on the VISUAL INDEX screen are called "thumbnails."
- You can operate playback using the PREV/PLAY/NEXT/STOP/PAUSE/SCAN/SLOW buttons on the camcorder.

To adjust the volume

Adjust the volume with the VOLUME buttons.

To return to the recording mode

Press the VISUAL INDEX button.

Viewing still images

You can create still images by capturing scenes from movies that you recorded on your camcorder (p. 59).

View still images.

- Touch the recording media you want to view.
 - : Memory card A
 - : Memory card B

Playback (Continued)

- ② Touch the playback mode, then select  (still image).

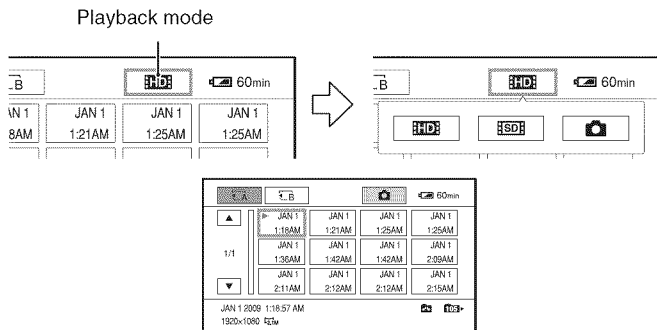

- ③ Touch twice the thumbnail of the still image you want to view.
The first touch will show the information on the still image at the lower part of the screen.

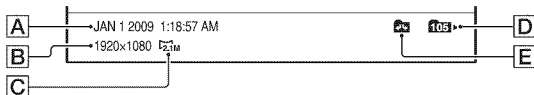

- A** Date and time of recording
- B** Resolution
- C** Image size
- D** Playback folder
- E** Playback folder edge

Indicates that this is the first or the last page of the playback folder. This does not appear when there is only 1 playback folder.

- ▶ appears on the still image that was played back most recently.

Your camcorder displays the selected still image.

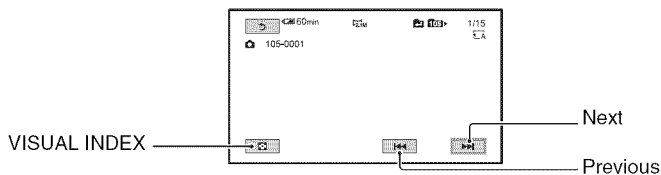

Changing/checking the settings in your camcorder

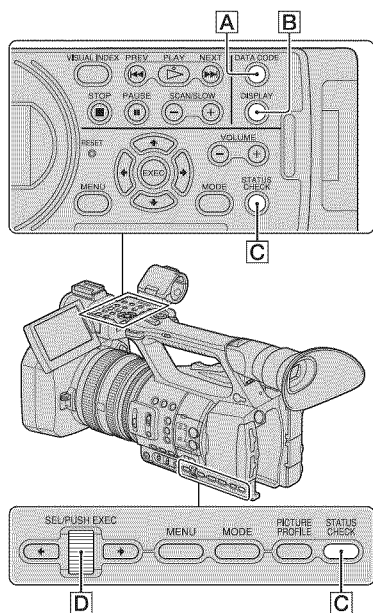

Changing the screen

You can turn on and off the display of the time code, and other information on the screen.

Press the **DISPLAY** button **B**.

The screen indicators turn on (displayed) and off (not displayed) as you press the button.

In the recording mode, the screen changes like “detailed display → simple display → no display” as you press the button.

Tips

- You can display the screen indicators during playback on a TV. Select [ALL OUTPUT] of [DISPLAY OUTPUT] (p. 79).

Displaying recording data (Data code)

You can display information, including date, time, and camera data automatically stored during recording on the screen during playback.

Press the **DATA CODE** button **A** during playback or pause.

The screen changes like “date and time display → camera data display → no display” as you press the button.

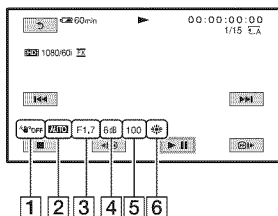

1 STEADYSHOT

2 Exposure

AUTO appears during playback of the movie recorded with the iris, gain or shutter speed automatically adjusted.

MANUAL appears during playback of the movie recorded with the iris, gain or shutter speed manually adjusted.

3 Iris

CLOSE appears in the iris value display area during playback of the movie recorded with the iris manually adjusted to its maximum value.

4 Gain

5 Shutter speed

6 White balance

Changing/checking the settings in your camcorder (Continued)

Notes

- The exposure correction value (EV), shutter speed, iris and flash on/off will be displayed during viewing still images.
- When you play back the memory card on other devices, the camera data may be displayed incorrectly. Confirm the correct camera data on your camcorder.

Displaying the settings in your camcorder (Status check)

You can check the settings of the following items.

- Audio setup such as microphone volume level (p. 75)
- Output signal setup ([VIDEO OUT], etc.) (p. 74)
- Functions assigned to the ASSIGN buttons (p. 43)
- Camera setup (p. 69)
- Memory card information
You can check the estimated used and free spaces.

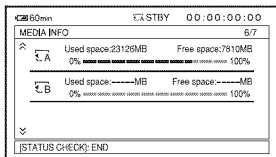

Battery Info

You can check the remaining capacity of the attached battery.

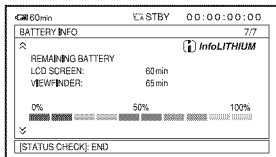

1 Press the STATUS CHECK button **C**.

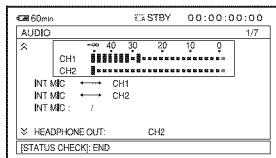

2 Turn the SEL/PUSH EXEC dial **D** until a desired display shows up on the screen.

AUDIO → OUTPUT → ASSIGN → CAMERA → MEDIA INFO → BATTERY INFO

Setup items are displayed according to the settings of the camcorder when it is turned on.

To hide the display

Press the STATUS CHECK button **C**.

Connecting a monitor or a TV (Continued)

Connecting to a high definition TV

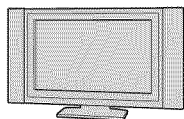

High definition image quality (HD) movies are played back in high definition image quality (HD).
Standard definition image quality (SD) movies are played back in standard definition image quality (SD).

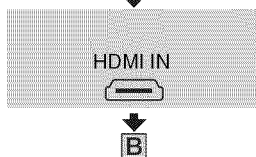
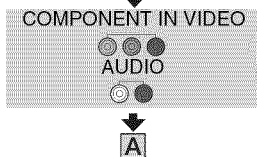

: Signal flow

Type	Camcorder	Cable	TV	Menu Setting
------	-----------	-------	----	--------------

A

①

A/V connecting cable (supplied)

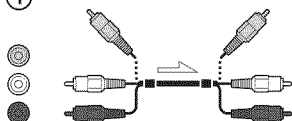

COMPONENT
IN

(White) (Red) AUDIO

(REC/OUT SET)
menu →
[VIDEO OUT] →
[COMPONENT
OUTPUT] →
[1080i/480i] (default)
(p. 74)

②

Component video cable
(supplied)

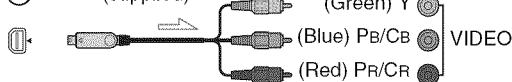

(Green) Y
(Blue) PB/CB
(Red) PR/CR
VIDEO

Notes

- If you connect only component video plugs, audio signals are not output. Connect the white and red plugs to output audio signals.

 : Signal flow

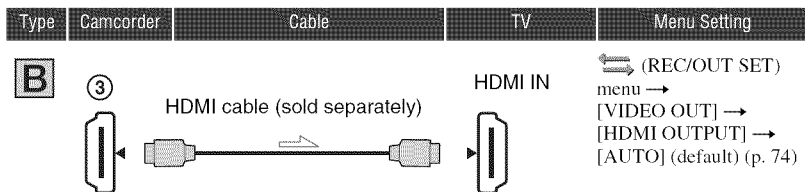

⚡ Notes

- **Use an HDMI cable with the HDMI logo.**
- Images are not output from the HDMI OUT jack of your camcorder, if copyright protection signals are recorded in the movies.
- Your TVs may not function correctly (for example, no sound or image).
- Do not connect the HDMI OUT jack of your camcorder and HDMI OUT jack of the external device with the HDMI cable. This may cause a malfunction.
- This camcorder is not compatible with "BRAVIA" sync.

Connecting a monitor or a TV (Continued)

Connecting to a 16:9 (wide) or 4:3 TV

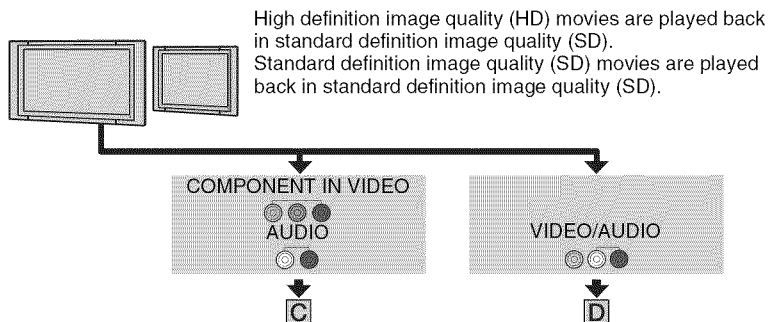

To set the aspect ratio according to the connected TV (16:9/4:3)

Select \rightleftarrows (REC/OUT SET) \rightarrow [VIDEO OUT] \rightarrow [TV TYPE] and the aspect ratio to match your TV (p. 74).

💡 Tips

- When your TV is monaural (when your TV has only one audio input jack), connect the yellow plug of the A/V connecting cable to the video input jack and connect the white (left channel) or the red (right channel) plug to the audio input jack of your TV or VCR. When you want to play the sound in monaural mode, use a connecting cable for that purpose.

\rightleftarrows : Signal flow

Type	Camcorder	Cable	TV	Menu Setting
C	<ol style="list-style-type: none"> 	 	COMPONENT IN (White) VIDEO (Red) AUDIO	\rightleftarrows (REC/OUT SET) menu \rightarrow [VIDEO OUT] \rightarrow [COMPONENT OUTPUT] \rightarrow [480i] (p. 74) [VIDEO OUT] \rightarrow [TV TYPE] \rightarrow [16:9]/[4:3]* (p. 74)
			(Green) Y (Blue) Pb/Cb (Red) Pr/Cr VIDEO	

🔊 Notes

- If you connect only component video plugs, audio signals are not output. Connect the white and red plugs to output audio signals.

Type	Camcorder	Cable	TV	Menu Setting
------	-----------	-------	----	--------------

D

①

A/V connecting cable (supplied)

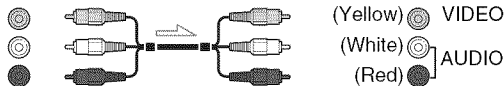

(No other jacks should be connected.)

↔ (REC/OUT SET)

menu →

[VIDEO OUT] →

[TV TYPE] →

[16:9]/[4:3]* (p. 74)

* Change the settings according to the TV connected.

When connecting to your TV via a VCR

Select the connecting method with [VIDEO OUT] (p. 74) depending on the input jack of the VCR. Connect your camcorder to the LINE IN input on the VCR. Set the input selector on the VCR to LINE (VIDEO 1, VIDEO 2, etc.).

🔊 Notes

- Images are output in standard definition image quality (SD) when the A/V connecting cable is used.
- When the frame rate of [REC FORMAT] is 24p or 30p, images are converted to the interlace signals by the pull-down system to be output.

💡 Tips

- The resolution of the signal depends on the [VIDEO OUT] setting. See page 74 for details.
- If you connect your camcorder to the TV using more than one type of cable to output images, the order of priority of the TV input jacks is as follows:
HDMI → component video → video.
- HDMI (High-Definition Multimedia Interface) is an interface to send both video/audio signals. The HDMI OUT jack outputs high quality images and digital audio.

Operating the MODE menu

You can edit the recorded movies, format memory cards, etc.

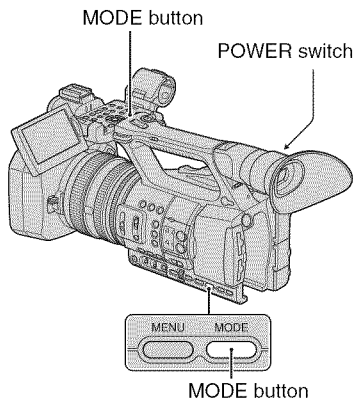

1 Set the POWER switch to ON.

2 Press the MODE button.

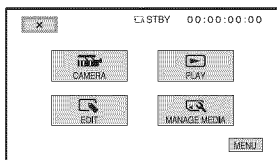

3 Touch the desired category.

Example: [EDIT] category

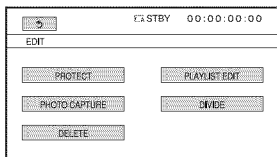

4 Touch the desired item.

Example: [DELETE]

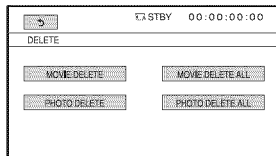

5 Operate following the instructions on the screen.

To hide the MODE menu screen

Touch , or press the MODE button.

To return to the previous screen

Touch .



Protecting recorded images (Protect)

Protect movies and still images to avoid deleting them by mistake.

💡 Tips

- You can also protect movies and still images by pressing the MENU button on the VISUAL INDEX screen or the playback screen.

To undo the protection of movies and still images

- Touch the movie or still image marked with  in step 4.
 disappears.

1 Press the MODE button.

2 Touch [EDIT] → [PROTECT].

3 To protect movies, touch [MOVIE PROTECT] → select the desired memory card and image quality.

To protect still images, touch [PHOTO PROTECT] → select the desired memory card.

4 Touch the movies or still images to be protected.

 is displayed on the selected images.

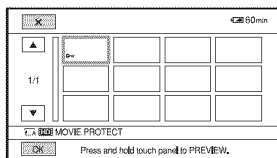

💡 Tips

- Press and hold the image down to preview the image. Touch  to return to the previous screen.
- You can select up to 100 images at one time.

5 Touch [OK] → [YES] → [OK].

Using the Playlist of movies

The Playlist is a list showing thumbnails of the movies that you have selected.

The original movies are not changed even if you edit or erase the movies added to the Playlist.

Creating the Playlist

Notes

- High definition image quality (HD) movies and standard definition image quality (SD) movies are added to individual Playlists.

1 Press the **MODE** button.

2 Touch **[EDIT]** → **[PLAYLIST EDIT]** → **[ADD]** → select the desired memory card and image quality.

3 Touch the movie to be added to the Playlist.

- ✓ is displayed on the selected movies.

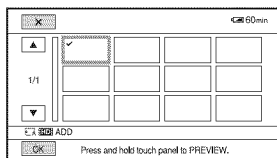

Tips

- Press and hold the image down to preview the image. Touch ↶ to return to the previous screen.

4 Touch **[OK]** → **[YES]** → **[OK]**.

Notes

- Do not remove the battery pack, the AC Adaptor or the memory card that contains the movies

from your camcorder during the operation. It may damage the memory card.

- You cannot add still images to a Playlist.

Tips

- You can add a maximum of 999 high definition image quality (HD) movies, or 99 standard definition image quality (SD) movies to the Playlist.
- You can also add movies by pressing the MENU button on the VISUAL INDEX screen, the playback screen or the Playlist screen.

Playing the Playlist

1 Press the **MODE** button.

2 Touch **[PLAY]** → **[PLAYLIST]** → select the desired memory card and image quality.

Movies added to the Playlist appear.

3 Touch the movie you want to play back.

The Playlist is played back from the selected movie to the end, then the screen returns to the Playlist screen.

To erase unnecessary movies from the Playlist

① Press the **MODE** button.

② Touch **[EDIT]** → **[PLAYLIST EDIT]** → **[ERASE]** → select the desired memory card and image quality.

- To erase all the movies from the Playlist, touch **[EDIT]** → **[PLAYLIST EDIT]** → **[ERASE ALL]** → select the desired memory card and image quality.

③ Touch the movie to be erased from the list.

- ✓ is displayed on the selected movies.

Capturing still images from a movie

💡 Tips

- Press and hold the image down to preview the image. Touch  to return to the previous screen.

④ Touch **OK** → [YES] → **OK**.

💡 Tips



- Even if you erase a movie from a Playlist, the original movie is not deleted.
- You can also erase movies by pressing the MENU button on the Playlist screen or the Playlist playback screen.

To change the order within the Playlist

- ① Press the MODE button.
- ② Touch [EDIT] → [PLAYLIST EDIT] → [MOVE] → select the desired memory card and image quality.
- ③ Touch the movie to be moved.
✓ is displayed on the selected movies.

💡 Tips

- Press and hold the image down to preview the image. Touch  to return to the previous screen.

- ④ Touch **OK**.
- ⑤ Select the destination with  / .
- ⑥ Touch **OK** → [YES] → **OK**.

💡 Tips

- When you select multiple movies, the movies are moved following the order appearing in the Playlist.
- You can also reorder movies by pressing the MENU button on the Playlist screen.

You can save a selected frame from a recorded movie as a still image.

1 Press the MODE button.



2 Touch [EDIT] → [PHOTO CAPTURE] → select the desired memory card and image quality.

3 Touch the movie to be captured.

The selected movie starts playback.

4 Touch  at the point where you want to capture.

The movie pauses. Play and pause toggles as you press .

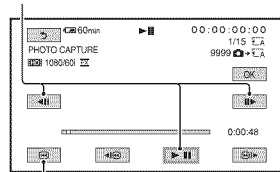

After you select the point with , make fine adjustment with  / .



Returns to the beginning of the selected movie

5 Touch **OK**.

The captured still image is saved on the memory card selected for movies. When capturing is finished, the screen returns to pause.

- To continue capturing, touch , then repeat steps from step 4.
- To capture a still image from another movie, touch , then repeat steps from step 3. If you change the memory card and the image

Capturing still images from a movie (Continued)

quality of the movies, start again from the beginning.

6 Touch .

Notes

- The image size is fixed depending on the image quality of the movie:
 - [2.1M] with high definition image quality (HD)
 - [0.2M] in 16:9 (wide) with standard definition image quality (SD)
 - [VGA(0.3M)] in 4:3 with standard definition image quality (SD)
- The memory card where you want to save still images should have enough free space.
- The recording date and time of captured still images is the same as the recording date and time of the movies.
- If the movie you are capturing from has no data code, the recording date and time of the still image will be the date and time you captured from the movie.

Dividing a movie

You can divide a movie at a designated point.

1 Press the MODE button.

2 Touch [EDIT] → [DIVIDE] → select the desired memory card and image quality.

3 Touch the movie to be divided. The selected movie starts playback.

4 Touch at the point where you want to divide.

The movie pauses. Play and pause toggles as you press .

After you select the point with , make fine adjustment with / .

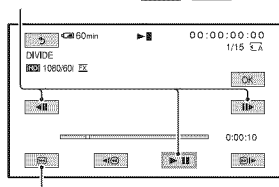

Returns to the beginning of the selected movie

5 Touch → [YES] → .

Notes

- You cannot restore movies once they are divided.
- Do not remove the battery pack, the AC Adaptor or the memory card that contains the movies from your camcorder during the operation. It may damage the memory card.

- A slight difference may occur from the point where you touch  and the actual dividing point, as your camcorder selects the dividing point based in about half-second increments.
- If you divide the original movie, the movie added to the Playlist will also be divided.

Tips

- You can also divide a movie by pressing the MENU button on the VISUAL INDEX screen or the playback screen of movies.

Deleting movies and still images

You can free media space by deleting movies and still images from the memory card.

Notes

- You cannot restore images once they are deleted.
- Do not remove the battery pack, the AC Adaptor or the memory card that contains the movies or still images from your camcorder during the operation. It may damage the memory card.
- You cannot delete protected movies and still images. Undo the protection of the movies and still images to delete them, before you try to delete them (p. 57).
- If the deleted movie is included in the Playlist (p. 58), the movie added to the Playlist is deleted also from the Playlist.
- Save important movies and still images in advance (p. 81).

Tips

- You can select up to 100 images at one time.
- To delete all data recorded on the memory card and recover all the recordable space of the memory card, format the memory card (p. 62).

1 Press the MODE button.

2 Touch [EDIT] → [DELETE].

3 To delete movies, touch [MOVIE DELETE] → select the desired memory card and image quality.

To delete still images, touch [PHOTO DELETE] → select the desired memory card.

4 Touch the movies or still images to be deleted.

✓ is displayed on the selected images.

Deleting movies and still images (Continued)

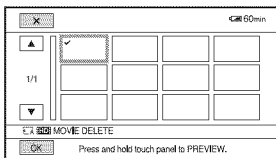

💡 Tips

- Press and hold the image down to preview the image. Touch to return to the previous screen.

5 Touch → [YES] → .

To delete all movies/still images at one time

In step **3**, touch [MOVIE DELETE ALL] → select the desired memory card and image quality → [YES] → [YES] → .

- To delete all still images at one time, touch [PHOTO DELETE ALL] → select the desired memory card → [YES] → [YES] → .

🔔 Notes

- Protected movies and still images are not deleted from the memory card.

💡 Tips

- You can also delete images by pressing the MENU button on the VISUAL INDEX screen or the playback screen of movies and still images.

Formatting the memory card

Formatting deletes all data from the memory card to recover recordable free space.

🔔 Notes

- Connect your camcorder to the wall outlet (wall socket) using the supplied AC Adaptor to prevent your camcorder from running out of power during the operation.
- To avoid the loss of important images, you should save them (p. 81) before formatting the memory card.
- Protected movies and still images are also deleted.

1 Press the MODE button.

2 Touch [MANAGE MEDIA] → [MEDIA FORMAT].

3 Touch the memory card to be formatted.

4 Touch [YES] → [YES] → .

🔔 Notes

- While [Executing...] is displayed, do not operate the buttons on the camcorder, or disconnect the AC Adaptor or remove the memory card from the camcorder. (The access lamp is lit or flashing while formatting the memory card.)

Preventing data on the memory card from being recovered

Unintelligible data will be written on the memory card. Thus, it may become more difficult to recover any original data. Even if you format the memory card, there may be some data remaining. Therefore, when you dispose of or transfer the memory card, it is recommended that you perform a [A MEDIA EMPTY]/[B MEDIA EMPTY] operation.

Notes

- If you perform this operation, all stored data are deleted. To avoid the loss of important images, they should be saved (p. 81) before the operation.
- You cannot perform this operation unless you connect the AC Adaptor to the wall outlet (wall socket).
- Disconnect all cables except the AC Adaptor. Do not disconnect the AC Adaptor during the operation.
- Do not apply any vibrations or shocks to your camcorder during this operation.

1 Operate the camcorder on an outside power source using the AC Adaptor (p. 19).

2 Set the POWER switch to ON.

3 Press the MODE button.

4 Touch [MANAGE MEDIA] → [MEDIA FORMAT].

5 Touch the memory card to be formatted.

The format screen appears.

6 Press and hold the STOP button for more than 3 seconds.

The media empty screen appears.

STOP button

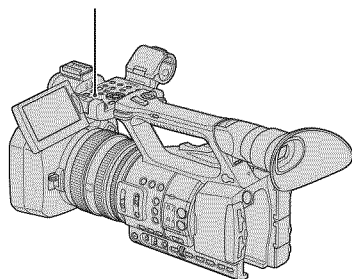

7 Touch [YES] → [YES] → [OK].

Notes

- It may take from several minutes to several hours to empty recording media, depending on the capacity. You can check the actual time required on the LCD screen.
- If you stop the operation while [Executing...] appears, be sure to complete the operation by performing [MEDIA FORMAT] or emptying when you use the memory card next time.

Repairing the image database file

This function checks the management information and the consistency of movies on the memory card, and repairs any inconsistencies found.

🔌 Notes

- Connect your camcorder to the wall outlet (wall socket) using the supplied AC Adaptor to prevent your camcorder from running out of power during the operation.

1 Press the **MODE** button.

2 Touch **[MANAGE MEDIA]** → **[REPAIR IMAGE DB FILE]**.

3 Touch the memory card you want to check the management file.

4 Touch **[YES]**.

The management file check starts.
Touch **[OK]** and quit the management file check if no inconsistency is found.

5 Touch **[YES]**.

After **[Completed.]** appears, touch **[OK]**.

🔌 Notes

- If you stop the operation while **[Repairing the Image Database File]** appears, be sure to complete the operation as described above when you use the memory card next time.

Operating the menu

You can change various settings or make detailed adjustments using the menu items displayed on the screen.

MENU button

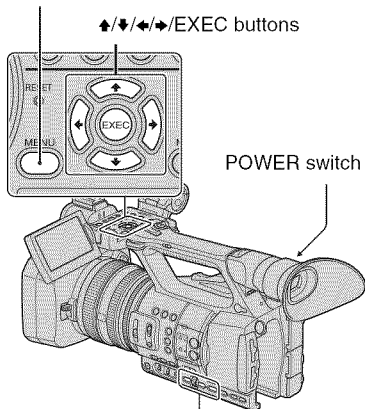

▲/▼/◀/▶/EXEC buttons

POWER switch

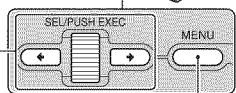

SEL/PUSH EXEC dial/

◀/▶ buttons

MENU button

⚡ Tips

- You may select menu items also with the ◀/▶ buttons.

1 Set the POWER switch to ON.

2 Press the MENU button.

The menu screen appears.

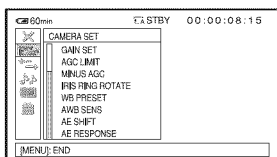

3 Turn the SEL/PUSH EXEC dial until the icon of the desired menu is highlighted, then press the dial to select the menu.

CAMERA SET (p. 69)

REC/OUT SET (p. 73)

AUDIO SET (p. 75)

DISPLAY SET (p. 77)

OTHERS (p. 80)

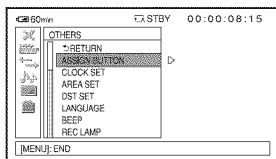

4 Turn the SEL/PUSH EXEC dial until the desired menu item is highlighted, then press the dial to select the item.

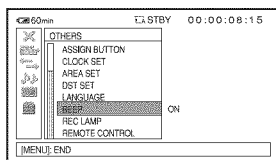

5 Turn the SEL/PUSH EXEC dial until the desired setting is highlighted, then press the dial to confirm the setting.

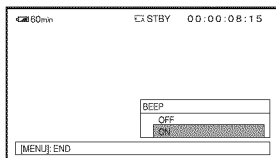

6 Press the MENU button to hide the menu screen.

To return to the previous screen, select [↩ RETURN].

🔍 Notes

- The available menu items vary depending on the context of your camcorder during recording or playback.

Menu items

●: Functions that return to the default settings when you switch the format, perform the functions by the MODE button, or turn off the camcorder.

ASSIGN: Functions that can be assigned to the ASSIGN buttons.



(CAMERA SET) menu

(p. 69)

GAIN SET	
AGC LIMIT	
MINUS AGC	
IRIS RING ROTATE	ASSIGN
WB PRESET	
AWB SENS	
AE SHIFT	ASSIGN
AE RESPONSE	
AUTO IRIS LIMIT	
FLICKER REDUCE	
BACK LIGHT	ASSIGN
SPOTLIGHT	ASSIGN
STEADYSHOT	ASSIGN
AF ASSIST	
HANDLE ZOOM	
D.EXTENDER	● ASSIGN
FADER	● ASSIGN
x.v.Color	
COLOR BAR	● ASSIGN



(REC/OUT SET) menu

(p. 73)

REC FORMAT	
HSD WIDE REC	
VIDEO OUT	



(AUDIO SET) menu (p. 75)

AUDIO LIMIT	
HEADPHONE OUT	
INT MIC SET	
XLR SET	



(DISPLAY SET) menu

(p. 77)

ZEBRA	ASSIGN
PEAKING	ASSIGN
MARKER	ASSIGN
EXPANDED FOCUS TYPE	
CAMERA DATA DISPLAY	
AUDIO LEVEL DISPLAY	
LCD BRIGHT	
LCD COLOR	
LCD BACKLIGHT LEVEL	
VF BACKLIGHT	
VF POWERMODE	
REMAINING	
DISPLAY OUTPUT	

Menu items (Continued)



(OTHERS) menu (p. 80)

ASSIGN BUTTON
CLOCK SET
AREA SET
DST SET/
SUMMERTIME
LANGUAGE
BEEP
REC LAMP ASSIGN
REMOTE CONTROL
CALIBRATION



(SMOOTH SLOW REC) menu (p. 41)

SLOW REC MODE
TIMING



(EDIT) menu (p. 57, 58, 60, 61)

PROTECT
ADD TO PLAYLIST
DIVIDE
DELETE
DELETE ALL



(PLAYLIST EDIT) menu (p. 58)

ADD
MOVE
ERASE
ERASE ALL

(CAMERA SET) menu

Settings to adjust your camcorder to the recording conditions (GAIN SET/BACK LIGHT/STEADYSHOT, etc.)

The default settings are marked with ►.
The indicators in parentheses appear when the items are selected.

See page 65 for details on selecting menu items.

Press the MENU button → select  (CAMERA SET) with the SEL/PUSH EXEC dial.

GAIN SET

You can set gain values for H, M and L positions of the GAIN switch. The default settings of [H], [M] and [L] are 18 dB, 9 dB and 0 dB, respectively.

- ① Select [H], [M] or [L] with the SEL/PUSH EXEC dial.
- ② Set the gain value with the SEL/PUSH EXEC dial, and press the dial.
You can select the value between -6 dB and 21 dB by 3 dB. The larger the value, the higher the gain.
- ③ Select [OK] with the SEL/PUSH EXEC dial.
- ④ Press the MENU button to hide the menu screen.

AGC LIMIT

You can select the upper limit for the Auto Gain Control (AGC) from [OFF] (21 dB, the default setting), [18dB], [15dB], [12dB], [9dB], [6dB], [3dB] and [0dB].

Notes

- If you adjust the gain manually, you cannot obtain the effect of [AGC LIMIT].

MINUS AGC

When you set this function to [ON], the automatic gain control range can be

expanded to the negative range. Especially in a bright environment, minus gain control allows more suitable gain setting and enables low noise recording. The dynamic range of the camcorder is not reduced when you set [MINUS AGC] to [ON].

► ON

Enables minus gain control (up to -3 dB) during automatic gain control, as required.

OFF

Disables minus gain control during automatic gain control.

IRIS RING ROTATE

You can select the operating direction of the iris ring.

► NORMAL

Makes images dark with clockwise rotation of the iris ring.

OPPOSITE

Makes images dark with counter-clockwise rotation of the iris ring.

💡 Tips

- You can assign this function to an ASSIGN button (p. 43).

WB PRESET

You can use the preset white balance. For more details, see page 33.

AWB SENS

You can set the auto white balance operation under a reddish light source such as an incandescent lamp or candle, or under a bluish light source such as in outdoor shade.

► INTELLIGENT

Automatically adjusts the white balance so that scenes look natural for the light source.

Press the MENU button → select  (CAMERA SET) with the SEL/PUSH EXEC dial.

HIGH

Automatically adjusts the white balance while reducing redness or blueness.

MIDDLE

LOW

Automatically adjusts the white balance while increasing redness or blueness.

🔌 Notes

- This is only effective when white balance is adjusted automatically.
- [AWB SENS] is not effective under a clear sky or the sun.

AE SHIFT

■ ON/OFF

You can turn on or off the function. When [ON] is selected,  and selected value appear on the screen.

■ LEVEL

You can set an offset value to adjust the automatic exposure adjustment value from [-7] (dark) - [0] (standard) - [+7] (bright) with the SEL/PUSH EXEC dial. The default setting is [0].

🔌 Notes

- This function is not effective while you adjust the iris, shutter speed and gain all manually.

💡 Tips

- You can assign an ASSIGN button to work as [ON/OFF] (p. 43).

AE RESPONSE

You can select the speed at which the exposure is adjusted automatically following the changes in the brightness of the subject. You can select the speed from [FAST], [MIDDLE] and [SLOW]. The default setting is [FAST].

AUTO IRIS LIMIT

You can select the highest iris value for the automatic adjustment from [F11], [F9.6], [F8], [F6.8], [F5.6], [F4.8] and [F4]. The default setting is [F11].

🔌 Notes

- This function is not effective during the manual iris adjustment.

FLICKER REDUCE

▶ ON

Reduces flickering. Flickering of the screen under a light source such as fluorescent lamps will be reduced.

OFF

Not reduce flickering.

🔌 Notes

- Flickering may not be reduced for certain light sources.

BACK LIGHT

When you set this function to [ON] () , you can correct backlighting. The default setting is [OFF].

🔌 Notes

- [BACK LIGHT] is set to [OFF] when you set [SPOTLIGHT] to [ON].
- [BACK LIGHT] is set to [OFF] if all of iris, gain, and shutter speed are adjusted manually.

💡 Tips

- You can assign this function to an ASSIGN button (p. 43).

SPOTLIGHT

When you set this function to [ON] () , you can prevent overexposure of light while recording a subject under strong light, such as a stage. For example, you can prevent people's faces from being over-exposed. The default setting is [OFF].

🔊 Notes

- [SPOTLIGHT] is set to [OFF] when you set [BACK LIGHT] to [ON].
- [SPOTLIGHT] is set to [OFF] if all of iris, gain, and shutter speed are adjusted manually.

💡 Tips

- You can assign this function to an ASSIGN button (p. 43).

STEADYSHOT

■ SET

▶ STEADYSHOT

You can activate the camera-shake reduction setting.

ACTIVE STEADYSHOT (👉ACT)

You can use the camera-shake reduction with more powerful effect.

OFF

Select [OFF] (👉OFF) when you use a tripod (sold separately) to make images look natural.

■ STEADYSHOT TYPE

You can select a type of camera-shake reduction for different recording situations.

HARD

Reduces camera shakes considerably.

This setting is not suitable for recording when you are using techniques like panning or tilting.

▶ STANDARD

Standard camera-shake reduction.

SOFT

Reduces camera shakes moderately. Slight unsteadiness remains in movies, which make the movies look as they are.

WIDE CONVERSION

This item is provided for a wide conversion lens (sold separately), and especially effective for Sony wide conversion lens.

■ ACTIVE STEADYSHOT TYPE

You can select a type of powerful camera-shake reduction for different recording situations.

▶ STANDARD

Reduces camera shakes more powerfully while you are walking or moving around.

WIDE CONVERSION

This item is provided for using a wide conversion lens (sold separately) in [ACTIVE STEADYSHOT] mode, and especially effective for Sony wide conversion lens.

🔊 Notes

- At the [ACTIVE STEADYSHOT] setting, the imaging field shifts slightly to the telephoto side, and the resolution will deteriorate slightly, as well.

💡 Tips

- You can assign an ASSIGN button to work as [SET] (p. 43).

AF ASSIST

When you set this function to [ON], you can temporarily focus manually using the focus ring during the auto focus adjustment. The default setting is [OFF].

🔊 Notes

- This function is effective only when the FOCUS switch is set to AUTO (p. 30).

HANDLE ZOOM

You can select the zoom speed for the FIX position of the handle zoom switch from [1] (slow) through [8] (fast). The default setting is [3].

Press the MENU button → select  (CAMERA SET) with the SEL/PUSH EXEC dial.

D. EXTENDER

When you set this function to [ON] (**DIG.EXT**), the displayed image becomes about 1.5 times larger. The image quality decreases because the image is digitally processed. This function helps you to focus on far-away subjects such as a wild bird away at a distance. The default setting is [OFF].

Notes

- The function returns to the default setting when you switch the format, perform the function by the MODE button, or turn off the camcorder.

Tips

- You can assign this function to an ASSIGN button (p. 43).

FADER

You can add visual effects to transition between scenes.

- ① Select [WHITE FADER] or [BLACK FADER] during standby to fade in with the selected effect, or recording to fade out with the selected effect.
- ② Press the record button.

The fader indicator stops flashing and disappears when the fading is complete.

To cancel before starting the operation, select [OFF] in step ①.

The setting will be cleared every time you press the record button.



WHITE FADER



BLACK FADER



Notes

- This function is automatically set to [OFF] (the default setting) when you switch the format, perform the function by the MODE button, or turn off the camcorder.
- You cannot set this function when the remaining space of the memory card is less than 1 minute.

Tips

- You can assign this function to an ASSIGN button (p. 43).

x.v.Color

When you set this function to [ON] (**COLOR**), you can record with the wider color range. Your camcorder can reproduce brilliant and vivid colors for flowers and the beautiful blue-green of tropical oceans. The default setting is [OFF].

Notes

- The colors may not be well reproduced when you play back a movie recorded with this function set to [ON] on a TV that does not support x.v.Color.
- You cannot set [x.v.Color] in the following cases:
 - When standard definition image quality (SD) is selected.
 - During recording movies
- When you set [x.v.Color] to [ON], the picture profile will be disabled.

COLOR BAR

ON/OFF

When you select [ON], you can display color bars on the screen or record them on the memory card. This function helps you to adjust colors when you view movies recorded with your camcorder on a TV or a monitor. The default setting is [OFF].

Notes

- This function is automatically set to [OFF] when you turn off the camcorder.
- You cannot change the setting during recording or expanded focus operation, or when fader is set.

■ TYPE

Selects a type of the color bars.

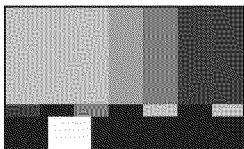

TYPE 1

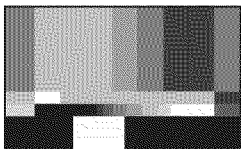

TYPE 2

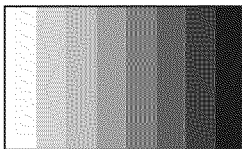

TYPE 3

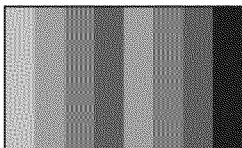

TYPE 4 (75% brightness of TYPE 3)

💡 Tips

- You can assign an ASSIGN button to work as [ON/OFF] (p. 43).

⇄ (REC/OUT SET) menu

Recording settings, input and output settings (REC FORMAT/VIDEO OUT, etc.)

The default settings are marked with ▶. The indicators in parentheses appear when the items are selected.

See page 65 for details on selecting menu items.

Press the MENU button → select ⇄ (REC/OUT SET) with the SEL/PUSH EXEC dial.

REC FORMAT

See page 27.

HSDI WIDE REC

You can record a movie in an aspect ratio that matches that of a TV that you want to connect. Refer also to the instruction manuals that come with the TV.

▶ ON

Records a movie in an aspect ratio that matches the full screen of a 16:9 (wide) TV.

OFF (4:3)

Records a movie in an aspect ratio that matches the full screen of a 4:3 TV.

🔍 Notes

- Set [TV TYPE] correctly to suite a TV that you want to connect for playback.
- The aspect ratio will be fixed to 16:9 and you cannot set it to 4:3 when you record movies with high definition image quality (HD).

Press the MENU button → select  (REC/OUT SET) with the SEL/PUSH EXEC dial.

VIDEO OUT

■ HDMI OUTPUT

You can select the resolution of the output signal from the HDMI OUT jack.

▶ AUTO

720p/480i

1080i/480i

480p

480i

■ COMPONENT OUTPUT

You can select the resolution of the output signal from the COMPONENT OUT jacks.

720p/480i

▶ 1080i/480i

480i

■ TV TYPE

You need to convert the signal depending on a type of your TV when playing back the movie. The recorded movies are played back as following illustrations.

▶ 16:9

Select to view your movies on a 16:9 (wide) TV.

16:9 format movies



4:3 format movies



4:3

Select to view your movies on a 4:3 standard TV.

16:9 format movies



4:3 format movies



ⓘ Notes

- When you play back the standard definition image quality (SD) movies recorded with [SD] WIDE REC set to [ON], images may appear normal in vertical direction, but compressed in horizontal direction, depending on the TV.

(AUDIO SET) menu

Settings for the audio recording (AUDIO LIMIT/XLR SET, etc.)

The default settings are marked with ►. The indicators in parentheses appear when the items are selected.

See page 65 for details on selecting menu items.

Press the MENU button → select  (AUDIO SET) with the SEL/PUSH EXEC dial.

AUDIO LIMIT

You can set the clipping-noise reduction function for CH1/CH2.

► OFF

Disables the function.

ON

Enables the function.

Notes

- This function is available only when you set the AUTO/MAN (CH1/CH2) switch to MAN.

HEADPHONE OUT

You can set the sound to output to the headphone when the HEADPHONE MONITOR switch is set to STEREO MIX.

► STEREO

Outputs in stereo.

MONO

Outputs in monaural.

INT MIC SET

■ INT MIC SENS

You can set recording sensitivity of the internal microphone.

► NORMAL

Sensitivity that is normally used in professional recordings.

HIGH

Sensitivity that is normally used in consumer recordings.

SENS-HI appears on the status check screen.

■ INT MIC WIND

OFF

Disables wind noise reduction.

► ON

Enables wind noise reduction.

 appears on the status check screen.

XLR SET

■ XLR AGC LINK

You can select either linked or separate AGC (Auto Gain Control) of CH1 and CH2 when using an external microphone (sold separately).

► SEPARATE

Separately applies the AGC for CH1/CH2. Sound inputs from CH1/CH2 will be recorded as separate sound.

LINKED ()

Applies the AGC of CH1 linked with that of CH2. Sound inputs from CH1/CH2 will be recorded as a set of sound such as stereo sound. **A**  appears on the status check screen.

Notes

- This function is available when the CH1 and CH2 switches are set to AUTO and the INPUT1 and INPUT2 switches are both set to MIC or both set to LINE (p. 39).

■ AUDIO MANUAL GAIN

You can select either linked or separate audio level control of CH1 and CH2 when using an external microphone (sold separately).

► SEPARATE

Separately controls the audio levels of CH1 and CH2. Sound inputs from CH1 and CH2 will be recorded as separate sound.

Press the MENU button → select  (AUDIO SET) with the SEL/PUSH EXEC dial.

LINKED ()

Controls the audio level of CH1 linked with that of CH2. Sound inputs from CH1 and CH2 will be recorded as a set of sound such as stereo sound.  appears on the status check screen.

Notes

- This function is available when the CH1 and CH2 switches are set to MAN and the INPUT1 and INPUT2 switches are both set to MIC or both set to LINE (p. 39).
- When you select [LINKED], you can adjust the volume with the AUDIO LEVEL dial of CH1 (p. 39).

INPUT1 TRIM

You can adjust the input signal level from INPUT1.

You can select from [-18dB], [-12dB], [-6dB], [0dB], [+6dB] and [+12dB]. The default setting is [0dB].

Notes

- The setting is not effective when you set the INPUT1 switch to LINE.

INPUT1 WIND

OFF

Disables wind noise reduction.

ON

Enables wind noise reduction.

 appears on the status check screen.

Notes

- The setting is not effective when you set the INPUT1 switch to LINE.

INPUT2 TRIM

INPUT2 WIND

You can set INPUT2 in the same way as INPUT1.

Tips

- -48 dBu is set as 0 dB in your camcorder.
- Set INPUT TRIM to [0dB] for a microphone (sold separately).
- The INPUT TRIM function adjusts the input level from an external microphone. When using

a highly sensitive microphone or recording loud sound, set this to the minus side. When using a less sensitive microphone or recording quiet sound, set it to the plus side.

- When recording loud sound, the sound may be distorted at either the input point or the recording point. If it is distorted at the input point, adjust the sound using the INPUT TRIM function. If it is distorted at the recording point, lower the total volume level manually.
- If you set INPUT TRIM too far to the minus side, the microphone volume becomes too low, resulting in a poor signal to noise ratio.
- Test the effect of the [AUDIO SET] function according to the microphone used or the sound field of the recording site before actual recording.

(DISPLAY SET) menu

Display settings of the display and the viewfinder (MARKER/VF BACKLIGHT/DISPLAY OUTPUT, etc.)

The default settings are marked with ►. The indicators in parentheses appear when the items are selected.

See page 65 for details on selecting menu items.

Press the MENU button → select  (DISPLAY SET) with the SEL/PUSH EXEC dial.

ZEBRA

You can display a zebra pattern as a guide for adjusting brightness.

■ ON/OFF

When you select [ON],  and the brightness level appear on the screen. The zebra pattern will not be recorded with the image. The default setting is [OFF].

■ LEVEL

You can select the brightness level between 70 and 100 or 100+. The default setting is [70].

Tips

- The zebra pattern is a strip pattern displayed over a part of an image on the screen when the part is higher than the preset brightness level.
- You can assign an ASSIGN button to work as [ON/OFF] (p. 43).

PEAKING

■ ON/OFF

When you select [ON], **PEAKING** appears and you can display an image on the screen with its outlines enhanced. This function helps you to adjust the focus. The default setting is [OFF].

■ COLOR

You can select peaking color from [WHITE], [RED] and [YELLOW]. The default setting is [WHITE].

■ LEVEL

You can select a peaking sensitivity from [HIGH], [MIDDLE] and [LOW]. The default setting is [MIDDLE].

Notes

- The enhanced outlines will not be recorded on the memory card.

Tips

- You can focus more easily using this function in combination with the expanded focus function (p. 31).
- You can assign an ASSIGN button to work as [ON/OFF] (p. 43).

MARKER

■ ON/OFF

When you select [ON], you can display markers. The default setting is [OFF]. Markers will not be recorded on the memory card.

■ CENTER

When you select [ON], you can display a marker at the center of the screen. The default setting is [ON].



■ GUIDEFAME

When you select [ON], you can display frame markers that help you to check horizontal and vertical positions of a subject. The default setting is [OFF].



Notes

- Only the time code is output to an external device via external output jacks when [MARKER] is set to [ON], even if [DISPLAY OUTPUT] is set to [ALL OUTPUT].

Press the MENU button → select  (DISPLAY SET) with the SEL/PUSH EXEC dial.

- You cannot display markers under following conditions:
 - [EXPANDED FOCUS]
 - During [SMOOTH SLOW REC]
 - When the current time is displayed after the power is turned on
- You can display markers only on the LCD panel and viewfinder. You cannot display them on an external device.

Tips

- You can display all types of markers at the same time.
- You can obtain a balanced composition by positioning the subject at the cross points of the guideframe marker.
- You can assign an ASSIGN button to work as [ON/OFF] (p. 43).

EXPANDED FOCUS TYPE

You can set a type of the expanded focus display.

▶ TYPE 1

Simply enlarges images.

TYPE 2

Enlarges and shows images in black and white.

CAMERA DATA DISPLAY

When you set this function to [ON], you can constantly display the iris, gain and shutter speed settings on the screen. The default setting is [OFF].

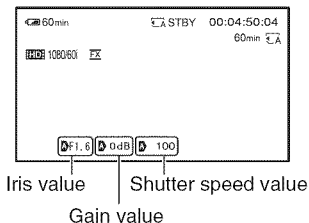

Tips

- The settings appear on the screen during the manual adjustment regardless of the settings of this function.
-  indicates that the settings are automatically adjusted values.
- The displayed settings are different from the settings that will be displayed when you press the DATA CODE button (p. 49).

AUDIO LEVEL DISPLAY

When you set this function to [ON], you can display the audio level meter on the screen. The default setting is [ON].

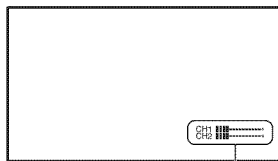

Audio level meter

LCD BRIGHT

You can adjust the brightness of the LCD screen. Changes in the LCD brightness will not affect the brightness of recording images.

Tips

- You can also turn off the LCD backlight (p. 20).

LCD COLOR

You can adjust the color level of the LCD panel. Changes in the LCD color level will not affect the color level of recording images.

LCD BACKLIGHT LEVEL

You can adjust the backlight level of the LCD screen.

► NORMAL

Standard brightness.

BRIGHT

Brightens the LCD screen.

Notes

- When you connect your camcorder to outside power sources, [BRIGHT] is automatically selected for the setting.
- When you select [BRIGHT], the recordable time with the battery is slightly reduced.

VF BACKLIGHT

You can adjust the brightness of the viewfinder.

► NORMAL

Standard brightness.

BRIGHT

Brightens the viewfinder screen.

Notes

- When you connect your camcorder to outside power sources, [BRIGHT] is automatically selected for the setting.
- When you select [BRIGHT], the recordable time with the battery is slightly reduced.

VF POWERMODE

► AUTO

Turns on the viewfinder while you close the LCD panel or record in mirror mode.

ON

Always turns on the viewfinder.

REMAINING

AUTO

Displays the remaining recording time available for movies when you re-enter movie recording mode or switch to [SMOOTH SLOW REC]. When the remaining time is 5 minutes or more, the display goes off after 8 seconds.

► ON

Always displays the remaining recording time available for movies.

DISPLAY OUTPUT

You can select where to output the display information, such as time code.

► LCD PANEL

Outputs the information to the LCD screen and viewfinder.

ALL OUTPUT

Outputs the information to the LCD screen, viewfinder, HDMI output, component output and video output.

Notes

- Only the time code is output when [MARKER] is set to [ON] and a marker is displayed on the screen.



(OTHERS) menu

Settings while recording or other basic settings (AREA SET/BEEP, etc.)

The default settings are marked with ►. The indicators in parentheses appear when the items are selected.

See page 65 for details on selecting menu items.

Press the MENU button → select  (OTHERS) with the SEL/PUSH EXEC dial.

ASSIGN BUTTON

See page 43.

CLOCK SET

See page 22.

AREA SET

You can adjust a time difference without stopping the clock. When you use your camcorder abroad, you can adjust the clock to the local time.

DST SET/SUMMERTIME

You can change this setting without stopping the clock. Set to [ON] to move the time forward 1 hour.

► OFF

Does not set the summertime.

ON

Sets the summertime.

LANGUAGE

You can select the language to be used on the LCD screen.

Tips

- Your camcorder offers [ENG[SIMP]] (simplified English) in case that you cannot find your native tongue among the options.

BEEP

OFF

Cancels the melody.

► ON

Activates a melody when you start/stop recording, or when you are warned with warning indicators, etc.

REC LAMP (Recording lamp)

When you set this function to [OFF], you can turn off the camera recording lamp. The default setting is [ON].

Tips

- You can assign this function to an ASSIGN button (p. 43).

REMOTE CONTROL

When you set this function to [ON], you can use the supplied Wireless Remote Commander (p. 113). The default setting is [ON].

Tips

- Set to [OFF] to prevent your camcorder from responding to a command sent by another remote control unit.

CALIBRATION

See page 103.

Saving images with a computer

Preparing a computer (Windows)

You can perform following operations using “Content Management Utility.”

- Importing images to a computer
- Viewing imported images

To save movies using a computer, install the software from the supplied CD-ROM “Content Management Utility” beforehand. Use commercially available software to edit images or create discs.

Step 1 Checking the computer system

OS*1

Microsoft Windows XP SP3*2/Windows Vista SP2*3/Windows 7

CPU

Use an Intel Core 2 Duo 2.20 GHz CPU or faster to play back videos with high definition image quality (HD) in the FX mode.

Videos with high definition image quality (HD) recorded in other than the FX mode may be played back with a slower CPU. Depending on the performance of your video card, videos with high definition image quality (HD) recorded using the FX mode may be played back with a slower CPU than that recommended above.

For the following operations, an Intel Pentium III 1GHz or faster is necessary.

- Importing movies to the computer
- Processing with standard definition image quality (SD)

Memory

For Windows XP: 512 MB or more (1 GB or more is recommended.) However, 256 MB or more is sufficient for processing only the movies with standard definition image quality (SD).

For Windows Vista/Windows 7: 1 GB or more

Hard disk

Disk volume required for installation: Approximately 100 MB
Only the NTFS or exFAT file system can be used for importing videos or registering them for viewing.

Display

Minimum 1,024 × 768 dots

Others

USB port (this must be provided as standard, High-Speed USB (USB 2.0 compatible)) (CD-ROM drive is necessary for installation)

*1 Standard installation is required. Operation is not assured if the OS has been upgraded or in a multi-boot environment.

*2 64-bit editions and Starter (Edition) are not supported.

*3 Starter (Edition) is not supported.

Notes

- Operation with all computer environments is not assured.
- The supplied software “Content Management Utility” is not supported by Macintosh computers.

Step 2 Installing the supplied software “Content Management Utility”

Install “Content Management Utility” before connecting your camcorder to a computer.

- ① Confirm that your camcorder is not connected to the computer.
- ② Turn on the computer.
 - Log on as an Administrator for installation.
 - Close all applications running on the computer before installing the software.
- ③ Place the supplied CD-ROM “Content Management Utility” in the disc drive of your computer.
The installation screen appears.

Saving images with a computer (Continued)

- If the screen does not appear, click [Start] → [Computer] (in Windows XP, [My Computer]), then double-click [SONYCMU(E:)] (CD-ROM).

- ④ Select the language for the application to be installed, then click [OK].
- ⑤ When the install wizard screen appears, click [Next].
- ⑥ Confirm the license agreement, and if you accept the terms, click [Next].
- ⑦ Select the drive or folder to install the application, then click [Next].
- ⑧ Select the option to create the desk-top shortcut, then click [Next].
- ⑨ Turn on your camcorder, then connect the camcorder to the computer using the supplied USB cable.

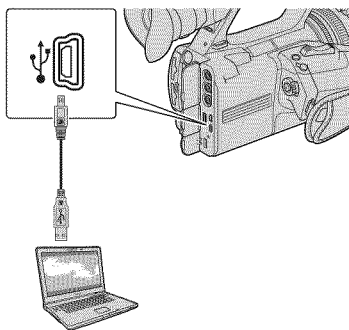

The [USB SELECT] screen appears on the camcorder screen automatically.

- ⑩ Touch [\leftarrow A] or [\leftarrow B] on the camcorder screen.
 - If the [USB SELECT] screen does not appear, press the MODE button, then touch [MANAGE MEDIA] → [USB CONNECT].
- ⑪ Click [Next].
- ⑫ Follow the on-screen instructions to install the software.
 - Restart the computer if required to complete the installation.

When the installation is completed, the following icon will appear, depending on the selection in step ⑧.



- ⑬ Remove the CD-ROM from the computer.

To disconnect your camcorder from the computer

- ① Click the  icon at the bottom right of the desktop of the computer → [Safely remove USB Mass Storage Device-Drive].

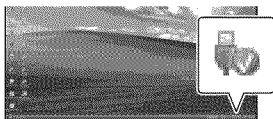

- ② Touch [END] → [YES] on the camcorder screen.
- ③ Disconnect the USB cable.

Troubleshooting

If you run into any problems using your camcorder, follow the flow chart below.

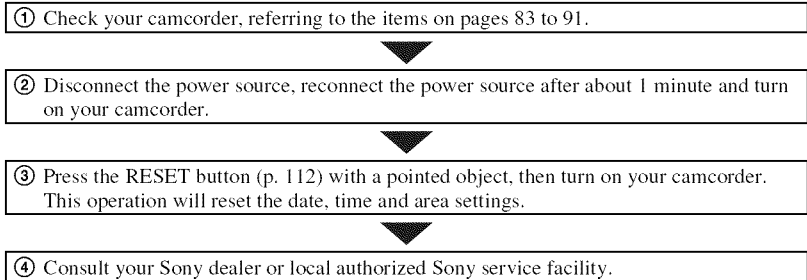

- Power sources/LCD screen/Wireless Remote Commander...p. 83
- Memory card...p. 85
- Recording...p. 86
- Playback...p. 89
- Connecting to TV...p. 90
- Dubbing/Editing/Connecting to other devices...p. 91
- Connecting to a computer...p. 91

Power sources/LCD screen/Wireless Remote Commander

The power does not turn on or abruptly turns off.

- Attach a charged battery pack to the camcorder (p. 17).
- Use the AC Adaptor to connect to a wall outlet (wall socket) (p. 17).

The camcorder does not operate even when the power is set to on.

- Disconnect the AC Adaptor from the wall outlet (wall socket) or remove the battery pack, then reconnect it after about 1 minute.
- Press the RESET button (p. 112) using a sharp-pointed object.

The camcorder gets warm.

- The camcorder may get warmer while you use it. This is not a malfunction.

The CHG lamp does not light up during charging the battery pack.

- Set the POWER switch of the camcorder to OFF (CHG) (p. 17).
- Attach the battery pack correctly (p. 17).
- Connect the power plug to the wall outlet (wall socket) correctly.
- The charging of the battery pack is completed (p. 17).

The CHG lamp blinks during charging the battery pack.

- Attach the battery pack correctly (p. 17). If the CHG lamp still continues blinking, the battery pack may be damaged. Disconnect the power plug and consult your Sony dealer.
 - If the temperature of the battery pack is too high or too low, the battery pack may not be charged and the CHG lamp may blink slowly.
-

The remaining battery time indicator does not indicate the correct time.

- Ambient temperature is too high or too low, or the battery pack has not been charged enough. This is not a malfunction.
 - Fully charge the battery again. If the problem persists, the battery may be worn-out. Replace it with a new one (p. 17, 100).
 - The indicated time may not be correct in certain circumstances. For example, when you open or close the LCD panel, it takes about 1 minute to display the correct remaining battery time.
-

The battery pack discharges too quickly.

- Ambient temperature is too high or low, or the battery pack has not been charged enough. This is not a malfunction.
 - Fully charge the battery again. If the problem persists, the battery may be worn-out. Replace it with a new one (p. 17, 100).
-

The image remains on the LCD screen.

- This occurs if you disconnect the DC plug or remove the battery pack without turning off the power first. This is not a malfunction.
-

The image in the viewfinder is not clear.

- Move the viewfinder lens adjustment lever until the image appears clearly (p. 21).
-

The image in the viewfinder has disappeared.

- If you set [VF POWERMODE] to [AUTO], the finder light remains off while the LCD panel is open (p. 79).
-

The supplied Wireless Remote Commander does not function.

- Set [REMOTE CONTROL] to [ON] (p. 80).
- Remove any obstructions between the Wireless Remote Commander and the remote sensor of the camcorder.
- Keep strong light sources, such as sunlight or overhead lighting, away from the remote sensor, otherwise the Wireless Remote Commander may not function properly.
- Insert a fresh battery in the compartment with its +/- terminals matching those of the compartment (p. 113).

Another video device malfunctions when you use the supplied Wireless Remote Commander.

- Select a commander mode other than DVD2 for your video device.
- Cover the sensor of your video device with black paper.

When a device is connected to the REMOTE jack, the camcorder or the device does not operate properly.

- The connected device may react slowly to some operations, such as zooming.

Memory card

The remaining movie recording indicator is not displayed.

- Set [ REMAINING] to [ON] to always display the remaining movie recording indicator (p. 79).

The camcorder does not operate with the memory card inserted.

- The memory card was formatted on a computer. Format them on this camcorder (p. 62).

The data file name is incorrect, or flashing.

- The file is damaged.
- Use a file format supported by your camcorder (p. 98).

The recording media indicator is flashing.

- Something wrong happened to the memory card. Repair the image database file (p. 64).

Images on the memory card cannot be deleted.

- You can select no more than 100 images to be deleted on the edit screen.
- The images are protected. Release the protect function (p. 57).

Recording

The recording does not start when you press the record button.

- The playback screen is displayed. Finish playback operation (p. 45).
- There is no empty space on the memory card. Replace the memory card with new one, delete unnecessary images (p. 61) or format the memory card (p. 62).
- Total number of movie scenes exceeds the recordable capacity of your camcorder (p. 96). Delete unnecessary images (p. 61).
- The temperature of your camcorder is extremely high. Turn off your camcorder and leave it for a while in a cool place.
- The temperature of your camcorder is extremely low. Turn off your camcorder and leave it for a while in a warm place.
- Something wrong happened to the memory card. Repair the image database file (p. 64).

The handle zoom does not work.

- Set the handle zoom switch to FIX or VAR (p. 29).

The access lamp remains lit even after recording was stopped.

- Your camcorder is recording the scene you have just shot on the memory card.

The imaging field looks different.

- The imaging field may look different depending on the condition of your camcorder. This is not a malfunction.

The actual recording time for movies is less than the expected recording time of the memory card.

- Depending on the recording conditions, the time available for recording may be shorter, for example when recording a fast moving object, etc. (p. 95).

The camcorder does not keep the setting changes.

- Some menu items return to the default setting when the power is turned off (p. 67).
- The LCD backlight setting and the EXPANDED FOCUS setting are not stored.
- You disconnected the power sources when the POWER switch was set to ON. Before disconnecting the battery or the AC Adaptor, set the POWER switch to OFF and make sure that the access lamp is turned off.

There is a time difference between the point when the record button is pressed and the point that the recording movie is started or stopped actually.

- On your camcorder, there may be a slight time difference between the point where you press the record button and the actual point that recording movie starts/stops. This is not a malfunction.

The aspect ratio (16:9 (wide)/4:3) cannot be changed.

- The aspect ratio of high definition image quality (HD) movies is 16:9 (wide).

Automatic focus does not function.

- Set the FOCUS switch to AUTO to enable the automatic focus function (p. 30).
- Adjust the focus manually if the automatic focus does not work properly (p. 30).

[This function is currently not available.] appears when selecting a function on the MODE menu.

- Try again after finishing all tasks currently selected on the MODE menu.

Menu items are grayed out or do not work.

- You cannot select grayed out display items in the current recording/playback situation.
- There are some functions you cannot activate simultaneously. The following list shows examples of unworkable combinations of functions and menu items.

Cannot use	Situation
[BACK LIGHT], [SPOTLIGHT], [ON/ OFF] of [AE SHIFT]	All of iris, gain, and shutter speed are set manually.
[FADER]	The camcorder is unable to record images. The memory card has less than 1 minute of remaining capacity. [COLOR BAR] is set to [ON].
[ZEBRA], [PEAKING], [CAMERA DATA DISPLAY]	[COLOR BAR] is set to [ON].
[ON/OFF] of [MARKER]	[EXPANDED FOCUS] is set to [ON]. While the date and time are displayed when the power is turned on.
[LCD BACKLIGHT LEVEL], [VF BACKLIGHT]	AC power source is being used.
[AREA SET], [DST SET]/[SUMMERTIME]	Date and time are not set.
[COLOR BAR]	Movies are being recorded. [FADER] is selected. [EXPANDED FOCUS] is set to [ON].

Iris, gain, shutter speed, or white balance cannot be adjusted manually.

- Set the AUTO/MANUAL switch to MANUAL.

Tiny spots in white, red, blue, or green appear on the screen.

- This phenomenon appears when using a slow shutter speed (p. 32). This is not a malfunction.

The subjects passing by the frame very fast appear crooked.

- This is called the focal plane phenomenon. This is not a malfunction. Because of the way that the image device (CMOS sensor) reads out image signals, the subjects passing by the frame rapidly might appear crooked depending on the recording conditions.
-

The LCD screen is too bright, and the subject cannot be seen.

- Set [BACK LIGHT] to [OFF].
-

The LCD screen is too dark, and the subject cannot be seen.

- Press and hold the DISPLAY button for a few seconds to turn on the backlight (p. 20).
-

Horizontal stripes appear on the image.

- This occurs when recording pictures under a fluorescent lamp, sodium lamp, or mercury lamp. This is not a malfunction. This can be improved by changing the shutter speed (p. 32).
-

The image appears divided horizontally.

- This occurs when you light the subject using a flash. This can be avoided by using a shutter speed as slow as possible (p. 32).
-

Black bands appear when you record a TV screen or computer screen.

- This can be improved by adjusting the shutter speed (p. 32).
-

Fine patterns flicker, diagonal lines look jagged.

- Adjust [DETAIL] to the negative side (p. 38).
-

The time code is not recorded in sequence.

- The time code may not be recorded sequentially if you change the settings with [REC FORMAT].

Playback

Refer also to the “Memory card” section (p. 85).

The desired images cannot be found. Images cannot be played back.

- Select the memory card and image quality of the image you want to play back on the VISUAL INDEX screen (p. 45).
- Image data cannot be played back if you have modified file names or folders, or have edited the data on a computer (When viewing still images, the file name flashes). This is not a malfunction (p. 100).
- Images recorded on other devices may not be played back, or displayed in incorrect size. This is not a malfunction.

The data file name is displayed incorrectly, or flashing.

- The file is damaged.
- The file format is not supported on your camcorder (p. 98).
- Only the file name is displayed, if the folder structure does not conform to the universal standard.

No sound or only a low sound is heard.

- Turn up the volume (p. 47).
- Movies recorded using [SMOOTH SLOW REC] do not have sounds.

“---” is displayed on the screen.

- The memory card you are playing was recorded without setting the date and time.
- Bars will be displayed for the camera data of the movies recorded with [SMOOTH SLOW REC] or [COLOR BAR] set to [ON].
- Bars will be displayed for the exposure correction value and flash information of the still images created with [PHOTO CAPTURE].

Multi ch appears on the LCD screen.

- This appears when you play back movies recorded with 5.1ch surround sound. 5.1ch surround sound is down-mixed to 2ch stereo and played back on your camcorder.

Connecting to TV

Neither image nor sound is played back on the TV connected with the component video cable.

- Set [VIDEO OUT] according to the requirements of the connected device (p. 74).
- When you are using the component video cable, make sure that you connect the red and white plugs of the A/V connecting cable (p. 51).

Neither image nor sound is played back on the TV connected with the HDMI cable.

- Pictures are not output from the HDMI OUT jack, if copyright protection signals are recorded in the pictures.
- Signals are not output from the HDMI OUT jack when the USB jack is connected.

Neither image nor sound is played back on the TV, projector, or AV amplifier connected with the HDMI cable.

- If you cannot view images or hear sound on the TV, projector, or AV amplifier connected with the HDMI cable, try disconnecting and connecting the HDMI cable, or turn on your camcorder again.

The image appears distorted on the 4:3 TV.

- This happens when viewing a movie recorded in 16:9 (wide) mode on a 4:3 TV. Select [REC/OUT SET] → [VIDEO OUT] → [TV TYPE] → the appropriate down conversion type (p. 74).

Black zone appears at top and bottom of a 4:3 TV screen.

- This happens when viewing a movie recorded in the 16:9 (wide) mode on a 4:3 TV. This is not a malfunction.

Dubbing/Editing/Connecting to other devices

Time code and other information appear on the display of the connected device.

- Set [DISPLAY OUTPUT] to [LCD PANEL] while connected with the A/V connecting cable (p. 79).

Dubbing cannot be done correctly using the A/V connecting cable.

- The A/V connecting cable is not connected properly. Make sure that the A/V connecting cable is connected to the input jack of the other device for dubbing images from your camcorder.

Sound cannot be added to the memory card after recording.

- You cannot add sound to the memory card after recording on your camcorder.

Dubbing cannot be done correctly using the HDMI cable.

- You cannot dub movies using the HDMI cable.

Connecting to a computer

The computer does not recognize the camcorder.

- Disconnect the cable from the computer, then connect it again securely.
- Disconnect the cable from the computer, restart the computer, then connect the computer to your camcorder correctly.

Movies cannot be viewed or copied to a computer.

- Disconnect the cable from the computer, then connect it again.
- You need to install the supplied “Content Management Utility” to copy movies from your camcorder to your computer (p. 81).

The computer freezes.

- Disconnect the cable from your computer and camcorder. Reboot your computer, and connect your computer and camcorder following the steps in the correct order (p. 81).

Warning indicators and messages

Self-diagnosis display/Warning indicators

When an error occurs, a warning indicator appears on the LCD screen or in the viewfinder.

You can fix some problems associated with the symptoms yourself. If the problem persists even after you have tried a couple of times, contact your Sony dealer or local authorized Sony service facility.

C:04:□□

- The battery pack is not an “InfoLITHIUM” battery pack. Use an “InfoLITHIUM” battery pack (p. 100).
- Connect the DC plug of the AC Adaptor to the DC IN jack of the camcorder firmly (p. 19).

C:06:□□

- The battery pack is too hot. Replace the battery pack, or remove it and put it in a cool place.

C:13:□□

- Remove the “Memory Stick PRO Duo” media. After installing them again, operate your camcorder.

C:32:□□

- Remove the power source. Reconnect it and operate your camcorder again.

E:20:□□ / E:61:□□ / E:62:□□ / E:92:□□ / E:94:□□

- Try the steps ② to ④ on page 83.

(Battery level warning)

- The battery pack is nearly used up.
- Depending on the operating environment, or battery conditions,  may flash, even if there are approximately 5 to 10 minutes remaining.

(Warning indicator pertaining to battery pack temperature)

- The battery pack is too hot. Replace the battery pack, or remove it and put it in a cool place.

(Warning indicator pertaining to memory cards)

Slow flashing

- Free spaces for recording images are running out. For the type of memory cards you can use with your camcorder, see page 9.
- No memory card is inserted (p. 23).

Fast flashing



- There are not enough free spaces for recording images. Delete unnecessary images (p. 61), or format the memory card (p. 62) after storing the images on other media (p. 81).
- The image database file may be damaged (p. 64).

(Warning indicators pertaining to memory card formatting)

- The memory card is damaged.
- The memory card is not formatted correctly (p. 62).

(Warning indicator pertaining to incompatible memory card)

- Incompatible memory card is inserted (p. 9).

   (Warning indicator pertaining to the write-protect of the memory card)

- Access to the memory card was restricted on another device.

* When [BEEP] is set to [ON] (p. 80), you hear a melody when the warning indicators appear on the screen.

Warning messages

If messages appear on the screen, follow the instructions.

Memory card

Data error.

- An error occurred during reading or writing the memory card. If the message appears after you repeat a few times, the memory card could be damaged. Try with another memory card.

Buffer overflow

- You have performed recording and erasing operations repeatedly, or a memory card that has been formatted by other device is used. Copy and take data backup to other device (such as a computer), and then format the memory card on the camcorder (p. 62).
- The size of the inserted memory card is not sufficient for copying the movie(s). Use the recommended memory card (p. 9).

There is no Image Database File. Movies cannot be recorded or played. Create a new file?

- There is no image database file. Touch [YES] to create a new image database file.

HD movie management information is damaged. Create new information?

- The management information of high definition image quality (HD) movies is damaged. Touch [YES] to create new management information. The previously recorded images on the memory card cannot be played back on your camcorder (Image files are not damaged). If you execute [REPAIR IMAGE DB FILE] after creating new management information, playing back the previously recorded images may become possible. If it does not work, copy the image file to your computer using the supplied software.

There is no HD movie management information. Create new information?

- As there is no management information of high definition image quality (HD) movies, the camcorder does not record or play back movies. Touch [YES] to create management information. You will be able to record or play back high definition image quality (HD) movies.
- It is possible to record standard definition image quality (SD) movies.

Inconsistencies found in Image Database File. Cannot record or play HD movies. Do you want to repair the Image Database File?

The Image Database File is damaged. Movies cannot be recorded or played. Do you want to repair the Image Database File?

Inconsistencies found in Image Database File. Movies cannot be recorded or played. Do you want to repair the Image Database File?

- As the image database file is damaged, or has inconsistencies, the camcorder does not record movies. Touch [YES] to repair the image database file.

Recovering data.

- Your camcorder tries to recover data automatically if the data writing was not performed properly.

Cannot recover data.

- Writing data onto the media of the camcorder has failed. Attempts were made to recover the data, but they were unsuccessful.

Reinsert memory card A.

Reinsert memory card B.

- Reinsert the memory card a few times. If even then the message appears, the memory card could be damaged. Try with another memory card.

A format error has occurred in memory card A.

A format error has occurred in memory card B.

- Check the format, then format the memory card with your camcorder if necessary (p. 62).

Memory card A may not record or play movies normally.

Memory card B may not record or play movies normally.

- Use the memory card recommended for your camcorder (p. 9).

Memory card A may not record or play normally.

Memory card B may not record or play normally.

- Use the memory card recommended for your camcorder (p. 9).

Memory card A has been pulled out during writing. Data could be corrupted.

Memory card B has been pulled out during writing. Data could be corrupted.

- Reinsert the memory card, and follow the instructions on the LCD screen.

Others

No further selection is possible.

- You can select only 100 images at one time for:
 - Deleting movies/still images
 - Protecting movies/still images, or releasing the protection
 - Editing the Playlist

Data protected.

- You tried to delete protected data. Release the protection of the data.
-

Recording time of movies

Estimated time of recording and playback with each battery pack

“HD” stands for high definition image quality, and “SD” stands for standard image quality.

Recording time

Approximate time available when you use a fully charged battery pack.

(unit: minute)

Battery pack	Continuous recording time		Typical recording time	
	HD	SD	HD	SD
NP-F570	130	150	80	85
	130	150	80	85
NP-F770	285	320	170	185
	285	320	170	185
NP-F970	425	480	245	285
	425	480	245	285

Notes

- Top: When the LCD backlight is on
Bottom: When recording with the viewfinder
- Recording format
HD image quality: FX
SD image quality: HQ
- Typical recording time shows the time when you repeat recording start/stop, zooming, and so on.
- Times measured when using the camcorder at 25 °C (77 °F) (10 °C to 30 °C (50 °F to 86 °F) is recommended).
- The recording and playback time will be shorter when you use your camcorder in low temperatures.
- The recording and playback time will be shorter depending on the conditions under which you use your camcorder.

Playing time

Approximate time available when you use a fully charged battery pack.

(unit: minute)

Battery pack	LCD panel opened*	
	HD	SD
NP-F570	225	270
NP-F770	460	550
NP-F970	690	830

* When the LCD backlight turns on

Estimated recording time of movies

High definition image quality (HD)

(unit: minute)

	AVCHD 24 M (FX)	AVCHD 17 M (FH)	AVCHD 9 M (HQ)	AVCHD 5 M (LP)
	1 GB	5 (5)	6 (6)	10 (9)
2 GB	10 (10)	10 (10)	25 (15)	40 (35)
4 GB	20 (20)	25 (25)	50 (40)	90 (75)
8 GB	45 (45)	55 (55)	105 (80)	185 (155)
16 GB	90 (90)	115 (115)	215 (165)	375 (315)
32 GB	180 (180)	235 (235)	435 (335)	750 (630)

Recording time of movies (Continued)

■ Standard definition image quality (SD)

(unit: minute)

SD 9 M (HQ)	
1 GB	10 (10)
2 GB	25 (25)
4 GB	55 (50)
8 GB	115 (105)
16 GB	235 (210)
32 GB	475 (425)

🔊 Notes

- The recordable time may vary depending on the recording and subject conditions. [REC FORMAT] (p. 27).
- The number in () is the minimum recordable time.

💡 Tips

- You can record movies of a maximum of 3,999 scenes with high definition image quality (HD), and 9,999 scenes with standard definition image quality (SD).
- The maximum continuous recording time of movies is approximately 13 hours.
- Your camcorder uses the VBR (Variable Bit Rate) format to automatically adjust image quality to suit the recording scene. This technology causes fluctuations in the recording time of the media. Movies containing quickly moving and complex images are recorded at a higher bit-rate, and this reduces the overall recording time.
- Bit-rate (movie + audio, etc.), number of pixels, and aspect ratio of each recording mode of movies are as follows.
 - High definition image quality (HD)
 - FX: max. 24 Mbps 1920 × 1080/16:9
 - FH: approx. 17 Mbps (ave.) 1920 × 1080/16:9
 - HQ: approx. 9 Mbps (ave.) 1440 × 1080/16:9
 - LP: approx. 5 Mbps (ave.) 1440 × 1080/16:9
 - Standard definition image quality (SD)
 - HQ: approx. 9 Mbps (ave.) 720 × 480/16:9, 4:3
- Number of pixels and aspect ratio of still images (Still images are created from movies.)
 - 1920 × 1080 dots/16:9
 - 640 × 360 dots/16:9
 - 640 × 480 dots/4:3

Using your camcorder abroad

Power supply

You can use your camcorder in any country/region using the AC Adaptor supplied with your camcorder within the AC 100 V to 240 V, 50 Hz/60 Hz range.

Viewing high definition image quality (HD) movies

In countries/regions where 1080/60i is supported, you can view the movies with the same high definition image quality (HD) as that of the recorded movies. You need an NTSC-system-based and 1080/60i compatible TV (or monitor) with component and AUDIO/VIDEO input jacks. The component video cable (supplied) or an HDMI cable (sold separately) must be connected.

Viewing standard definition image quality (SD) movies

To view standard definition image quality (SD) movies, you need an NTSC-system-based TV with AUDIO/VIDEO input jacks. An A/V connecting cable must be connected.

On TV color systems

Your camcorder is NTSC system, so its picture can only be viewed on an NTSC-system TV with AUDIO/VIDEO input jacks.

System	Used in
NTSC	Bahama Islands, Bolivia, Canada, Central America, Chile, Colombia, Ecuador, Guyana, Jamaica, Japan, Korea, Mexico, Peru, Surinam, Taiwan, the Philippines, the U.S.A., Venezuela, etc.

System	Used in
PAL	Australia, Austria, Belgium, China, Czech Republic, Denmark, Finland, Germany, Holland, Hong Kong, Hungary, Italy, Kuwait, Malaysia, New Zealand, Norway, Poland, Portugal, Singapore, Slovak Republic, Spain, Sweden, Switzerland, Thailand, United Kingdom, etc.
PAL - M	Brazil
PAL - N	Argentina, Paraguay, Uruguay.
SECAM	Bulgaria, France, Guiana, Iran, Iraq, Monaco, Russia, Ukraine, etc.

Simple setting of the clock by time difference

When you are abroad, you can easily adjust the clock to the local time by setting the time difference. Select [AREA SET], then set the time difference (p. 80).

File/folder structure on the memory card

The file/folder structure is shown below. You do not usually need to acknowledge the file/folder structure, when recording/playing back movies and still images on the camcorder.

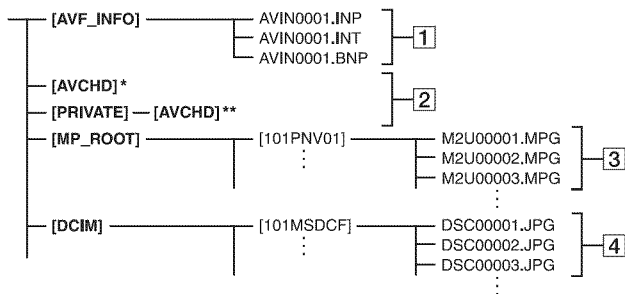

* “Memory Stick PRO Duo” media

**SD memory card, SDHC memory card, SDXC memory card

1 Image management files

When you delete the files, you cannot record/play back the images correctly. The files are defaulted as hidden files and not usually displayed.

2 HD movie management information folder

This folder contains recording data of high definition image quality (HD) movies. Do not try to open this folder or access the contents of this folder from a computer. Doing so might damage image files, or prevent image files from being played back.

3 SD movie files (MPEG-2 files)

The extension of the files is “.MPG”. The maximum size is 2 GB. When the capacity of a file exceeds 2 GB, the file becomes divided.

The file numbers go up automatically. When the capacity of a file number exceeds 9999, another folder is created to record new movie files. The folder name goes up: [101PNV01] → [102PNV01]

4 Still image files (JPEG files)

The extension of the files is “.JPG”. The file numbers go up automatically. When the capacity of a file number exceeds

9999, another folder is created to store new still image files.

The folder name goes up: [101MSDCF] → [102MSDCF]

- By pressing the MODE button, then selecting [MANAGE MEDIA] → [USB CONNECT] → [A] / [B], you can access the memory card from the computer through USB connection.
- Do not modify the files or folders on the camcorder from the computer. The image files may be destroyed or may not be played back.
- Operation is not guaranteed, if you perform the above operation.
- When you delete image files, follow the steps on page 61. Do not delete the image files on the camcorder directly from the computer.
- Do not format the memory card using a computer. The camcorder may not operate correctly.
- Do not copy the files on the memory card from the computer. Operation is not guaranteed.
- Use the supplied application software “Content Management Utility” to input data from the memory card to a computer.

Maintenance and precautions

About the AVCHD format

What is the AVCHD format?

The AVCHD format is a high definition digital video camera format used to record a high definition (HD) signal, using efficient data compression coding technology. The MPEG-4 AVC/H.264 format is adopted to compress video data, and the Dolby Digital or Linear PCM system is used to compress audio data.

The MPEG-4 AVC/H.264 format is capable of compressing images at higher efficiency than that of the conventional image compressing format.

- Because the AVCHD format uses a data compression system, images may be distorted in scenes where the image, angle, or brightness changes drastically. This is not a malfunction.

Recording and playback on your camcorder

Based on the AVCHD format, your camcorder records with the high definition image quality (HD). In addition to high definition image quality (HD), your camcorder is capable of recording a standard definition (SD) signal in the conventional MPEG-2 format.

Video signal*: MPEG-4 AVC/H.264

1920 × 1080/60i, 1440 × 1080/60i

Audio signal: Dolby Digital 2ch

Recording media: memory card

* Data recorded in AVCHD format other than the above mentioned cannot be played back on your camcorder.

- 1080i specification
A high definition specification which utilizes 1,080 effective scanning lines and the interlace system.

About the memory card

- A memory card formatted by a computer (Windows OS/Mac OS) does not have guaranteed compatibility with your camcorder.
 - Data read/write speed may vary depending on the combination of the memory card and memory card compliant product you use.
 - Damaged or lost image data will not be compensated for, and may occur in the following cases:
 - If you eject the memory card, turn the power off on your camcorder, or remove the battery pack for replacement while your camcorder is reading or writing image files on the memory card (while the access lamp is lit or flashing).
 - If you use the memory card near magnets or magnetic fields.
 - It is recommended to make a back-up of important data on the hard disk of a computer.
 - Be careful not to apply excessive force when writing on a memo area on memory card.
 - Do not attach a label or the like on memory card or a memory card adaptor.
 - Do not touch, or allow metallic objects to come into contact with the terminals.
 - Do not bend, drop or apply strong force to the memory card.
 - Do not disassemble or modify the memory card.
 - Do not let the memory card get wet.
 - Be careful to keep memory card out of the reach of small children. There is danger that a child might swallow it.
 - Do not insert anything other than the compliant size of memory card into the memory card slot. Doing so may cause a malfunction.
 - Do not use or keep the memory card in the following locations:
 - Places subject to extremely high temperature, such as a car parked outside in the summer.
 - Places under direct sunlight.
 - Places with extremely high humidity or subject to corrosive gases.
- **On the memory card adaptor**
- When inserting memory card into a memory card adaptor, make sure the memory card is inserted facing in the correct direction, then insert it all the way in. Note that improper use may cause a malfunction.

Maintenance and precautions (Continued)

On image data compatibility

- Image data files recorded on a memory card by your camcorder conform to the “Design rule for Camera File system” universal standard established by the JEITA (Japan Electronics and Information Technology Industries Association).
- On your camcorder, you cannot play back still images recorded on other devices (DCR-TRV900 or DSC-D700/D770) that do not conform to the universal standard. (These models are not sold in some regions.)
- If you cannot use memory card that has been used with another device, format it with your camcorder (p. 62). Note that formatting erases all information on the memory card.
- You may not be able to play back images with your camcorder:
 - When playing back image data modified on your computer.
 - When playing back image data recorded with other devices.

About the “Memory Stick” media

Types of “Memory Stick” media	Recording /Playback
“Memory Stick Duo” media (with MagicGate)	–
“Memory Stick PRO Duo” (Mark2) media	○
“Memory Stick PRO-HG Duo” media	○*

- * This product does not support 8-bit parallel data transfer but it supports 4-bit parallel data transfer the same as with “Memory Stick PRO Duo” media.
- This product cannot record or play data that uses “MagicGate” technology. “MagicGate” is a copyright protection technology that records and transfers the contents in an encrypted format.

About the “InfoLITHIUM” battery pack

This unit is compatible with an “InfoLITHIUM” battery pack (L series). Your camcorder operates only with an “InfoLITHIUM” battery pack. “InfoLITHIUM” L series battery packs have the  mark.

What is an “InfoLITHIUM” battery pack?

An “InfoLITHIUM” battery pack is a lithium-ion battery pack that has functions for communicating information related to operating conditions between your camcorder and a supplied AC Adaptor. The “InfoLITHIUM” battery pack calculates the power consumption according to the operating conditions of your camcorder, and displays the remaining battery time in minutes.

With an AC Adaptor, the remaining battery time and charging time appear.

To charge the battery pack

- Be sure to charge the battery pack before you start using your camcorder.
- We recommend charging the battery pack in an ambient temperature of between 10 °C to 30 °C (50 °F to 86 °F) until the charge lamp of the AC Adaptor turns off. If you charge the battery pack outside of this temperature range, you may not be able to charge it efficiently.

To use the battery pack effectively

- Battery pack performance decreases when the ambient temperature is 10 °C (50 °F) or below, and the length of time you can use the battery pack becomes shorter. In that case, do one of the following to use the battery pack for a longer time.
 - Put the battery pack in a pocket to warm it up, and insert it in your camcorder right before you start taking shots.
 - Use a large capacity battery pack: NP-F770/ F970 (sold separately).

- Frequent use of the LCD screen or a frequent playback, fast forward or rewind operation wears out the battery pack faster.
We recommend using a large capacity battery pack: NP-F770/F970 (sold separately).
- Be sure to set the POWER switch to OFF when not recording or playing back on your camcorder. The battery pack is also consumed when your camcorder is in recording standby or playback pause.
- Have spare battery packs ready for two or three times the expected recording time, and make trial recordings before making the actual recording.
- Do not expose the battery pack to water. The battery pack is not water resistant.

About the remaining battery time indicator

- When the power goes off even though the remaining battery time indicator indicates that the battery pack has enough power to operate, charge the battery pack fully again. Remaining battery time will be indicated correctly. Note, however, that the battery indication will not be restored if it is used in high temperatures for a long time, or if left in a fully charged state, or when the battery pack is frequently used. Use the remaining battery time indication as a rough guide only.
- The  mark that indicates low battery flashes even if there are still 5 to 10 minutes of battery time remaining, depending on the operating conditions or ambient temperature.

About storage of the battery pack

- If the battery pack is not used for a long time, fully charge the battery pack and use it up on your camcorder once a year to maintain proper function. To store the battery pack, remove it from your camcorder and put it in a dry, cool place.
- To discharge the battery pack on your camcorder completely, leave your camcorder in recording standby until the power goes off (p. 19).

About battery life

- Battery capacity decreases over time and through repeated use. If decreased usage time between charges becomes significant, it is probably time to replace it with a new one.
- Each battery's life is governed by storage, operating and environmental conditions.

About x.v.Color

- x.v.Color is a more familiar term for the xvYCC standard proposed by Sony, and is a trademark of Sony.
- xvYCC is an international standard for color space in video. This standard can express a wider color range than the currently used broadcast standard.

About handling of your camcorder

On use and care

- Do not use or store the camcorder and accessories in the following locations.
 - Anywhere extremely hot or cold. Never leave them exposed to temperatures above 60 °C (140 °F), such as under direct sunlight, near heaters or in a car parked in the sun. They may malfunction or become deformed.
 - Near strong magnetic fields or mechanical vibration. The camcorder may malfunction.
 - Near strong radio waves or radiation. The camcorder may not be able to record properly.
 - Near AM receivers and video equipment. Noise may occur.
 - On a sandy beach or anywhere dusty. If sand or dust gets in your camcorder, it may malfunction. Sometimes this malfunction cannot be repaired.
 - Near windows or outdoors, where the LCD screen, the viewfinder, or the lens may be exposed to direct sunlight. This damages the inside of the viewfinder or the LCD screen.
 - Anywhere very humid.
- Operate your camcorder on DC 7.2 V (battery pack) or DC 8.4 V (AC Adaptor).
- For DC or AC operation, use the accessories recommended in these operating instructions.

Maintenance and precautions (Continued)

- Do not let your camcorder get wet, for example, from rain or sea water. If your camcorder gets wet, it may malfunction. Sometimes this malfunction cannot be repaired.
- If any solid object or liquid gets inside the casing, unplug your camcorder and have it checked by a Sony dealer before operating it any further.
- Avoid rough handling, disassembling, modifying, physical shock, or impact such as hammering, dropping or stepping on the product. Be particularly careful of the lens.
- Do not use a deformed or damaged battery pack.
- Keep the POWER switch setting to OFF when you are not using your camcorder.
- Do not wrap your camcorder with a towel, for example, and operate it. Doing so might cause heat to build up inside.
- When disconnecting the power cord (mains lead), pull it by the plug and not the lead.
- Do not damage the power cord (mains lead) such as by placing anything heavy on it.
- Keep metal contacts clean.
- Keep the Wireless Remote Commander and button-type battery out of children's reach. If the battery is accidentally swallowed, consult a doctor immediately.
- If the battery electrolytic liquid has leaked,
 - consult your local authorized Sony service facility.
 - wash off any liquid that may have contacted your skin.
 - if any liquid gets in your eyes, wash with plenty of water and consult a doctor.

■ When not using your camcorder for a long time

- Turn on the camcorder and record and play back images about once a month to keep it in an optimum state for a long time.
- Use up the battery pack completely before storing it.

Moisture condensation

If your camcorder is brought directly from a cold place to a warm place, moisture may condense inside your camcorder and cause a malfunction of your camcorder.

■ If moisture condensation has occurred

Leave your camcorder for about 1 hour without turning it on.

■ Note on moisture condensation

Moisture may condense when you bring your camcorder from a cold place into a warm place (or vice versa) or when you use your camcorder in a humid place as shown below.

- When you bring your camcorder from a ski slope into a place warmed up by a heating device.
- When you bring your camcorder from an air conditioned car or room into a hot place outside.
- When you use your camcorder after a squall or a shower.
- When you use your camcorder in a hot and humid place.

■ How to avoid moisture condensation

When you bring your camcorder from a cold place into a warm place, put your camcorder in a plastic bag and seal it tightly. Remove the bag when the air temperature inside the plastic bag has reached the ambient temperature (after about 1 hour).

LCD screen

- Do not exert excessive pressure on the LCD screen, as it may cause damage.
- If your camcorder is used in a cold place, a residual image may appear on the LCD screen. This is not a malfunction.
- While using your camcorder, the back of the LCD screen may heat up. This is not a malfunction.

■ To clean the LCD screen

If fingerprints or dust make the LCD screen dirty, it is recommended you use a soft cloth to clean it.

On adjustment of the touch panel (CALIBRATION)

The buttons on the touch panel may not work correctly. If this happens, follow the procedure below. It is recommended that you connect your camcorder to the wall outlet (wall socket) using the supplied AC Adaptor during the operation.

- 1 Turn on the camcorder.
- 2 Press the MENU button → select  (OTHERS) → [CALIBRATION] with the SEL/PUSH EXEC dial.

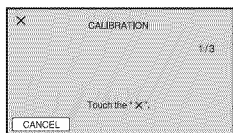

- 3 Touch "x" displayed on the screen with the corner of memory card or the like 3 times.
 - If you did not press the right spot, try the calibration again.
 - Touch [CANCEL] to cancel calibration.

Notes

- Do not use a sharp-pointed object for calibration. Doing so may damage the LCD screen.

On handling the casing

- If the casing is soiled, clean the camcorder body with a soft cloth lightly moistened with water, and then wipe the casing with a dry soft cloth.
- Avoid the following to avoid damage to the finish.
 - Using chemicals such as thinner, benzene, alcohol, chemical cloths, repellent, insecticide and sunscreen.
 - Handling with above substances on your hands.
 - Leaving the casing in contact with rubber or vinyl objects for a long period of time.

About care and storage of the lens

- Wipe the surface of the lens clean with a soft cloth in the following instances:
 - When there are fingerprints on the lens surface.
 - In hot or humid locations
 - When the lens is exposed to salty air such as at the seaside.
- Store in a well-ventilated location subject to little dirt or dust.
- To prevent mold, periodically clean the lens as described above.

On charging the pre-installed rechargeable battery

Your camcorder has a pre-installed rechargeable battery to retain the date, time, and other settings even when the POWER switch is set to OFF. The pre-installed rechargeable battery is always charged while your camcorder is connected to the wall outlet (wall socket) via the AC Adaptor or while the battery pack is attached. The rechargeable battery will be fully discharged in about **3 months** if you do not use your camcorder at all without the AC Adaptor connected or the battery pack attached. Use your camcorder after charging the pre-installed rechargeable battery.

However, even if the pre-installed rechargeable battery is not charged, the camcorder operation will not be affected as long as you are not recording the date.

Procedures

Connect your camcorder to a wall outlet (wall socket) using the supplied AC Adaptor, and leave it with the POWER switch set to OFF for more than 24 hours.

Removing dust from inside the viewfinder

1 Remove the eye piece of the viewfinder.

Slide down the viewfinder release lever and hold it at the position (①), then lift the eye piece of the viewfinder as indicated with the arrow in the illustration (②).

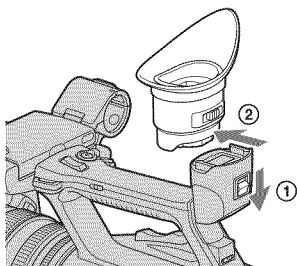

2 Remove dust inside the eye piece and viewfinder with a blower.

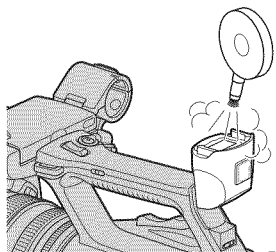

Specifications

System

Video signal

NTSC color, EIA standards
HDTV 1080/60i

Video recording system

HD image quality: MPEG-4 AVC/
H.264 AVCHD
SD image quality: MPEG-2 PS

Audio recording system

Dolby Digital 2ch (48 kHz 16-bit)
Dolby Digital Stereo Creator employed

Still image recording system

DCF Ver. 2.0
Exif Ver. 2.21
MPF Baseline

Recording media (movies/still images)

“Memory Stick PRO Duo” media
SD card (Class 4 or faster)

Viewfinder

Electric viewfinder (color)
Picture: 1.1 cm (0.45 type, aspect ratio
16:9)
Total dot number:
1 226 880 (approx. 852×3 [RGB] \times
480)

Image device

6.0 mm (1/3 type) 3CMOS sensor
Gross: Approx. 1 120 000 pixels
Effective (movie, 16:9):
Approx. 1 040 000 pixels*
Effective (movie, 4:3):
Approx. 780 000 pixels*

Lens

G Lens
20 \times (Optical), Approx. 30 \times (Digital,
when [D.EXTENDER] is set to [ON])
Focal length
f=4.1 - 82.0 mm (3/16 - 3 1/4 in.)
When converted to a 35 mm still
camera*
29.5 - 590 mm (1 3/16 - 23 1/4 in.)
(16:9),

36.1 - 722 mm (1 7/16 - 28 1/2 in.)
(4:3)

F1.6 - 3.4

Filter diameter: 72 mm (2 7/8 in.)

Color temperature

[AUTO]

 (one push) A/B

[INDOOR] (3 200K)

[OUTDOOR] (5 800K)

Minimum illumination

1.5 lx (lux) (Fixed Shutter Speed 1/30,
auto gain, auto iris) (F 1.6)

* When [SET] of [STEADYSHOT] is set to
[STEADYSHOT] or [OFF]

Output connectors

VIDEO OUT jack

Pin connector

1 Vp-p, 75 Ω (ohms) unbalanced, sync
negative

AUDIO OUT jacks

Pin connectors

-10 dBu (at load impedance 47 k Ω
(kilohms)), Output impedance with less
than 2.2 k Ω (kilohms)
(0 dBu = 0.775 Vrms)

COMPONENT OUT jack

Mini-D jack

Y: 1 Vp-p, 75 Ω (ohms)

PB/PR, CB/CR: 0.7 Vp-p, 75 Ω (ohms)

HDMI OUT jack

HDMI connector

(headphones) jack

Stereo-minijack (\varnothing 3.5 mm)

Input connectors

INPUT1/INPUT2 jacks

XLR 3-pin, female,

MIC: -48 dBu: 3 k Ω (kilohms)

(Variable in the range of between

-60 dBu and -30 dBu in 6 dBu step by
the INPUT TRIM function)

LINE: +4 dBu: 10 k Ω (kilohms)

Specifications (Continued)

(0 dBu = 0.775 Vrms)

Input/Output connectors

USB jack

mini-B

Remote jack

Stereo mini-minijack (Ø 2.5 mm)

LCD screen

Picture

8.0 cm (3.2 type, aspect ratio 16:9)

Total dot number

921 600 (1 920 × 480)

General

Power requirements

DC 7.2 V (battery pack)

DC 8.4 V (AC Adaptor)

Average power consumption

During camera recording using the viewfinder with normal brightness:

HD recording 6.7 W

SD recording 5.9 W

During camera recording using the LCD with normal brightness:

HD recording 6.7 W

SD recording 5.9 W

Operating temperature

0 °C to 40 °C (32 °F to 104 °F)

Storage temperature

-20 °C to +60 °C (-4 °F to +140 °F)

Dimensions (approx.)

173 × 193 × 393 mm

(6 7/8 × 7 5/8 × 15 1/2 in.) (w/h/d)

including the projecting parts

Mass (approx.)

2.1 kg (4 lb 11 oz) including the lens hood with lens cover

2.3 kg (4 lb 15 oz) including the battery pack (NP-F570), lens hood with lens cover

AC Adaptor AC-L100C

Power requirements

AC 100 V - 240 V, 50 Hz/60 Hz

Current consumption

0.35 A - 0.18 A

Power consumption

18 W

Output voltage

DC 8.4 V*

Operating temperature

0 °C to 40 °C (32 °F to 104 °F)

Storage temperature

-20 °C to +60 °C (-4 °F to +140 °F)

Dimensions (approx.)

48 × 29 × 81 mm

(1 15/16 × 1 3/16 × 3 1/4 in.) (w/h/d)

excluding the projecting parts

Mass (approx.)

170 g (6.0 oz) excluding the power cord (mains lead)

* See the label on the AC Adaptor for other specifications.

Rechargeable battery pack NP-F570

Maximum output voltage

DC 8.4 V

Output voltage

DC 7.2 V

Maximum charge voltage

DC 8.4 V

Maximum charge current

3.0 A

Capacity

Typical: 15.8 Wh (2 200 mAh)

Minimum: 15.0 Wh (2 100 mAh)



Type

Li-ion

Design and specifications are subject to change without notice.

• Manufactured under license from Dolby Laboratories.

On trademarks

- “Handycam” and **HANDYCAM** are registered trademarks of Sony Corporation.
- “AVCHD” and “AVCHD” logotype are trademarks of Panasonic Corporation and Sony Corporation.
- “Memory Stick,”  “Memory Stick Duo,” **MEMORY STICK DUO** “Memory Stick PRO Duo,” **MEMORY STICK PRO DUO** “Memory Stick PRO-HG Duo,” **MEMORY STICK PRO-HG DUO** “MagicGate,” **MAGICGATE** “MagicGate Memory Stick” and “MagicGate Memory Stick Duo” are trademarks of Sony Corporation.
- “InfoLITHIUM” is a trademark of Sony Corporation.
-  is a trademark of Sony Corporation.
- “x.v.Color” is a trademark of Sony Corporation.
- Dolby and the double-D symbol are trademarks of Dolby Laboratories.
- Microsoft, Windows, and Windows Vista are trademarks or registered trademarks of U.S. Microsoft Corporation in the U.S. and other countries.
- Macintosh and Mac OS are registered trademarks of Apple Inc. in the U.S. and other countries.
- HDMI, HDMI logo, and High-Definition Multimedia Interface are trademarks or registered trademarks of HDMI Licensing LLC.
- Intel, Intel Core, and Pentium are trademarks or registered trademarks of Intel Corporation or its subsidiaries in the United States and other countries.
- Adobe, the Adobe logo, and Adobe Acrobat are either registered trademarks or trademarks of Adobe Systems Incorporated in the United States and/or other countries.
- SDXC and SDHC logos are trademarks of SD-3C, LLC.
- MultiMedia Card is a trademark of MultiMediaCard Association.

All other product names mentioned herein may be the trademarks or registered trademarks of their respective companies. Furthermore, TM and [®] are not mentioned in each case in this manual.

Notes on the License

ANY USE OF THIS PRODUCT OTHER THAN CONSUMER PERSONAL USE IN ANY MANNER THAT COMPLIES WITH THE MPEG-2 STANDARD FOR ENCODING VIDEO INFORMATION FOR PACKAGED MEDIA IS EXPRESSLY PROHIBITED WITHOUT A LICENSE UNDER APPLICABLE PATENTS IN THE MPEG-2 PATENT PORTFOLIO, WHICH LICENSE IS AVAILABLE FROM MPEG LA, L.L.C., 250 STEELE STREET, SUITE 300, DENVER, COLORADO 80206.

THIS PRODUCT IS LICENSED UNDER THE AVC PATENT PORTFOLIO LICENSE FOR THE PERSONAL AND NON-COMMERCIAL USE OF A CONSUMER TO

(i) ENCODE VIDEO IN COMPLIANCE WITH THE AVC STANDARD (“AVC VIDEO”) AND /OR

(ii) DECODE AVC VIDEO THAT WAS ENCODED BY A CONSUMER ENGAGED IN A PERSONAL AND NON-COMMERCIAL ACTIVITY AND/OR WAS OBTAINED FROM A VIDEO PROVIDER LICENSED TO PROVIDE AVC VIDEO.

NO LICENSE IS GRANTED OR SHALL BE IMPLIED FOR ANY OTHER USE.

ADDITIONAL INFORMATION MAY BE OBTAINED FROM MPEG LA, L.L.C. SEE <[HTTP://WWW.MPEGLA.COM](http://www.mpegla.com)>

“C Library,” “Expat,” “zlib,” “libjpeg,” “dtoa” and “pcre” software are provided in your camcorder. We provide this software based on license agreements with their owners of copyright. Based on requests

by the owners of copyright of these software applications, we have an obligation to inform you of the following. Please read the following sections.

Read “license1.pdf” in the “License” folder on the CD-ROM “Content Management Utility.” You will find licenses (in English) of “C Library,” “Expat,” “zlib,” “libjpeg,” “dtoa” and “pcre” software.

Specifications (Continued)

On GNU GPL/LGPL applied software

The software that is eligible for the following GNU General Public License (hereinafter referred to as "GPL") or GNU Lesser General Public License (hereinafter referred to as "LGPL") are included in the camcorder.

This informs you that you have a right to have access to, modify, and redistribute source code for these software programs under the conditions of the supplied GPL/LGPL.

Source code is provided on the web. Use the following URL to download it. When downloading the source code, select HDR-AX2000 as the model for your camcorder.

<http://www.sony.net/Products/Linux/>

We would prefer you do not contact us about the contents of source code.

Read "license2.pdf" in the "License" folder on the CD-ROM "Content Management Utility." You will find licenses (in English) of "GPL," and "LGPL" software.

To view the PDF, Adobe Reader is needed. If it is not installed on your computer, you can download it from the Adobe Systems web page:

<http://www.adobe.com/>

Identifying parts and controls

The numbers in () are reference pages.

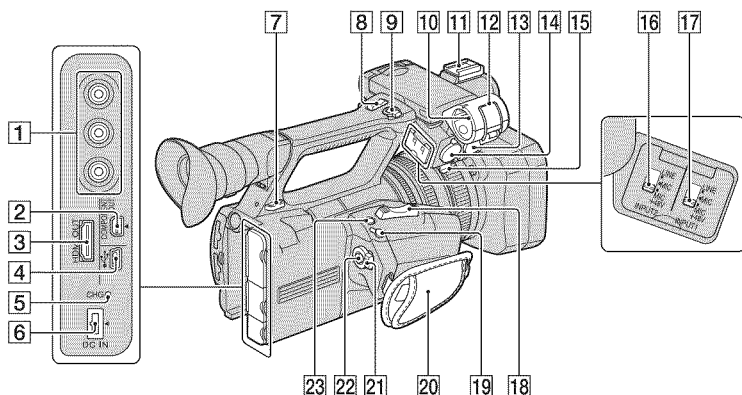

- 1** VIDEO OUT jack/AUDIO OUT jacks (51)
- 2** COMPONENT OUT jack (51)
- 3** HDMI OUT jack (51)
- 4** USB jack (81)
- 5** CHG (charge) lamp (17)
- 6** DC IN jack (17)
- 7** Hook for shoulder strap (111)
- 8** Handle zoom lever (29)
- 9** Handle record button (25)
- 10** Microphone holder
- 11** Accessory shoe
- 12** Microphone fixing clamper
- 13** INPUT1 jack (39)
- 14** INPUT2 jack (39)
- 15** Cable holder
Provided for securing a microphone cable, etc.
- 16** INPUT2 switch (39)
- 17** INPUT1 switch (39)
- 18** Zoom lever (29)
- 19** REMOTE jack
The REMOTE jack is used for controlling playback, etc. on the video device and peripherals connected to it.
- 20** Grip belt (19)
- 21** POWER switch (19)
- 22** Record button (25)
- 23** ASSIGN 7/EXPANDED FOCUS button (43)

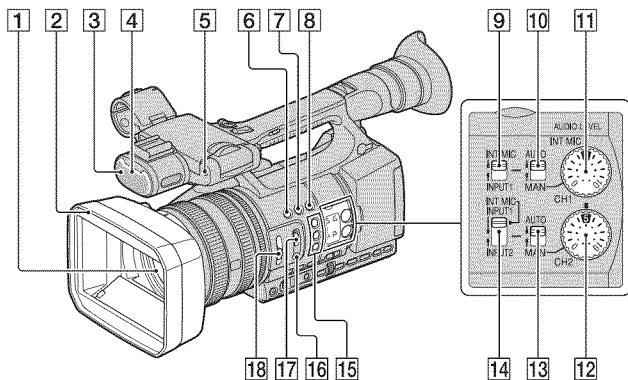

Identifying parts and controls (Continued)

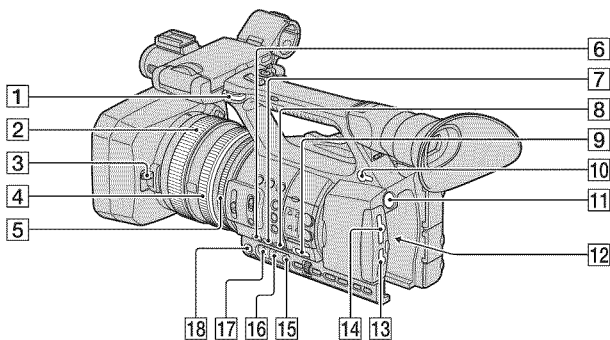

- 1** Lens (16)
- 2** Lens hood with lens cover (16)
- 3** Internal microphone (39)
- 4** Front recording lamp (80)
The recording lamp flashes if the remaining capacity of the memory card or battery is low.
- 5** Remote sensor (80)
- 6** ASSIGN 4/ZEBRA button (43)
- 7** ASSIGN 5/AE SHIFT button* (43)
- 8** ASSIGN 6/VISUAL INDEX button (43)
- 9** CH1 (INT MIC/INPUT1) switch (39)
- 10** AUTO/MAN (CH1) switch (40)
- 11** AUDIO LEVEL(CH1) dial (40)
- 12** AUDIO LEVEL(CH2) dial (40)
- 13** AUTO/MAN (CH2) switch (40)
- 14** CH2 (INT MIC/INPUT1/INPUT2) switch (39)
- 15** ASSIGN 1/2*/3 buttons (43)
- 16** PUSH AUTO button (30)
- 17** FOCUS switch (30)
- 18** ND filter (33)

* The ASSIGN 5/AE SHIFT button and the ASSIGN 2 button have raised tactile dots for your convenience in locating the button.



- 1** Hook for shoulder strap
- 2** Focus ring (30)
- 3** Lens cover lever (16)
- 4** Zoom ring (29)
- 5** Iris ring (31)
- 6** GAIN button (32)
- 7** WHT BAL button* (33)
- 8** SHUTTER SPEED button (32)
- 9** AUTO/MANUAL switch (31)
- 10**  (headphones) jack
For stereo mini-jack headphones
- 11** BATT RELEASE button (18)
- 12** Battery pack (17)
- 13** Memory card B slot/select button/access lamp (23)
- 14** Memory card A slot/select button/access lamp (23)
- 15**  (One push) button (34)
- 16** White balance memory switch (33)
- 17** Gain switch (32)
- 18** IRIS button (31)

* WHT BAL button has a raised tactile dot for your convenience in locating the button.

To attach a shoulder strap

Attach a shoulder strap (sold separately) to the hooks for a shoulder strap.

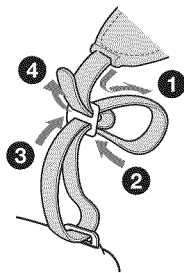

Identifying parts and controls (Continued)

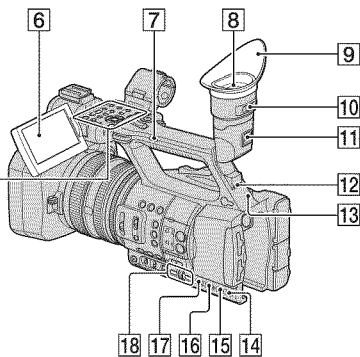
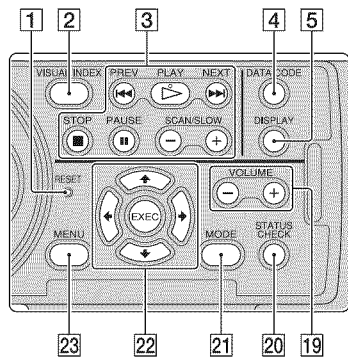

1 RESET button

If you press the RESET button, all settings including the clock setting (except the picture profile settings) return to the default.

2 VISUAL INDEX button (45)

3 Playback control buttons (PREV/PLAY/NEXT/STOP/PAUSE/SCAN/SLOW) (45)

4 DATA CODE button (49)

5 DISPLAY button (49)

6 LCD screen/touch panel (20)

7 Handle zoom switch (29)

8 Viewfinder (21)

9 Large eyecup (21)

10 Viewfinder lens adjustment lever (21)

11 Viewfinder release lever (104)

12 HEADPHONE MONITOR switch (41)

13 Rear recording lamp (80)

The recording lamp flashes if the remaining capacity of the memory card or battery is low.

14 STATUS CHECK button (50)

15 PICTURE PROFILE button* (35)

16 MODE button (56)

17 MENU button** (22, 65)

18 SEL/PUSH EXEC dial/◀/▶ buttons (22, 65)

19 VOLUME buttons* (45)

20 STATUS CHECK button (50)

21 MODE button (56)

22 ▲/▼/◀/▶/EXEC buttons (65)

23 MENU button* (22, 65)

* PICTURE PROFILE button, VOLUME+ button, MENU button, and PLAY button have raised tactile dots for your convenience in locating the buttons.

**MENU button has a raised tactile bar for your convenience in locating the button.

Wireless Remote Commander

Remove the insulation sheet before using the Wireless Remote Commander.

Insulation sheet

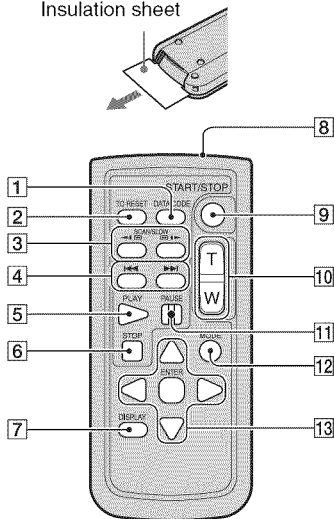

- 1 DATA CODE button (49)
- 2 TC RESET button
This button does not work with this camcorder.
- 3 SCAN/SLOW buttons (45)
- 4 ◀▶ (PREV/NEXT) buttons (45)
- 5 PLAY button (45)
- 6 STOP button (45)
- 7 DISPLAY button (49)
- 8 Transmitter
- 9 START/STOP button (25)
- 10 Power zoom buttons (29)
- 11 PAUSE button (45)
- 12 MODE button (56)
- 13 ◀/▶/▲/▼/ENTER buttons

Notes

- Aim the Wireless Remote Commander towards the remote sensor to operate your camcorder.
- Point the remote sensor away from strong light sources such as direct sunlight or overhead lighting. Otherwise, the Wireless Remote Commander may not function properly.
- When you are operating with the Wireless Remote Commander supplied with your camcorder, your video device may also operate. In that case, select a commander mode other than DVD2 for your video device, or cover the sensor of your video device with black paper.

To change the battery of the Wireless Remote Commander

- 1 While pressing on the tab, inset your fingernail into the slit to pull out the battery case.
- 2 Place a new battery with the + side facing up.
- 3 Insert the battery case back into the Wireless Remote Commander until it clicks.

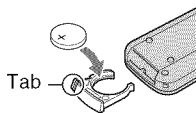

WARNING

Battery may explode if mistreated. Do not recharge, disassemble or dispose of in fire.

- When the lithium battery becomes weak, the operating distance of the Wireless Remote Commander may shorten, or the Wireless Remote Commander may not function properly. In this case, replace the battery with a Sony CR2025 lithium battery. Use of another battery may present a risk of fire or explosion.

Screen indicators

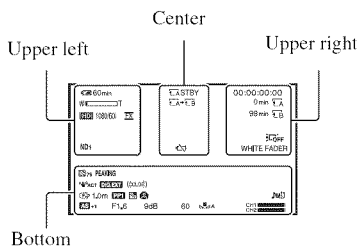

Upper left

Indicator	Meaning
60min	Remaining battery
1080/60i	REC FORMAT (27)
	WIDE REC (73)
ND OFF ND1 ND2 ND3	ND filter (33)

Center

Indicator	Meaning
A B	Memory card
A → B	Relay recording (26)
B → A	Relay recording (26)
STBY REC	Recording status (25)
	Warning (92)
	Playback indicator (45)

Upper right

Indicator	Meaning
0min	Estimated remaining recording time
A B	Recording/playback media
00:00:00:00	Time code (hour:minute:second:frame)
OFF	LCD backlight off (20)
WHITE FADER BLACK FADER	FADER (72)

Bottom

Indicator	Meaning
PEAKING	PEAKING (77)
	ZEBRA (77)
ACT OFF	STEADYSHOT (71)
DIG.EXT	D.EXTENDER (72)
(COLOR)	x.v.Color (72)
	Manual focus (30)
PP1 ~ PP6	Picture profile (35)
	BACK LIGHT (70)
	SPOTLIGHT(70)
CLOSE	Iris (31)
9dB	Gain (32)
60	Shutter speed (32)
	Manual volume control (40)
AS	AE SHIFT (70)
A	Auto setting (78)
A B	White balance (33)

Tips

- Indicators may look different or appear at different positions.

Data code during recording

The recording date, time and condition are recorded automatically on the memory card. They are not displayed while recording. However, you can check them by pressing the DATA CODE button (p. 49).

Index

- A**
- AC Adaptor.....17
 - Access lamp.....23
 - ACTIVE STEADYSHOT.....71
 - AE RESPONSE.....70
 - AE SHIFT.....70, 87
 - AE SHIFT/ASSIGN 5 button.....43
 - AF ASSIST.....71
 - AGC LIMIT.....69
 - AREA SET.....80, 87
 - ASSIGN BUTTON.....43
 - ASSIGN buttons.....43
 - AUDIO LEVEL DISPLAY.....78
 - AUDIO LEVEL (CH1/CH2) dial.....40
 - AUDIO LIMIT.....75
 - AUDIO MANUAL GAIN.....75
 - AUDIO SET menu.....75
 - AUTO IRIS LIMIT.....70
 - AUTO/MAN (CH1/CH2) switch.....40
 - AUTO/MANUAL switch.....31
 - AWB SENS.....69
- B**
- BACK LIGHT.....70, 87
 - BATT RELEASE (battery release) button.....18
 - Battery.....17
 - Battery Info.....50
 - BEEP.....80
 - BLACK FADER.....72
 - Button-type lithium battery.....113
- C**
- CALIBRATION.....103
 - CAMERA DATA DISPLAY.....78, 87
 - CAMERA SET menu.....69
 - CENTER.....77
 - CH1 (INT MIC/INPUT1) switch.....39
 - CH2 (INT MIC/INPUT1/INPUT2) switch.....39
 - Channel setting.....39
 - Charge lamp.....17
 - Charging time.....18
 - CLOCK SET.....22
 - COLOR BAR.....72, 87
 - COLOR LEVEL.....37
 - COLOR MODE.....37
 - COLOR PHASE.....37
 - Connect
 - Computer.....81
 - TV.....51
 - Connecting cord.....19
 - COPY.....38
- D**
- DATA CODE button.....49
 - Date and time.....23, 114
 - DELETE.....61
 - DETAIL.....38
 - DISPLAY button.....20, 49
 - DISPLAY OUTPUT.....79
 - DISPLAY SET menu.....77
 - DIVIDE.....60
 - DST SET.....80, 87
 - D.EXTENDER.....72
- E**
- EXPANDED FOCUS.....31
 - Expanded focus.....31
 - EXPANDED FOCUS TYPE.....78
 - EXPANDED FOCUS/ASSIGN 7 button.....43
- F**
- FADER.....72, 87
 - FLICKER REDUCE.....70
 - Focus.....30
 - Focus infinity.....31
 - Focus ring.....30
 - FOCUS switch.....30
- G**
- Gain.....32
 - GAIN button.....32
 - GAIN SET.....69
 - Gain switch.....32
 - GAMMA.....37
 - Grip belt.....20
 - GUIDEFRAAME.....77
- H**
- Handle record button.....25
 - HANDLE ZOOM.....71
 - Handle zoom.....29
 - Handle zoom lever.....29
 - Handle zoom switch.....29
 - HEADPHONE OUT.....75
 - Headphones jack.....111
 - High definition TV.....52
 - Holding the camcorder.....20
 - Hook for shoulder strap.....111
- I**
- Image database file.....64
 - INDOOR.....34
 - Indoor.....34
 - “InfoLITHIUM” battery pack.....100
 - INPUT1.....39
 - INPUT1 switch.....39
 - INPUT1 TRIM.....76
 - INPUT1 WIND.....76
 - INPUT2.....39
 - INPUT2 switch.....39
 - INPUT2 TRIM.....76
 - INPUT2 WIND.....76
 - Insulation sheet.....113

Index (Continued)

INT MIC SENS75
INT MIC SET75
INT MIC WIND75
Internal microphone75
IRIS31
IRIS button31
Iris ring31
IRIS RING ROTATE69

L

LANGUAGE80
Large eyecup21
LCD backlight20
LCD BACKLIGHT LEVEL
.....78, 87
LCD BRIGHT78
LCD COLOR78
LCD screen20
Lens103
Lens cover lever16

M

MANAGE MEDIA62
MARKER77, 87
MEDIA FORMAT62
Memory card9, 99
 Insert/Eject23
Memory card slot23
“Memory Stick Duo” media
slot cover23
“Memory Stick” media
.....9, 100
“Memory Stick PRO Duo”
media100
Menu65
 AUDIO SET menu75
 CAMERA SET menu69
 DISPLAY SET menu77
 MODE menu56
 OTHERS menu80
 REC/OUT SET menu73
MENU button22, 65

Menu items67
MIC+48V40
MINUS AGC69
MODE button56
MODE menu56
Moisture condensation102

N

ND filter33
NTSC97

O

One push button34
OTHERS menu80
OUTDOOR34
Outdoor34
OUTPUT SELECT74
Outside power source19

P

PAL97
PEAKING77, 87
PHOTO CAPTURE59
Picture profile35
PICTURE PROFILE button
.....35
Playback45
PLAYLIST58
PLAYLIST EDIT58
Power cord (mains lead)17
POWER switch19
Pre-installed rechargeable
battery103
PROTECT57
PUSH AUTO button30
Push auto focus30
PUSH (lens hood release)
button16

R

REC CH SELECT switch39

REC FORMAT27
REC LAMP80
REC SET73
Record button25
Recording25
Recording format27
Recording lamp25
REC/OUT SET menu73
Relay recording26
REMAINING79
REMOTE CONTROL80
Remote sensor110
REPAIR IMAGE DB FILE
.....64
RESET38
RESET button112

S

Screen indicators114
SD WIDE REC73
Self-diagnosis display92
SEL/PUSH EXEC dial22, 65
Shoulder strap111
Shutter speed32
SHUTTER SPEED button
.....32
SKINTONE DETAIL38
SMOOTH SLOW REC41
Specifications105
SPOTLIGHT70, 87
Status check50
STATUS CHECK button50
STEADYSHOT71
Still image59
SUMMERTIME80, 87

T

Telephoto29
Trademark107
Transmitter113
Troubleshooting83

TV	51
TV color systems	97
TV TYPE	74

U

USB SELECT	82
Using the menu	56, 65
Using your camcorder abroad	97

V

VF BACKLIGHT	79, 87
VF POWERMODE	79
VIDEO OUT	74
Viewfinder	21
Viewfinder lens adjustment lever	21
Viewfinder release lever	104
VISUAL INDEX button	45
VISUAL INDEX/ASSIGN 6 button	43
Volume	47
VOLUME buttons	47

W

Warning indicators	92
Warning messages	93
WB PRESET	69
WB SHIFT	37
White balance	33
White balance memory switch	34
WHITE FADER	72
WHT BAL button	33
Wide angle	29
Wireless Remote Commander	113

X

XLR AGC LINK	75
XLR SET	75
x.v.Color	72

Z

ZEBRA	77, 87
ZEBRA/ASSIGN 4 button	43
Zoom	29
Zoom lever	29
Zoom ring	29
ZOOM switch	29

Paso 1: Comprobación de los elementos suministrados

Asegúrese de que su videocámara contiene los siguientes elementos.

El número entre paréntesis indica la cantidad del elemento.

- No se incluyen las tarjetas de memoria.

Adaptador de alimentación de ca (AC-L100C) (1) (pág. 120)

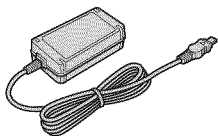

Cable de alimentación (1) (pág. 120)



Control remoto inalámbrico (RMT-845) (1)



Tiene instalada una pila de litio tipo botón.

Cable de video componente (1)



Cable de conexión A/V (1)

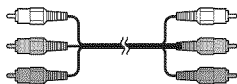

Cable USB (1)

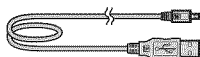

Ocular grande (1) (pág. 124)

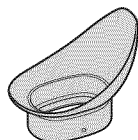

Batería recargable (NP-F570) (1) (pág. 120)



Parasol del objetivo con tapa del objetivo (1) (pág. 119)

Este parasol del objetivo está premontado.

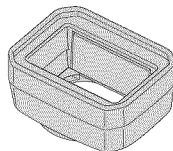

CD-ROM "Content Management Utility" (1)

Guía de operaciones (1)

Paso 2: Colocación del parasol del objetivo con tapa del objetivo

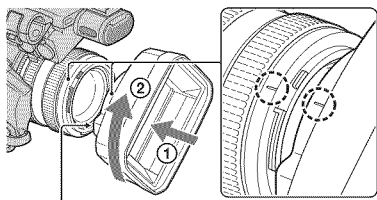

Botón PUSH (liberación del parasol del objetivo)

Alinee las marcas en el parasol con las marcas en la videocámara y gire el parasol del objetivo en la dirección que indica la flecha ② hasta que se bloquee.

Para extraer el parasol del objetivo con tapa del objetivo

Gire el parasol del objetivo en la dirección opuesta a la de la flecha ② de la ilustración mientras presiona el botón PUSH (liberación del parasol del objetivo).

🔧 Consejos

- Si coloca o retira un filtro PL de 72 mm o el protector MC, retire el parasol del objetivo con tapa del objetivo.

Para abrir o cerrar el obturador del parasol del objetivo con tapa del objetivo

Mueva la palanca de la tapa del objetivo a la posición OPEN para abrir la tapa del objetivo y muévala a la posición CLOSE para cerrarla.

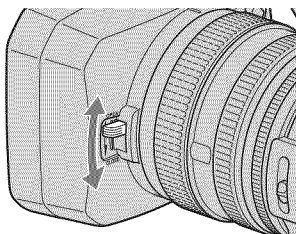

Paso 3: Carga de la batería

Puede cargar la batería "InfoLITHIUM" (serie L) con el adaptador de alimentación de ca suministrado.

Notas

- No se puede utilizar baterías que no sean "InfoLITHIUM" (serie L).

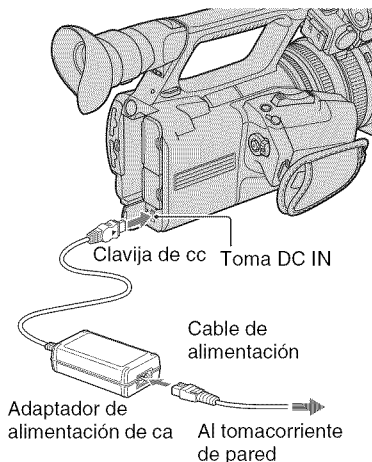

- 1 Ejerza presión sobre la batería contra la parte posterior de la videocámara y deslícela hacia abajo.

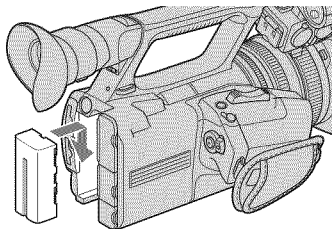

- 2 Con la marca ► de la clavija de cc hacia fuera, conecte la clavija de cc a la toma de DC IN de la videocámara.

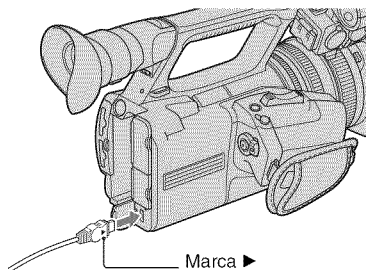

- 3 Conecte el cable de alimentación al adaptador de alimentación de ca

- 4 Conecte el cable de alimentación al tomacorriente de la pared.

5 Ajuste el interruptor POWER en OFF (CHG).

El indicador CHG se enciende y se inicia el proceso de carga.

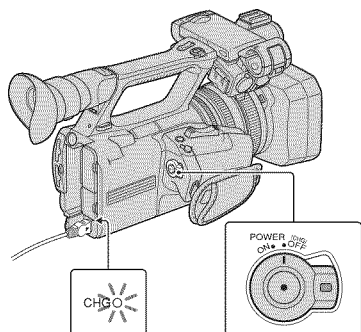

Después de cargar la batería

El indicador CHG se apaga cuando la batería está completamente cargada. Desconecte el adaptador de alimentación de ca de la toma de DC IN.

💡 Consejos

- Puede comprobar la carga restante de la batería con la función de comprobación de estado.

Para retirar la batería

Deslice el interruptor POWER a la posición OFF (CHG). Presione el botón BATT RELEASE (liberación de la batería) y retire la batería.

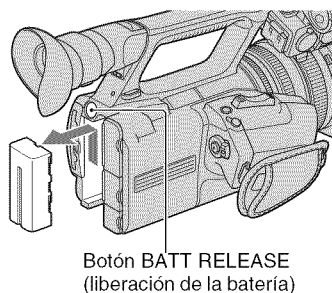

Para guardar la batería

Si deja de usar la batería por un tiempo, úsela hasta agotarla y guárdela.

Tiempo de carga

Tiempo aproximado (m) necesario para cargar totalmente una batería descargada por completo.

Batería	Tiempo de carga
NP-F570 (suministrada)	260
NP-F770	370
NP-F970	485

🔌 Notas

- No se pueden usar baterías NP-F330 con esta videocámara.

Paso 3: Carga de la batería (Continuación)

Acerca de la batería

- Antes de cambiar la batería, ajuste el interruptor POWER en la posición OFF (CHG).
- El indicador CHG parpadeará durante la carga o la información de la batería no se mostrará correctamente en las siguientes condiciones.
 - La batería no está correctamente conectada.
 - La batería está dañada.
 - La batería está gastada.
 - La batería está demasiado fría.
Remueva la batería y colóquela en un lugar cálido.
 - La batería está demasiado caliente.
Remueva la batería y colóquela en un lugar frío.
- Cuando el adaptador de alimentación de ca esté conectado a la toma de DC IN de la videocámara, la batería no suministrará alimentación, incluso si el cable de alimentación está desconectado al tomacorriente de pared.

Tiempo de carga

- Tiempo medido con la videocámara a 25 °C
Se recomienda de 10 °C a 30 °C

Uso de una fuente de alimentación externa

Puede usar un adaptador de alimentación de ca para obtener energía de ca. Mientras utiliza el adaptador de alimentación de ca la batería no perderá su carga aunque esté conectada a la cámara.

Conecte la videocámara como se muestra en “Paso 3: Carga de la batería” en la página 120.

Acerca del adaptador de alimentación de ca

- Evite los cortocircuitos en la clavija de cc del adaptador de alimentación de ca o en el terminal de la batería con objetos metálicos. Podría provocar una falla de funcionamiento.

Paso 4: Encendido y sujeción adecuados de la videocámara

Para grabar o reproducir, coloque el interruptor POWER en la posición ON. La primera vez que utilice la videocámara, aparecerá la pantalla [AJUS.RELOJ] (pág. 125).

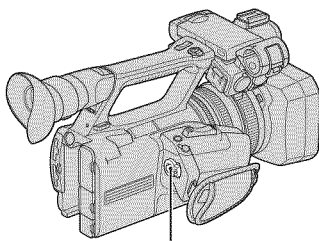

Interruptor POWER

-
- 1** Deslice el interruptor POWER a la posición ON mientras presiona el botón verde.

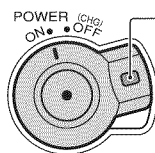

Mantenga presionado el botón verde.

⚡ Notas

- La fecha y hora actuales aparecen en la pantalla LCD por unos segundos al encender la videocámara después de haberse ajustado la fecha y la hora [AJUS.RELOJ] (pág. 125).

Paso 5: Ajuste del panel LCD y el visor

2 Sostenga la videocámara correctamente.

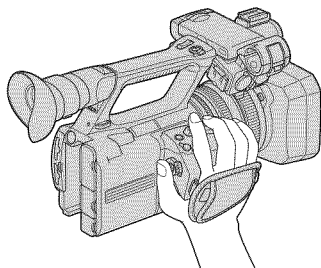

3 Asegúrese de que la sostiene correctamente y luego ajuste la correa de sujeción.

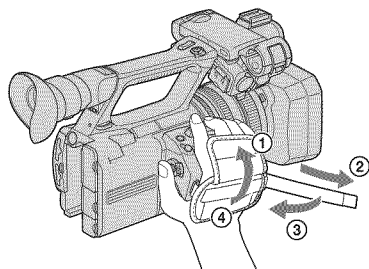

Para apagar la videocámara

Deslice el interruptor POWER a la posición OFF (CHG).

Notas

- Si en la pantalla aparecen mensajes de advertencia, siga las instrucciones.

Panel LCD

Abra el panel LCD 180 grados (①), luego gírelo hasta encontrar el mejor ángulo para grabar o reproducir (②).

① Abra 180 grados.

② 90 grados (máx.)

② 180 grados (máx.)

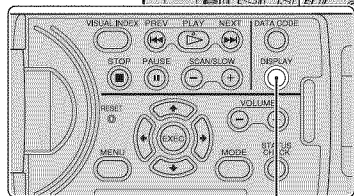
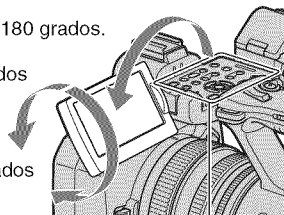

Botón DISPLAY

Consejos

- Las imágenes se muestran como imágenes de espejo en la pantalla LCD, pero se graban como imágenes normales.

Para desactivar la luz de fondo de la pantalla LCD y prolongar la duración de la batería

Mantenga presionado el botón DISPLAY durante unos segundos hasta que aparezca OFF.

Este ajuste es práctico cuando utiliza la videocámara en lugares muy luminosos o cuando desea ahorrar energía. Este ajuste no afectará a la imagen grabada. Para encender la luz de fondo de la pantalla LCD, mantenga presionado el botón DISPLAY durante unos segundos hasta que OFF desaparezca.

Además, puede encender la luz de fondo de la pantalla LCD al encender/apagar la videocámara.

Paso 5: Ajuste del panel LCD y el visor (Continuación)

💡 Consejos

- Puede ajustar el brillo de la pantalla LCD en [BRILLO LCD].

Visor

Puede ver imágenes utilizando el visor para ahorrar energía de la batería o cuando la imagen en la pantalla LCD no sea clara.

Palanca de ajuste del objetivo del visor
Muévela hasta que la imagen aparezca nítida.

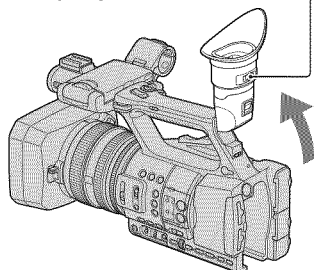
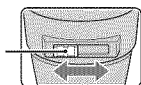

colocar el ocular grande hacia el lado derecho o izquierdo.

⚡ Notas

- No retire el ocular preinstalado.

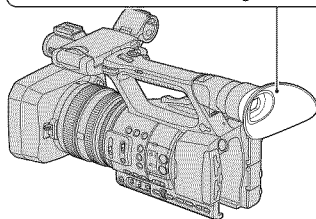
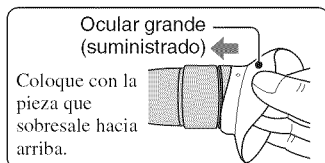

⚡ Notas

- Es posible que los colores primarios produzcan algún resplandor cuando en el visor usted cambie su línea visual. No se trata de una falla de funcionamiento. Los colores resplandecientes no se graban en la tarjeta de memoria.

💡 Consejos

- Puede ajustar el brillo de la luz de fondo del visor con [LUZ FONDO VISOR].
- Para ver imágenes tanto en la pantalla LCD como en el visor, ajuste [M.ALIM.VISOR] en [ACTIVADO].

Cuando tenga dificultades para ver la imagen del visor

Si no puede ver claramente la imagen en el visor en condiciones de brillo, use el ocular grande suministrado. Para colocar el ocular grande, ensáchelo un poco y alinéelo con la ranura del ocular en el visor. Puede

Paso 6: Ajuste de la fecha y la hora

Ajuste la fecha y la hora cuando use la videocámara por primera vez. De lo contrario, la pantalla [AJUS.RELOJ] aparecerá cada vez que encienda la videocámara.

💡 Consejos

- Si no usa la videocámara durante **aproximadamente 3 meses**, la batería recargable incorporada se descarga y es posible que los ajustes de la fecha y la hora se borren de la memoria. En este caso, cargue la batería recargable y ajuste la fecha y la hora nuevamente.

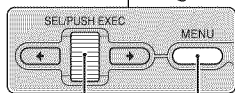
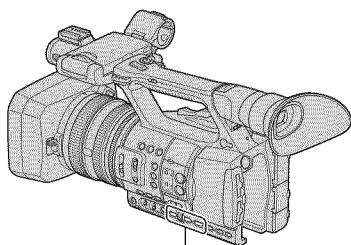

Selector SEL/
PUSH EXEC

Botón
MENU

Vaya directamente al paso 4 cuando ajuste el reloj por primera vez.

1 Presione el botón MENU.

- 2 Seleccione  (OTROS) girando el selector SEL/PUSH EXEC, luego presione el selector.

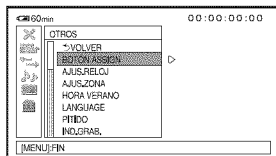

- 3 Seleccione [AJUS.RELOJ] girando el selector SEL/PUSH EXEC, luego presione el selector.

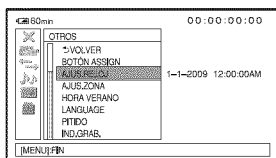

- 4 Seleccione el área girando el selector SEL/PUSH EXEC y luego presione el selector.

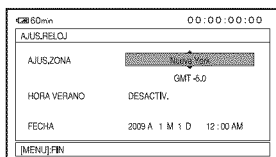

- 5 Ajuste [HORA VERANO], [A] (año), [M] (mes), [D] (día), hora y minuto, girando el selector SEL/PUSH EXEC y luego presione el selector.

Paso 6: Ajuste de la fecha y la hora (Continuación)



El reloj se pone en marcha.

- Ajuste [HORA VERANO] en la posición [ACTIVADO] para avanzar 1 h
- Puede seleccionar cualquier año hasta el año 2037.
- Para la medianoche, ajústelo en 12:00 AM. Para el mediodía, ajústelo en 12:00 PM.

💡 Consejos

- La fecha y la hora se graban automáticamente en la tarjeta de memoria seleccionada y se pueden ver durante la reproducción (botón DATA CODE).

Cambio del ajuste de idioma

Puede cambiar las indicaciones en pantalla para que muestren mensajes en un idioma en particular.

Presione el botón MENU y seleccione  (OTROS) con el selector SEL/PUSH EXEC. Seleccione el idioma de los mensajes en pantalla en [LANGUAGE].

Paso 7: Inserción de una tarjeta de memoria

- 1 Abra la tapa en la dirección que indica la flecha.

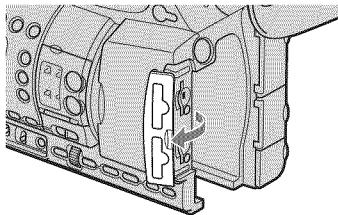

- 2 Oriente la esquina biselada de la tarjeta de memoria como se muestra en la ilustración e insértela en la ranura para tarjeta de memoria hasta que calce.

Ranura para tarjeta de memoria A e indicador de acceso

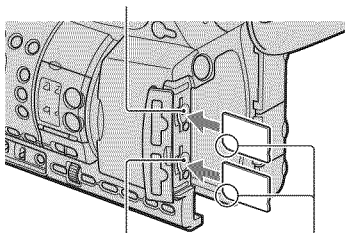

Ranura para tarjeta de memoria B e indicador de acceso

Inserte la esquina biselada primero, mirando hacia abajo.

📌 Notas

- Si inserta una tarjeta de memoria en la ranura en la dirección incorrecta, puede dañarse la tarjeta de memoria, la ranura para tarjeta de memoria o los datos de imágenes.

- Cuando inserta una nueva tarjeta de memoria en modo de espera, aparece la pantalla [Crear nuevo arch.base de datos de imágenes.]. Siga las indicaciones en pantalla y toque [SI].

Para expulsar la tarjeta de memoria

Empuje suavemente la tarjeta de memoria una vez.

⚙️ Notas

- Cuando el indicador de acceso se enciende o parpadea en color rojo, la videocámara está leyendo o grabando datos. No sacuda ni golpee la videocámara, no la apague, ni extraiga la tarjeta de memoria ni retire la batería. De lo contrario, se podrían dañar los datos de imágenes.
- Si aparece [Error al crear un nuevo archivo de base de datos de imágenes. Es posible que no exista suficiente espacio libre.] en el paso 2, formatee la tarjeta de memoria.
- Al insertar o expulsar la tarjeta de memoria, tenga cuidado de evitar que la tarjeta de memoria no salte ni se caiga.

Selección de la ranura para tarjeta de memoria que se usará en la grabación

Presione el botón A o B de la ranura para tarjeta de memoria donde está insertada la tarjeta de memoria con la que desea grabar. El indicador de la ranura seleccionada se enciende de color verde.

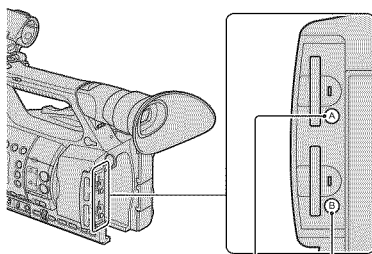

Botón A de la ranura para tarjeta de memoria

Botón B de la ranura para tarjeta de memoria

⚙️ Notas

- Sólo puede seleccionar una ranura que ya tenga una tarjeta de memoria insertada.
- Mientras se graban películas en la tarjeta de memoria, no puede cambiar la ranura aunque presione los botones A/B de la ranura para tarjeta de memoria.

💡 Consejos

- Cuando sólo una ranura tiene una tarjeta de memoria insertada, la ranura que tiene la tarjeta de memoria se selecciona automáticamente.
- Si el espacio de la tarjeta de memoria se ocupa completamente durante la grabación, la videocámara continúa la grabación automáticamente en la tarjeta de memoria insertada en la otra ranura (Grabación con relevo, pág. 130).

Grabación

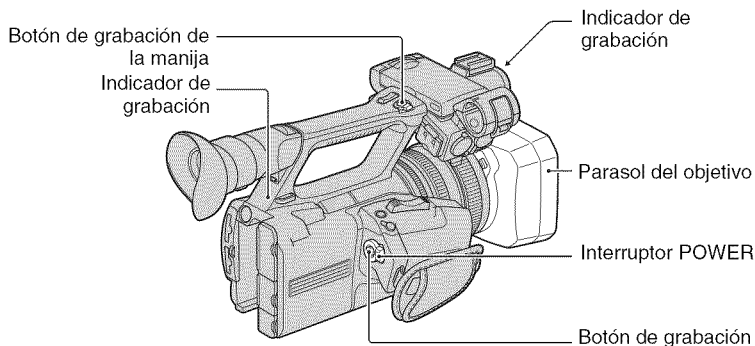

La videocámara graba películas en las tarjetas de memoria. Proceda de la siguiente forma para grabar películas.

- Esta videocámara puede grabar películas con calidad de imagen de alta definición (HD) o calidad de imagen de definición estándar (SD). El ajuste predeterminado de fábrica es calidad de imagen de alta definición (HD) ([FORM.GRAB.], pág. 130).

Notas

- Cuando el indicador de acceso está encendido o parpadeando de color rojo, la videocámara está escribiendo datos en la tarjeta de memoria. No sacuda ni golpee la videocámara y no retire el adaptador de alimentación de ca ni la batería.
- La videocámara puede grabar películas durante 13 h aproximadamente.
- Si un archivo de película excede los 2 GB durante la grabación, la videocámara divide el archivo y crea un nuevo archivo automáticamente.
- Los ajustes de menú, los ajustes de PICTURE PROFILE y los ajustes realizados con el interruptor AUTO/MANUAL se almacenan en la videocámara cuando ajusta el interruptor POWER en la posición OFF. El indicador de acceso se enciende mientras se almacenan los ajustes. Si retira la batería o el adaptador de alimentación de ca antes de apagar la videocámara, es posible que los ajustes regresen a los valores predeterminados.

1 Abra el obturador del paracol del objetivo.

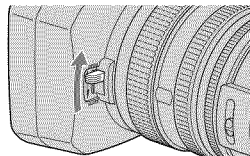

2 Deslice el interruptor POWER a la posición ON mientras presiona el botón verde.

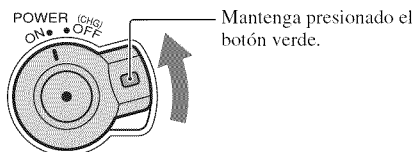

3 Presione el botón de grabación o el botón de grabación de la manija.

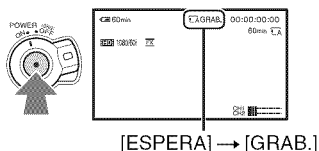

El indicador de grabación se enciende durante la grabación.

Para detener la grabación de una película, vuelva a presionar el botón de grabación o el botón de grabación de la manija.

💡 Consejos

- Al grabar con calidad de imagen de alta definición (HD), la relación de aspecto está ajustada en 16:9. Al grabar con calidad de imagen de definición estándar (SD), puede cambiar la relación de aspecto a 4:3 ([GRABACIÓN PANOR. **HSDF**]).
- Puede cambiar la visualización de la pantalla durante la grabación.
- El indicador de grabación se puede desactivar ([IND.GRAB.]).
- Para grabaciones de ángulo bajo, resulta conveniente usar el botón de grabación de la manija. Suelte la palanca HOLD para activar el botón de grabación de la manija. Tal vez resulte útil colocar el panel LCD cara arriba o cerrarlo después de colocarlo cara abajo o levantar el visor durante este tipo de grabación.
- Puede capturar imágenes fijas a partir de las películas que grabó.

Grabación continua en las tarjetas de memoria, una después de otra (Grabación con relevo)

Inserte las tarjetas de memoria en las ranuras A y B, de manera que la videocámara cambie la tarjeta de memoria A (o B) justo antes de que se termine el espacio de la otra tarjeta y continúe grabando en la siguiente tarjeta de memoria en forma automática.

Inserte una tarjeta de memoria que se pueda grabar.

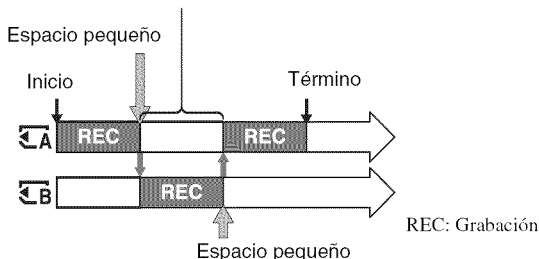

Notas

- No expulse la tarjeta de memoria que se está usando actualmente para grabar. Reemplace sólo la tarjeta de memoria cuyo indicador de ranura esté apagado.
- Aunque presione el botón de la ranura de tarjeta de memoria, no es posible cambiar la ranura que se está usando actualmente, A o B, mientras se graban películas.
- Cuando el tiempo de grabación restante de la tarjeta de memoria que está usando es menor a 1 m y la otra ranura tiene insertada una tarjeta de memoria que se puede grabar, aparece [A → B] o [B → A] en la pantalla de la videocámara. El indicador se apaga cuando se cambia la tarjeta de memoria.
- Si comienza la grabación en una tarjeta de memoria con tiempo de grabación restante menor a 1 minuto, es posible que la videocámara no pueda grabar con relevo. Para grabar con relevo sin errores, asegúrese de que la tarjeta de memoria tenga más de 1 m al iniciar la grabación.
- Esta videocámara no puede reproducir sin cortes las películas grabadas con relevo.
- Puede volver a combinar las películas grabadas con relevo utilizando el software de aplicación suministrado (sólo Windows).

Selección del formato de grabación

Puede seleccionar el formato de grabación (velocidad de bits, calidad de imagen, tamaño de imagen, velocidad de cuadros, sistema de exploración). En el ajuste predeterminado, [HD: 1080/60i FX] está seleccionado.

Para cambiar el ajuste

Presione MENU → seleccione (AJUSTE GRAB./SALIDA) → [FORM.GRAB.] con el selector SEL/PUSH EXEC.

Valor de ajuste	Descripción
HD: 1080/60i FX	<ul style="list-style-type: none"> • Velocidad de bits FX: máx. 24 Mbps FH: aprox. 17 Mbps (promedio) HQ: aprox. 9 Mbps (promedio) LP: aprox. 5 Mbps (promedio)
HD: 1080/60i FH	
HD: 1080/60i HQ	<ul style="list-style-type: none"> • Calidad de imagen HD: Calidad de imagen de alta definición SD: Calidad de imagen de definición estándar
HD: 1080/60i LP	
HD: 1080/30p FX	<ul style="list-style-type: none"> • Tamaño de imagen FX: 1920×1080 FH: 1920×1080 HQ: Grabación HD 1440×1080 Grabación SD 720×480 LP: 1440×1080
HD: 1080/30p FH	
HD: 1080/24p FX	<ul style="list-style-type: none"> • Velocidad de cuadros 24, 30 ó 60 • Sistema de exploración i: entrelazado p: progresivo pSCAN: Graba imágenes de sistema de exploración progresiva como señal entrelazada (60i).
HD: 1080/24p FH	
SD: 480/60i HQ	
SD: 480/30p SCAN HQ	
SD: 480/24p SCAN HQ	

Valor de ajuste

Por ejemplo, si selecciona [**HD:** 1080/60i **FX**], las películas se graban con el siguiente formato.

- HD: Calidad de imagen de alta definición. SD es la calidad de imagen de definición estándar.
- 1080: Líneas de exploración efectivas
- 60: Velocidad de cuadros
- i: Sistema de exploración
- FX: Modo de grabación

Notas

- El modo de grabación se ajusta en FX o FH con el sistema de exploración progresiva.

Additional information on this product and answers to frequently asked questions can be found at our Customer Support Website.

<http://www.sony.net/>

Printed in Japan



4163319130