

HANDYCAM

Digital HD Video Camera Recorder

Operating Guide US

Guía de operaciones ES

Please also refer to :

Por favor consulte también:

<http://www.sony.net/SonyInfo/Support/>

Additional information on this product and answers to frequently asked questions can be found at our Customer Support Website.

Puede encontrar más información sobre este producto y respuestas a las preguntas más frecuentes en nuestro sitio Web de atención al cliente.

<http://www.sony.net/>

Printed on 70% or more recycled paper using VOC (Volatile Organic Compound)-free vegetable oil based ink.

Impreso en papel reciclado en un 70% o más utilizando tinta hecha con aceite vegetal exento de compuesto orgánico volátil (COV).



4418119110

US/ES

HANDYCAM

AVCHD
ProgressiveHDMI
HIGH DEFINITION MULTIMEDIA INTERFACEInfoLITHIUM
SERIES

MEMORY STICK TV

SD
XC
CLASSICNAVTEQ
MAPS

Owner's Record

The model and serial numbers are located on the bottom. Record the serial number in the space provided below. Refer to these numbers whenever you call upon your Sony dealer regarding this product.

Model No. HDR- _____

Serial No. _____

Model No. AC- _____

Serial No. _____

WARNING

To reduce fire or shock hazard, do not expose the unit to rain or moisture.

Do not expose the batteries to excessive heat such as sunshine, fire or the like.

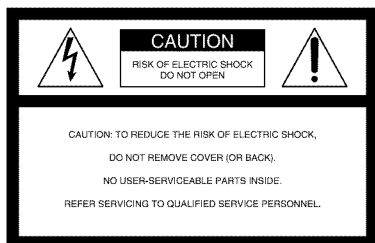

This symbol is intended to alert the user to the presence of uninsulated “dangerous voltage” within the product’s enclosure that may be of sufficient magnitude to constitute a risk of electric shock to persons.



This symbol is intended to alert the user to the presence of important operating and maintenance (servicing) instructions in the literature accompanying the appliance.

IMPORTANT SAFETY INSTRUCTIONS

SAVE THESE INSTRUCTIONS.
DANGER - TO REDUCE THE RISK OF FIRE
OR ELECTRIC SHOCK,
CAREFULLY FOLLOW THESE
INSTRUCTIONS.

US

- Read these instructions.
- Keep these instructions.
- Heed all warnings.
- Follow all instructions.
- Do not use this apparatus near water.
- Clean only with dry cloth.
- Do not block any ventilation openings. Install in accordance with the manufacturer's instructions.
- Do not install near any heat sources such as radiators, heat registers, stoves, or other apparatus (including amplifiers) that produce heat.
- Do not defeat the safety purpose of the polarized or grounding-type plug. A polarized plug has two blades with one wider than the other. A grounding type plug has two blades and a third grounding prong. The wide blade or the third prong are provided for your safety. If the provided plug does not fit into your outlet, consult an electrician for replacement of the obsolete outlet.
- Protect the power cord from being walked on or pinched particularly at plugs, convenience receptacles, and the point where they exit from the apparatus.
- Only use attachments/accessories specified by the manufacturer.
- Use only with the cart, stand, tripod, bracket, or table specified by the manufacturer, or sold with the apparatus. When a cart is used, use caution when moving the cart/apparatus combination to avoid injury from tip-over.



- Unplug this apparatus during lightning storms or when unused for long periods of time.
- Refer all servicing to qualified service personnel. Servicing is required when the apparatus has been damaged in any way, such as power-supply cord or plug is damaged, liquid has been spilled or objects have fallen into the apparatus, the apparatus has been exposed to rain or moisture, does not operate normally, or has been dropped.
- If the shape of the plug does not fit the power outlet, use an attachment plug adaptor of the proper configuration for the power outlet.

Representative plug of power supply cord of countries/regions around the world.



A Type
(American Type)



B Type
(British Type)



BF Type
(British Type)



B3 Type
(British Type)



C Type
(CEE Type)



SE Type
(CEE Type)



O Type
(Ocean Type)

The representative supply voltage and plug type are described in this chart.

Depend on an area, Different type of plug and supply voltage are used.

Attention: Power cord meeting demands from each country shall be used.

– For only the United States

Use a UL Listed, 1.5-3 m (5-10 ft.), Type SPT-2 or NISPT-2, AWG no. 18 power supply cord, rated for 125 V 7 A, with a NEMA 1-15P plug rated for 125 V 15 A.”

Europe

Countries/regions	Voltage	Frequency (Hz)	Plug type
Austria	230	50	C
Belgium	230	50	C
Czech	220	50	C
Denmark	230	50	C
Finland	230	50	C
France	230	50	C
Germany	230	50	C
Greece	220	50	C
Hungary	220	50	C
Iceland	230	50	C
Ireland	230	50	C/BF
Italy	220	50	C
Luxemburg	230	50	C
Netherlands	230	50	C
Norway	230	50	C
Poland	220	50	C
Portugal	230	50	C
Romania	220	50	C
Russia	220	50	C
Slovak	220	50	C
Spain	127/230	50	C
Sweden	230	50	C
Switzerland	230	50	C
UK	240	50	BF

Asia

Countries/regions	Voltage	Frequency (Hz)	Plug type
China	220	50	A
Hong Kong	200/220	50	BF
India	230/240	50	C
Indonesia	127/230	50	C
Japan	100	50/60	A
Korea (rep)	220	60	C
Malaysia	240	50	BF
Philippines	220/230	60	A/C
Singapore	230	50	BF
Taiwan	110	60	A

Countries/regions	Voltage	Frequency (Hz)	Plug type
Thailand	220	50	C/BF
Vietnam	220	50	A/C

Oceania

Countries/regions	Voltage	Frequency (Hz)	Plug type
Australia	240	50	O
New Zealand	230/240	50	O

North America

Countries/regions	Voltage	Frequency (Hz)	Plug type
Canada	120	60	A
USA	120	60	A

Central America

Countries/regions	Voltage	Frequency (Hz)	Plug type
Bahamas	120/240	60	A
Costa Rica	110	60	A
Cuba	110/220	60	A/C
Dominican (rep)	110	60	A
El Salvador	110	60	A
Guatemala	120	60	A
Honduras	110	60	A
Jamaica	110	50	A
Mexico	120/127	60	A
Nicaragua	120/240	60	A
Panama	110/220	60	A

South America

Countries/regions	Voltage	Frequency (Hz)	Plug type
Argentina	220	50	C/BF/O
Brazil	127/220	60	A/C
Chile	220	50	C
Colombia	120	60	A
Peru	220	60	A/C
Venezuela	120	60	A

Middle East

Countries/regions	Voltage	Frequency (Hz)	Plug type
Iran	220	50	C/BF
Iraq	220	50	C/BF
Israel	230	50	C
Saudi Arabia	127/220	50	A/C/BF
Turkey	220	50	C
UAE	240	50	C/BF

Africa

Countries/regions	Voltage	Frequency (Hz)	Plug type
Algeria	127/220	50	C
Congo (dem)	220	50	C
Egypt	220	50	C
Ethiopia	220	50	C
Kenya	240	50	C/BF
Nigeria	230	50	C/BF
South Africa	220/230	50	C/BF
Tanzania	230	50	C/BF
Tunisia	220	50	C

Read this first

Before operating the unit, please read this manual thoroughly, and retain it for future reference.

CAUTION

Battery pack

If the battery pack is mishandled, the battery pack can burst, cause a fire or even chemical burns. Observe the following cautions.

- Do not disassemble.
- Do not crush and do not expose the battery pack to any shock or force such as hammering, dropping or stepping on it.
- Do not short circuit and do not allow metal objects to come into contact with the battery terminals.
- Do not expose to high temperature above 60°C (140°F) such as in direct sunlight or in a car parked in the sun.
- Do not incinerate or dispose of in fire.
- Do not handle damaged or leaking lithium ion batteries.
- Be sure to charge the battery pack using a genuine Sony battery charger or a device that can charge the battery pack.
- Keep the battery pack out of the reach of small children.
- Keep the battery pack dry.
- Replace only with the same or equivalent type recommended by Sony.
- Dispose of used battery packs promptly as described in the instructions.

Replace the battery with the specified type only. Otherwise, fire or injury may result.

AC Adaptor

Do not use the AC Adaptor placed in a narrow space, such as between a wall and furniture.

Use the nearby wall outlet (wall socket) when using the AC Adaptor. Disconnect the AC Adaptor from the wall outlet (wall socket) immediately if any malfunction occurs while using your camcorder.

Even if your camcorder is turned off, AC power source (mains) is still supplied to it while connected to the wall outlet (wall socket) via the AC Adaptor.

Note on the power cord (mains lead)

The power cord (mains lead) is designed specifically for use with this camcorder only, and should not be used with other electrical equipment.

Excessive sound pressure from earphones and headphones can cause hearing loss.

For customers in the U.S.A. and CANADA

RECYCLING LITHIUM-ION BATTERIES

Lithium-Ion batteries are recyclable.

You can help preserve our environment by returning your used rechargeable batteries to the collection and recycling location nearest you.



For more information regarding recycling of rechargeable batteries, call toll free 1-800-822- 8837, or visit <http://www.rbrc.org/>

Caution: Do not handle damaged or leaking Lithium-Ion batteries.

Battery pack

This device complies with Part 15 of the FCC Rules. Operation is subject to the following two conditions: (1) This device may not cause harmful interference, and (2) this device must accept any interference received, including interference that may cause undesired operation.

This class B digital apparatus complies with Canadian ICES-003.

For the customers in the U.S.A.

UL is an internationally recognized safety organization.

The UL Mark on the product means it has been UL Listed.

If you have any questions about this product, you may call:

Sony Customer Information Center 1-800-222-SONY (7669).

The number below is for the FCC related matters only.

Regulatory Information

Declaration of Conformity

Trade Name: SONY

Model No.: HDR-CX760V, HDR-PJ760V

Responsible Party: Sony Electronics Inc.

Address: 16530 Via Esprillo, San Diego, CA 92127 U.S.A.

Telephone No.: 858-942-2230

This device complies with Part 15 of the FCC Rules. Operation is subject to the following two conditions: (1) This device may not cause harmful interference, and (2) this device must accept any interference received, including interference that may cause undesired operation.

Declaration of Conformity

Trade Name: SONY

Model No.: HDR-PJ710V

Responsible Party: Sony Electronics Inc.

Address: 16530 Via Esprillo, San Diego, CA 92127 U.S.A.

Telephone No.: 858-942-2230

This device complies with Part 15 of the FCC Rules. Operation is subject to the following two conditions: (1) This device may not cause harmful interference, and (2) this device must accept any interference received, including interference that may cause undesired operation.

CAUTION

You are cautioned that any changes or modifications not expressly approved in this manual could void your authority to operate this equipment.

Note

This equipment has been tested and found to comply with the limits for a Class B digital device, pursuant to Part 15 of the FCC Rules.

These limits are designed to provide reasonable protection against harmful interference in a residential installation. This equipment generates, uses, and can radiate radio frequency energy and, if not installed and used in accordance with the instructions, may cause harmful interference to radio communications. However, there is no guarantee that interference will not occur in a particular installation. If this equipment does cause harmful interference to radio or television reception, which can be determined by turning the equipment off and on, the user is encouraged to try to correct the interference by one or more of the following measures:

- Reorient or relocate the receiving antenna.
- Increase the separation between the equipment and receiver.

- Connect the equipment into an outlet on a circuit different from that to which the receiver is connected.
- Consult the dealer or an experienced radio/TV technician for help.

The supplied interface cable must be used with the equipment in order to comply with the limits for a digital device pursuant to Subpart B of Part 15 of FCC Rules.

For the State of California , USA only

Perchlorate Material – special handling may apply,

See

www.dtsc.ca.gov/hazardouswaste/perchlorate

Perchlorate Material: Lithium battery contains perchlorate.

For the customers in Canada

This device complies with RSS-310 of Industry Canada. Operation is subject to the condition that this device does not cause harmful interference.



About language setting

- The on-screen displays in each local language are used for illustrating the operating procedures. Change the screen language before using the camcorder if necessary (p. 22).

On recording

- Before starting to record, test the recording function to make sure the image and sound are recorded without any problems.
- Compensation for the contents of recordings cannot be provided, even if recording or playback is not possible due to a malfunction of the camcorder, recording media, etc.
- TV color systems differ depending on the country/region. To view your recordings on a TV, you need a NTSC system-based TV.
- Television programs, films, video tapes, and other materials may be copyrighted. Unauthorized recording of such materials may be contrary to the copyright laws.

Notes on use

- Do not do any of the following. Otherwise, the recording media may be damaged, recorded images may be impossible to play back or may be lost, or other malfunctions could occur.
 - ejecting the memory card when the access lamp (p. 25) is lit or flashing
 - removing the battery pack or AC Adaptor from the camcorder, or applying mechanical shock or vibration to the camcorder when the  (Movie)/  (Photo) lamps (p. 27) or the access lamp (p. 25) are lit or flashing
- When the camcorder is connected to other devices through a USB connection and the power of the camcorder is turned on, do not close the LCD panel. The image data that has been recorded may be lost.
- Use the camcorder in accordance with local regulations.

LCD Panel , viewfinder (HDR-CX760V/ PJ760/PJ760V)

- The LCD screen and viewfinder (HDR-CX760V/PJ760/PJ760V) are manufactured using extremely high-precision technology, so over 99.99% of the pixels are operational for effective use. However, there may be some tiny black points and/or bright points (white, red, blue, or green in color) that appear constantly on the LCD screen. These points are normal results of the manufacturing process and do not affect the recording in any way.

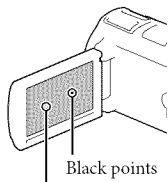

White, red, blue or green points

About this manual, illustrations and on-screen displays

- The example images used in this manual for illustration purposes are captured using a digital still camera, and therefore may appear different from images and screen indicators that actually appear on your camcorder. And, the illustrations of your camcorder and its screen indication are exaggerated or simplified for understandability.
- Design and specifications of your camcorder and accessories are subject to change without notice.
- In this manual, the internal memory of the camcorder and the memory card are called "recording media."
- In this manual, the DVD disc recorded with high definition image quality (HD) is called AVCHD recording disc.

- The model name is shown in this manual when there is a difference in specification between models. Confirm the model name on the bottom of your camcorder.
- Illustrations used in this manual are based on HDR-PJ760V unless otherwise specified.

	Capacity of internal memory	Projector	viewfinder
HDR-PJ710/ PJ710V*	32 GB	✓	—
HDR-CX760V*	96 GB	—	✓
HDR-PJ760V*/ PJ760	96 GB	✓	✓

The model with * is equipped with GPS.

Learning more about the camcorder ("Handycam" User Guide)

"Handycam" User Guide is an on-line manual. Refer to it for in-depth instructions on the many functions of the camcorder.

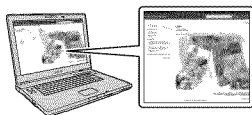

- 1 Access the Sony support page.
<http://www.sony.net/SonyInfo/Support/>
 - 2 Select your country or region.
 - 3 Search for the model name of your camcorder within the support page.
- Check the model name on the bottom of your camcorder

Table of contents

IMPORTANT SAFETY INSTRUCTIONS	3
Read this first	6
Learning more about the camcorder (“Handycam” User Guide)	9
Parts and controls.....	13

Getting started

Supplied Items.....	17
Charging the battery pack	18
Charging the battery using your computer	19
Charging the battery pack abroad	21
Turning the power on, and setting the date and time.....	22
Changing the language setting.....	22
Preparing the recording media	25
Selecting a recording medium.....	25
Inserting a memory card	25

Recording/Playback

Recording.....	27
Recording movies	27
Shooting photos	27
Zooming.....	30
Playback	32
Playing movies and photos from a map (HDR-CX760V/PJ710V/PJ760V).....	33
Operating buttons while playing.....	35

Advanced operations

Recording people clearly	37
Recording the selected subject clearly (Face Priority).....	37
Recording voices clearly (Closer Voice).....	37
Capturing smiles automatically (Smile Shutter)	38
Recording movies in various situations.....	38
Selecting the suitable setting automatically for the recording situation (Intelligent Auto).....	38
Reducing camera-shake ( SteadyShot).....	39
Recording in dark places (NightShot).....	39
Recording movies in dim places (Video Light).....	40

Recording images with the selected image quality.....	41
Selecting the image quality of movies (Recording mode)	41
Changing the image quality of photos.....	42
Using the manual adjustment features.....	42
Shooting images with the iris priority mode.....	42
Shooting images with the Shutter Speed priority mode	43
Controlling the image settings manually with the MANUAL dial	43
Recording information on your location (GPS) (HDR-CX760V/PJ710V/PJ760V)	44
Obtaining a map of the current location (triangulating priority mode)	45
Checking the triangulating status.....	46
Enjoying a digest of your movies (Highlight Playback).....	48
Saving Highlight Playback in HD image quality ( Scenario Save).....	49
Converting the data format to STD image quality (Highlight Movie)	49
Playing images on a TV	50
Enjoying 5.1ch surround sound.....	51
Using the built-in projector (HDR-PJ710/PJ710V/PJ760/PJ760V)	52

Editing

Editing on your camcorder.....	54
Deleting movies and photos	54
Dividing a movie.....	54
Capturing a photo from a movie	55

Saving movies and photos with a computer

Useful functions available when connecting the camcorder to your computer	56
For Windows	56
For Mac	56
Preparing a computer (Windows)	57
Step 1 Checking the computer system.....	57
Step 2 Installing the built-in "PlayMemories Home" software.....	57
Starting the "PlayMemories Home" software.....	60
Downloading the dedicated software for the camcorder	60
Installing Music Transfer.....	60
Installing software for a Mac	60

Saving images with an external device

Dubbing guide	61
The devices on which the created disc can be played back.....	62
Creating a disc with the DVD writer or recorder	63
Creating a disc with DVDDirect Express	63
Creating a high definition image quality (HD) disc with a DVD writer	64
Creating a standard definition image quality (STD) disc with a recorder, etc.....	64
Saving images on an external media device	66

Customizing your camcorder

Using menus	68
Menu lists.....	70

Others/Index

Troubleshooting	74
Self-diagnosis display/Warning indicators.....	75
Recording time of movies/number of recordable photos	77
Expected time of recording and playback with each battery pack.....	77
Expected recording time of movies.....	78
Expected number of recordable photos	79
About handling of your camcorder	81
Specifications	86
END-USER LICENSE AGREEMENT FOR MAP DATA FOR VIDEO CAMERA RECORDER PRODUCTS (HDR-CX760V/PJ710V/PJ760V)	89
Screen indicators.....	92
Index.....	94

Parts and controls

Figures in () are reference pages.

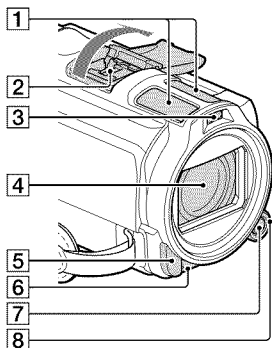

1 Built-in microphone

2 Active Interface Shoe



3 Flash/Video light

4 Lens (Carl Zeiss lens)

5 Remote sensor/Infrared port

6 Camera recording lamp (72)

The camera recording lamp lights up in red during recording. The lamp flashes when the remaining recording media capacity or battery power is low.

7 MANUAL button (43)

8 MANUAL dial (43)

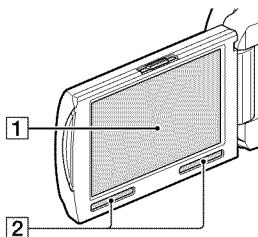

HDR-CX760V

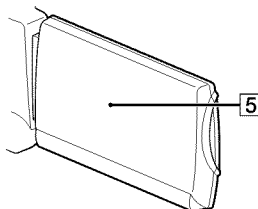

HDR-PJ710/PJ710V/PJ760/PJ760V

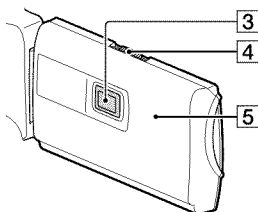

1 LCD screen/Touch panel (22, 24)

If you rotate the LCD panel 180 degrees, you can close the LCD panel with the LCD screen facing out. This is convenient during playback operations.

2 Speakers

3 Projector lens (52)

4 PROJECTOR FOCUS lever (52)

5 GPS antenna (HDR-CX760V/PJ710V/PJ760V)

A GPS antenna is located in the LCD panel.

HDR-PJ710/PJ710V

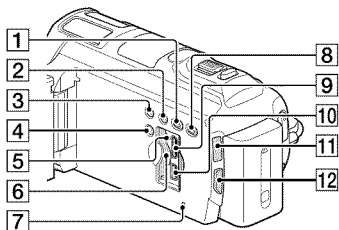

Press RESET using a pointed object.

Press RESET to initialize all the settings including the clock setting.

- 8 PROJECTOR button (52) (HDR-PJ710/PJ710V/PJ760/PJ760V)
 - 9 HDMI OUT jack (50)
 - 10 USB jack (63, 66)
 - 11 (Movie) / (Photo) lamp (27)
 - 12 MODE button
-

HDR-CX760V

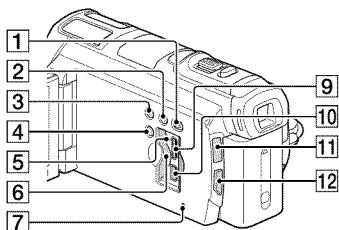

HDR-PJ710/PJ710V

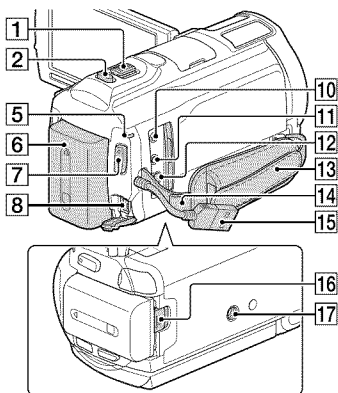

HDR-PJ760/PJ760V

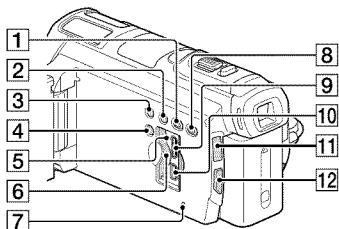

- 1 (View Images) button
- 2 LIGHT (Video Light) button (40)
- 3 NIGHTSHOT button (39)
- 4 POWER button
- 5 Memory card access lamp (25)
While the lamp is lit or flashing, the camcorder is reading or writing data.
- 6 Memory card slot (25)
- 7 RESET button

HDR-CX760V/PJ760/PJ760V

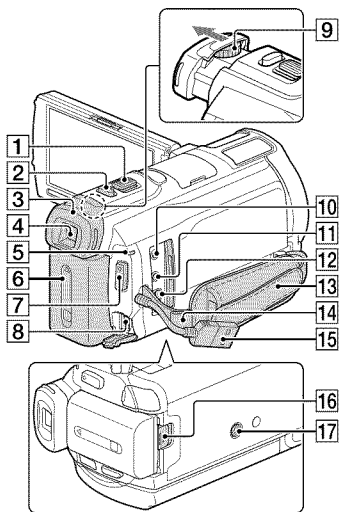

- 1 Power zoom lever (30)
- 2 PHOTO button (27)
- 3 Eyecup
- 4 Viewfinder (23)
- 5 CHG (charge) lamp (18)
- 6 Battery pack (18)
- 7 START/STOP button (27)
- 8 DC IN jack (18)
- 9 Viewfinder lens adjustment lever (23)
- 10 (microphone) jack (PLUG IN POWER)
- 11 (headphones) jack
- 12 A/V Remote Connector (50)
- 13 Grip belt
- 14 Loop for a shoulder belt
- 15 Built-in USB Cable (19)
- 16 BATT (battery) release lever (20)
- 17 Tripod receptacle

Attach a tripod (sold separately; the length of the screw must be less than 5.5 mm (7/32 in.)).

To fasten the grip belt

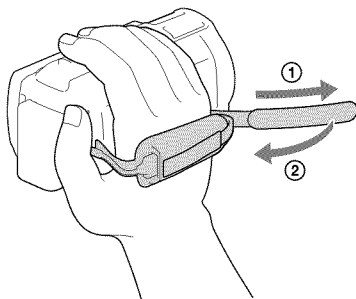

To attach the lens hood

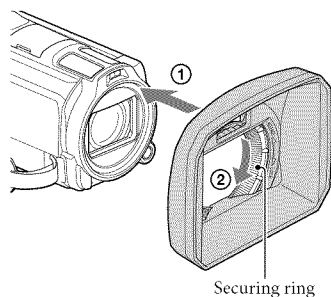

Align the lens hood with the camcorder properly (①), then turn the securing ring of the lens hood in the direction of the arrow (②).

- When attaching the lens hood, align the opening section of the lens hood with the flash-emitting section of the camcorder properly.
- To remove the lens hood, turn the securing ring of the lens hood in the opposite direction from that of the arrow.
- Remove the lens hood when you record movies using the NightShot function. If you do not do so, the shadow of the lens hood will be reflected and recorded in your movies.
- Remove the lens hood when you operate the camcorder with the supplied remote commander.

To attach the Step Down Ring

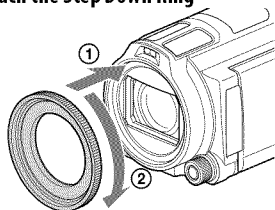

Align the Step Down Ring with the camcorder properly (①), then turn it in the direction of the arrow until the Step Down Ring is locked in place (②).

- You can change to the filter diameter to 37mm (1 1/2 in.) by attaching the Step Down Ring, allowing you to use the recommended conversion lens.
- You cannot attach the wide end conversion lens/filter, if the Step Down Ring is attached.
- To remove Step Down Ring, turn it in the opposite direction from that of the arrow.

Wireless Remote Commander

The wireless remote commander is useful when you use the projector (HDR-PJ710/PJ710V/PJ760/PJ760V).

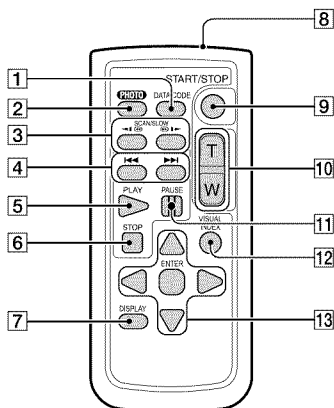

- 1 DATA CODE button (72)**
Displays the date and time, camera setting data, or coordinates (HDR-CX760V/PJ710V/PJ760V) of the recorded images when you press this button during playback.
- 2 PHOTO button (27)**
The on-screen image when you press this button will be recorded as a still image.
- 3 SCAN/SLOW buttons (35)**
- 4 ◀◀/▶▶ (Previous/Next) buttons (35)**
- 5 PLAY button**
- 6 STOP button**
- 7 DISPLAY button (28)**
- 8 Transmitter**
- 9 START/STOP button (27)**
- 10 Power zoom buttons**
- 11 PAUSE button**
- 12 VISUAL INDEX button (32)**
Displays an Index screen during playback.
- 13 ◀/▶/▲/▼/ENTER buttons**

When you press any of these buttons, the light blue frame appears on the LCD screen. Select a desired button or an item with ◀/▶/▲/▼, then press ENTER to enter.

Getting started

Supplied Items

The numbers in () are the supplied quantity.

Camcorder (1)

AC Adaptor (1)

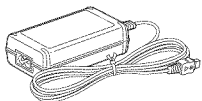

Power cord (Mains lead) (1)

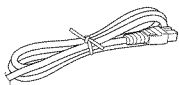

HDMI cable (1)

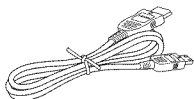

A/V connecting cable (1)



USB connection support cable (1)

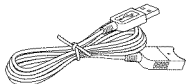

- The USB connection support cable is designed for use with this camcorder only. Use this cable when the Built-in USB Cable of the camcorder (p. 19) is too short for connection.

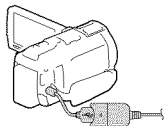

Lens hood (1)



Step Down Ring (1)



Wireless Remote Commander (1)



Rechargeable battery pack NP-FV50 (1)

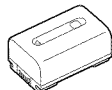

"Operating Guide" (This manual) (1)

Notes

- The "PlayMemories Home" (Lite Version) software and "PlayMemories Home Help Guide" are pre-installed in this camcorder (p 57, p 60).

Charging the battery pack

- 1 Close the LCD screen after replacing the viewfinder (HDR-CX760V/PJ760/PJ760V) and attach the battery pack.

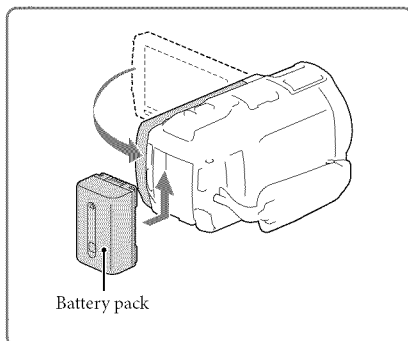

- 2 Connect the AC Adaptor (①) and the power cord (mains lead) (②) to your camcorder and the wall outlet (wall socket).

- The CHG (charge) lamp turns on.
- The CHG (charge) lamp turns off when the battery pack is fully charged. Disconnect the AC Adaptor from the DC IN jack of your camcorder.

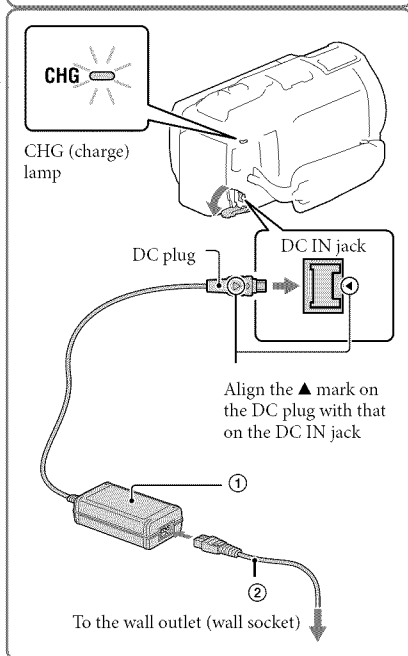

Notes

- You cannot attach any "InfoLITHIUM" battery pack other than the V series to your camcorder.

Charging the battery using your computer

Turn off your camcorder and connect the camcorder to a running computer using the Built-in USB Cable.

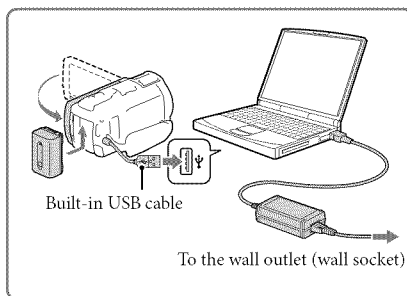

To charge the battery from a wall outlet (wall socket) using the Built-in USB Cable

You can charge the battery by connecting the Built-in USB Cable to a wall outlet (wall socket) using an AC-UD10 USB charger/AC Adaptor (sold separately). You cannot use a Sony CP-AH2R, CP-AL, or AC-UP100 portable power supply device (sold separately) to charge the camcorder.

Charging time

Approximate time (min.) required when you fully charge a fully discharged battery pack.

Battery pack	Charging time	
	AC Adaptor	Built-in USB Cable* (when using your computer)
NP-FV50 (supplied)	155	280
NP-FV70	195	545
NP-FV100	390	1,000

- The charging times shown in the table above are measured when charging the camcorder at a temperature of 25 °C (77 °F). It is recommended that you charge the battery in a temperature range of 10 °C to 30 °C (50 °F to 86 °F).

* The charging times are measured without using the USB connection support cable.

To remove the battery pack

Close the LCD screen. Slide the BATT (battery) release lever (①) and remove the battery pack (②).

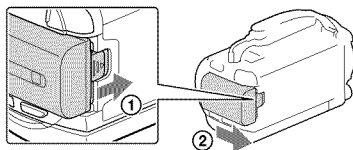



To use a wall outlet (wall socket) as a power source

Make the same connections as those for charging the battery pack.

Even if the battery pack is attached, the battery pack is not discharged.

Notes on the battery pack

- When you remove the battery pack or disconnect the AC Adaptor, turn the camcorder off and make sure that the  (Movie)/ (Photo) lamps (p. 27) and the access lamp (p. 25) are turned off.
- The CHG (charge) lamp flashes during charging under the following conditions:
 - The battery pack is not attached correctly.
 - The battery pack is damaged.
 - The temperature of the battery pack is low.
Remove the battery pack from your camcorder and put it in a warm place.
 - The temperature of the battery pack is high.
Remove the battery pack from your camcorder and put it in a cool place.
- When attaching a video light (sold separately), it is recommended that you use an NP-FV70 or NP-FV100 battery pack.
- You cannot use the NP-FV30 “InfoLITHIUM” battery pack with your camcorder.
- In the default setting, the power turns off automatically if you leave your camcorder without any operation for about 2 minutes, to save battery power ([Eco Mode] p. 73).

Notes on the AC Adaptor

- Use the nearby wall outlet (wall socket) when using the AC Adaptor. Disconnect the AC Adaptor from the wall outlet (wall socket) immediately if any malfunction occurs while using your camcorder.
- Do not use the AC Adaptor placed in a narrow space, such as between a wall and furniture.
- Do not short-circuit the DC plug of the AC Adaptor or battery terminal with any metallic objects. This may cause a malfunction.
- Disconnect the AC Adaptor from the camcorder, holding both the camcorder and the DC plug.



- Recording time, Playing time (p. 77)
- Remaining battery indicator (p. 28)
- Charging the battery pack abroad (p. 21)

Charging the battery pack abroad

You can charge the battery pack in any countries/regions using the AC Adaptor supplied with your camcorder within the AC 100 V - 240 V, 50 Hz/60 Hz range. Do not use an electronic voltage transformer.

Turning the power on, and setting the date and time

1 Open the LCD screen of your camcorder and turn the power on.

- You can also turn on the camcorder by pressing POWER (p. 14).

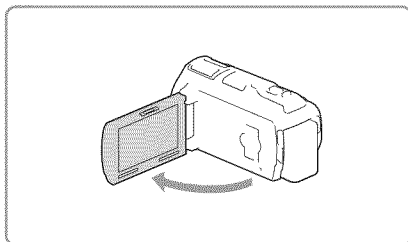

2 Select the desired language, then select [Next].

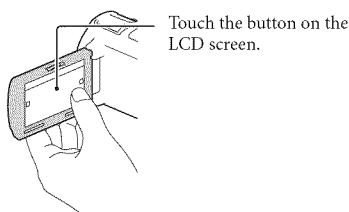

3 Select the desired geographical area with [Left]/[Right], then select [Next].

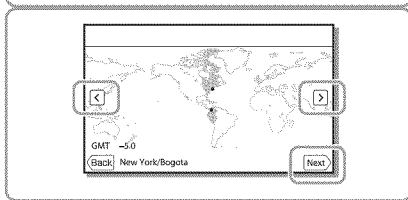

4 Set [Daylight Savings] or [Summer Time], select the date format and the date and time.

- If you set [Daylight Savings] or [Summer Time] to [On], the clock advances 1 hour.
- When you select the date and time, select one of the items and adjust the value with [Up]/[Down].
- When you select [OK], the date and time setting operation is complete.

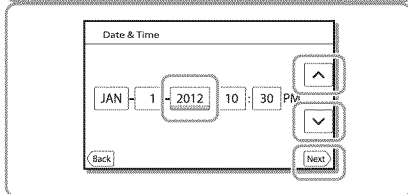

Changing the language setting

You can change the on-screen displays to show messages in a specified language. Select [MENU] → [Setup] → [General Settings] → [Language Setting] → a desired language.

To turn off the power

Close the LCD screen or press the POWER button (p. 14).

If the viewfinder is pulled out, retract the viewfinder as shown in the illustration on the right (HDR-CX760V/PJ760/PJ760V).

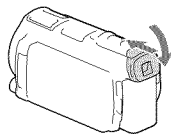

On turning the camcorder on or off using the LCD screen or the viewfinder (HDR-CX760V/PJ760/PJ760V)

The power of the camcorder is turned on or off depending on the status of the LCD screen or the viewfinder.

Status		Power of the camcorder
LCD screen	Viewfinder	
Open	Retracted	On
	Pulled out	On
Closed	Retracted	Off
	Pulled out	On

Notes

- Even if the LCD screen is closed, if the viewfinder is pulled out, the camcorder is not turned off. When you turn off the power of the camcorder, make sure that the viewfinder is retracted to the original position.

When you make recording with the viewfinder only (HDR-CX760V/PJ760/PJ760V)

Pull out the viewfinder (①) and close the LCD panel and then adjust the angle you want (②). If the indicator on the viewfinder appears blurred, adjust the appearance using the viewfinder lens adjustment lever located on the above of the viewfinder.

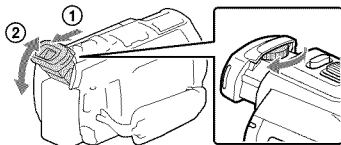

To adjust the angle of the LCD panel

First open the LCD panel 90 degrees to the camcorder (①), and then adjust the angle (②).

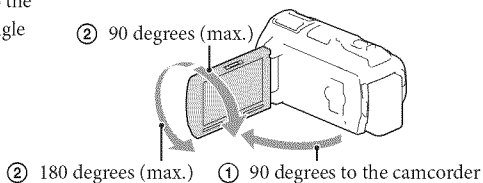

To turn off the beep sound

Select [MENU] → [Setup] → [General Settings] → [Beep] → [Off].

Notes

- The recording date, time and condition, and coordinates (HDR-CX760V/PJ710V/PJ760V) are recorded automatically on the recording media. They are not displayed during recording. However, you can check them as [Data Code] during playback. To display them, select [MENU] → [Setup] → [▶ Playback Settings] → [Data Code] → [Date/Time].
- Once the clock is set, the clock time is automatically adjusted with [Auto Clock ADJ] and [Auto Area ADJ] set to [On]. The clock may not be adjusted to the correct time automatically, depending on the country/region selected for your camcorder. In this case, set [Auto Clock ADJ] and [Auto Area ADJ] to [Off] (HDR-CX760V/PJ710V/PJ760V).



- [Power On By LCD] (HDR-PJ710/PJ710V) (p. 72)
- To set the date and time again: [Date & Time Setting] (p. 73)
- To calibrate the touch panel: [Calibration] (p. 84)

Preparing the recording media

The recording media that can be used are displayed on the screen of your camcorder as following icons.

Default recording medium



Internal memory

Alternative recording medium



Memory card

Notes

- You cannot select a different recording medium for movies and for photos.

Selecting a recording medium

Select [MENU] → [Setup] → [Media Settings] → [Media Select] → the desired medium.

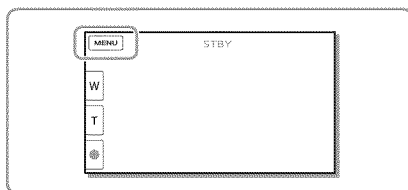

Inserting a memory card

Open the cover, and insert the memory card until it clicks.

- The [Preparing image database file. Please wait.] screen appears if you insert a new memory card. Wait until the screen disappears.

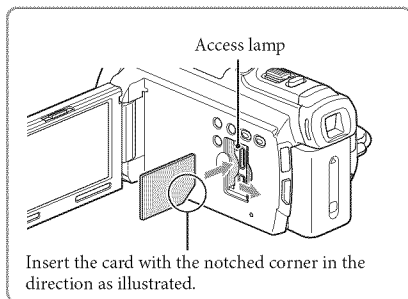

To eject the memory card

Open the cover and lightly push the memory card in once.

Notes

- To ensure stable operation of the memory card, it is recommended to format the memory card with your camcorder before the first use (p. 72). Formatting the memory card will erase all the data stored on it and the data will be irrecoverable. Save your important data on your PC, etc.
- If [Failed to create a new Image Database File. It may be possible that there is not enough free space.] is displayed, format the memory card (p. 72).
- Confirm the direction of the memory card. If you forcibly insert the memory card in the wrong direction, the memory card, memory card slot, or image data may be damaged.
- When inserting or ejecting the memory card, be careful so that the memory card does not pop out and drop.

Types of memory card you can use with your camcorder

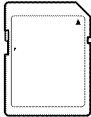
		SD Speed Class	Capacity (operation verified)	Described in this manual
“Memory Stick PRO Duo” media (Mark2)		—	Up to 32 GB	“Memory Stick PRO Duo” media
“Memory Stick PRO-HG Duo” media				
SD memory card		Class 4 or faster	Up to 64 GB	SD card
SDHC memory card				
SDXC memory card				

- Operation with all memory cards is not assured.

Notes

- A MultiMediaCard cannot be used with this camcorder.
- Movies recorded on SDXC memory cards cannot be imported to or played back on computers or AV devices not supporting the exFAT* file system by connecting the camcorder to these devices with the USB cable. Confirm in advance that the connecting equipment is supporting the exFAT system. If you connect an equipment not supporting the exFAT system and the format screen appears, do not perform the format. All the data recorded will be lost.

* The exFAT is a file system that is used for SDXC memory cards.



- Recording/playback/editing media: Screen indicators during recording (p. 93)
- Recording time of movies/number of recordable photos (p. 77)

Recording

In the default setting, movies and photos are recorded on the internal memory. Movies are recorded with high definition image quality (HD).

Recording movies

- 1 Open the LCD screen and press **MODE** to turn on the  (Movie) lamp.

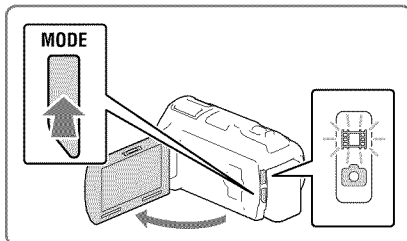

- 2 Press **START/STOP** to start recording.

- To stop recording, press **START/STOP** again.
- You can record photos during movie recording by pressing **PHOTO** (Dual Capture).

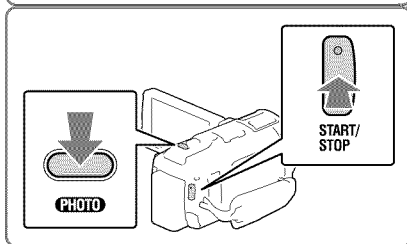

Shooting photos

- 1 Open the LCD screen and press **MODE** to turn on the  (Photo) lamp.

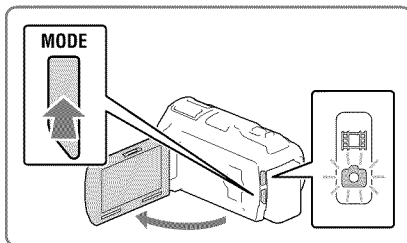

2 Press PHOTO lightly to adjust the focus, then press it fully.

- When the focus is adjusted properly, AE/AF lock indicator appears on the LCD screen.

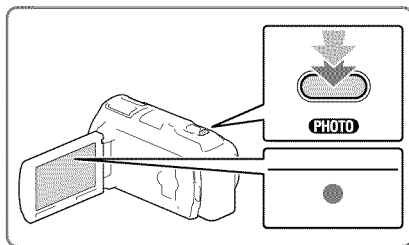

To display items on the LCD screen

Items on the LCD screen disappear if you do not operate the camcorder for a few seconds after you turn the camcorder on or switch between the movie recording and photo shooting modes.

Touch anywhere except the buttons on the LCD screen to display information on icons with functions convenient for recording.

Screen indicators during recording

Described here are icons for both movie recording and photo recording modes. Refer to the page in () for details.

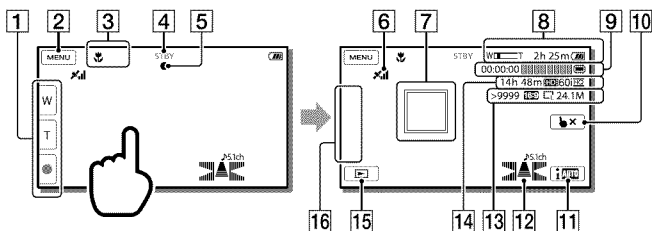

- 1 Zoom button (W: Wide/T: Telephoto), START/STOP button (in movie recording mode), PHOTO button (in photo recording mode)
- 2 MENU button (68)
- 3 Status detected by Intelligent Auto (38)
- 4 Recording status ([STBY]/[REC])
- 5 AE/AF (automatic exposure/automatic focus) lock (28)
- 6 GPS triangulating status* (45)

- 7 Tracking focus (37)
- 8 Zoom, Remaining battery
- 9 Counter (hour: minute: second), Capturing a photo, Recording/playback/editing media (93)
- 10 Tracking focus cancel button (37)
- 11 Intelligent Auto button (38)
- 12 Audio mode (71), Audio Level Display (71)
- 13 Approximate number of recordable photos, Aspect ratio (16:9 or 4:3), Photo size (L/M/S)
- 14 Estimated recording remaining time, Recording image quality (HD/STD), Frame rate (60p/60i/24p) and recording mode (PS/FX/FH/HQ/LP) (41)
- 15 View Images button (32)
- 16 My Button (you can assign your favorite functions to icons displayed in this area) (71)

* HDR-CX760V/PJ710V/PJ760V

To record in mirror mode

Open the LCD panel 90 degrees to the camcorder (①), then rotate it 180 degrees to the lens side (②).

A mirror-image of the subject appears on the LCD screen, but the image will be normal when recorded.

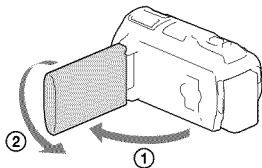

If white circular spots appear on photos

This is caused by particles (dust, pollen, etc.) floating close to the lens. When they are accentuated by the camcorder's flash, they appear as white circular spots. To reduce the white circular spots, light the room and shoot the subject without a flash.

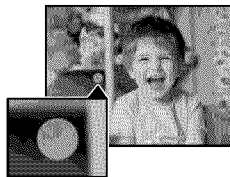

Notes

- If you close the LCD screen while recording movies, the camcorder stops recording.
- The maximum continuous recordable time of movies is about 13 hours.
- When a movie file exceeds 2 GB, the next movie file is created automatically.
- The flash does not work while the  (movie) lamp is lit.

- The following states will be indicated if data is still being written onto the recording media after recording has finished. During this time, do not apply shock or vibration to the camcorder, or remove the battery or AC Adaptor.
 - Access lamp (p. 25) is lit or flashing
 - The media icon in the upper right of the LCD screen is flashing
- When [Frame Rate] is set to [24p], you cannot record photos while the camcorder is in movie recording mode.
- The LCD screen of your camcorder can display recording images across the entire screen (full pixel display). However, this may cause slight trimming of the top, bottom, right, and left edges of images when played back on a TV which is not compatible with full pixel display. It is recommended you record images with [Guide Frame] set to [On] and using the outer frame of [Guide Frame] (p. 71) as a guide.



- Recording time, recordable number of photos (p. 77)
- [Media Select] (p. 25)
- [Flash] (p. 71)
- To display items on the LCD screen all the time: [Display Setting] (p. 71)
- To change the image size: [Image Size] (p. 42)
- Recordable time, remaining capacity [Media Info] (p. 72)

Zooming

Move the power zoom lever to magnify or reduce the size of the image.

W (Wide angle): Wider range of view

T (Telephoto): Close view

- You can magnify images up to 17 times (Extended Zoom) the original size with the power zoom lever.
- Move the power zoom lever slightly for a slower zoom. Move it further for a faster zoom.

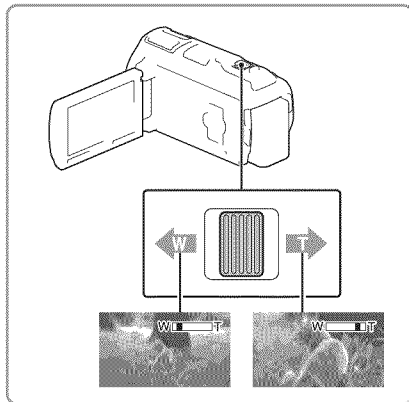

Notes

- Be sure to keep your finger on the power zoom lever. If you move your finger off the power zoom lever, the operation sound of the power zoom lever may also be recorded.
- You cannot change the zoom speed with the [Zoom] button on the LCD screen.
- The minimum possible distance between camcorder and subject while maintaining sharp focus is about 1 cm (about 13/32 in.) for wide angle and about 80 cm (about 31 1/2 in.) for telephoto.

- You can magnify images up to 10 times using optical zooming in the following cases:
 - When [SteadyShot] is set to other than [Active]
 - When the  (Photo) is lit



- Further zooming: [Digital Zoom] (p. 70)



Playback

You can search for recorded images by date and time of recording (Event view) or location of recording (Map view) (HDR-CX760V/PJ710V/PJ760V).

- 1 Open the LCD screen and press the  button on the camcorder to enter the playback mode.

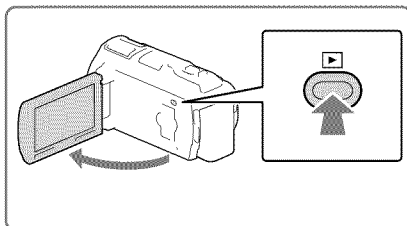
- You can enter the playback mode by selecting  on the LCD screen (p. 28).



- 2 Select / to move the desired event to the center (①) and then select it (②).

- The camcorder displays recorded images as an event automatically, based on the date and time.

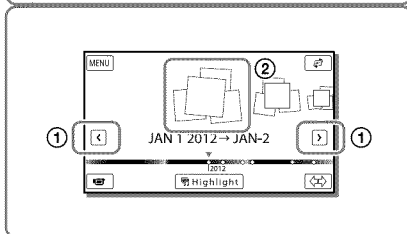

- 3 Select the image.

- The camcorder plays from the selected image to the last image in the event.

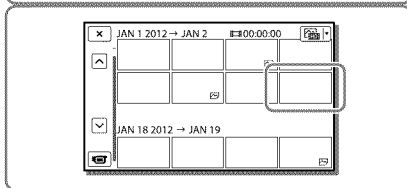

Screen display on the Event View screen

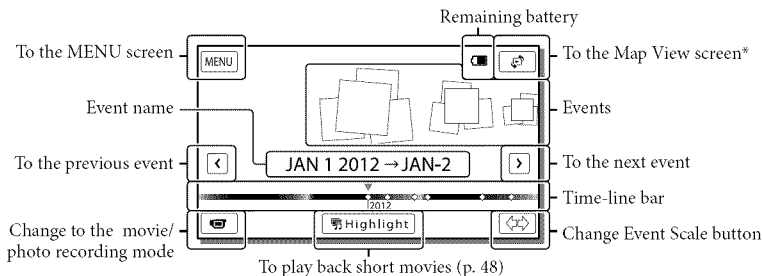

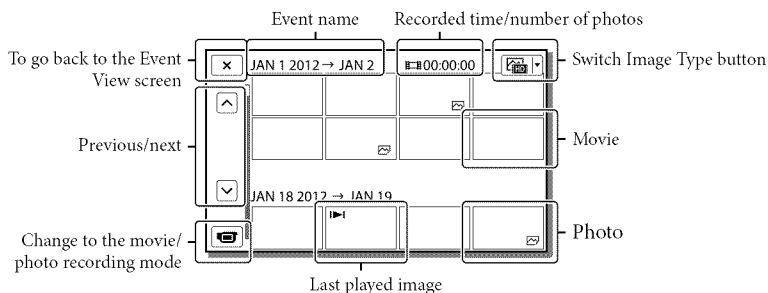

- Reduced-size images which enable you to view many images at the same time on an index screen are called “thumbnails.”

Notes

- To prevent your image data from being lost, save all your recorded images on external media periodically. (p. 61)
- In the default setting, a protected demonstration movie is pre-recorded.

Playing movies and photos from a map (HDR-CX760V/PJ710V/PJ760V)

- 1 Switch to the Map View by touching  → [Map View].

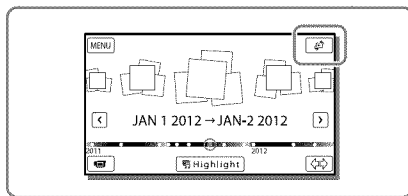

- 2 Select the recording location.

- Touch the direction on the map in which you want the map to be scrolled. Keep touching that point to scroll the map continuously.
- If you change the map scale using the power zoom lever, the clusters of thumbnails will change as well.

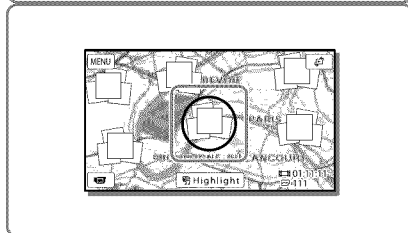

3 Select the desired image.

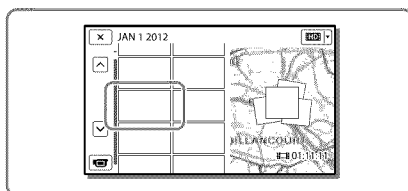

When you use the map data for the first time

A message appears asking you to confirm whether you agree with the terms of the license agreement of the map data. You can use the map data by touching [Yes] on the screen after agreeing to the terms of the license agreement (p 89).

You cannot use the map data if you touch [No]. However, when you try to use the map data for the second time, the same message will appear on the screen, and you can use the map data by touching [Yes].

Screen display on the Map View

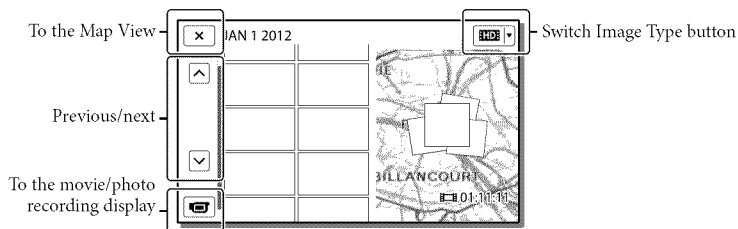
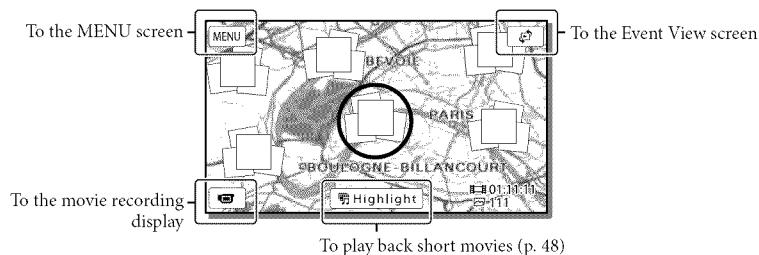

Operating buttons while playing

Items on the LCD screen disappear if you do not attempt to operate the camcorder for a few seconds. To display the items again, touch the LCD screen.

While playing a movie

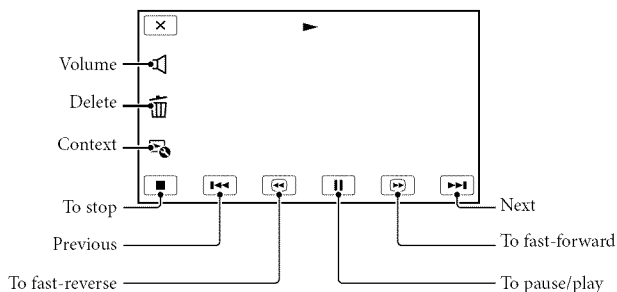

While viewing photos



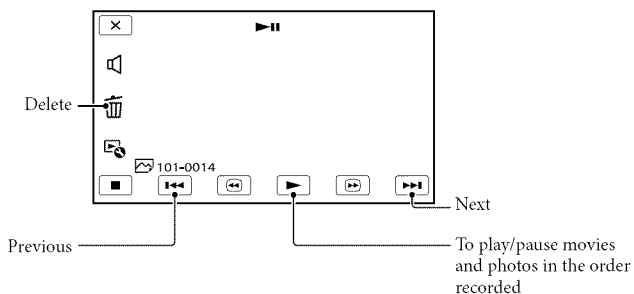

Operating buttons while viewing photos will be changed depends on the setting of Switch Image Type button (p. 33).

📷 (Movie/photo) (default setting)

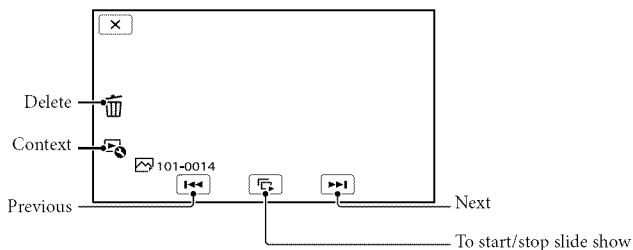

 (photo)



- As you repeat selecting /  during playback, movies are played as fast as about 5 times → about 10 times → about 30 times → about 60 times.
- Select /  during pause to play movies slowly.
- To repeat Slideshow, select  → [Slideshow Set].

To play back images with other devices

- You may not be able to play back normally images recorded on your camcorder with other devices. Also, you may not be able to play back images recorded on other devices with your camcorder.
- Standard definition image quality (STD) movies recorded on SD memory cards cannot be played on AV equipment of other manufacturers.

Recording people clearly

Recording the selected subject clearly (Face Priority)

Your camcorder can track a face you select and adjust the focus, exposure, and skin tone of the face automatically. Touch one of the faces targeted.

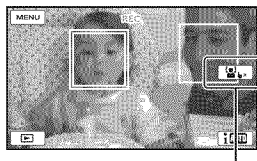
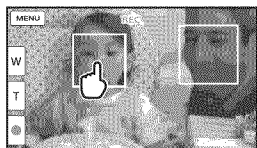

The double-lined frame Release selection is displayed.

Notes

- The subject you touched may not be detected, depending on the surrounding brightness or hairstyle of the subject.
- Make sure to set the [Face Detection] setting to other than [Off] ([Auto] is the default setting).

To record subjects other than people (Tracking focus)

Touch the subject you want to record. Your camcorder adjusts the focus automatically.

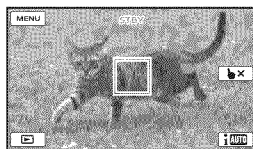
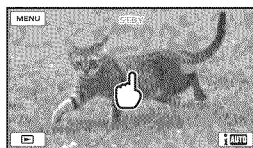

Recording voices clearly (Closer Voice)

Your camcorder detects the face of a person and records the voice clearly. ([On] is the default setting.)

- 1 Select **MENU** → [Camera/Mic] → [Microphone] → [Closer Voice].
- 2 Select the desired item.

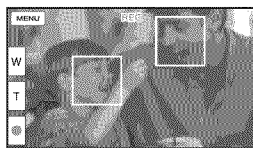

Notes

- If you select [Off], **OFF** appears on the LCD screen.
- [Closer Voice] will not function while an external microphone is attached to your camcorder.

- When you want to record the sound clearly without any interference, such as when you record a music concert, set [Closer Voice] to [Off].



- [Face Detection] (p. 71)

Capturing smiles automatically (Smile Shutter)

A photo is recorded automatically when the camcorder detects the smile of a person during movie recording (p. 71). ([Dual Capture] is the default setting.)

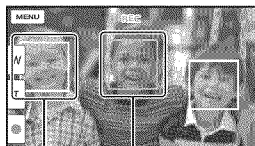

The camcorder is detecting a smile (orange).

The camcorder is detecting a face.

Notes

- When the frame rate and the recording mode are set to [60i]/[Highest Quality **FX**] or [60p]/[60p Quality **PS**], you cannot use the Smile Shutter function while recording movies. Furthermore, when the frame rate is set to [24p], you cannot use the Smile Shutter function, either.
- Smiles may not be detected depending on recording conditions, subject conditions, and the setting of your camcorder.



- [Smile Sensitivity] (p. 71)

Recording movies in various situations

Selecting the suitable setting automatically for the recording situation (Intelligent Auto)

Your camcorder records movies after selecting the most suitable setting for the subjects or the situation automatically. ([On] is the default setting.) When the camcorder detects a subject, the icons that correspond to the detected conditions are displayed.

Select → [On] → at the right bottom of the recording screen of movies or photos.



Face detection:

The camcorder detects faces, and adjusts the focus, color and exposure.

(Portrait), (Baby)

Scene detection:

The camcorder selects the most effective setting automatically, depending on the scene.

(Backlight), (Landscape), (Night Scene), (Spotlight), (Low light), (Macro)

Camera-shake detection:

The camcorder detects whether camera-shake occurs or not, and makes the optimum compensation.

(Walk), (Tripod)



Sound detection:

The camcorder detects and suppresses the wind noise so that the voice of a person or the surrounding sound can be recorded clearly.

 (Auto Wind NR)

- To cancel the Intelligent Auto function, select  → [Off].

To record images brighter than those recorded using the Intelligent Auto function



Select  → [Camera/Mic] →
[ Manual Settings] → [Low Lux].

Notes

- The camcorder may not detect the expected scene or subject, depending on the recording conditions.

Reducing camera-shake ()

The camcorder has a balanced SteadyShot function that allows you to reduce the camera-shake when shooting with zooming, as well as when shooting with a wide-angle shot. ([Active] is the default setting.)

- Select  → [Camera/Mic] →
[ Camera Settings] →
[ SteadyShot].
- Select the desired item.

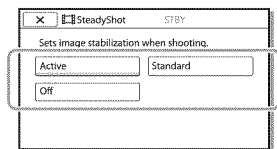

Active:

In addition to the balanced SteadyShot function, the camcorder compensates for camera-shake in the vertical and horizontal directions.



Standard:

The camcorder reduces camera-shake using the balanced SteadyShot function in wide-angle shooting.

Off:

The camcorder does not use the balanced SteadyShot function.

Notes

- The angle of view will be changed after changing the settings of the [ SteadyShot] function.
- You can magnify images up to 10 times using optical zooming in the following cases:
 - When [ SteadyShot] is set to other than [Active]
 - When the  (Photo) is lit

Recording in dark places (NightShot)

You can record images even in total darkness.

Press NIGHTSHOT.

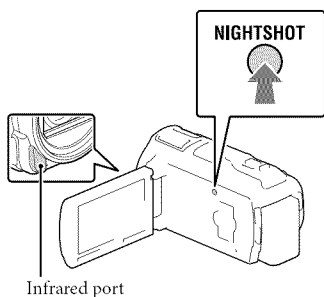

-  appears.
- To cancel the NightShot function, press NIGHTSHOT again.

Notes

- Using NightShot in bright places will cause a malfunction of your camcorder.
- Do not cover the infrared port. Infrared rays are required when using NightShot.
- When recording movies using the NightShot function, remove the lens hood (supplied), the Step Down Ring (supplied), and the conversion lens (sold separately).



- [Focus] (p. 70)
- [Low Lux] (p. 70)

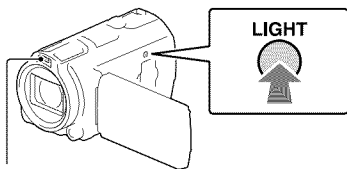

Recording movies in dim places (Video Light)

Press LIGHT.



Flash/
Video light

Each time you press the LIGHT button, the indicator changes as follows.

Off (no indicator) → Auto ( AUTO) → On () → ...

Notes

- Keep a distance of about 0.3 m to 1.5 m (1 foot to 5 feet) between the camcorder and the subject.
- The video light generates strong light. Do not use the video light directly in front of the eyes at close range.
- The battery drains quickly while using the video light.
- When you shoot photos, the video light turns off and will work as a flash.



- [Light Bright] (p. 71)

Recording images with the selected image quality

Selecting the image quality of movies (Recording mode)

You can switch the recording mode to select the movie quality when recording high definition image quality (HD) movies. The recording time (p. 78) or the type of media device to which the images can be copied may change, depending on the recording mode selected. ([Standard HQ] is the default setting.)

Notes

- [60p Quality PS] can be set only when the [Frame Rate] is set to [60p].

- 1 Select [MENU] → [Image Quality/Size] → [REC Mode].
- 2 Select the desired recording mode.

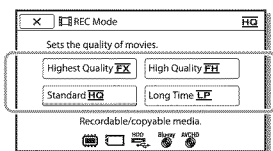

-  appears on a medium icon if a movie recorded with the selected recording mode cannot be copied on that medium.

Recording mode and the media devices to which the images can be copied

Types of media	Recording mode		
	PS*	FX	FH/HQ/LP
On this camcorder			
Internal memory	✓	✓	✓
Memory card	✓	✓	✓
On external devices			
External media (USB storage devices)	✓	✓	✓
Blu-ray discs	✓	✓	✓
AVCHD recording discs	—	—	✓

* [60p Quality PS] can be set only when the [Frame Rate] is set to [60p].

On image quality

The image quality and the bit-rate for each recording mode can be set as follows. (“M,” such as in “24M,” means “Mbps.”) For the high definition image quality (HD) movies

- [60p Quality PS]: 1920 × 1080/60p quality, AVC HD 28M (PS)
- [Highest Quality FX]: 1920 × 1080/60i or 1920 × 1080/24p quality, AVC HD 24M (FX)
- [High Quality FH]: 1920 × 1080/60i or 1920 × 1080/24p quality, AVC HD 17M (FH)
- [Standard HQ]: 1440 × 1080/60i quality, AVC HD 9M (HQ)^{*1}
- [Long Time LP]: 1440 × 1080/60i quality, AVC HD 5M (LP)

For the standard definition image quality (STD) movies

- [Standard HQ]: Standard quality, STD 9M (HQ)^{*2}

^{*1} The default setting

*2 Standard image quality (STD) is fixed to this value.



- [Frame Rate] (p. 71)
- Recording standard definition image quality (STD) movie: [/ Setting] (p. 71)
- Dubbing guide (p. 61)

Changing the image quality of photos

The number of photos you can shoot differs, depending on the image size selected.

- 1 Select **MENU** → [Image Quality/Size] → [Image Size].
- 2 Select the desired image size.

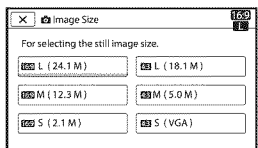

Notes

- The image size selected with this setting takes effect for photos taken by the Dual Capture function (p. 27).



- Number of recordable photos (p. 79)

Using the manual adjustment features

Shooting images with the iris priority mode

Changing IRIS parameter changes the range that is in focus.

- 1 Select **MENU** → [Camera/Mic] → [Manual Settings] → [IRIS] → [Manual].
- 2 Select **+**/**-** to adjust the iris.

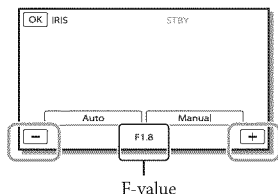

- As the F-value (aperture value) becomes smaller, the iris opens and the background blurs.

To change the atmosphere of image by the IRIS parameter

Smaller F-value (opening the iris) narrows the range that is in focus. Larger F-value (narrowing down the iris) widens the range that is in focus. Open the iris to blur the background, or narrow down the iris to sharpen the whole image.

Notes

- Even if you open the IRIS wider (a smaller F-value) than F3.4 when you set the zoom lever to the W (Wide angle) side, the IRIS is reset to F3.4 as you move the zoom lever to the T (Telephoto) side.

Shooting images with the Shutter Speed priority mode

You can express the movement of a moving subject in various way by adjusting the shutter speed. When shooting a mountain stream, for example, a splash of water will be captured clearly with high speed shutter, or a trailing image of water with low speed shutter.

- 1 Select **[MENU]** → [Camera/Mic] → **[ Manual Settings]** → [Shutter Speed] → [Manual].
- 2 Select **[+]**/**[-]** to adjust the shutter speed.

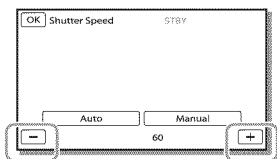

- As the value becomes smaller (slower shutter speed), a trailing image of the movement of the subject is captured.
- When you record images under a fluorescent lamp, sodium lamp, or mercury lamp horizontal stripes may appear, flicker may occur, or color may change. In this case, change the shutter speed according to the power supply frequency in your region.

Controlling the image settings manually with the MANUAL dial

It is convenient to make manual adjustments using the MANUAL dial, by assigning a menu item ([Focus] in the default setting) to the MANUAL dial.

MANUAL button

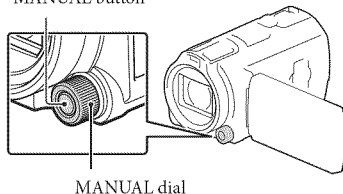

- 1 Press MANUAL to switch to manual operation mode.
 - Pressing MANUAL switches the operation mode between manual and automatic.
- 2 Rotate the dial to make the adjustment.

Items you can control with the MANUAL dial

- [Focus] (p. 70)
- [Exposure] (p. 70)
- [IRIS] (p. 70)
- [Shutter Speed] (p. 70)
- [AE Shift] (p. 70)
- [White Balance Shift] (p. 70)

To assign the menu item to the MANUAL dial

- 1 Press and hold MANUAL down for a few seconds.
- 2 Rotate the MANUAL dial and select the item to be assigned.

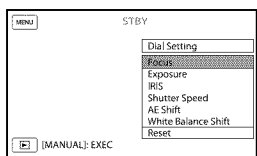

- Select [Reset] to reset the items adjusted manually to the default settings.

3 Press MANUAL.

- The camera data that appears on the LCD screen will differ, depending on the recording settings of the camcorder. The settings will be displayed with the following icons.
 - **AUTO**: Automatic
 - **MANUAL**: Exposure is set manually.
 - **AE/A**: IRIS priority
 - **AE/S**: Shutter speed priority

Notes

- Manual settings will be retained even if you change the assigned item of the MANUAL dial. However, if you set [Exposure] after setting [AE Shift] manually, [Exposure] will override [AE Shift].
- If you set either one of [Exposure], [IRIS], or [Shutter Speed], the settings of other 2 items are canceled.



- [Data Code] (p. 72)

Recording information on your location (GPS) (HDR-CX760V/PJ710V/PJ760V)

The following features are available if you use the GPS (Global Positioning System) function.

- Recording location information on movies or photos ([On] is the default setting.)

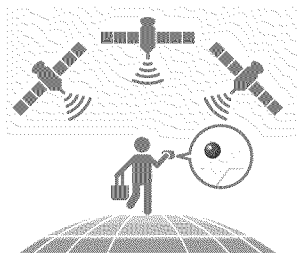

- Playing movies and photos by searching for them from a map (Map View, p. 33)

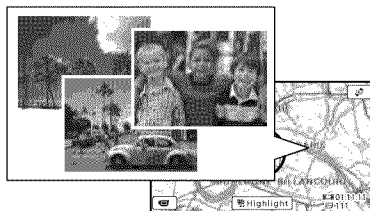

- Displaying a map of your current location



GPS triangulating status

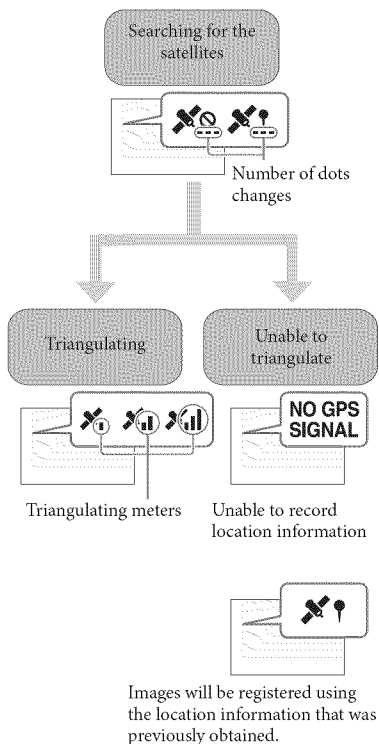

If you do not want to record location information

Select [MENU] → [Setup] → [General Settings] → [GPS Setting] → [Off].

Notes

- It may take a while before the camcorder starts triangulating.
- Use the GPS function outdoors and in open areas, as the radio signals can best be received in such areas.
- The map always displays the north at the top.

Obtaining a map of the current location (triangulating priority mode)

This feature is useful for checking a map of your current location while traveling. As the camcorder turns other functions off to search for satellites, obtaining triangulating information can take priority. Select [MENU] → [Setup] → [General Settings] → [Your Location].

A marker (red) that indicates your current location

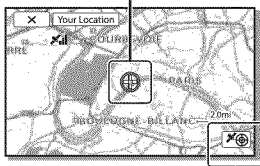

Displays the triangulating information (p. 46)

Notes

- If you select a certain point on the screen, the map shows an area with that point at the center. Select [X] to move your current location back to the center again.
- If the camcorder cannot acquire current location information, the triangulating information screen appears (p. 46).
- If the location information that was previously acquired is invalid, the marker does not appear.
- To close the current location screen, select [X].

Checking the triangulating status

The camcorder displays the status of the GPS signal reception when you are unable to obtain the triangulating information.

1 Display your current location (p. 45).

If your current location appears on the LCD screen, you do not need to continue this operation.

2 Select .

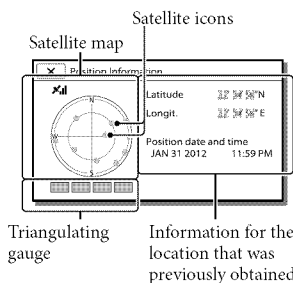
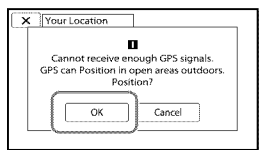

Triangulating gauge

Information for the location that was previously obtained.

- To close the triangulating information screen, select .

On the satellite map and triangulating gauge

The center of the satellite map shows your current location. You can check the direction (north/south/east/west) of the satellites with the satellite icons (●) that appear on the satellite map.

When the camcorder succeeds in triangulating your location, the triangulating gauge turns to green.

How to check the GPS satellite icons/ triangulating gauge

The color of the GPS satellite icons and the triangulating gauge change according to the current status triangulation.

GPS satellite icons/ triangulating gauge	Status
●/■ (black)	No signal, but orbit information for the satellite is available.
●/■ (gray)	Part of the satellite orbit information has been obtained.
●/■ (brown)	About a half of the satellite orbit information has been obtained.
●/■ (ocher)	Most of the satellite orbit information has been obtained.
●/■ (green)	Triangulating is completed and the satellite is currently being used.

If data on your current location cannot be obtained

A display that allows you to triangulate the location again appears. In this case, follow the instructions that appears on the LCD screen.

Hints for better reception

- Use the GPS function outdoors and in open areas.
For details on locations or situations where radio signals cannot be received, refer to the “Handycam” User Guide.
- Rotate the LCD panel to direct the GPS antenna (p. 13) towards the sky. Do not place your hand on the GPS antenna.

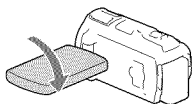

- Select [Your Location] in the menu to use the triangulating priority mode (p. 45).
- Use GPS Assist Data.

If you import GPS Assist Data from your computer to your camcorder using the built-in “PlayMemories Home” software, the time it takes the camcorder to acquire your location information can be shortened. Connect the camcorder to a computer that is connected to the Internet. The GPS Assist Data will be updated automatically.



Notes

- In the following situations, the current location of the camcorder shown on the map may be different from the actual location. The margin of error can be as wide as several hundred meters.
 - When the camcorder receives GPS signals that have been reflected off the surrounding buildings
 - When the GPS signal is too weak

- The GPS Assist Data may not function in the following cases:
 - When the GPS Assist Data are not updated for about 30 days or more
 - When the date and time of the camcorder are not correctly set
 - When the camcorder is moved for a long distance
- If you are using a Mac, you cannot import GPS Assist Data.

Enjoying a digest of your movies (Highlight Playback)

You can enjoy a digest of high definition image quality (HD) movies and photos, similar to a short movie.

- 1 Press  (View Images) (p. 32).
- 2 Display the desired event at the center of the Event View, and select [ Highlight].

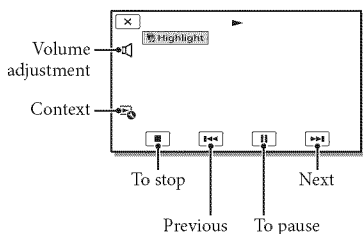
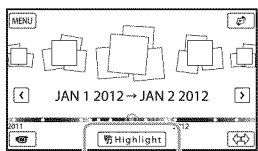

- 3 Select the desired operation when the highlight playback finishes.

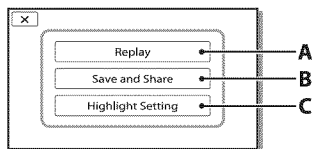

A: The camcorder plays the Highlight Playback scenes again.





B: You can save the Highlight Playback scenes in standard definition image quality (STD) and share it (upload it to the web, etc.).

C: You can change the settings for Highlight Playback.

To change the settings for Highlight Playback

You can change the Highlight Playback settings by selecting [Highlight Setting] on the screen after Highlight Playback has finished.

You can also change the setting by selecting  → [Highlight Setting] while the camcorder is playing highlight scenes.

- [Playback Range]
You can set the playback range (starting and ending date) of the Highlight Playback.
- [Theme]
You can select a theme for Highlight Playback.
- [Music]
You can select music.
- [Audio mix]
The original sound is played back with the music.
- [Length]
You can set the length of the Highlight Playback segment.
- [Highlight Point]
You can set the points in a movie or photo that will be used in a Highlight Playback. Play the desired movie, and select  → . Or play the desired photo and select .  appears on the movie or photo that is used in a Highlight Playback.
To erase the points, select  → [Clear All Points].

Notes

- Highlight Playback scenes will change each time you select a Highlight Playback.
- The [Playback Range] setting is cleared when the Highlight Playback stops.

- After the music file is transferred to the camcorder, if you cannot play the music, the music file may be damaged. Delete the music file by selecting [MENU] → [Setup] → [▶] Playback Settings] → [Empty Music], then transfer the music file again. You can restore the music data recorded on your camcorder at the default using “Music Transfer.” For operating instructions, see “Music Transfer” help.
- If the Highlight Playback function was started from the Map View screen, [Highlight Point] cannot be set. However, if the Highlight Playback function was started from the Event View screen and you set the [Highlight Point], the point can take effect on the Map View also (HDR-CX760V/PJ710V/PJ760V).
- The audio used for the Highlight Playback will be converted to 2ch stereo.
- When you connect the camcorder to an external device, such as a TV, and watch Highlight Playback or Highlight Scenario, these images do not appear on the LCD screen of the camcorder.



- Adding your desired music: “Music Transfer” (p. 60)

Saving Highlight Playback in HD image quality (Scenario Save)

You can save your favorite Highlight Playback as a “Scenario” with high definition image quality (HD). Up to 8 scenarios can be saved and these scenarios can be played on the camcorder only.

- 1 Select [Replay] on the screen after a Highlight Playback has finished.
- 2 When the Highlight Playback starts again, select [Scenario Save].

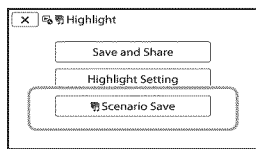

To play back a saved scenario

Select [MENU] → [Playback Function] → [Scenario], select the desired scenario, and then select [OK].

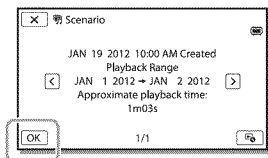

- To erase a saved scenario, select [Erase] → [Erase All] while playing the scenario.

Converting the data format to STD image quality (Highlight Movie)

You can convert the data format of Highlight Playback or Highlight Scenarios to standard definition image quality (STD) and save them as a “Highlight Movie.” Highlight movies can be used to create DVDs or be uploaded to the Web.

- 1 Select [Save and Share] on the screen after a Highlight Playback or Highlight Scenario playback has finished.
- 2 Select the desired operation when the item has been saved.

Playing images on a TV

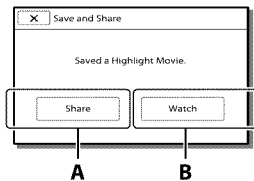

- A:** Selecting [Share] allows you to upload the Highlight movie to the Web using the built-in “PlayMemories Home” software (p. 60), or create DVDs using the “DVDirect Express” DVD writer (p. 63)
- B:** Your camcorder plays the Highlight Movie saved.

To play back a Highlight Movie

Select [MENU] → [Playback Function] → [Highlight Movie] and select the desired Highlight Movie.

- To erase a Highlight Movie, select  while the Highlight Movie is playing.

Connection methods and the image quality viewed on the TV screen differ depending on what type of TV is connected, and the connectors used.

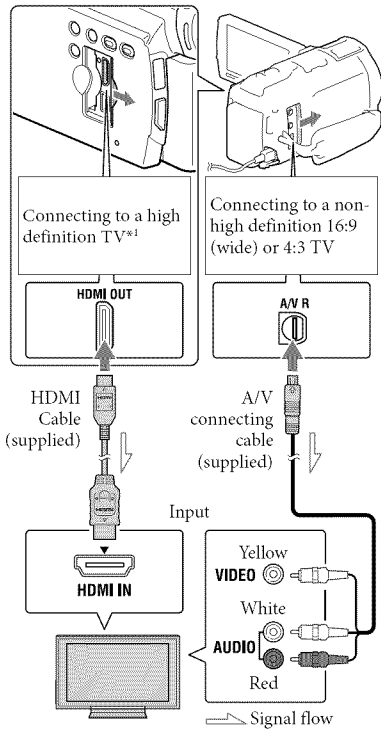

* If the TV does not have the HDMI input jack, use the A/V connecting cable for connection.

- 1 Switch the input on the TV to the connected jack.
- 2 Connect the camcorder to a TV.
- 3 Play a movie or a photo on the camcorder (p. 32).

Notes

- Refer to the instruction manuals of the TV as well.
- Use the supplied AC Adaptor as the power source (p. 20).
- When movies are recorded with standard definition image quality (STD), they are played back in standard definition image quality (STD) even on a high definition TV.
- When you play back standard definition image quality (STD) movies on a 4:3 TV that is not compatible with the 16:9 signal, set [ Wide Mode] to [4:3] to record movies with 4:3 aspect ratio.
- If you connect your camcorder to the TV using more than one type of cable to output images, HDMI output takes priority.
- The camcorder does not support the S-Video output.

Enjoying 5.1ch surround sound

You can record Dolby Digital 5.1ch surround sound with the built-in microphone. Realistic sound can be enjoyed when playing a movie on devices that support 5.1ch surround sound input.

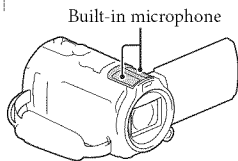
**Notes**

- If you try to play back 5.1ch sound with the speakers on your camcorder, the 5.1ch sound is automatically converted and output in 2ch.
- To enjoy the 5.1ch surround sound of the movies recorded with high definition image quality (HD) in 5.1ch sound, you need a device compatible with 5.1ch surround.

- When you connect your camcorder with the supplied HDMI cable, the sound of high definition image quality (HD) movies recorded in 5.1ch sound is automatically output in 5.1ch sound. The sound of standard definition image quality (STD) movies is converted to 2ch.



- [Audio Mode] (p. 71)

On an HDMI cable

- Use an HDMI cable with the HDMI logo.
- Use an HDMI mini connector on one end (for the camcorder), and a plug suitable for connecting your TV on the other end.
- Copyright-protected images are not output from the HDMI OUT jack of your camcorder.
- Some TVs may not function correctly (e.g., no sound or image) with this connection.
- Do not connect the camcorder HDMI OUT jack to an external device HDMI OUT jack, as malfunction may result.
- HDMI (High Definition Multimedia Interface) is an interface to send both video/audio signals. The HDMI OUT jack outputs high quality images and digital audio.

When your TV is monaural (When your TV has only one audio input jack)

Connect the yellow plug of the A/V connecting cable to the video input jack and connect the white (left channel) or red (right channel) plug to the audio input jack of your TV or VCR.

When connecting to your TV via a VCR

Connect your camcorder to the LINE IN input on the VCR using the A/V connecting cable. Set the input selector on the VCR to LINE (VIDEO 1, VIDEO 2, etc.).



- Setting the aspect ratio supported by the TV: [TV Type] (p. 71)

Using “BRAVIA” Sync

You can operate your camcorder with the remote commander of your TV by connecting your camcorder to a “BRAVIA” Sync compatible TV launched in 2008 or later with the HDMI cable.

You can operate the menu of your camcorder by pressing the SYNC MENU button of the remote commander of your TV. You can display the camcorder screens such as Event View, play selected movies or display selected photos by pressing up/down/left/right/enter buttons of the remote commander of your TV.

- There may be some operations you cannot do with the remote commander.
- Set [CTRL FOR HDMI] to [On].
- Also set your TV accordingly. Refer to the instruction manual of the TV for details.
- The operation of “BRAVIA” Sync differs according to each model of BRAVIA. Refer to the instruction manual of your TV for details.
- If you turn off the TV, your camcorder is turned off simultaneously.

On “Photo TV HD”

This camcorder is compatible with the “Photo TV HD” standard. “Photo TV HD” allows for highly-detailed, photo-like depiction of subtle textures and colors. By connecting Sony’s Photo TV HD-compatible devices using an HDMI cable*, a whole new world of photos can be enjoyed in breathtaking HD quality.

* The TV will automatically switch to the appropriate mode when displaying photos.

Using the built-in projector (HDR-PJ710/PJ710V/PJ760/PJ760V)

You can use a flat surface such as a wall as a screen to view recorded images using the built-in projector.

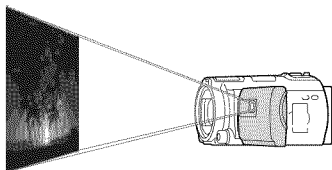

Notes

- The LCD screen turns off while an image is being projected. Use the power zoom lever/PHOTO button or wireless remote commander to operate the camcorder.

- 1 Face the projector lens towards a surface, such as a wall, and then press PROJECTOR.

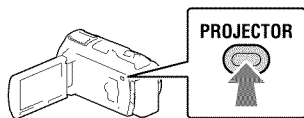

- 2 When the operating guide screen appears, select [Project].

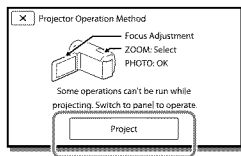

- This screen appears the first time you use the built-in projector.

3 Adjust the focus of the projected image using the PROJECTOR FOCUS lever.

PROJECTOR FOCUS lever

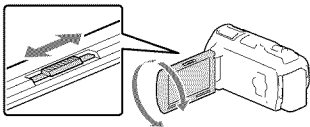

- The projected image is larger when the distance between your camcorder and the reflecting surface increase.
- It is recommended that you place the camcorder about 0.5 m (1.6 feet) or further away from the surface that the images are to be projected onto.

4 Move the power zoom lever to select the image you want to play, then press PHOTO to begin playback.

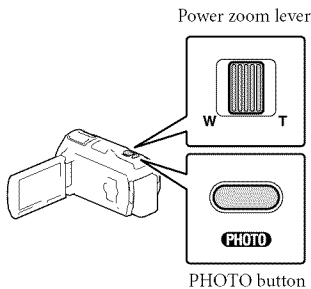

- Use the power zoom lever to move the selection frame that appears on the LCD screen and press the PHOTO button to start playing the framed item.
- For details on playback, see page 32.
- When you use the wireless remote commander, use ◀/▶/▲/▼ to move the selection frame and press ENTER to start playing the framed item.
- To turn off the projector, press PROJECTOR.

Notes

- Be careful of the following operations or situations while using the projector.
 - Make sure not to project images towards the eyes.
 - Make sure not to touch the projector lens.
 - The LCD screen and the projector lens become hot while in use.
 - Using the projector shortens battery life.
- The following operations are unavailable while you are using the projector.
 - Map operation (HDR-PJ710V/PJ760V)
 - Output of Highlight Playback to a device such as a TV
 - Operation of the camcorder with the LCD screen closed
 - Several other functions

Editing on your camcorder

Notes

- Some basic editing operations can be done on the camcorder. If you want to perform advanced editing operations, install the “Expanded Feature” for the built-in “PlayMemories Home” software.
- You cannot restore images once they are deleted. Save important movies and photos in advance.
- Do not remove the battery pack or the AC Adaptor from your camcorder while deleting or dividing the images. It may damage the recording media.
- Do not eject the memory card while deleting or dividing images from the memory card.
- If you delete or divide movies/photos that are included in saved scenarios (p. 49), the scenarios will also be deleted.

Deleting movies and photos

- 1 Select **MENU** → [Edit/Copy] → [Delete].
- 2 Select [Multiple Images], and then select the type of image you want to delete.

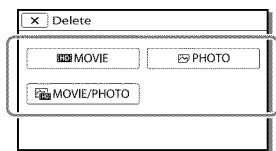

- 3 Add check marks ✓ to the movies or photos to be deleted and select **OK**.

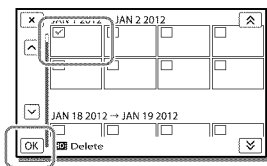

To delete all movies/photos in the selected date at one time

- 1 In step 2, select [All In Event].
- 2 Select the date you want to delete using **▲**/**▼**, and then select **OK**.

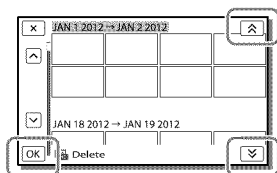

To delete a part of a movie

You can divide a movie and delete it.





- Release protection: [Protect] (p. 72)
- [Format] (p. 72)

Dividing a movie

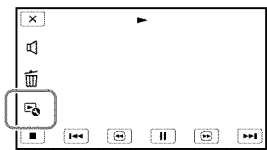
- 1 Select **⏏** → [Divide] on the movie playback screen.



- 2 Select the point where you want to divide the movie into scenes using , and then select .

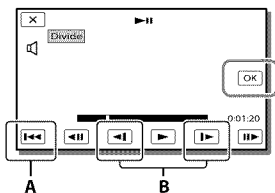

- A:** Returns to the beginning of the selected movie
B: Adjusts the dividing point with more precision



Notes

- A slight difference may occur from the point where you select and the actual dividing point, as your camcorder selects the dividing point based on about half-second increments.
- Some basic editing operations can be done on the camcorder. If you want to do advanced editing operations, use the built-in "PlayMemories Home" software.

Capturing a photo from a movie

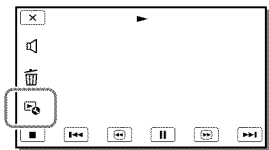
- 1 Select  → [Photo Capture] that appears on the playback screen of a movie.



- 2 Select the point where you want to capture a photo using , and then select .

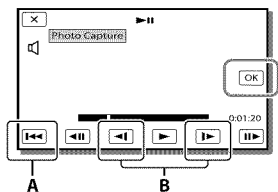

- A:** Returns to the beginning of the selected movie
B: Adjusts the capturing point with more precision

If the movie was recorded with one of the following image quality levels, the image size will be set as shown below.

- High definition image quality (HD): 2.1 M (16:9)
- Wide aspect ratio (16:9) with standard definition image quality (STD): 0.2 M (16:9)
- 4:3 aspect ratio with standard definition image quality (STD): 0.3 M (4:3)

On recording date and time of captured photos

- The recording date and time of captured photos are the same as the recording date and time of the movies.
- If the movie you are capturing from has no data code, the recording date and time of the photo will be the date and time you captured from the movie.

Useful functions available when connecting the camcorder to your computer

For Windows

The built-in “PlayMemories Home” (Lite Version) software allows you to import images in the camcorder to your computer and play them on the computer easily.

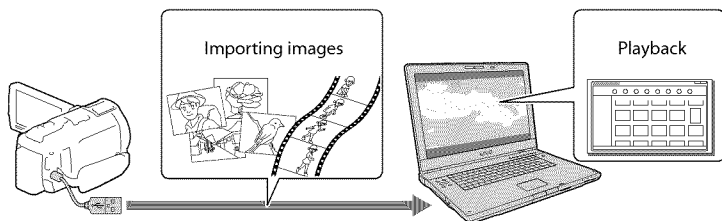

- Use the USB connection support cable when the Built-in USB Cable of the camcorder is too short for connection with your computer.

To use the “Expanded Feature” upgrade for the “PlayMemories Home” software

On the computer that is connected to the Internet, you can download the “Expanded Feature” upgrade which allows you to use various expanded functions.

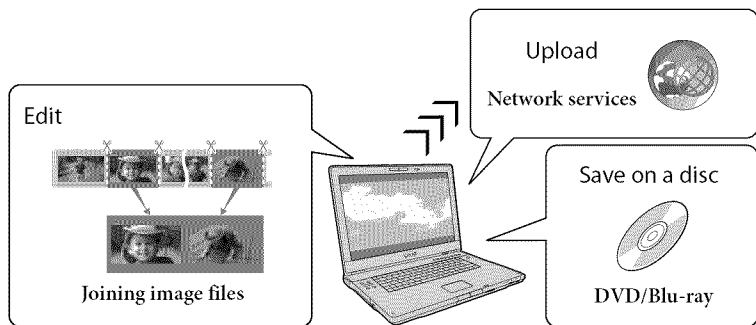

For Mac

The built-in “PlayMemories Home” software is not supported with Mac computers. To import images from the camcorder to your Mac and play them, use the appropriate software on your Mac. For details, visit the following URL.

<http://www.sony.co.jp/imsoft/Mac/>

Preparing a computer (Windows)

Step 1 Checking the computer system

OS*1

Microsoft Windows XP SP3*2/Windows Vista SP2*3/Windows 7 SP1

CPU*4

Intel Core Duo 1.66 GHz or faster, or Intel Core 2 Duo 1.66 GHz or faster (Intel Core 2 Duo 2.26 GHz or faster is required when processing FX or FH movies, and Intel Core 2 Duo 2.40 GHz or faster is required when processing PS movies.)

However, Intel Pentium III 1 GHz or faster is sufficient for the following operations:

- Importing the movies and photos to the computer
- Creating a Blu-ray disc/AVCHD recording disc/DVD-video (Intel Core Duo 1.66 GHz or faster is required when creating a DVD video by converting high definition image quality (HD) to standard definition image quality (STD).)
- Processing only the movies with standard definition image quality (STD)

Memory

Windows XP: 512 MB or more (1 GB or more is recommended)

Windows Vista/ Windows 7: 1 GB or more

Hard disk

Disk volume required for installation: Approximately 500 MB (10 GB or more may be necessary when creating AVCHD recording discs. 50 GB maximum may be necessary when creating Blu-ray discs.)

Display

Minimum 1,024 × 768 dots

Others

USB port (this must be provided as standard, Hi-Speed USB (USB 2.0 compatible)), Blu-ray disc/DVD burner Either NTFS or exFAT file system is recommended as the hard disk file system.

- *1 Standard installation is required. Operation is not assured if the OS has been upgraded or in a multi-boot environment.
- *2 64-bit editions and Starter (Edition) are not supported. Windows Image Mastering API (IMAPI) Ver.2.0 or newer is required to use disc creation function, etc.
- *3 Starter (Edition) is not supported.
- *4 Faster processor is recommended.

Notes

- Operation with all computer environments is not assured.

Step 2 Installing the built-in “PlayMemories Home” software

1 Turn on the computer.

- Log on as an Administrator for installation.
- Close all applications running on the computer before installing the software.

2 Connect the camcorder to the computer using the Built-in USB Cable, then select [USB Connect] on the LCD screen of the camcorder.

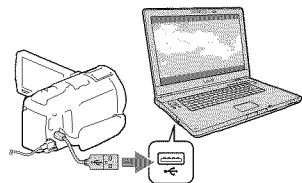

- When using Windows 7: The Device Stage window opens.
- When using Windows XP/Windows Vista: The AutoPlay wizard is displayed.

3 On Windows 7, select [PlayMemories Home] on the Device Stage window. On Windows XP/Windows Vista, select [Computer] (on Windows XP, [My Computer]) → [PMHOME] → [PMHOME.EXE].

4 Follow the instructions that appear on the computer screen to continue the installation.

When the installation completes, “PlayMemories Home” starts up.

- If the “PlayMemories Home” software is already installed on your computer, register your camcorder with the “PlayMemories Home” software. Functions that can be used with this camcorder will then be available.
- If the “PMB (Picture Motion Browser)” software is installed on your computer, it will be overwritten by the “PlayMemories Home” software. In this case, you cannot use some functions that were available with “PMB” with this “PlayMemories Home” software.
- Instructions for installing the “Expanded Feature” upgrade appear on the computer display. Follow the instructions and install the expansion files.
- The computer has to be connected to the Internet to install the “Expanded Feature” upgrade. If you did not install the file the first time you started the “PlayMemories Home” software, the instructions appear again when you select a function of the software that can be used only when the “Expanded Feature” upgrade has been installed.
- For details on “PlayMemories Home,” select ? (“PlayMemories Home Help Guide”) on the software or visit the PlayMemories Home support page (<http://www.sony.co.jp/pmh-se/>).

Notes

- Make sure to set [USB LUN Setting] to [Multi] when you install the “PlayMemories Home” software.
- If the “Device Stage” does not start up when you are using Windows 7, click [Start], then double click the camera icon for this camcorder → the medium icon on which the desired images are stored → [PMHOME.EXE].
- Operation is not guaranteed if you read or write video data from or to the camcorder using software other than the built-in “PlayMemories Home” software. For the information on the compatibility of the software you are using, consult the manufacturer of the software.

To disconnect your camcorder from the computer

- 1 Click the  icon at the bottom right of the desktop of the computer → [Safely remove USB Mass Storage Device].



- 2 Select → [Yes] on the camcorder screen.
 - 3 Disconnect the USB cable.
- If you are using Windows 7, the  icon may not appear on the desktop of the computer. In this case, you can disconnect the camcorder from your computer without following the procedures described above.

Notes

- Do not format the internal memory of the camcorder using a computer. If you do this, the camcorder will not operate correctly.
- Do not insert AVCHD recording discs that have been created using the built-in “PlayMemories Home” software to DVD players or recorders, as these devices do not support the AVCHD

- standard. If you do, you may not be able to remove the disc from these devices.
- This camcorder captures high definition footage in the AVCHD format. Using the enclosed PC software, high definition footage can be copied onto DVD media. However, DVD media containing AVCHD footage should not be used with DVD based players or recorders, as the DVD player/recorder may fail to eject the media and may erase its contents without warning.
 - When you access the camcorder from the computer, use the built-in “PlayMemories Home” software. Do not modify the files or folders on the camcorder from the computer. The image files may be damaged or may not be played back.
 - Operation is not guaranteed, if you operate the data on the camcorder from the computer.
 - The camcorder automatically divides an image file that exceeds 2 GB and saves the parts as separate files. All image files may be shown as separate files on a computer, however, the files will be handled properly by the import function and the playback function of the camcorder or the “PlayMemories Home” software.
 - Use the built-in “PlayMemories Home” software when you import long movies or edited images from the camcorder to a computer. If you use other software, the images may not be imported correctly.
 - When you delete image files, follow the steps on page 54.

- Your computer must support the creation of Blu-ray discs.
- BD-R (unrewritable) and BD-RE (rewritable) media are available for creating Blu-ray discs. You cannot add contents to either type of disc after creating the disc.
- To play back a Blu-ray disc that has been created with a movie that was recorded in [60p Quality **PS**] image quality, you need a device that complies with the AVCHD Ver. 2.0 format.

To create a Blu-ray disc

You can create a Blu-ray disc with a high definition image quality (HD) movie previously imported to a computer.

To create a Blu-ray disc, the “BD Add-on Software” must be installed.

Visit the following URL to install the software.

<http://support.d-imaging.sony.co.jp/BDUW/>

Starting the “PlayMemories Home” software

- 1 Double-click the “PlayMemories Home” icon on the computer screen.

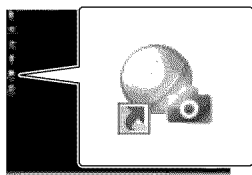

The “PlayMemories Home” software starts up.

- 2 Double-click the “PlayMemories Home Help Guide” short-cut icon on the computer screen to see how to use “PlayMemories Home.”

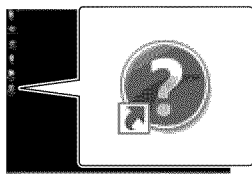

- If the icon is not displayed on the computer screen, click [Start] → [All Programs] → [PlayMemories Home] → the desired item.

Downloading the dedicated software for the camcorder

Installing Music Transfer

Music Transfer allows you to change the music files that have been supplied with your camcorder to suit your tastes, or to delete or add music files.

Furthermore, this software can restore the music files that were supplied with your camcorder.

To use this software, you must download it from the following URL and install it on your computer.

For Windows: <http://www.sony.co.jp/imsoft/Win/>

For Mac: <http://www.sony.co.jp/imsoft/Mac/>

For details, refer to the “Music Transfer” help.

Installing software for a Mac

For details on the software for Mac computers, refer to the following URL.
<http://www.sony.co.jp/imsoft/Mac/>



- You can access the URL noted above by clicking [FOR_MAC.URL] in [PMHOME] while your camcorder is connected to the computer. When you connect the camcorder to the computer, set [USB LUN Setting] to [Multi].

Notes

- The software that can be used with your camcorder will differ, depending on the countries/regions.

Dubbing guide

You can save high definition image quality (HD) movies using an external device. Select the method to be used according to the device.

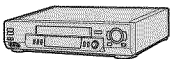
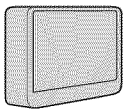
External devices	Connecting cable	Page
 <p>DVDirect Express DVD writer Saving images on a DVD disc with high definition image quality (HD).</p>	Built-in USB cable of the DVDirect Express	63
 <p>DVD writer other than DVDirect Express Saving images on a DVD disc with high definition image quality (HD) or with standard definition image quality (STD).</p>	Built-in USB Cable	64
 <p>Hard disk recorder, etc. Saving images on a DVD disc with standard definition image quality (STD).</p>	A/V connecting cable (supplied)	64
 <p>External media device Saving images on an external media device with high definition image quality (HD).</p>	USB Adapter Cable VMC-UAM1 (sold separately)	66

Movies that are recorded with standard definition image quality (STD)

Use the A/V connecting cable to connect the camcorder to an external device in which images are saved.

Notes

- Delete the demonstration movie when copying or creating discs. If it is not deleted, the camcorder may not operate correctly. However, you cannot recover the demonstration movie once you delete it.
- Movies recorded with [ REC Mode] (p. 71) set to [60p Quality **PS**] or [Highest Quality **FX**] can be saved on external media devices.



- Dubbing on a computer: the built-in “PlayMemories Home” software (p. 60)

The devices on which the created disc can be played back

DVD disc with high definition image quality (HD)

AVCHD format playback devices, such as a Sony Blu-ray disc player or a PlayStation®3

DVD disc with standard definition image quality (STD)

Ordinary DVD playback devices, such as a DVD player.

Notes

- The AVCHD recording disc can be played back only on AVCHD format compatible devices.
- Discs with high definition image quality (HD) images recorded should not be used in DVD players/recorders. Because DVD players/recorders are not compatible with the AVCHD format, DVD players/recorders may fail to eject the disc.
- Always maintain your PlayStation®3 to use the latest version of the PlayStation®3 system software. The PlayStation®3 may not be available in some countries/regions.

Creating a disc with the DVD writer or recorder

Notes

- Connect your camcorder to the wall outlet (wall socket) using the supplied AC Adaptor for this operation (p. 20)
- Refer to the instruction manual supplied with the device connected.
- Sony DVD writer may not be available in some countries/regions.

Creating a disc with DVDirect Express

Connect your camcorder and the “DVDirect Express” DVD writer (sold separately) using the USB cable supplied with the DVDirect Express.

- 1 Connect the DVDirect Express to the Ψ (USB) jack of your camcorder with the USB cable of the DVDirect Express.

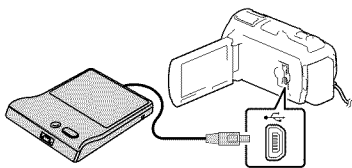

- 2 Insert an unused disc into the DVDirect Express, and close the disc tray.
- 3 Press \odot (DISC BURN) on the DVDirect Express.

Movies that have not yet been saved on any disc can be saved on the disc at this time.

- After the operation is completed, select X.

To perform [DISC BURN OPTION]

You can also create a standard definition image quality (STD) disc.

- 1 Select [DISC BURN OPTION] in step 3 above.
- 2 Select the recording medium containing the movie(s) you want to save.
- 3 Select the image quality of the disc you will create.
- 4 Add check marks \checkmark to the images you want to copy, and then select OK.

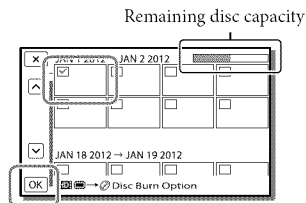

- After the operation is completed, select X.

To play back a disc in the DVDirect Express

- 1 To play back movies from the disc in the DVDirect Express on the TV screen, connect the DVDirect Express to the Ψ (USB) jack of your camcorder, and connect your camcorder to the TV (p. 50).
- 2 Insert a created disc into the DVDirect Express.
- 3 Press the play button on the DVDirect Express.
 - After the operation is completed, select X.

Notes

- High definition (HD) and standard definition (STD) image quality movies will be saved on individual discs.
- If the total memory size of movies to be burnt by the DISC BURN operation exceeds that of the disc, disc creation stops when the limit is reached. The last movie on the disc may be cut off.
- Do not do any of the following when creating a disc.
 - Turn off the camcorder
 - Disconnect the USB cable or the AC Adaptor
 - Subject the camcorder or the DVDirect Express to mechanical shock or vibration
 - Eject the memory card from the camcorder
- Disc creation time to copy movies to the limit of the disc is about 20 to 60 minutes. It may take more time depending on the recording mode or the number of scenes.

Creating a high definition image quality (HD) disc with a DVD writer

Use the built-in USB cable to connect your camcorder to a Sony DVD writer other than DVDirect Express (sold separately), etc., which is compatible with high definition image quality (HD) movies.

- 1 Connect a DVD writer to your camcorder with the Built-in USB Cable.

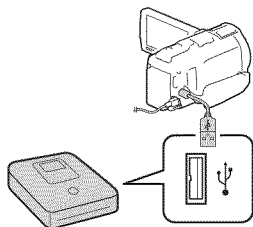

- 2 Select [USB Connect] on the camcorder screen.

- If the [USB Select] screen does not appear, select [MENU] → [Setup] → [Connection] → [USB Connect].

- 3 Record movies on the connected device.

- After the operation is completed, select .

Notes

- Always maintain the firmware of the Sony DVDirect (DVD Writer) to its latest version. For details, see the following website.
<http://sony.storagesupport.com/>

Creating a standard definition image quality (STD) disc with a recorder, etc.

Connect your camcorder to a disc recorder, a Sony DVD writer, etc., other than DVDirect Express, with the A/V connecting cable. You can copy images played back on your camcorder on a disc or video cassette.

- 1 Insert the recording medium in the recording device (a disc recorder, etc.).

- If your recording device has an input selector, set it to the input mode.

- 2 Connect your camcorder to the recording device with the A/V connecting cable.

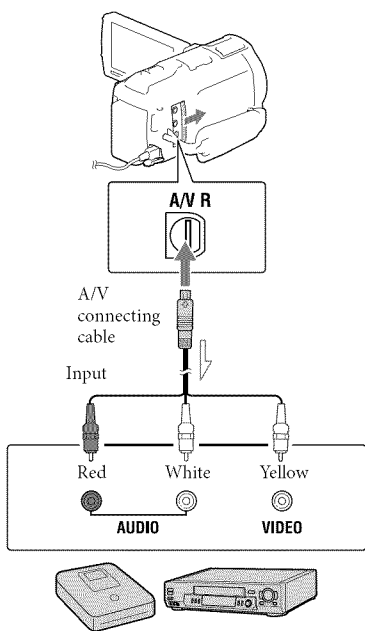

➤ Signal flow

- Connect your camcorder to the input jacks of the recording device.

- 3 Start playback on your camcorder, and record it on the recording device.
- 4 When dubbing is finished, stop the recording device, and then your camcorder.

Notes

- You cannot copy images to recorders connected with an HDMI cable.
- Since copying is performed via analog data transfer, the image quality may deteriorate.

- High definition image quality (HD) movies will be copied with standard definition image quality (STD).
- When you connect a monaural device, connect the yellow plug of the A/V connecting cable to the video input jack, and the white (left channel) or the red (right channel) plug to the audio input jack on the device.



- Copying date and time information: [Data Code] (p. 72)
- Using 4:3 screen size display device: [TV Type] (p. 72)

Saving images on an external media device

You can save movies and photos on an external media device (USB storage devices), such as an external hard disk drive. The following functions will be available after you have saved your images on an external media device.

- You can connect your camcorder and the external media device, and then play back images stored on the external media device (p. 66).
- You can connect your computer and the external media device and import images to your computer using the built-in "PlayMemories Home" software (p. 60).

Notes

- For this operation, you need the USB Adaptor Cable VMC-UAM1 (sold separately).
- Connect the AC Adaptor and the power cord (mains lead) to the DC IN jack of your camcorder and the wall outlet (wall socket).
- Refer to the instruction manual supplied with the external media device.

- 1 Connect your camcorder and the external media device using the USB Adaptor Cable (sold separately).

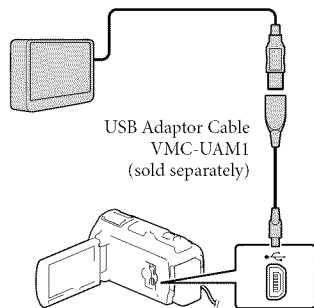

- Make sure not to disconnect the USB cable while [Preparing image database file. Please wait.] is displayed on the LCD screen.
- If [Repair Img. DB F.] is displayed on the camcorder screen, select .

- 2 Select [Copy.] on the camcorder screen.

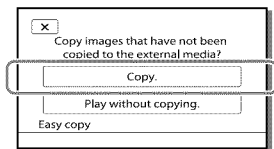

- Movies and photos that are stored on one of the camcorder's recording media selected in [Media Select], and that have not yet been saved on external media device can be saved on the connected media device at this time.
- This operation is available only when there are newly recorded images in your camcorder.
- To disconnect the external media device, select  while the camcorder is in the playback standby mode (either Event View or Event Index is displayed).

To play back images in the external media device on the camcorder

Select [Play without copying.] in step 2 and select the image you want to view.

- You can also view images on a TV connected to your camcorder (p. 50).
- When an external media device is connected,  will appear on the Event View screen.

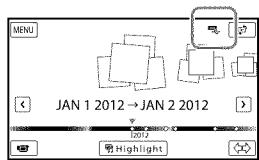

To delete images in the external media device

- 1 Select [Play without copying.] in step 2.
- 2 Select [MENU] → [Edit/Copy] → [Delete], and then follow the instructions that appear on the LCD screen to delete images.

To save the desired images in the camcorder to the external media device

- 1 Select [Play without copying.] in step 2.
 - 2 Select [MENU] → [Edit/Copy] → [Copy], and then follow the instructions that appear on the LCD screen to save images.
- If you want to copy images that have not yet been copied, select [MENU] → [Edit/Copy] → [Direct Copy] while your camcorder is connected to the external media device.

To play back high definition image quality (HD) movies on your computer







On the “PlayMemories Home” software (p. 60), select the drive that represents the external media device connected, and then play movies.

Notes

- You cannot use the following devices as an external media device.
 - media devices with a capacity exceeding 2 TB
 - ordinary disc drive such as CD or DVD drive
 - media devices connected via a USB hub
 - media devices with built-in USB hub
 - card reader
- You may not be able to use external media devices with a code function.
- The FAT file system is available for your camcorder. If the storage medium of the external device was formatted for the NTFS file system, etc., format the external media device using the camcorder before use. The format screen appears when an external media device is connected to your camcorder. Make sure that important data has not previously been saved on the external media device before you format it using the camcorder.
- Operation is not assured with every device satisfying requirements for operating.
- For details on available external media devices, go to the Sony support website in your country/region.
- The number of scenes you can save on the external media device are as follows. However, even if the external media device has free space, you cannot save scenes exceeding the following number.
 - High definition image quality (HD) movies: Max. 3,999
 - Standard definition image quality (STD) movies: Max. 9,999
 - Photos: Max. 40,000
- If your camcorder does not recognize the external media device, try the following operations.
 - Reconnect the USB Adaptor Cable to your camcorder.
 - If the external media device has the AC power cord (mains lead), connect it to the wall outlet (wall socket).
- The number of scenes may be smaller depending on the type of images recorded.
- You cannot copy images from an external media device to the internal recording medium on the camcorder.

Using menus

The camcorder has various menu items under each of 6 menu categories.

-  **Shooting Mode (Items for selecting a shooting mode)** → p. 70
-  **Camera/Mic (Items for customized shooting)** → p. 70
-  **Image Quality/Size (Items for setting up image quality or size)** → p. 71
-  **Playback Function (Items for playback)** → p. 71
-  **Edit/Copy (Items for editing images such as copy or protect)** → p. 72
-  **Setup (Other setup items)** → p. 72

1 Select .

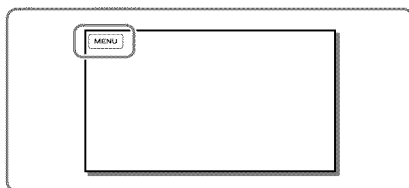

2 Select a category.

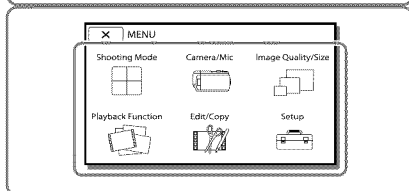

3 Select your desired menu item.

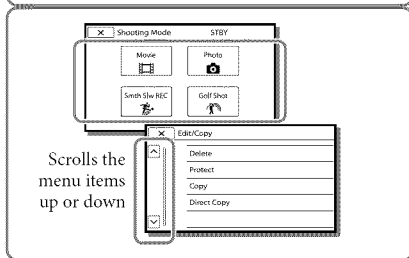

Notes

- Select  to finish setting the menu or to return to the previous menu screen.

To find a menu item quickly

The [Camera/Mic] and [Setup] menus have sub-categories. Select the sub-category icon so that the LCD screen displays the list of menus in the sub-category selected.

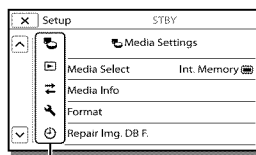

Sub-category icons

When you cannot select a menu item

Grayed out menu items or settings are not available.

When you select the grayed out menu item, your camcorder displays the reason why you cannot select the menu item or the instruction of under which condition you can set the menu item.

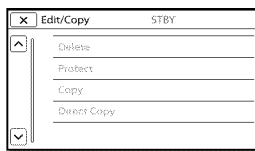







Menu lists

Shooting Mode





- Movie Records movies.
- Photo..... Shoots photos.
- Smth Slw REC..... Records smooth slow-motion movies.
- Golf Shot..... Divides two seconds of fast movement into frames which are then recorded as a movie and photos. Keep the subject in the white frame in the center of the screen when recording.

Camera/Mic

Manual Settings

- White Balance..... Adjusts the color balance to the recording environment.
- Spot Meter/Fcs..... Adjusts the brightness and focus for the selected subject simultaneously.
- Spot Meter..... Adjusts the brightness of images to a subject you touch on the screen.
- Spot Focus..... Adjusts the focus on a subject you touch on the screen.
- Exposure..... Adjusts the brightness of movies and photos. If you select [Manual], adjust the brightness (exposure) using  / .
- Focus..... Adjusts the focus manually. If you select [Manual], select  to adjust the focus for a nearby subject and  to adjust the focus for a distant subject.
- IRIS..... Sharpens the subject with its background blurred or sharpens the whole image.
- Shutter Speed..... Adjusts Shutter Speed. When you shoot a moving subject at a higher shutter speed, it appears as if frozen on the image. At a lower shutter speed, the subject appears as if it is flowing.
- AGC Limit..... Sets the maximum level of AGC (Auto Gain Control).
- AE Shift..... Adjusts the exposure. Touch  if the subject is white or the backlight is bright, or touch  if the subject is black or the light is dim.
- White Balance Shift Adjusts the white balance.
- Low Lux..... Records bright color images in the dim.

Camera Settings

- Scene Selection Selects an appropriate recording setting according to the type of scene, such as night view or beach.
-  Cinematone..... Adjusts the color of the movie to resemble the atmosphere of films when recording.
-  Fader..... Fades scenes in or out.
-  Self-Timer..... Sets the self-timer when your camcorder is in photo recording mode.
- Tele Macro..... Focuses on the subject with its background blurred.
-  SteadyShot Automatically corrects the camera-shake correction when shooting with zooming not only when shooting with wide-angle.
-  SteadyShot Sets the SteadyShot function when shooting photos.
- Digital Zoom..... Sets the maximum zoom level of the digital zoom.
- Conversion Lens Sets the type of an attached conversion lens (sold separately).
- Auto Back Light..... Adjusts the exposure for backlit subjects automatically.
- Dial Setting..... Assigns a function to the MANUAL dial.
- NIGHTSHOT Light..... Emits infrared light when using NightShot.

 Face

- Face Detection Automatically detects faces.
- Smile Shutter Automatically takes a shot whenever a smile is detected.
- Smile Sensitivity Sets the smile detection sensitivity for the Smile Shutter function.

 Flash

- Flash Sets how the flash is activated when shooting photos.
- Flash Level Sets the brightness of flash.
- Red Eye Reduction Prevents reddyeye when shooting with flash.







 Microphone

- Closer Voice Detects human faces and records the associated voice clearly.
- Bit-in Zoom Mic Records movies with vivid sound appropriate to the zoom position.
- Auto Wind NR Recognizes the recording conditions and reduces the wind noise.
- Audio Mode Sets the recording sound format (5.1ch surround/2ch stereo).
- Micref Level Sets the microphone level for recording.

 Shooting Assist

- My Button Assigns functions to My Buttons.
- Expanded Focus*1 Magnifies the image that appears at the center of the screen by about 2.0 times.
- Guide Frame Displays frames as a guide to make sure the subject is horizontal or vertical.
- Display Setting Sets the duration that icons or indicators are displayed on the LCD screen.
- Zebra Displays a zebra pattern as a guide for adjusting brightness.
- Peaking Displays an image on the screen with its outlines enhanced.
- Light Bright Adjusts the brightness of the video light.
- Audio Level Display Displays the audio level meter on the LCD screen while recording.

 Image Quality/Size

-  REC Mode Sets the mode to record movies.
-  Frame Rate Sets the frame rate to record movies.
-  **HD** / **STD** Setting Sets the image quality for recording (high definition image quality (HD) or standard definition image quality (STD)).
-  Wide Mode Sets the horizontal to vertical ratio when recording movies with standard definition image quality (STD).
-  x.v.Color Records a wider range of colors. Set this item when you watch images with a TV which is compliant with x.v.Color.
-  Image Size Sets the photo size.

 Playback Function

- Event View Starts playing images from the Event View display.
- Map View*2 Starts playing the images from the Map View display.
- Highlight Movie Starts playing Highlight Playback scenes or Highlight Scenarios saved with standard definition image quality (STD).
-  Scenario Starts playing the scenarios that were saved by Highlight Playback.

Edit/Copy

- Delete.....Deletes movies or photos.
- Protect.....Protects movies or photos to avoid deleting.
- Copy.....Copies images.
- Direct Copy.....Copies images stored in the camcorder to some type of external media device.

Setup

Media Settings

- Media Select.....Selects the type of recording media (p. 25).
- Media Info.....Displays information on the recording media.
- Format.....Deletes and formats all data on the recording media.
- Repair Img. DB F.....Repairs the image database file on the recording media (p. 76).
- File Number.....Sets how to assign the file number to photos.

Playback Settings

- Data Code.....Displays information that was recorded automatically at the time of recording.
- Volume.....Adjusts the volume of playback sound (p. 35).
- Download Music.....Downloads your favorite music files from the computer to your camcorder (while the camcorder is connected to the computer) that can be played with the Highlight Playback scenes.
- Empty Music.....Deletes all music files.

Connection

- TV Type.....Converts the signal depending on the TV connected (p. 50).
- HDMI Resolution.....Selects the output image resolution when connecting your camcorder to a TV with an HDMI cable.
- CTRL FOR HDMI.....Sets whether or not the TV's Remote Commander is to be used when the camcorder is connected to a "BRAVIA" Sync compatible TV with the HDMI cable.
- USB Connect.....Select this item when no instructions appear on the LCD screen when you connect your camcorder to an external device via USB.
- USB Connect Setting ... Sets the connection mode when the camcorder is connected to a computer or a USB device.
- USB LUN Setting.....Sets the camcorder to improve the compatibility of a USB connection by restricting some USB functions.
- Disc Burn.....Saves images that have not yet been saved onto a disc.

General Settings

- Beep.....Sets whether the camcorder sounds operation beeps or not.
- LCD Brightness.....Adjusts the brightness of the LCD screen.
- Your Location*2.....Displays the current location on a map.
- GPS Setting*2.....Receives the GPS signal.
- REC Lamp.....Turns the recording lamp on the front of the camcorder off.
- Remote Ctrl.....Sets the Wireless Remote Commander to be used.
- Power On By LCD*3.....Sets the power so that it turns on automatically when you open the LCD screen.

- Language Setting Sets the display language (p. 22).
- Calibration Calibrates the touch panel.
- Battery Info..... Displays the approximate remaining battery time.
- Eco Mode Sets the LCD screen and the power so that they turn off automatically.
- Demo Mode Sets playback of the demonstration movie about the functions of the camcorder.

Clock Settings

- Date & Time Setting Sets the date and time.
- Area Setting Adjusts for a time difference without stopping the clock (p. 22).
- Auto Clock ADJ ^{*2} Adjusts the clock automatically by acquiring the time from the GPS system.
- Auto Area ADJ^{*2}..... Corrects time differences automatically by acquiring the current location information from the GPS system.

^{*1} HDR-CX760V/PJ760/PJ760V

^{*2} HDR-CX760V/PJ710V/PJ760V

^{*3} HDR-PJ710/PJ710V

Troubleshooting

If you run into any problems using your camcorder, follow the steps below.

① Check the list (p. 74 to 76), and inspect your camcorder.

② Disconnect the power source, attach the power source again after about 1 minute, and turn the camcorder on.

③ Press RESET (p. 14) using a pointed object, and turn the camcorder on. If you press RESET, all settings, including the clock setting, are reset.

④ Contact your Sony dealer or local authorized Sony service facility.

- Your camcorder may be required to initialize or change the current internal memory of your camcorder, depending on the problem. In the event of this, the data stored on the internal memory will be deleted. Be sure to save the data on the internal memory on other media (backup) before sending your camcorder for repair. We will not compensate you for any loss of internal memory data.
- During repair, we may check a minimum amount of data stored on the internal memory in order to investigate the problem. However, your Sony dealer will neither copy nor retain your data.
- See the “Handycam” User Guide (p. 9) for details on the symptoms of your camcorder, and “PlayMemories Home Help Guide” (p. 60) on connecting your camcorder to a computer.

The power does not turn on.

- Attach a charged battery pack to the camcorder (p. 18).
- The plug of the AC Adaptor has been disconnected from the wall outlet (wall socket). Connect it to the wall outlet (wall socket) (p. 20).

The camcorder does not operate even when the power is set to on.

- It takes a few seconds for your camcorder to be ready to shoot after the power is turned on. This is not a malfunction.
- Disconnect the AC Adaptor from the wall outlet (wall socket) or remove the battery pack, then reconnect it after about 1 minute. If the functions still do not work, press RESET using a pointed object. (If you press RESET (p. 14), all settings, including the clock setting, are reset.)
- The temperature of your camcorder is extremely high. Turn off your camcorder and leave it for a while in a cool place.
- The temperature of your camcorder is extremely low. Leave your camcorder with the power of your camcorder on. Turn off your camcorder and take it to a warm place. Leave the camcorder there for a while, then turn on your camcorder.



Your camcorder gets warm.

- Your camcorder may become warm during operation. This is not a malfunction.

The power abruptly turns off.

- Use the AC Adaptor (p. 20).
- In the default setting, when about 2 minutes have elapsed while you do not operate your camcorder, the camcorder automatically turns off. Change the setting of [Eco Mode] (p. 73), or turn on the power again.
- Charge the battery pack (p. 18).

Pressing START/STOP or PHOTO does not record images.

- The playback screen is displayed. Press MODE to turn on the  (Movie) or  (Photo) lamp (p. 27).
- Your camcorder is recording the image you have just shot on the recording media. You cannot make new recording during this period.

Self-diagnosis display/Warning indicators

- The recording media is full. Delete unnecessary images (p. 54).
- Total number of movie scenes or photos exceeds the recordable capacity of your camcorder (p. 78, 79). Delete unnecessary images (p. 54).

The camcorder stops operating.

- The temperature of your camcorder is extremely high. Turn off your camcorder and leave it for a while in a cool place.
- The temperature of your camcorder is extremely low. Turn off your camcorder and take it to a warm place. Leave the camcorder there for a while, then turn on the camcorder.

“PlayMemories Home” cannot be installed.

- Check the computer environment or installation procedure required to install “PlayMemories Home.”

“PlayMemories Home” does not work correctly.

- Quit “PlayMemories Home” and restart your computer.

The camcorder is not recognized by the computer.

- Disconnect devices from the USB jack of the computer other than the keyboard, mouse, and your camcorder.
- Disconnect the Built-in USB Cable from the computer and your camcorder, and restart the computer, then connect the computer and your camcorder again in the correct order.
- When both the Built-in USB Cable and the USB jack of the camcorder are connected to the external devices at the same time, disconnect one that is not connected to a computer.

If indicators appear on the LCD screen or viewfinder (HDR-CX760V/PJ760/PJ760V), check the following.

If the problem persists even after you have tried to fix a couple of times, contact your Sony dealer or local authorized Sony service facility. In this case, when you contact them, give them all the numbers of the error code beginning with C or E. You may hear a melody when some warning indicators appear on the screen.

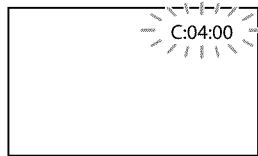

C:04:□□

- The battery pack is not an “InfoLITHIUM” battery pack (V series). Use an “InfoLITHIUM” battery pack (V series) (p. 18).
- Connect the DC plug of the AC Adaptor to the DC IN jack of your camcorder securely (p. 18).

C:06:□□

- The battery pack temperature is high. Change the battery pack or place it in a cool place.

C:13:□□ / C:32:□□

- Remove the power source. Reconnect it and operate your camcorder again.

E:□□:□□

- Follow the steps from ② on page 74.

E:□

- The battery pack is nearly used up.



- The battery pack temperature is high. Change the battery pack or place it in a cool place.



- No memory card is inserted (p. 25).
- When the indicator flashes, there are not enough free spaces for recording images. Delete unnecessary images (p. 54), or format the memory card after storing the images on other media (p. 72).
- The image data base file may be damaged. Check the data base file by selecting [MENU] → [Setup] → [Media Settings] → [Repair Img. DB F.] → the recording medium.



- The memory card is damaged.
- Format the memory card with your camcorder (p. 72).



- Incompatible memory card is inserted (p. 26).



- The memory card is write-protected.
- Access to the memory card was restricted on another device.



- There is something wrong with the flash.



- The amount of lights is not sufficient, so camera-shake easily occurs. Use the flash.
- The camcorder is unsteady, so camera-shake easily occurs. Hold the camcorder steady with both hands and record the image. However, note that the camera-shake warning indicator does not disappear.



- The recording medium is full.

- Photos cannot be recorded during processing. Wait for a while, then record.
- When [[REC Mode] is set to [Highest Quality **FX**] or [60p Quality **PS**], you cannot capture photos while recording movies. Furthermore, if [[Frame Rate] is set to [24p], you cannot record photos while the camcorder is in movie recording standby mode.

Recording time of movies/number of recordable photos

“HD” stands for high definition image quality, and “STD” stands for standard definition image quality.

Expected time of recording and playback with each battery pack

Recording time

Approximate time available when you use a fully charged battery pack.

HDR-PJ710/PJ710V



(unit: minute)

Battery pack	Continuous recording time		Typical recording time	
	HD	STD	HD	STD
Image quality				
NP-FV50 (supplied)	110	120	55	60
NP-FV70	230	250	115	125
NP-FV100	455	500	225	250

HDR-CX760V/PJ760/PJ760V

(unit: minute)

Battery pack	Continuous recording time		Typical recording time	
	HD	STD	HD	STD
Image quality				
NP-FV50 (supplied)	110	120	55	60
	115	125	55	60
NP-FV70	230	250	115	125
	240	260	120	130
NP-FV100	455	500	225	250
	485	515	240	255

- Top: When the LCD screen is opened
Bottom: When recording with the viewfinder without opening the LCD screen
- Each recording time is measured when the camcorder is recording high definition image quality (HD) movies with [ REC Mode] set to [Standard ].

- Typical recording time shows the time when you repeat recording start/stop, switching the MODE lamp, and zooming.
- Times measured when using the camcorder at 25 °C (77 °F). 10 °C to 30 °C (50 °F to 86 °F) is recommended.
- The recording and playback time will be shorter when you use your camcorder in low temperatures.
- The recording and playback time will be shorter depending on the conditions under which you use your camcorder.

Playing time

Approximate time available when you use a fully charged battery pack.

HDR-PJ710/PJ710V

(unit: minute)

Battery pack	HD	STD
Image quality		
NP-FV50 (supplied)	200	215
NP-FV70	415	440
NP-FV100	830	870

HDR-CX760V/PJ760/PJ760V

(unit: minute)

Battery pack	HD	STD
Image quality		
NP-FV50 (supplied)	200	215
	225	240
NP-FV70	415	440
	465	490
NP-FV100	830	870
	925	980

- Top: When the LCD screen is opened
Bottom: When playing with the viewfinder without opening the LCD screen

Expected recording time of movies

Internal memory

HDR-PJ710/PJ710V

High definition image quality (HD) in h (hour) and min (minute)

Recording mode	Recording time	
	HDR-PJ710	HDR-PJ710V
[60p Quality PS]	2 h 35 min (2 h 35 min)	2 h 20 min (2 h 20 min)
[Highest Quality FX]	3 h 5 min (3 h 5 min)	2 h 45 min (2 h 45 min)
[High Quality FH]	4 h 10 min (4 h 10 min)	3 h 45 min (3 h 45 min)
[Standard HQ]	7 h 25 min (5 h 35 min)	6 h 40 min (5 h 5 min)
[Long Time LP] (5.1ch)*	12 h 45 min (10 h 30 min)	11 h 35 min (9 h 30 min)
[Long Time LP] (2ch)*	13 h 15 min (10 h 50 min)	11 h 55 min (9 h 45 min)

Standard definition image quality (STD) in h (hour) and min (minute)

Recording mode	Recording time	
	HDR-PJ710	HDR-PJ710V
[Standard HQ] (5.1ch)*	7 h 40 min (7 h 5 min)	6 h 55 min (6 h 20 min)
[Standard HQ] (2ch)*	7 h 55 min (7 h 15 min)	7 h 5 min (6 h 35 min)

HDR-PJ760/CX760V/PJ760V

High definition image quality (HD) in h (hour) and min (minute)

Recording mode	Recording time	
	HDR-PJ760	HDR-CX760V/ PJ760V
[60p Quality PS]	7 h 55 min (7 h 55 min)	7 h 40 min (7 h 40 min)
[Highest Quality FX]	9 h 20 min (9 h 20 min)	9 h (9 h)

Recording mode	Recording time	
	HDR-PJ760	HDR-CX760V/ PJ760V
[High Quality FH]	12 h 40 min (12 h 40 min)	12 h 15 min (12 h 15 min)
[Standard HQ]	22 h 20 min (16 h 55 min)	21 h 35 min (16 h 25 min)
[Long Time LP] (5.1ch)*	38 h 35 min (31 h 40 min)	37 h 20 min (30 h 40 min)
[Long Time LP] (2ch)*	39 h 55 min (32 h 35 min)	38 h 40 min (31 h 35 min)

Standard definition image quality (STD) in h (hour) and min (minute)

Recording mode	Recording time	
	HDR-PJ760	HDR-CX760V/ PJ760V
[Standard HQ] (5.1ch)*	23 h 5 min (21 h 15 min)	22 h 25 min (20 h 35 min)
[Standard HQ] (2ch)*	23 h 50 min (21 h 50 min)	23 h 5 min (21 h 10 min)

* You can change the recording sound format with [Audio Mode] (p. 71).

- You can record movies of a maximum of 3,999 scenes with high definition image quality (HD), and 9,999 scenes with standard definition image quality (STD).
- The maximum continuous recording time of movies is approximately 13 hours.
- If you want to record up to the maximum recording time indicated in the table, you need to delete the demonstration movie on your camcorder.
- Your camcorder uses the VBR (Variable Bit Rate) format to automatically adjust image quality to suit the recording scene. This technology causes fluctuations in the recording time of the media. Movies containing quickly moving and complex images are recorded at a higher bit-rate, and this reduces the overall recording time.

Notes

- The number in () is the minimum recordable time.

Memory card

High definition image quality (HD)

	(unit: minute)				
	2 GB	4 GB	8 GB	16 GB	32 GB
PS	8 (8)	15 (15)	35 (35)	75 (75)	150 (150)
FX	10 (10)	20 (20)	40 (40)	85 (85)	180 (180)
FH	10 (10)	25 (25)	60 (60)	120 (120)	245 (245)
HQ	25 (15)	50 (35)	105 (80)	210 (160)	430 (325)
LP 5.1ch*	40 (35)	85 (70)	180 (150)	370 (300)	740 (610)
LP 2ch*	45 (35)	90 (75)	185 (155)	380 (310)	770 (630)

Standard definition image quality (STD)

	(unit: minute)				
	2 GB	4 GB	8 GB	16 GB	32 GB
HQ 5.1ch*	25 (20)	50 (50)	110 (100)	220 (205)	445 (410)
HQ 2ch*	25 (25)	55 (50)	110 (100)	225 (210)	460 (420)

* You can change the recording sound format with [Audio Mode] (p. 71).

- When using a Sony memory card.

Notes

- The recordable time may vary depending on the recording and subject conditions and [REC Mode] and [Frame Rate] (p. 71).
- The number in () is the minimum recordable time.

Expected number of recordable photos

Internal memory

You can record the maximum 40,000 photos.

Memory card

	16:9 24,1M
2 GB	200
4 GB	400
8 GB	810
16 GB	1600
32 GB	3250

- When using a Sony memory card.
- The number of recordable photos of memory card shown is for the maximum image size of your camcorder. The actual number of recordable photos is displayed on the LCD screen during recording (p. 93).
- The number of recordable photos of memory card may vary depending on the recording conditions.

Notes

- The unique pixel array of Sony's ClearVid and the image processing system of Sony's BIONZ allows still image resolution equivalent to the sizes described.

On bit-rate and recording pixels

- The bit-rate, pixels and aspect ratio of each recording mode for movies (movie + audio, etc.)
 - High definition image quality (HD):
 - PS: Max. 28 Mbps 1,920 × 1,080 pixels/16:9
 - FX: Max. 24 Mbps 1,920 × 1,080 pixels/16:9
 - FH: Approx. 17 Mbps (average) 1,920 × 1,080 pixels/16:9
 - HQ: Approx. 9 Mbps (average) 1,440 × 1,080 pixels/16:9

LP: Approx. 5 Mbps (average) $1,440 \times 1,080$
pixels/16:9

– Standard definition image quality (STD):

HQ: Approx. 9 Mbps (average) 720×480
pixels/16:9, 4:3

• The photo recording pixels and the aspect ratio.

– Photo recording mode, Dual capture:

$6,544 \times 3,680$ dots/16:9

$4,912 \times 3,680$ dots/4:3

$4,672 \times 2,628$ dots/16:9

$2,592 \times 1,944$ dots/4:3

$1,920 \times 1,080$ dots/16:9

640×480 dots/4:3

– Capturing a photo from a movie:

$1,920 \times 1,080$ dots/16:9

640×360 dots/16:9

640×480 dots/4:3

About handling of your camcorder

On use and care

- The camcorder is not dustproofed, dripproofed or waterproofed.
- Do not hold the camcorder by the following parts, and also do not hold the camcorder by the jack covers.

Shoe cover

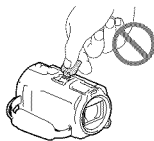

Lens hood

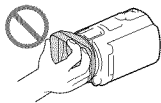

LCD Screen

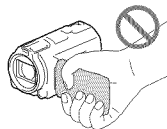

Battery pack

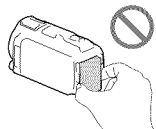

Built-in USB Cable

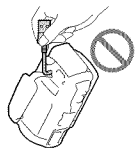

Viewfinder (HDR-CX760V/PJ760/PJ760V)

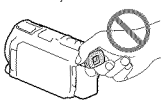

- Do not aim at the sun. Doing so might cause your camcorder to malfunction. Take images of the sun only in low light conditions, such as at dusk.
- Use the camcorder in accordance with local regulations.
- Do not use or store the camcorder and accessories in the following locations:
 - Anywhere extremely hot, cold or humid. Never leave them exposed to temperatures above 60 °C (140 °F), such as under direct sunlight, near heaters or in a car parked in the sun. They may malfunction or become deformed.

- Near strong magnetic fields or mechanical vibration. The camcorder may malfunction.
- Near strong radio waves or radiation. The camcorder may not be able to record properly.
- Near tuner devices such as TVs or radio. Noise may occur.
- On a sandy beach or anywhere dusty. If sand or dust gets in your camcorder, it may malfunction. Sometimes this malfunction cannot be repaired.
- Near windows or outdoors, where the LCD screen, the viewfinder (HDR-CX760V/PJ760/PJ760V), or the lens may be exposed to direct sunlight. This damages the inside of the viewfinder (HDR-CX760V/PJ760/PJ760V) or the LCD screen.

- Operate your camcorder on DC 6.8 V/7.2 V (battery pack) or DC 8.4 V (AC Adaptor).
- For DC or AC operation, use the accessories recommended in these operating instructions.
- Do not let your camcorder get wet, for example, from rain or sea water. If your camcorder gets wet, it may malfunction. Sometimes this malfunction cannot be repaired.
- If any solid object or liquid gets inside the casing, unplug your camcorder and have it checked by a Sony dealer before operating it any further.
- Avoid rough handling, disassembling, modifying, physical shock, or impact such as hammering, dropping or stepping on the product. Be particularly careful of the lens.
- Keep the LCD screen and the viewfinder (HDR-CX760V/PJ760/PJ760V) closed when you are not using your camcorder.
- Do not wrap your camcorder with a towel, for example, and operate it. Doing so might cause heat to build up inside.
- When disconnecting the power cord (mains lead), pull it by the plug and not the cord.
- Do not damage the power cord (mains lead) such as by placing anything heavy on it.
- Do not use a deformed or damaged battery pack.
- Keep metal contacts clean.
- If the battery electrolytic liquid has leaked:
 - Consult your local authorized Sony service facility.

- Wash off any liquid that may have contacted your skin.
- If any liquid gets in your eyes, wash with plenty of water and consult a doctor.

When not using your camcorder for a long time

- To keep your camcorder in optimum state for a long time, turn it on and let it run by recording and playing back images about once a month.
- Use up the battery pack completely before storing it.

Note on the camcorder/battery pack temperature

- When the temperature of the camcorder or battery pack becomes extremely high or extremely low, you may not be able to record or play back on the camcorder, due to the protection features of the camcorder being activated in such situations. In this case, an indicator appears on the LCD screen or the viewfinder (HDR-CX760V/PJ760/PJ760V).

Notes on charging through the USB cable

- Operation with all computers is not assured.
- If you connect the camcorder to a laptop computer that is not connected to a power source, the battery of the laptop computer will continue to use up its charge. Do not leave the camcorder connected to a computer in this manner.
- Charging with a personally assembled computer, with a converted computer, or through a USB hub are not guaranteed. The camcorder may not function correctly depending on the USB device which is used with the computer.

Moisture condensation

If your camcorder is brought directly from a cold place to a warm place, moisture may condense inside your camcorder. This may cause a malfunction to your camcorder.

- If moisture condensation has occurred
Leave your camcorder for about 1 hour without turning it on.
- Note on moisture condensation
Moisture may condense when you bring your camcorder from a cold place into a warm place (or vice versa) or when you use your camcorder in a humid place as follows:
 - You bring your camcorder from a ski slope into a place warmed up by a heating device.
 - You bring your camcorder from an air conditioned car or room into a hot place outside.
 - You use your camcorder after a squall or a rain.
 - You use your camcorder in a hot and humid place.
- How to prevent moisture condensation
When you bring your camcorder from a cold place into a warm place, put your camcorder in a plastic bag and seal it tightly. Remove the bag when the air temperature inside the plastic bag has reached the surrounding temperature (after about 1 hour).

When the camcorder is connected to a computer or accessories

- Do not try to format the recording media of the camcorder using a computer. If you do so, your camcorder may not operate correctly.
- When connecting the camcorder to another device with communication cables, be sure to insert the connector plug in the correct way. Pushing the plug forcibly into the terminal will damage the terminal and may result in a malfunction of the camcorder
- When the camcorder is connected to other devices through a USB connection and the

power of the camcorder is turned on, do not close the LCD panel. The image data that has been recorded may be lost.

Notes on optional accessories

- We recommend using genuine Sony accessories.
- Genuine Sony accessories may not be available in some countries/regions.

Active Interface Shoe

- The Active Interface Shoe supplies power to accessories such as a video light, a flash, or a microphone (sold separately). The accessory can be turned on or off as you open or close the LCD screen, and the viewfinder (HDR-CX760V/PJ760/PJ760V) of your camcorder. Refer to the operating instructions supplied with your accessory for details.
- The Active Interface Shoe has a safety device for fixing the installed accessory securely. To connect an accessory, press down and push it to the end, and then tighten the screw. To remove an accessory, loosen the screw, and then press down and pull out the accessory.
- When you are recording movies with an external flash (sold separately) connected to the accessory shoe, turn off the power of the external flash to prevent charging noise being recorded.
- You cannot use an external flash (sold separately) and the built-in flash at the same time.
- When an external microphone (sold separately) is connected, it takes precedence over the built-in microphone.

On Wireless Remote Commander

- Remove the insulation sheet before using the Wireless Remote Commander.

Insulation sheet

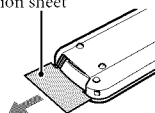

- Point the Wireless Remote Commander towards the remote sensor to operate your camcorder (p. 13).
- When no commands have been sent from the Wireless Remote Commander within a certain period, the light blue frame disappears. When you press any of ◀▶/▲▼, or ENTER again, the frame appears at the position where it was displayed last.
- You cannot select some buttons on the LCD screen, or the viewfinder (HDR-CX760V/PJ760/PJ760V) using ◀▶/▲▼.

To change the battery of the Wireless Remote Commander

- ① While pressing on the tab, inset your fingernail into the slit to pull out the battery case.
- ② Place a new battery with the + side facing up.
- ③ Insert the battery case back into the Wireless Remote Commander until it clicks.

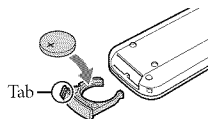

WARNING

Battery may explode if mistreated. Do not recharge, disassemble or dispose of in fire.

- When the lithium battery becomes weak, the operating distance of the Wireless Remote Commander may shorten, or the Wireless Remote Commander may not function properly. In this case, replace the battery with a Sony CR2025 lithium battery. Use of another battery may present a risk of fire or explosion.

LCD screen

- Do not apply excessive pressure on the LCD screen, as it may cause uneven color and other damage.

- If your camcorder is used in a cold place, a residual image may appear on the LCD screen. This is not a malfunction.
- While using your camcorder, the back of the LCD screen may heat up. This is not a malfunction.

To clean the projector lens (HDR-PJ710/PJ710V/PJ760/PJ760V)

- Wipe the lens gently with a soft cloth such as a cleaning cloth or glass cleaning cloth.
- Stubborn stains may be removed with a soft cloth such as a cleaning cloth or glass cleaning cloth lightly dampened with water.
- Never use a solvent such as alcohol, benzene or thinner; acid, alkaline or abrasive detergent; or a chemical cleaning cloth, as they will damage the lens surface.

On adjustment of the touch panel ([Calibration])

The buttons on the touch panel may not work correctly. If this happens, follow the procedure below. It is recommended that you connect your camcorder to the wall outlet (wall socket) using the supplied AC Adaptor during the operation.

- ① [MENU] → [Setup] → [General Settings] → [Calibration].

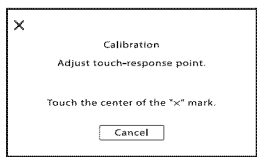

- ② Touch "x" displayed on the screen with the corner of memory card or the like 3 times. Touch [Cancel] to cancel calibration.

Notes

- If you did not press the right spot, try the calibration again.
- Do not use a sharp-pointed object for calibration. Doing so may damage the LCD screen.
- You cannot calibrate the LCD screen if it is rotated, or closed with the screen facing out.

On handling the casing

- If the casing is soiled, clean the camcorder body with a soft cloth lightly moistened with water, and then wipe the casing with a dry soft cloth.
- Avoid the following to avoid damage to the finish:
 - Using chemicals such as thinner, benzene, alcohol, chemical cloths, repellent, insecticide and sunscreen
 - Handling the camcorder with above substances on your hands
 - Leaving the casing in contact with rubber or vinyl objects for a long period of time

On handling the LCD screen and the light-emitting part of flash

If fingerprints or dust make dirty, it is recommended that you use a soft cloth to clean it.

About the Carl Zeiss lens

Your camcorder is equipped with a Carl Zeiss lens, which was developed jointly by Carl Zeiss, in Germany, and Sony Corporation, and produces superior images. It adopts the MTF measurement system for video cameras and offers a quality typical of a Carl Zeiss lens. Also, the lens for your camcorder is T*[®]-coated to suppress unwanted reflections and faithfully reproduce colors.

MTF= Modulation Transfer Function. The number value indicates the amount of light from a subject coming into the lens.

About care and storage of the lens

- Wipe the surface of the lens clean with a soft cloth in the following instances:
 - When there are fingerprints on the lens surface
 - In hot or humid locations
 - When the lens is exposed to salty air such as at the seaside
- Store in a well-ventilated location subject to little dirt or dust.
- To prevent mold, periodically clean the lens as described above.

On charging the pre-installed rechargeable battery

Your camcorder has a pre-installed rechargeable battery to retain the date, time, and other settings even when the LCD screen is closed. The pre-installed rechargeable battery is always charged while your camcorder is connected to the wall outlet (wall socket) via the AC Adaptor or while the battery pack is attached. The rechargeable battery will be fully discharged in about 3 months if you do not use your camcorder at all. Use your camcorder after charging the pre-installed rechargeable battery.

However, even if the pre-installed rechargeable battery is not charged, the camcorder operation will not be affected as long as you are not recording the date.

How to charge the pre-installed rechargeable battery

Connect your camcorder to a wall outlet (wall socket) using the supplied AC Adaptor, and leave it with the LCD screen closed for more than 24 hours.

Note on disposal/transfer of the camcorder

Even if you delete all movies and still images, or perform [Format] (p. 72), data on the internal memory may not be completely erased. When you transfer the camcorder, it is recommended that you select [MENU] → [Setup] → [Media Settings] → [Format] → [Empty] to prevent the recovery of your data. Also, when you dispose of the camcorder, it is recommended that you destroy the actual body of the camcorder.

Note on disposal/transfer of the memory card

Even if you delete data in the memory card or format the memory card on your camcorder or a computer, you may not delete data from the memory card completely. When you give the memory card to somebody, it is recommended that you delete data completely using data deletion software on a computer. Also, when you dispose of the memory card, it is recommended that you destroy the actual body of the memory card.

Specifications

System

Signal format: NTSC color, EIA standards
HDTV 1080/60i, 1080/60p specification

Movie recording format:
HD: MPEG-4 AVC/H.264 AVCHD format
Ver.2.0 compatible
STD: MPEG2-PS

Audio recording system:
Dolby Digital 2ch/5.1ch
Dolby Digital 5.1 Creator

Photo file format:
DCF Ver.2.0 Compatible
Exif Ver.2.3 Compatible
MPF Baseline Compatible

Recording media (Movie/Photo):

Internal memory
HDR-PJ710/PJ710V: 32 GB
HDR-CX760V/PJ760/PJ760V: 96 GB
"Memory Stick PRO Duo" media
SD card (Class 4 or faster)
The capacity that a user can use
HDR-PJ710: Approx. 31.8 GB*²
HDR-PJ710V: Approx. 28.8 GB*¹
HDR-CX760V/PJ760V: 92.6 GB*¹
HDR-PJ760: 95.6 GB*²

*¹ 1 GB equals 1 billion bytes, 2.8 GB is used for pre-installed map and another portion is used for data management functions. Only pre-installed demonstration movie may be deleted.

*² 1 GB equals 1 billion bytes, a portion of which is used for system management and/or application files. Only pre-installed demonstration movie may be deleted.

Viewfinder:

Electronic viewfinder (color) (HDR-CX760V/PJ760/PJ760V)

Image device:

6.3 mm (1/2.88 type) CMOS Sensor
Recording pixels (photo, 16:9):
Max. 24.1 mega (6 544 × 3 680) pixels*³
Gross: Approx. 6 650 000 pixels
Effective (movie, 16:9)*⁴:
Approx. 6 140 000 pixels
Effective (photo, 16:9):
Approx. 6 140 000 pixels
Effective (photo, 4:3):
Approx. 4 600 000 pixels

Lens:

Carl Zeiss Vario-Sonnar T*
10 × (Optical)*⁴, 17 × (Extended, while recording movies)*⁵, 120 × (Digital)
Filter diameter: 52 mm (2 1/8 in.)
37 mm (1 1/2 in.) (When attaching the Step Down Ring)
F1.8 ~ F3.4
Focal length:
f = 3.8 mm ~ 38.0 mm (5/32 in. ~ 1 1/2 in.)
When converted to a 35 mm still camera
For movies*⁴: 26.0 mm ~ 260 mm (1 1/16 in. ~ 10 1/4 in.) (16:9)
For photos: 26.0 mm ~ 260 mm (1 1/16 in. ~ 10 1/4 in.) (16:9)

Color temperature: [Auto], [One Push], [Indoor] (3 200 K), [Outdoor] (5 800 K)

Minimum illumination:

6 lx (lux) (in default setting, shutter speed 1/60 second)
3 lx (lux) ([Low Lux] is set to [On], shutter speed 1/30 second)
0 lx (lux) (NIGHTSHOT is set to [On])

*³ The unique pixel array of Sony's ClearVid and the image processing system (BIONZ) allow still image resolution equivalent to the sizes described.

*⁴ [SteadyShot] is set to [Standard] or [Off].

*⁵ [SteadyShot] is set to [Active].

Input/Output connectors

A/V Remote Connector: Video and audio output jack

HDMI OUT jack: HDMI mini connector

USB jack: mini-AB/Type A (Built-in USB)

Headphone jack: Stereo minijack (φ 3.5 mm)

MIC input jack: Stereo minijack (φ 3.5 mm)

LCD screen

Picture: 7.5 cm (3.0 type, aspect ratio 16:9)

Total number of pixels:

921 600 (1 920 × 480)

Projector (HDR-PJ710/PJ710V/PJ760/PJ760V)

Projection type: DLP

Light source: LED (R/G/B)

Focus: Manual

Throw Distance: 0.5 m (1.6 feet) or over

Contrast ratio: 1500:1

Resolution (output): nHD (640 × 360)

Continuous projection time (when using the supplied battery pack):
Approx. 1 h 40 min.

General

Power requirements: DC 6.8 V/7.2 V (battery pack) DC 8.4 V (AC Adaptor)

USB Charging: DC 5 V 500 mA/1.5 A

Average power consumption:

HDR-PJ710/PJ710V

HD: 3.4 W STD: 3.1 W

HDR-CX760V/PJ760/PJ760V

During camera recording using the viewfinder at normal brightness:

HD: 3.2 W STD: 3.0 W

During camera recording using LCD screen at normal brightness:

HD: 3.4 W STD: 3.1 W

Operating temperature: 0 °C to 40 °C (32 °F to 104 °F)

Storage temperature: -20 °C to +60 °C (-4 °F to +140 °F)

Dimensions (approx.):

HDR-CX760V:

67.5 mm × 73.5 mm × 137.5 mm (2 3/4 in. × 3 in. × 5 1/2 in.) (w/h/d) including the projecting parts

107.5 mm × 87.5 mm × 166 mm (4 1/4 in. × 3 1/2 in. × 6 5/8 in.) (w/h/d) including the projecting parts, the supplied rechargeable battery pack, and the lens hood attached

HDR-PJ710/PJ710V:

71.5 mm × 72 mm × 124 mm (2 7/8 in. × 2 7/8 in. × 5 in.) (w/h/d) including the projecting parts

107.5 mm × 87.5 mm × 161.5 mm (4 1/4 in. × 3 1/2 in. × 6 3/8 in.) (w/h/d) including the projecting parts, the supplied rechargeable battery pack, and the lens hood attached

HDR-PJ760/PJ760V:

71.5 mm × 73.5 mm × 137.5 mm (2 7/8 in. × 3 in. × 5 1/2 in.) (w/h/d) including the projecting parts

107.5 mm × 87.5 mm × 166 mm (4 1/4 in. × 3 1/2 in. × 6 5/8 in.) including the projecting parts, the supplied rechargeable battery pack, and the lens hood attached

Mass (approx.)

HDR-CX760V:

555 g (1 lb 3 oz) main unit only

655 g (1 lb 7 oz) including the supplied rechargeable battery pack, and the lens hood

HDR-PJ710:

560 g (1 lb 3 oz) main unit only

665 g (1 lb 7 oz) including the supplied rechargeable battery pack, and the lens hood

HDR-PJ710V:

565 g (1 lb 3 oz) main unit only

670 g (1 lb 7 oz) including the supplied rechargeable battery pack, and the lens hood

HDR-PJ760:

575 g (1 lb 4 oz) main unit only

675 g (1 lb 7 oz) including the supplied rechargeable battery pack, and the lens hood

HDR-PJ760V:

580 g (1 lb 4 oz) main unit only

680 g (1 lb 7 oz) including the supplied rechargeable battery pack, and the lens hood

AC Adaptor AC-L200C/AC-L200D

Power requirements: AC 100 V - 240 V, 50 Hz/60 Hz

Current consumption: 0.35 A - 0.18 A

Power consumption: 18 W

Output voltage: DC 8.4 V*

Operating temperature: 0 °C to 40 °C (32 °F to 104 °F)

Storage temperature: -20 °C to +60 °C (-4 °F to +140 °F)

Dimensions (approx.): 48 mm × 29 mm × 81 mm (1 15/16 in. × 1 3/16 in. × 3 1/4 in.) (w/h/d) excluding the projecting parts

Mass (approx.): 170 g (6.0 oz) excluding the power cord (mains lead)

* See the label on the AC Adaptor for other specifications.

Rechargeable battery pack NP-FV50

Maximum output voltage: DC 8.4 V

Output voltage: DC 6.8 V

Maximum charge voltage: DC 8.4 V

Maximum charge current: 2.1 A

Capacity

Typical: 7.0 Wh (1 030 mAh)

Minimum: 6.6 Wh (980 mAh)

Type: Li-ion

Design and specifications of your camcorder and accessories are subject to change without notice.

- Manufactured under license from Dolby Laboratories.

On trademarks

- “Handycam” and **HANDYCAM** are registered trademarks of Sony Corporation.
- “AVCHD,” “AVCHD Progressive,” “AVCHD” logotype and “AVCHD Progressive” logotype are trademarks of Panasonic Corporation and Sony Corporation.
- “Memory Stick,” “,” “Memory Stick Duo,” “**MEMORY STICK DUO**,” “Memory Stick PRO Duo,” “**MEMORY STICK PRO DUO**,” “Memory Stick PRO-HG Duo,” “**MEMORY STICK PRO-HG DUO**,” “MagicGate,” “**MAGIC GATE**,” “MagicGate Memory Stick” and “MagicGate Memory Stick Duo” are trademarks or registered trademarks of Sony Corporation.
- “InfoLITHIUM” is a trademark of Sony Corporation.
- “x.v.Color” is a trademark of Sony Corporation.
- “BIONZ” is a trademark of Sony Corporation.
- **S-MASTER** is a registered trademark of Sony Corporation.
- “BRAVIA” is a trademark of Sony Corporation.
- “DVDirect” is a trademark of Sony Corporation.
- Blu-ray Disc™ and Blu-ray™ are trademarks of the Blu-ray Disc Association.
- Dolby and the double-D symbol are trademarks of Dolby Laboratories.
- HDMI, the HDMI logo and High-Definition Multimedia Interface are trademarks or registered trademarks of HDMI Licensing LLC in the United States and other countries.
- Microsoft, Windows, Windows Vista, and DirectX are either registered trademarks or trademarks of Microsoft Corporation in the United States and/or other countries.
- Mac and Mac OS are registered trademarks of Apple Inc. in the U.S. and other countries.
- Intel, Intel Core, and Pentium are trademarks or registered trademarks of Intel Corporation or its subsidiaries in the United States and other countries.
- “” and “PlayStation” are registered trademarks of Sony Computer Entertainment Inc.
- Adobe, the Adobe logo, and Adobe Acrobat are either registered trademarks or trademarks of Adobe Systems Incorporated in the United States and/or other countries.

- NAVTEQ and the NAVTEQ Maps logo are trademarks of NAVTEQ in the US and other countries.
- SDXC logo is a trademark of SD-3C, LLC.
- MultiMediaCard is a trademark of MultiMediaCard Association.

All other product names mentioned herein may be the trademarks or registered trademarks of their respective companies. Furthermore, ™ and ® are not mentioned in each case in this manual.



Add further enjoyment with your PlayStation 3 by downloading the application for PlayStation 3 from PlayStation Store (where available.)

The application for PlayStation 3 requires PlayStation Network account and application download.

Accessible in areas where the PlayStation Store is available.

END-USER LICENSE AGREEMENT FOR MAP DATA FOR VIDEO CAMERA RECORDER PRODUCTS (HDR- CX760V/PJ710V/PJ760V)

YOU SHOULD CAREFULLY READ THE FOLLOWING AGREEMENT BEFORE USING THIS SOFTWARE.

IMPORTANT-READ CAREFULLY: This End-User License Agreement (“LICENSE”) is a legal agreement between you and Sony Corporation (“SONY”), the licensor of the map data included in your video camera recorder product (“PRODUCT”). Such map data, including subsequent updates/upgrades, is referred to herein as the SOFTWARE. This LICENSE covers only the SOFTWARE. You may use the SOFTWARE only in connection with your use of the PRODUCT. By touching the “AGREE” button appearing on the screen of the PRODUCT in connection with this License, you agree to be bound by the terms of this LICENSE. If you do not agree to the terms of this LICENSE, SONY is unwilling to license the SOFTWARE to you. In such event, the SOFTWARE will not be available and you may not use the SOFTWARE.

SOFTWARE LICENSE

The SOFTWARE is protected by copyright laws and international copyright treaties, as well as other intellectual property laws and treaties. The SOFTWARE is licensed, not sold.

GRANT OF LICENSE

This LICENSE grants you the following rights on a non-exclusive basis:
SOFTWARE. You may use the SOFTWARE on one unit of the PRODUCT.
Use. You may use the SOFTWARE for its own use.

DESCRIPTION OF OTHER RIGHTS AND LIMITATIONS

Restrictions. You may not transfer or distribute any part of the SOFTWARE in any form for any purpose except as expressly permitted in this LICENSE. You may not use the SOFTWARE with any products, systems or applications other than with the PRODUCT. Except as otherwise provided in this LICENSE, you may not use and may not permit any third party to use the SOFTWARE separated from the PRODUCT (in whole or in part, including, but

not limited to, reproductions, outputs or extractions or other works thereof in any form) for the purpose of rental or lease whether with any license fee or not. Some jurisdictions do not allow the restrictions of such rights, in such case the above restrictions may not apply to you.

Limitation on Reverse Engineering, Decompile and Disassembly. You may not (i) extract the SOFTWARE from the PRODUCT, (ii) reproduce, copy, modify, port, translate, or create derivative works of the SOFTWARE in whole or in part, or (iii) reverse engineer, decompile, disassemble the SOFTWARE by any means whatsoever in whole or in part for any purpose. Some jurisdictions do not allow the limitation of such rights, in such case the above limitation may not apply to you.

Trademarks and Notices: You may not remove, alter, cover or deface any trademarks or copyright notices on the SOFTWARE.

Data Files. The SOFTWARE may create data files automatically for use with the SOFTWARE. Any such data files will be deemed to be part of the SOFTWARE.

SOFTWARE Transfer. You may permanently transfer all of your rights under this LICENSE only as part of a sale or transfer of the PRODUCT, provided you retain no copies of the SOFTWARE, transfer all of the SOFTWARE (including all copies (only if permitted to copy under “Limitation on Reverse Engineering, Decompile and Disassembly” Paragraph above), component parts, the media and printed materials, all versions and any upgrades of the SOFTWARE and this LICENSE), and the recipient agrees to the terms and conditions of this LICENSE.

Termination. Without prejudice to any other rights, SONY may terminate this LICENSE if you fail to comply with the terms and conditions of this LICENSE. In such event, you must stop using the SOFTWARE and all of its component parts. The provisions of this LICENSE “COPYRIGHT,” “HIGH RISK ACTIVITIES,” “EXCLUSION OF WARRANTY ON SOFTWARE,” “LIMITATION OF LIABILITY,” “PROHIBITION ON EXPORT,” “SEVERABILITY,” and “GOVERNING LAW AND JURISDICTION” Sections, “Confidentiality” Paragraph of this Section and this Paragraph shall survive any expiration or termination of this LICENSE.

Confidentiality. You agree to keep information contained in the SOFTWARE which is not publicly known confidential to yourself, and not to disclose such information to others without SONY’s prior written approval.

COPYRIGHT

All title and copyright in and to the SOFTWARE (including but not limited to any map data, images, photographs, animation, video, audio, music, text and “applets”, incorporated into the SOFTWARE), and any copies of the SOFTWARE, are owned by SONY,

licensors and suppliers to SONY and their respective affiliates (such licensors and suppliers to SONY, together with their respective affiliates, are hereinafter collectively referred to as "SONY's Licensors"). All rights not specifically granted under this LICENSE are reserved by SONY or SONY's Licensors.

HIGH RISK ACTIVITIES

The SOFTWARE is not fault-tolerant and is not designed, manufactured or intended for use in hazardous environments requiring fail-safe performance, such as in the operation of nuclear facilities, aircraft navigation or communication systems, air traffic control, direct life support machines, or weapons systems, in which the failure of the SOFTWARE could lead to death, personal injury, or severe physical or environmental damage ("High Risk Activities"). SONY, its affiliates, their respective suppliers and SONY's Licensors specifically disclaim any express or implied warranty of fitness for High Risk Activities.

EXCLUSION OF WARRANTY ON SOFTWARE

You expressly acknowledge and agree that use of the SOFTWARE is at your sole risk. The SOFTWARE is provided "AS IS" and without warranty of any kind and SONY, its affiliates, its and their respective suppliers and SONY's Licensors (in this section, SONY, its affiliates, their respective suppliers and SONY's Licensors shall be collectively referred to as "SONY") EXPRESSLY DISCLAIMS ALL WARRANTIES AND CONDITIONS, EXPRESS OR IMPLIED, ARISING BY LAW OR OTHERWISE, INCLUDING, BUT NOT LIMITED TO, THE IMPLIED WARRANTIES AND CONDITIONS OF QUALITY, NON-INFRINGEMENT, MERCHANTABILITY AND FITNESS FOR A PARTICULAR PURPOSE. SONY DOES NOT WARRANT THAT THE FUNCTIONS CONTAINED IN THE SOFTWARE WILL MEET YOUR REQUIREMENTS, OR THAT THE OPERATION OF THE SOFTWARE WILL BE UNINTERRUPTED OR ERROR FREE. SONY DOES NOT WARRANT OR MAKE ANY REPRESENTATIONS REGARDING THE USE, INABILITY TO USE OR THE RESULTS OF THE USE OF THE SOFTWARE IN TERMS OF ITS CORRECTNESS, ACCURACY, RELIABILITY, OR OTHERWISE. SOME JURISDICTIONS DO NOT ALLOW THE EXCLUSION OF IMPLIED WARRANTIES, IN SUCH CASE THE ABOVE EXCLUSIONS MAY NOT APPLY TO YOU.

You expressly understand that the data in the SOFTWARE may contain inaccurate or incomplete information due to the passage of time, changing circumstances, sources used and the nature of collecting comprehensive geographic data, any of which may lead to incorrect results.

LIMITATION OF LIABILITY

IN THIS SECTION SONY, ITS AFFILIATES, ITS AND THEIR RESPECTIVE SUPPLIERS AND SONY'S LICENSORS SHALL BE COLLECTIVELY REFERRED TO AS "SONY" TO THE MAXIMUM EXTENT PERMITTED UNDER APPLICABLE LAW. SONY SHALL NOT BE LIABLE FOR ANY CLAIM, DEMAND OR ACTION, IRRESPECTIVE OF THE NATURE OF THE CAUSE OF CLAIM, DEMAND OR ACTION, ALLEGING ANY LOSS OR DAMAGES, DIRECT OR INDIRECT, WHICH MAY RESULT FROM THE USE OR POSSESSION OF THE SOFTWARE; NOR FOR ANY LOSS OF PROFIT, REVENUE, CONTRACTS OR SAVINGS, NOR ANY OTHER DIRECT, INDIRECT, INCIDENTAL, SPECIAL OR CONSEQUENTIAL DAMAGES ARISING OUT OF YOUR USE OF OR INABILITY TO USE THE SOFTWARE, ANY DEFECT IN THE SOFTWARE, OR THE BREACH OF THE TERMS AND CONDITIONS, WHETHER IN AN ACTION IN CONTRACT OR TORT OR BASED ON A WARRANTY, EVEN IF SONY HAS BEEN ADVISED OF THE POSSIBILITY OF SUCH DAMAGES EXCEPT IN THE EVENT OF SONY'S GROSS NEGLIGENCE OR WILLFUL MISCONDUCT, OF DEATH OR PERSONAL INJURY, AND OF DAMAGES DUE TO THE DEFECTIVE NATURE OF THE PRODUCT. IN ANY CASE, SAVE FOR THE FOREGOING EXCEPTIONS, SONY'S ENTIRE LIABILITY UNDER ANY PROVISION OF THIS LICENSE SHALL BE LIMITED TO THE AMOUNT ACTUALLY PAID ALLOCATABLE TO THE SOFTWARE. SOME JURISDICTIONS DO NOT ALLOW THE EXCLUSION OR LIMITATION OF CONSEQUENTIAL OR INCIDENTAL DAMAGES, SO THE ABOVE EXCLUSION OR LIMITATION MAY NOT APPLY TO YOU.

PROHIBITION ON EXPORT

YOU ACKNOWLEDGE THAT THE USE OF THE SOFTWARE IN SOME COUNTRIES, REGIONS, AREAS OR FACILITIES, OR THE EXPORT OF THE PRODUCTS FROM THE COUNTRY WHERE SUCH PRODUCTS ARE DESIGNED TO BE SOLD, MAY BE RESTRICTED OR PROHIBITED. YOU AGREE TO USE THE SOFTWARE OR EXPORT THE PRODUCTS IN ACCORDANCE WITH THE APPLICABLE LAWS, ORDINANCES, RULES AND REGULATIONS OF RELEVANT COUNTRIES, REGIONS, AREAS AND FACILITIES.

SEVERABILITY

If any part of this LICENSE is held invalid or unenforceable, the other parts will remain valid.

GOVERNING LAW AND JURISDICTION

This LICENSE shall be governed by the laws of Japan without giving effect to its conflict of laws

provisions or the United Nations Convention for Contracts for the International Sale of Goods, which is expressly excluded. Any dispute arising out of this LICENSE shall be subject to the exclusive venue of the Tokyo District Court, and the parties hereby consent to the venue and jurisdiction of such court. THE PARTIES HEREBY WAIVE TRIAL BY JURY WITH RESPECT TO ANY MATTERS ARISING UNDER OR RELATING TO THIS LICENSE. SOME JURISDICTIONS DO NOT ALLOW THE EXCLUSION OF THE RIGHT OF TRIAL BY JURY, IN SUCH CASE THE ABOVE EXCLUSION MAY NOT APPLY TO YOU.

ENTIRE AGREEMENT

These terms and conditions constitute the entire agreement between SONY and you pertaining to the subject matter hereof, and supersedes in their entirety any and all previously existing written or oral agreements between us with respect to such subject matter.

GOVERNMENT END USERS

If the SOFTWARE is being acquired by or on behalf of the United States government or any other entity seeking or applying rights similar to those customarily claimed by the United States government, such SOFTWARE is a "commercial item" as that term is defined in 48 C.F.R. ("FAR") 2.101, is licensed in accordance with this LICENSE, and such SOFTWARE delivered or otherwise furnished shall be marked and embedded the "Notice of Use" as designated by SONY and/or its affiliates and shall be treated in accordance with such notice.

NOTICE OF USE

CONTRACTOR (MANUFACTURER/
SUPPLIER) NAME: SONY CORPORATION
CONTRACTOR (MANUFACTURER/
SUPPLIER) ADDRESS: 1-7-1 Konan, Minato-
ku, Tokyo, Japan

These SOFTWARE are commercial items as defined in FAR 2.101 and are subject to the END-USER LICENSE AGREEMENT FOR MAP DATA FOR VIDEO CAMERA RECORDER PRODUCTS under which this SOFTWARE was provided.

If the Contracting Officer, federal government agency, or any federal official refuses to use the legend provided herein, the Contracting Officer, federal government agency, or any federal official must notify SONY prior to seeking additional or alternative rights in the Software.

Copyright and trademark information

©1993-2011 NAVTEQ
©2012 ZENRIN CO., LTD.

Australia

© Hema Maps Pty. Ltd, 2010.
Copyright. Based on data provided under license from PSMA Australia Limited (www.pasma.com.au). Product incorporates data which is © 2010 Telstra Corporation Limited, GM Holden Limited, Intelomatics Australia Pty Ltd, NAVTEQ International LLC, Sentinel Content Pty Limited and Continental Pty Ltd.

Austria

© Bundesamt für Eich- und Vermessungswesen

Canada

This data includes information taken with permission from Canadian authorities, including © Her Majesty the Queen in Right of Canada, © Queen's Printer for Ontario, © Canada Post Corporation, GeoBase®, © The Department of Natural Resources Canada. All rights reserved.

Croatia, Estonia, Latvia, Lithuania, Moldova, Poland, Slovenia and Ukraine

© EuroGeographic

France

source: © IGN 2009 - BD TOPO®

Germany

Die Grundlagendaten wurden mit Genehmigung der zuständigen Behörden entnommen.

Great Britain

Contains Ordnance Survey data © Crown copyright and database right 2010
Contains Royal Mail data © Royal Mail copyright and database right 2010

Greece

Copyright Geomatics Ltd.

Hungary

Copyright © 2003; Top-Map Ltd.

Italy

La Banca Dati Italiana è stata prodotta usando quale riferimento anche cartografia numerica ed al tratto prodotta e fornita dalla Regione Toscana.

Screen indicators

Japan

- 日本の地図の作成にあたっては、国土地理院長の承認を得て、同院発行の2万5千分の1地形図を使用しています。(承認番号 平20業使、第204-46号)
- 日本の地図の作成にあたっては、国土地理院長の承認を得て、同院の技術資料H-1-No.3「日本測地系における離島位置の補正量」を使用しています。(承認番号 国地企調発第78号 平成16年4月23日)

Jordan

© Royal Jordanian Geographic Centre

Mexico

Fuente: INEGI (Instituto Nacional de Estadística y Geografía.)

Norway

Copyright © 2000; Norwegian Mapping Authority

Portugal

Source: IgeoE - Portugal

Spain

Información geográfica propiedad del CNIG

Sweden

Based upon electronic data © National Land Survey Sweden.

Switzerland

Topografische Grundlage: © Bundesamt für Landestopographie.

United States

© United States Postal Service® 2010. Prices are not established, controlled or approved by the United States Postal Service®.
The following trademarks and registrations are owned by the USPS: United States Postal Service, USPS, and ZIP+4.

The following indicators appear when you change the settings. See page 28 and 35 also for the indicators that appear during recording or playing.

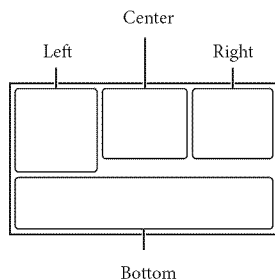

Left

Indicator	Meaning
	MENU button (68)
	Self-timer recording (70)
	GPS triangulating status (45)
	Video light
	Wide Mode (71)
	Fader (70)
	[Face Detection] set to [Off] (71)
	[Smile Shutter] set to [Off] (71)
	Manual focus (70)
	Scene Selection (70)
	White Balance (70)
	SteadyShot off (70)
	White Balance Shift (70)
	Tele Macro (70)
	x.v.Color (71)
	Conversion Lens (70)
	Zebra
	Peaking
	Cinematone
	Destination (73)

	Intelligent Auto (face detection/scene detection/camera-shake detection/sound detection) (38)
--	---

Center

Indicator	Meaning
	Slideshow Set
	NightShot (39)
	Warning (75)
	Playback mode (35)

Right

Indicator	Meaning
	Recording image quality (HD/STD), frame rate (60p/60i/24p) and recording mode (PS/FX/FH/HQ/LP) (41)
	Remaining battery
	Recording/playback/editing media (25)
0:00:00	Counter (hour:minute:second)
00Min	Estimated recording remaining time
	Photo size (42)
9999	Approximate number of recordable photos and photo size
101	Playback folder
100/112	Current playing movie or photo/Number of total recorded movies or photos
	Connection to the external media device (66)

Bottom

Indicator	Meaning
	[Micref Level] low (71)
	[Auto Wind NR] set to [Off] (71)
	[Closer Voice] set to [Off] (37)
	Blt-in Zoom Mic (71)
	Audio Mode (71)
	Low Lux (70)

	Spot Meter/Fcs (70)/Spot Meter (70)/ Exposure (70)
EV	AE Shift (70)
10000	Shutter Speed (43)
F1.8	IRIS (42)
	Intelligent Auto (38)
	Data file name
	Protect (72)
	Flash (71)/Red Eye Reduction (71)

- Indicators and their positions are approximate and may differ from what you actually see.
- Some indicators may not appear, depending on your camcorder model.

Index

Symbols

5.1ch surround sound51

A

Active Interface Shoe13, 83

AE Shift70

AGC Limit70

Auto Wind NR39

AVCHD recording disc9, 41

A/V connecting cable50

B

Battery pack18

Beep24

“BRAVIA” Sync52

Built-in USB Cable19

C

Calibration84

Care81

Charging the battery pack18

Charging the battery pack using
your computer19

Closer Voice37

Computer57

Connection50

Creating discs61, 63

D

Data Code24

Date/Time24

Delete54

Direct Copy67

DISC BURN OPTION63

Disc recorder64

Display items on the LCD
screen28

Divide54

Dual Capture27

Dubbing61

DVD61

DVDirect Express63

DVD writer64

E

Editing54

Empty Music49

Event View32

Expanded Feature56

Extended Zoom30

External media device66

F

Face Priority37

FH41

Full charge19

FX41

G

GPS44

Grip belt15

H

“Handycam” User Guide9

HDMI Cable50

Highlight Movie49

Highlight Playback48

Highlight Setting48

HQ41

I

Image Size42

Install57, 60

Intelligent Auto38

IRIS42, 70

L

Language8

LCD screen28

Lens hood15

LP41

M

Mac60

MANUAL dial43

Map View33

Media Select25

Media Settings25

Memory card25

“Memory Stick PRO-HG Duo”
media26

“Memory Stick PRO Duo”
media (Mark2)26

Menu lists70

Menus68

Micref Level71

Mirror mode29

Moisture condensation82

Movies27

Music Transfer49, 60

N

NightShot39

Notes on handling of your
camcorder81

Number of recordable photos79

O

Operating buttons35

P

Photo Capture55

Photos27

Playback32

Playing discs62

Playing scenarios49

PlayMemories Home17, 56, 57

PlayMemories Home Help
Guide17, 60

Power on22

Projector52

PS41

R

REC Mode41

Recording27

Recording and playback time77

Recording media25

Recording time of movies77, 78

Repair74

RESET14

S

Saving images on an external media device.....	66
Scenario Save.....	49
Screen indicators	28, 92
SD card.....	26
Self-diagnosis display.....	75
Setting the date and time.....	22
Shutter Speed	43
Smile Shutter	38
Specifications	86
Starting PlayMemories Home.....	60
Summer Time	22
Supplied Items.....	17

T

Thumbnails	33
Touch panel	28
Tracking focus.....	37
Triangulating.....	45
Triangulating priority mode	45
Tripod.....	15
Troubleshooting.....	74
TV.....	50

U

USB.....	19, 57
USB Adaptor Cable	66
USB Connect.....	64
USB connection support cable.....	17

V

VBR.....	78
Video Light.....	40

W

Wall outlet (wall socket)	20
Warning indicators.....	75
White Balance Shift.....	70
Wind noise	71
Windows.....	57
Wireless Remote Commander	16, 83

Y

Your Location.....	45
--------------------	----

Z

Zoom.....	30
-----------	----

You will find the menu lists on pages 70 to 73.