



Scan, watch and discover how to
get the most out of your TV.
Escanee, observe y descubra
cómo obtener el máximo de su TV.
<http://SCN.BY99ab0htw6j3hb>

Panasonic®

Model No.
Número de modelo
TC-L50EM5

Owner's Manual

50" Class 1080p LCD HDTV
(49.5 inches measured diagonally)

Manual de usuario

Televisión de alta definición de 1080p y
clase 50" de LCD
(49.5 pulgadas medidas diagonalmente)

VIERA

For assistance (U.S.A./Puerto Rico), please call:
1-877-95-VIERA (958-4372)
www.panasonic.com/help

For assistance (Canada), please call:
1-866-330-0014
concerge.panasonic.ca

Para solicitar ayuda (EE.UU./Puerto Rico), llame al:
1-877-95-VIERA (958-4372)
www.panasonic.com/help

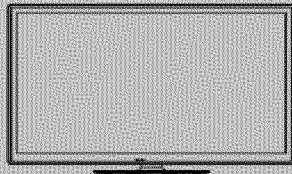

English

Thank you for purchasing this Panasonic product.
Please read these instructions before operating your set and retain them
for future reference. The images shown in this manual are for illustrative
purposes only.

Español

Gracias por su decisión de comprar este producto marca Panasonic.
Lea estas instrucciones antes de utilizar su televisor y guárdelas para
consultarlas en el futuro. Las imágenes mostradas en este manual tienen
solamente fines ilustrativos.



TQB2AC0115-1

This product incorporates the following software or technology:

- (1) the software based in part on the work of the Independent JPEG Group,
- (2) the software developed by the FreeType Project,
- (3) the software licensed under the GNU General Public License, Version 2 (GPL v2) and/or,
- (4) open sourced software other than the software licensed under the GPL and/or LGPL

For the software categorized as (3), please refer to the terms and conditions of GPL, as the case may be at <http://www.gnu.org/licenses/old-licenses/gpl-2.0.html>
In addition, the software categorized as (3) is copyrighted by several individuals.
Please refer to the copyright notice of those individuals at <http://www.am-linux.jp/dl/DTV12UM/>

The GPL software is distributed in the hope that it will be useful, but WITHOUT ANY WARRANTY, without even the implied warranty of MERCHANTABILITY or FITNESS FOR A PARTICULAR PURPOSE.

At least three (3) years from delivery of products, we will give to any third party who contact us at the contact information provided below, for a charge no more than our cost of physically performing source code distribution, a complete machine-readable copy of the corresponding source code covered under GPL v2.

Contact Information

cdrequest@am-linux.jp

Source code covered under GPL v2 is also freely available to you and any other member of the public via our website below.
<http://www.am-linux.jp/dl/DTV12UM/>

For the software categorized as (3) and (4), please refer to the applicable license terms included in the "Setup" menu on product.



HDMI, the HDMI logo and High-Definition Multimedia Interface are trademarks or registered trademarks of HDMI Licensing LLC in the United States and other countries.

Manufactured under license from Dolby Laboratories. Dolby and the double-D symbol are trademarks of Dolby Laboratories.



This product qualifies for ENERGY STAR in the "Home Use" setting and this is the setting in which energy savings will be achieved. Any modifications to the "Home Use" setting or other factory default settings could result in greater energy consumption beyond levels that meet ENERGY STAR qualifications.



Contents

Please read before using the unit

- Safety Precautions 4

Getting started

- Accessories/Optional Accessory 8
- Connections 11
- Identifying Controls 13
- First Time Setup 14

Basic Features

- Watching TV 16
- Watching content from external devices 19
- Using Media player 20

Advanced Features

- Editing and Setting Channels 26
- Input Labels 28
- How to Use Menu Functions 29
 - Picture settings 30
 - Audio settings 31
 - Lock settings 31
 - TV settings 32
 - Setup 32

Support Information

- Ratings List for parental control 34
- Technical Information 36
- Care and Cleaning 40
- Specifications 41
- Frequently Asked Questions (FAQ) 42
- Index 44
- Limited Warranty
(for U.S.A. and Puerto Rico only) 45
- Customer Services Directory
(for U.S.A. and Puerto Rico) 46
- Limited Warranty (for Canada) 47

Getting started

Basic

Advanced

Support Information



Safety Precautions

	CAUTION RISK OF ELECTRIC SHOCK DO NOT OPEN	
WARNING: To reduce the risk of electric shock, do not remove cover or back. No user-serviceable parts inside. Refer servicing to qualified service personnel.		



The lightning flash with arrowhead within a triangle is intended to tell the user that parts inside the product are a risk of electric shock to persons.



The exclamation point within a triangle is intended to tell the user that important operating and servicing instructions are in the papers with the appliance.

Note to CATV System Installer

This reminder is provided to direct the CATV system installer's attention to Article 820-40 of the NEC that provides guidelines for proper grounding and, in particular, specifies that the cable ground shall be connected to the grounding system of the building, as close to the point of cable entry as practical.

Secure Ventilation

Slots and openings in the cabinet and the back or bottom are provided for ventilation, and to ensure reliable operation of the LCD TV and to protect it from overheating. These openings must not be blocked or covered. There should be at least 10 cm of space around the TV. The openings should never be blocked by placing the LCD TV on a bed, sofa, rug or other similar surface. This LCD TV should not be placed in a built-in installation such as a bookcase unless proper ventilation is provided.

Important Safety Instructions (TV set)

- 1) Read these instructions.
- 2) Keep these instructions.
- 3) Heed all warnings.
- 4) Follow all instructions.
- 5) Do not use this apparatus near water.
- 6) Clean only with dry cloth.
- 7) Do not block any ventilation openings. Install in accordance with the manufacturer's instructions.
- 8) Do not install near any heat sources such as radiators, heat registers, stoves or other apparatus (including amplifiers) that produce heat.
- 9) Do not defeat the safety purpose of the polarized or grounding-type plug. A polarized plug has two blades with one wider than the other. A grounding type plug has two blades and a third grounding prong. The wide blade or the third prong are provided for your safety. If the provided plug does not fit into your outlet, consult an electrician for replacement of the obsolete outlet.
- 10) Protect the power cord from being walked on or pinched particularly at plugs, convenience receptacles, and the point where they exit from the apparatus.
- 11) Only use attachments / accessories specified by the manufacturer.
- 12) Use only with the cart, stand, tripod, bracket or table specified by the manufacturer, or sold with the apparatus. When a cart is used, use caution when moving the cart / apparatus combination to avoid injury from tip-over.
- 13) Unplug this apparatus during lightning storms or when unused for long periods of time.
- 14) Refer all servicing to qualified service personnel. Servicing is required when the apparatus has been damaged in any way, such as power-supply cord or plug is damaged, liquid has been spilled or objects have fallen into the apparatus, the apparatus has been exposed to rain or moisture, does not operate normally, or has been dropped.
- 15) Operate only from the type of power source indicated on the marking label. If you are not sure of the type of power supplied to your home, consult your television dealer or local power company.
- 16) Follow all warnings and instructions marked on the LCD TV.
- 17) Never push objects of any kind into this LCD TV through cabinet slots as they may touch dangerous voltage points or short out parts that could result in a fire or electric shock. Never spill liquid of any kind on the LCD TV.
- 18) If an outside antenna is connected to the television equipment, be sure the antenna system is grounded so as to provide some protection against voltage surges and built up static charges. In the U.S. Section 810-21 of the National Electrical Code provides information with respect to proper grounding of the mast and supporting structure, grounding of the lead-in wire to an antenna discharge unit, size of grounding conductors, location of antenna discharge unit, connection to grounding electrodes, and requirements for the grounding electrode.

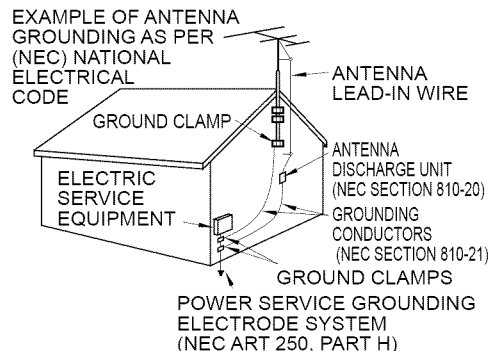

- 19) An outside antenna system should not be located in the vicinity of overhead power lines, other electric light, power circuits, or where it can fall into such power lines or circuits. When installing an outside antenna system, extreme care should be taken to keep from touching such power lines or circuits as contact with them might be fatal.
- 20) Unplug this LCD TV from the wall outlet and refer servicing to qualified service personnel under the following conditions:
 - a. When the power cord or plug is damaged or frayed.
 - b. If liquid has been spilled into the LCD TV.
 - c. If the LCD TV has been exposed to rain or water.
 - d. If the LCD TV does not operate normally by following the operating instructions.

Adjust only those controls that are covered by the operating instructions as improper adjustment of other controls may result in damage and will often require extensive work by a qualified technician to restore the LCD TV to normal operation.
 - e. If the LCD TV has been dropped or the cabinet has been damaged.
 - f. When the LCD TV exhibits a distinct change in performance - this indicates a need for service.
- 21) When replacement parts are required, be sure the service technician uses replacement parts specified by the manufacturer that have the same characteristics as the original parts. Unauthorized substitutions may result in fire, electric shock, or other hazards.
- 22) **WARNING: TO REDUCE THE RISK OF FIRE OR ELECTRIC SHOCK, DO NOT EXPOSE THIS APPARATUS TO RAIN, MOISTURE, DRIPPING OR SPLASHING. DO NOT PLACE LIQUID CONTAINERS (FLOWER VASES, CUPS, COSMETICS, ETC.) ABOVE THE SET (INCLUDING ON SHELVES ABOVE, ETC.).**
- 23) **WARNING: SMALL PARTS CAN PRESENT CHOKING HAZARD IF ACCIDENTALLY SWALLOWED. KEEP SMALL PARTS AWAY FROM YOUNG CHILDREN. DISCARD UNNEEDED SMALL PARTS AND OTHER OBJECTS, INCLUDING PACKAGING MATERIALS AND PLASTIC BAGS/SHEETS TO PREVENT THEM FROM BEING PLAYED WITH BY YOUNG CHILDREN, CREATING THE POTENTIAL RISK OF SUFFOCATION.**
- 24) **WARNING: To prevent the spread of fire, keep candles or other open flames away from this product at all times.**
- 25) **WARNING: Do not place this TV in any medical institutions or locations with medical devices.**

Radio waves from this TV may interfere with the medical devices and cause accidents due to the malfunction.
- 26) **WARNING: Do not use this TV near any automatic control devices such as automatic doors or fire alarms.**

Radio waves from this TV may interfere with the automatic control devices and cause accidents due to the malfunction.
- 27) **WARNING: Keep this TV away at least 9 inches (22 cm) from the location where a cardiac pacemaker is implanted.**

Radio waves from this TV may interfere with the operation of the pacemaker.
- 28) **CAUTION: The Power switch on this unit will not completely shut off all power from AC outlet. Since the power cord serves as the main disconnect device for the unit, you will need to unplug it from the AC outlet to shut down all power. Therefore, make sure the unit has been installed so that the power cord can be easily unplugged from AC outlet in case of an accident. To avoid fire hazard, the power cord should also be unplugged from the AC outlet when left unused for a long period of time (for example, when on vacation).**
- 29) **CAUTION: TO PREVENT ELECTRIC SHOCK, DO NOT USE THIS PLUG WITH A RECEPTACLE OR OTHER OUTLET UNLESS THE BLADES CAN BE FULLY INSERTED TO PREVENT BLADE EXPOSURE.**
- 30) **CAUTION: USE WITH OTHER STAND MAY RESULT IN INSTABILITY POSSIBLY CAUSING INJURY.**
- 31) **CAUTION: DANGER OF EXPLOSION IF BATTERY IS INCORRECTLY REPLACED. REPLACE ONLY WITH THE SAME OR EQUIVALENT TYPE.**



NOTE: This equipment is designed to operate in North America and other countries where the broadcasting system and AC house current are exactly the same as in North America.

FCC STATEMENT

This equipment has been tested and found to comply with the limits for a Class B digital device, pursuant to Part 15 of the FCC Rules. These limits are designed to provide reasonable protection against harmful interference in a residential installation. This equipment generates, uses and can radiate radio frequency energy and, if not installed and used in accordance with the instructions, may cause harmful interference to radio communications. However, there is no guarantee that interference will not occur in a particular installation. If this equipment does cause harmful interference to radio or television reception, which can be determined by turning the equipment off and on, the user is encouraged to try to correct the interference by one or more of the following measures:

- Reorient or relocate the receiving antenna.
- Increase the separation between the equipment and receiver.
- Connect the equipment into an outlet on a circuit different from that to which the receiver is connected.
- Consult the Panasonic Service Center or an experienced radio/TV technician for help.

FCC Caution: To assure continued compliance, follow the attached installation instructions and use only shielded interface cable when connecting to computer or peripheral devices. Any changes or modifications not expressly approved by Panasonic Corp. of North America could void the user's authority to operate this device.

FCC Declaration of Conformity

Models:	TC-L50EM5
Responsible Party:	Panasonic Corporation of North America One Panasonic Way, Secaucus, NJ 07094
Contact Source:	Panasonic Consumer Marketing Company of North America
Telephone No.:	1-877-95-VIERA (958-4372)
Email:	consumerproducts@panasonic.com

This device complies with Part 15 of the FCC Rules. Operation is subject to the following two conditions: (1) This device may not cause harmful interference, and (2) this device must accept any interference received, including interference that may cause undesired operation.

CEA CHILD SAFETY NOTICES

WARNING

Flat panel displays are not always supported on the proper stands or installed according to the manufacturer's recommendations. Flat panel displays that are inappropriately situated on dressers, bookcases, shelves, desks, speakers, chests or carts may fall over and may cause personal injury or even death.

The consumer electronics industry (of which Panasonic is a member) is committed to making home entertainment enjoyable and safe. To prevent personal injury or death, be sure to follow the following safety guidelines:

TUNE INTO SAFETY:

- One size does NOT fit all. Follow the manufacturer's recommendations for the safe installation and use of your flat panel display.
- Carefully read and understand all enclosed instructions for proper use of this product.
- Don't allow children to climb on or play with furniture and television sets.
- Don't place flat panel displays on furniture that can easily be used as steps, such as a chest of drawers.
- Remember that children can become excited while watching a program, especially on "larger than life" flat panel displays. Care should be taken to install the display where it cannot be pushed, pulled over, or knocked down.
- Care should be taken to route all cords and cables connected to the flat panel display so that they cannot be pulled or grabbed by curious children.

WALL MOUNTING: IF YOU DECIDE TO WALL MOUNT YOUR FLAT PANEL DISPLAY, ALWAYS:

- Use a mount that has been recommended by the display manufacturer and/or listed by an independent laboratory (such as UL, CSA, ETL).
- Follow all instructions supplied by the display and wall mount manufacturers.
- If you have any doubts about your ability to safely install your flat panel display, contact your retailer about professional installation.
- Make sure the wall where you are mounting the display is appropriate. Some wall mounts are not designed to be mounted to walls with steel studs or old cinder block construction. If you are unsure, contact a professional installer.
- A minimum of two people are required for installation. Flat panel displays can be heavy.

Panasonic recommends that a qualified installer perform the wall-mount installation. See page 8.

The American Academy of Pediatrics discourages media viewing for children younger than two years. For more details, see www.aap.org.



Accessories/Optional Accessory

Accessories

Check you have all the items shown.

Accessories

- Remote Control Transmitter
● N2QAYB000806



- Batteries for the Remote Control Transmitter (2)
● AA Battery

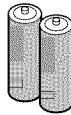

- Pedestal

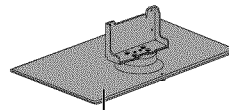

How to assemble (p. 9)

- Power cord

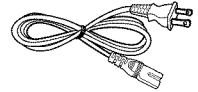

- Owner's Manual

- Child safety

- Quick Start Guide

- Product Registration Card (U.S.A.)

Optional Accessory

Wall-hanging bracket

Please contact your nearest Panasonic dealer to purchase the recommended wall-hanging bracket. For additional details, please refer to the wall-hanging bracket installation manual.

Back of the TV

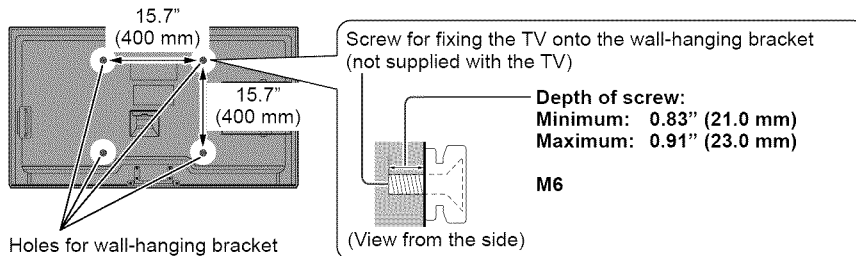

Holes for wall-hanging bracket installation

WARNING

- Customer assumes liability if mounting the unit themselves or if a Panasonic bracket is not used. Any damage resulting from not having a professional installer mount your unit will void your warranty.
- Always be sure to ask a qualified technician to perform any necessary set-up. Incorrect fitting may cause equipment to fall, resulting in injury and product damage.
- Do not mount the unit directly below ceiling lights (such as spotlights, floodlights or halogen lights) which typically give off high heat. Doing so may warp or damage plastic cabinet parts.
- Take care when fixing wall brackets to the wall. Always ensure that there are no electrical cables or pipes in the wall before hanging bracket.
- When using an angled-type wall hanging bracket, please ensure that there is sufficient space for the connecting cables so that they do not press against the wall when the TV is tilted forward.
- For safety reasons, remove units no longer being used from their wall-mounted locations.

Attaching the pedestal to TV

■ Assembling the pedestal

- Fix securely with assembly screws (A). (Total 4 screws)
- Tighten screws firmly.

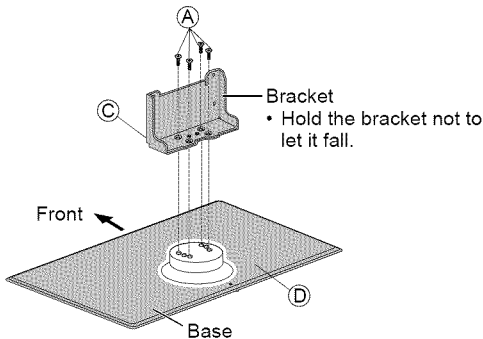

Accessories

Assembly screws (4 of each)



- XSS5+16FJK size (M5 x 16)

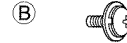

- XYN4+F15FJK size (M4 x 15)

Bracket (1)

- TBL5ZA33201

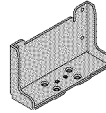

Base (1)

- TBL5ZX04901

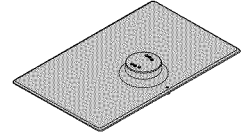

■ Set-up

- Tighten assembly screws (B) (total 4 screws) loosely at first, then tighten them firmly to fix securely.

Rear view

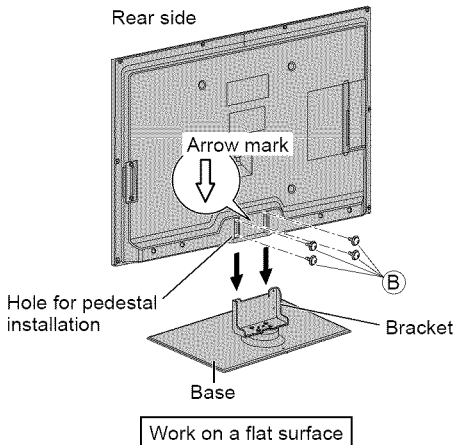

Removing the pedestal from the TV

Be sure to remove the pedestal in the following way when using the wall hanging bracket or repacking the TV.

1. Remove the assembly screws (B) from the TV.
2. Lift the TV from the pedestal.
3. Remove the assembly screws (A) from the bracket.

WARNING

Do not disassemble or modify the pedestal.

- Otherwise, the TV may fall over and become damaged, and personal injury may result.

Caution

Do not use any pedestal other than that provided with this TV.

- Otherwise, the TV may fall over and become damaged, and personal injury may result.

Do not use the pedestal if it becomes warped or physically damaged.

- If you use the pedestal when it is physically damaged, personal injury may result. Contact your nearest Panasonic dealer immediately.

During set-up, make sure that all screws are securely tightened.

- If sufficient care is not taken to ensure screws are properly tightened during assembly, the pedestal will not be strong enough to support the TV, and it might fall over and become damaged, and personal injury may result.

When removing the pedestal, do not remove the pedestal by any methods other than the specified procedure. (above)

- Otherwise, the TV and/or pedestal may fall over and become damaged, and personal injury may result.

Installing the remote's batteries

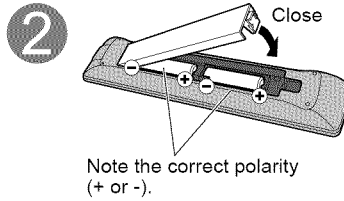
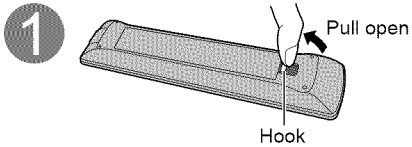

Caution

- Incorrect installation may cause battery leakage and corrosion, resulting in damage to the remote control.
 - Do not mix old and new batteries.
 - Do not mix different battery types (such as alkaline and manganese batteries).
 - Do not use rechargeable (Ni-Cd) batteries.
- Do not burn or break batteries.

Power cord connection

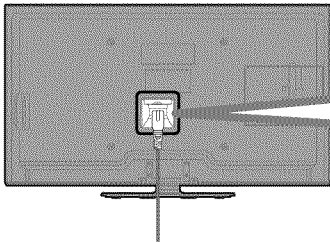

Insert the power cord plug (included) firmly into place.

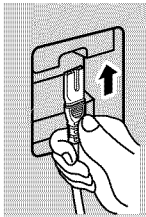

- When disconnecting the power cord, be absolutely sure to disconnect the power cord plug from the wall outlet first.
- The included power cord is for use with this unit only.

Connections

Connection Panels

Back of the TV

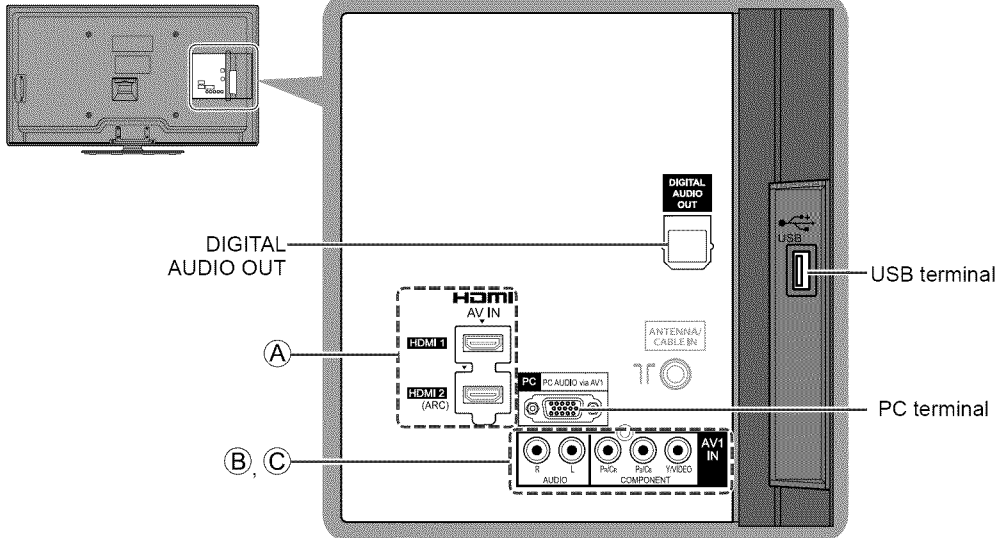

● For (A), (B), (C) connections, please refer to p. 12.

Antenna or Cable connection

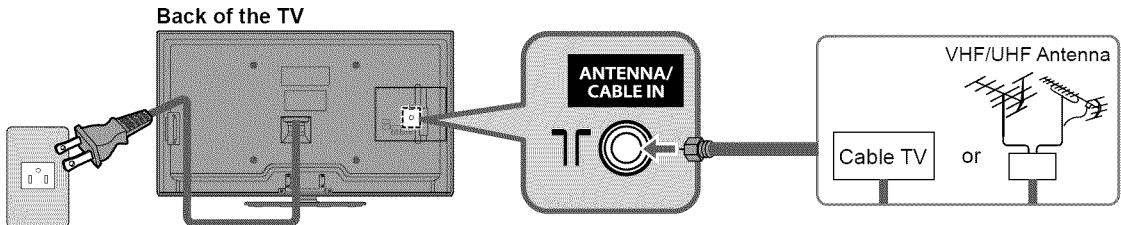

Power Cord
(Connect after all the other connections have been made.)

VHF/UHF Antenna

- NTSC (National Television System Committee); ATSC (Advanced Television Systems Committee); Digital TV Standards include digital high-definition television (HDTV), standard-definition television (SDTV), data broadcasting, multi-channel surround sound audio and interactive television.

Cable

- You need to subscribe to a cable TV service to enjoy viewing their programming.
- You may need to subscribe to a high-definition (HD) cable service to enjoy HD programming. The connection for high-definition can be done with the use of an HDMI or Component Video cable. (p. 12)

Note

- When using a Cable box, external equipment and video cables shown in this manual are not supplied with the TV.
- When disconnecting the power cord, be absolutely sure to disconnect the power cord plug from the wall outlet first.
- For additional assistance, visit us at: www.panasonic.com/help
www.panasonic.ca

AV cable connection

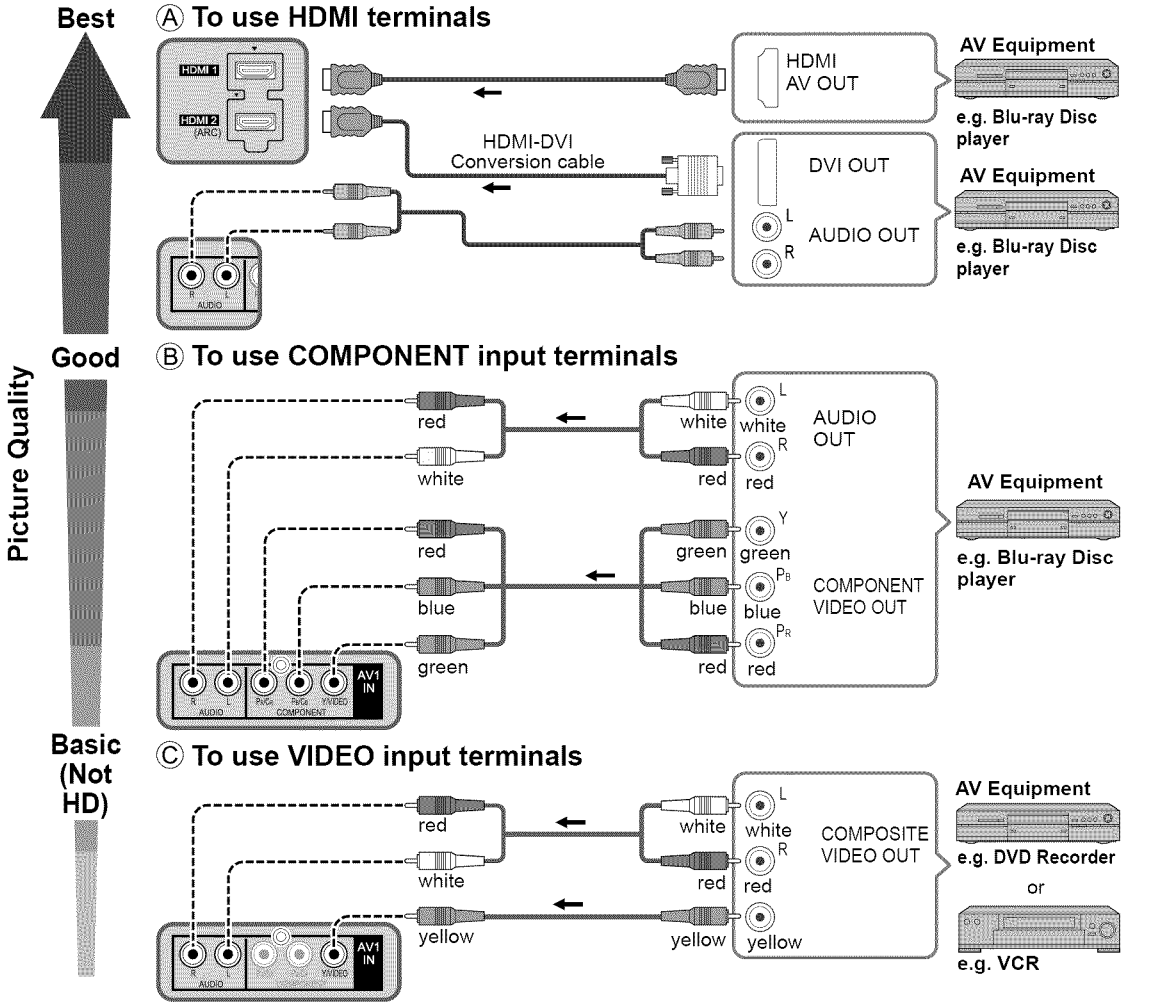

Audio connection

- Listen to your TV through your stereo

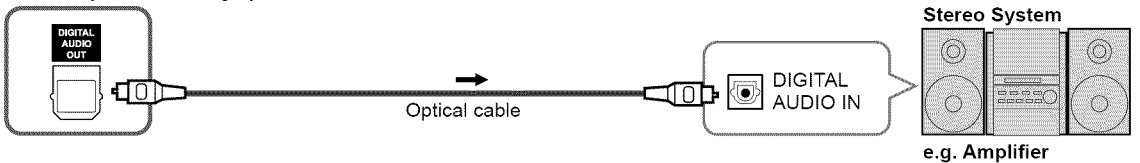

PC / Computer connection (VGA)

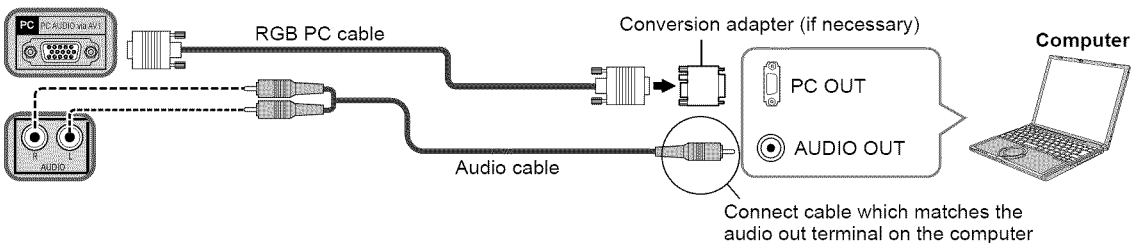

Identifying Controls

TV controls/indicators

Front of the TV

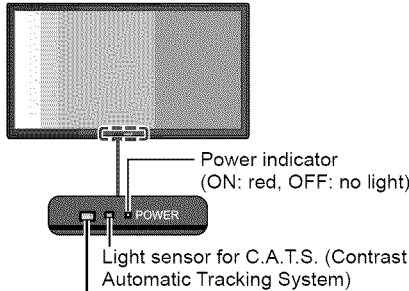

Remote control sensor range is about 23 feet (7 meters) in front of the TV set

Note

- The TV consumes a small amount of electric energy even when turned off.
- Do not place any objects between the TV remote control sensor and remote control.
- About C.A.T.S. ➔ p. 30

Back of the TV

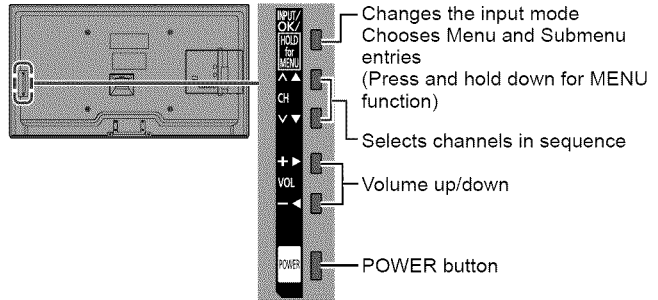

Remote control

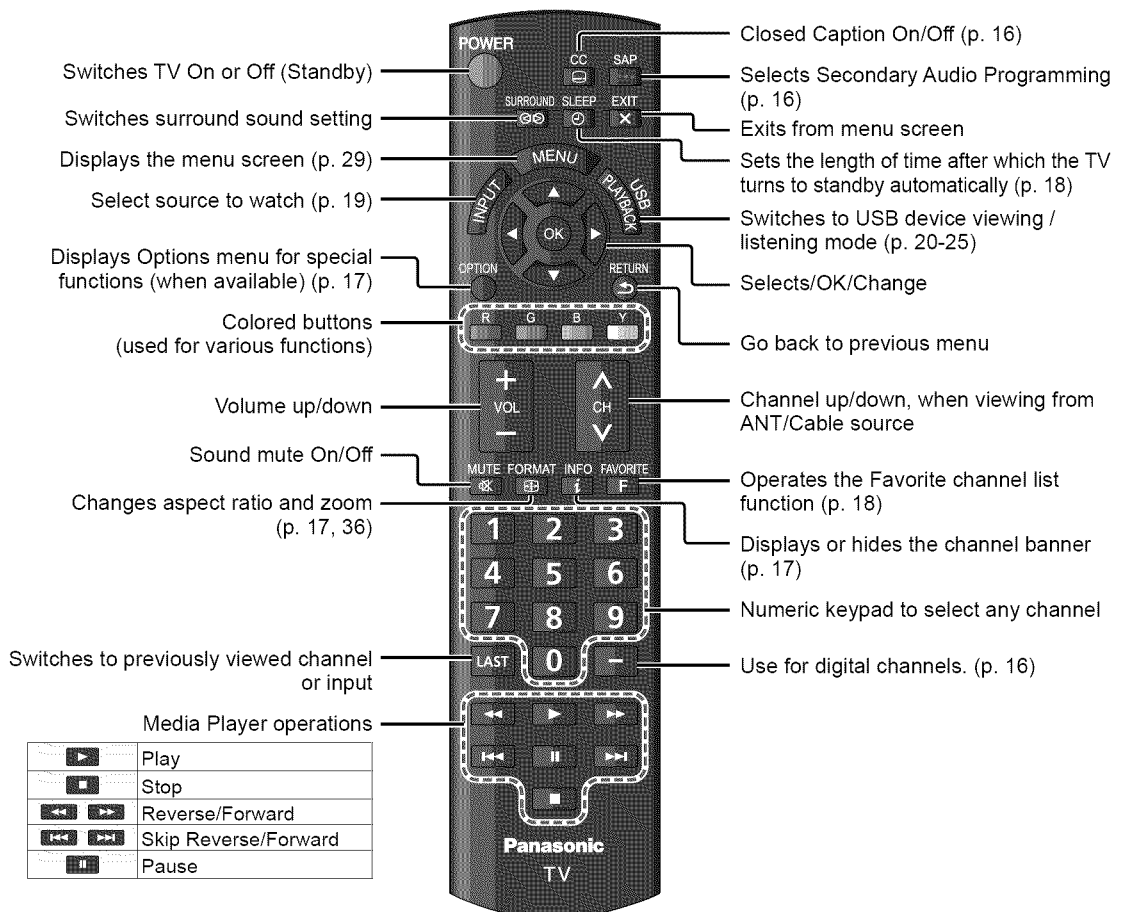

First Time Setup

The first time setup screen is displayed when the TV is turned on for the first time after the power cord is inserted into a wall outlet.

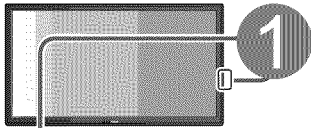

1 Turn the TV On with the [POWER] button

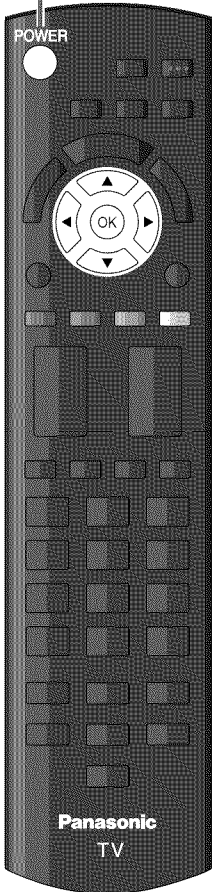
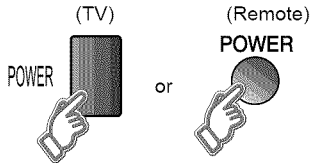

2 Configure your viewing mode

1 Select your language

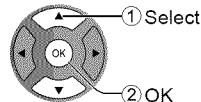
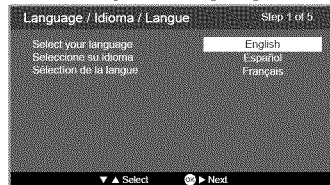

2 Select your viewing mode (Be sure to select "Home Use")

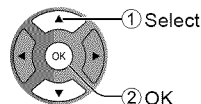

● Please confirm your selection (Home Use) before pressing the [OK] button.

■ If you select "Store Demonstration" by mistake in ②, confirmation screen will be displayed.

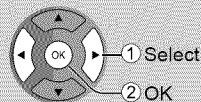

- Select "No" and return to previous screen ②.
- If you select "Yes", screen enters the store demonstration mode.

To display the "Set viewing mode" screen again as shown above and select "Home Use", perform "Reset to defaults" in the "Setup" menu (p. 33)

- If you perform "Reset to defaults", please do not unplug the AC Cord while the TV is being reset.

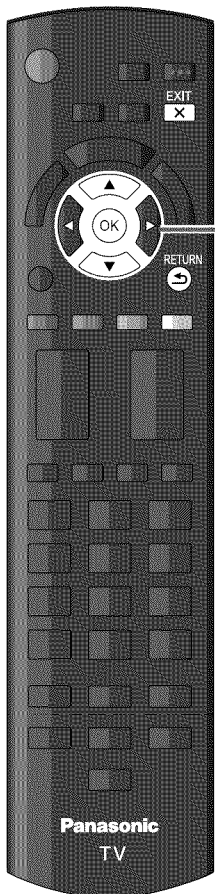

3 ANT/Cable setup

① Select signal type ("Over-the-Air")

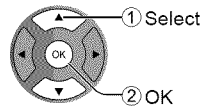
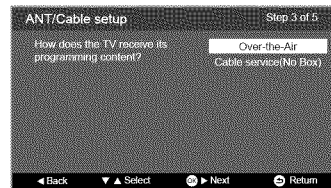

② Select "Auto program" and start scanning

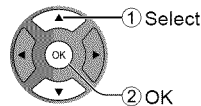
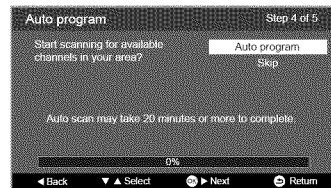

➔ Scanning starts

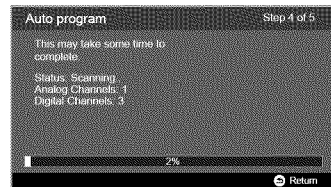

4

Complete First time setup

Congratulations! You are done.

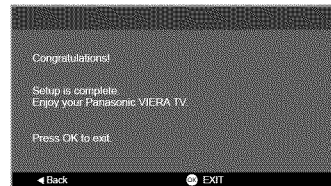

■ Press to exit from a menu screen



■ Press to go back to the previous screen



To watch TV via a Cable box, Satellite receiver, or any other source (DVD, DVR, gaming device, etc.), press the [INPUT] button and select the appropriate input.

Note

- If you turn off the TV by pulling out the power cord before completing "First time setup", "First time setup" will launch again when you next turn on the TV. On the other hand, if you turn off the TV with the POWER button on the TV or remote control, this procedure will not launch again on your next power on.
- You can repeat "First time setup" by selecting "Reset to defaults" in the "Setup" menu (p. 33)
- After "First time setup", you can also change "Language" and "ANT/Cable setup" from the "Setup" and "TV" menus respectively. (p. 32)
- About broadcasting systems
 - Analog (NTSC):**
Conventional broadcasting
 - Digital (ATSC):**
Program that allows you to view more channels featuring high-quality video and sound

Watching TV

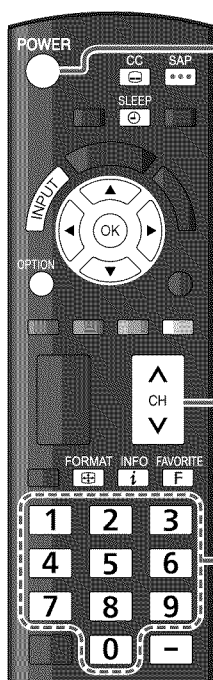

1 Turn power on
(Remote)



or

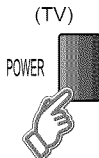

Note

- Please select correct input
➔ (p. 19)



2 Select a channel number

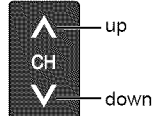

or

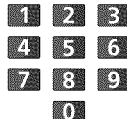

■ To directly enter the digital channel number



When tuning to a digital channel, press the button to enter the minor number in a compound channel number.

example: CH15-1: **1 5 - 1**

- Also available side [CH] button on the unit.

For Cable/Satellite box connection
- Use your connected box's remote control.

Note

- Reselect "Cable" or "Antenna" in "ANT in" of "TV" settings menu to switch the signal reception between cable TV and antenna (p. 27).
- The channel number and volume level remain the same even after the TV is turned off.

■ Other Useful Functions

Listen with SAP (Secondary Audio Programming)

■ Select the Audio mode for watching TV



Digital mode

Press [SAP] to select next Audio track (if available) when receiving a digital channel.



(example)

Analog mode

Press [SAP] to select the desired Audio mode.

- Each press of [SAP] will change the Audio mode. ("Stereo" / "SAP" / "Mono")

- SAP is not available when watching TV with a Cable or Satellite box connected via HDMI.
- Contact your Cable or Satellite operator for instructions on enabling SAP with their box.

Closed Caption

■ Press [CC] to cycle through the Closed Caption modes



Digital TV:

- "Off" / "Service1 - 6"

Analog TV:

- "Off" / "CC1 - 4" / "TEXT1 - 4"

- The selected mode is only set for the program you are watching at the moment.
- Closed Caption is not available when watching TV with a Cable or Satellite box connected via HDMI.
- Contact your Cable or Satellite operator for instructions on enabling CC with their box.
- Closed Caption settings are memorized in "Closed caption" of "Setup" menu.

Displaying information

- Displays or hides information. Shows the channel banner when watching programs via the Antenna/Cable input.

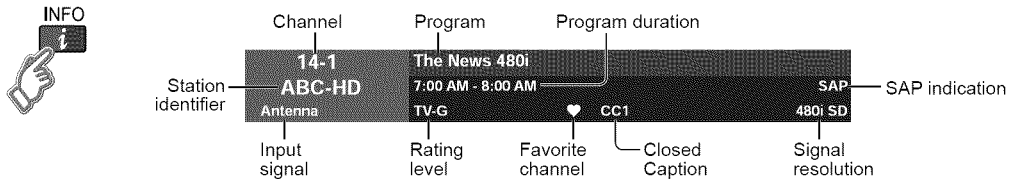

Change aspect ratio and zoom the picture

- Press [FORMAT] repeatedly to cycle through the aspect modes (p. 36)

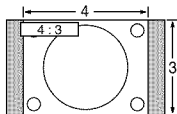

480i, 480p:

- "FULL" / "4:3" / "JUST" / "ZOOM"

1080p, 1080i, 720p:

- "FULL" / "4:3" / "JUST" / "ZOOM" / "H-FILL"

PC:

- "FULL" / "4:3"

Use when the picture does not fill the whole screen (bars appears on either side of the image) or portions of the picture is trimmed.

Note

- Some content, such as film-based movies, are available in extra-wide format. Top and bottom bars are unavoidable.
- Connected devices, such as Cable/Satellite box, DVD/Blu-ray players and game consoles have their own aspect (format) settings. Adjust the aspect of the devices.

Display the "Options menu"

- Press [OPTION] to show the "Options menu"

This menu consists of shortcuts to convenient functions.

This menu is only available when the TV is using the Antenna/Cable input, not when using Cable or Satellite box.

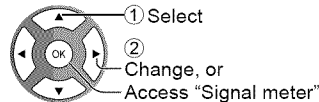
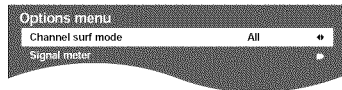

Channel surf mode

Specify favorites or type of channels to view when pressing the [CH up/down] button.

- "All" / "Favorite" / "Digital only" / "Analog only"

"Favorite": Only channels registered as FAVORITE.

Signal Meter

Check the signal strength if interference is found or freezing occurs on a digital image.

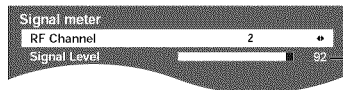

Signal intensity

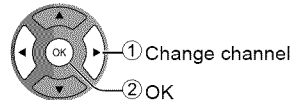

- If the signal is weak, check the antenna. If no problem is found, consult your local dealer.

Call up a Favorite channel

■ FAVORITE

Channel numbers registered in Favorite are displayed on the "Favorite List" screen. Select the desired channel with the up/down cursor.



To set Favorite channels

While viewing the channel that you want to set:

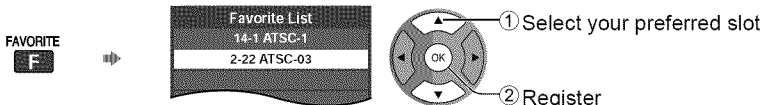

- When watching a Favorite channel, the icon "♥" will be displayed on the channel banner (p. 17).
- You can set up to 10 channels as Favorite.
- You cannot save a new channel in a used slot. If you want to change your Favorite channel, first delete the existing channel (see below), then save the new channel in the empty slot.

To delete Favorite channels

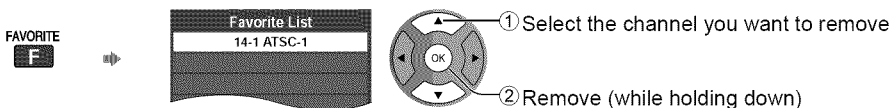

- The icon "♥" will be removed from the channel banner (p. 17).

■ Other Useful Operations

Password setting/entering

You need to enter the password when you access a locked channel or input.

■ Input your 4-digit password

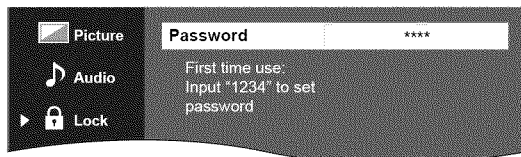

- If it is your first time entering the password, please enter "1234". This is the default password.
- To change password ► (p. 31)
- Make a note of your password. Do not forget it. (If you have forgotten your password, consult your local dealer.)
- When you select a locked channel, a message will be displayed that allows you to view the channel after you input your password.

Set the "Sleep timer"

The TV automatically goes into Standby after the selected period.

■ Press [SLEEP] repeatedly until the desired time appears.

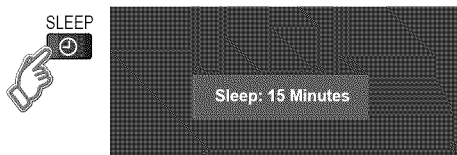

Note

- It is also possible to set the time from "Sleep Timer" in the "Setup" menu (p. 32).
- To cancel, set to "Off" or turn off the TV.
- When the remaining time is within 3 minutes, the remaining time is displayed on the screen.

• "Off" / "15" / "30" / "60" / "90" (minutes)

Watching content from external devices

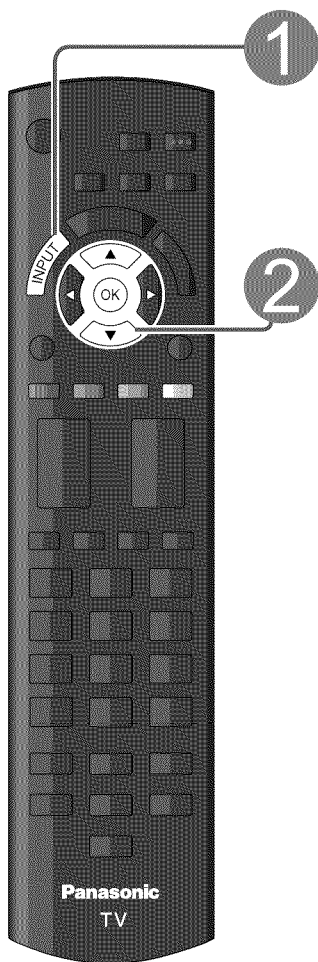

1 With the connected equipment turned On
Display the input selection screen



2 **Select the input mode**

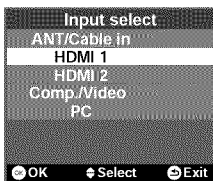

(example)

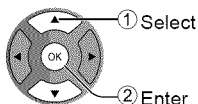

Or, press the [INPUT] button repeatedly to cycle through the available inputs.

Select the input of your choice, then press [OK].



(example)

- You can label or skip each input mode
 - Input Labels (p. 28)
 - If an input is set to "Not used" (p. 28), the input will be grayed-out on the "Input select" screen.
- During selection, if no action is taken for several seconds, the "Input select" screen disappears.
- The terminal or label (name) of the connected equipment is displayed.

Using Media player

You can view still and motion images and play music saved on a USB flash memory.

Basic features for Media player

Available contents and features

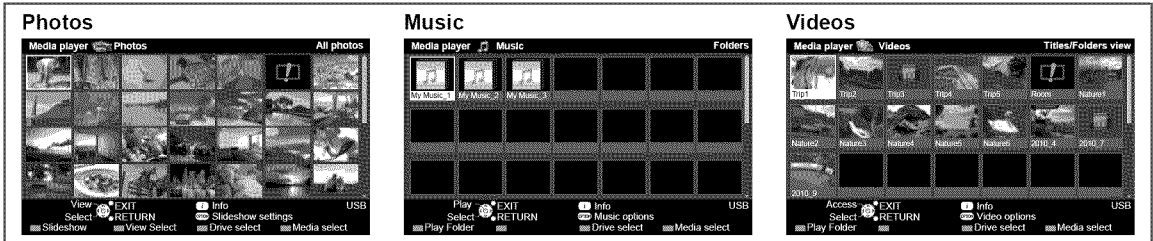

Drive select

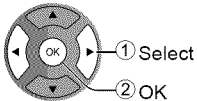
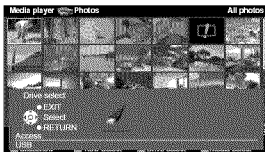

Media select

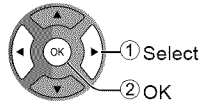
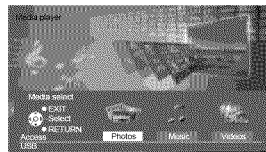

Information panel

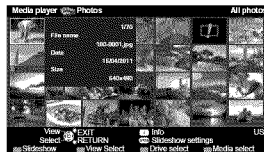

Displays data information (file name, date, size, etc.)
 • Information differs depending on selected data.

Options menu



Option menu
 Photos ➔ p. 22-23
 Music ➔ p. 24
 Videos ➔ p. 24-25

Media information

Inserting or removing a USB flash memory

● Insert the device

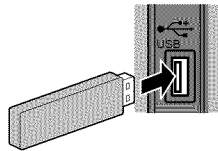

• Insert straight in

● Remove the device

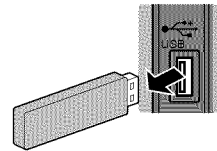

• Pull straight out

● Media player only supports USB Mass storage class devices.

● Compliance:

- Supports only USB1.1 or USB2.0 standard
- Supports file format of FAT16 or FAT32
- Maximum USB capacity supported is 16GB
- USB Hub is not supported.

Compatible Data format for Media player (USB flash memory)

Media	Compatible format
Photo	<ul style="list-style-type: none"> • JPEG files (DCF and EXIF standards) <ul style="list-style-type: none"> Sub-sampling - 4:4:4, 4:2:2 and 4:2:0 Image resolution - Baseline JPEG: 15,360 (W) × 8,640 (H) - Progressive JPEG: 1,920 (W) × 1,440 (H)
Music	<ul style="list-style-type: none"> • MP3 files (MPEG Audio Layer-3) • AAC files (MPEG2-AAC / MPEG4-AAC)
Videos	<ul style="list-style-type: none"> • MP4 files (Video codec H.264 Audio codec MP3/AC-3/LPCM) • MKV files (Video codec H.264 Audio codec MP3/AC-3/LPCM)

● For more data format information. (p. 37)

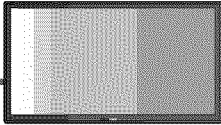

1 Insert a USB flash memory

2 Display Media player



3 Select the contents

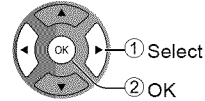
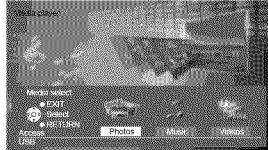

4 Select the data (Photos/Music/Videos)

How to view the data differs depending on data storage conditions.

1 Select Title/Folder



(e.g. Photos)

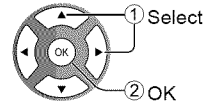

2 Select file



(e.g. Photos)

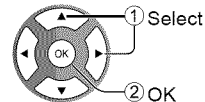

5 View or play

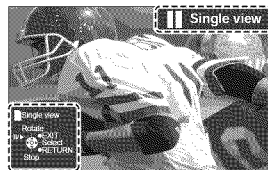

(e.g. Photos)

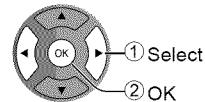

■ Press to exit from Media player screen



■ Press to return to thumbnail view

RETURN

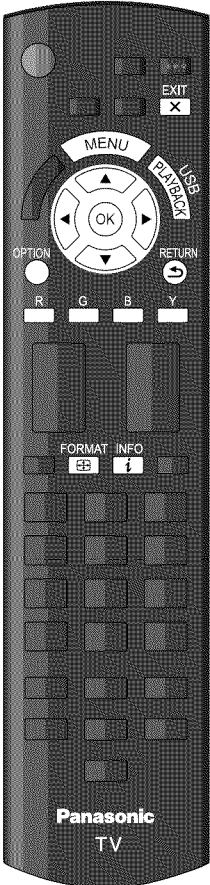

Photos view

Photos thumbnail

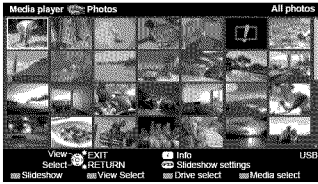

Features

- Start Slideshow → R
- View select → G
- Drive select → B
- Media select → Y

Photos playback screen

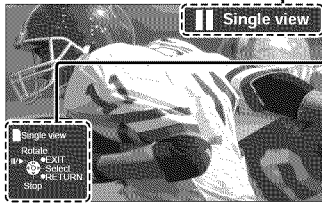
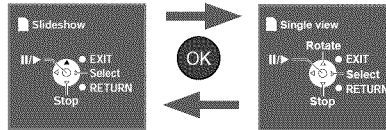

Photo status



Navigation Guide



- To display/hide Guide and Banner → INFO

View select

① Display the viewing mode selection screen



② Select the view type

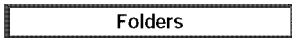

- Folder view: Displays the thumbnails grouped by folders

③ Select folder view to display the thumbnails of the selected group

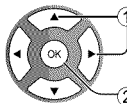

- ① Select
- ② Display thumbnails of the selected folder

- To return to the thumbnail of all photos



Slideshow settings

① Display the "Slideshow settings" screen

OPTION



② Select the items and set

Slideshow settings	
Transition effect	Dissolve ◀▶
Photo size	Normal ◀▶
Display interval	5 seconds ◀▶
Repeat	Off ◀▶
Background music	Off ◀▶

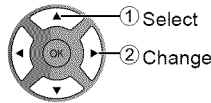

Settings	Item Description
Transition effect	<p>Selects the transition effect shown between photos ("None" / "Dissolve" / "Wipe →" / "Wipe ←" / "Wipe ↑" / "Wipe ↓" / "Box in" / "Box out" / "Random")</p> <p>"Dissolve" : The photo is replaced by an indefinite block unit</p> <p>"Wipe →" : The next photo slides over the preceding clip from left to right.</p> <p>"Wipe ←" : The next photo slides over the preceding clip from right to left.</p> <p>"Wipe ↑" : The next photo slides over the preceding clip from bottom to top.</p> <p>"Wipe ↓" : The next photo slides over the preceding clip from top to bottom.</p> <p>"Box in" : A box shape expands from each of the four corners toward the center.</p> <p>"Box out" : A box shape expands from the center of each quadrant toward the corners of each quadrant.</p> <p>"Random" : Each transition mode is performed randomly.</p>
Photo size	<p>Selects enlarged or normal viewing mode on Single view and Slideshow ("Zoom" / "Normal")</p> <ul style="list-style-type: none"> Depending on the photo size, the photo may not be enlarged.
Display interval	<p>Sets the interval for each image to be displayed in the Slideshow mode. ("5" / "10" / "15" / "30" / "60" / "90" / "120" seconds)</p>
Repeat	<p>Turn the slideshow repeat (cycle) function on or off ("Off" / "On").</p>
Background music	<p>Selects the background music during Photo mode ("Off" / "Type 1" / "Type 2" / "Type 3")</p> <ul style="list-style-type: none"> "Type 1", "Type 2" and "Type 3" are the fixed music each installed in this TV.

- Picture quality may be lower depending on the slideshow settings.
- Picture setting may not work depending on the slideshow settings.

Music view

Music thumbnail

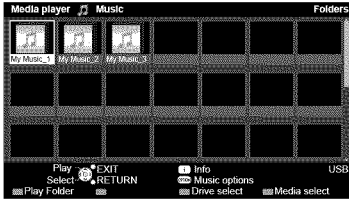

Features

- ① Play folder → R
- ② Drive select → B
- ③ Media select → Y

Music playback screen

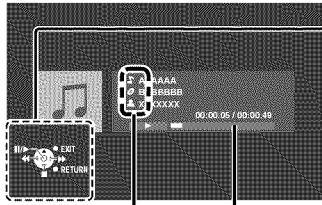

Navigation area

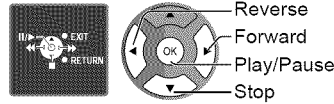

- Forward/Reverse
Five levels of 1 to 5 (x2, x5, x30, x70, x100) are available.

- Artist name Elapsed time of current song
- Album name
- Song name

To display/hide Guide and Banner → INFO

Music options

① Display the "Music options" screen

OPTION



② Set the play repeat function to your preference

■ Repeat ("Off" / "One" / "Folder")

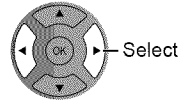
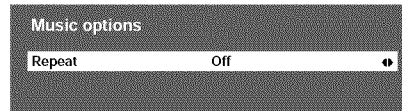

Videos view

Videos thumbnail

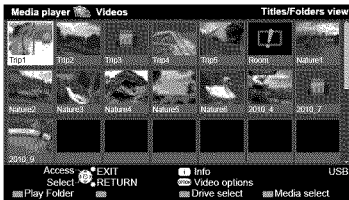

Features

- ① Play folder → R
- ② Drive select → B
- ③ Media select → Y
- ④ Aspect change → FORMAT

Videos playback screen

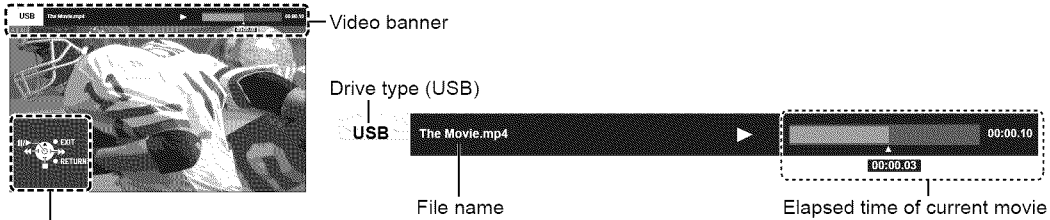

Navigation area

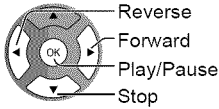

- Forward/Reverse
Five levels of 1 to 5 (x2, x5, x30, x70, x100)
are available.

• Subtitles are not supported.

• To display/hide Guide and Banner

Video options

① Display the "Video options" screen

OPTION



② Select the items and set

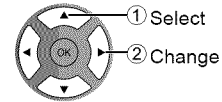
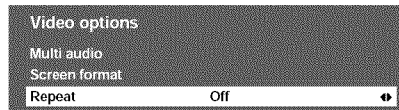

Settings	Item Description
Multi audio	Selects between selectable sound tracks (if available) • Selections depend on the contents you are watching.
Screen format	Sets the aspect to your viewing preference • Selections depend on the type of signal you are watching, SD or HD.
Repeat	Playback repeat ("Off" / "On").

Other settings in Media player

① Display the menu



② Select the item

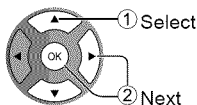
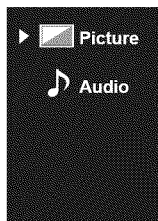

③ Set

■ Adjust the Picture and Audio

example: "Picture" menu
"Picture" / "Audio" menu (p. 30-31)

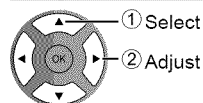
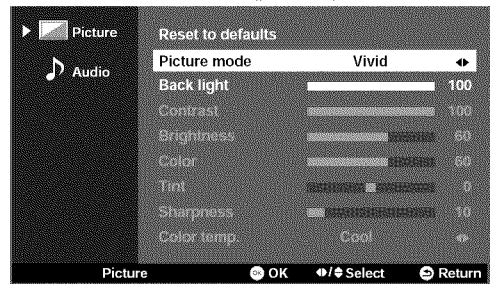

- Some items are grayed out to indicate that these items are not available. Availability depends on the contents you are enjoying.

Editing and Setting Channels

The current channel settings can be changed according to your needs and reception conditions.

Auto program

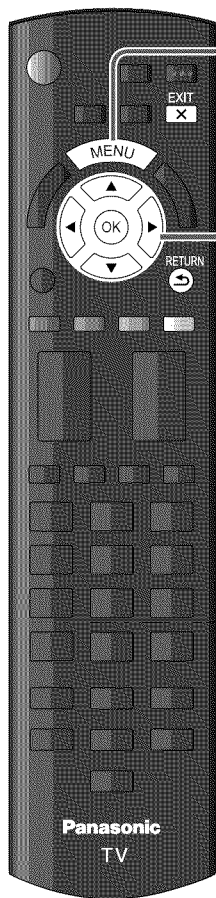

1 Display the menu



2 Select "TV"

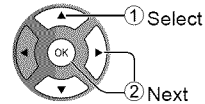
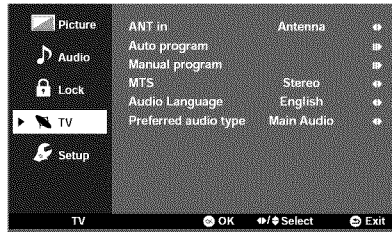

3 Select "ANT in", then select "Antenna" or "Cable"

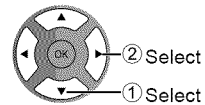
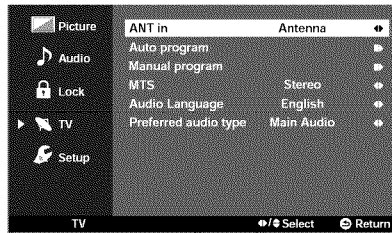

4 Select "Auto program"

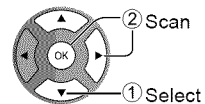
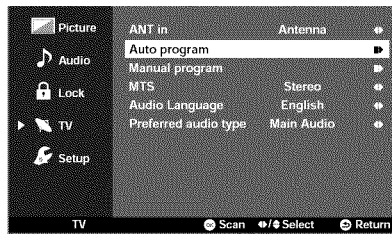

■ Press to exit from a menu screen



Automatically searches and adds available channels to the memory.

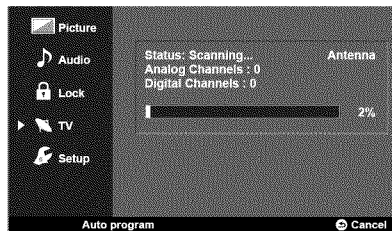

① After the scan is complete, all previously saved channels will be erased.

② To cancel scanning process



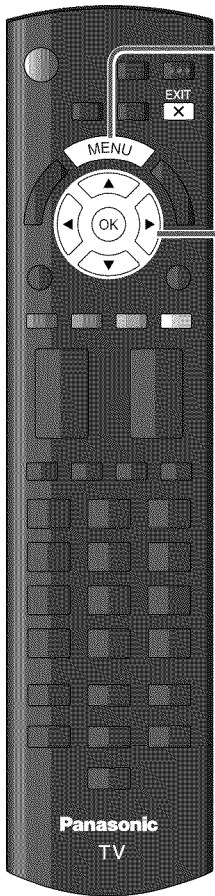

1 Display the menu



2 Select "TV"

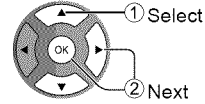
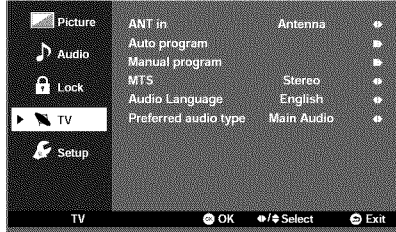

3 Select "ANT in", then select "Antenna" or "Cable"

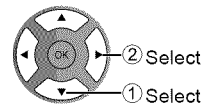
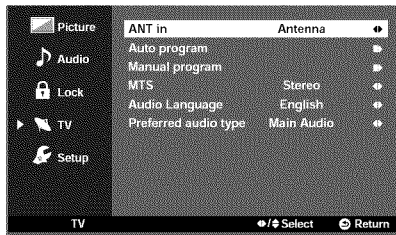

4 Select "Manual program"

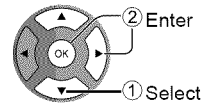
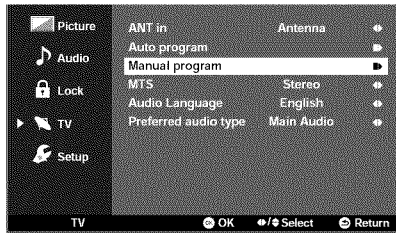

■ Press to exit from a menu screen



5 Select the channel you want to set/remove from the channel list

2	Analog	<input checked="" type="checkbox"/>
3	Analog	<input checked="" type="checkbox"/>
4	Analog	<input checked="" type="checkbox"/>
5	Analog	<input checked="" type="checkbox"/>
6	Analog	<input checked="" type="checkbox"/>
7	Analog	<input checked="" type="checkbox"/>
8	Analog	<input checked="" type="checkbox"/>
9	Analog	<input checked="" type="checkbox"/>
10	Analog	<input checked="" type="checkbox"/>

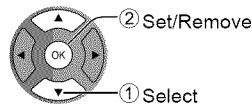

: channel will be removed from the channel list
(You cannot select the channel using [CH up/down] button.)

: channel will remain on the channel list

To change channel list pages

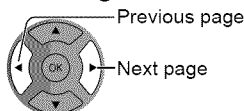

Input Labels

You can label the terminal with the type of equipment connected to it. This makes selecting the correct input easier (Input select ➔ p. 19).

You can also skip any unused terminal with this feature.

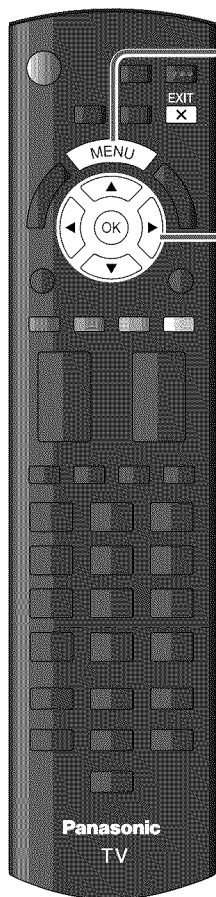

1 Display the menu



2 Select "Setup"

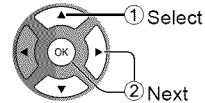
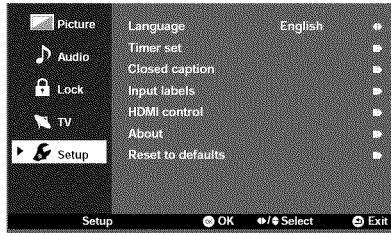

3 Select "Input labels"

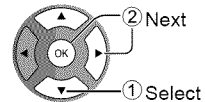
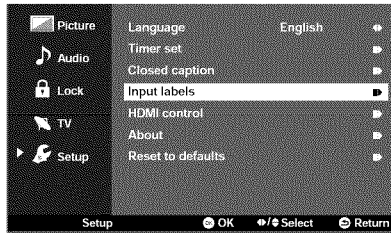

4 Select an input terminal and set

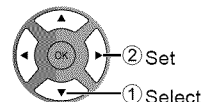
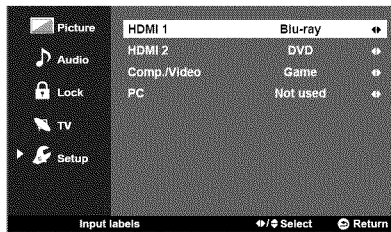

■ Press to exit from a menu screen



- 1 The labels you set will be displayed in the "Input select" screen (p. 19).
- 2 If "Not used" is selected, you cannot select the mode.

How to Use Menu Functions

Various menus allow you to make changes to video, audio, and other settings to help you enjoy a TV viewing experience best suited for you.

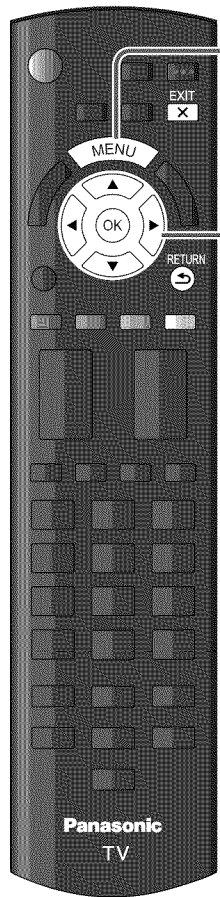

1 Display the menu



- ① Shows the functions that can be adjusted.
- ② Some functions will be disabled depending on the type of input signal.

Menu structure

Menu bar

Press [OK] or [right cursor] to move to the menu items

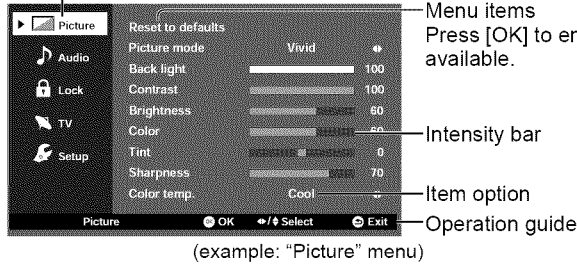

2 Select the menu

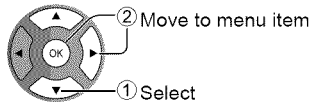
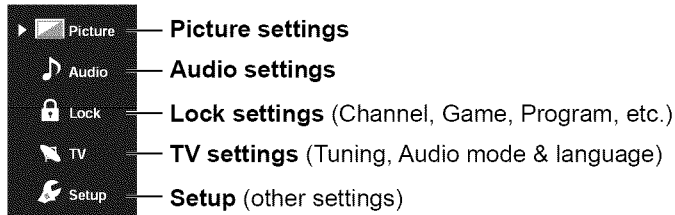

3 Select a menu item, then adjust or select the option

■ Press to exit from a menu screen
EXIT

■ Press to go back to the previous screen
RETURN

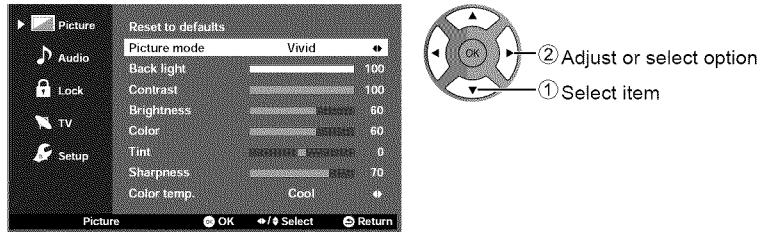

① Some items have submenus, press [OK] or [right cursor] to enter the submenu.

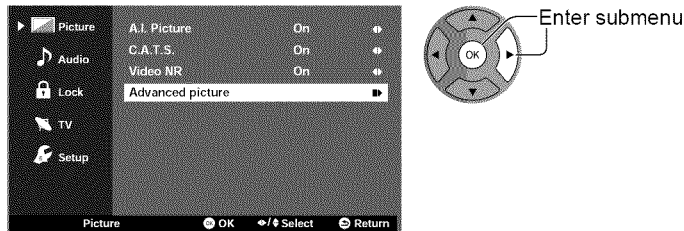

Settings	Items	Item Description		
Reset to defaults		Resets all picture adjustments to factory default settings. Press the [OK] button to proceed.		
Picture mode	Vivid	Provides enhanced picture contrast and sharpness for viewing in a well-lit room.		
	Standard	Recommended for normal viewing conditions with subdued room lighting.		
	Cinema	For watching movies in a darkened room. It provides a soft, film-like picture.		
	Game	For playing video games.		
	Custom (Photo)	Customizes each item according to your preference. Photo is displayed in JPEG menu (full screen).		
Back light		Adjusts the luminance of the back light.		
Contrast, Brightness, Color, Tint, Sharpness		Adjusts the color, brightness, etc. for each picture mode to suit your preference		
		• Display range	Contrast/Brightness/Color/Sharpness : 0 - 100 Tint : -50 - +50	
Color temp.	Cool/ Normal/ Warm	Selects a choice of Cool (blue), Normal, or Warm (red) color.		
A.I. picture	Off/ On	Controls dark areas without affecting the black level or brightness in the overall picture.		
C.A.T.S.	Off/ On	Automatically adjusts the screen brightness according to the ambient lighting condition.		
Video NR	Off/ On	Reduces noise, commonly called snow. Leave it off when receiving a strong signal.		
Advanced picture	3D Y/C Filter	Off/ On	Minimizes noise and cross-color in the picture.	
	Color matrix	SD/ HD	Selects image resolution of component-connected devices. SD: Standard-Definition HD: High-Definition Only used with 480p video signal.	
	Black level	Dark/ Light	Selects Dark or Light. Valid only for external input signals.	
	MPEG NR	Off/ On	Reduces picture noise in MPEG-compressed video. • For Digital TV only	
	3:2 pulldown	Off/ Auto	Adjusts the picture recorded in 24 fps for optimum quality.	
	Aspect adjustments	Screen format	FULL/4:3/JUST/ ZOOM/H-FILL	Changes the format (aspect ratio). Lets you choose the aspect depending on the format of received signal. (p. 36)
		H size (displayed when the input signal is SD)	Size 1/Size 2	Adjusts the horizontal display range to reduce noise of both side edges of an image. Size 2: Adjusts the image size according to the aspect mode to reduce noise. (p. 36)
HD size (displayed when the input signal is HD)		Size 1/Size 2	Selects between 95 % (Size 1) or 100 % (Size 2) for the scanning area with High-definition signal. Select "Size 1" if noise is generated on the edges of the screen. • Size 1: Selected item for "HD size". Scanning 95 % • Size 2: Selected item for "HD size". Scanning 100 %	
Zoom adjustments		V-position/ V-size	Adjusts vertical alignment and size when aspect setting is "Zoom".	

- Some menus are grayed out depending on the input signal or condition. (e.g. "3:2 pulldown" will be grayed out if the input signal is high-definition or you are viewing photos, etc.)

Audio settings Adjust Audio quality

Settings	Items	Item Description
Reset to defaults		Resets "Bass", "Treble", "Balance", "Surround" and "TV speakers" adjustments to factory default settings. Press the [OK] button to proceed.
Bass		Increases or decreases the bass response.
Treble		Increases or decreases the treble response.
Balance		Emphasizes the left / right speaker volume.
Surround	Off/ On	Enhances audio L/R response when listening to stereo.
TV speakers	Off/ On	Switches to "Off" when using external speakers. Off: "Surround" does not work if "Off" is selected. • "Bass", "Treble" and "Balance" will be grayed out when "TV speakers" is set to "Off".
SPDIF Type	Off/ Dolby Digital/ PCM	SPDIF: A protocol and physical interface for digital audio signal Selects the initial setting for digital audio output signal from DIGITAL AUDIO OUT terminal PCM: Digital output signal is fixed to PCM. Dolby Digital: Digital output signal is fixed to Dolby Digital. • When TV receives NTSC signal, the output is PCM. • For Digital TV or Video mode
Audio input	HDMI1-2 in	Digital/ Analog The default setting is "Digital" for the HDMI connection. (Digital input signal) Select audio input terminal when DVI cable is connected. (Analog audio input signal)

Lock settings Locks specified channels or shows to prevent children from watching objectionable content.

You will be asked to enter your password each time you display the "Lock" menu.
• Password setting/entering ➔ p. 18

Set "Custom" in "Mode" to specify "Channel", "Program" and "Input".

Settings	Items	Item Description
Mode	Off	Unlocks all the Lock settings of "Channel", "Program" and "Input".
	All	Locks all the inputs regardless of the Lock settings of "Channel", "Program" and "Input".
	Custom	Locks specified inputs of "Channel", "Program" and "Input".
Channel (These channels will be blocked regardless of the program rating.)	Channel	Select a channel to lock.
	Mode	Off/On Set program lock status. "V-chip" technology enables restricted shows to lock according to TV ratings. On: Set each rating level (U.S.TV Ratings, U.S. Movie Ratings, C.E.L.R., C.F.L.R.)
Program (To set a rating level)	U.S.TV Ratings	U.S. TV program ratings.
	U.S. Movie Ratings	U.S. movie ratings.
	C.E.L.R.	Canadian English ratings.
	C.F.L.R.	Canadian French ratings.
Inputs	HDMI1-2/ Comp./Video/ PC	Locks external inputs accordingly.
Change password		Changes the password. Input the new 4-digit password twice.

- This television is designed to support the "Downloadable U.S. Region Rating System" when available. (Available only in the U.S.A.)
- The Off rating is independent of other ratings.
- When placing a lock on a specific-age-based-rating level, the Off rating and any other more restrictive ratings will also be blocked.

TV settings**Tuning, setting audio mode & language**

Settings	Items	Item Description
ANT in	Cable/Antenna	
Auto program		See p. 26-27 for more detail.
Manual Program		
MTS	Stereo/ SAP/ Mono	Selects the Audio mode for watching TV (p. 16)
Audio Language	English/ Español/ Français	Selects the language for TV programs
Preferred audio type	Main Audio/ Hearing Impaired/ Visually Impaired	Narration settings for impaired users Hearing Impaired: Activates closed captioning when available on broadcasts. Visual Impaired: Activates the narration soundtrack when available on broadcasts. • For Digital TV only

Setup**Other function settings**

Settings	Items	Item Description
Language	English/ Español/ Français	Selects the screen menu language.
Timer Set	Sleep Timer	Off/15/30/60/90 (minutes) Sets the period after which the TV will turn off automatically.
	No signal for 10 minutes	Stay on/ Power TV off To conserve energy, the TV automatically turns off when NO SIGNAL and NO OPERATION continue for more than 10 minutes. • The on-screen display will flash 3, 2 and 1 to indicate the last three (3) remaining minutes prior to the shut-off.
	No activity for 3 hours	Stay on/ Power TV off To conserve energy, the TV automatically turns off when no operation of remote and back panel key continues for more than 3 hours. • The on-screen display will flash 3, 2 and 1 to indicate the last three (3) remaining minutes prior to the shut-off.

Settings	Items	Item Description	
		<ul style="list-style-type: none"> The television includes a built-in decoder that is capable of providing a text display of the audio. The program being viewed must be transmitting the Closed Caption (CC) information. (p. 38) The settings in "Analog" or "Digital" depend on the broadcaster. 	
Closed Caption	Analog Closed Caption	Off/ CC1-4/ TEXT1-4	Choose the Closed Caption service of Analog broadcasting. CC1-4: Information related to pictures (Appears at the bottom of the screen) T1-4: Textual information (Appears over the entire screen)
	Digital Closed Caption	Off/ Service1-6	The Digital Closed Caption menu lets you configure the way you choose to view the digital captioning.
	Digital Caption Setting (Set display settings in digital program)	Caption Style: Auto	The default settings are displayed.
		Caption Style: Custom	You can personalize below items to your preference: Font Size Font Style Font Color Font Opacity Background Color Background Opacity Outline Color Outline Opacity
Input labels	See p. 28 for more detail.		
HDMI control	CEC function	Off/ On	On: The TV will automatically switch to the appropriate HDMI input whenever an HDMI connected equipment is initially turned on and the Play mode is selected.
	Power Off Link	No/ Yes	On: When the TV is turned off, all HDMI connected equipment is also automatically turned off. <ul style="list-style-type: none"> A Panasonic DVD Recorder will not turn off if it is still in Rec mode. The TV remains on even if the HDMI connected equipment is turned off.
About	Displays TV version and software license.		
Reset to defaults	Performing reset will clear all settings made in the "Setup" menu, such as channel settings. After reset, "First time setup" will launch when you next power on the TV (p. 14). <ul style="list-style-type: none"> Password setting/entering ➔ (p. 18) 		

Ratings List for parental control

“V-chip” technology enables you to lock channels or shows according to standard ratings set by the entertainment industry.

■ U.S. TV PROGRAMS RATINGS (U.S. TV Ratings)

Age-based Group	Age-based Ratings	Possible Content Selections	Description
NR (Not Rated)	TV-NR	<ul style="list-style-type: none"> ● Viewable ● Blocked 	Not Rated.
Youth	TV-Y	<ul style="list-style-type: none"> ● Viewable ● Blocked 	All children. The themes and elements in this program are specifically designed for a very young audience, including children from ages 2-6.
	TV-Y7	<ul style="list-style-type: none"> ● FV Blocked ● Viewable ● Blocked 	Directed to older children. Themes and elements in this program may include mild physical or comedic violence, or may frighten children under the age of 7.
Guidance	TV-G	<ul style="list-style-type: none"> ● Viewable ● Blocked 	General audience. It contains little or no violence, no strong language, and little or no sexual dialogue or situations.
	TV-PG	<ul style="list-style-type: none"> ● D,L,S,V (all selected) ● Any combination of D, L, S, V 	Parental guidance suggested. The program may contain infrequent coarse language, limited violence, some suggestive sexual dialogue and situations.
	TV-14	<ul style="list-style-type: none"> ● D,L,S,V (all selected) ● Any combination of D, L, S, V 	Parents strongly cautioned. This program may contain sophisticated themes, sexual content, strong language and more intense violence.
	TV-MA	<ul style="list-style-type: none"> ● L,S,V (all selected) ● Any combination of L, S, V 	Mature audiences only. This program may contain mature themes, profane language, graphic violence, and explicit sexual content.

FV: Fantasy/Cartoon Violence.
 V: Violence
 S: Sex
 L: Offensive Language
 D: Dialogue with sexual content.

■ U.S. MOVIE RATINGS

NR	NO RATING (NOT RATED) AND NA (NOT APPLICABLE) PROGRAMS. Movie which has not been rated or where rating does not apply.
G	GENERAL AUDIENCES. All ages admitted.
PG	PARENTAL GUIDANCE SUGGESTED. Some material may not be suitable for children.
PG-13	PARENTS STRONGLY CAUTIONED. Some material may be inappropriate for children under 13.
R	RESTRICTED. Under 17 requires accompanying parent or adult guardian.
NC-17	NO ONE 17 AND UNDER ADMITTED.
X	ADULTS ONLY.

■ CANADIAN ENGLISH RATINGS (C. E. L. R.)

E	Exempt - Exempt programming includes: news, sports, documentaries and other information programming, talk shows, music videos, and variety programming.
C	Programming intended for children under age 8. No offensive language, nudity or sexual content.
C8+	Programming generally considered acceptable for children 8 years and over. No profanity, nudity or sexual content.
G	General programming, suitable for all audiences.
PG	Parental Guidance suggested. Some material may not be suitable for children.
14+	Programming contains themes or content which may not be suitable for viewers under the age of 14. Parents are strongly cautioned to exercise discretion in permitting viewing by pre-teens and early teens.
18+	18+ years old. Programming restricted to adults. Contains constant violence or scenes of extreme violence.

■ CANADIAN FRENCH RATINGS (C. F. L. R.)

E	Exempt - Exempt programming.
G	General - Programming intended for audience of all ages. Contains no violence, or the violence content is minimal or is depicted appropriately.
8 ans+	8+ General - Not recommended for young children. Programming intended for a broad audience but contains light or occasional violence. Adult supervision recommended.
13 ans+	Programming may not be suitable for children under the age of 13 - Contains either a few violent scenes or one or more sufficiently violent scenes to affect them. Adult supervision strongly suggested.
16 ans+	Programming may not be suitable for children under the age of 16 - Contains frequent scenes of violence or intense violence.
18 ans+	Programming restricted to adults. Contains constant violence or scenes of extreme violence.

Caution

● The V-Chip system that is used in this set is capable of blocking “NR” programs (non rated, not applicable and none) as per FCC Rules Section 15.120(e)(2). If the option of blocking “NR” programs is chosen “unexpected and possibly confusing results may occur, and you may not receive emergency bulletins or any of the following types of programming:”

- Locally originated programming
- News
- Political
- Public Service Announcements
- Religious
- Sports
- Weather

Technical Information

Aspect Ratio (FORMAT)

Press the [FORMAT] button repeatedly to cycle through the aspect modes. This lets you choose the aspect depending on the format of the received signal and your preference. (p. 17)
(e.g.: in case of 4:3 image)

● JUST

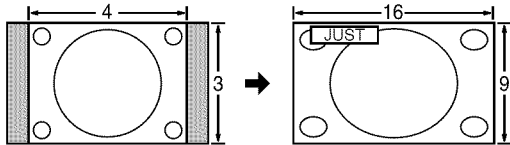

Stretches to justify the 4:3 image to the four corners of the screen.
(Recommended for normal TV broadcast)

● ZOOM

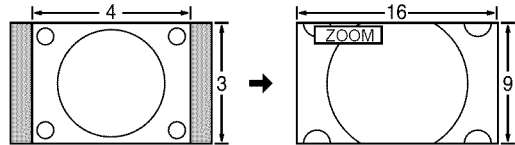

Enlarges the 4:3 image to the entire screen.
(Recommended for Letter Box)

● FULL

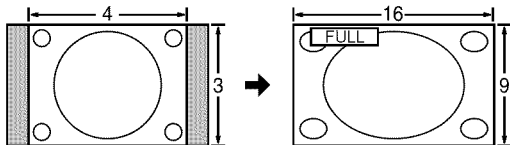

Enlarges the 4:3 image horizontally to the screen's side edges.
(Recommended for anamorphic picture)

● H-FILL

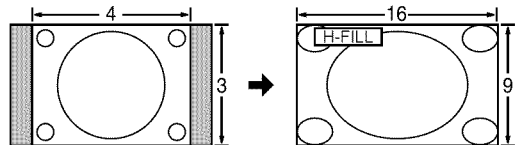

Enlarges the 4:3 image horizontally to the screen's side edges.
The side edges of the image are cut off.

● 4:3

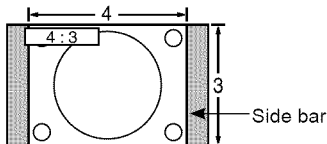

Standard
(Note that "Image retention" of the side bar may occur from displaying it for a long time.)

Note

- 480i (4:3), 480i (16:9), 480p (4:3), 480p (16:9):
FULL, JUST, 4:3 or ZOOM
- 1080p / 1080i / 720p:
FULL, H-FILL, JUST, 4:3 or ZOOM

● Zoom adjustments

Vertical image position and size can be adjusted when the aspect is set to "ZOOM".

- Select "Zoom adjustments" from "Aspect adjustments" in "Advanced picture" of "Picture" menu. (p. 30)

V-position: Vertical position adjustment

V-size: Vertical size adjustment

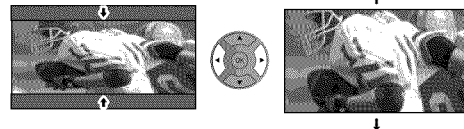
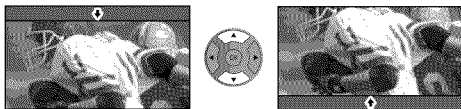

- To reset the aspect ratio ⇒  (OK)

H size

● Aspect Ratio: 4:3

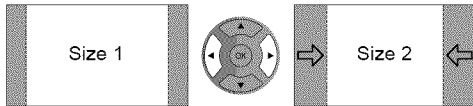

- The width will be decreased on both sides to reduce noise.

● Aspect Ratio: FULL/JUST(H-FILL/ZOOM)

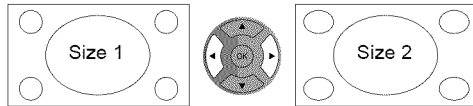

- The width will be increased on both sides to reduce noise.

See page 30 for more information.

Data format information

● Compatible Data format for Media player (USB flash memory) ➔ p. 20

DCF (Design rule for camera file system): A Japan Electronics and Information Technology Industries Association's standard
EXIF: Exchangeable Image File Format

Note

- The picture may not appear correctly on this TV depending on the recording equipment used.
- Display may take some time when there are many files and folders.
- The function (Media player) cannot display Motion JPEG and still image not DCF formatted (i.e. TIFF, BMP).
- Data modified with a PC may not be displayed.
- Images imported from a PC must be compatible with EXIF 2.0, 2.1 and 2.2.
- Partly degraded files might be displayed at a reduced resolution.
- All ".JPG" extension data in the USB flash memory will be read in Photo viewer Mode.
- The folder and file names may be different depending on the digital camera used.
- Do not use two-byte characters or other special codes.

USB flash memory warning messages

Message	Meaning
Cannot read file	<ul style="list-style-type: none"> ● The file is broken or unreadable. ● The TV does not support the format.
No Device Inserted	<ul style="list-style-type: none"> ● Confirm USB device is inserted correctly.
This operation is not possible	<ul style="list-style-type: none"> ● Your operation is not available.

HDMI connection

HDMI (high-definition multimedia interface) allows you to enjoy high-definition digital images and high-quality sound by connecting the TV unit and HD devices.

HDMI-compatible equipment (*1) with an HDMI or DVI output terminal, such as a Cable or Satellite box or a DVD player, can be connected to the HDMI connector using an HDMI compliant (fully wired) cable.

- HDMI is the world's first complete digital consumer AV interface complying with a non-compression standard.
- If the external equipment has only a DVI output, connect to the HDMI terminal via a DVI to HDMI adapter cable (*2).
- When the DVI to HDMI adapter cable is used, connect the audio cable to the audio input terminal.
- Audio settings can be made on the "HDMI1 input" or "HDMI2 input" menu screen. (p. 31)
 - Applicable audio signal sampling frequencies (L.PCM): 48 kHz, 44.1 kHz, 32 kHz
 - (*1): The HDMI logo is displayed on an HDMI-compliant device.
 - (*2): Enquire at your local digital equipment retailer shop.

Caution

- All signals are reformatted before being displayed on the screen.
- If the connected device has an aspect adjustment function, set the aspect ratio to "16:9".
- These HDMI connectors are "type A".
- These HDMI connectors are compatible with HDCP (High-Bandwidth Digital Content Protection) copyright protection.
- A device having no digital output terminal may be connected to the input terminal of either "COMPONENT", or "VIDEO" to receive analog signals.
- The HDMI input terminal can be used with only the following image signals: 480i, 480p, 720p, 1080i and 1080p.
Match the output setting of the digital device.
- If the HDMI 2 terminal is connected with an ARC equipment but "SPDIF Type" in the "Audio" menu is set to "Off", no audio will be output from the ARC equipment.
- For details of the applicable HDMI signals, see p. 39.

DIGITAL AUDIO OUT terminal

You can enjoy your Home theater by connecting a Dolby Digital (5.1 channel) decoder and "Multi Channel" amplifier to the DIGITAL AUDIO OUT terminals.

Caution

- Depending on your DVD player and DVD-Audio software, the copyright protection function may operate and disable optical output.
- Please select "Dolby Digital" in "SPDIF type" in "Audio" menu, if you want to enjoy 5.1 multi channel stereo sound. But when a NTSC channel is selected, the output from the DIGITAL AUDIO OUT jack will be PCM even if you select "Dolby Digital" as SPDIF type.

Closed Caption (CC)

- For viewing the CC of digital broadcasting, set the aspect to Full (If viewing with H-Fill, Just, Zoom or 4:3; characters might be cut off).
- The CC can be displayed on the TV only when the receiver (such as a Cable box or satellite receiver) has the CC set to ON within the device itself. Check with your Cable or Satellite provider for instructions. The TV's CC button does not operate the Satellite or Cable box's CC function.
- If the CC is set to On on both the receiver and TV when the signal is 480i (except for the HDMI connection), the CC may overlap on the TV.
- If a digital program is being output in analog format, the CC data will also be output in analog format.
- If the recorder or output monitor is connected to the TV, the CC needs to be set up on the recorder or output monitor.

PC Input Terminals

● Signal Names for D-sub 15P Connector

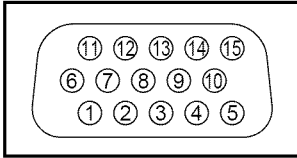

Pin Layout for PC Input Terminal

Pin No.	Signal Name	Pin No.	Signal Name	Pin No.	Signal Name
①	R	⑥	GND (Ground)	⑪	NC (not connected)
②	G	⑦	GND (Ground)	⑫	NC
③	B	⑧	GND (Ground)	⑬	HD/SYNC
④	NC (not connected)	⑨	NC (not connected)	⑭	VD
⑤	GND (Ground)	⑩	GND (Ground)	⑮	NC

Input signal that can be displayed

* Mark: Applicable input signal for Component (Y, Pb, Pr), HDMI and PC

	horizontal frequency (kHz)	vertical frequency (Hz)	COMPONENT	HDMI	PC
525 (480)/60i	15.73	59.94	*	*	
525 (480)/60p	31.47	59.94	*	*	
750 (720)/60p	45.00	59.94	*	*	
1,125 (1,080)/60i	33.75	59.94	*	*	
1,125 (1,080)/60p	67.43	59.94		*	
1,125 (1,080)/60p	67.50	60.00		*	
1,125 (1,080)/24p	26.97	23.98		*	
1,125 (1,080)/24p	27.00	24.00		*	
640 × 400 @70	31.47	70.08			*
640 × 480 @60	31.47	59.94			*
Macintosh13" (640 × 480)	35.00	66.67			*
640 × 480 @75	37.50	75.00			*
852 × 480 @60	31.44	59.89			*
800 × 600 @60	37.88	60.32			*
800 × 600 @75	46.88	75.00			*
800 × 600 @85	53.67	85.08			*
Macintosh16" (832 × 624)	49.73	74.55			*
1,024 × 768 @60	48.36	60.00			*
1,024 × 768 @70	56.48	70.07			*
1,024 × 768 @75	60.02	75.03			*
1,024 × 768 @85	68.68	85.00			*
Macintosh 21" (1,152 × 870)	68.68	75.06			*
1,280 × 768 @60	47.78	59.87			*
1,280 × 1,024 @60	63.98	60.02			*
1,366 × 768 @60	48.39	60.04			*

Note

- Signals other than above may not be displayed properly.
- The above signals are reformatted for optimal viewing on your display.
- Computer signals that can be input are those with a horizontal scanning frequency of 15 to 110 kHz and vertical scanning frequency of 48 to 120 Hz. (However, the image will not be displayed properly if the signals exceed 1,200 lines.)

Panasonic does not guarantee operation and performance of peripheral devices made by other manufacturers; and we disclaim any liability or damage arising from operation and/or performance from usage of such other maker's peripheral devices.

Care and Cleaning

First, unplug the Power cord plug from the wall outlet.

Display panel

The front of the display panel has been specially treated. Wipe the panel surface gently, using only a cleaning cloth or a soft, lint-free cloth.

- If the surface is particularly dirty, soak a soft, lint-free cloth in diluted, mild liquid dish soap (1 part mild liquid dish soap diluted by 100 times the amount of water) and then wring the cloth to remove excess liquid. Use this cloth to wipe the surface of the display panel, then wipe it evenly with a dry cloth of the same type until the surface is dry.
- Do not scratch or hit the surface of the panel with fingernails or other hard objects. Furthermore, avoid contact with volatile substances such as insect sprays, solvents, and thinner; otherwise, the quality of the surface may be adversely affected.

Cabinet

If the cabinet becomes dirty, wipe it with a soft, dry cloth.

- If the cabinet is particularly dirty, soak the cloth in diluted, mild liquid dish soap and then wring the cloth dry. Use this cloth to wipe the cabinet and then wipe it dry with a dry cloth.
- Do not allow any mild liquid dish soap to come into direct contact with the surface of the LCD TV. If water droplets get inside the unit, operating problems may result.
- Avoid contact with volatile substances such as insect sprays, solvents, and thinner; otherwise, the quality of the cabinet surface may be adversely affected or the coating may peel off.
- Do not let articles made from rubber or PVC be in contact with the TV for long periods of time.

Pedestal

Cleaning:

- Wipe the surfaces with a soft, dry cloth. If the unit is particularly dirty, clean it using a cloth soaked with water to which a small amount of mild liquid dish soap has been added and then wipe with a dry cloth. Do not use products such as solvents, thinner, or household wax for cleaning, as they can damage the surface coating. (If using a chemically-treated cloth, follow the instructions supplied with the cloth.)
- Do not attach sticky tape or labels, as they can make the surface of the pedestal dirty. Do not allow long-term contact with rubber, vinyl products, or the like. (Doing so will cause deterioration.)

Power cord plug

Wipe the plug with a dry cloth at regular intervals. (Moisture and dust can lead to fire or electrical shock.)

Specifications

		TC-L50EM5
Power Source		AC 110 - 127 V, 60 Hz
Power Consumption (Rated power / Standby power)		99 W / 0.25 W
Display Panel	Panel System	LCD panel (LED backlight)
	Screen size	50 " class (49.5 inches measured diagonally)
	W × H × Diagonal	43.1 " × 24.2 " × 49.5 " (1,096 mm × 616 mm × 1,257 mm)
	Number of pixels	1,920 × 1,080
Speaker Output		20 W [10 W + 10 W] (10 % THD)
PC signals		VGA, SVGA, XGA, WXGA, SXGA Horizontal scanning frequency 31 - 69 kHz Vertical scanning frequency 59 - 86 Hz
Channel Capability (Digital/Analog)		VHF/ UHF: 2 - 69, CATV: 1 - 135
Operating Conditions		Temperature: 32 °F - 95 °F (0 °C - 35 °C) Humidity: 20 % - 80 % RH (non-condensing)
Connection Terminals	VIDEO IN	RCA PIN (VIDEO, AUDIO-L, AUDIO-R)
	COMPONENT IN	RCA PIN (Y, P _B , P _R , AUDIO-L, AUDIO-R)
	HDMI IN 1/2	TYPE A Connector
	USB	USB2.0 Type A connector
	PC IN	D-SUB 15PIN (VGA, SVGA, XGA, WXGA, SXGA)
	DIGITAL AUDIO OUT	PCM / Dolby Digital, Fiber Optic
FEATURES		3D Y/C FILTER V-Chip CLOSED CAPTION Vesa compatible Media player
Dimensions	Including pedestal (W × H × D)	45.7 " × 29.1 " × 11.8 " (1,159 mm × 738 mm × 298 mm)
	TV Set only (W × H × D)	45.7 " × 27.3 " × 2.8 " (1,159 mm × 693 mm × 69 mm)
Mass	Including pedestal	46.3 lb. (21.0 kg) NET
	TV Set only	38.6 lb. (17.5 kg) NET

Note

- Design and Specifications are subject to change without notice. Mass and Dimensions shown are approximate.

Frequently Asked Questions (FAQ)

If there is a problem with your TV, please refer to the table below to determine the symptoms, then carry out the suggested check. If this does not solve the problem, visit the Panasonic website for further assistance. (see cover)

	Questions	Answers
Picture	How do I view the picture from devices such as a: Cable/Satellite box, game console, Blu-ray or DVD player?	<ul style="list-style-type: none"> ● Press the [INPUT] button on the remote to select the correct input source. ● Check that the device is turned on and functioning correctly.
	Why is there no picture or just a blue, black or snowy screen being displayed?	<ul style="list-style-type: none"> ● Check if the power cord is plugged in and the TV is turned on (front red LED light should be on; not blinking) ● Press the [INPUT] button on the remote to select the correct input source. ● Ensure all connections are correct and secure. ● When using external video source, such as a Cable/Satellite box or DVD player, check that the device is on and functioning correctly. ● Press [MENU] on the TV's remote control. If the menu is displayed, then the TV is working; recheck above steps.
	Why doesn't the picture look like it is in High-Definition?	<ul style="list-style-type: none"> ● Press the [INFO] button on the remote to confirm the type of signal being received (p. 17). HD signal should be 720p, 1080i or 1080p. ● Select a High-Definition channel from your HD source (Cable, Satellite or fiber optic service). HD channels sometimes broadcast non-HD content. ● Ensure that your HD source (HD box, Blu-ray player, etc.) is connected to the TV with an HDMI or Component cable and set to output an HD video signal.
	Why do black bars appear on the top and bottom and/or sides of the screen?	<ul style="list-style-type: none"> ● Change the format (aspect ratio) of the picture by pressing the [FORMAT] button on the remote control (p. 17). ● Check the aspect settings on your external video source, such as Cable/Satellite box, DVD/Blu-ray Disc player, etc. Note: Some content, such as film-based movies, are available in extra-wide format. Top and bottom bars are unavoidable.
	Why is the picture snowy when "ANT in" is selected?	<ul style="list-style-type: none"> ● When using a cable service (without a box), check that all connections are secure. ● When using a cable or satellite box, change the connection (wiring) to Composite, Component or HDMI. (p. 12) ● If you're using an antenna, then check that connections are secure. Change the position or direction of the antenna and check the "Signal Meter". (p. 17)
	Why is the picture chaotic and/or torn and/or with a buzz in the speakers?	<ul style="list-style-type: none"> ● Check if electrical products such as kitchen appliances, fluorescent lights or light dimmers are nearby. They may interfere with the TV's picture. ● Try viewing a picture from another device, such as a DVD player or a game console, to narrow down the source of the problem.
	Why is there a black box on the screen?	<ul style="list-style-type: none"> ● Change settings of Closed Caption (CC). (p. 16, 38)
	Why is the screen blank and the power indicator blinking?	<ul style="list-style-type: none"> ● The TV has gone into shutdown mode to protect itself. Try unplugging it for a few minutes and connecting it again. If there was a temporary power surge on the AC line it may now be OK. If the blinking returns, call 1-877-95-VIERA (U.S.A.) or 1-866-330-0014 (Canada).
	Why do some small spots on the screen remain bright or dark?	<ul style="list-style-type: none"> ● The LCD panel is made up of a few million pixels and is produced with advanced technology through an intricate process. Sometimes a few pixels may be bright or dark. These pixels do not indicate a defective panel and will have no impact on the performance of the TV.

	Questions	Answers
Sound	Why is there no sound coming from the TV?	<ul style="list-style-type: none"> ● Make sure the volume is up and MUTE is off. ● Check that the correct SAP (Secondary Audio Program) is selected by pressing the [SAP] button on the remote control. (p. 16) ● If the TV is connected to a Home Theater via optical cable, then: Check the connection, the audio system is on, the correct input is selected. ● Check "HDMI1 input" or "HDMI2 input" analog/digital audio settings. (p. 31)
	Why is the sound unusual, distorted, low volume or in another language?	<ul style="list-style-type: none"> ● Check that the correct SAP (Secondary Audio Program) is selected by pressing the [SAP] button on the remote control. ● Check that all connections of external equipment connected to the TV are secure. ● When using Cable or Satellite box, check the device's audio settings (example: try changing the box's Audio Range to 'narrow')
	Why is there a clicking, ticking or buzzing sound coming from the TV unit?	<ul style="list-style-type: none"> ● When TV power is turned on or shut off there are electrical components that make a click sound. This is normal operation. ● Changes in the temperature and humidity of the room may cause thermal expansion and contraction that can produce sounds. This is not a sign of faulty operation or a malfunction.
Other	What is the easiest and best way to connect a High-Definition Cable or Satellite box to the TV?	<ul style="list-style-type: none"> ● Use an HDMI cable. It carries both digital video and audio signal in HD. HDMI cable is the only cable needed to connect an HD device to the TV.
	Why does the [CC] button not display Closed Caption?	<ul style="list-style-type: none"> ● When viewing TV via an HDMI connected device, such as a Cable or Satellite box, CC must be enabled at the device. ● Closed Caption is available only at supported TV programming.
	Why does the screen and back cover of the TV get warm?	<ul style="list-style-type: none"> ● The main unit radiates heat and some of the parts may become hot. This is normal operation and does not affect the performance of the set. ● Ensure good ventilation. ● Do not block the ventilation holes of the TV and do not place the TV on top of other equipment.
	Why doesn't the Remote Control work?	<ul style="list-style-type: none"> ● Check that the batteries are fresh, are of the same type and are installed with the correct polarity (+ & -). ● To operate other devices, such as changing channels when using Cable or Satellite boxes or operating non-Panasonic Blu-ray players, use the remote supplied with the device.
	Why are some menu items grayed-out and unable to be selected?	<ul style="list-style-type: none"> ● Depending on certain modes or the selected input, some options are not available. For example, Zoom adjustments are only available when the FORMAT is changed to zoom mode.

Index

A

Accessories	8
ANT/Cable	26, 27
Antenna	11
Audio	31

B

Blinking LED	42
--------------------	----

C

Cable	11, 12
Care & Cleaning	40
CC Closed Caption	16, 33, 38
Channel	16, 18, 26-27
Colored buttons	13
COMPONENT input terminals	12
Connections	11-12
Customer Services Directory	46

E

Exit	13
------------	----

F

FAQ's	42-43
Favorite	18
First Time Setup	14-15
Format	17, 36

H

HDMI	38
HDMI terminals	12

I

Info	17
Input	19
Input Labels	28, 33

L

Language	14, 32
Last	13
Lock / Parental control	31, 34

M

Media player	20-25
Menu	29
Music	24
Mute	13

O

Options menu	17
--------------------	----

P

Pedestal	8, 9
Photo	22-23
Picture, Advanced	30
Picture settings	30
Power	13

R

Remote control	13
Reset	30, 31, 33

S

Safety	4
SAP	16
Specifications	41
Store Demonstration	14

T

Technical Information	36-39
-----------------------------	-------

U

USB	20
-----------	----

V

VIDEO input terminals	12
Videos	24-25
Viewing contents	21
Volume	13

W

Warranty	45, 47
Watching content from external devices	19
Watching TV	16-18

Z

Zoom	36
------------	----

Limited Warranty (for U.S.A. and Puerto Rico only)

Panasonic Consumer Marketing Company of North America,
Division of Panasonic Corporation of North America
One Panasonic Way
Secaucus, New Jersey 07094

Panasonic LCD Televisions Limited Warranty

Limited Warranty Coverage

If your product does not work properly because of a defect in materials or workmanship, Panasonic Consumer Marketing Company of North America (referred to as "the warrantor") will, for the length of the period indicated on the chart below, which starts with the date of original purchase ("Limited Warranty period"), at its option either (a) repair your product with new or refurbished parts, (b) replace it with a new or a refurbished equivalent value product, or (c) refund your purchase price. The decision to repair, replace or refund will be made by the warrantor.

LCD TV CATEGORIES	PARTS	LABOR	SERVICE
Up to 42" (diagonal)	1 (ONE) YEAR	1 (ONE) YEAR	Carry-In
46" (diagonal) and larger			On-Site

During the "Labor" Limited Warranty period there will be no charge for labor. During the "Parts" Limited Warranty period, there will be no charge for parts.

You must carry-in your product or arrange for on-site service during the Limited Warranty period. If non-rechargeable batteries are included, they are not warranted. This Limited Warranty only applies to products purchased and serviced in the United States or Puerto Rico. This Limited Warranty is extended only to the original purchaser of a new product which was not sold "as is". A purchase receipt or other proof of the original purchase date is required for Limited Warranty service.

On-Site or Carry-in Service

For On-Site or Carry-In Service in the United States and Puerto Rico call 1-877-95-VIERA (1-877-958-4372).

On-site service where applicable requires clear, complete and easy access to the product by the authorized servicer and does not include removal or re-installation of an installed product. It is possible that certain on-site repairs will not be completed on-site, but will require that the product or parts of the product, at the servicer's discretion be removed for shop diagnosis and/or repair and then returned.

Limited Warranty Limits And Exclusions

This Limited Warranty ONLY COVERS failures due to defects in materials or workmanship, and DOES NOT COVER normal wear and tear or cosmetic damage, nor does it cover markings or retained images on the glass panel resulting from viewing fixed images (including, among other things, non-expanded standard 4:3 pictures on wide screen TV's, or onscreen data in a stationary and fixed location). The Limited Warranty ALSO DOES NOT COVER damages which occurred in shipment, or failures which are caused by products not supplied by the warrantor, or failures which result from accidents, misuse, abuse, neglect, bug infestation, mishandling, misapplication, alteration, faulty installation, set-up adjustments, misadjustment of consumer controls, improper maintenance, power line surge, lightning damage, modification, or commercial use (such as in a hotel, office, restaurant, or other business), rental use of the product, service by anyone other than a Factory Service Center or other Authorized Servicer, or damage that is attributable to acts of God.

THERE ARE NO EXPRESS WARRANTIES EXCEPT AS LISTED UNDER "LIMITED WARRANTY COVERAGE". THE WARRANTOR IS NOT LIABLE FOR INCIDENTAL OR CONSEQUENTIAL DAMAGES RESULTING FROM THE USE OF THIS PRODUCT, OR ARISING OUT OF ANY BREACH OF THIS LIMITED WARRANTY. (As examples, this excludes damages for lost time, cost of having someone remove or re-install an installed unit if applicable, or travel to and from the servicer. The items listed are not exclusive, but are for illustration only.) **ALL EXPRESS AND IMPLIED WARRANTIES, INCLUDING THE LIMITED WARRANTY OF MERCHANTABILITY, ARE LIMITED TO THE PERIOD OF THE LIMITED WARRANTY.**

Some states do not allow the exclusion or limitation of incidental or consequential damages, or limitations on how long an implied Limited Warranty lasts, so the exclusions may not apply to you.

This Limited Warranty gives you specific legal rights and you may also have others rights which vary from state to state. If a problem with this product develops during or after the Limited Warranty period, you may contact your dealer or Service Center. If the problem is not handled to your satisfaction, then write to the warrantor's Consumer Affairs Department at the addresses listed for the warrantor.

PARTS AND SERVICE (INCLUDING COST OF AN ON-SITE SERVICE CALL, WHERE APPLICABLE) WHICH ARE NOT COVERED BY THIS LIMITED WARRANTY ARE YOUR RESPONSIBILITY.

Customer Services Directory (for U.S.A. and Puerto Rico)

Customer Services Directory (United States and Puerto Rico)

Obtain Product Information and Operating Assistance; locate your nearest Dealer or Service Center; purchase Parts and Accessories; or make Customer Service and Literature requests by visiting our Web Site at:

<http://www.panasonic.com/help>

or, contact us via the web at:

<http://www.panasonic.com/contactinfo>

You may also contact us directly at:

1-877-95-VIERA (958-4372)

Monday-Friday 9 am-9 pm; Saturday-Sunday 10 am-7 pm, EST.

■ For hearing or speech impaired TTY users, TTY: 1-877-833-8855

Accessory Purchases (United States and Puerto Rico)

Purchase Parts, Accessories and Instruction Books on line for all Panasonic Products by visiting our Web Site at:

<http://www.pstc.panasonic.com>

or, send your request by E-mail to:

npcparts@us.panasonic.com

You may also contact us directly at:

1-800-332-5368 (Phone) 1-800-237-9080 (Fax Only) (Monday - Friday 9 am to 9 pm, EST.)

Panasonic Consumer Marketing Company of North America - National Parts Center

20421 84th Avenue South,

Kent, WA 98032

(We Accept Visa, MasterCard, Discover Card, American Express, and Personal Checks)

■ For hearing or speech impaired TTY users, TTY: 1-866-605-1277

Limited Warranty (for Canada)

Panasonic Canada Inc.
5770 Ambler Drive, Mississauga, Ontario L4W 2T3
PANASONIC PRODUCT – LIMITED WARRANTY

Panasonic Canada Inc. warrants this product to be free from defects in material and workmanship under normal use and for a period as stated below from the date of original purchase agrees to, at its option either (a) repair your product with new or refurbished parts, (b) replace it with a new or a refurbished equivalent value product, or (c) refund your purchase price. The decision to repair, replace or refund will be made by Panasonic Canada Inc.

Viera TV (46" & over)	In-home service	One (1) year, parts (including panel) and labour.
Viera TV (under 46")	Carry-in service	One (1) year, parts (including panel) and labour.

In-home Service will be carried out only to locations accessible by roads and within 50 km of an authorized Panasonic service facility.

In-home service requires clear, complete and easy access to the product by the Authorized Servicer and does not include removal or re-installation of an installed product. If removal is required to service the product, it will be at the discretion of the Servicer and in no event will Panasonic Canada Inc. or the Servicer be liable for any special, indirect or consequential damages.

This warranty is given only to the original purchaser, or the person for whom it was purchased as a gift, of a Panasonic brand product mentioned above sold by an authorized Panasonic dealer in Canada and purchased and used in Canada, which product was not sold "as is", and which product was delivered to you in new condition in the original packaging.

IN ORDER TO BE ELIGIBLE TO RECEIVE WARRANTY SERVICE HEREUNDER, A PURCHASE RECEIPT OR OTHER PROOF OF DATE OF ORIGINAL PURCHASE, SHOWING AMOUNT PAID AND PLACE OF PURCHASE IS REQUIRED

LIMITATIONS AND EXCLUSIONS

This warranty **ONLY COVERS** failures due to defects in materials or workmanship, and **DOES NOT COVER** normal wear and tear or cosmetic damage. The warranty **ALSO DOES NOT COVER** damages which occurred in shipment, or failures which are caused by products not supplied by Panasonic Canada Inc., or failures which result from accidents, misuse, abuse, neglect, mishandling, misapplication, alteration, faulty installation, set-up adjustments, misadjustment of consumer controls, improper maintenance, power line surge, lightning damage, modification, introduction of sand, humidity or liquids, commercial use such as hotel, office, restaurant, or other business or rental use of the product, or service by anyone other than a Authorized Servicer, or damage that is attributable to acts of God. Dry cell batteries are also excluded from coverage under this warranty.

THIS EXPRESS, LIMITED WARRANTY IS IN LIEU OF ALL OTHER WARRANTIES, EXPRESS OR IMPLIED, INCLUDING ANY IMPLIED WARRANTIES OF MERCHANTABILITY AND FITNESS FOR A PARTICULAR PURPOSE. IN NO EVENT WILL PANASONIC CANADA INC. BE LIABLE FOR ANY SPECIAL, INDIRECT OR CONSEQUENTIAL DAMAGES RESULTING FROM THE USE OF THIS PRODUCT OR ARISING OUT OF ANY BREACH OF ANY EXPRESS OR IMPLIED WARRANTY. (As examples, this warranty excludes damages for lost time, travel to and from the Authorized Servicer, loss of or damage to media or images, data or other memory or recorded content. This list of items is not exhaustive, but for illustration only.)

In certain instances, some jurisdictions do not allow the exclusion or limitation of incidental or consequential damages, or the exclusion of implied warranties, so the above limitations and exclusions may not be applicable. This warranty gives you specific legal rights and you may have other rights which vary depending on your province or territory.

WARRANTY SERVICE

For product operation and information assistance, please contact:

Our Customer Care Centre: 1-800 #: 1-866-330-0014
or visit our website: concierge.panasonic.ca

For product repairs, please contact Viera Customer Care Agent using the above contact info.

IF YOU SHIP THE PRODUCT TO A SERVICENTRE

Carefully pack and send prepaid, adequately insured and preferably in the original carton.
Include details of the defect claimed, and proof of date of original purchase.

USA Only: Disposal may be regulated in your community due to Environmental considerations. For disposal or recycling information, please visit Panasonic website: <http://www.panasonic.com/environmental> or call 1-888-769-0149.

Sólo Estados Unidos: La disposición puede estar regulada en su comunidad debido a consideraciones ambientales. Para información sobre la disposición o reciclaje, por favor visite la página web de Panasonic: <http://www.panasonic.com/environmental> ó llame al 1-888-769-0149.

Customer's Record

The model number and serial number of this product can be found on its back cover. You should note this serial number in the space provided below and retain this book, plus your purchase receipt, as a permanent record of your purchase to aid in identification in the event of theft or loss, and for Warranty Service purposes.

Model Number _____

Serial Number _____

Anotación del cliente

El modelo y el número de serie de este producto se encuentran en su panel posterior. Deberá anotarlos en el espacio provisto a continuación y guardar este manual, más el recibo de su compra, como prueba permanente de su adquisición, para que le sirva de ayuda al identificarlo en el caso de que le sea sustraído o lo pierda, y también para disponer de los servicios que le ofrece la garantía.

Modelo _____

Número de serie _____

Panasonic Consumer Marketing Company of North America
Division of Panasonic Corporation of North America
One Panasonic Way, Secaucus
New Jersey 07094 U.S.A.

Panasonic Canada Inc.
5770 Ambler Drive
Mississauga, Ontario
L4W 2T3 CANADA

SPECIFICATIONS

Dimensions (W x H x D)	45.7" (1,159 mm) x 29.1" (738 mm) x 11.8" (298 mm) (Including TV stand) 45.7" (1,159 mm) x 27.3" (693 mm) x 2.8" (69mm) (TV Set only)
Mass	46.3 lb. (21.0 kg) (Including TV stand) 38.6 lb. (17.5 kg) (TV Set only)
Power Source	AC 110-127 V, 60 Hz
Power Consumption	99 W (Rated power) 0.25 W (Standby power)

DIMENSIONS

Top View

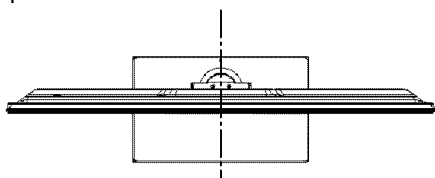

Front View

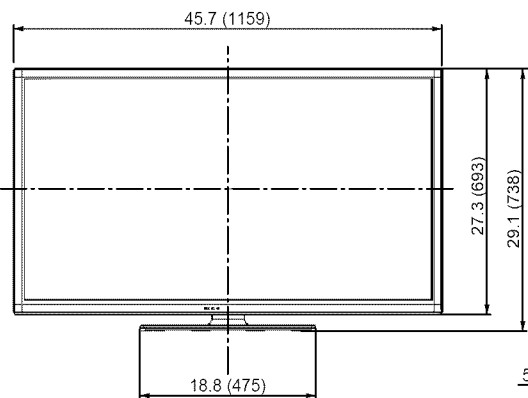

Side View

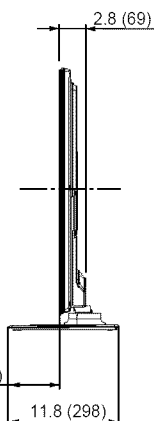

Back View

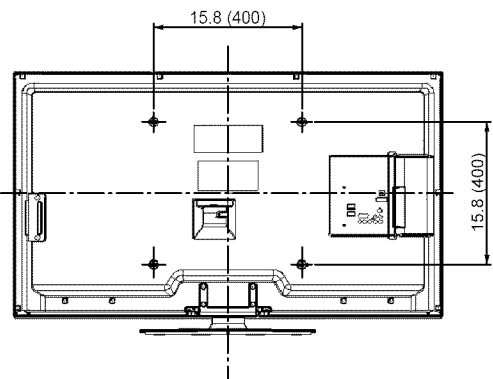

Note:
To make sure that the LCD TV fits the cabinet properly when a high degree of precision is required, we recommend that you use the LCD TV itself to make the necessary cabinet measurements. Panasonic cannot be responsible for inaccuracies in cabinet design or manufacture.

JACKS

Rear Panel

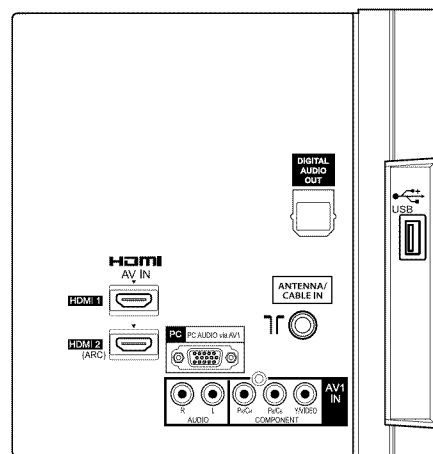

Specifications are subject to change without notice.
Non-metric weights and measurements are approximate.