

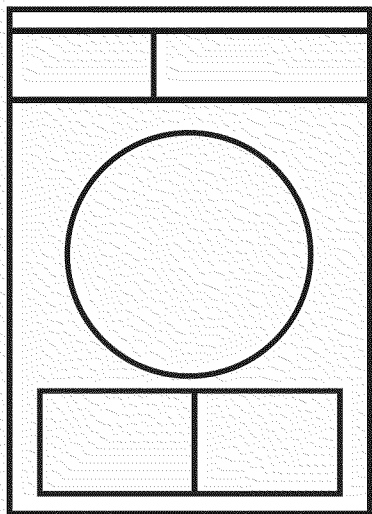

Dryer
WTE86300US



Household Appliances

en Operating, Care and
Installation Instructions

BOSCH

Table of Contents

Definitions	3
IMPORTANT SAFETY INSTRUCTIONS	4
GROUNDING INSTRUCTIONS	5
INSTALLATION INSTRUCTIONS	6
Introduction	6
Information concerning waste disposal	6
Before installing the dryer	6
Electrical connection	8
Integrated socket	10
Condensate hose connection	10
Installation – step by step	11
Built under Installation	11
Check list before using the dryer	11
Preparing to transport the dryer – step by step	11
OPERATING INSTRUCTIONS	12
Your new dryer	12
Panel	13
Safety information	14
Before switching on the dryer	14
Using the dryer	14
Protecting the dryer	14
Protection of the environment	14
Before using the dryer for the first time	14
Temporary disconnection of the dryer	15
Laundry	15
Identification of fabrics	15
Drying tips	15
Program selection	16
Automatic programs	16
Special programs	16
Time programs	16
Options	16
Indicator of program sequence	17
Operation	18
Using the dryer	18
Cleaning and care	19
Cleaning the dryer	19
Cleaning the lint filter	19
Cleaning the air cooler	19
Cleaning the moisture sensor	20
Cleaning the bearing shield	20
Change the light bulb	20
Troubleshooting	21
SERVICE and REPAIR	22
STATEMENT OF LIMITED PRODUCT WARRANTY	23
Warranty Exclusions	25
Program selection table	26
Summary of instructions	27

Congratulations on having selected a Bosch clothes dryer, the choice of those that demand exceptional performance from their clothes dryer.

This dryer complies with UL 2158 A Electric Clothes Dryers.

A distinctive feature of your dryer is low energy consumption.

An easy operation philosophy, a variety of customized drying programs and a solid touch and feel make this appliance a user-friendly assistant in your household.

The Bosch dryer offers the following standard features:

- High efficiency precision drying system
- Exceptionally quiet operation
- Sensor controlled auto cycles
- Timed cycles for 20 and 40 minutes
- Short program for ½ load (25 minutes)

Each dryer which leaves our factory has undergone a thorough performance test and is in full working condition. If you have any questions especially concerning installation of the dryer – our customer service team will be happy to advise you.

Further information and a selection of our products can be found on our web site:
www.boschappliances.com

Information

Please read and follow these operating and installation instructions and all other information enclosed with the dryer.

Definitions

WARNING

WARNING – This indicates that death or serious injuries may occur as a result of not observing this warning.

CAUTION

CAUTION – This indicates that injuries or significant damage may occur as a result not observing this warning.

CAUTION

CAUTION – This indicates that minor injuries or damage may occur as a result of not observing this warning.

 This symbol is used to draw the user's attention to something in particular.

IMPORTANT SAFETY INSTRUCTIONS

WARNING

To reduce the risk of fire, electric shock, serious injury or death to persons and /or damage when using your dryer, follow basic precautions, including the following.

1. Read all instructions before using the dryer. Bosch dryers are provided with Operating, Care and Installation Instructions.
2. Do not dry articles that have been previously cleaned, washed, soaked, or spotted with gasoline, dry cleaning solvents, other flammable, or explosive substances as they give off vapors that could ignite or explode.
3. Do not allow children to play on or in the appliance at any time; severe **injury** or **death** could result. Children should be kept a safe distance away from appliances at all times. Children should only be permitted within an appliance's vicinity if under close, constant adult supervision.
4. When children become old enough to operate the appliance, it is the legal responsibility of the parents or legal guardians to ensure that they are instructed in safe practices by qualified persons.
5. Before the appliance is removed from service or discarded, remove the door to the drying compartment.
6. Do not reach into the appliance if the drum is rotating.
7. Do not install or store this appliance where it will be exposed to the weather.
8. Do not tamper with the controls.
9. Do not repair or replace any part of the appliance or attempt any service unless specifically recommended in the user-maintenance instructions or in published user repair instructions that you understand and have the skills to carry out.
10. Do not use fabric softeners or products to eliminate static unless recommended by the fabric manufacturer.
11. Do not use heat to dry articles containing foam rubber (may be labeled latex foam) or similarly textured rubber-like materials. Foam rubber materials can ignite by spontaneous combustion.
12. Clean lint screen before or after each load.
13. The interior of the machine should be cleaned periodically by qualified service personnel.
14. Always be sure to unplug the dryer from the electrical supply before attempting any service. Disconnect the power cord by grasping the plug, not the cord.
15. Store all laundry chemicals and aids in a cool dry place according to the manufacturer's instructions in an area where children cannot reach them.
16. To reduce the risk of fire, clothes, cleaning rags, mop heads and the like which have traces of any flammable substance, such as vegetable oil, cooking oil, petroleum based oils or distillates, waxes, fats, etc., must not be placed in the dryer. These items may contain some flammable substance(s) even after washing, which may smoke or catch fire by itself.
17. Do not place items exposed to cooking oils in your dryer. Items contaminated with cooking oils may contribute to a chemical reaction that could cause a load to catch fire.
18. Do not sit on top of the dryer.
19. To reduce the risk of fire or electrical shock, DO NOT use an extension cord or an adapter to connect the dryer to the electrical power supply.
20. The dryer must only be used for its intended purpose.
21. Use the integrated socket only for listed appliances.
22. Always check pockets and remove any objects. Cigarette lighters are particularly hazardous.
23. Replace worn out power cords and/or loose plugs.
24. Do not operate the dryer if any guards and/or panels have been removed.
25. Do not operate the dryer if any parts are missing or broken.
26. Do not bypass any safety devices.
27. Do not use a plastic or non-metal flexible duct with this dryer. Plastic or non-metal flexible duct are a potential fire hazard.

28. Do not operate this dryer until you are sure that the dryer has been installed according to the INSTALLATION INSTRUCTIONS and that installation and grounding are in compliance with all local regulations and/or other applicable regulations and requirements.
29. Failure to install, maintain and/or operate the dryer according to the manufacturer's instructions may result in injury and/or damage.
30. To avoid floor damage and mold growth, do not let spills or splashout cause standing water around or under the appliance.

Notes:

- A The IMPORTANT SAFEGUARDS and WARNINGS presented in this manual do not cover all possible conditions that may occur. Common sense, caution and care must be exercised when installing, maintaining or operating the dryer.
- B Always contact your dealer, distributor, service agent or the manufacturer about any problems or conditions that you do not understand.
- C Follow also the Safety Information in the INSTALLATION INSTRUCTIONS and the OPERATING INSTRUCTIONS.

GROUNDING INSTRUCTIONS

This appliance must be grounded. In the event of malfunction or breakdown, grounding will reduce the risk of electric shock by providing a path of least resistance for the electric current.

This appliance is equipped with a cord having an equipment-grounding conductor and a grounding plug. The plug must be plugged into an appropriate outlet that is properly installed and grounded in accordance with all local codes and ordinances.

WARNING

Improper connection of the equipment grounding conductor can result in a risk of electric shock.

Check with a qualified electrician or service person if you are in doubt as to whether the dryer is properly grounded.

DO NOT modify the plug provided with the appliance. If it does not fit the outlet, have a proper outlet installed by a qualified electrician.

KEEP THESE INSTRUCTIONS FOR FUTURE REFERENCE.

In case of change of ownership, manual should be conveyed with the dryer.

SAVE THESE INSTRUCTIONS

INSTALLATION INSTRUCTIONS

Introduction

Read these installation instructions completely and carefully. They will save you time and effort and help to ensure optimum dryer performance. Be sure to observe all listed warnings and cautions.

WARNING

WARNING – Risk of Fire.

- Clothes dryer installation must be performed by a qualified installer.
- Install the clothes dryer according to the manufacturer's instructions and local codes.
- Do not install a clothes dryer with flexible plastic venting materials. If flexible metal (foil type) duct is installed, it must be of a specific type identified by the appliance manufacturer as suitable for clothes dryers. Flexible venting materials are known to collapse, be easily crushed and trap lint. These conditions will obstruct clothes dryer airflow and increase the risk of fire.
- To reduce the risk of severe injury or death, follow all installation instructions.
- **SAVE THESE INSTRUCTIONS**

In addition to these instructions the dryer must be installed in accordance with all local codes or, in the absence of a local code:

- In the **U.S.A.**, in accordance with the National Electric Code, ANSI/NFPA70 – latest edition/State and Municipal codes and/or local codes.
- In **Canada**, in accordance with the Canadian Electric Code C22.1 – latest edition/Provincial and Municipal codes and/or local codes.

Information concerning waste disposal

Disposal of the packaging

WARNING

Keep children away from shipping carton and packaging components. Danger of suffocation from plastic foil and folding cartons.

All packaging materials are environmentally friendly and can be reused. Please dispose of packaging in an environmentally friendly manner. Please ask your dealer or inquire at your local authority about the current means of disposal.

Disposal of the old appliance

WARNING

If appliance is no longer usable, pull out main plug, cut off power cord and discard with main plug.

To prevent children from locking themselves in the appliance, remove the door. Old appliances are not worthless rubbish! Valuable raw materials can be reclaimed from environmentally friendly recycling. Please ask your dealer or inquire at your local authority about the current means of disposal.

Before installing the dryer

Unpacking the appliance

CAUTION

The dryer is very heavy. Do not lift it by yourself. Do not lift the appliance by projecting components (e.g. door) – due to risk of breakage.

CAUTION

Remove the appliance packaging carefully to prevent damage to the surfaces.

Check the dryer for transportation damage. Do not connect a dryer which is visibly damaged. If in doubt, contact your dealer.

Supplied components

The dryer is delivered as a complete unit. The operating instructions and supplied accessories can be found in the drum.

CAUTION

After removing the packaging, immediately remove any objects from the drum.

Installation location

⚠ CAUTION ⚠

Do not install the dryer:

- outdoors
- in an environment with dripping water,
- near flammable materials,
- in rooms which are at risk of frost,
- in rooms which may contain gas or other fuels,
- in cupboards with lockable doors or in closets.

it is not allowed to install the dryer in a small room with door.

The installation room must be well ventilated, otherwise the dryer will operate below optimum performance.

Do not operate the dryer at temperatures above 104°F (40°C) and below 41°F (5°C). Low temperatures affect the automatic program sequence and may prolong the drying times.

The installation surface for the dryer must be clean, level and firm. Do not install the appliance on carpets! Compensate for uneven floors with the height-adjustable feet.

Install the dryer and level side to side and front to back. Use a bubble level. Never remove the height-adjustable feet!

The size of the installation area depends on the dimensions of the dryer. Ensure that there is adequate room for the swivel range of the door!

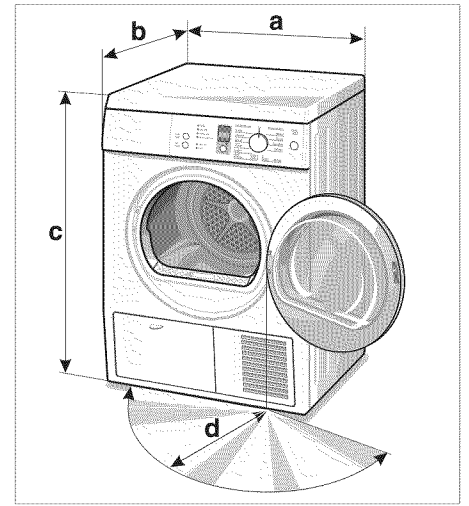

	Dimension	Weight
a	23.6" (600 mm)	92.4 lbs (42 kg)
b	23.0...24.2" (585...615 mm)	with packaging
c	33.1... 34.2" (840...868 mm)	96.8 lbs (44 kg)
d	17.7" (450 mm)/ angle	170-180°

Clearances Required

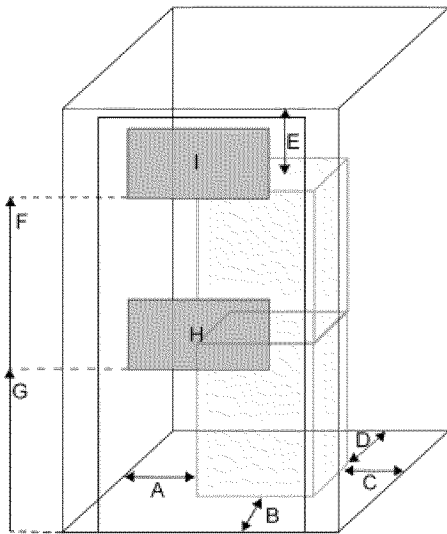

Stacked Washer and Dryer

A	Sides	0.295 in.	7.5 mm
B	Front	1.02 in.	26 mm
C	Sides	0.295 in.	7.5 mm
D	Rear	3.54 in.	90 mm
E	Top	6.10 in.	155 mm

F		68.7 in.	174.5 cm
G		37 in.	94 cm
H		3.937 in. x	10 x cm
		17,519 in.	44.5 cm
		68.975 sq. in	445 sq. cm
I		3.937 in. x	10 x cm
		17,519 in.	44.5 cm
		68.975 sq. in	445 sq. cm

Electrical connection

⚠ CAUTION ⚠

Power cord must be connected by a qualified person only.

Connect to individual Branch Circuit.

Do not use an adapter.

Do not use an extension cord.

Do not remove ground prong.

For CANADA

Your dryer comes with a power supply cord, CSA listed in Canada.

The Bosch dryer requires a 4-wire receptacle.

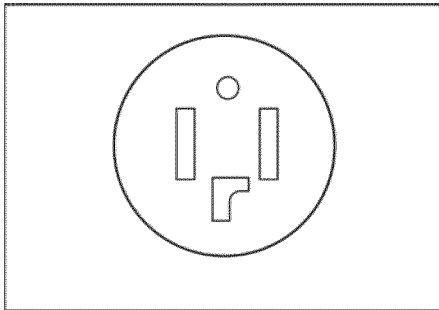

When installing the receptacle for the dryer cord, ensure that the power supply cord is accessible when the dryer is in the installed position.

The power cord should only be replaced by a qualified person. Use a 4-wire power supply cord (see electrical connection U.S.A. below).

For U.S.A.

Your dryer comes without a 3- or 4-wire power supply cord. The power cord kit must meet the following requirements:

- UL listed in the USA
- 208 – 240 volt rated (minimum)
- 30 amps
- Type SRDT or DRT (UL 2158 A)
- Five feet long (minimum)
- Marked suitable for dryer

⚠ CAUTION ⚠

Power cord must be connected by a licensed electrician only.

Use only a U.L. approved 30 amp power cord with strain relief clamp – note manufacturer's instructions.

Do not plug end of power cord into a live receptacle before connecting power cord to appliance terminals and closing junction/splitter box as described below.

Do not reuse old power cord. Cord must have closed loop or upturned end wire terminating connectors.

Do not make a sharp bend or crimp wiring/conductor at connections.

Only a 4-conductor cord shall be used when the appliance is installed in a mobile home, in a recreational vehicle, in a new branch circuit installation or an area where the local codes do not permit grounding through the neutral.

The splitting box is located at the top rear of the appliance.

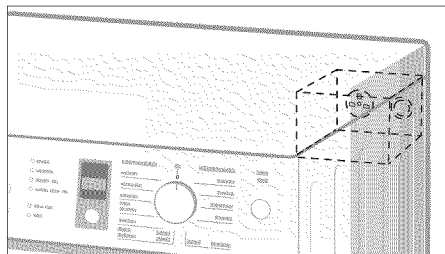

To connect the power cord you have to remove the cover plate.

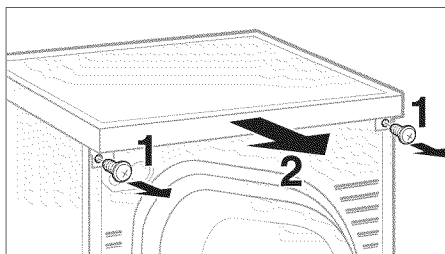

1. Remove the screws of the cover plate on the rear side of the appliance.

2. Push the cover plate from the front to the rear side and lift up.
3. Open the splitting box in the right corner (20 Torx).
4. Loosen the strain relief in the appliance.
5. Thread the power cord through the U.L. strain relief clamp.
6. Tighten the screws (2.5 Nm) of the U.L. strain relief clamp so that the power cord cannot be moved.
7. Connect the power cord as described below.
8. After connecting the power cord close the splitting box and replace the cover plate fasten in place with reverse handling.

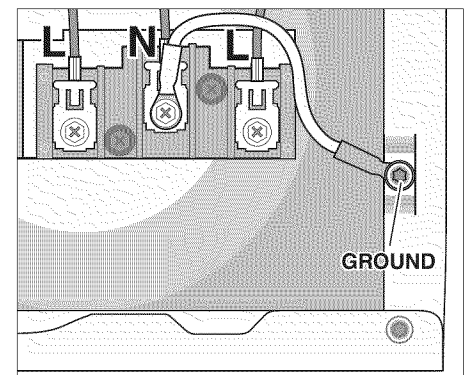

Dryer supplied to customer

Connecting 4-wire power supply cord

1. Remove the screws from the cover of the terminal block.
2. Remove the screws from the grounding cable.
3. Remove the grounding cable.
4. Loosen the 2 screws labeled **L** in the terminal block.
5. Attach the power cord ground conductor (green) to the **GROUND** point. Tighten the screw (2.5 Nm) so that the ground conductor is held securely in place.
6. Attach the 2 power cord outer conductors (red and black) to the 2 terminals labeled **L** and the remaining power cord conductor (white) to the terminal labeled **N**.

7. Tighten all 3 screws (3 Nm) so that the power conductors are held securely in place .
8. Check the U.L. strain relief clamp to make sure that it is tight and cannot be turned.
9. Replace the cover on the terminal block and fasten in place.

i Make sure that the U.L. strain relief clamp is outside the cover!

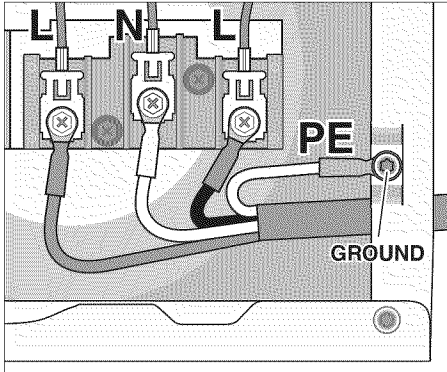

The appliance is now ready to be plugged into the 4-wire receptacle of the power rating.

Connecting 3-wire power supply cord

1. Remove the screws from the cover of the terminal block located at the top rear of the appliance.
2. Make sure that there is a grounding cable.
3. Loosen the 2 screws labeled **L** and the screw labeled **N** in the terminal block.
4. Attach the 2 power cord outer conductors (red and black) to the 2 terminals labeled **L** and the remaining power cord conductor (white) to the terminal labeled **N**.
5. Tighten all 3 screws (3 Nm) so that the power conductors are held in place securely.
6. Check the U.L. strain relief clamp to make sure that it is tight and cannot be turned.
7. Replace the cover on the terminal block and fasten in place.

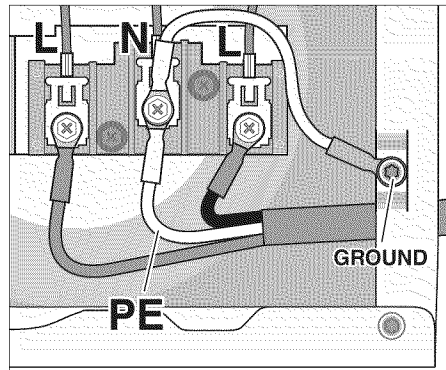

i Make sure that the U.L. strain relief clamp is outside the cover!

Additional grounding procedure

- Some local regulations may require a separate ground. In such cases, the required accessory ground wire, clamp and screw must be purchased separately.
- Never ground the dryer to plastic plumbing lines, gas lines or water pipes.

Grounding instruction

This appliance must be grounded. In the event of a malfunction or breakdown, grounding will reduce the risk of electric shock by providing a path of least resistance for the electric current. For Canada the dryer comes with a cord which has an equipment grounding conductor and a grounding plug. The plug must be plugged into an appropriate outlet which has been properly installed and grounded in accordance with all local regulations and ordinances.

⚠ CAUTION ⚠

Improper connection of the equipment grounding conductor may result in electric shock. Have the appliance checked by a qualified electrician or service technician if you are in doubt as to whether the dryer has been properly grounded.

Integrated socket

This appliance is equipped with a socket for connecting a washer without fuses. Only the listed washer may be connected. For all other connections Bosch will assume no liability.

CAUTION

Use copper conductors only.

Connect to a 30 A minimum individual branch circuit, fused at 30 A maximum.

Use receptable only for:

208 – 240 VAC 60 Hz 11 A

washer: WFR2460UC,

WFL2060UC, WAE20060UC,

WAS20160UC, WAS24460UC.

Condensate hose connection

The dryer must have its condensate drain line installed and run to a suitable drain.

The connection for the condensate hose is located on the back of the dryer. Connect the condensate drain hose to the dryer. The other end should then be placed and secured at nearby sink or drain. If installed with a washer it may, room permitting, be installed next to the washer drain hose and drained to the same drain used by the washer.

Be sure to follow all local codes and regulations in running the condensate to a suitable drain.

Installation – step by step

1. Unpack the dryer.
2. Remove all objects from the drum.
3. Check the dryer for visible damage.
4. Position the dryer near the installation location.
5. Have the power supply cord fitted by an authorized technician (see page 8).
6. Move the dryer to its final location and align.

CAUTION

Do not slide dryer across the floor if height-adjustable feet have been extended. Feet and/or dryer base may be damaged if dryer is slid across floor with height-adjustable feet extended.

7. Position and then level the dryer.

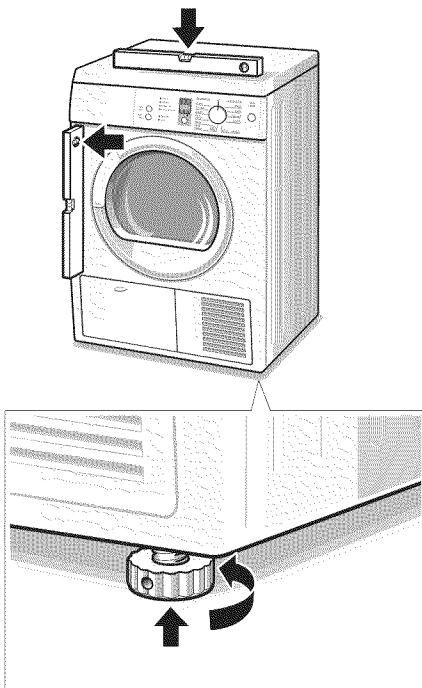

The dryer should be level with all four feet firmly on the ground. The dryer must not wobble.

If the dryer is not level or if it does wobble, the feet must be adjusted. Adjust the height-adjustable feet until the dryer does not rock and is level, both front-to-back and side-to-side.

8. Insert plug into the wall receptacle.

Built under Installation

The appliance can be built under; that is, you can install the dryer under-counter in a kitchen cabinet opening. The cabinet opening should be square and have dimensions as shown in the figure.

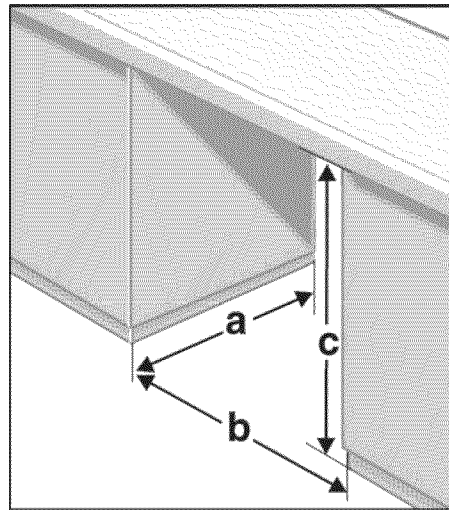

- a 600 mm minimum // 23 5/8"
- b 600 mm minimum // 23 5/8"
- c 850 mm minimum // 33 1/2"

- i** If installed under a countertop, the countertop must be continuous and securely attached to neighboring cabinets.

CAUTION

An opening of at least 31 square inches (200 cm²) must be available at the front and side of the closet.

Check list before using the dryer

1. Check that steps 1-8 have been implemented properly.
2. Ensure that the dryer is connected to the power supply.
3. Read the operating instructions to understand how your dryer operates.
4. Conduct an appliance test:
 - Check that the drum is empty.
 - Close the dryer door.
 - Switch the dryer to “Extra Dry” and then press the Start button.
 - After 3-5 minutes press the Stop button and open the door.
5. If the interior of the dryer feels warm, the dryer has been connected properly. Switch the dryer to “OFF”.
6. If the dryer does not work, switch the dryer to “OFF”. Look in the troubleshooting section (page 21) of the OPERATING INSTRUCTIONS and find the fault.

Preparing to transport the dryer – step by step

1. Rotate the program selector to “OFF”.
2. Pull out power supply plug.
3. Place any accessories in the drum.
4. Close the door and secure with adhesive tape.
5. Screw the height-adjustable feet of the dryer into the housing to prevent them from being damaged during transportation.

OPERATING INSTRUCTIONS

Your new dryer

Open the door...

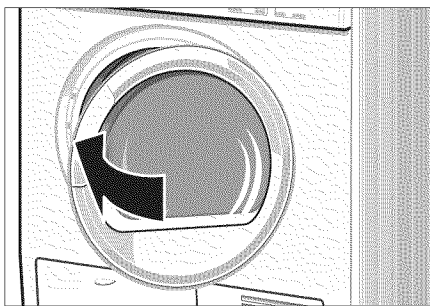
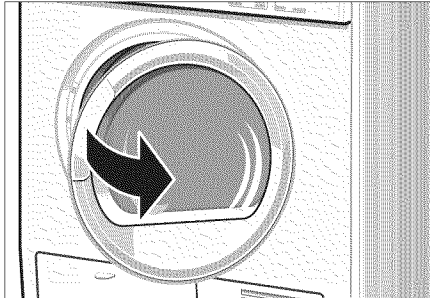

....and close the door.

Lint filter

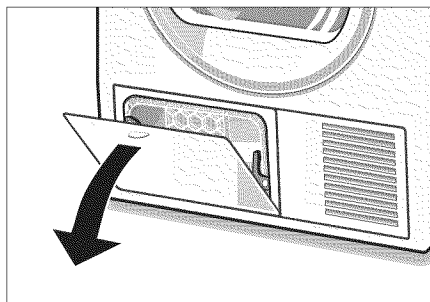
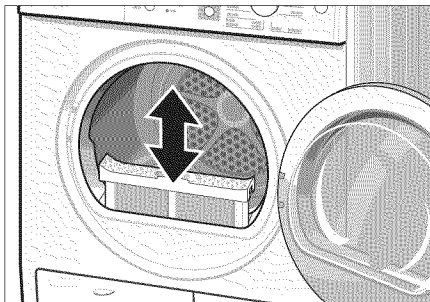

Open the maintenance flap...

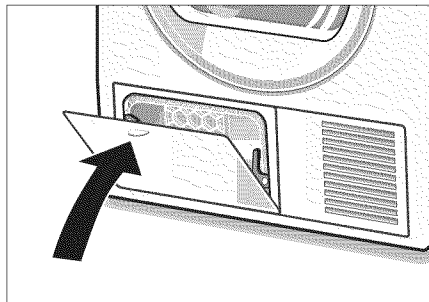

...and close the maintenance flap.

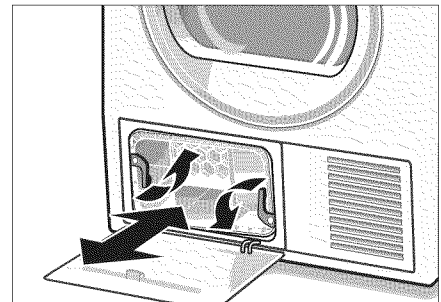

Air cooler

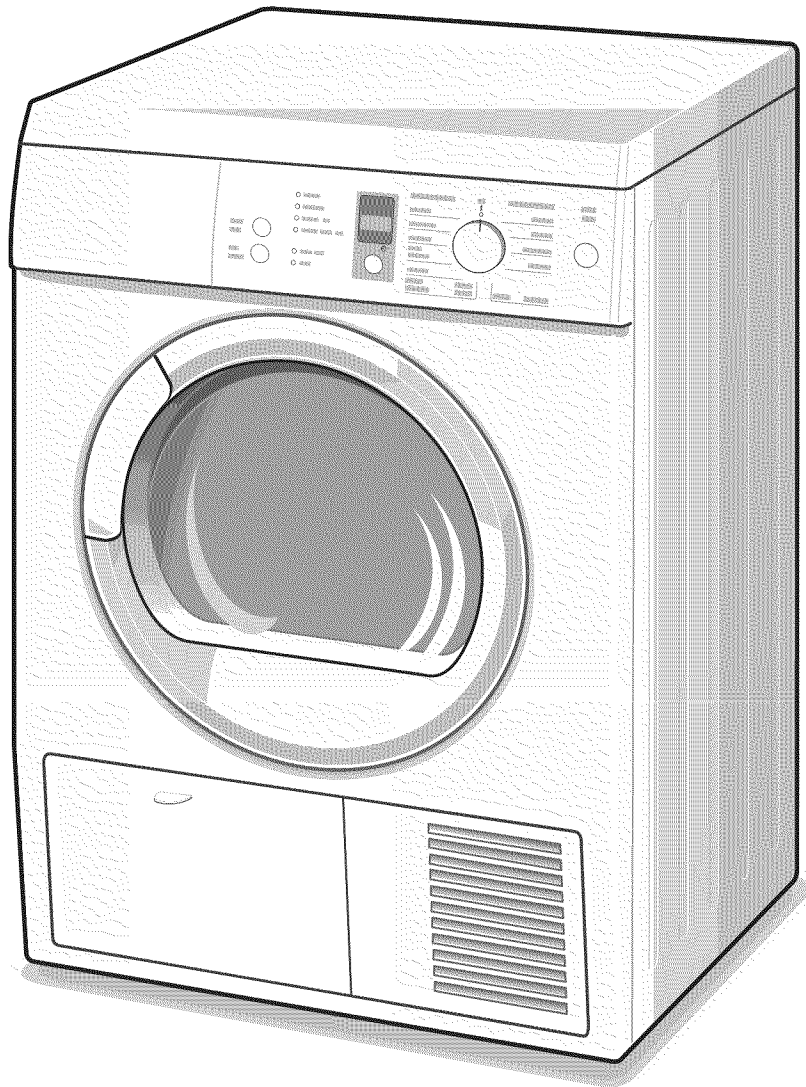

Panel

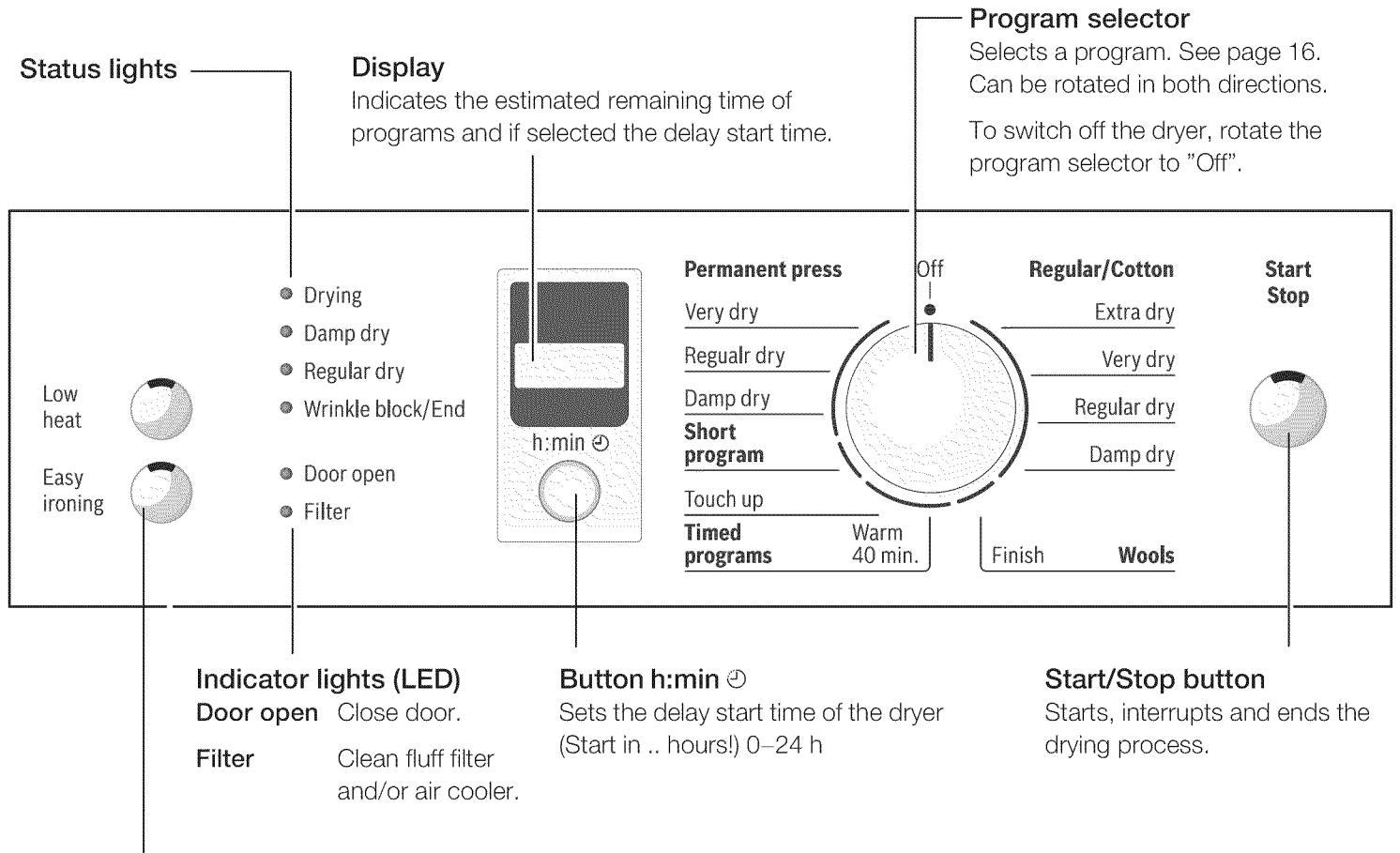

Buttons for additional options

Low heat

Reduced temperature, the drying time is extended correspondingly; for sensitive textiles ☐, e.g. polyacrylic, polyamide, elastane, acetate

Easy ironing

Reduces creasing and extends anti-crease phase when programme ends to 2 hours (standard 1 hour).

Safety information

⚠ WARNING! ⚠

To reduce the risk of fire, electric shock or injury to persons always follow the IMPORTANT SAFETY INSTRUCTIONS (see page 4).

⚠ WARNING! ⚠

EXPLOSION HAZARD!

Keep flammable materials and vapors, such as gasoline, away from the dryer.

Do not dry anything that has ever had anything flammable on it (even after washing).

Do not dry anything that has ever had any type of oil on it (including cooking oils).

Items containing foam, rubber or plastic must be dried on a clothes-line or by using an Air fluff cycle.

Do not allow items containing flammable materials, such as lighters, to remain in clothes while drying.

Failure to follow these instructions may result in explosion or fire.

Risk of death or injury!

Use the dryer only in the house and for drying normal amounts of laundry for the household. Use only for drying textiles which were washed with water.

Before switching on the dryer

Install the dryer in accordance with the installation instructions (from page 6).

Do not use a dryer which is visibly damaged. If in doubt, contact your dealer.

Using the dryer

Do not leave children unsupervised near the dryer.

Keep pets away from the dryer.

Before closing the door, check the contents of the drum.

Remove all objects from pockets. Lighters are particularly hazardous.

Risk of explosion!

Switch off the dryer at the end of the program.

Protecting the dryer

Do not climb on the dryer.

Do not lean or sit on the door.

Risk of dryer tipping over!

Do not store or use solvent detergent boosters or stain remover in the vicinity of the dryer.

The dryer could be damaged.

Do not lift the dryer by projecting components.

Risk of breakage!

Risk of injury!

Protection of environment

Tips on saving energy

To save energy, money and time, Bosch recommends the following:

- **Drain the laundry thoroughly!**
Before drying, spin the laundry thoroughly in the washing machine. Use the highest possible spin speed for the type of laundry! Higher spin speeds reduce the drying time and the energy consumption.
- **Use optimum load!**
Use maximum recommended loads. However, do not exceed loads.
- **Clean filter!**
Clean the filter before and after each drying process (see page 19).

- **Ventilate the room!**
During the drying process provide an adequate supply of fresh air.
- **Do not dry unsuitable materials!**
Do not dry rubberized or air-tight items.

Before using the dryer for the first time

Before you use the dryer for the first time:

1. Read these operating instructions carefully.
2. Check that the supply voltage corresponds with the voltage specifications on the rating plate of the dryer, see rear side of the dryer.
3. Remove all objects from the drum.
4. Check the dryer for visible damage. If damages found contact your dealer.
5. Wipe the inside of the drum with a damp cloth.
6. Conduct an appliance test, see page 11.
7. If the dryer does not work, switch the dryer to "Off". Look in the troubleshooting section (page 21) of the operating instructions and find the fault.

Temporary disconnection of the dryer

Operate your dryer only when you are at home. If you intend going on vacation or are not using your dryer for an extended period of time, you should:

1. Turn off the circuit breaker.
2. Pull out the power supply plug if possible.
3. Clean the lint filter.

Laundry

Identification of fabrics

Observe the treatment symbols on the textile labels. They provide valuable information as well as limitations about the drying process.

Do not dry the following textiles in the dryer:

- Air-tight textiles (e.g. rubberized).
- Delicate fabrics (silk, synthetic curtains) .

Drying tips

In principle, the following applies to all drying programs:

- To ensure a uniform drying result, sort the laundry according to fabric type and drying program.
- Fasten zippers, hooks and eyes. Fasten loose belts, apron strings, etc..
- Do not overdry easy-care laundry – risk of wrinkling! Leave laundry to dry in the air.
- Do not iron laundry immediately after drying. Place the laundry in a pile for a short while. Residual moisture will then be distributed uniformly.
- Knitted textiles (e.g. T-shirts, cotton jersey laundry) often shrink when dried for the first time. Do not use the “Very dry/Extra dry” program.

Program selection

For optimum drying results your dryer offers several program groups and additional options.

Select the required drying program from the program table according to the examples (see page 26).

Automatic programs

There are automatic programs for different types of textiles (regular/cotton, permanent press).

Regular/Cotton

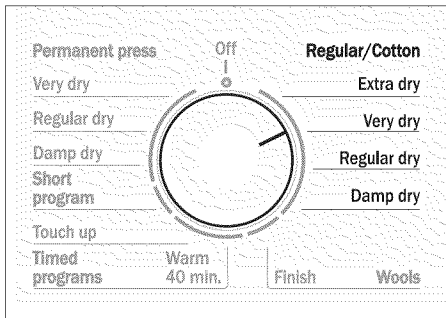

Permanent Press

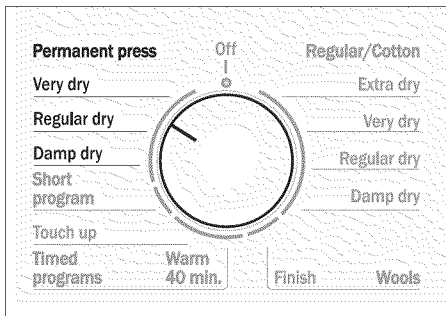

The program sequence of automatic programs is controlled via sensors. The duration of the program depends on the measured degree of moisture in the laundry and on the selected degree of dryness (e.g. damp dry or extra dry).

Special programs

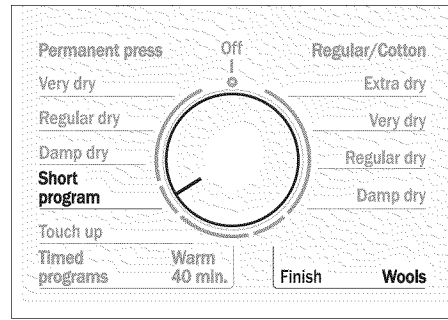

The programs Wools Finish and Short are made for special application cases.

The Wools Finish program is for machine-washable woollen textiles. Textiles are fluffier but not dried. Remove and hang up textiles when the program ends.

The Short program is for washing which is to be dried quickly, e.g. made of synthetic fabrics, cotton or blended fabrics.

Time programs

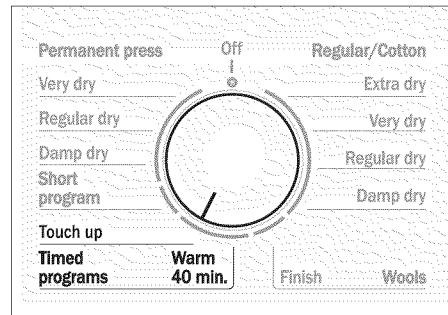

Time programs run at specific temperatures. Suitable for predried, multi-ply, delicate textiles or individual small items. Also for subsequent drying.

- Warm 40 min.
- Touch up (20 min) for extreme temperature sensitive textiles.

Options

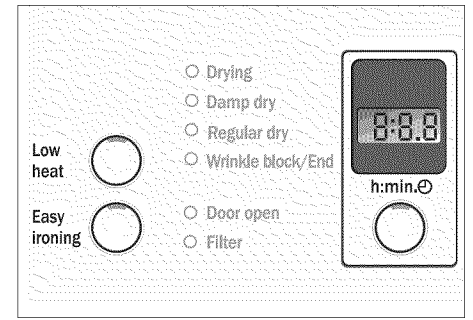

Low heat

Press the "Low heat" button for temperature sensitive textiles. Observe the care information or symbols on the textiles. The temperature of the drying process is reduced, the drying time is extended.

i For extreme temperature sensitive textiles (e.g. camisoles, paints) press the "Low heat" button to reduce the temperature of the drying process.

Easy Ironing

To prevent the laundry from creasing, the dryer drum rotates at specific intervals following the drying program. Standard setting for this function is 1 hour.

If the "Easy ironing" button is pressed, this function is extended to 2 hours.

The laundry remains loose and fluffy until it is removed. The laundry should be removed at the latest after this time has elapsed.

Start Delay

Sets the delay start time of the dryer (Start in .. hours!) 0–24 h (0.5 h steps)

The selected time is displayed.

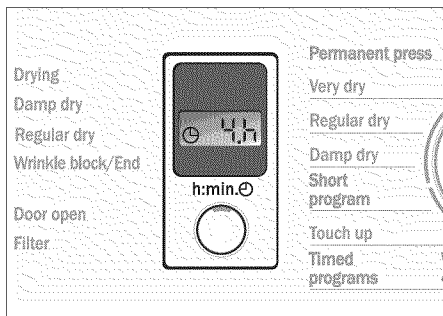

Operation with Start Delay

First select a program and then the start delay by pressing the button. Press the Start/stop button and after the run down of the delay start time the drying program starts.

Indicator of program sequence

The dryer uses an electronic scanning system for all programs except the time programs and the special “Wool Finish” program. A moisture sensor continuously checks the moisture in the laundry. Drying ends automatically as soon as the selected degree of dryness has been reached.

The drum continues to rotate at specific intervals for one hour to prevent creasing.

The current state of the process and the level reached during the program sequence is indicated via indicator lights (drying, damp dry, regular dry, Wrinkle block/End).

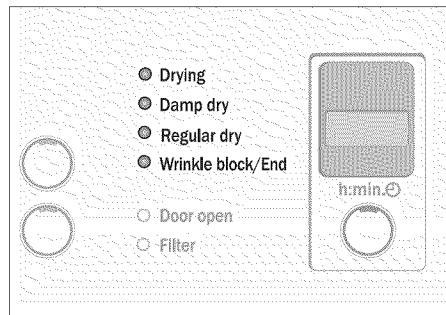

i If the indicator light “Wrinkle block/End” illuminates when the program selector is in Off-Position – turn off the circuit breaker and call for customer service!

Operation

Using the dryer

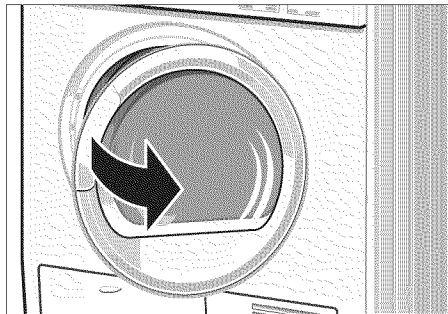

1. Open the door.

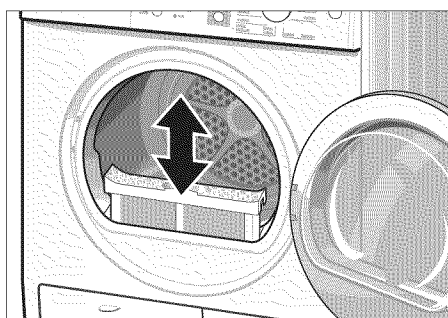

2. Check lint filter.

The filter should be cleaned after and before every drying process. Cleaning the filter reduces the drying time and saves energy.

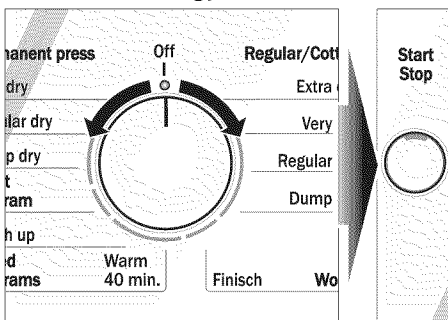

3. Rotate program selector to the desired program.

Select the program which corresponds to the laundry in the dryer from the program selection table (see page 26). The dryer light turns on inside the drum.

The "Start/Stop" indicator light starts flashing.

i The estimated remaining time will be indicated.

i Lint filter indicator flashes for 5 seconds – "Check lint filter"!

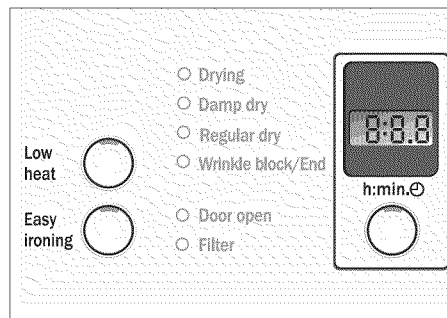

4. If required, select "Low heat" by pressing the button. The "Options" are explained on page 16.

5. If required, select "Easy ironing" by pressing the button. The "Options" are explained on page 16.

i The estimated remaining time will be updated.

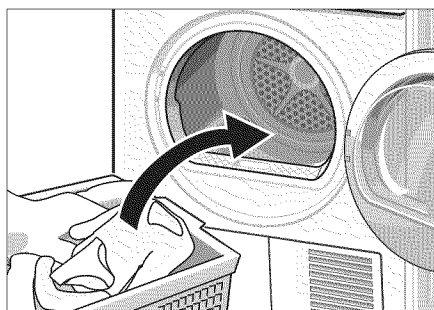

6. Place laundry in the empty drum. Put each piece of laundry into the machine separately. For best results the laundry to be dried must be sorted according to type of laundry and desired degree of drying. For further information see page 16.

i Observe drying symbols of the laundry manufacturer.

Ensure that there is only laundry in the drum. Check that all items are completely in the drum.

7. Close the door.

i If the door has not been closed properly, the dryer will not start.

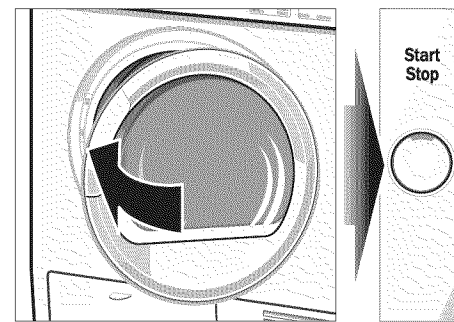

8. Press the "Start/Stop" button. The "Start/Stop" indicator light illuminates.

If an automatic program has been selected, the indicator lights indicate the progress of the program sequence.

i At the end of the program sequence **Damp dry** is emitted (if set).

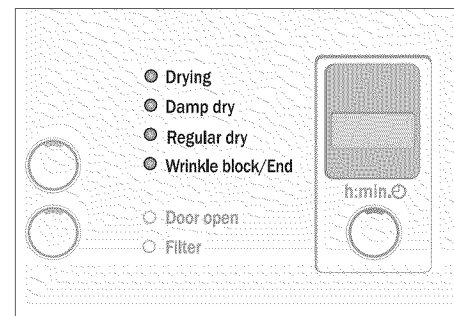

i At program end the LED "Wrinkle block/End" illuminates.

i When the drying process is complete (program or selected time program ended), the drum rotates at specific intervals. This prevents the laundry from creasing (see "Easy ironing", page 16).

9. Open the door.

10. Take the laundry out of the dryer.

11. Rotate the program selector to "Off". The dryer light goes out.

12. Clean the filter. The filter should be cleaned after each drying process. Cleaning the filter reduces the drying time and saves energy.

13. Close the door.

Cleaning and care

Cleaning the dryer

⚠ WARNING! ⚠

RISK OF EXPLOSION!

Never use solvents or highly flammable liquids for cleaning.

CAUTION!

Incorrect cleaning may damage the dryer. Do not spray with a water jet. Do not use scouring agents or all-purpose cleaners. Do not use steam cleaners.

Wipe the housing and fascia with a soft cloth and soapy water only.

Wipe the drum, door seal and inside of the door with a damp cloth only.

Cleaning the lint filter

A dirty filter extends the drying time and increases energy consumption.

The filter should be cleaned before and after each drying process, however at the latest when the "Filter" indicator light illuminates.

If the "Filter" indicator light illuminates during a drying program, clean the filter immediately and check the condensate hose.

i The program interrupts automatically.

1. Switch off the dryer. Program selector to "Off".

CAUTION

The inside of the door heats up during the drying process.

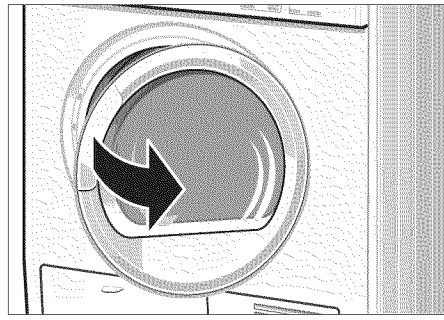

2. Open the door.

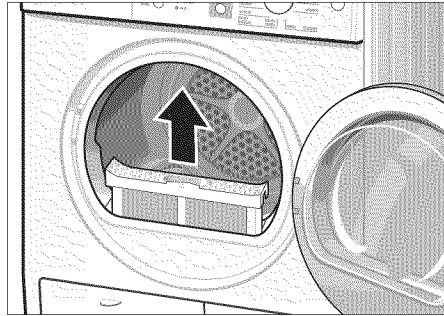

3. Pull out filter...

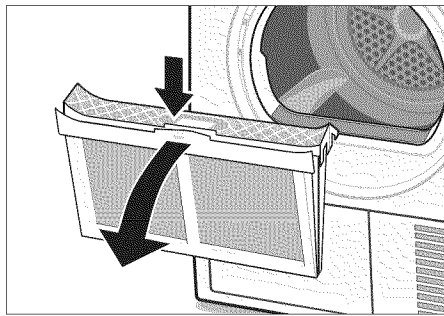

4. ...and open.



5. Remove fluff (run hand over filter).

The filter should be rinsed once a year under warm running water. The filter must be dried thoroughly before being replaced.

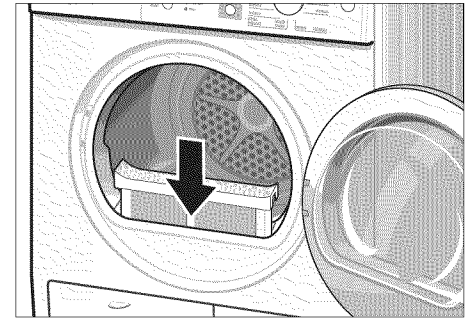

6. Close filter and re-insert.
7. Close the door.

Cleaning the air cooler

3–4 times a year or if o (Filter) flashes continuously after the fluff filter has been cleaned.

1. Leave the dryer to cool down.
2. Residual water may escape, place an absorbent cloth under the maintenance flap.

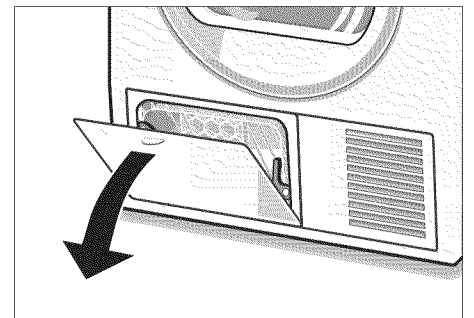

3. Unlock the maintenance flap.
4. Completely open maintenance flap.

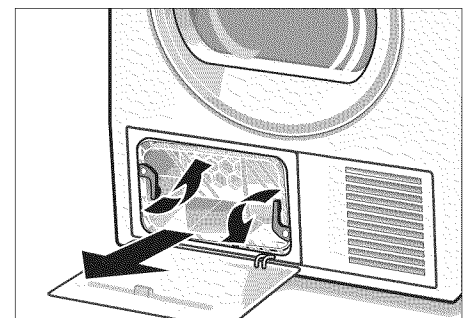

5. Screw both locking levers towards each other.
6. Pull out the air cooler.

- i** Do not damage the air cooler!
Clean with warm water only; do not use hard/sharp-edged objects!

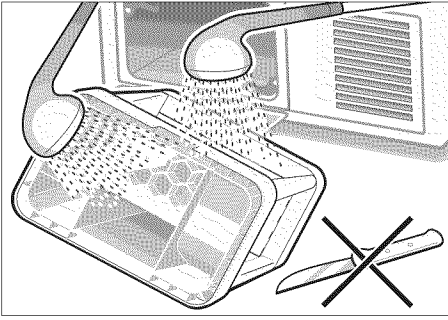

7. Clean the air cooler completely, drain thoroughly.
8. Clean the seals.

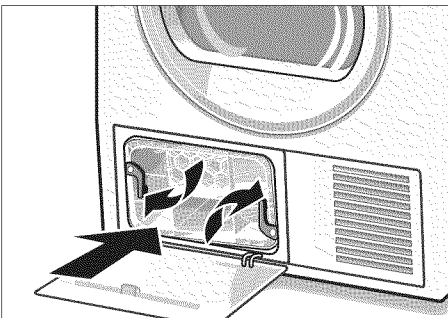

9. Re-insert the air cooler, handle at the bottom!
10. Unscrew both locking levers.

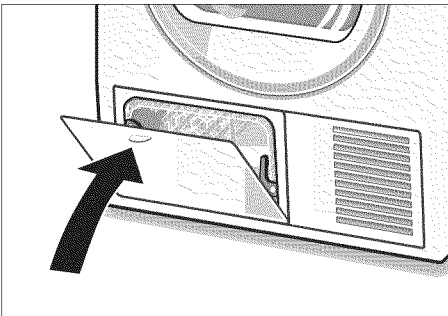

11. Close the maintenance flap until it locks into position.

Cleaning the moisture sensor

Occasionally the moisture sensor has to be cleaned because a fine layer of transparent buildup is deposited on the sensors.

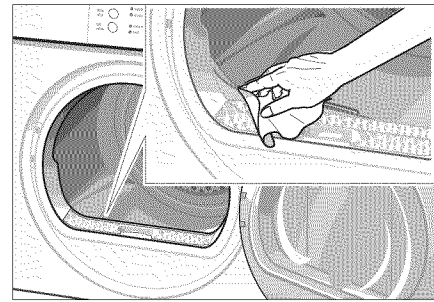
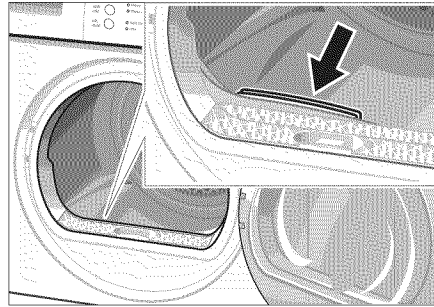

This deposit can easily be removed by wiping the sensors (the two bars next to the lint filter) with a cloth and a little white vinegar. Use white vinegar only!
Clean the moisture sensor once a month.

Cleaning the bearing shield

Over time, fluff from the drying process collects in the bearing shield.

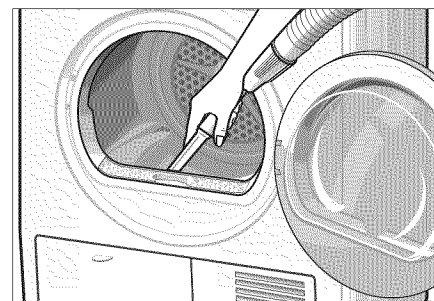

This fluff can be easily removed using your vacuum cleaner, at least once a month.

Changing the light bulb

The dryer light turns on inside the drum when you open the door.

To change the light bulb:

1. Turn off the circuit breaker.
2. Pull out power supply plug.
3. Open the door and locate the light bulb on the upper center of the seal.

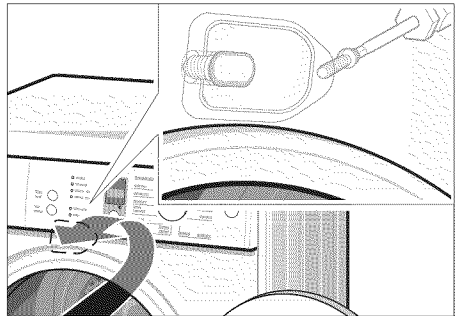
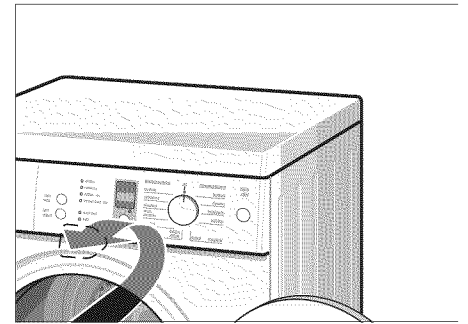

4. Loosen the screw of the cover and open the cover.
5. Turn bulb counterclockwise. Replace the bulb with a new appliance bulb only (obtainable through customer service).
6. Replace the cover and secure with the screw.
7. Plug in dryer or reconnect power supply.

Troubleshooting

WARNING!

**RISK OF ELECTRICAL SHOCK !
EXPLOSION HAZARD!**

Repairs or replacement of parts may be carried out by authorized technicians only.

Before calling the customer service, check whether you can rectify the fault yourself by means of the following table.

If a fault cannot be rectified or a repair is required:

1. Set program selector to "Off".
2. Turn off the circuit breaker.
3. Pull the mains plug out of the socket.
4. Call customer service (see page 22).

Problem	Possible cause	Remedial action
Dryer does not start. "Start/Stop" indicator light does not illuminate.	Main plug not inserted at all or not inserted correctly.	Insert main plug correctly.
	A fuse of power supply has tripped.	Replace/switch on fuse.
	"Start/Stop" button not pressed.	Press "Start/Stop" button.
	Door not closed.	Close door.
	Ambient temperature below 41 °F/5 °C.	Increase room temperature.
Program has been interrupted. "Filter" indicator light illuminates, a warning signal is emitted and the display shows "F:01" or "F:02".	Lint filter dirty.	Clean filter as described on page 19. Switch off/switch on again.
	Fault in program sequence or malfunction.	Switch off dryer, leave to cool down for 30 min, switch on again. Restart program.
	The room/cabinet is not adequately ventilated.	Provide an adequate supply of fresh air. Switch off/switch on again.
Drum light does not function.	No program selected.	Select program.
	Lightbulb defective, lightbulb burned out.	Change light bulb, see page 20.
	No power supply.	Guarantee power supply.
"Start/Stop" indicator light does not illuminate. "Wrinkle block/Finished" indicator lights. The display shows "–0–".	Fault in program sequence or malfunction.	Switch off dryer, leave to cool down for 30 min, switch on again. Restart program.
	Moisture sensor dirty.	Clean moisture sensor as described on page 20. Switch off/switch on again.
"Start/Stop" indicator light flashes and the display shows "F:03".	Condensation outlet.	Check hose for condensation outlet.
Degree of drying has not been reached or the drying time is too long. Display may indicate "F:04".	Laundry was too wet.	Spin laundry at higher speed in the washing machine. Switch off/switch on again.
	Unsuitable program selected.	Select program with aid of the program selection table (see page 26). Switch off/switch on again.
	Maximum drying time was exceeded.	Clean lint filter (see page 19). Check hose for condensation outlet. Spin laundry at a higher speed in your washer.
	Motor limit temperature was exceeded.	Switch off dryer, leave to cool down for 30 min. Switch on again. Start program.

SERVICE and REPAIR

CAUTION

CAUTION – Label all wires prior to disconnection when servicing controls. Wiring errors can cause improper and dangerous operation. Verify proper operation after servicing.

The Bosch dryers require no special care other than the care and cleaning noted above.

i If you are having a problem with your dryer, before calling for service please refer to Table on page 21, following.

If service becomes necessary, contact your dealer or installer or an authorized service center. Do not attempt to repair the appliance yourself. Any work performed by unauthorized personnel may void the warranty.

If you are having a problem with your Bosch dryer and are not pleased with the service you have received:

- First, please contact your installer or the Bosch Authorized Service Contractor in your area and explain to them why you are not satisfied. This will usually correct the problem.
- If after working with your installer or service person the problem still has not been resolved to your satisfaction, please let us know by either writing to us at,

BSH Home Appliances
5551 Mc Fadden Avenue
Huntington Beach, CA 92649

or, calling us at

1-800-944-2904.

Please be sure to include, if writing, or have available, if calling, the following information:

- Model Number
- Serial Number
- Date of Original Purchase
- Date Problem Originated
- Explanation of Problem

Also, if writing, please be sure to include a daytime telephone number and a copy of the sales invoice.

You will find the model number and serial number information on the rating plate.

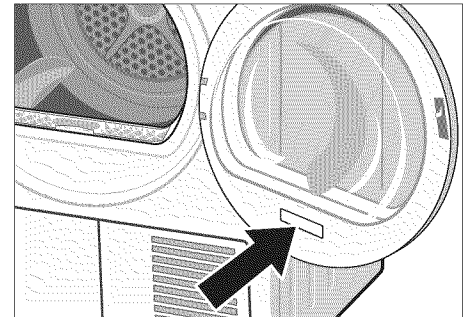

STATEMENT OF LIMITED PRODUCT WARRANTY

Bosch Nexxt® Clothes Dryer

What this Warranty Covers & Who it Applies to: The limited warranty provided by BSH Home Appliances Corporation (Bosch) in this Statement of Limited Product Warranty applies only to the Bosch Nexxt® Clothes Dryer (“Product”) sold to you, the first using purchaser, but strictly conditioned on the Product having been purchased: (1) for your normal, household (non-commercial) use, and has in fact at all times only been used for normal household purposes (any commercial use or setting of the Product *automatically voids the warranty*); (2) new at retail (not a display, “as is”, or previously returned model) purchased directly by the end-user consumer, and not for resale, or commercial use; and (3) within the United States or Canada, and has at all times remained within the country of original purchase. The warranties stated herein apply only to the first purchaser of the Product and are not transferable. The warranty is *automatically void* if the Product was a display model, sold “as is”, tampered with, a damaged or “scratch and dent” model, or a previously returned model, a free give-away, charitable donation or contest prize.

- Please make sure to return your registration card; while not necessary to effectuate warranty coverage, it is the best way for Bosch to notify you in the unlikely event of a safety notice or product recall.

How Long the Warranty Lasts: Bosch warrants that the Product is free from defects in materials and workmanship for a period of three hundred sixty-five days (365) days from the date of purchase. The foregoing timeline begins to run upon the date of purchase, and shall not be stalled, tolled, extended, or suspended, for any reason whatsoever.

Repair/Replace as Your Exclusive Remedy: During this warranty period, Bosch or one of its authorized service providers will repair your Product without charge to you (subject to certain limitations stated herein) if your Product proves to have been manufactured with a defect in materials or workmanship. If reasonable attempts to repair the Product have been made without success, then Bosch will replace your Product (upgraded models may be available to you, in Bosch’s sole discretion, for an additional charge). All removed parts and components shall become the property of Bosch at its sole option. All replaced and/or repaired parts shall assume the identity of the original part for purposes of this warranty and this warranty shall not be extended with respect to such parts. Bosch’s sole liability and responsibility hereunder is to repair manufacturer-defective Product only, using a Bosch-authorized service provider during normal business hours. For safety and property damage concerns, Bosch highly recommends that you do not attempt to repair the Product yourself, or use an un-authorized servicer; Bosch will have no responsibility or liability for repairs or work performed by a non-authorized servicer. If you choose to have someone other than an authorized service provider work on your Product, THIS WARRANTY WILL AUTOMATICALLY BECOME NULL AND VOID. Authorized service providers are those persons or companies that have been specially trained on Bosch products, and who possess, in Bosch’s opinion, a superior reputation for customer service and technical ability (note that they are independent entities and are *not* agents, partners, affiliates or representatives of Bosch). Notwithstanding the foregoing, Bosch will not incur any liability, or have responsibility, for the Product if it is located in a remote area (more than 100 miles from an authorized service provider) or is reasonably inaccessible, hazardous, threatening, or treacherous locale, surroundings, or environment; in any such event, if you request, Bosch would still pay for labor and parts and ship the parts to the nearest authorized service provider, but you would still be fully liable and responsible for any travel time or other special charges by the service company, assuming they agree to make the service call.

Extended Limited Warranty:

LENGTH OF WARRANTY	SCOPE OF WARRANTY
2 Year Limited Warranty From Date of Purchase	Bosch will provide replacement parts, free of charge, for any component part that proves defective under conditions of normal home use during the first two years from the date of purchase, normal (non-expedited) shipping costs included, labor charges excluded.
2 Year Limited Warranty on Electronics From Date of Purchase	Bosch will repair or replace, free of charge, any microprocessor or printed circuit board that proves defective under conditions of normal home use during the first two years from the date of purchase, labor charges excluded.
2 Year Limited Warranty on Motor From Date of Purchase	Bosch will repair or replace, free of charge, any motor or component part of the motor that proves defective under conditions of normal home use during the first two years from the date of purchase, labor charges excluded.

Out of Warranty Product: Bosch is under no obligation, at law or otherwise, to provide you with any concessions, including repairs, pro-rates, or Product replacement, once this warranty has expired.

Warranty Exclusions: The warranty coverage described herein excludes all defects or damage that are not the direct fault of Bosch, including without limitation, one or more of the following: (1) use of the Product in anything other than its normal, customary and intended manner (including without limitation, any form of commercial use, use or storage of an indoor product outdoors, use of the Product in conjunction with air or water-going vessels); (2) any party's willful misconduct, negligence, misuse, abuse, accidents, neglect, improper operation, failure to maintain, improper or negligent installation, tampering, failure to follow operating instructions, mishandling, unauthorized service (including self-performed "fixing" or exploration of the appliance's internal workings); (3) adjustment, alteration or modification of any kind; (4) a failure to comply with any applicable state, local, city, or county electrical, plumbing and/or building codes, regulations, or laws, including failure to install the product in strict conformity with local fire and building codes and regulations; (5) ordinary wear and tear, spills of food, liquid, grease accumulations, or other substances that accumulate on, in, or around the Product; and (6) any external, elemental and/or environmental forces and factors, including without limitation, rain, wind, sand, floods, fires, mud slides, freezing temperatures, excessive moisture or extended exposure to humidity, lightning, power surges, structural failures surrounding the appliance, and acts of God. In no event shall Bosch have any liability or responsibility whatsoever for damage to surrounding property, including cabinetry, floors, ceilings, and other structures or objects around the Product. Also excluded from this warranty are scratches, nicks, minor dents, and cosmetic damages on external surfaces and exposed parts; Products on which the serial numbers have been altered, defaced, or removed; service visits to teach you how to use the Product, or visits where there is nothing wrong with the Product; correction of installation problems (you are solely responsible for any structure and setting for the Product, including all electrical, plumbing or other connecting facilities, for proper foundation/flooring, and for any alterations including without limitation cabinetry, walls, floors, shelving, etc.); and resetting of breakers or fuses. TO THE EXTENT ALLOWED BY LAW, THIS WARRANTY SETS OUT YOUR EXCLUSIVE REMEDIES WITH RESPECT TO PRODUCT, WHETHER THE CLAIM ARISES IN CONTRACT OR TORT (INCLUDING STRICT LIABILITY, OR NEGLIGENCE) OR OTHERWISE. THIS WARRANTY IS IN LIEU OF ALL OTHER WARRANTIES, WHETHER EXPRESS OR IMPLIED. ANY WARRANTY IMPLIED BY LAW, WHETHER FOR MERCHANTABILITY OR FITNESS FOR A PARTICULAR PURPOSE, OR OTHERWISE, SHALL BE EFFECTIVE ONLY FOR THE PERIOD THAT THIS EXPRESS LIMITED WARRANTY IS EFFECTIVE. IN NO EVENT WILL THE MANUFACTURER BE LIABLE FOR CONSEQUENTIAL, SPECIAL, INCIDENTAL, INDIRECT, "BUSINESS LOSS", AND/OR PUNITIVE DAMAGES, LOSSES, OR EXPENSES, INCLUDING WITHOUT LIMITATION TIME AWAY FROM WORK, HOTELS AND/OR RESTAURANT MEALS, REMODELLING EXPENSES IN EXCESS OF DIRECT DAMAGES WHICH ARE DEFINITELY CAUSED EXCLUSIVELY BY Bosch, OR OTHERWISE. SOME STATES DO NOT ALLOW THE EXCLUSION OR LIMITATION OF INCIDENTAL OR CONSEQUENTIAL DAMAGES, AND SOME STATES DO NOT ALLOW LIMITATIONS ON HOW LONG IMPLIED WARRANTY LASTS, SO THE ABOVE LIMITATIONS MAY NOT APPLY TO YOU. THIS WARRANTY GIVES YOU SPECIFIC LEGAL RIGHTS, AND YOU MAY ALSO HAVE OTHER RIGHTS, WHICH VARY FROM STATE TO STATE. No attempt to alter, modify or amend this warranty shall be effective unless authorized in writing by an officer of BSH.

How to Obtain Warranty Service: To obtain warranty service for your Product, you should contact the nearest Bosch authorized service center.

BSH Home Appliances Corporation – 5551 McFadden Avenue, Huntington Beach, CA 92649 / 1-800-944-2904

Program selection table

Automatic programs		
For Cottons and coloreds made of cotton or linen. Press "Low heat" button for temperature-sensitive textiles. Press "Easy ironing" button to prevent the laundry from creasing.		"Regular/Cottons"
	For laundry,	
Bed linen and table linen, towels	which is to be ironed	Damp dry
Bed linen and table linen, towels, T-shirts, sports shirts, overalls		
T-shirts, sports shirts, dresses, trousers, overalls, underwear		
Terry towels, kitchen towels, hand towels, bed linen, underwear, cotton socks	which is not to be ironed	Regular dry
Terry towels, kitchen towels, hand towels, bed linen, underwear, cotton socks	which is not to be ironed, thick multi-ply	Very dry
Terry bathrobes and terry bed linen	which is particularly thick or multi-ply	Extra dry
Easy-care (drip-dry) laundry made of synthetic and blended fabric, cotton e.g. polyester Press the "Low heat" button for very temperature-sensitive textiles.		"Permanent Press"
	For laundry,	
Trousers, dresses, skirts, shirts, blouses, leggings, sports clothing with synthetic-rich fibers, lingerie	which is not to be or only lightly ironed	Damp dry
Shirts, blouses, sports clothing	which is not to be ironed	Regular dry
Bed linen and table linen, track suits, anoraks, blankets	which is not to be ironed, thick multi-ply	Very dry
Specials		
To dry washable woolen textiles (e.g. sweaters, woolen pullover, skirts)		Wools
Small loads, loads that need a short drying time, e.g. sports shirts, work-out clothes (cotton, synthetic)		Short
Timed programs		
Pre-dried textiles with low moisture content, individual small items, e.g. bath towels, bathing suits, dish cloths. For smallest loading condition from 0.22 lb–0.44 lb (i.e. one small towel), for this a time dry program should be selected. Press the "Low heat" button for temperature-sensitive textiles.		Warm 40 min. / Touch up (20 min.)

Summary of instructions

Safety information

⚠ WARNING! ⚠

Always follow the IMPORTANT SAFETY INSTRUCTIONS (see page 4).

⚠ WARNING! ⚠

EXPLOSION HAZARD!

Keep flammable materials and vapors, such as gasoline, away from the dryer.

Do not dry anything that has ever had anything flammable on it (even after washing).

Do not dry anything that has ever had any type of oil on it (including cooking oils).

Items containing foam, rubber or plastic must be dried on a clothes-line or by using an Air fluff cycle.

Do not allow items containing flammable materials, such as lighters, to remain in clothes while drying.

Failure to follow these instructions may result in explosion or fire.

Risk of death or injury!

Use the dryer only in the house and for drying normal amounts of laundry for the household.
Use only for drying textiles which were washed with water.

⚠ CAUTION ⚠

Before using your dryer read and follow all installation and operating instructions.

Preparing the dryer

i Check the lint filter. The filter should be cleaned before and after every drying process.

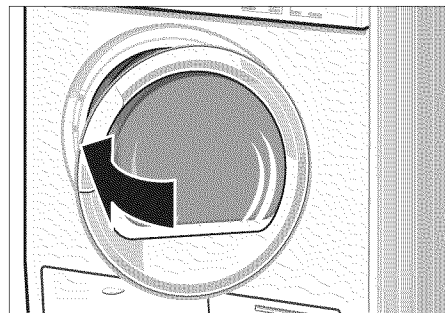
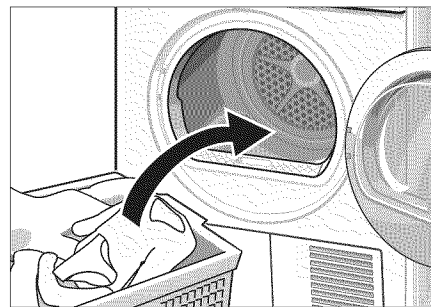
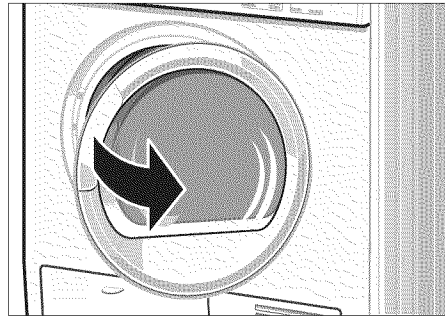

Selecting a program

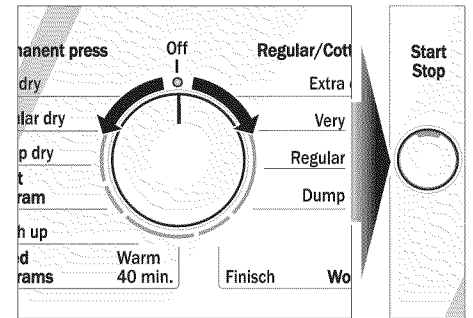

Choose an option...

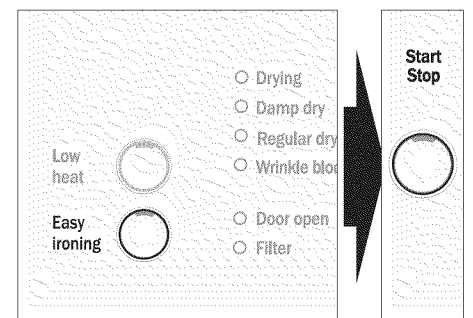

...and start the dryer.

Switch off the dryer

