





UAB

Front Surround System

YAS-101

OWNER'S MANUAL

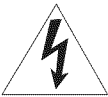
IMPORTANT SAFETY INSTRUCTIONS

	CAUTION RISK OF ELECTRIC SHOCK DO NOT OPEN	
CAUTION: TO REDUCE THE RISK OF ELECTRIC SHOCK, DO NOT REMOVE COVER (OR BACK). NO USER-SERVICEABLE PARTS INSIDE. REFER SERVICING TO QUALIFIED SERVICE PERSONNEL.		

• Explanation of Graphical Symbols



The lightning flash with arrowhead symbol, within an equilateral triangle, is intended to alert you to the presence of uninsulated “dangerous voltage” within the product’s enclosure that may be of sufficient magnitude to constitute a risk of electric shock to persons.

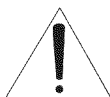

The exclamation point within an equilateral triangle is intended to alert you to the presence of important operating and maintenance (servicing) instructions in the literature accompanying the appliance.

IMPORTANT

Please record the serial number of this unit in the space below.

MODEL:

Serial No.:

The serial number is located on the rear of the unit.

Retain this Owner’s Manual in a safe place for future reference.

- 1 Read these instructions.
- 2 Keep these instructions.
- 3 Heed all warnings.
- 4 Follow all instructions.
- 5 Do not use this apparatus near water.
- 6 Clean only with dry cloth.
- 7 Do not block any ventilation openings. Install in accordance with the manufacturer’s instructions.
- 8 Do not install near any heat sources such as radiators, heat registers, stoves, or other apparatus (including amplifiers) that produce heat.
- 9 Do not defeat the safety purpose of the polarized or grounding-type plug. A polarized plug has two blades with one wider than the other. A grounding type plug has two blades and a third grounding prong. The wide blade or the third prong are provided for your safety. If the provided plug does not fit into your outlet, consult an electrician for replacement of the obsolete outlet.
- 10 Protect the power cord from being walked on or pinched particularly at plugs, convenience receptacles, and the point where they exit from the apparatus.
- 11 Only use attachments/accessories specified by the manufacturer.
- 12 Use only with the cart, stand, tripod, bracket, or table specified by the manufacturer, or sold with the apparatus. When a cart is used, use caution when moving the cart/apparatus combination to avoid injury from tip-over.
- 13 Unplug this apparatus during lightning storms or when unused for long periods of time.
- 14 Refer all servicing to qualified service personnel. Servicing is required when the apparatus has been damaged in any way, such as power-supply cord or plug is damaged, liquid has been spilled or objects have fallen into the apparatus, the apparatus has been exposed to rain or moisture, does not operate normally, or has been dropped.



FOR CANADIAN CUSTOMERS

To prevent electric shock, match wide blade of plug to wide slot and fully insert.

This Class B digital apparatus complies with Canadian ICES-003.

FCC INFORMATION (for US customers)

- IMPORTANT NOTICE: DO NOT MODIFY THIS UNIT!**
This product, when installed as indicated in the instructions contained in this manual, meets FCC requirements. Modifications not expressly approved by Yamaha may void your authority, granted by the FCC, to use the product.
- IMPORTANT:** When connecting this product to accessories and/or another product use only high quality shielded cables. Cable/s supplied with this product **MUST** be used. Follow all installation instructions. Failure to follow instructions could void your FCC authorization to use this product in the USA.
- NOTE:** This product has been tested and found to comply with the requirements listed in FCC Regulations, Part 15 for Class "B" digital devices. Compliance with these requirements provides a reasonable level of assurance that your use of this product in a residential environment will not result in harmful interference with other electronic devices. This equipment generates/uses radio frequencies and, if not installed and used according to the instructions found in the users manual, may cause interference harmful to the operation of other electronic devices.
- Compliance with FCC regulations does not guarantee that interference will not occur in all installations. If this product is found to be the source of interference, which can be determined by turning the unit "OFF" and "ON", please try to eliminate the problem by using one of the following measures:
- Relocate either this product or the device that is being affected by the interference.
- Utilize power outlets that are on different branch (circuit breaker or fuse) circuits or install AC line filter/s.
- In the case of radio or TV interference, relocate/reorient the antenna. If the antenna lead-in is 300 ohm ribbon lead, change the lead-in to coaxial type cable.
- If these corrective measures do not produce satisfactory results, please contact the local retailer authorized to distribute this type of product. If you can not locate the appropriate retailer, please contact Yamaha Electronics Corp., U.S.A. 6660 Orangethorpe Ave., Buena Park, CA 90620.
- The above statements apply **ONLY** to those products distributed by Yamaha Corporation of America or its subsidiaries.

We Want You Listening For A Lifetime



Yamaha and the Electronic Industries Association's Consumer Electronics Group want you to get the most out of your equipment by playing it at a safe level. One that lets the sound come through loud and clear without annoying blaring or distortion – and, most importantly, without affecting your sensitive hearing. Since hearing damage from loud sounds is often undetectable until it is too late, Yamaha and the Electronic Industries Association's Consumer Electronics Group recommend you to avoid prolonged exposure from excessive volume levels.

Caution: Read this before operating your unit.

- To assure the finest performance, please read this manual carefully. Keep it in a safe place for future reference.
- Install this unit in a well ventilated, cool, dry, clean place - away from direct sunlight, heat sources, vibration, dust, moisture, and/or cold. For proper ventilation, allow the following minimum clearances.
Top: 5 cm (2 in)
Rear: 5 cm (2 in)
Sides: 1 cm (3/8 in)
- Locate this unit away from other electrical appliances, motors, or transformers to avoid humming sounds.
- Do not expose this unit to sudden temperature changes from cold to hot, and do not locate this unit in an environment with high humidity (i.e. a room with a humidifier) to prevent condensation inside this unit, which may cause an electrical shock, fire, damage to this unit, and/or personal injury.
- Avoid installing this unit where foreign objects may fall onto this unit and/or this unit may be exposed to liquid dripping or splashing. On the top of this unit, do not place:
 - Other components, as they may cause damage and/or discoloration on the surface of this unit.
 - Burning objects (i.e. candles), as they may cause fire, damage to this unit, and/or personal injury.
 - Containers with liquid in them, as they may fall and liquid may cause electrical shock to the user and/or damage to this unit.
- Do not cover this unit with a newspaper, tablecloth, curtain, etc. in order not to obstruct heat radiation. If the temperature inside this unit rises, it may cause fire, damage to this unit, and/or personal injury.
- Do not plug in this unit to a wall outlet until all connections are complete.
- Do not operate this unit upside-down. It may overheat, possibly causing damage.
- Do not use force on switches, knobs and/or cords.
- When disconnecting the power cable from the wall outlet, grasp the plug; do not pull the cable.
- Do not clean this unit with chemical solvents; this might damage the finish. Use a clean, dry cloth.
- Only voltage specified on this unit must be used. Using this unit with a higher voltage than specified is dangerous and may cause fire, damage to this unit, and/or personal injury. Yamaha will not be held responsible for any damage resulting from use of this unit with a voltage other than specified.
- To prevent damage by lightning, keep the power cable and outdoor antennas disconnected from a wall outlet or the unit during a lightning storm.
- Do not attempt to modify or fix this unit. Contact qualified Yamaha service personnel when any service is needed. The cabinet should never be opened for any reasons.
- When not planning to use this unit for long periods of time (i.e. vacation), disconnect the AC power plug from the wall outlet.
- Be sure to read the "Troubleshooting" section on common operating errors before concluding that this unit is faulty.
- Before moving this unit, press  to set this unit in standby mode, and disconnect the power supply cable from the wall outlet.
- Condensation will form when the surrounding temperature changes suddenly. Disconnect the power supply cable from the outlet, then leave the unit alone.
- Install this unit near the wall outlet and where the AC power plug can be reached easily.
- The batteries shall not be exposed to excessive heat such as sunshine, fire or like.
- Secure placement or installation is the owner's responsibility. Yamaha shall not be liable for any accident caused by improper placement or installation of speakers.

WARNING

TO REDUCE THE RISK OF FIRE OR ELECTRIC SHOCK, DO NOT EXPOSE THIS UNIT TO RAIN OR MOISTURE.

As long as this unit is connected to the AC wall outlet, it is not disconnected from the AC power source even if you turn off this unit by . In this state, this unit is designed to consume a very small quantity of power.

(Power key)

Turns on the power of this unit or sets it to the standby mode.

■ For U.K. customers

If the socket outlets in the home are not suitable for the plug supplied with this appliance, it should be cut off and an appropriate 3 pin plug fitted. For details, refer to the instructions described below.

Note

The plug severed from the mains lead must be destroyed, as a plug with bared flexible cord is hazardous if engaged in a live socket outlet.

■ Special Instructions for U.K. Model

IMPORTANT

THE WIRES IN THE MAINS LEAD ARE COLOURED IN ACCORDANCE WITH THE FOLLOWING CODE:

Blue: NEUTRAL

Brown: LIVE

As the colours of the wires in the mains lead of this apparatus may not correspond with the coloured markings identifying the terminals in your plug, proceed as follows:

The wire which is coloured BLUE must be connected to the terminal which is marked with the letter N or coloured BLACK. The wire which is coloured BROWN must be connected to the terminal which is marked with the letter L or coloured RED.

Making sure that neither core is connected to the earth terminal of the three pin plug.

CONTENTS

Supplied items	2	Enjoying sound with your preference	7
Front panel	2	Additional Information	8
Placing	3	Operation indicators of the unit	11
Connection	4	Troubleshooting	12
Operation	6	Specification	14

What you can do with this unit

- Enjoy high quality surround sound (AIR SURROUND XTREME)..... 7
- Enjoy clear dialogue and narration (Clear voice) 7
- Maintain a consistent volume level between different channels, programs, commercials. (UniVolume) 7
- Operate the unit by the TV's remote control (TV remote control learning)..... 9

About this manual

- In this manual, operations that can be performed using either the front panel buttons or the remote control are explained using the remote control.
-  indicates a tip for your operation. Notes contain important information about safety and operating instructions.
- This manual is produced prior to production. Design and specifications are subject to change in part as a result of improvements, etc. In case of differences between the manual and the product, the product has priority.

Notes on remote controls and batteries

- Do not spill water or other liquids on the remote control.
- Do not drop the remote control.
- Do not leave or store the remote control in the following places:
 - places of high humidity, such as near a bath
 - places of high temperatures, such as near a heater or a stove
 - places of extremely low temperatures
 - dusty places
- Do not expose the remote control sensor of this unit to direct sunlight or lighting such as inverted fluorescent lamps.
- If the batteries grow old, the effective operation range of the remote control decreases considerably. If this happens, replace the batteries with two new ones as soon as possible.
- Do not use old batteries together with new ones.
- Do not use different types of batteries (such as alkaline and manganese batteries) together. Read the packaging carefully as these different types of batteries may have the same shape and color.
- Exhausted batteries may leak. If the batteries have leaked, dispose of them immediately. Avoid touching the leaked material or letting it come into contact with clothing, etc. Clean the battery compartment thoroughly before installing new batteries.
- Do not throw away batteries with general house waste. Dispose of them correctly in accordance with your local regulations.
- Keep batteries away from children. If a battery is accidentally swallowed, contact your doctor immediately.
- When not planning to use the remote control for long periods of time, remove the batteries from the remote control.
- Do not charge or disassemble the supplied batteries.

Supplied items

Before assembly and connecting, make sure you have received all of the following items.



Main unit x 1

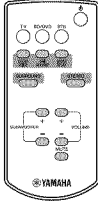

Remote control x 1



Optical cable x 1
(1.5 m (4.9 ft))

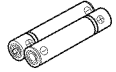

Battery x 2
(AAA, R03, UM4)



Mounting template x 1



Spacer x 2
(for attaching to a wall)

Front panel

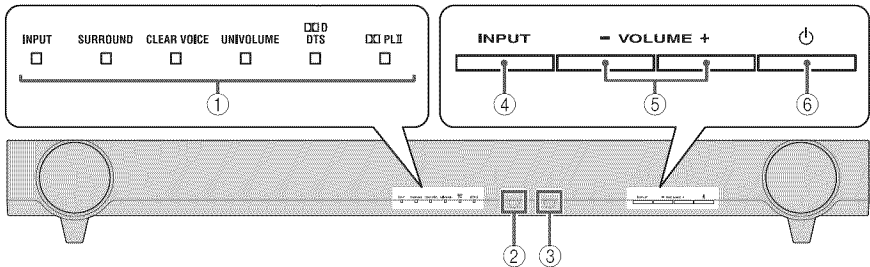

① Indicators

Light up to show the system condition. (☞ P. 11)



The indicators automatically become darker if the unit is left turned on for 5 seconds without any operation being performed. (Auto dimmer function)

② Remote control sensor

Receives infrared signals from the remote control of this unit.

③ TV remote control sensor

Receives infrared signals from the TV remote control.

④ INPUT

Selects an input source you want to listen to. (☞ P. 6)

⑤ VOLUME +/-

Controls the volume of the unit. (☞ P. 8)

⑥ (Power)

Turns on the unit, or sets it to standby mode.

Placing

Installation: illustrated examples

Example 1

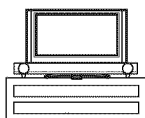

Example 2

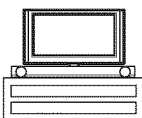

Example 3

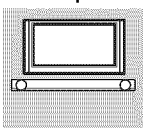

Example 1: Unit beneath TV

Example 2: Unit without stand beneath TV (P. 9)

Example 3: Wall mounting

Notes

- Do not place the unit on/under any other components such as BD player in a pile. The vibration of the unit may cause system failure, etc. in other components.
- Depending on your installation environment, connections to external components such as TV or BD player can be done before installing the unit. We recommend that you temporarily place and arrange all components in order to decide which procedure is best done first.
- When you clean the unit, use a clean, dry and soft cloth (such as cloth for glasses).
- Do not touch the grille on the front and bottom of the unit.
- Place the unit away from your TV more than 50 mm (2") so as not to damage your TV with rear panel of the unit. The brackets on the rear of the unit are removable.

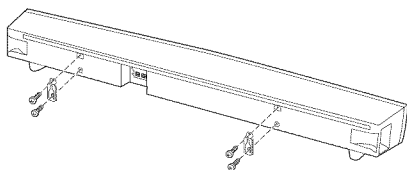

Attaching the unit to a wall

You can attach the unit to a wall using the brackets on the rear of the unit.

When installing the unit on a wall, all installation work must be performed by a qualified contractor or dealer. The customer must never attempt to perform this installation work. Improper or inadequate installation could cause the unit to fall, resulting in personal injury.

- 1 Attach the supplied mounting template on a wall and mark the holes of the mounting template.

Tapes or thumbtacks

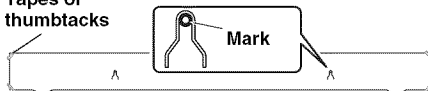

- 2 Remove the mounting template and then install the commercially available screws and the supplied spacers at the marks.

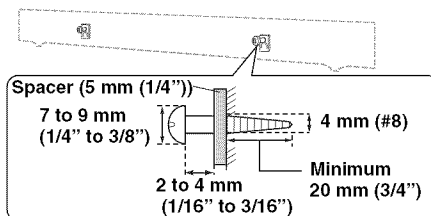

- 3 Hang the unit on the screws using the brackets on the rear of the unit.

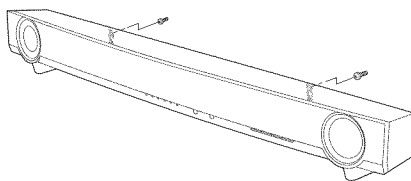

Notes

- Do not attach the unit to a wall that is made of weak materials such as plaster or veneered woods. Doing so may cause the unit to fall.
- Use commercially available screws that can support the weight of the installation.
- Make sure you use specified screws to attach the unit. Using clamps other than specified screws, such as short screws, nails, or two-sided tape, may cause the unit to fall.
- When connecting the unit, fix the cables in place where they will not become loose. If your foot or hand accidentally gets caught on a loose cable, the unit may fall.
- After attaching the unit, check that the unit is fixed securely. Yamaha will bear no responsibility for any accidents caused by improper installations.

Connection

- Do not connect the power cable until all connections are completed.
- Do not use excessive force when inserting the cable plug. Doing so may damage the cable plug and/or terminal.

Connecting a TV

The unit plays the audio output from your TV.

Connect input components such as a BD player, etc., to your TV first and check the components play properly before connecting to the unit. See the manuals of your TV and BD player, etc., for details.

After that, connect the unit to your TV as the illustration below.

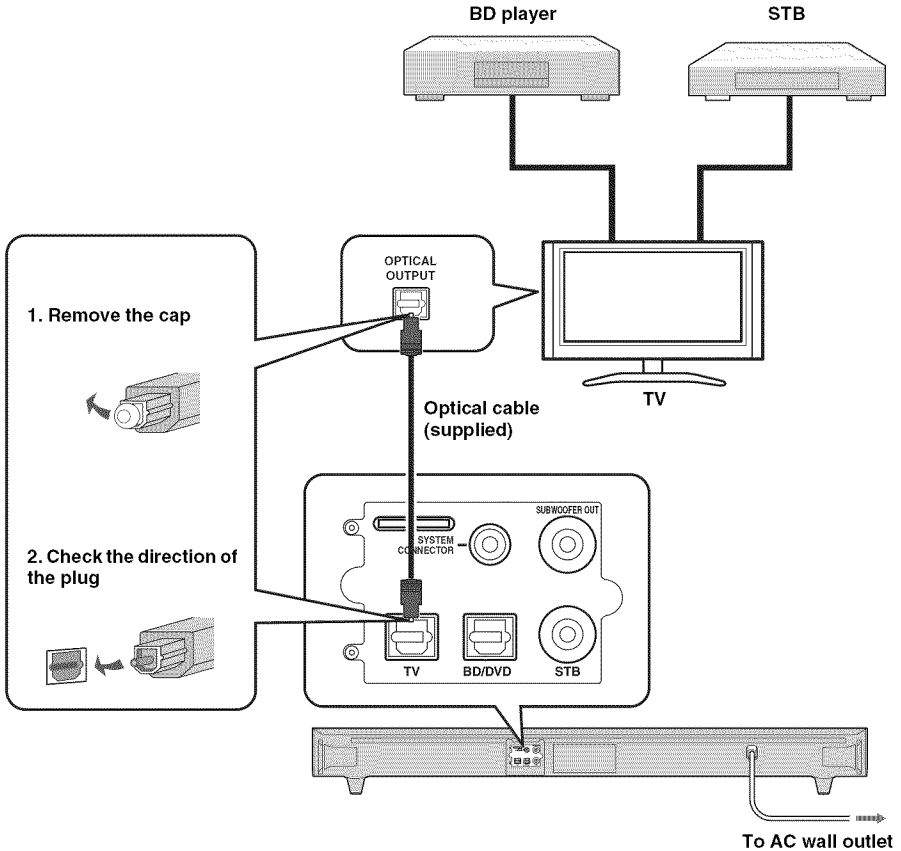

Setting your TV

As connections are completed, set your TV as below before operation.

- Set the volume of the TV to minimum.
- If applicable, set the audio output of your TV's built-in speakers to off.

Alternative connections

Connect the input components (BD player, STB, etc) to the unit directly in the following cases.

- When the unit does not play the sound output from the components connected to your TV (® P. 4).
- When your TV does not have any audio input jacks to connect input components, such as a BD player, etc.

Refer to “Using an external subwoofer” (® P. 8) for details on the use of an external subwoofer and appropriate settings of the unit.

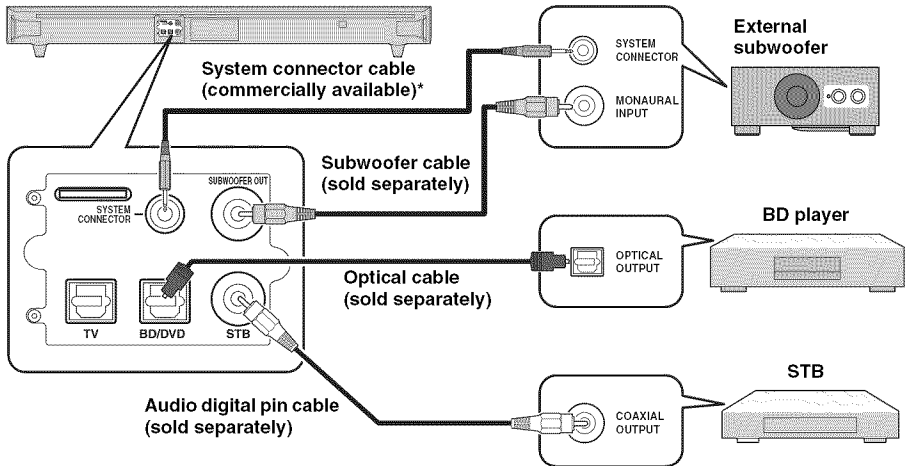

* If connecting an external Yamaha subwoofer, use the cable supplied with the subwoofer to enable synchronous on/off switching of the unit and subwoofer.

Operation

Once you have finished all cable connections and remote control operation, follow the procedure below to start basic playback operation.

Remote control

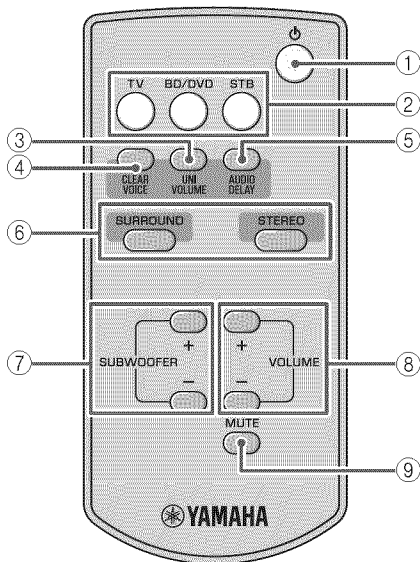

- 1 **⏻ (Power):** Turns on the unit, or sets it to standby mode.
- 2 **Input buttons:** Select the input source you want to listen to.
- 3 **UNIVOLUME:** Turns UniVolume mode on and off. (P. 7)
- 4 **CLEAR VOICE:** Turns Clear voice mode on and off. (P. 7)
- 5 **AUDIO DELAY:** Turns the audio delay adjusting mode on and off. (P. 8)
- 6 **SURROUND/STEREO:** Switch surround/stereo mode. (P. 7)
- 7 **SUBWOOFER +/-:** Adjust the subwoofer volume. (P. 8)
- 8 **VOLUME +/-:** Adjust the volume. (P. 8)
- 9 **MUTE:** Switches mute mode on and off. (P. 8)

Installing the batteries

Before installing batteries or using the remote control, make sure that you read precautions on the remote control and batteries in “Notes on remote controls and batteries” (P. 1).

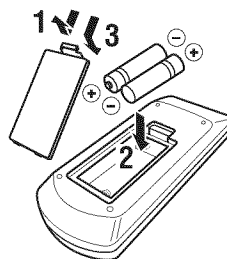

Operation range

Use the remote control within 6 m (20 ft) of the main unit and point it toward the remote control sensor.

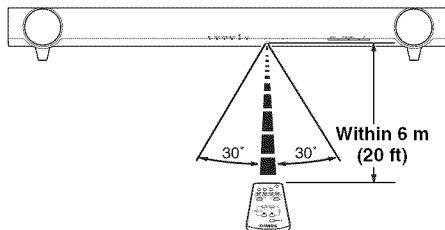

Basic playback operation

- 1 Turn your TV on.
- 2 Press the TV button to switch the input of the unit to "TV."
The unit plays the TV sound.
The INPUT indicator lights up in green.
(P. 11)
- 3 Switch the input of your TV if you use components such as a BD player.



When you play back components such as a BD player connected to the audio input jack of the unit.

- 1 Switch the video input of your TV to the video source such as a BD player.
- 2 Press the BD/DVD or STB button to switch the input of the unit.

The color of INPUT indicator depends on the selected input. (P. 11)

- 3 Start playback.



For information on the external component, refer to the instruction manual for the product.

Enjoying sound with your preference

Switching stereo/surround sound

Playback in surround sound: You can enjoy a realistic sound effect using Yamaha's exclusive AIR SURROUND XTREME.

Playback in stereo sound: An extended sound is achieved for a 2 channel source.

Surround		Stereo	
	Green		No light

Automatic volume level adjustment (UniVolume)

While watching the TV, compensate the excessive volume differences to make it easier to hear during the following cases.

- When switching the channel
- When a TV program changed to commercial
- When one program is finished and another program started



On/Off



Green

Hear narration or dialogue from your TV more clearly (Clear voice)

This function makes dialogue in movies, TV dramas or play-by-play broadcasting clear to listen to.



On/Off



Green

Adjust the volume level

Press **VOLUME +/-** to adjust the volume level.

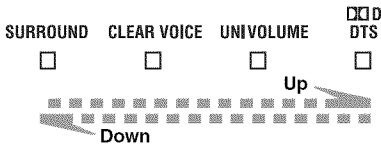

The color of **DTS** indicator changes depending on the adjustable range. Green indicates a lower volume level, orange a moderate level, and red a higher level.

Note

Note that when the **DTS** indicator is red, the volume is set to a higher level. Excessive sound may damage your hearing or bother others.



To turn off the volume temporarily, press **MUTE**.

To resume the volume, press **MUTE** again or press **VOLUME +/-**.

MUTE



Adjust the subwoofer level

Press **SUBWOOFER +/-** to adjust the bass level.

The color of **DTS** indicator changes depending on the bass level. Green indicates a minus level, orange a standard level (default value is 0), and red a plus level.

Audio delay control

You can use this function to delay sound to synchronize with a lagging video image.

- 1 Press and hold **AUDIO DELAY** more than 3 seconds to enter adjustment mode.

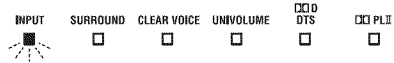

Flashes in green (☞ P. 11)

- 2 Press **SUBWOOFER +/-** to adjust the delay time. (+ increases the delay time)

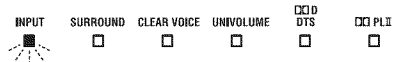

Make the delay time longer



Make the delay time shorter

The color of **DTS** indicator changes depending on the adjustable range. Green indicates a shorter delay time, orange a medium delay, and red a longer delay.

- 3 Press **AUDIO DELAY** to exit the adjustment mode.



The adjustment mode is canceled if the unit is left for 20 seconds without any operation being performed.

Additional Information

Using an external subwoofer

Although the unit has a subwoofer built-in, you can use commercially available powered subwoofer of your choice. Refer to “Alternative connections” (☞ P. 5).

- 1 Set the unit to standby mode.
- 2 Press both the **VOLUME -** button and **⏻** button of the main unit, release the **⏻** button first, then release the **VOLUME -** button.

This unit is turned on when switching between the built-in subwoofer and external subwoofer.

The **SURROUND** indicator lights up as the following illustration. Check if the setting is correct. (☞ P. 11)

	Built-in subwoofer	External subwoofer
The SURROUND indicator (for 2 seconds after the unit is turned on)	<p>SURROUND</p> <p>Green</p>	<p>SURROUND</p> <p>No light</p>

- The default setting is playback of the built-in subwoofer.
- You can verify the current setting by turning the unit on again from standby mode.

Note

You cannot use the built-in subwoofer and the external subwoofer simultaneously.

Operation by the TV remote control is difficult (with unit beneath/under TV)

TV remote control operation may be difficult if the unit hides the sensor of your TV when beneath or under the TV. Try the two solutions below and see whether this solves the problem.

- 1 Move the unit in all directions.
- 2 Remove the stands to lower the height of the unit.

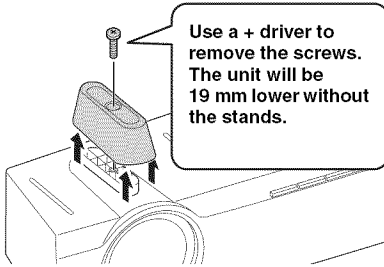

Note

Keep the stands and screws in a safe place for future use.

Using TV remote control signal transmission function

If you cannot solve the problem by the suggestions above, follow the procedure below and use the TV remote control signal transmission function, which transmits the TV remote control signal received at the front of the unit to the remote control sensor of your TV through the IR flasher at the rear of the unit.

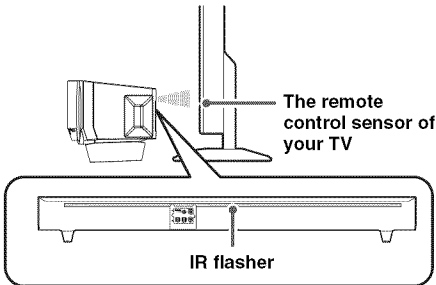



- 1 Set the unit to standby mode.

- 2 Press both the **VOLUME +** button and **⏻** button of the main unit, release the **⏻** button first, then release the **VOLUME +** button.

The unit is turned on when switching the TV remote control signal transmission function on/off.

The **CLEAR VOICE** indicator lights up as the following illustration. Check if the setting is correct. (✱ P. 11)

	On	Off
The CLEAR VOICE indicator (for 2 seconds after the unit is turned on)	CLEAR VOICE  No light	CLEAR VOICE  Green

- The default setting is off.
- You can verify the current setting by turning the unit on again from standby mode.

Notes

- Move the unit in all directions again if TV remote control remains difficult.
- The TV remote control signal transmission function is enabled even if the unit is in standby mode.

Operate the unit by TV remote control (TV remote control learning function)

You can use the TV remote control solely to operate by having the unit learn the TV remote control operations. You can operate the following functions by TV remote control.

- **Volume down**
- **Volume up**
- **Power on/standby mode**



Some TV remote controls may not control these functions. Use the remote control supplied with the unit in this case.

- 1 Set the unit and TV to standby mode.
- 2 Press both the **INPUT** button and **⏻** button of the main unit, release the **⏻** button first, then release the **INPUT** button.

The unit enters the remote control learning mode.

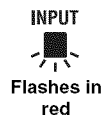

Continued to the next page. →

- 3** Press the button below of the main unit to select the operation you want the unit to learn.

Operation you want the unit to learn	The button of the unit	The Indicator flashes in green
Volume down	VOLUME -	□ ■ □ □ □ □
Volume up	VOLUME +	□ □ ■ □ □ □
Power on/standby mode	⏻	□ □ □ ■ □ □

- 4** Point your TV remote control at the remote control sensor and press the respective button twice or three times until the indicator changes from flashing green to lit green.

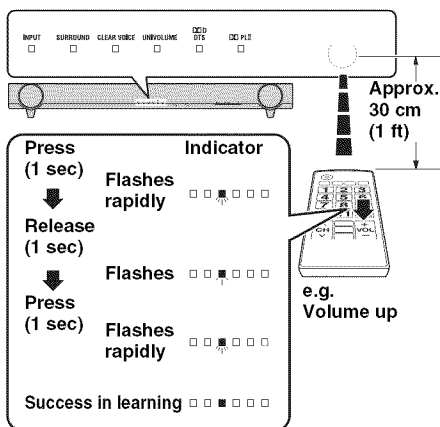

Fault in learning

The UNIVOLUME, CLEAR VOICE and SURROUND indicators flash in green simultaneously for about 3 seconds.

- 5** Repeat steps 3 and 4 to make the unit learn the other operations.
- 6** Press the ⏻ button of the main unit for more than 3 seconds to finish the remote control learning mode.

Release the ⏻ button of the main unit when all the indicators light up in green. The unit enters standby mode.

Notes

- The unit will automatically set to standby mode if the unit in the remote control learning mode is left turned on for 5 minutes without any operation being performed.
- If learning fails, try again with your TV turned off. Note that screen glare may disturb TV remote control learning.

Removing all learned TV remote control operations

- Set the unit to standby mode.
- Press both the INPUT button and ⏻ button of the main unit, release the ⏻ button first, then release the INPUT button.
 

Flashes in red
- Press the INPUT button of the main unit again for more than 3 seconds.
- Release the INPUT button of the main unit when DDD DTS indicator flashes.

Press the ⏻ button of the main unit for more than 3 seconds to finish the remote control learning mode, or to have the unit learn operations of another TV remote control.

Resetting the unit

Should the unit freeze for any reason, this may be remedied by initiating the factory settings.

- Set the unit to standby mode.
- Press and hold the ⏻ button of the main unit for more than 3 seconds.

All the indicator flashes in green.



- Release the ⏻ button of the main unit.

Troubleshooting

Refer to the chart below should the unit not function properly. If the problem you are experiencing is not listed below, or if the instruction below does not help, set the unit to the standby mode, disconnect the AC power supply cable, and contact the nearest authorized Yamaha dealer or service center. Check the below first.

- 1 The AC power supply cable of the unit, TV and external components (such as BD player) are firmly connected to the AC wall outlet.
- 2 The power supply of the unit, TV and the external components (such as BD player) are turned on.
- 3 All cables are firmly connected to their respective jacks on each component.

Problem	Cause	Solution	See page
Power turns on but immediately shuts off.	The power cable may be connected improperly.	Make sure the power cable is plugged into the outlet firmly.	4
	The unit may have received a strong electrical shock, such as from a lightning bolt or excessive static electricity.	Set the unit to standby mode, and then disconnect the power cable. Wait for about 30 seconds, connect the power cable, and then turn the unit on again.	—
	The unit has an auto-sleep function, which will automatically set to standby mode if the unit is left turned on for 12 hours without any operation being performed.		—
The speakers make no sound.	The volume may be set to minimum.	Adjust the volume level.	8
	The mute function may be activated.	Press MUTE on the remote control to cancel the mute function and adjust the volume.	8
	The input source or input setting may be incorrect.	Select the correct input source or input setting.	7
Surround effect is not achieved.	A surround mode is not selected.	Press SURROUND on the remote control to play back the source in surround effect.	7
No bass / The external subwoofer makes no sound.	The volume of the subwoofer channel may be set to minimum level.	Adjust the volume level of the subwoofer.	8
	Opposite setting of subwoofer is selected.	Select correct setting of subwoofer.	8
	The source does not contain low frequency signals.		—
	The cable between the unit and the subwoofer not connected when selecting playback of the external subwoofer.	Connect the unit and the external subwoofer by using a subwoofer pin cable.	5
The volume level decreases without any operation.	The unit controls its volume within a certain level to prevent the next playback from sudden output at excessive volume.	Reset the volume.	8
This unit does not operate properly.	The unit may receive a strong electrical shock, such as from a lightning bolt or excessive static electricity, or drop in power supply.	Set the unit to standby mode, and then disconnect the power cable. Wait for about 30 seconds, connect the power cable, and then turn on the unit again.	—
A digital or high-frequency equipment produces noises.	The unit may be placed close to digital equipment or high-frequency equipment.	Place the unit away from such equipment.	—
The remote control does not operate the unit.	The unit may be outside the remote control operation range.	The operation range for the remote control of the unit is within 6 m (20 ft).	6
	The remote control sensor of the unit may be exposed to direct sunlight or other lighting.	Change the lighting or reposition the unit.	—
	The batteries may be worn out.	Replace the batteries.	6
The volume of the unit and TV increases simultaneously.	Your TV itself received the signal from TV remote control, having learned the operation of the unit.	Set the volume of your TV to minimum, or set the audio output of your TV built-in speaker to off.	—
		Adjust the volume by using the remote control of the unit.	8

Problem	Cause	Solution	See page
The volume, subwoofer and audio delay time is not adjustable.	The adjustment has reached the maximum or minimum.		8
The unit does not learn the operation of TV remote control.	The remote control sensor of the unit may be exposed to direct sunlight or lighting.	Reposition the unit.	—
	The screen glare of TV disturbs the remote control signal.	Disconnect the power cable and perform the remote control learning operation again.	—
	The batteries of TV remote control may be worn out.	Replace the batteries.	—
	The button of the unit was not pressed long enough for the remote control learning operation.	Press the button of TV remote control in the order “press 1 second” › “release 1 second” › “press 1 second”	9
	The TV remote control is not available for remote control learning.	Use the remote control of the unit.	9
	The TV remote control is outside of the operation range.	Point your TV remote control towards the remote control sensor of the unit keeping a distance of 30 cm (1 ft) between them.	9
	The unit does not enter the remote control learning mode.	Operate after checking that the INPUT indicator is flashing in red.	9
The power state of the unit and of your TV is opposite. (For example, though your TV is on, the unit is in standby mode.)	The power state of the unit and of your TV is opposite from the beginning.	Press the power button of TV remote control to set your TV and the unit to standby mode after pressing the power button of your TV itself and of the unit to set both your TV and the unit to on.	9
The TV remote control is not working even if you use the TV remote control signal transmission function.	The unit and TV are too close/far from one another.	Try to use the TV remote control signal transmission function again after repositioning the IR flasher of the unit and the remote control sensor of your TV.	9
		Try to use the TV remote control signal transmission function again after adjusting the height of the unit by removing or attaching its stands.	9
	Something is between the unit and your TV.	Remove the obstruction.	—
	The TV remote control signal transmission function is not activated.	Restart the unit and check the indicator status.	9
	The TV remote control is not compatible with the TV remote control signal transmission function.	Place the unit (without the stands, for example) so as not to hide the remote control sensor of your TV.	9
You cannot use 3D glasses.	The unit obstructs the 3D glasses transmitter of your TV.	Check the position of 3D glasses transmitter of your TV by referring to the manual of your TV, and move the unit to the position where there is no obstruction.	—
The picture on your TV screen becomes blurred or distorted.	The unit is too close to your CRT TV.	Move the unit away from your TV.	—

Contact your nearest authorized Yamaha dealer or service center if the following problem occurs.

Problem	Cause	Solution	See page
The power of the unit immediately shuts off, and the INPUT indicator flashes.	The protection circuit is activated.		—

Specification

Amplifier section

- Minimum RMS Output Power
 - Front Left and Right (1 kHz, 1% THD, 6 Ω) 24 W + 24 W
 - Subwoofer (100 Hz, 1% THD, 3 Ω) 48 W
- Maximum Power
 - Front Left and Right (1 kHz, 10% THD, 6 Ω) 30 W + 30 W
 - Subwoofer (100 Hz, 10% THD, 3 Ω) 60 W

Speaker section

- Type
 - Front speaker Acoustic suspension type/
Non-magnetic shielding type
 - Subwoofer Bass reflex type/
Non-magnetic shielding type
- Driver
 - Front speaker 6.5 cm (2-1/2 in) cone × 2
 - Subwoofer 7.5 cm (3 in) cone × 2
- Impedance
 - Front speaker 6 Ω
 - Subwoofer 3 Ω
- Frequency Response (-10 dB, Stereo mode)
 - Front speaker 150 Hz to 20 kHz
 - Subwoofer 50 Hz to 150 Hz



This system employs new technologies and algorithms that make it possible to achieve 7-channel surround sound with only front speakers, and without using wall reflections.



Manufactured under license from Dolby Laboratories. Dolby, Pro Logic and the double-D symbol are trademarks of Dolby Laboratories.

Input Jacks

- Optical 2 (TV, BD/DVD)
- Coaxial 1 (STB)

Output Jacks

- Subwoofer 1
- System Connector (for subwoofer power interlock) 1

General

- Power Supply
 - [U.S.A. and Canada models] AC 120 V, 60 Hz
 - [Taiwan model] AC 110 V, 60 Hz
 - [Other models] AC 220-240 V, 50/60 Hz
- Power Consumption 22 W
- Standby Power Consumption Less than 0.5 W
- Dimensions (W × H × D)
 - With stands 890 × 107 × 120.5 mm
(35-1/8 × 4-1/4 × 4-3/4 in)
- Weight 4.2 kg (9.3 lbs.)

* Specifications are subject to change without notice.



“DTS” and “DTS Digital Surround” are registered trademarks of DTS, Inc.

UniVolume

“UniVolume” is a trademark of Yamaha Corporation.

Information for Users on Collection and Disposal of Old Equipment and Used Batteries



These symbols on the products, packaging, and/or accompanying documents mean that used electrical and electronic products and batteries should not be mixed with general household waste.

For proper treatment, recovery and recycling of old products and used batteries, please take them to applicable collection points, in accordance with your national legislation and the Directives 2002/96/EC and 2006/66/EC.



By disposing of these products and batteries correctly, you will help to save valuable resources and prevent any potential negative effects on human health and the environment which could otherwise arise from inappropriate waste handling.

For more information about collection and recycling of old products and batteries, please contact your local municipality, your waste disposal service or the point of sale where you purchased the items.



[Information on Disposal in other Countries outside the European Union]

These symbols are only valid in the European Union. If you wish to discard these items, please contact your local authorities or dealer and ask for the correct method of disposal.

Pb

Note for the battery symbol (bottom two symbol examples):

This symbol might be used in combination with a chemical symbol. In this case it complies with the requirement set by the Directive for the chemical involved.

Important Notice: Guarantee Information for customers in EEA* and Switzerland**English**

For detailed guarantee information about this Yamaha product, and Pan-EEA* and Switzerland warranty service, please either visit the website address below (Printable file is available at our website) or contact the Yamaha representative office for your country. * EEA: European Economic Area

<http://europe.yamaha.com/warranty/>

