

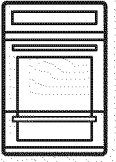

Thinking of you
Electrolux



EN ELECTRIC RANGE

USE AND CARE GUIDE



Table of contents

Finding information	2
IMPORTANT SAFETY INSTRUCTIONS	3-6
Features	7
Surface Cooking	8-10
• Cookware	8
• How the cooktop works	9
• Home canning	10
Setting Surface Controls	11-16
• Cooktop controls	11
• Cooktop power level settings	12-13
• Setting the single element	14
• Setting the dual elements	15
• Warming zone	16
Oven Cooking	17-18
• Oven racks	17
• Luxury Glide™ oven racks	18
Setting Oven Controls	19-43
• Oven control display and keys	19
• Setting the clock	20
• Changing clock display mode	20
• Changing oven temperature display mode (°F/°C)	21
• Changing between 12-hour energy saving or continuous bake mode settings	21
• Adjusting tone volume	22
• Cooktop lock	22
• Oven control lock	23
• Timer	23
• Fast preheat	24
• Bake	25-26
• Cook time	27
• Setting cook time with end time	28
• Broil	29-30
• Conv bake	31-32
• Conv convert	33
• Conv broil	34
• Conv roast	35-36
• Keep warm	37
• Slow cook	38
• My favorite	39
• Adjusting the oven temperature	40
• Sabbath mode	41-42
• Restoring control to factory default settings	43
• Interior oven light	43
Fresh-Clean	44-46
Care & Cleaning	47-51
• Cleaning recommendations	47
• Cooktop maintenance	48
• Cooktop cleaning	48-49
• Aluminum foil and oven liners	49
• Removing and replacing the oven door	50
• Special door care instructions	51
• Changing oven light	51
Solutions to Common Problems	52-54
Warranty	55

Please read and save this guide

Thank you for choosing **Electrolux**, the premium brand in home appliances. This *Use & Care Guide* is part of our commitment to customer satisfaction and product quality throughout the service life of your new appliance.

We view your purchase as the beginning of a relationship. To ensure our ability to continue serving you, please use this page to record important product information.

Record your purchase

Purchase date

Electrolux model number

Electrolux serial number

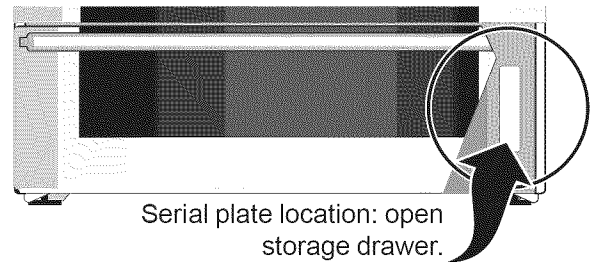

NOTE

Registering your product with Electrolux enhances our ability to serve you. You can register online at www.electroluxappliances.com or by dropping your Product Registration Card in the mail.

Questions?

For toll-free telephone support in the U.S. and Canada:

1-877-4ELECTROLUX (1-877-435-3287)

For online support and Internet production information visit www.electroluxappliances.com

Recognize safety symbols, words and labels

Safety items throughout this manual are labeled with a WARNING or CAUTION based on the risk type as described below:

WARNING

This symbol alerts you to situations that may cause serious body harm, death or property damage.

CAUTION

This symbol alerts you to situations that may cause bodily injury or property damage.

Read all of the following safety instructions before using this appliance

- **Remove all tape and packaging before using the range.** Destroy the carton and plastic bags after unpacking the range. Never allow children to play with packaging material.
- **Proper Installation—Be sure your appliance is properly installed and grounded by a qualified technician in accordance with the National Fuel Gas Code ANSI Z223- latest edition, or in Canada CAN/CGA B149.1 and CAN/GGA B149.2, and the National Electrical Code ANSI/NFPA No.70-latest edition, or in Canada CSA Standard C22.1, Canadian Electrical Code, Part 1, and local code requirements.** Install only per installation instructions provided in the literature package for this range.
Ask your dealer to recommend a qualified technician and an authorized repair service. Know how to disconnect the power to the range at the circuit breaker or fuse box in case of an emergency.
- **User servicing—Do not repair or replace any part of the appliance unless specifically recommended in the manuals.** All other servicing should be done only by a qualified technician. This may reduce the risk of personal injury and damage to the range.
- **Never modify or alter the construction of a range by removing leveling legs, panels, wire covers, anti-tip brackets/screws, or any other part of the product.**

Save these instructions for future reference.

WARNING

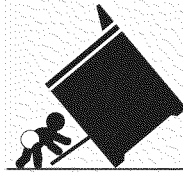

Tip Over Hazard

- A child or adult can tip the range and be killed.
- Verify the anti-tip device has been installed to floor or wall.
- Ensure the anti-tip device is re-engaged when the range is moved to floor or wall.
- Do not operate the range without the anti-tip device in place and engaged.
- Failure to follow these instructions can result in death or serious burns to children and adults.

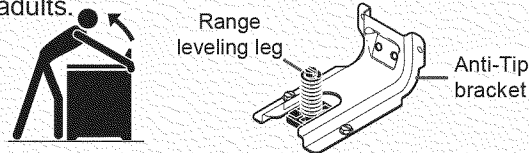

To check if the anti-tip bracket is installed properly, use both arms and grasp the rear edge of range back. Carefully attempt to tilt range forward. When properly installed, the range should not tilt forward.

Refer to the anti-tip bracket **installation instructions** supplied with your range for proper installation.

WARNING

- **Stepping, leaning or sitting on the doors or drawers of this range can result in serious injuries and also cause damage to the range.** Do not allow children to climb or play around the range. The weight of a child on an open door may cause the range to tip, resulting in serious burns or other injury.
- **Do not leave children alone—Children should not be left alone or unattended in the area where appliance is in use.** They should never be allowed to sit or stand on any part of the appliance.
- **Storage in or on appliance—flammable materials should not be stored in an oven, lower oven drawer, near surface units or in the storage drawer.** This includes paper, plastic and cloth items, such as cookbooks, plasticware and towels, as well as flammable liquids. Do not store explosives, such as aerosol cans, on or near the range.

WARNING

Do not store items of interest to children in the cabinets above a range or on the backguard of a range. Children climbing on the range to reach items could be seriously injured.

CAUTION

- **Do not touch surface zones, areas near these zones, heating elements or interior surfaces of the oven.** ALL surface zones and oven heating elements may be hot even though they are dark in color. Areas near surface zones may become hot enough to cause burns. During and after use, do not touch, or let clothing or other flammable materials touch these areas until they have had sufficient time to cool. Among these areas are the cook top, surfaces facing the cook top, the oven vent openings and surfaces near these openings, oven door and window.
- **Wear proper apparel—Loose-fitting or hanging garments should never be worn while using the appliance.** Do not let clothing or other flammable materials contact hot surfaces.
- **Do not use water or flour on grease fires—Smother the fire with a pan lid, or use baking soda, a dry chemical or foam-type extinguisher.**
- **When heating fat or grease, watch it closely.** Fat or grease may catch fire if allowed to become too hot.
- **Use only dry potholders - Moist or damp potholders on hot surfaces may result in burns from steam.** Do not let potholders touch hot heating elements. Do not use a towel or other bulky cloth instead of a potholder.
- **Do not heat unopened food containers -** Buildup of pressure may cause container to burst and result in injury.
- To avoid a possible fire hazard, **never use your appliance for warming or heating a room.**
- **Do not cook foods directly on the oven bottom.** To avoid damaging the oven interior always use proper cookware and always use the oven racks.

CAUTION

- **Protective liners—**Do not use aluminum foil to line the oven bottom, except as suggested in the manual. Improper installation of these liners may result in a risk of electrical shock, or fire.

IMPORTANT

- **Do not attempt to operate the range during a power failure.** If the power fails, always turn off the range. If the range is not turned off and the power resumes, the range will begin to operate again. Once the power resumes, reset the clock and oven function.
- Be sure to always have an appropriate foam-type **fire extinguisher** available, visible and easily accessible located near the appliance.
- Remove the oven door from any unused range if it is to be stored or discarded.

Important instructions for using your cooktop

- **Know which control operates each surface heating zone.** Place a pan of food on the unit before turning it on, and turn the zone off before removing the pan.
- **Use proper pan size—**This appliance is equipped with one or more surface units of different sizes. Select utensils having flat bottoms large enough to cover the surface unit heating element. The use of undersized utensils will expose a portion of the heating element to direct contact and may result in ignition of clothing. Proper relationship of utensil to element will also improve efficiency.
- **Utensil handles should be turned inward and not extend over adjacent surface elements—**To reduce the risk of burns, ignition of flammable materials, and spillage due to unintentional contact with the utensil, the handle of the utensil should be positioned so that it is turned inward, and does not extend over adjacent surface units.
- **Never leave surface elements unattended at high heat settings—**Boilovers cause smoking and greasy spillovers that may ignite, or a pan that has boiled dry may melt.

- **Do not immerse or soak removable heating elements**—Heating elements should never be immersed in water. Heating elements clean themselves during normal operation.
- **Glazed cooking utensils**—Only certain types of glass, glass/ceramic, ceramic, earthenware, or other glazed utensils are suitable for cook top service without breaking due to the sudden change in temperature. Check the manufacturer's recommendations for cook top use.
- **When flaming foods under a ventilating hood, turn the fan on.**
- **Do not cover the broiler insert with aluminum foil. Exposed fat and grease could ignite.**
- **Cold temperatures** can damage the electronic control. When using the appliance for the first time, or when the appliance has not been used for an extended period of time, be certain the unit has been in temperatures above 32°F (0°C) for at least 3 hours before turning on the power to the appliance.

Important instructions for cleaning your range

- **Clean the range regularly to keep all parts free of grease that could catch fire.** Pay particular attention to the area underneath each surface element. Do not allow grease to accumulate.
- **Kitchen cleaners and aerosols—Always follow the manufacturer's recommended directions for use.** Be aware that excess residue from cleaners and aerosols may ignite causing damage and injury.
- **Clean ventilating hoods frequently—Grease should not be allowed to accumulate on the hood or filter.** Follow manufacturer's instructions for cleaning.

Self cleaning ovens

- **Clean in the self-cleaning cycle only the parts listed in this Use & Care Manual.** Before self cleaning the oven, remove the broiler pan and any utensils or foods from the oven.
- **Do not use oven cleaners**—No commercial oven cleaner or oven liner protective coating of any kind should be used in or around any part of the oven.
- **Do not clean door gasket**—The door gasket is essential for a good seal. Care should be taken not to rub, damage or move the gasket.
- The health of some birds is extremely sensitive to the fumes given off during the self-cleaning cycle of any range. Move birds to another well-ventilated room.

Important safety notice

The California Safe Drinking Water and Toxic Enforcement Act requires the Governor of California to publish a list of substances known to the state to cause cancer, birth defects or other reproductive harm, and requires businesses to warn customers of potential exposure to such substances.

For Ceramic-glass cooktop models

- **Do not cook on broken cook top**—If cook top should break, cleaning solutions and spillovers may penetrate the broken cook top and create a risk of electric shock. Contact a qualified technician immediately.
- **Clean cook top with caution**—If a wet sponge or cloth is used to wipe spills on a hot cooking area, be careful to avoid a steam burn. Some cleaners can produce noxious fumes if applied to a hot surface.

Important instructions for using your oven

- **Use care when opening oven door or lower oven drawer (if equipped)**—Stand to the side of the range when opening the door of a hot oven. Let hot air or steam escape before you remove or replace food in the oven.
- **Keep oven vent ducts unobstructed.** The oven vent is located under the left rear surface element if your model is equipped with coil elements. The oven vent is located below the backguard for models equipped with ceramic-glass cook tops. Touching the surfaces in this area when the oven is operating may cause severe burns. Also, do not place plastic or heat-sensitive items on or near the oven vent. These items could melt or ignite.
- **Placement of oven racks.** Always place oven racks in desired location while oven is cool. If rack must be moved while oven is hot use extreme caution. Use potholders and grasp the rack with both hands to reposition. Do not let potholders contact the hot heating elements in the oven. Remove all utensils from the rack before moving.
- **Do not use the broiler pan without its insert.** The broiler pan and its insert allow dripping fat to drain and be kept away from the high heat of the broiler.

Grounding Instructions

For models factory-equipped with a power cord:

For personal safety, this appliance must be properly grounded. For maximum safety, the power cord must be plugged into an electrical outlet that is correctly polarized and properly grounded. If a 2-prong wall receptacle is the only available outlet, it is the personal responsibility of the consumer to have it replaced with a properly grounded 3-prong wall receptacle installed by a qualified electrician.

Grounding type
wall receptacle

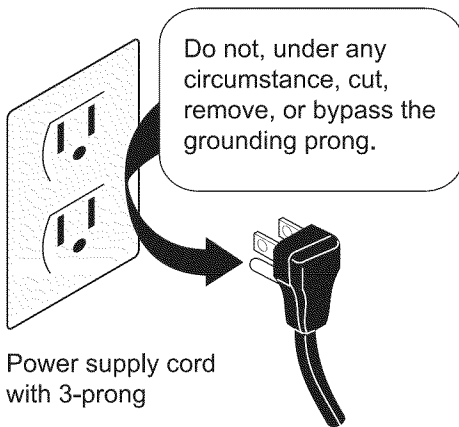

WARNING

- Avoid fire hazard or electrical shock. Do not use an adapter plug, an extension cord, or remove grounding prong from electrical power cord. Failure to follow this warning can cause serious injury, fire or death.
- This appliance may be equipped with a 3-prong grounding plug. For your protection against shock hazard, it should be plugged directly into a properly grounded receptacle. **Do not** cut or remove the grounding prong from this plug.

See the **INSTALLATION INSTRUCTIONS** packaged with this appliance for complete installation and grounding instructions.

Range features

Your electric range features include:

1. Membrane touch control panel
2. Oven digital control display, timer & surface controls
3. Sure-2-fit™ cobalt blue self-cleaning upper oven interior
4. Self-clean oven door latch
5. Automatic interior oven door light switch
6. Interior oven light
7. Perfect-Convect³™ convection fan system
8. Extendable Luxury-Glide™ telescoping interior oven rack(s)
9. Interior oven racks (not shown, types may vary by model)
10. Large 1-piece metal upper & lower oven door handles
11. Color coordinated or stainless steel oven exterior panels & trim
12. Full-width tinted oven door window glass
13. Storage drawer
14. Easy to clean upswept color coordinated or stainless steel cooktop.
15. Ceramic smoothtop
16. Leveling legs & anti-tip bracket (included)
17. Broiler pan (some models)
18. Broiler pan insert (some models)

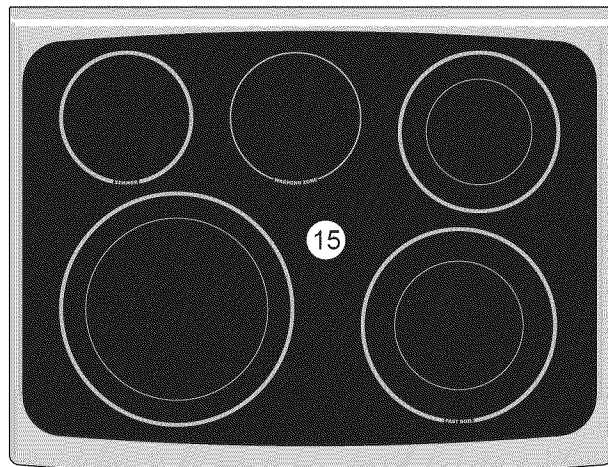
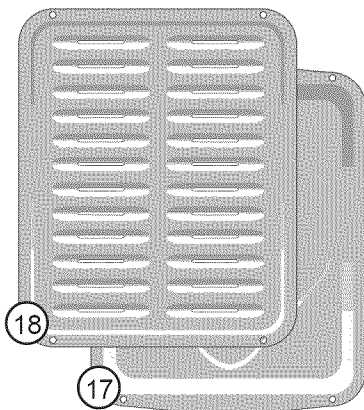
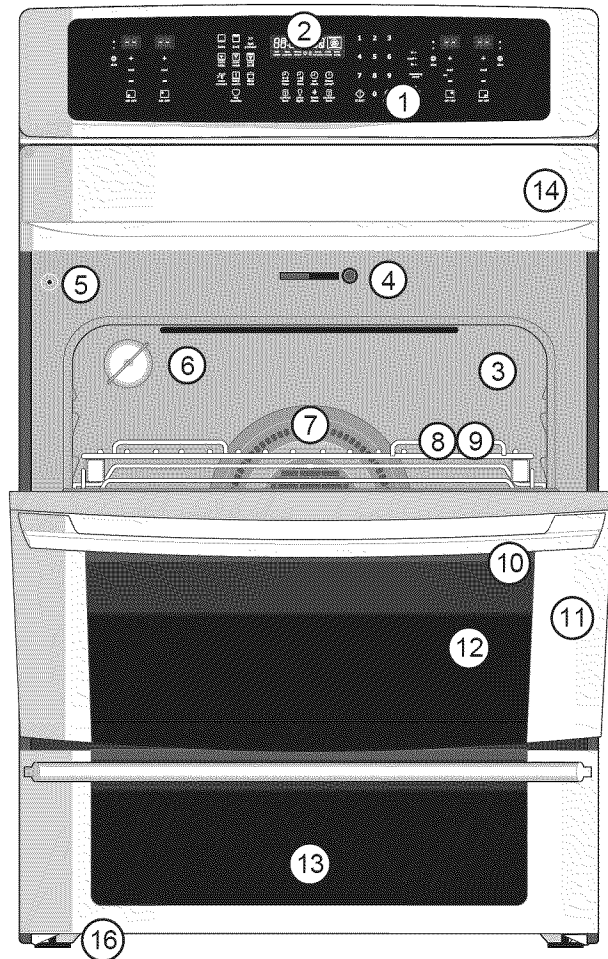

Cookware

Using proper cookware

The size and type of cookware will influence settings needed for the best cooking results. Be sure to follow the recommendations for using proper cookware as illustrated.

Cookware should have flat bottoms that make good contact with the entire surface heating element. Check for flatness by rotating a ruler across the bottom of the cookware.

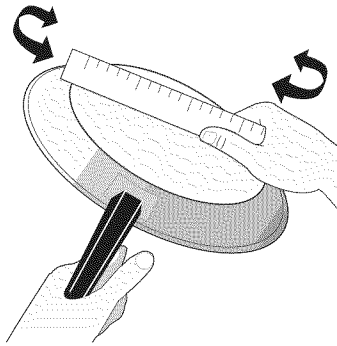

Cookware should always:

- Have flat bottoms.
- Have tight fitting lids.
- Be well-balanced.
- Be made of material that conducts heat well.
- Be easy to clean.
- Match to the size of the element.

Cookware should not:

- have a curved or warped bottom.
- hang over the surface element by more than one-half inch.
- be smaller than the element by more than one-half inch.
- have a heavy handle that tilts the pan.

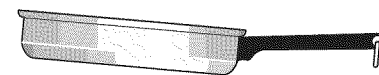
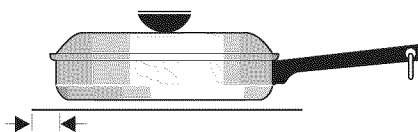
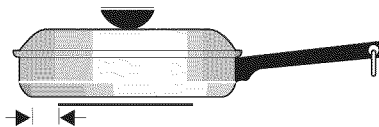
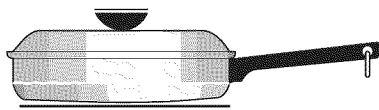

Cookware material types

The cookware material determines how evenly and quickly heat is transferred from the surface element to the pan bottom. The most popular materials available are:

- **Aluminum** - Excellent heat conductor. Some types of food will cause it to darken (Anodized aluminum cookware resists staining & pitting). If aluminum pans slide across the ceramic cooktop, they may leave metal marks which will resemble scratches. Remove these marks immediately.
- **Copper** - Excellent heat conductor but discolors easily. May leave metal marks on ceramic glass (see Aluminum above).
- **Stainless steel** - Slow heat conductor with uneven cooking results. Is durable, easy to clean and resists staining.
- **Cast iron** - A poor heat conductor however will retain heat very well. Cooks evenly once cooking temperature is reached. Not recommended for use on ceramic cooktops.
- **Porcelain-enamel on metal** - Heating characteristics will vary depending on base material. Porcelain-enamel coating must be smooth to avoid scratching ceramic cooktops.
- **Glass** - Slow heat conductor. Not recommended for ceramic cooktop surfaces because it may scratch the glass.

For more information about the ceramic cooktop see "Cooktop Cleaning & Maintenance" in the **Care & Cleaning** section.

How the cooktop works

About the ceramic glass cooktop

The ceramic cooktop has radiant surface elements mounted below the surface of the glass. Heat is transferred up through the surface of the cooktop to the cookware.

The design of the ceramic cooktop outlines the area of the surface element underneath. Your range is equipped with radiant surface burners with different wattage ratings. The ability to heat food quicker and in larger volumes increases as the element wattage increases.

The type and size of cookware, the number of surface elements in use and the settings, are all factors that will affect the amount of heat that will spread to areas beyond the surface elements. The areas surrounding the elements may become **hot enough to cause burns**.

About the radiant surface elements

The element temperature rises gradually and evenly. As the temperature rises, the element will glow red. To maintain the selected setting, the element will cycle on and off. The heating element retains enough heat to provide a uniform and consistent heat even during the off cycle. For efficient cooking, turn off the element several minutes before cooking is complete. This will allow residual heat to complete the cooking process.

NOTES

- Radiant elements have a limiter that allows the element to cycle ON and OFF, even at the HI setting. This helps to prevent damage to the ceramic cooktop. Cycling at higher settings is **normal**. Cycling may also occur if the cookware is too small for the radiant element or if the cookware bottom is warped (*refer to Using Proper Cookware on page 7*).
- Read the detailed instructions for ceramic glass cooktop cleaning in both the **Care and Cleaning** and **Before You Call** sections of this Use and Care Manual.

CAUTION

Unlike the surface elements, the keep warm zone will not glow red when it is hot.

Always use potholders or oven mitts when removing food from the keep warm zone as cookware and plates will be **hot**.

Radiant surface elements may appear to have cooled after they have been turned off. **The glass surface may still be hot** and burns may occur if the glass surface is touched before it has cooled.

Do not place flammable items such as plastic salt and pepper shakers, spoon holders or plastic wrappings on top of the range when it is in use. These items could melt or ignite. Potholders, towels or wooden spoons could catch fire if placed too close to the surface elements.

Home Canning

➔ IMPORTANT

DO NOT straddle a cooking utensil over two different surface cooking areas at the same time. This might cause the ceramic cooktop to fracture.

Be sure to read and observe all the following points when home canning using your appliance:

- Use only quality flat bottom canners when home canning. Use a straight-edge to check canner bottom.
- Start with hot tap water **to bring water to boil more quickly.**
- Use the highest heat setting when first bringing the water to a boil. Once boiling is achieved, reduce heat to lowest possible setting to maintain that boil.
- Make sure the diameter of the canner does not exceed 1 inch beyond the surface element markings. It is recommended to use smaller diameter canners on electric coil and ceramic glass cooktops.
- When using two canners at the same time, stagger the canners on the left and right sides of the cooktop. This will help distribute the heat more evenly.

Be sure to review the latest online information available for home canning. Some suggestions would be the **U.S. Department of Agriculture Food Safety and Inspection Service** or the **National Center for Home Food Preservation (NCHFP).**

➔ IMPORTANT

Do not allow aluminum foil or ANY material that can melt to make contact with the ceramic glass cooktop. If these items melt on the cooktop they will damage the ceramic cooktop.

Oven vent location

The oven vent is located under the left side of the control panel. When the upper oven is operational, warm air will pass through this vent naturally. The venting is necessary for proper air circulation and provides good baking results in the upper oven.

Do not block this vent.

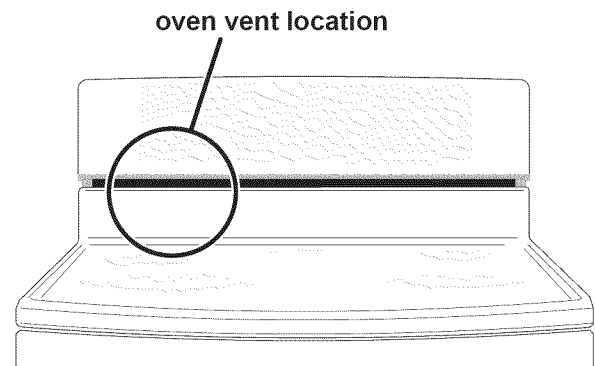

Cooktop controls

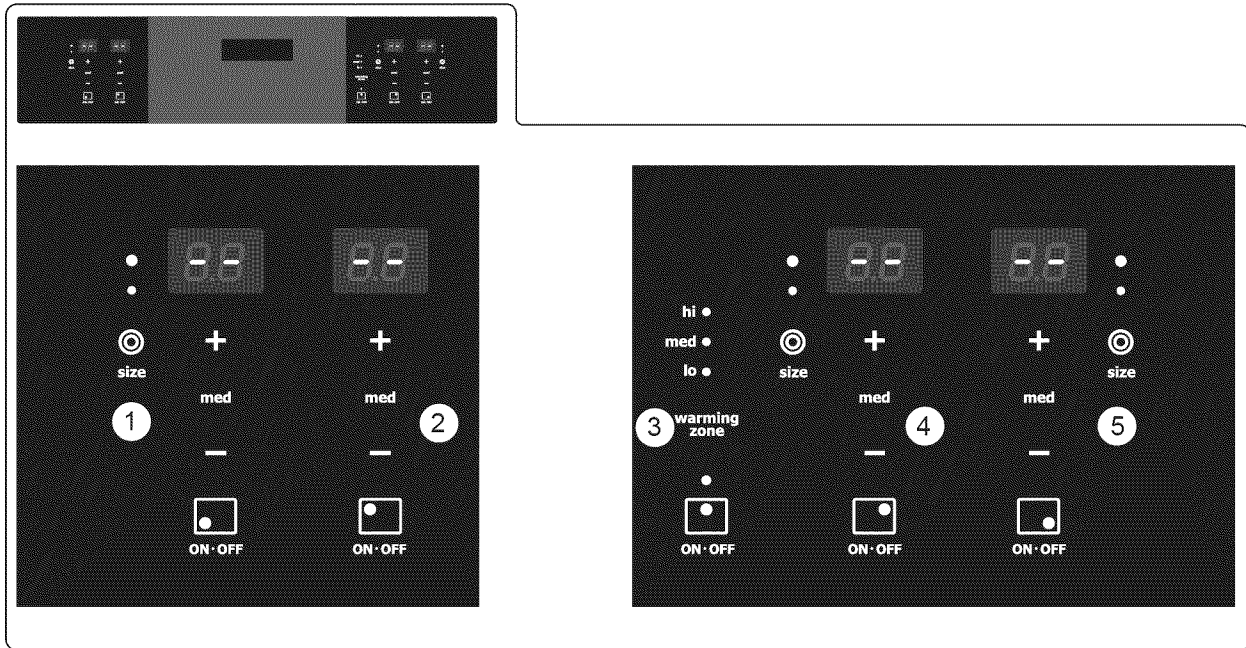

Cooktop and cooktop controls

1. Left front 9/12 inch expandable radiant element (1200/3000W)
2. Left rear 6 inch element (1200W)
3. Warming zone 6 inch element (100W)
4. Right rear 5/7 inch expandable radiant element (750/1800W)
5. Right front 6/9 inch high wattage expandable radiant element (1200/3000W)

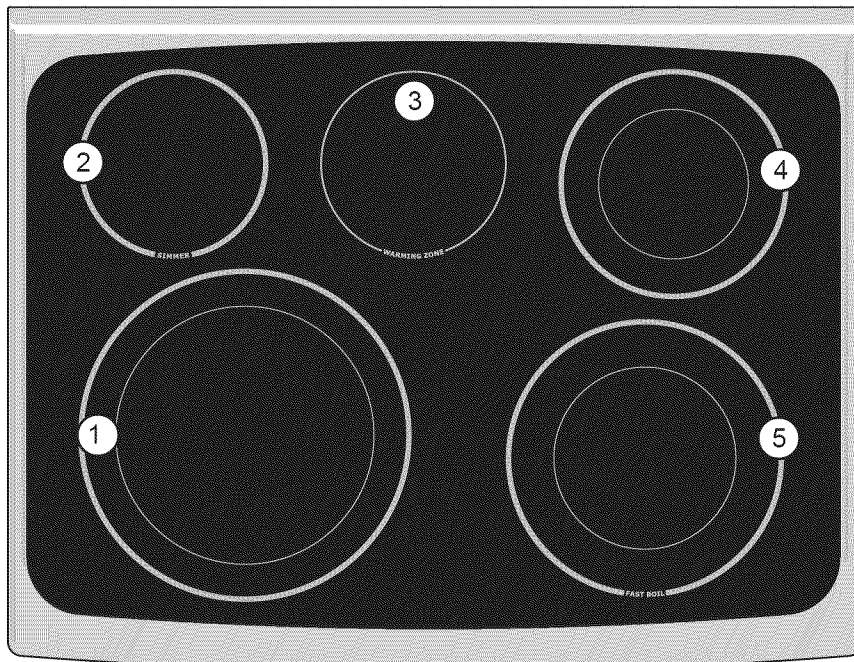

12 Setting Surface Controls

Cooktop power level settings

Available power level settings

Your surface control provides varied settings for each heating zone (except the warmer zone). These power levels include **ON** (--), **Lo** (10%), **5.0** (medium 50%), and **Hi** (100%). See Figure 1 through Figure 4.

The + and - keys provide incremental adjustments for precise control when changing surface settings. Low heat settings (between 0.0 and 2.8) change with more precision. High heat settings (between 3.0 to HI) will change faster. See Figure 5.

Element size indicators

Some cooktop zone positions offer two different element sizes. At these locations, you may choose to use the inner element only or you may expand the heating area with a press of the **BURNER SIZE** key.

The number of circles displayed at the element zone LED represents the number of heating rings available for that position.

- 1 circle = single element
- 2 circles = double element

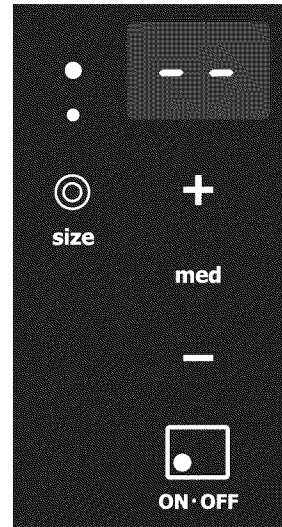

Fig. 1

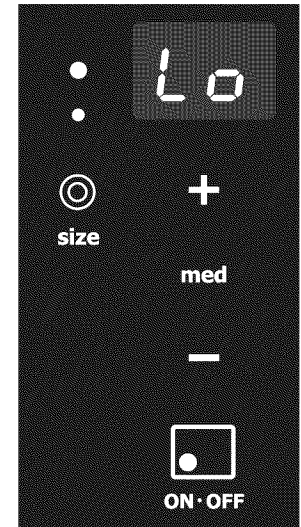

Fig. 2

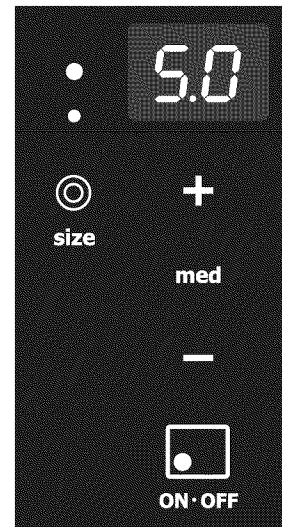

Fig. 3

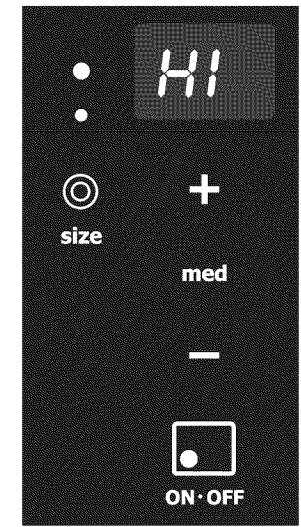

Fig. 4

Display Settings Changes	
Setting / Power	Incremental change
Lo to 3.0 (10-30%)	0.2
3.0 to HI (30-100%)	0.5

Fig. 5

Cooktop power level settings

Cooktop element display windows

The control panel provides four digital display windows showing power levels for the cooking zones on the cooktop. Power levels are monitored using the window displays and controlled with the corresponding control touch keypads.

The dual radiant heating elements provide two different element sizes. This feature provides additional heating area choices to match the size of the cookware you are using.

Available power level settings

The control panel will display power level settings ranging from **Hi** (Figure 1) to **Lo** (Figure 6) and **OFF** (Figure 7).

The settings between **9.5** (Figure 2) and **3.0** (Figure 3) decrease and increase in increments of **0.5** (1/2). Settings between **2.8** (Figure 4) and **1.2** (Figure 5) are **Simmer** settings which decrease and increase in increments of 0.2 to **Lo** (Figure 6) for more precise settings at lower heat levels.

Hot surface element message (HE)

After turning any of these elements OFF, the cooktop will remain HOT for some time. The corresponding **HE** message (hot element, Figure 8) will remain ON until that element position on the cooktop has cooled. The display will turn off when cool (Figure 7).

Cooktop lockout message (- -)

The (- -) message will appear in the display when the **cooktop lockout** feature is active (Figure 9). Refer to the cooktop lockout instructions for more detailed information.

Sabbath Day feature (Sb) message

The display windows will show the **Sb** message when the Sabbath Day feature is active (Figure 10). See "**Setting the Sabbath Day feature**" section for detailed instructions.

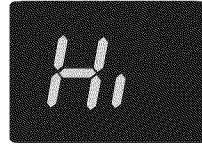

Fig. 1



Fig. 2



Fig. 3



Fig. 4

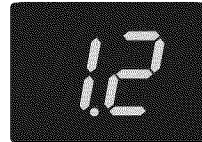

Fig. 5

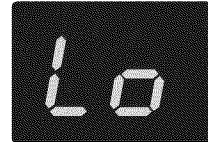

Fig. 6



Fig. 7



Fig. 8

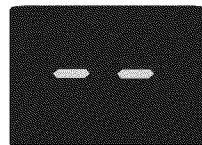

Fig. 9



Fig. 10

14 Setting Surface Controls

Setting the single element

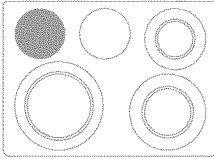

The left rear cooking position on the cooktop may only be used as a **single** surface element.

The other 3 dual element positions on the cooktop may be set to heat as a single or **dual** element. Refer to the following page for more complete information about the dual elements.



For best results

The size and type of utensil used, and the amount and type of food being cooked will influence the setting needed for best cooking results.

CAUTION

- Radiant surface elements may appear to have cooled after they have been turned off. The glass surface may still be hot **and burns may occur if the glass surface is touched before it has cooled sufficiently.**
- Do not place flammable items such as **plastic salt & pepper shakers, spoon holders, plastic wrappings** or **aluminum foil** on top of the range when it is in use. These items could melt or ignite. Potholders, towels or wooden spoons could catch fire if placed too close to the surface elements. Some of these items may melt and can damage the ceramic cooktop.

Cooktop power level settings

Use the **Suggested cooktop power level settings table** (Figure 1) to determine the best element power setting for the type of food you are preparing.

To operate the single radiant surface element:

Example	
Step	Press
1. Place cookware center on the surface element.	
2. Press and hold the ON-OFF key for the desired element position until a beep sounds.	ON-OFF
3. Press +, med (5.0) or -. Each touch of the + or - key will decrease or increase the power level by 0.5 between 9.5 and 3.0. Simmer power levels between 3.0 and 1.2 will decrease or increase by 0.2 increments. Lo is the lowest power level available.	+, med, -
4. When finished, press ON-OFF to turn element off.	ON-OFF

Suggested cooktop power level settings table

Setting	Type of cooking
High (8-Hi)	Start most foods, bring water to boil, pan broiling
Medium high (5-8)	Continue a rapid boil, fry, deep fat fry
Medium (3-5)	Maintain a slow boil, thicken sauces and gravies, steam vegetables
Medium low (2-3)	Keep foods cooking, poach, stew
Lo (Lo-2)	Keep warm, melt, simmer

Note: The suggested settings are based for cooking with medium-weight aluminum pans with lids. Settings may vary when using other types of pans. Do not use these settings for the warmer zone.

Fig. 1

Setting the dual elements

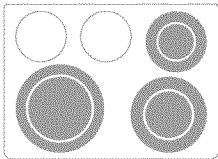

The right rear and both right and left front elements may be set to heat as single or **dual** elements.

Cooktop power level settings

Use the **Suggested cooktop power level settings table** (Figure 1- previous page) to determine the best element power setting for the type of food you are preparing.

To operate a dual radiant surface element:

Example	
Step	Press
1. Place cookware center on the surface element.	
2. Press and hold the ON·OFF key for the desired element position until a tone sounds.	ON·OFF
3. Press +, med (5.0) or -. Each touch of the + or - key will decrease or increase the power level by 0.5 between 9.5 and 3.0. Simmer power levels between 3.0 and 1.2 will decrease or increase by 0.2 increments. Lo is the lowest power level available.	-, med, +
4. Use the size key to toggle between the inner single heating element (Figure 2) or to expand for dual element heating (Figure 3-), then release.	size
5. When finished, press ON OFF key to turn element off.	ON·OFF

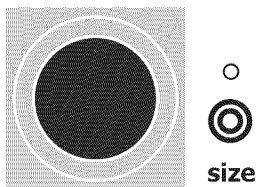

Fig. 2
inner portion
heats only.

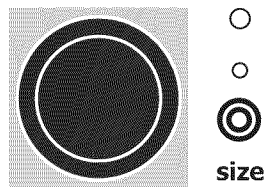

Fig. 3
inner and middle
portions will
heat.

▶ IMPORTANT

Do not allow aluminum foil, plastic, or ANY material that can melt to make contact with the ceramic glass cooktop. If these items melt on the cooktop they can damage the ceramic cooktop.

☰ NOTES

- Start most cooking operations at a higher heat setting and then turn to a lower setting to finish cooking.
- For efficient cooking, turn the surface element OFF several minutes before cooking is complete. This will allow residual heat to complete the cooking process.
- A glowing red surface heating area extending beyond the bottom edge of the cookware indicates the cookware is **too small** for the surface heating area.
- Radiant elements have a limiter that will make the element **cycle** ON and OFF, even at the high setting. This helps prevent damage to the ceramic smoothtop. Cycling at the high setting is normal and will occur more frequently if the cookware is too small for the radiant element or if the cookware bottom is warped.

Hot Element (HE) Message

After heating using any of the cooktop elements, the cooktop will become **very hot**. Even with all the controls off, the cooktop will remain hot for some time afterwards.



Fig. 1

The controls monitor the temperature of the cooktop surface. If the message "HE" (hot element) shows in the cooktop display window, then the cooktop is too hot to touch (Figure 1).

☰ NOTE

Any heating zone may be set again and used for cooking even if the HE message is displayed.

16 Setting Surface Controls

Warming zone

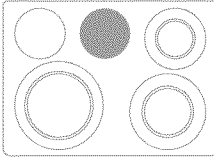

The purpose of the **warming zone** is to maintain cooked foods at serving temperatures.

Always start with hot, cooked foods. It is not recommended to heat cold food to serving temperatures. Foods like vegetables, gravies, casseroles, soups, stews, breads, and pastries work well on the warming zone. The warming zone works well for warming oven-safe dinner plates.

Warming zone temperature selection

Refer to the suggested settings (*Figure 1*) when choosing a setting for food. If a particular food is not listed, start with the **med** setting and adjust as needed. Most foods may be kept at serving temperatures when using the **med** setting.

Suggested warming zone settings	
Food item	Heat level
Hot beverages	hi
Fried foods	hi
Vegetables	med
Soups (cream) and stews	med
Sauces and gravies	med
Meats	med
Eggs	lo
Dinner plates with food	lo
Casseroles	lo
Breads/pasteries	lo

-Fig. 1-

IMPORTANT

Use only plates, cookware and utensils recommended for oven and ceramic cooktop use. **Do not use plastic wrap or aluminum foil** to cover foods. Plastic or aluminum foil may melt onto the ceramic cooktop.

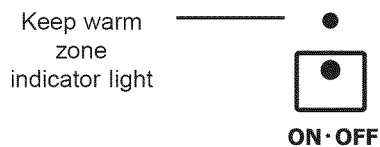

-Fig. 2-

To operate keep warm zone:

Examples	
Step	Press
1. Place cookware on the warming zone .	
2. Press warmer zone ON·OFF (The warmer zone indicator light will turn on).	ON·OFF
3. Press keep warm key until desired temperature setting is displayed (<i>Figures 3, 4 and 5</i>).	hi med lo
4. When finished, press ON·OFF .	ON·OFF

hi ●	hi ●	hi ●
med ●	med ●	med ●
lo ●	lo ●	lo ●
low setting Fig. 3	medium setting Fig. 4	high setting Fig. 5

CAUTION

- Unlike other surface elements, the warming zone will not glow red when it is hot. To avoid possible burns always use potholders or oven mitts when moving food to and from the warming zone. Cookware or plates **will be hot**.
- Radiant surface elements may appear to have cooled after they have been turned off. **The glass surface may still be hot** and burns may occur if the glass surface is touched before it has cooled sufficiently.
- **Do not place flammable items** such as plastic salt & pepper shakers, spoon holders, plastic wrappings or aluminum foil on top of the range when it is in use. **These items could melt or ignite**. Potholders, towels or wooden spoons could catch fire if placed too close to the surface elements.

Oven racks

CAUTION

Always use potholders or oven mitts when removing food or adjusting the oven racks. Wait until the oven has completely cooled if possible. Oven racks may be **HOT** and may cause burns.

Air circulation in the oven

For best air circulation when baking, allow a space of 2-4 inches (5-10 cm) around the cookware for proper air circulation. Be sure pans and cookware do not touch each other, the oven door, sides or back of the oven cavity.

Hot air must be able to circulate around cookware for even heat to reach the food.

Removing and replacing flat or offset oven racks

- **To remove** - pull the oven rack straight forward until it reaches the stop position. Lift up front of oven rack slightly and slide out.
- **To replace** - place the oven rack on the rack guides on the oven walls. Tilt the front of the rack upward slightly and slide the oven rack back into place.

Types of oven racks

Your appliance may be equipped with any one or more of the following oven rack types:

Flat oven rack

Fig. 2

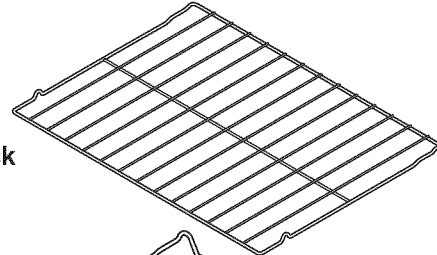

Offset oven rack

(some models)

Fig. 3

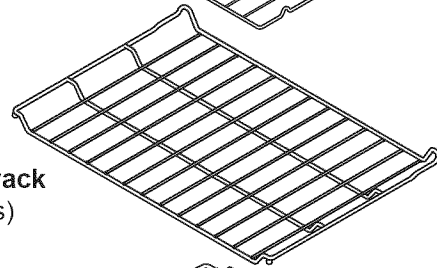

Fully extendable Luxury-Glide™ oven rack

Fig. 4

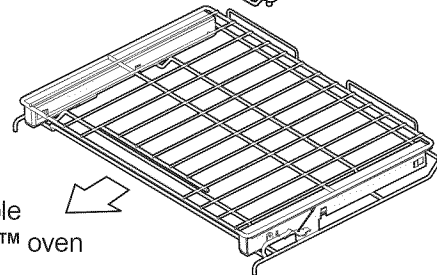

Flat oven racks may be used for most cooking needs and may be placed in most oven rack positions.

The **offset oven rack** (some models, see Figure 3) provides additional stepdown positions from the standard flat rack design. The offset design positions the base of the rack about 1/2 of a rack position lower than the flat rack and may be used in most oven rack positions.

The fully extendable **Luxury-Glide™** oven rack (see Figure 4) allows you to effortlessly extend your food away from the oven. See **Removing and Replacing the Luxury-Glide™ Oven Racks** for instructions.

Luxury Glide™ oven racks

➔ IMPORTANT

Remove **ALL oven racks** before starting a self-clean cycle. If oven racks are left inside the oven during a cleaning cycle, the slide ability of the **Luxury-Glide™** oven racks may be damaged and all of the oven racks will lose their shiny finish. Clean oven racks according to the instructions provided in the **Care & Cleaning** section.

The fully extendable **Luxury-Glide™** rack makes food preparation easier. This oven rack has glide tracks that allow the rack to be pulled away from the oven without rubbing the sides of the oven wall.

Removing and replacing the Luxury-Glide™ oven racks

To remove - Using one hand, reach through handle opening and lift up on the release lever located across the lower front of the rack as shown in Figure 1.

While holding up the release lever, pull the glide rack out of the oven until the stop position is reached (see Figure 2). Using both hands, grasp the upper and lower portions of the glide rack. Lift up the front of the rack slightly and continue to pull the rack away from the oven (see Figure 3). Be sure to grasp both upper and lower rack portions together when removing or handling the glide rack. The rack portions move independently and are difficult to handle unless held together.

To replace - grasp both upper and lower portions of glide rack, lift and hold the rack level between the oven cavity walls. Tilt the front of the rack upward slightly and slide the rack completely into position. Some force may be necessary to make sure the oven rack has snapped completely into place.

➔ IMPORTANT

To prevent possible damage to the oven, **DO NOT** attempt to close the oven door until all the oven racks are fully positioned back inside the oven cavity.

Luxury-Glide™ extendable oven rack

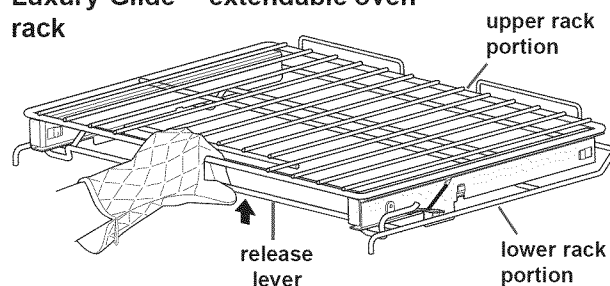

Fig. 1

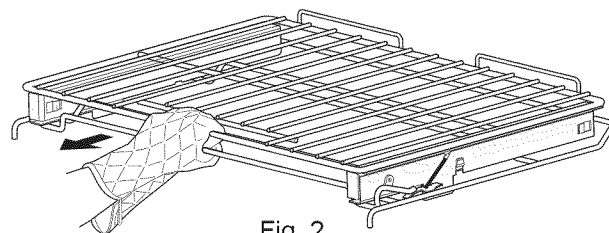

Fig. 2

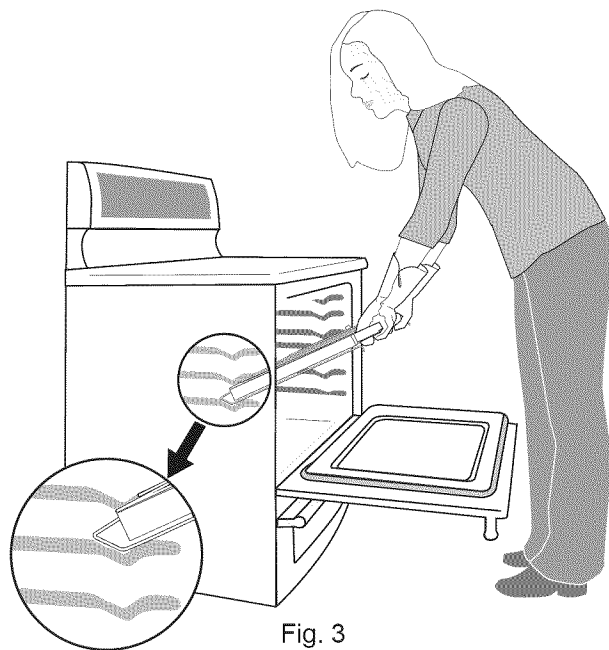
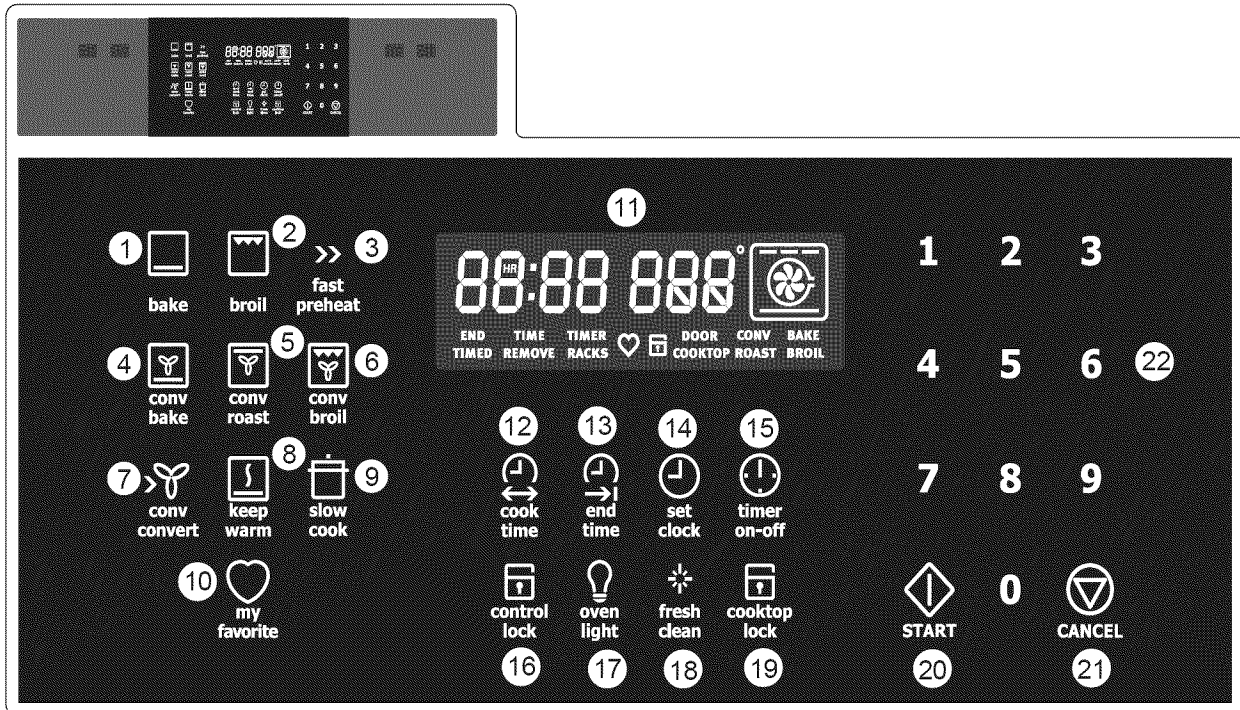

Fig. 3

Oven control display and keys



- | | |
|-----------------------|------------------------------|
| 1. Bake | 12. Cook Time |
| 2. Broil | 13. End Time |
| 3. Fast Preheat | 14. Set Clock |
| 4. Convection Bake | 15. Oven Timer |
| 5. Convection Roast | 16. Control Lock |
| 6. Convection Broil | 17. Oven Light |
| 7. Convection Convert | 18. Fresh Clean (self-clean) |
| 8. Keep Warm | 19. Cooktop Lock |
| 9. Slow Cook | 20. Start |
| 10. My Favorite | 21. Cancel |
| 11. Oven display | 22. Numeric Key Pad |

Minimum & maximum control settings

Feature	Min. temp	Max. temp
Fast Preheat	170°F / 76°C	550°F / 288°C
Bake	170°F / 76°C	550°F / 288°C
Broil	400°F / 205°C	550°F / 288°C
Conv Bake	170°F / 76°C	550°F / 288°C
Conv Roast	170°F / 76°C	550°F / 288°C
Conv Broil	400°F / 205°C	550°F / 288°C
Keep Warm	150°F/66°C	190°F/88°C
Slow Cook	Lo (225°F / 108°C) Hi (275°F / 135°C)	

Minimum & maximum time settings

Feature	Min. time	Max. time
Timer	1 min	11 hr 59 min
Clock 12 hr	1:00 hr	11 hr 59 min
Clock 24 hr	0:00 hr	23 hr 59 min
Cook time 12 hr	1 min	11 hr 59 min
End time 12 hr	1:00 hr	12 hr 59 min
End time 24 hr	0:00 hr	23 hr 59 min
Clean duration	(2 hr)	(4 hr)

20 Setting Oven Controls



Setting the clock

When the appliance is powered up for the first time or when the electric supply to the appliance has been interrupted, the display will **flash** "12:00" (Figure 1).



Fig. 1

To set the clock for 1:30:

Example	
Step	Press
1. Press set clock .	
2. Enter 130 using the numeric keypad.	130
3. Press START to accept.	

NOTES

- Be sure to set the clock with the **correct** time of day before using the oven, especially cooking with added time instructions.
- The clock cannot be adjusted when the oven is cooking, when the timer is active or during self-clean.
- If an invalid time of day is entered, the control will sound a triple beep (error tone). Re-enter a valid time of day and press **START**. If **CANCEL** is pressed the clock will set for **12:00**.

Changing clock display mode

The oven control is factory preset to display the time of day with a 12-hour clock setting. The display can be changed to provide the time of day using a 24-hour clock display or the clock display may be turned OFF.

When the clock display is turned OFF, the clock continues to run in the background on the previously chosen 12-hour or 24-hour mode.

To change clock display modes:





Example	
Step	Press
1. Press and hold set clock for 6 seconds.	
2. Press set clock to toggle between "12 Hr dAY", "24 Hr dAY" or "CLO OFF" display choices. Release keypad when the desired mode appears (Figures 1, 2 and 3).	 
3. Press START to accept.	



Fig. 1

Fig. 2



Fig. 3

NOTE

- The clock display mode cannot be modified when the oven is active with any cooking function or during self-clean.

Changing oven temperature display mode (°F or °C)

The oven control is factory preset to display oven temperatures with Fahrenheit (°F) values. The control may be changed to display either Fahrenheit or Celsius (°C) temperatures.

To change the temperature display mode:



Example	
Step	Press
1. Press and hold broil key for 6 seconds. Release when "F" or "C" appears in display.	
2. Press broil to toggle between "F" or "C" temperature display choices. Release key when desired mode appears in display (Figures 1 and 2).	
3. Press START to accept.	



Fig. 1



Fig. 2

NOTE

The temperature display mode cannot be modified when the oven is active or once self-clean is set.

Changing between 12-Hour Energy Saving or continuous bake mode settings

The oven control is factory preset for a 12-Hour Energy Saving mode. This setting automatically turns the oven off after 11 hours and 59 minutes of continuous cooking. The control may be set to override this feature.

To change between 12-Hour Energy Saving or continuous bake settings:



Example	
Step	Press
1. Press and hold timer on-off key for 6 seconds.	
2. Press timer on-off to choose between "12 Hr OFF" (Figure 3) or "StAY On" (Figure 4). Release key.	
3. Press START to accept.	



Fig. 3



Fig. 4

NOTE

Changing between the 12-Hour Energy Saving or continuous bake mode will not change how the cooktop controls operate.

22 Setting Oven Controls

Adjusting tone volume

A tone will sound when a key is pressed and at the end of a cycle (**timer**, **cook time** or **end time**). The factory audio setting is preset to the highest level (5). The control may be adjusted for lower levels 1 through 5, or OFF.

To adjust audio tone level:



Example	
Step	Press
1. Press and hold end time for 6 seconds (AUD will appear on left side of display window) then release keypad.	
2. To toggle through the available audio levels press and continue to press end time . When the level you prefer is displayed release the keypad. Level 5 is the highest setting - <i>Fig. 1</i> -, 1 is the lowest setting - <i>Fig. 2</i> - and AUD OFF - <i>Fig. 3</i> -will provide a silent control setting.	
3. Press START to accept.	



Fig. 1



Fig. 2



Fig. 3

NOTES

When the control is set for **Aud OFF**, error tones will remain audible.

Cooktop lock

The cooktop lock will lockout the cooktop control keypads. This feature does **not lock** the oven controls or lock the oven door. To lock the oven controls use the control lock feature.

Examples

Step Press

To activate the cooktop lock:

Press and hold **cooktop lock** key for 3 seconds. Once locked, "**cooktop**" and lock icon will appear in the display (*Figure 1*). The four cooktop power level display windows will show "--" (*Figure 2*).



cooktop lock

To cancel the cooktop lock feature:

Press and hold **cooktop lock** key for 3 seconds. Once unlocked, "**cooktop**" and lock icon will no longer appear in the display.



cooktop lock

If an element is still hot when cooktop lock is activated, "**HE**" will appear in the control panel instead of "--" (*Figure 3*).



Fig. 1

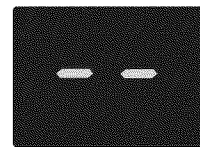

Fig. 2



Fig. 3

NOTES

- If the cooktop lockout key is pressed when cooktop is active, the cooktop will turn OFF and lock.
- If a cooktop control key is pressed when the cooktop lock is active, the control will sound an error tone (triple beep) indicating the cooktop is not available until cooktop lockout is canceled.

Oven control lock

The control lock will lock the oven controls and the oven door. This feature does **not lock** the cooktop controls. To lock the cooktop controls use the cooktop lock feature.

Examples

Step	Press
------	-------

To activate the control lock:

Press and hold **control lock** key for 3 seconds. "**door Loc**" will appear in the display until the oven door is locked.



control lock

To cancel control lock:

Press and hold **control lock** key for 3 seconds. Once the oven door is unlocked, the "**door Loc**" message will no longer display (*Figure 1*).



control lock



Fig. 1

NOTES

- To avoid possible damage to the oven door locking mechanism, do not attempt to force the oven door open when the **door Loc** message is displayed.
- If an oven control key is pressed when oven lock is active, the oven will sound an error tone (triple beep) indicating the function is not available until the control lock feature is turned off.

Timer

The timer may be used to help time cooking or food preparation times without interfering with any active cooking process. When the timer countdown reaches less than 1 minute, the display will show time remaining in seconds. When the time runs out the timer will beep, "**End**" will display..

Timer settings:

- Minimum set time: 1 minute
- Maximum set time: 11 hours 59 minutes

How to set the timer for 5 minutes:

Example

Step	Press
------	-------

1. Press **timer on-off**.



2. Enter **5** minutes using numeric keypad.

5

3. Press **start**.



To cancel an active timer at anytime, press the **timer on-off** keypad.

NOTES

- The timer **does not** start or stop the cooking process. The timer may be started alone or with any other active oven feature.
- The timer will display hours and minutes until 1 hour remains. When less than 1 hour remains, the display will count down in minutes and seconds. Once the timer has less than 1 minute remaining, only seconds will display.
- If both the oven and timer are active, the timer information will display by default. To momentarily display information for any other active oven feature, press the corresponding key once for the other feature.

24 Setting Oven Controls

Fast preheat

Use the fast preheat option for single rack baking to quickly bring the oven to baking temperature. The fast preheat option must be set using the **bake** or **conv bake** feature. Fast preheat may be set with **cook time** or cook time with an **end time**. The following oven temperature settings apply for fast preheat:





- Factory default temperature: 350°F/176°C
- Minimum fast preheat setting: 170°F / 77°C
- Maximum fast preheat setting: 550°F / 288°C



For best results

- **Recommended for single oven rack cooking ONLY.** Use oven rack position 2 or 3.
- For batter and dough-based baked goods such as cakes, pastries, and breads, use the standard bake function for best results.

To set fast preheat using the default oven temperature:

Example	
Step	Press
1. Press bake or conv bake .	 or 
2. Press fast preheat .	
3. Press START .	

When activated, the oven will begin preheating and "PRE" will appear in the display (-Fig. 1-).

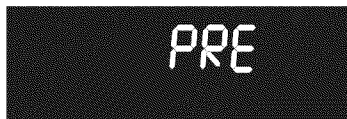





Fig. 1

A tone will sound indicating the oven has finished preheating. Place prepared food inside oven using a **single** oven rack.

To stop preheating at any time press **CANCEL**.

How to set fast preheat with the oven temperature set for 425°F/ 218°C):

Example	
Step	Press
1. Press bake or conv bake	 or 
2. Enter 4 2 5 using numeric keypads	4 2 5
3. Press fast preheat	
4. Press START	

To stop **fast preheat** at any time press **CANCEL**.

NOTES

- The convection fan **will rotate** when fast preheat is started. This is normal. If fast preheat is set with the bake feature the convection fan will turn off once the oven set temperature is reached.
- To change temperature settings **after** fast preheat has started, press **bake** key, enter the desired temperature with the numeric keypad, and press **START** to accept.
- To change cooktime settings **after** fast preheat has started, press **cooktime** key, enter the desired time with the numeric keypad, and press **START** to accept.

IMPORTANT

Once the oven has fully preheated, the **fast preheat** feature will perform like bake and continue to bake until cancelled.

Bake

Use **bake** to cook most food items that require normal cooking temperatures. Bake may be set with the following options:

- Fast preheat
- Cook time and Cook time with end time setting

The following oven temperature settings apply to the **bake** feature:

- Factory default bake setting: 350°F/176°C
- Minimum bake setting: 170°F / 77°C
- Max. bake setting: 550°F / 288°C

To set the oven for **bake** at the factory default oven temperature of 350°F (176°C):



Example	
Step	Press
1. Press bake . The default oven temperature of 350°F will appear in the display.	
2. Press START (Figure 1).	



Fig. 1



Once **bake** is active the oven will begin preheating. When the oven reaches set temperature the control will sound a tone indicating the oven is ready.

To stop **bake** at any time press **CANCEL**.

CAUTION

- Always use pot holders or oven mitts when working with a hot oven. When cooking, the oven interior, oven racks and cooktop will become **hot** enough to cause burns.
- **Do not cook foods directly on the oven bottom.** To avoid damaging the oven interior and surfaces, always cook foods in the oven using cookware positioned on an oven rack.

To set **bake** with the oven temperature set for 425°F/ 218°C):

Example	
Step	Press
1. Press bake	
2. Enter 4 2 5 using numeric keypad	425
3. Press START	

To stop **bake** at any time press **CANCEL**.

NOTES

- The convection fan **will rotate** when **bake** is first started. This is normal. The fan will turn off once the oven reaches the set temperature.
- A **cook time** setting may be added any time after starting **bake**. Refer to the **cook time** section for complete instructions.
- If **bake** is active without a **cook time** setting, the oven will remain on for 12 hours before automatically turning off unless cancelled. If you wish to **bake** for longer than 12 hours, see "Changing between 12-Hour Energy Saving or continuous **bake** mode settings" for instructions.

26 Setting Oven Controls

Bake (cont'd)



For best results

- Fully preheat the oven before baking items like cookies, biscuits and breads.
- When using any single rack, position the rack so that the food is in the center of the oven.
- For best results when baking cakes using 2 oven racks, place racks in positions 2 and 4 (*Figure 1*). Use the Luxury Glide™ rack in position 4.
- When baking using 2 oven racks, position cookware as shown in *Figure 2*. Allow at least 2 inches (5 cm) of space between cookware for proper air circulation.
- Dark or dull pans absorb more heat than shiny bakeware, resulting in dark or overbrowning of foods. It may be necessary to reduce the oven temperature or cook time to prevent overbrowning of some foods. Dark pans are recommended for pies. Shiny pans are recommended for cakes, cookies and muffins.
- For batter and dough-based baked goods such as cakes, pastries, and breads, use the convection bake function for best results.

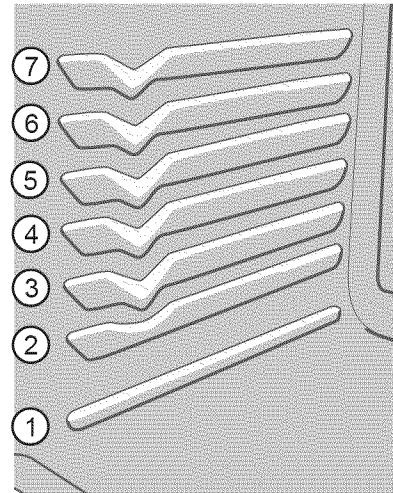

Fig. 1

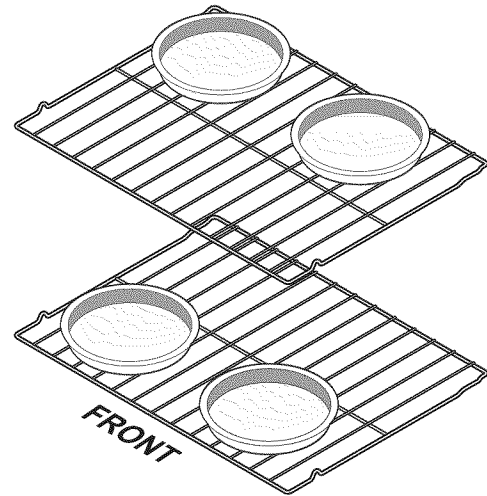

Fig. 2

Cook time

The cook time feature is used when a recipe calls for a specific temperature and cook time. Following the recipe's suggested cook time can help ensure the best possible results.

The maximum cook time setting is 11 hours, 59 minutes. Cook time instructions may be set with the following features:

- Bake
- Conv bake
- Conv roast
- Slow cook
- Keep warm
- Fast preheat
- My favorite

To bake for 30 minutes with the oven default temperature setting of 350°F (176°C):





Example	
Step	Press
1. Press cook time .	
2. Enter 30 using numeric keypads.	30
3. Press START .	
4. Press bake .	
5. Press START (Figure 1).	



Fig. 1

Once active, the oven display will show "TIMED" and "BAKE" (Figure 1). The oven will cook at the set temperature for 30 minutes and then automatically shut-off.

When the cook time runs out:

"End" will appear in the display window and the oven will shut-off automatically (Figure 2). The control will beep 3 times every 30 seconds until the cancel keypad is pressed.

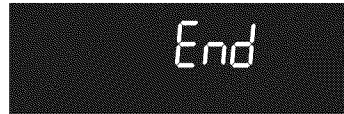

Fig. 2

To stop cooking at any time press **CANCEL**.

WARNING

FOOD POISONING HAZARD. Do not let food sit for more than one hour before or after cooking. Doing so can result in food poisoning or sickness.

NOTES

- When cooking with a cook time setting, press the active **cook time** key once to momentarily display any remaining cook time.
- When cooking with cook time settings, the cook time may be removed at anytime by setting a new cook time of **0:00**.
- **Cook time** settings cannot be added to the broil or self-clean features.

Setting cook time with end time

Adding a cook time with a specific end time gives the same benefits as the cook time option in addition to controlling exactly when the cooking process will begin and end.

Cook time and end time instructions may be set with the following features:

- Bake
- Conv bake
- Conv roast
- Slow cook
- Keep warm

▶ IMPORTANT

Before setting **end time** instructions, be sure the time of day is correct.

To set the oven to bake at 375°F (191°C) for 50 minutes and to automatically shut-off at 5:30:







Example	
Step	Press
1. Press cook time .	
2. Enter 50 minutes using numeric keypads.	50
3. Press START .	
4. Press end time .	
5. Enter 530 using numeric keypads.	530
6. Press start .	
7. Press bake (Figure 1).	
8. Enter 375 using numeric keypads.	375
9. Press START to activate.	



Fig. 1

Once **START** is pressed, the oven will calculate the delayed start time. Once the delayed start time has passed, the oven will automatically turn on and heat to the set temperature. The oven will continue to maintain this temperature during the set cook time until reaching the set end time.

When the cook time runs out:

"**End**" will appear in the display window and the oven will shut-off automatically (Figure 2). The control will beep 3 times every 30 seconds as a reminder until the **CANCEL** keypad is pressed.

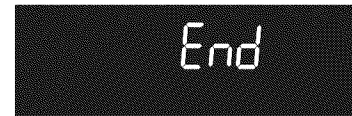

Fig. 2

To stop cooking at any time press **CANCEL**.

⚠ CAUTION

Use caution when preparing foods with **cook time** or **end time** instructions. Foods that can easily spoil such as milk, eggs, fish, meat or poultry, should be chilled in the refrigerator first. Even when chilled, they should not stand in the oven for more than 1 hour before cooking begins, and should be removed promptly when done.

🗨 NOTES

- An **end time** setting may be set with **fresh clean**. Refer to the fresh clean section for details on how to select different clean cycle times.
- The **end time** setting may be added to the **fast preheat**, **conv bake** or **conv convert** features. An **end time** setting cannot be added to **broil**.
- Once the **end time** feature has started the cooking process, press the **cook time** keypad once to display any cook time remaining.

Broil

Use the broil feature to cook meats that require direct exposure to radiant heat for optimum browning results.

The following oven temperature settings apply to the broil feature:

- Factory default temperature: **550°F / 288°C**
- Min. broil setting: **400°F / 205°C**
- Max. broil setting: **550°F / 288°C**

WARNING

Should an oven fire occur, **close the oven door**. If the fire continues, throw baking soda on the fire or use a fire extinguisher. **Do not** put water or flour on the fire. Flour may be explosive and water can cause a grease fire to spread and cause personal injury.

CAUTION

- **Always** use **pot holders** or **oven mitts** when working with a hot oven. When broiling, the oven interior, oven racks and cooktop will become **hot** enough to cause burns.
- **Do not** use the broiler pan without the insert.
- **Do not** cover the broil pan/insert with aluminum foil; the exposed grease could ignite.
- To prevent food from contacting the broil element and to prevent grease splattering, **do not** use the roasting rack when broiling.

For best results

- For optimum browning results, allow the oven to preheat **5-6 minutes** before placing meat in the oven.
- To avoid burning food, watch the food carefully when broiling and turn meat when needed.
- Use the recommended pans and oven rack positions for the type and amount of meat being prepared. See *Broiling Table on the next page*.

To set broil with the factory default temperature setting of **550°F / 288°C**:



Example	
Step	Press
1. Place the broiler insert on the broiler pan, then place the meat on the insert. Remember to follow all warnings and cautions.	
2. Arrange the interior oven rack to rack position recommendations. See <i>Figures 3 and 4 on the next page</i> . Be sure to place the pan with meat directly under broil element. Leave the oven door open slightly (about 4 inches) in the broil position. See <i>Figure 2 on the next page</i> .	
3. Press broil .	
4. Press START .	
5. Turn meat when desired doneness for first side is obtained.	



Fig. 1

Once activated, the oven display will show "BROIL" (*Figure 1*) and will broil at the set temperature until cancelled.

To stop broil at anytime press **CANCEL**.

30 Setting Oven Controls

Broil (con't)

The broil pan insert has slots that allow grease and fat from the meat to drain into the broil pan. Place prepared meat on broil pan insert and then place onto broiler pan as shown in *Figure 1*.

Recommended broiling times

Use the broiling table (*Figure 4*) for approximate recommended broiling times for the types of meats listed. Increase or decrease broiling times, or move the broiling pan to a different rack position to suit for doneness.

If the food you are broiling is not listed in the table, follow the instructions provided in your recipe and watch the item closely.

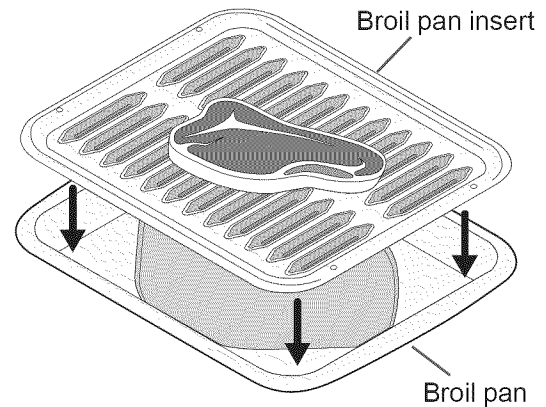
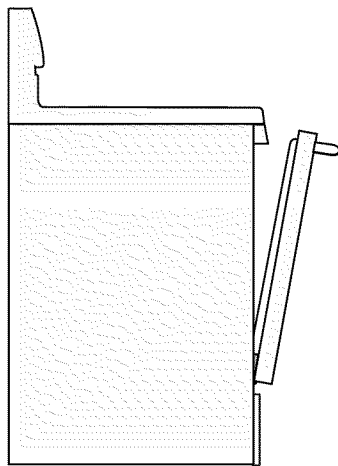

Fig. 2



Oven door in broil position
Fig. 1

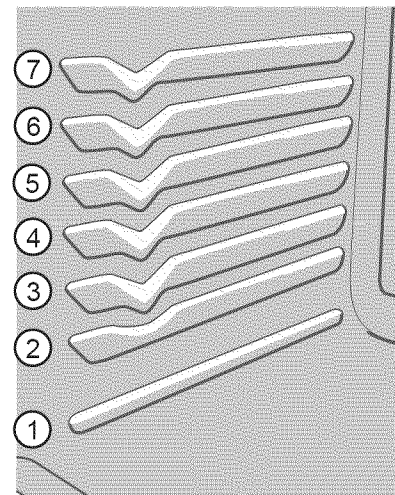

Fig. 3

Broiling Table

Food	Rack position	Temp	Cook time in minutes		Doneness
			1st side	2nd side	
Steak 1" thick	5th or 7th*	550°F	6	4	Medium
Steak 1" thick	6th or 7th*	550°F	7	5	Medium-well
Steak 1" thick	6th or 7th*	550°F	8	7	Well
Pork chops 3/4" thick	6th	550°F	8	6	Well
Chicken-bone in	5th	450°F	20	10	Well
Chicken-boneless	6th	450°F	8	6	Well
Fish	6th	500°F	13	n/a	Well
Shrimp	5th	550°F	5	n/a	Well
Hamburger 1" thick	7th*	550°F	9	7	Medium
Hamburger 1" thick	6th	550°F	10	8	Well

*Use the off-set rack if you choose to use oven rack position 7.

Fig. 4

Conv bake

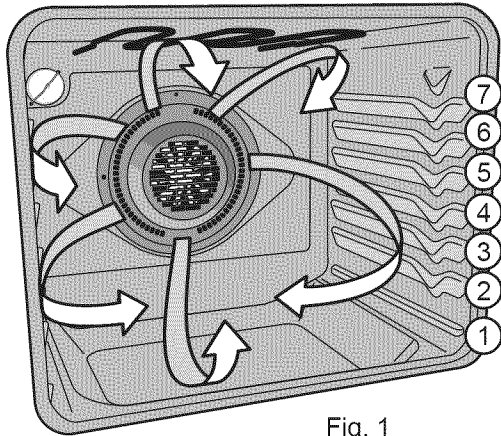

Fig. 1

Convection (conv) bake uses a fan to circulate the oven heat evenly and continuously (Figure 1). The improved heat distribution allows for even cooking with excellent results. Multiple rack cooking may slightly increase cook times for some food types, but the overall result will be time saved.

The conv bake feature should only be used when your recipe instructions have been written especially for convection baking.

If your recipe instructions are for baking and you wish to use conv bake, follow the **conv convert** option instructions. The conv convert option will automatically adjust the oven temperature so that convection baking will provide the best possible results.

Benefits of conv bake:

- **Superior multiple oven rack performance.**
- Foods cook more evenly.
- No special pans or bakeware required.

Conv bake may be set with the following options:

- Conv convert
- Fast preheat
- Cook time or cook time with end time settings

The following temperature settings apply to the conv bake feature:

- Factory default setting: 350°F/176°C
- Min. bake setting : 170°F / 76°C
- Max. bake setting: 550°F / 288°C

To set conv bake with the factory default temperature setting of 350°F (176°C):

Example	
Step	Press
Preheat the oven if needed.	
1. Press conv bake .	
2. Press START .	

When activated, the control display will show "**CONV BAKE**" (Figure 2) and the oven will begin heating. Once the oven reaches the set temperature a tone will sound indicating the oven is ready.

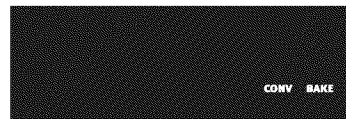

Fig. 2

To stop conv bake at anytime press **CANCEL**.

Conv bake (cont'd)



For best results

- Fully preheat the oven before baking items like cookies, biscuits and breads.
- When using any single rack, position the rack so that the food is in the center of the oven.
- For best results when baking cakes using 2 oven racks, place racks in positions 2 and 4 (*Figure 1*). Use the Luxury Glide™ rack in position 4.
- When baking using 2 oven racks, position cookware as shown in *Figure 2*. Allow at least 2 inches (5 cm) of space between cookware for proper air circulation.
- Dark or dull pans absorb more heat than shiny bakeware, resulting in dark or overbrowning of foods. It may be necessary to reduce the oven temperature or cook time to prevent overbrowning of some foods. Dark pans are recommended for pies. Shiny pans are recommended for cakes, cookies and muffins.
- Cookies and biscuits should be baked on pans with no sides or very low sides to allow heated air to circulate around the food.

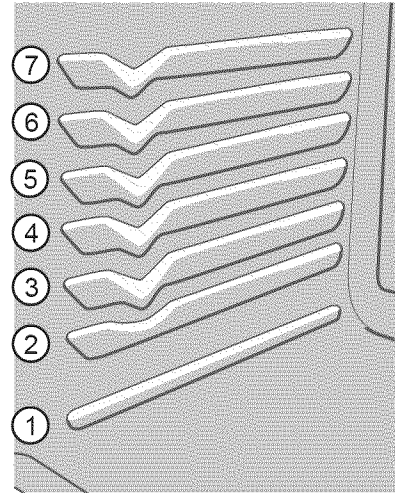

Fig. 1

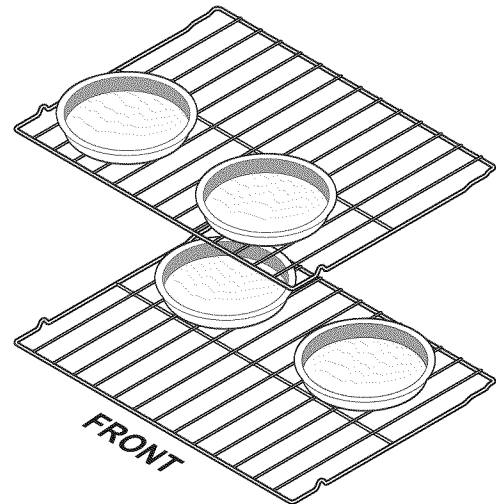

Fig. 2



Conv convert

The convection (conv) convert feature allows you to convert any normal baking recipe into a convection bake recipe. The control uses the normal recipe settings and adjusts to a lower temperature for convection baking. Conv convert must be used with conv bake. Conv convert may be set with cook or end time instructions.

Benefits of conv convert:

- Superior multiple oven rack performance.
- Some foods cook faster, saving time and energy.
- No special pans or bakeware required.

To set conv convert with the factory default oven temperature of 350°F (176°C):

Example	
Step	Press
1. Press conv bake .	
2. Press conv convert .	



Fig. 1





When activated, the control display will show "CONV BAKE" (Figure 1) and the oven will begin heating. Once the oven reaches the set temperature a tone will sound indicating the oven is ready.

To stop conv convert at anytime press **CANCEL**.

NOTES

- When using **conv convert**, cook time reductions may vary depending on the oven set temperature.
- **Conv convert reduces original temperatures by 25°F (14°C).**
- The conv convert feature will work best if the **cook time** is 20 minutes or longer. If a cooktime is set that is less than 20 minutes, the feature will not provide a "CF" (check food) message.

To set conv convert for 30 minutes with a temperature setting of 375°F (191°C):

Example	
Step	Press
1. Press cook time .	
2. Enter 30 using numeric keypad.	30
3. Press START .	
4. Press conv bake .	
5. Enter 375 using numeric keypad.	375
6. Press conv convert .	

When conv convert is used with cook time or end time settings, the conv convert feature will display a "CF" for **check food** when the cook time is 75% complete (Figure 2). At this time the oven control will provide 1 long tone at regular intervals until the set cook time has finished or conv convert is canceled.

To stop conv convert at anytime press **CANCEL**.



Fig. 2



For best results



- Follow the rack placement and pan position recommendations in the **Convection Bake** section of this Use and Care Guide.

34 Setting Oven Controls

Conv broil

Use the convect broil feature to cook thicker cuts of meats that require direct exposure to radiant heat and the convect fan for optimum browning results.

To set convect broil with a default oven set temperature of 550°F (288°C):

Example	
Step	Press
1. Press conv broil key.	
2. Press START to accept.	

The convect fan will begin rotating once conv broil has been activated.

To stop convect broil at any time press **CANCEL**.



For best results

- Be sure to carefully follow all the recommended broil pan and insert instructions and the directions for placing the oven racks as provided in the **broil** section.
- Since **convect broil** cooks food faster, reduce the cook time by 25% from the recommended cook time of your recipe (check the food at this time). If necessary, increase cook time until the desired doneness is obtained.
- **Close the oven door** when using convect broil.

Conv roast

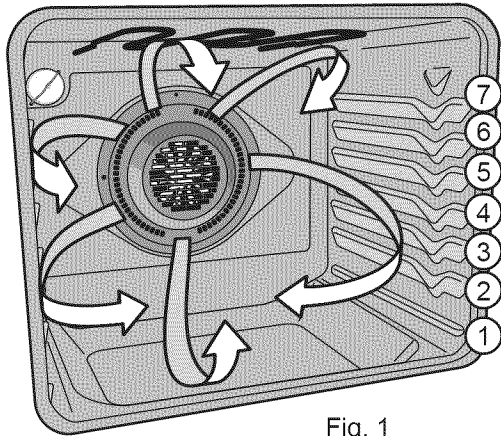

Fig. 1

How conv roast works

Convection (conv) roast combines a cook cycle with the convection fan and element to rapidly roast meats and poultry. Heated air circulates around the meat from all sides, sealing in juices and flavors. Meats cooked with this feature are crispy and brown on the outside while staying moist inside. There is no need to reduce the oven temperature when using conv roast.

Conv roast may be set with the following options:

- Cook time
- Cook time with end time

The following oven temperature settings apply for conv roast:

- Factory default temperature: 350°F/176°C
- Min. conv roast setting: 170°F / 76°C
- Max. conv roast setting: 550°F / 288°C

Benefits of conv roast:

- Superior multiple oven rack performance.
- Some foods will cook faster, saving time and energy.

To set conv roast with the factory default oven temperature setting of 350°F (176°C):

Example	
Step	Press
1. Press conv roast .	
2. Press START	

When activated, the control display will show "**CONV ROAST**" and the oven will begin heating. Once the oven reaches the set temperature a tone will sound indicating the oven is ready



Fig. 2

To stop conv roast at anytime press **CANCEL**.



For best results

- Preheating for conv roast will not be necessary for most meats and poultry.
- Place food items on rack positions 1, 2, or 3, keeping food in center of the oven cavity (see *Figure 1*).
- Since **conv roast** cooks faster, reduce cook times by 25% from the recommended time of your recipe (check the food at this time). Then if needed, increase cook time until the desired doneness is obtained.
- Place food items using the recommended rack positions for the type of food being prepared.
- Be sure to carefully follow your recipe's temperature and time recommendations or refer to the conv roast recommendations for additional information. *See Figure 2 on the next page.*
- Do not cover foods when dry roasting - covering will prevent the meat from browning properly.

Conv roast (cont'd)

When preparing meats for conv roast, you should use the broiler pan and insert. The broiler pan will catch grease spills and the insert will help prevent grease splatters.

1. Place oven rack on bottom or next to the bottom oven rack position.
2. Place the insert on the broiler pan.
3. Be sure the insert is securely seated on top of the broiler pan. **Do not** use the broiler pan without the insert. **Do not** cover the insert with aluminum foil.
4. Place meat (fat side up) on insert (*Figure 1*). Place prepared food on oven rack and slide into the oven.

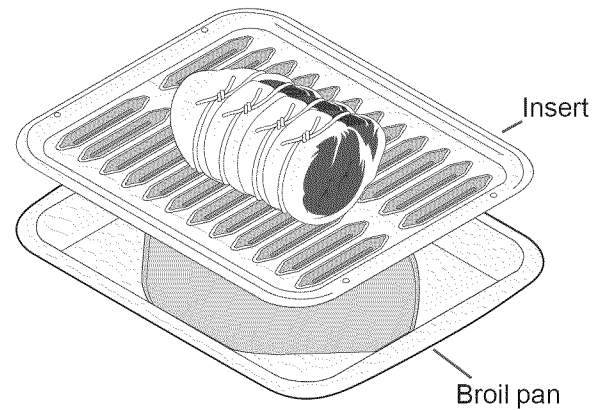

Fig. 1

Conv Roast Setting Suggestions					
Meat		Weight	Oven temp	Internal temp	Minute per lb.
Beef	Standing rib roast	4 to 6 lbs.	350°F	*	25-30
	Rib eye roast	4 to 6 lbs.	350°F	*	25-30
	Tenderloin roast	2 to 3 lbs.	400°F	*	15-25
Poultry	Turkey, whole**	12 to 16 lbs.	325°F	180°F	8-10
	Turkey, whole**	16 to 20 lbs.	325°F	180°F	10-15
	Turkey, whole**	20 to 24 lbs.	325°F	180°F	12-16
	Chicken	3 to 4 lbs.	350°F -375°F	180°F	12-16
Pork	Ham roast, fresh	4 to 6 lbs.	325°F	160°F	30-40
	Shoulder blade roast	4 to 6 lbs.	325°F	160°F	20-30
	Loin	3 to 4 lbs.	325°F	160°F	20-25
	Pre-cooked ham	5 to 7 lbs.	325°F	160°F	30-40

Fig. 2

* For beef: medium 160°F, well done 170°F.

** Stuffed turkey requires additional roasting time. Shield legs and breast with foil to prevent overbrowning and drying of the skin.

Keep warm

Use the keep warm feature to keep hot foods warm. Keep warm may be set with the following options:

- Cook time
- Cook time with end time



The following temperature settings apply to the keep warm feature:

- Auto-suggest (default) setting: 170°F / 76°C
- Minimum keep warm setting: 150°F / 66°C
- Maximum keep warm setting: 190°F / 88°C



WARNING

- **FOOD POISONING HAZARD. Do not let food sit for more than one hour before or after cooking. Doing so may cause bacteria to grow which can result in food poisoning or sickness.**
- To prevent food from contacting the broil element and to prevent grease splattering, **do not** use the roasting rack when broiling.

To set keep warm with the default setting:

Example	
Step	Press
1. Press KEEP WARM	
2. Press START	

To set keep warm with a setting of 150°F:

Example	
Step	Press
1. Press KEEP WARM	
2. Enter 150 using numeric keypad.	150
3. Press START	

If changing cooking times, select the **cook time** or **end time** keys needed to make the changes.

To end keep warm at any time, press **CANCEL**.

Slow cook

The slow cook feature is used to cook foods slowly using lower temperatures. The cooking results will be much like that of a slow cooker. This feature is ideal when roasting beef, pork or poultry.

Slow cook may be set with the following options:

- Cook time
- Cook time with end time

The following temperature settings apply to the slow cook feature:

- High: 275°F / 134°C use for cooking 4 to 5 hours
- Low: 225°F / 108°C use for cooking 8 to 9 hours



For best results

- Completely thaw all frozen foods before cooking.
- When using a single oven rack, place in oven rack position 2 or 3.
- Position multiple racks to accommodate size of cooking utensils when cooking multiple food items.
- Add any cream or cheese sauces during the last hour of cooking.
- **Do not frequently open** the oven door or leave the oven door open when checking food items. The more heat that is lost, the longer the food will need to cook.
- Cover foods to keep them moist or use a loose or vented cover to allow foods to turn crisp or brown.
- Roasts may be left uncovered so browning can occur. Cook times will vary depending on the weight, fat content, bone & the shape of the roast.
- Preheating the oven is not necessary.

To set slow cook with low setting:

Example	
Step	Press
1. Position oven racks and cookware in oven. Close the oven door.	
2. Press slow cook key. Hi will appear in the oven display indicating the default setting is for high (<i>Figure 1</i>). If a low setting is needed, press slow cook again to select the Lo setting (<i>Figure 2</i>) and release.	
3. Press START .	



Fig. 1



Fig. 2

To stop **slow cook** at any time press **CANCEL**.

To add or change any cook settings after slow cook has started:

- Press **slow cook** key. To change the setting, press the **slow cook** key again to toggle between the Hi or Lo setting and release. Press **START** to accept change.
- If changing cooking times, select the **cook time** or **end time** keys to make the needed changes.



NOTE







Slow cooking meats may result in the exterior of meats becoming dark; this is normal.

My favorite



The **my favorite** feature may be used to store and recall a favorite recipe setting. This feature will only store or recall one favorite recipe at a time.

My favorite feature may be used with **bake, cook time, conv bake, conv roast** and **keep warm** cooking features. This feature will not work with any other feature including end time, broil or self clean.

To save and store my favorite recipe settings (example shown to bake for 30 minutes with oven temperature of 325°F):

Example	
Step	Press
1. Press cook time .	
2. Enter 3 0 minutes using numeric keypads.	30
3. Press START .	
4. Press bake .	
5. Enter 3 2 5 oven temperature using numeric keypads.	325
6. Press START .	
7. To store, press and hold my favorite keypad for 3 seconds.	
If at this time you do not wish to start the oven with the newly stored recipe, be sure to press CANCEL .	

To use a saved favorite recipe setting:

Example	
Step	Press
1. Press my favorite key. The favorite icon will appear in the display (<i>Figure 1</i>).	
2. Press START .	

To erase a favorite recipe setting:

Example	
Step	Press
Press my favorite and hold until the favorite icon disappears from the display (<i>-Fig. 1-</i>).	

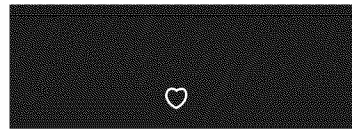

Fig. 1

NOTES

- If you do not wish the oven to automatically start the recipe when saving **my favorite**, be sure to press **CANCEL** for the last step.
- **my favorite** feature stores or recalls only one recipe at any time.
- If a different favorite recipe is needed, you may record a new recipe over the old. Or, any previously stored recipe may be erased before recording a new recipe by following the steps provided "To erase favorite recipe setting."

Adjusting the oven temperature

Your appliance has been factory calibrated and tested to ensure accurate baking temperatures. For the first few uses, follow your recipe times and temperature recommendations carefully. If you think the oven is cooking **too hot** or **too cool** for your recipe times, the control may be adjusted so the oven cooks hotter or cooler than the temperature displayed.



The oven temperature may be increased +35°F (+19°C) or decreased -35°F (-19°C) from the factory default settings.



For best results

Do not use oven thermometers such as those found in grocery stores to check the temperature settings inside your oven. These oven thermometers could vary as much as 20° to 40° from actual temperatures.

How to offset the oven temperature by +30°F:

Example	
Step	Press
1. Press and hold bake for 6 seconds. Release when acceptance tone sounds. "UPO" should appear in left side of display.	
2. Enter 3 0 using numeric keypad (Figure 1).	30
3. To accept change, press START .	

How to offset the oven temperature by -30°F:



Example	
Step	Press
1. Press and hold bake for 6 seconds. Release when acceptance tone sounds. "UPO" should show in left side of display.	
2. Enter 3 0 using numeric keypad (Figure 1).	30
3. Press bake to toggle to minus (Figure 2).	
4. To accept change, press START .	



Fig. 1

Fig. 2-

NOTE

Oven temperature adjustments made will not affect the broil or self-cleaning feature temperatures.

Sabbath mode

(for use on the Jewish Sabbath & Holidays)



For further assistance, guidelines for proper usage and a complete list of models with the Sabbath feature, please visit the web at <http://www.star-k.org>.

This appliance provides special settings for use when observing the Jewish Sabbath/Holidays. Sabbath mode disables all audible tones or visual display changes on the oven control. **BAKE** and **cooktop** heating are the only cooking features available while in the Sabbath mode.

You must first set the **BAKE** feature and temperature(s) needed for the oven, the **COOK TIME** option if needed, and any cooktop power levels before setting the Sabbath mode. Any settings made prior to setting the Sabbath mode will be visible in the displays. The **COOK TIME** option, if set prior to the Sabbath mode, will give one audible alert at the end of **COOK TIME**.

The Sabbath mode will override the factory preset 12-hour Energy Saving mode and the appliance will stay on until the cooking features are cancelled. If any of the cooking features are cancelled when the appliance is in the Sabbath mode, no audible or visual indicators will be available to verify the cancellation.

If the oven interior lights are needed, be sure to activate them prior to setting the Sabbath mode. Once the oven light is turned ON and the Sabbath mode is active, the oven light will remain on until the Sabbath mode is turned off and the oven lights are turned off. The oven door will not activate the interior oven lights when the oven door is opened or closed.

It is recommended that any oven temperature modification made within an active Sabbath mode be followed with 2 presses of the **START** key. This will ensure the oven remains ON even if an attempt is made to set the oven temperature outside of its temperature range. If the oven temperature is set outside of the temperature range, the oven will default to the nearest available temperature. Try to set the desired oven temperature again.

The cooktop settings may also be changed even after the appliance has been set for the Sabbath mode.

To set the oven for the Sabbath feature:

Example	
Step	Press
1. Be sure the clock is set with the correct time of day.	
2. Press bake .	
3. Enter desired temperature.	325
4. Press START .	
5. Enter cook time or end time settings, if needed. If not needed, skip this step and continue to step 7. Refer to the cook time or end time instructions.	
6. Enter the cooktop settings, if needed. If not needed, skip this step and continue to step 7. Refer to the surface cooking instructions.	
7. To enter Sabbath mode, press and hold both the cook time and end time keys together for 3 seconds. A beep will sound. Release the keys.	

Once properly set in Sabbath mode, SAb will show in the oven displays (Figure 1) and Sb will appear in all the individual cooktop displays (Figure 2) until the Sabbath mode is cancelled.



Fig. 1



Fig. 2



▶ IMPORTANT

Remember the oven will shut-off after completing a **cook time** or **end time** and therefore may only be used once during the Sabbath/Jewish Holidays. The maximum **cooktime** setting is 11 hours and 59 minutes.

42 Setting Oven Controls

Canceling Sabbath mode

To cancel Sabbath mode:

Example	
Step	Press
Press and hold both the cook time and end time keys for 3 seconds. A beep will sound. Release the keys.	 + 

All previously-set features in the oven and the cooktop will automatically cancel once Sabbath mode has ended.

NOTES

- The only keys available once the range is set to Sabbath mode are:



- You may change the oven temperature once baking has started.

- Press **bake**.
- Enter the desired temperature.
- Press **START**.

- To adjust cooktop settings, press + or - for the active cooktop elements.
- Remember that the oven control **will no longer beep or display any further changes** once the oven is set for the Sabbath feature.

WARNING

FOOD POISONING HAZARD. Do not let food sit for more than one hour before or after cooking. Doing so can result in food poisoning or sickness.

What to do after a power failure or power interruption when Sabbath feature is active:

Should a power failure or interruption occur during the Sabbath Holidays, the appliance will SHUT OFF. SF will appear in all control and surface displays indicating a Sabbath mode failure (Figures 1 and 2). Sabbath failure mode will remain and the oven will not work until Sabbath mode is cancelled (see "To cancel Sabbath mode" section).



Fig. 1



Fig. 2

After Sabbath mode is cancelled, Sabbath mode settings may be entered again (See "To set the oven for the Sabbath feature" section).

Restoring control to factory default settings

Your appliance is set with a number of predetermined oven control settings. Over time, you may make changes to the original factory settings.

The following functions or features have user-programmable options or adjustments that may have been changed from the default settings:

- Clock 12-hour or 24-hour display mode.
- 12-Hour Energy Savings or continuous bake mode.
- Tone volume.
- Oven temperature display mode (F° or C°).
- Any oven temperature adjustment made.
- Any saved "my favorite."

IMPORTANT

Before restoring, please be aware that **any previous changes** made to the oven control settings will be erased once the **START** keypad is pressed. This includes any temperature offset made for the oven when baking.

To restore to factory default settings:

Example



- | Step | Press |
|---|---|
| 1. Press and hold the number 7 key for 6 seconds. A beep will sound and "rST P S" will appear in the display (<i>Figure 1</i>). | 7 |
| 2. Press START to accept. |  |



Fig. 1

Interior oven light

The interior oven light will automatically turn ON when the oven door is opened.

Press  keypad to turn the interior oven light ON and OFF whenever the oven door is closed.

The interior oven light is located at the upper left rear wall of the oven interior and is covered with a glass shield held in place with a wire holder. The glass shield must be in place whenever the oven is in use.

To change the interior oven light, see "Changing the oven light" in the **Care & Cleaning** section.

Before starting fresh clean

Adhere to the following precautions before starting fresh clean (self-clean cycle):

- Remove **all items** from the oven and cooktop, including **food, cookware, utensils, plastic** and **any aluminum foil**. Aluminum foil will not withstand high temperatures generated during the self-clean cycle.
- Remove **all oven racks and accessories** from the oven interior to avoid possible damage. If the oven racks are not removed they may discolor. The Luxury Glide™ oven rack must be removed before starting self-clean to avoid damaging the glide ability of the rack. "Remove racks" will flash in the display for several seconds as reminder to remove the racks before starting a self-clean cycle (Figure 1).



Fig. 1

- Be sure the **oven vent area is clear**.
- Remove **all items** from the storage drawer.
- Be sure the oven light shield is in place. Turn off the oven light.
- **Remove any excess spills or loose debris.** Spills on the oven bottom should be wiped-up and removed **before starting self-clean**. To clean, use hot, soapy water and a cloth. Large food spillovers can cause heavy smoke or a fire during self-clean. Spills that have a high sugar or acid content (such as milk, tomatoes, sauerkraut, fruit juices or pie filling) may leave a dull spot even after self-cleaning.
- **Do not clean the oven door gasket** (Figure 2). Do not use any cleaning materials on the oven door gasket. Doing so may damage the gasket. The woven material of the oven door gasket is essential for a good seal. Care should be taken not to rub, damage or remove the door gasket.
- **Do not** use commercial oven cleaners or protective coatings of any kind inside oven. Residue from oven cleaners may damage the porcelain during the next self-clean cycle.



For best results

Clean any soil from the oven exterior. Clean using soap and water before starting a self-clean cycle. If soils are not removed, they may burn on due to the high temperatures during self-clean.

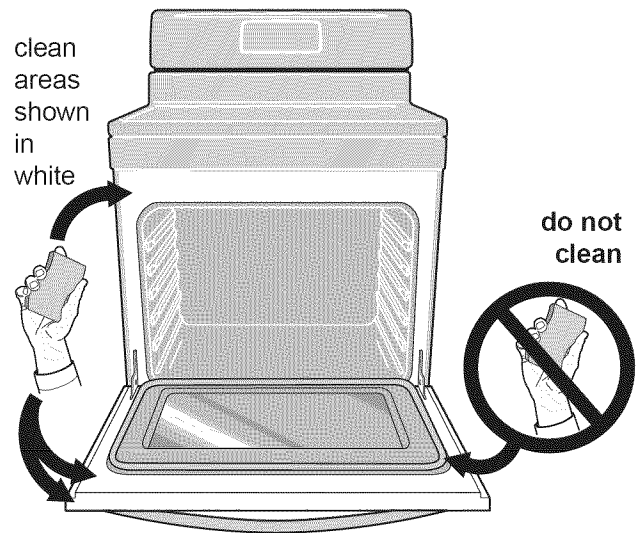

Fig. 2

⚠ WARNING

- **Do not touch** the oven during the self-clean cycle.
- **Keep children away from oven** during the self-clean cycle.
- Failure to follow these instructions can result in burns.

⚠ CAUTION

- The health of some birds is extremely sensitive to the fumes given off during the self-clean cycle of any range. Move birds to another well-ventilated room.
- **DO NOT** line the oven walls, oven racks, oven bottom or any other part of the range with aluminum foil. Doing so will stop heat distribution, produce poor baking results and may cause permanent damage to the oven interior. Aluminum foil will melt to a hot oven surface during self-clean.

Setting fresh clean

A self-cleaning oven automatically cleans itself using much higher temperatures than those used for cooking. The self-clean feature eliminates soils completely or reduces them to a fine powdered ash that you can later easily wipe away with a damp cloth.

Fresh clean combines self-clean with an added air freshening feature. The air cleaner will eliminate baked on food odors during self-clean but may not eliminate all odors. The air cleaner is not active for other oven functions.

▶ IMPORTANT

The first fresh clean cycle **will not be odor-free**. These odors are normal and are a result of the manufacturing process. It is recommended to ventilate the area. Open any windows and turn on an exhaust fan or overhead range hood (if available) during the fresh clean cycle.

The **fresh clean** feature provides 3 different clean time settings for self-cleaning. Set clean for 2 hours for light, 3 hours for normal or 4 hours for heavier soils.

To start fresh clean:

Step	Example	Press
1.	3:00 CLn	
2.	4:00 CLn	⚙️
3.	2:00 CLn	▶

- The oven should be empty and **all oven racks** removed. Remove all items from the cooktop. Be sure the oven door is **completely** closed.
- Press **fresh clean** once for a 3-hour clean time (*Figure 1*); twice for a 4-hour clean time (*Figure 2*) or 3 times for a 2-hour clean time (*Figure 3*).
- Press **START**.

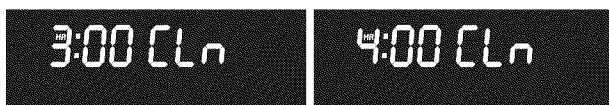

Fig. 1

Fig. 2



Fig. 3

Once active, the door lock motor will begin locking the oven door. **"door Loc"** (*Figure 4*) will appear in the display. **DO NOT** try to open the oven door when the **"door Loc"** message is on (allow about 15 seconds for the oven door to completely lock). **DO NOT** force the oven door open. This could damage the door locking system. Once the oven door is locked the **"door Loc"** message will turn off and **"CLn"** (*Figure 5*) will remain in the display for the entire clean cycle.

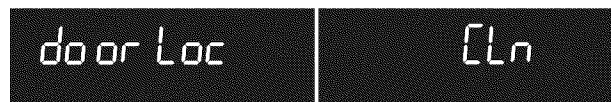

Fig. 4

Fig. 5

To stop fresh clean at any time, press **CANCEL**.

When the fresh clean cycle has finished:

- The time of day and **"Hot"** will show in the display (*Figure 6*).
- Once the oven has cooled (about 1 hour) and **"Hot"** is no longer displayed, the **"door OPn"** message will appear (*Figure 7*). When this message turns OFF the door has finished unlocking.



Fig. 6

Fig. 7

- When the oven is cool, wipe away any residue or powdered ash from the oven interior using a damp cloth or paper towel.

🗨️ NOTES

- Self-clean will not operate if ANY surface elements are active.
- A self-clean cycle will not start if the **control lock** feature is active.
- When the self-clean feature is active, you may check the amount of clean time remaining by pressing the **self-clean** ⚙️ key once.
- If a self-clean cycle was started but did not finish due to a power failure, your oven may not have completely cleaned.

Setting fresh clean (cont'd)

To cancel fresh-clean:

1. Press the **cancel**  key.
2. If the self-clean cycle has heated the oven to a high temperature, "**Hot**" (Figure 1) will show in the display. Allow enough time for the oven to cool and for the "**door OPn**" message to display (Figure 2). When this message turns OFF the oven door may be opened.



Fig. 1

Fig. 2

Starting fresh clean after cancelling:

If a self-clean cycle was cancelled **using the cancel key** before the oven was finished cleaning, you may wish to set for another self-clean cycle.

If self-clean was cancelled shortly after being started, and the oven interior did not reach high self-clean temperatures, the next clean cycle may be set as soon as the oven door unlocks from the cancelled clean cycle.

If the oven became hot enough from the cancelled self-clean cycle, you may be required to wait up to 4 hours before the control will allow another self-clean cycle to start.

Restarting a fresh clean cycle after a power outage:

If the self-clean cycle was interrupted by a power failure, your oven may not be thoroughly cleaned. Another self-clean cycle may be needed. Once power is restored, the oven has cooled and the oven door has unlocked, set to clean for another cycle.

Setting repeated fresh clean cycles

If attempting to set repeating self-clean cycles, the control may display the messages "**CLEAn**" then "**dELAY**" followed by the length of time before the next self-clean may be set.





For example, if the message displayed reads "**4:00**", and the time is 12:00 o'clock, the control will not allow self-clean to be set again until after 4:00 o'clock.

Setting delayed fresh clean

You may wish to set your appliance to perform a self-clean cycle later (up to 12 hours later). The **end time** key will determine when the cleaning will stop.

You will need to set the **end time** far enough to allow for the type of clean cycle you choose, whether for 2, 3, or 4 hours. Remember to add 30 to 40 additional minutes of cooling time before using the oven for cooking.

Setting for a heavy (4 hour) fresh clean cycle to end at 8:00 o'clock:

Example	
Step	Press
1. Be sure the clock is set with the correct time of day. Remove all oven racks. Remove all items from the cooktop. Be sure the oven door is completely closed.	
2. Press end time .	
3. Enter 8 0 0 using the numeric keypad.	800
4. Press START .	
5. Press fresh clean .	
6. Press fresh clean again.	
7. Press START .	

Press **CANCEL** at any time to stop fresh clean.

CAUTION

To avoid possible burns use caution when opening the oven door after the self-clean cycle is finished. The oven may still be **VERY HOT**. **Stand to the side of the oven** when opening the door to allow hot air or steam to escape.

Cleaning Recommendations

Surface	Type Cleaning Recommendation
<ul style="list-style-type: none"> • Control knobs (some models) • Painted body parts • Painted decorative trim • Aluminum, plastic or vinyl trim 	<p>For general cleaning, use hot, soapy water and a cloth. For more difficult soils and built-up grease, apply a liquid detergent directly onto soil. Leave on soil for 30-60 minutes. Rinse with a damp cloth and dry. Do not use abrasive cleaners these surfaces; they can scratch. To remove control knobs, turn to OFF position; grasp firmly and pull straight off the shaft. To replace knobs after cleaning, line up the flat sides of both knob and shaft; then push knob into place.</p>
<ul style="list-style-type: none"> • Control panel • Control key pad membrane • Decorative trim (some models) 	<p>Before cleaning the control panel, turn all controls off, activate control lock (some models) and if needed remove knobs from panel (some models). Do not use abrasive cleaners on controls or trim; they can scratch. Clean using hot, soapy water and a dishcloth. Be sure to squeeze excess water from dishcloth before wiping control panel; especially when wiping around the controls area. Excess water in or around the controls may cause damage to the appliance. When rinsing, use clean water and a dishcloth and be sure to squeeze excess water from dishcloth before wiping the control panel.</p>
<ul style="list-style-type: none"> • Stainless Steel (some models) 	<p>Clean stainless with warm soapy water using a clean sponge or cloth. Rinse with clean water and dry with soft clean cloth. Do not use harsh scrubbing cleaners. Only use kitchen cleaners especially made for cleaning stainless steel. Always be sure to rinse cleaners from the surface as bluish stains may occur during heating that cannot be removed.</p>
<ul style="list-style-type: none"> • Porcelain enamel parts • Broiler pan and broiler pan insert 	<p>Gentle scrubbing with a soapy no-scratch cleaning pad will remove most spots. Rinse with a 1:1 solution of clear water and ammonia. If necessary, cover difficult spots with an ammonia-soaked paper towel for 30 to 40 mins. Rinse with clean water and a damp cloth, and then scrub with a soap-filled no-scratch cleaning pad. Rinse and wipe dry with a clean cloth. Do not allow food spills with high sugar or acid content (milk, tomatoes, sauerkraut, fruit juices or pie filling) to remain on surfaces; they may cause a dull spot even after cleaning.</p>
<ul style="list-style-type: none"> • Oven interior 	<p>Remove excessive spillovers from oven cavity bottom before starting self-clean. Clean any soils from oven frame and door liner outside the oven door gasket. For important preparation information be sure to read all the instructions in the self-cleaning section.</p>
<ul style="list-style-type: none"> • Oven racks 	<p>Do not clean oven racks in oven during the self-clean cycle. Remove and clean using a mild, abrasive cleaner following manufacturer's instructions. Thoroughly rinse and dry.</p>
<ul style="list-style-type: none"> • Oven door 	<p>Use soap & water to thoroughly clean the top, sides and front of the oven door. Rinse well. You may use a glass cleaner on the outside glass of the oven door. Do not immerse the door in water. Do not spray or allow water or glass cleaner to enter the door vents. To avoid scratches, do not use oven cleaners, cleaning powders or any harsh abrasive cleaning materials on the outside of the oven door. Do not clean the oven door gasket. On self-cleaning models the oven door gasket is made of a woven material which is essential for a good seal. Care should be taken not to rub, damage or remove this gasket.</p>
<ul style="list-style-type: none"> • Ceramic cooktop 	<p>Refer to "Cooktop cleaning" and "Cooktop maintenance" in the Care and Cleaning section.</p>

Cooktop maintenance

Consistent and proper cleaning is essential to maintaining your ceramic glass cooktop.

Prior to using your cooktop for the first time, apply some of the cooktop cleaner supplied with your new appliance. Buff with a **non-abrasive** cloth or no-scratch cleaning pad. This will make cleaning easier when soiled from cooking. The special cooktop cleaning cream leaves a protective finish on the glass to help prevent scratches and abrasions.

Sliding aluminum or copper clad bottom pans on the cooktop can cause metal markings on the cooktop surface. These marks should be removed **immediately** after the cooktop has cooled using the cooktop cleaning cream. Metal marks can become permanent if not removed prior to future use.

Cookware (cast iron, metal, ceramic or glass) with rough or dirty bottoms can mark or scratch the cooktop surface.

Do not:

- Slide anything metal or glass across the cooktop.
- Use cookware with dirt or dirt build up on bottom; replace with clean cookware before using.
- Use your cooktop as a cutting board or work surface in the kitchen.
- Cook foods directly on the cooktop surface without a pan.
- Drop heavy or hard objects on the ceramic glass cooktop, they may cause it to crack.

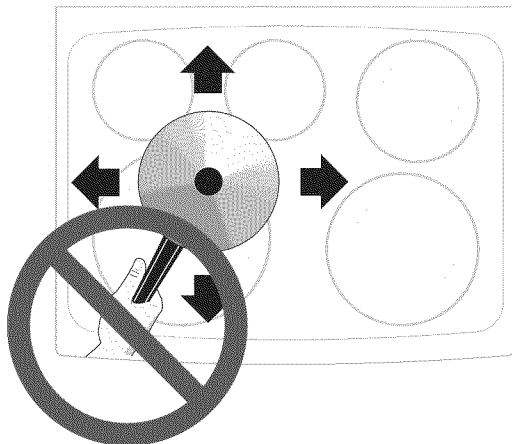

Cooktop cleaning

⚠ CAUTION

Before cleaning the cooktop, be sure the controls are turned to OFF and the cooktop is COOL.

For light to moderate soil:

Apply a few drops of the ceramic glass cooktop cleaner directly to the cooktop. Use a paper towel or use a **non-abrasive**, no-scratch cleaning pad to clean the entire cooktop surface. Make sure the cooktop is cleaned thoroughly, leaving no residue.

For heavy, burned on soil:

Apply a few drops of the ceramic glass cooktop cleaner directly to the soiled area. Rub the soiled area using a **non-abrasive**, no-scratch cleaning pad, applying pressure as needed. Do not use the pad you use to clean the cooktop for any other purpose.

If soils remain, carefully scrape soils with a razor blade scraper, holding scraper at a 30 degree angle to the surface. Remove loosened soils with cooktop cleaning cream and buff surface clean.

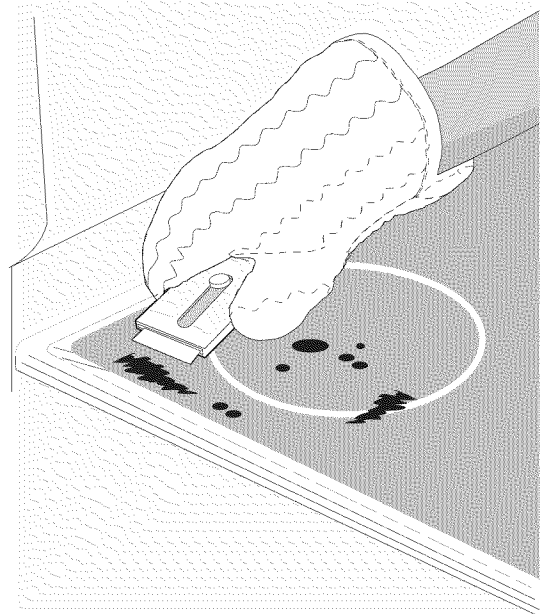

Cooktop cleaning (cont'd)

Plastic or foods with a high sugar content:

These types of soils need be removed immediately. Permanent damage (such as pitting of the cooktop surface) may occur if not removed **immediately**. After turning the surface elements OFF, use a razor blade scraper or a metal spatula with a mitt and scrape the soil from the hot surface. Allow the cooktop to cool. Use the same method for heavy or burned on soils.

➔ IMPORTANT

Damage to the ceramic glass cooktop may occur if you use an abrasive type cleaning pad. Only use cleaning products that have been specifically designed for ceramic glass cooktops.

Do not use the following on the cooktop:

- Do not use abrasive cleaners and scouring pads, such as metal and some nylon pads. They may scratch the cooktop, making it more difficult to clean.
- Do not use harsh cleaners, such as chlorine bleach, ammonia or oven cleaners, as they may etch or discolor the cooktop.
- Do not use dirty sponges, cloths or paper towels, as they can leave soil or lint on the cooktop which can burn and cause discoloration.



Aluminum foil and oven liners

Do not use oven bottom liners or use aluminum foil to cover the oven racks.

⚠ CAUTION

Protective liners—Do not use aluminum foil to line the oven bottom, except as suggested in the manual. Improper installation of these liners may result in a risk of electrical shock, or fire.

Using a liner in the oven restricts the heat and air flow needed to obtain the best possible cooking results for any oven.

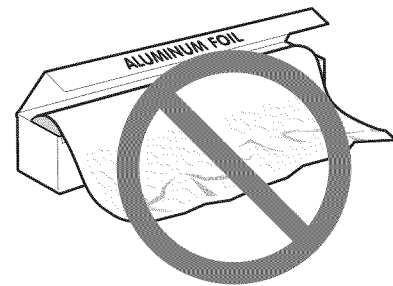

During self-clean the oven temperature can become hot enough to melt aluminum cooking utensils or aluminum foil if left in the oven. This could result in **permanent damage** to the oven interior and porcelain finish.

Removing and replacing the oven door

⚠ CAUTION

To prevent possible burns, do not attempt to remove the oven door until the oven has completely cooled.

➔ IMPORTANT

The oven door is heavy. Be careful when removing and lifting the door. Do not lift the oven door by the handle.

To remove the oven door:

1. Open oven door completely (*Figure 1*).
2. Pull the hinge locks on both left and right hinges down from the oven frame completely towards the oven door (*Figure 2*). A tool such as a small flat-blade screwdriver may be required.
3. Firmly grasp both sides of oven door along the door sides (Do not use the oven door handle).
4. Close the door to the broil stop position. The oven door will stop into this position just before fully closing.
5. With the oven door in the broil stop position (*Figure 3*), lift and carefully pull the oven door away from the oven frame. To avoid finish damage, be careful not to allow the oven door hinges to contact the oven front frame.

To replace oven door:

1. Firmly grasp both sides of oven door along the door sides (Do not use the oven door handle).
2. Holding the oven door at the same angle as the removal position (See "Removing the oven door" section), carefully line up and insert both door hinge arms between the pins located on each side of the oven door frame (*Figure 1*).
3. With both door hinge arms in place, open the oven door (*Figure 2*).
4. Push the door hinge locks up towards and into the oven frame for both left and right oven door hinges to the locked position (*Figure 3*).
5. Close the oven door.

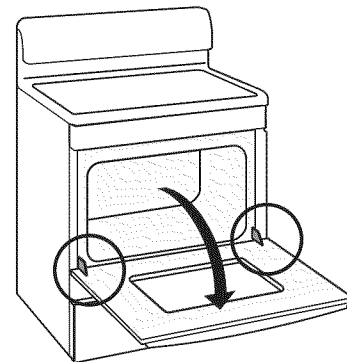

Fig. 1

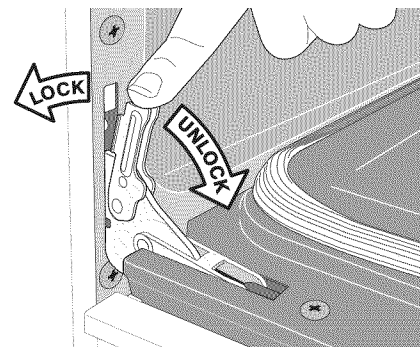

Fig. 2

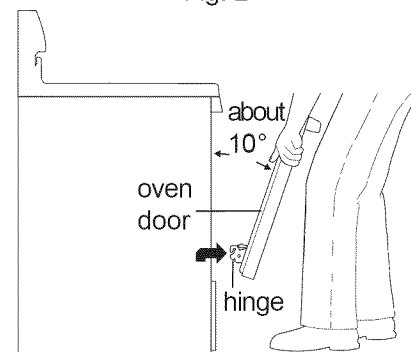

Fig. 3

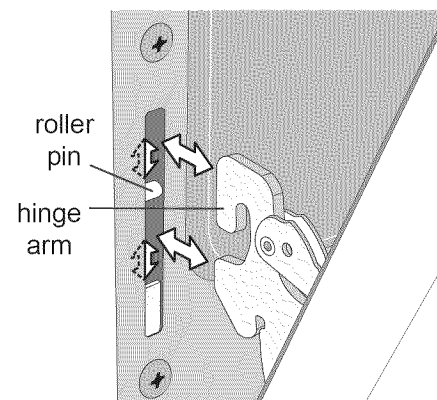

Fig. 4

Special door care instructions

➔ IMPORTANT

Most oven doors contain glass that can break. Read the following recommendations:

- **Do not** close the oven door until all the interior oven racks are fully inserted and retracted to the back of the oven.
- Do not hit the glass with pots, pans, or any other object. The oven door glass may break or even break at a later time unexpectedly.
- Scratching, hitting, jarring or stressing the oven door glass may weaken its structure causing an increased risk of breakage at a later time.
- You may use a glass cleaner on the outside of the oven door glass. **Do not spray** or allow water or the cleaner to enter or drip down into the oven door vents. Spray cleaner on cloth first and then wipe the oven door clean.
- **Do not** use strong oven cleaners, powders or any harsh abrasive cleaning materials on the outside of the oven door or glass.
- **Never clean** the oven door gasket.

Changing the oven light

⚠ CAUTION

Be sure the range is unplugged and all parts are COOL before replacing oven light. Wear a leather glove for protection against possible broken glass or burns.

The oven lights are located at the rear of the oven cavity and are covered with a glass shield held by a wire holder (*Figure 1*). The glass shield protects the light bulb and must be in place whenever the oven is in use.

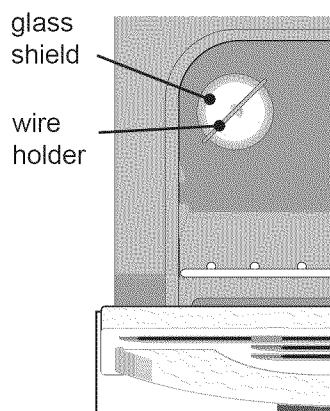

Fig. 1

To replace interior oven light bulb:

1. Turn electrical power off at the main source or unplug the range.
2. Press wire holder to one side to release the glass shield that covers the light bulb.
3. Replace light with a new 40 watt appliance bulb.
4. Replace glass shield over bulb and snap wire holder back into place.
5. Turn power on at main source (or plug the appliance in).
6. The clock will then need to be reset. To reset, see Setting clock in this Use & Care Guide.

Solutions to Common Problems

Before you call for service, review the following list. It may save you time & expense. The list includes common occurrences that are not the result of defective workmanship or materials in this appliance.

Before you call	
Problem	Solution
Appliance is not level	<ul style="list-style-type: none"> • Be sure floor is level, strong & stable enough to adequately support range. • If floor is sagging or sloping, contact a carpenter to correct the situation. • Poor installation. Place oven rack in center of oven. Place a level on the oven rack. Adjust leveling legs at base of appliance until the oven rack is level. • Kitchen cabinet alignment may make range appear not level. Be sure cabinets are square & have sufficient room for appliance clearance.
Cannot move appliance easily. Appliance must be accessible for service	<ul style="list-style-type: none"> • Cabinets not square or are built in too tightly. Contact builder or installer to make appliance accessible. • Carpet interferes with appliance. Provide sufficient space so appliance can be lifted over carpet.
Surface element too hot or not hot enough	<ul style="list-style-type: none"> • Incorrect control setting. Be sure the correct control is ON for the element that you are attempting to use.
Surface element does not heat	<ul style="list-style-type: none"> • Lightweight or warped pans used. Use only flat, evenly balanced, medium or heavyweight cookware. Flat pans heat better than warped pans. Cookware materials and weight of the material affect heating. Heavy & medium-weight pans heat evenly. Because lightweight pans heat unevenly, foods may burn easily.
Entire appliance does not operate	<ul style="list-style-type: none"> • The time of day is not set. The time of day must first be set in order to operate the oven. See "Setting clock" in the Setting Oven Controls section. • Make sure cord/plug is plugged correctly into outlet. • Service wiring is not complete. Contact your dealer, installing agent or authorized service agent. • Electrical power outage. Check house lights to be sure. Call your local electric company for service.
Oven does not operate	<ul style="list-style-type: none"> • Be sure the oven controls are set properly for the desired cooking feature. See Setting Oven Controls in this Use & Care Guide or read the instructions "Entire appliance does not operate" in this checklist.
Oven light does not work	<ul style="list-style-type: none"> • Replace or tighten bulb. See "Changing upper or lower oven lights" sections in this Use & Care Guide.

Before you call

Problem	Solution
<p>Oven smokes excessively during broiling</p>	<ul style="list-style-type: none"> • Control not set properly. Follow broiling instructions under Setting Oven Controls. • Make sure oven door is opened to broil stop position. • Meat too close to the broil element. Reposition the broil rack to provide proper clearance between the meat & the element. Preheat the broil element for searing. • Meat not properly prepared. Remove excess fat from meat. Cut remaining fatty edges to prevent curling, but do not cut into lean. • Insert on broiler pan wrong side up & grease not draining. Always place grid on the broiler pan with ribs up & slots down to allow grease to drip into pan (some models). • Grease has built up on oven surfaces. Regular cleaning is necessary when broiling frequently. Old grease or food spatters cause excessive smoking.
<p>Flames inside oven or smoking from oven vent</p>	<ul style="list-style-type: none"> • Excessive spillovers in oven. For example this will happen for pie spillovers or large amounts of grease left on the oven bottom. Wipe up excessive spillovers before starting oven. If flames or excessive smoke are present see "About broiling" in the Setting Oven Controls section.
<p>Oven control panel beeps & displays any F code error (for example F10)</p>	<ul style="list-style-type: none"> • Oven control has detected a fault or error condition. Press CANCEL to clear the display & stop beeping. Try the bake or broil feature again. If the F code error repeats, remove power supply to appliance, wait 5 minutes and then repower the appliance and set clock for the time of day. Try the bake or broil feature again. If the fault recurs, record fault and call for service.
<p>Oven control panel beeps & cooktop control displays any F code error (for example F10)</p>	<ul style="list-style-type: none"> • Cooktop control has detected a fault or error condition. If the F code error persists, remove power supply to appliance, wait 5 minutes and then repower the appliance and set clock for time of day. Try the cooktop setting again. If the fault recurs, record F code fault and call for service.

Before you Call	
Problem	Solution
Scratches or abrasions on cooktop surface	<ul style="list-style-type: none"> • Coarse particles such as salt or sand between cooktop and utensils can cause scratches. Be sure cooktop surface and bottoms of utensils are clean before usage. Small scratches do not affect cooking and will become less visible with time. • Cleaning materials not recommended for ceramic-glass cooktop have been used. See "Cooktop Cleaning and Maintenance" in the Care and Cleaning section of this Use & Care Guide. • Cookware with rough bottom has been used. Use smooth, flat-bottomed cookware.
Metal marks on the cooktop	<ul style="list-style-type: none"> • Sliding or scraping of metal utensils on cooktop surface. Do not slide metal utensils on cooktop surface. Use a ceramic-glass cooktop cleaning creme to remove the marks. See "Cooktop Cleaning and Maintenance" in the Care and Cleaning section.
Brown streaks or specks on cooktop surface	<ul style="list-style-type: none"> • Boilovers are cooked onto surface. Use razor blade scraper to remove soil. See "Cooktop Cleaning and Maintenance" in the Care and Cleaning section.
Areas of discoloration with metallic sheen	<ul style="list-style-type: none"> • Mineral deposits from water and food. Remove using a ceramic-glass cooktop cleaning creme. Use cookware with clean, dry bottoms.
Poor baking results	<ul style="list-style-type: none"> • Many factors affect baking results. Make sure the proper oven rack position is used. Center food in the oven and space pans to allow air to circulate. Allow the oven to preheat to the set temperature before placing food in the oven. Try adjusting the recipe's recommended temperature or baking time. If you feel the oven is too hot or cool, see "Adjusting Oven Temperature" in the Setting Oven Controls section of this Use & Care Guide.

Your appliance is covered by a one year limited warranty. For one year from your original date of purchase, Electrolux will repair or replace any parts of this appliance that prove to be defective in materials or workmanship when such appliance is installed, used, and maintained in accordance with the provided instructions. In addition, the glass cooktop or radiant surface element of your appliance (excluding built-in and free-standing range appliances) is covered by a two through five year limited warranty. During the 2nd through 5th years from your original date of purchase, Electrolux will provide a replacement glass cooktop or radiant surface element for your appliance which has proven to be defective in materials or workmanship when such appliance is installed, used, and maintained in accordance with the provided instructions.

Exclusions

This warranty does not cover the following:

1. Products with original serial numbers that have been removed, altered or cannot be readily determined.
2. Product that has been transferred from its original owner to another party or removed outside the USA or Canada.
3. Rust on the interior or exterior of the unit.
4. Products purchased "as-is" are not covered by this warranty.
5. Products used in a commercial setting.
6. Service calls which do not involve malfunction or defects in materials or workmanship, or for appliances not in ordinary household use or used other than in accordance with the provided instructions.
7. Service calls to correct the installation of your appliance or to instruct you how to use your appliance.
8. Expenses for making the appliance accessible for servicing, such as removal of trim, cupboards, shelves, etc., which are not a part of the appliance when it is shipped from the factory.
9. Service calls to repair or replace appliance light bulbs, air filters, water filters, other consumables, or knobs, handles, or other cosmetic parts.
10. Labor or in-home service costs during the additional limited warranty periods beyond the first year from your original date of purchase.
11. Pickup and delivery costs; your appliance is designed to be repaired in the home.
12. Surcharges including, but not limited to, any after hour, weekend, or holiday service calls, tolls, ferry trip charges, or mileage expense for service calls to remote areas, including the state of Alaska.
13. Damages to the finish of appliance or home incurred during transportation or installation, including but not limited to floors, cabinets, walls, etc.
14. Damages caused by: services performed by unauthorized service companies; use of parts other than genuine Electrolux parts or parts obtained from persons other than authorized service companies; or external causes such as abuse, misuse, inadequate power supply, accidents, fires, or acts of God.

DISCLAIMER OF IMPLIED WARRANTIES; LIMITATION OF REMEDIES

CUSTOMER'S SOLE AND EXCLUSIVE REMEDY UNDER THIS LIMITED WARRANTY SHALL BE REPAIR OR REPLACEMENT AS PROVIDED HEREIN. **CLAIMS BASED ON IMPLIED WARRANTIES, INCLUDING WARRANTIES OF MERCHANTABILITY OR FITNESS FOR A PARTICULAR PURPOSE, ARE LIMITED TO ONE YEAR OR THE SHORTEST PERIOD ALLOWED BY LAW, BUT NOT LESS THAN ONE YEAR.** ELECTROLUX SHALL NOT BE LIABLE FOR CONSEQUENTIAL OR INCIDENTAL DAMAGES SUCH AS PROPERTY DAMAGE AND INCIDENTAL EXPENSES RESULTING FROM ANY BREACH OF THIS WRITTEN LIMITED WARRANTY OR ANY IMPLIED WARRANTY. SOME STATES AND PROVINCES DO NOT ALLOW THE EXCLUSION OR LIMITATION OF INCIDENTAL OR CONSEQUENTIAL DAMAGES, OR LIMITATIONS ON THE DURATION OF IMPLIED WARRANTIES, SO THESE LIMITATIONS OR EXCLUSIONS MAY NOT APPLY TO YOU. THIS WRITTEN WARRANTY GIVES YOU SPECIFIC LEGAL RIGHTS. YOU MAY ALSO HAVE OTHER RIGHTS THAT VARY FROM STATE TO STATE.

If You Need Service

Keep your receipt, delivery slip, or some other appropriate payment record to establish the warranty period should service be required. If service is performed, it is in your best interest to obtain and keep all receipts. Service under this warranty must be obtained by contacting Electrolux at the addresses or phone numbers below.

This warranty only applies in the USA, Puerto Rico and Canada. In the USA and Puerto Rico, your appliance is warranted by Electrolux Major Appliances North America, a division of Electrolux Home Products, Inc. In Canada, your appliance is warranted by Electrolux Canada Corp. Electrolux authorizes no person to change or add to any obligations under this warranty. Obligations for service and parts under this warranty must be performed by Electrolux or an authorized service company. Product features or specifications as described or illustrated are subject to change without notice.

USA

1-877-435-3287

Electrolux Major Appliances North America
10200 David Taylor Drive
Charlotte, NC 28262

Canada

1-800-265-8352

Electrolux Canada Corp.
5855 Terry Fox Way
Mississauga, Ontario, Canada L5V 3E4

