

MODELS**U.S. – CRE9500C, CRE9400C, CRE8600C, CRE7600B, CHE9000B****CANADA – CRE9500D, CRE8700D, CRE7700C, CRE7600C**

TABLE OF CONTENTS

	Page
For Future Reference	1
Important Safety Instructions	2-4
Range Control Panel	5-6
• Electronic Clock and Oven Control Functions	5-6
• Setting the Clock and Timer	6
Surface Cooking	7-8
• Panel Light (select models)	7
• The Controls	7
• Using Your Coil Element Cooking Surface	8
Using Your Oven	9-11
• Baking and Roasting	9
• Broiling	10
• Programmed Oven Operations	10-11
Cleaning	12-15
• Porcelain Enamel Cooktop	12
• Drip Bowls	12
• Manual Clean Oven (select models)	12
• Self-Clean Oven (select models)	12-13
• Range Cleaning Chart	14-15
Maintenance	16
• Adjusting the Oven Thermostat	16
• Storage Drawer	16
• Leveling Legs	16
• Light Replacement	16
Before You Call for Service	17
Warranty	Back Cover



FOR FUTURE REFERENCE

Congratulations on your choice of a Maytag electric range. As you use your new range we know you will appreciate the many features that provide excellent performance, ease of cleaning, convenience and dependability.

New features have dramatically changed today's cooking appliances and the way we cook. It is therefore very important to understand how your new electric range operates before you use it. On the following pages you will find information regarding the operation of your new range. By following these instructions carefully, you will be able to fully enjoy and properly maintain your new Maytag range.

Please take a moment to review the enclosed booklet, "Cooking Made Simple" as well. Whether you need assistance in selecting the right cookware or reviewing the "dos and don'ts" of baking, roasting and broiling, the answers are contained in this booklet. We want you to have excellent results with the food you prepare.

Should you have any questions about using your Maytag range, call or write us. Be sure to provide the model and serial numbers of your range.

MAYTAG CONSUMER EDUCATION
ONE DEPENDABILITY SQUARE
NEWTON, IOWA 50208
(515) 791-8911
(Mon. - Fri., 8 am - 5 pm CST)

For future reference, keep this manual in a convenient location. Record the model number and serial number of this electric range in the spaces provided. (This information can be found on the data plate located on the frame around the storage drawer.)

Model Number

Serial Number

IMPORTANT: Keep your sales slip or canceled check. Proof of original purchase date is needed for warranty service.

NOTE: In our continuing effort to improve the quality of our cooking products, it may be necessary to make changes to the appliance without revising this manual. As an example, a knob on your appliance may not look like an illustration in this book.

NOTE: (Canadian Ranges ONLY) Your range is equipped with seven (7) "P" fuses. The fuses are located on the back wall. Remove the storage drawer for access to the fuses. If part of your range does not operate, check to see if a fuse has blown. A gap in the fuse strip or a darkened window indicates a blown fuse. Replace with the same type and amperage "P" fuse.

BE SURE YOU READ THE SAFETY INSTRUCTIONS ON PAGES 2-4 BEFORE YOU START TO USE THIS RANGE.

IMPORTANT SAFETY INSTRUCTIONS

Read all instructions before using this appliance.

The following instructions are based on safety considerations and must be strictly followed to reduce the potential risks of fire, electric shock, or personal injury.

Be sure appliance is properly installed and grounded by a qualified technician.

Do not attempt to adjust, repair, service, or replace any part of appliance unless it is specifically recommended in this book. All other servicing should be referred to a qualified servicer. Always disconnect power to unit before any servicing by tripping circuit breaker to the OFF position or removing the fuse.

Locate and mark the breaker or fuse. Never replace a blown fuse or reset a breaker until you know what has caused the problem. Always replace a blown fuse with one of the correct amperage.

To Prevent Fire or Smoke Damage

Remove all packing materials from the appliance before operating it.

Flammable materials should not be stored in an oven or on or near surface elements.

If appliance is installed near a window, proper precautions should be taken to prevent curtains from blowing over surface elements.

Do not leave any items on the cooktop. The hot air from the vent may ignite flammable items and may increase pressure in closed containers which may cause them to burst.

Many aerosol-type spray cans are **EXPLOSIVE** when exposed to heat and may be highly flammable. Avoid their use or storage near an appliance.

Do not leave plastic items on the cooktop as they may melt or soften if left too close to the vent or surface element.

To eliminate the hazard of reaching over hot surface burners, cabinet storage should not be provided directly above a unit. If such storage is provided, it should be limited to items which are used infrequently and which are safely stored in an area subjected to heat from an appliance. Temperatures may be unsafe for some items, such as volatile liquids, cleaners or aerosol sprays.

In Case of Fire

Turn off appliance and ventilating hood to avoid spreading the flame.

Use dry chemical or foam-type extinguisher or baking soda to smother fire or flame. Never use water on a grease fire.

If fire is in the oven or broiler pan, smother by closing oven door.

If fire is in a pan on the surface burner, cover pan. Never attempt to pick up or move a flaming pan.

Child Safety

Do not leave children alone or unsupervised near the appliance when it is in use or is still hot.

Children must be taught that the appliance and utensils in or on it can be hot.

Children should be taught that an appliance is not a toy. Children should not be allowed to play with controls or other parts of the unit. Children should never be allowed to sit or stand on any part of the appliance.

CAUTION: Do not store items of interest to children in cabinets above an appliance or on the backguard of a range. Children climbing on the appliance or on the appliance door to reach items could be seriously injured.

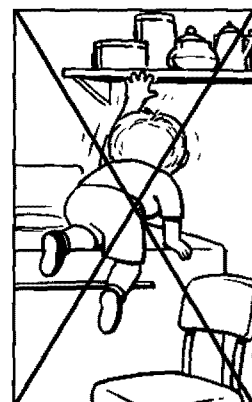

About Your Appliance

To prevent injury or damage to the appliance, do not use appliance as a space heater to heat or warm a room. Also, do not use the cooktop or oven as a storage area for food or cooking utensils.

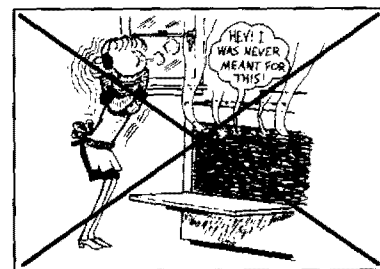

Keep the oven vent ducts **UNOBSTRUCTED** (located under the right rear element for coil cooktops or on the cooktop for smoothtop models). Blockage of the vent prevents the proper oven air circulation and will affect the oven performance.

CAUTION: Do not use an appliance as a step stool to cabinets above. Misuse of appliance doors or drawers, such as stepping, leaning or sitting on the door or drawer, may result in possible tipping of the appliance, breakage of door, and serious injuries.

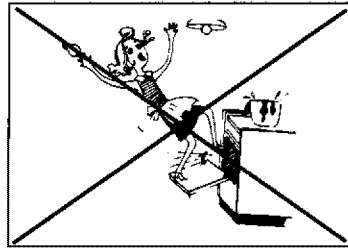

WARNING: To reduce the risk of tipping of appliance, the appliance must be secured by a properly installed anti-tip device. When removing the appliance for cleaning, be sure the anti-tip device is engaged when the range is replaced. Look underneath range to verify that one of the rear leveling legs is properly engaged in the bracket slot. The anti-tip device secures the rear leveling leg to the floor when properly engaged.

Do not touch a hot oven light bulb with a damp cloth as the bulb could break. Should the bulb break, disconnect power to the appliance before removing bulb to avoid electrical shock.

Cooking Safety

Always turn off surface element or the oven when cooking is completed.

It is normal for some parts of the cooktop, especially areas surrounding the surface elements, to become hot during cooking operations. Do not touch the cooktop until it has cooled.

Never leave surface cooking operations unattended at high heat setting or when deep fat frying. Boilovers cause smoking and greasy spillovers may ignite.

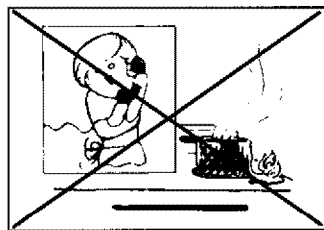

Never heat an unopened food container. Pressure build-up may cause container to burst resulting in personal injury or damage to the appliance.

Use dry, sturdy potholders. Damp potholders on hot surfaces may cause burns from steam. Towels or other bulky items should never be used as potholders. Do not let potholders touch hot heating elements.

Always let quantities of hot fat cool before attempting to move or handle.

Do not let grease or other flammable materials accumulate in or near the appliance, hood or vent fan. Clean hood frequently to prevent grease from accumulating on hood or filter.

Make sure the drip bowls are in place. Absence of these bowls during cooking may subject wiring or components underneath to damage.

Loose fitting or long hanging-sleeved apparel should not be worn while cooking. Clothing may ignite or catch utensil handles.

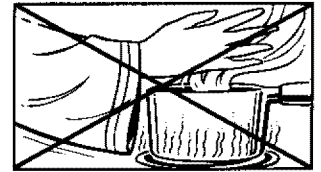

Always place oven racks in the desired positions while oven is cool. If a rack must be moved while hot, use a dry potholder and avoid touching hot element in oven.

Use care when opening the oven door. Let hot air or steam escape before removing or replacing food.

PREPARED FOOD WARNING: Follow food manufacturer's instructions. If a plastic frozen food container and/or its cover distorts, warps, or is otherwise damaged during cooking, immediately discard the food and its container. The food could be contaminated.

DO NOT TOUCH THE SURFACE OR OVEN ELEMENTS, AREAS NEAR THE ELEMENTS OR THE INTERIOR SURFACES OF OVEN. Elements may be hot even though they are dark in color. Areas near surface elements and the interior surfaces of the oven may become hot enough to cause burns. During and after use, do not touch or let clothing or other flammable materials contact heating elements, areas near elements or interior surfaces of oven until they have had sufficient time to cool. Among these areas are the cooktop, the surfaces facing the cooktop, the oven vent opening and the surfaces near opening, oven door, and oven window.

Do not allow aluminum foil, meat probes or any other metal object (other than a pan on a surface element) to contact heating elements.

Utensil Safety

Use proper pan size. This appliance is equipped with one or more surface elements of different sizes. Select utensils having flat bottoms large enough to cover the surface element. The use of undersized utensils will expose a portion of the heating element to direct contact and may result in the ignition of clothing. The proper relationship of the utensil to the element will also improve efficiency.

Use pans with flat bottoms and handles that are easily grasped and stay cool. Avoid using unstable or loose handled pans.

Be sure utensil is large enough to properly contain food and avoid boilovers. Pan size is particularly important in deep fat frying.

To minimize burns, ignition of flammable materials and spillage due to unintentional contact with the utensil, do not extend handles over adjacent surface elements. Always turn pan handles toward the side or back of the appliance, not out into the room where they are easily hit or reached by small children.

Never let a pan boil dry as this could damage the utensil and the appliance.

Follow the manufacturer's directions when using oven cooking bags.

Only certain types of glass, glass/ceramic, ceramic, or glazed utensils are suitable for cooktop or oven usage without breaking due to the sudden change in temperature.

This appliance has been tested for safe performance using conventional cookware. Do not use any devices or accessories that are not specifically recommended in this manual. Do not use eyelid covers for the surface units, stove top grills, or add-on oven convection systems. The use of devices or accessories that are not expressly recommended in this manual can create serious safety hazards, result in performance problems, and reduce the life of the components of the appliance.

Cleaning Safety

Turn off all controls and wait for appliance parts to cool before touching or cleaning them.

Clean cooktop with caution. Use care to avoid steam burns if a wet sponge or cloth is used to wipe spills on a hot surface. Some cleaners can produce noxious fumes if applied to a hot surface.

Do not soak or immerse the removable heating elements in water (select models). Immersing an element in water would damage the insulating material inside the element.

Do not use aluminum foil to line the surface unit drip bowls or the oven bottom. Improper installation of these liners may result in a risk of electric shock or fire.

Self-Clean Oven (select models)

Clean only parts listed in this booklet. Do not clean door gasket. The door gasket is essential for a good seal. Care should be taken not to rub, damage, or move the gasket. Do not use oven cleaners of any kind in or around any part of the self-clean oven.

Before self-cleaning the oven, remove broiler pan, oven racks, and other utensils, and wipe off excessive spillovers to prevent excessive smoke or flare-ups. **CAUTION: DO NOT LEAVE FOOD OR COOKING UTENSILS, ETC., IN THE OVEN DURING THE SELF-CLEAN CYCLE.**

It is normal for the cooktop of the range to become hot during a self-clean cycle. Therefore, touching or lifting the cooktop during a clean cycle should be avoided.

A fan should be heard during the self-clean cycle (select models). If not, cancel the cycle and call servicer. Refer to the Table of Contents for location of self-clean instructions and for information, if equipped.

Important Safety Notice and Warning

The California Safe Drinking Water and Toxic Enforcement Act of 1986 (Proposition 65) requires the Governor of California to publish a list of substances known to the State of California to cause cancer or reproductive harm, and requires businesses to warn customers of potential exposures to such substances.

Users of this appliance are hereby warned that when the oven is engaged in the self-clean cycle (select models), there may be some low level exposure to some of the listed substances, including carbon monoxide. Exposure to these substances can be minimized by properly venting the range to the outdoors during the self-clean cycle.

SAVE THESE INSTRUCTIONS

RANGE CONTROL PANEL



Electronic Clock and Oven Control



Styling and features may differ depending on the model you selected.

The electronic clock and oven control on your Maytag range is used for the time-of-day clock, timer, bake, broil, programmed oven operations and self-clean (select models) functions. A beep will sound each time a function pad is pressed.

The display on the control will flash when power is first supplied to the range or if there is a power failure. Once the time-of-day clock has been set (see Setting the Clock, page 6), the display will stop flashing.

The oven will automatically turn off if it is left on for 12 hours.

NOTE: The electronic control is equipped with a self-diagnostic feature for service use **ONLY**. If a fault code (F plus a number, ex. F1) appears in the display along with a continuous beeping sound, press the CANCEL pad. See Before You Call for Service (page 17) if the fault code reappears in the display.

The following pads are found on your Maytag electronic clock and oven control:

Cancel Pad

Press this pad to cancel all operations except the time-of-day clock and timer. If you are ever unsure if you've programmed the control correctly, press the CANCEL pad and start over.

▲ and ▼ Pads

Press or press and hold these pads to enter the time or temperature desired. These pads are also used to select Hi or Lo broil.

Timer Pad

The timer can be set from 1 minute to 9 hours, 50 minutes. It will count down by seconds (when set for 1 minute) or minutes (when set for 2 minutes or more time). See page 6 for instructions on setting the timer.

Clock Pad

Use this pad to set the time-of-day clock. For instructions to do this, see below.

You may also press this pad to recall the current time of day. For example, if the timer is counting down in the display, press the CLOCK pad to return the current time to the display. The timer will continue to count down and a signal will sound when the time expires.

Cook Time/Oven Stop Pads

These pads are used to program the oven to start and stop automatically, either immediately or at a later time. For detailed information on using Programmed Oven Operations, see pages 10–11.

Self Clean Pad (select models)

This pad is pressed to set the oven for a self-clean cycle. See pages 12–13 for detailed information on the self-clean feature.

Broil Pad

Use this pad to select broil. Two heat selections are available for broiling—Hi and Lo. See page 10 for more broiling information.

Oven Temp Pad

The oven temperature is set by pressing this pad and the ▲ or ▼ pad. Additional baking and roasting information can be found on page 9.

Setting the Clock and Timer

Clock

To set the time-of-day clock:

1. Press the CLOCK pad once. The words “Set Time” will flash in the display.
2. Set the correct time of day using the ▲ and ▼ pads.
 - To change the time by one minute, press either pad **once**.
 - To change the time in increments of 10 minutes, **press and hold** either pad.

When the power is first supplied to the range or if there has been a power failure, the display will flash. Follow above instructions to set the clock. The clock time cannot be changed when the oven is set for a cook or self-clean (select models) operation. Cancel the operation to set the clock.

Press the CLOCK pad to recall the time of day when another function is displayed.

Timer

To set the timer:

1. Press the TIMER pad once. The words “Set Timer” will flash in the display.
2. Set the desired time using the ▲ and ▼ pads.
 - Press either pad **once** to change the time by 1 minute (if the Timer is set for up to 1 hour), 5 minutes (if the Timer is set for over 1 hour), or 10 minutes (if the Timer is set for over 2 hours).
 - **Press and hold** either pad to change the time in 5 minute or 10 minute increments, depending upon the time set in the display.

The TIMER can be set from 1 minute (0HR:01) up to 9 hours and 50 minutes (9 HR:50).

The timing operation will start automatically. Colons will flash in the display to indicate a timing operation. One long continuous beep will signal the end of the timing operation and “End” will briefly appear in the display. The time of day will automatically reappear in the display. The TIMER pad does not control the oven.

To cancel: Press the TIMER pad and hold for 3 seconds. The time of day will reappear after a slight delay.

SURFACE COOKING

Panel Light (select models)

The panel light is turned on by pushing the rocker switch on the control panel and holding it in until the fluorescent light comes on. It may be turned off by pushing the other side of the switch.

The Controls

Your range is equipped with surface control knobs that provide an infinite choice of heat settings from **Low** to **High**. The knobs can be set on or between any of the numbered settings.

To operate the control: Push in and turn the knob in either direction to the desired heat setting. A surface indicator light on the control panel will turn on to alert you that one or more of the surface elements are on. After a cooking operation, be sure the elements and indicator lights are off.



Suggested Heat Settings

Turn the control knob to the desired heat setting. If in doubt, it is better to select a lower setting and increase to a higher one later if needed. It will take longer for the element to cool to a lower temperature than to heat up to a higher temperature.

Use the following chart as a guideline until you become more familiar with your new range. Information in the chart is based on the use of heavy gauge metal cookware. Other pan materials may require a different heat setting for the same cooking operation. (For more information on cookware, see "Cooking Made Simple" booklet.)

Setting	Uses
HIGH	To bring liquid to a boil, blanch or bring up pressure in a pressure cooker. Always reduce to a lower heat setting when liquids just begin to boil or food begins to cook.
8-9	To quickly brown or sear meat, for fast cooking of non-protein foods (such as vegetables or pasta).
7	To maintain a fast boil for large amounts of liquid.
5-6	To maintain a slow boil for large amounts of liquid, for most frying.
3-4	To continue cooking uncovered foods, for most slow frying, stewing, braising or steaming.
1-2	For long, slow cooking of covered foods (simmering).
LOW	To keep foods warm before serving, melt chocolate or butter.

Using Your Coil Element Cooking Surface

It is normal for some parts of the cooktop, especially areas surrounding the surface elements, to become warm or hot during surface cooking operations. Therefore, do not touch or let heat-sensitive materials such as plastics touch the cooktop until it has had time to cool.

Lift-up Cooktop

Your range features an upswept cooktop that can be lifted up for convenient access to the area under the cooktop. The top is hinged and can be raised but not removed.

NOTE: The slide-in range (CHE9000) is not equipped with a lift-up cooktop because of installation requirements.

To lift cooktop: When cool, grasp the front edge of the cooktop and gently lift up until the two automatic prop rods at the front of the cooktop snap into place.

To lower cooktop: Hold the front edge of the cooktop and carefully push back on each prop rod to release the notched support. Then gently lower the top into place. The prop rods will slide into the range frame.

Coil Elements

The coil elements of your range are self-cleaning. Do not immerse the elements in water.

To remove: Raise the element when cool and carefully pull out and away from the receptacle.

To replace: Insert the terminals on the element into the receptacle and guide the element into place until it sits level on the drip bowl.

Drip Bowls

The drip bowls, located under each surface element, are designed to catch boilovers. They must always be used—absence of these bowls during cooking may damage wiring or other parts underneath the cooktop.

Clean the drip bowls frequently. See cleaning section, pages 12–15.

USING YOUR OVEN

Every oven has its own characteristics. You may find that the cooking times and temperatures vary slightly from your old oven. This is normal.

For safety reasons, when opening the oven door, allow steam and hot air to escape before reaching into the oven to remove food.

Baking and Roasting

(For additional baking and roasting tips, refer to "Cooking Made Simple" booklet.)

Setting the Oven Controls for Baking and Roasting:

1. Press the OVEN TEMP pad. "Bake" and 000° will appear in the display.
2. Press either the ▲ or ▼ pad once and 350° will appear in the display. Press the ▲ or ▼ pad until the desired oven temperature is displayed.

The word ON will light in the display, the oven will turn on and the temperature display will rise in 5° increments while the oven is preheating. A beep will sound to indicate that the oven has preheated. Allow 10–15 minutes for preheating.

3. After the cooking operation, turn the oven off by pressing the CANCEL pad. Remove food from the oven.

NOTE: To change the oven temperature during a baking operation, press the ▲ or ▼ pad until the desired temperature is displayed.

NOTE: If the oven temperature is not selected within 30 seconds, the program will automatically cancel.

IMPORTANT: Do not move the door lock lever (select models) to the right during baking or roasting. The oven door may lock and will not unlock until the oven cools.

Oven Racks

The oven racks are designed with a lock-stop edge to keep the racks from coming completely out of the oven when there is food placed on them.

To remove: Be sure the rack is cool. Pull the rack straight out until it stops. Tilt the front end of the rack up and continue pulling it out.

To replace: Tilt the front end of the rack up and place it between the rack supports. Slide it back until it clears the lock-stop position. Lower the front and slide the rack straight in.

Do not cover an entire oven rack or oven bottom with aluminum foil. This will restrict air flow.

Rack Positions

Do not attempt to change the rack positions when the oven is hot. Use the following guidelines when selecting the proper rack position. **Never place pans directly on the oven bottom.**

Rack 1: (lowest position)	Used for roasting large cuts of meat and large poultry, frozen pies, souffles or angel food cake.
Rack 2:	Used for roasting small cuts of meat, large casseroles, baking loaves of bread, cakes (in either tube, bundt, or layer pans) or two-rack baking.
Rack 3: (middle position)	Used for most baked goods on a cookie sheet or jelly roll pan, or frozen convenience foods.
Rack 4:	Used for most broiling and two-rack baking.
Rack 5: (highest position)	Used for broiling thin, non-fatty foods such as fish, toasting bread.

Oven Light

Push the switch on the control panel marked OVEN LIGHT to turn it on and off. On select models the oven light automatically comes on whenever the oven door is opened.

Oven Vent

The oven vent is located under the right rear element. When the oven is in use, this area may feel warm or hot to the touch. To prevent problems, do not block the vent opening.

Fan (CHE9000 model only)

A fan automatically turns on whenever the oven is set for a cooking or self-clean operation to ensure long life of the clock and oven controls. The fan will automatically turn off when the oven has cooled.

Broiling

For best results, use the broiler pan and insert supplied with your range.

(For additional broiling tips, refer to "Cooking Made Simple" booklet.)

Setting the Controls for Broiling:

1. Press the BROIL pad and press the ▲ or ▼ pad to select either Hi or Lo broil as indicated in the display. Hi is used for most broiling operations. Lo should be selected when broiling thicker meats to the well-done stage (to prevent excessive browning). Broiling times may increase if LO is selected. **Allow the element to preheat for 3–4 minutes.**
2. Place the broiler pan on the recommended rack position shown in the broiling chart.
3. Follow the suggested times in the broiling chart below. Broil with the oven door open about 4 inches.
4. Check the doneness by cutting a slit in the meat near the center to check the color.
5. To cancel or end the broiling operation, press the CANCEL pad.
6. Broil times may need to be increased if the range is installed on a 208 volt circuit.

Broiling Chart

Until you become more familiar with your new range, use the following chart as a guide when broiling foods.

Food	Quantity &/Or Thickness	Temp.	Rack Position*	Doneness	Approx. Minutes/Side 1st Side	2nd Side
Bacon		HI	4	well	4–5	2–4
Beef Patties	3/4-inch thick	HI	4	well	8–10	7–8
Steaks	1-inch thick	HI	4	medium	8–10	7–8
			4	well	10–13	9–10
Chicken Pieces		LO	3	well	16–25	14–20
Fish	1/2-inch thick	HI	4	flaky	4–5	4–6
	1-inch thick	HI	4	flaky	7–9	4–6
Ham Slices (precooked)	1/2-inch thick	HI	4	heated	5–7	4–6
Pork Chops	1-inch thick	HI	3	well	12–14	10–12

*The bottom rack position is #1.

Programmed Oven Operations

The Programmed Oven Operations feature is used to turn the oven off at a preset time of day or delay the start and then turn off the oven.

This feature will not operate unless the clock is functioning and is set to the correct time of day.

If you delay more than 30 seconds between touching a pad and pressing the ▲ or ▼ pad, the display will either return to the previous setting or the time of day will reappear and the program will cancel.

To recall the preset stop time or cook time, just press the corresponding pad.

To reset or cancel the program, press the CANCEL pad.

IMPORTANT: Highly perishable foods such as dairy products, pork, poultry, seafood or stuffing are not recommended for delayed cooking. If cooking more than one food, select foods that cook for the same length of time and at the same oven temperature.

To Bake by Time (with immediate start):

1. Place the food in the oven.
2. Press the COOK TIME pad. The words "Set Cook Time" will flash in the display.
3. Enter the cooking time (how long you wish the food to cook) by pressing the ▲ or ▼ pad. The time will appear in hours and minutes. The maximum time that can be set is 11 hours and 55 minutes.
4. Press the OVEN TEMP pad. The word "Bake" and 000° will light in the display. If this step is not done within 7 seconds after entering the cook time, the control will beep until another pad is pressed.
5. Enter the oven temperature with the ▲ or ▼ pad.
6. The oven will automatically turn on and the words "Timed Bake On" will light in the display. The display will begin to count down the time remaining.
7. **At the end of the preset cooking time, the oven will automatically turn off and continuous beeps will sound.** Remove the food from the oven and press the CANCEL pad to stop the beeps.

Example for Immediate Start:

Food is to cook for 1½ hours at 350°F.

1. Press the COOK TIME pad.
2. Press the ▲ pad until 1:30 (1 hour, 30 minutes) appears in the display.
3. Press the OVEN TEMP pad.
4. Press the ▲ pad until 350° appears in the display. The oven will turn on immediately.



To Bake by Time (with delayed start):

1. Place the food in the oven.
2. Press the COOK TIME pad. The words "Set Cook Time" will flash in the display.

3. Enter the cooking time (how long you wish the food to cook) by pressing the ▲ or ▼ pad. The time will appear in hours and minutes. The maximum time that can be set is 11 hours and 55 minutes. **NOTE:** The oven automatically programs the start time.
4. Press the OVEN STOP pad. The words "Set Stop Time" will flash in the display.
5. Enter the time you wish the oven to turn off by pressing the ▲ or ▼ pad. The words "Delay Stop Time" will light in the display.
6. Press the OVEN TEMP pad. The word "Bake" and 000° will light in the display.
7. Enter the oven temperature by pressing the ▲ or ▼ pad.
8. If desired, press the CLOCK pad and the time of day will reappear in the display.
9. "Delay Bake" will light in the display and at the preset time the oven will automatically turn on and "Timed Bake" will appear in the display.
10. **At the end of the preset cooking time, the oven will automatically turn off and continuous beeps will sound.** Remove the food from the oven and press the CANCEL pad to stop the beeps.

Example for Delay Start:

Food is to cook for 2½ hours at 350°F. You wish the food to be cooked by 6:00.

1. Press the COOK TIME pad.
2. Press the ▲ pad until 2:30 (2 hours, 30 minutes) appears in the display.
3. Press the OVEN STOP pad.
4. Press the ▲ pad until 6:00 appears in the display.
5. Press the OVEN TEMP pad.
6. Press the ▲ pad until 350° appears in the display.



The oven will turn on at 3:30, cook the food for 2½ hours and will automatically turn off at 6:00. Press the CANCEL pad to stop the beeps.

CARE AND CLEANING

WARNING: Before cleaning, be certain all the elements are turned off and the range is cool.

Porcelain Enamel Cooktop

All spillovers, especially acidic spillovers, should be wiped up as soon as possible with a dry cloth. To prevent possible cracking or chipping of the porcelain, never wipe a warm or hot surface with a damp cloth.

Do not use abrasive or caustic cleaning agents on the porcelain finish. Abrasive cleaners will permanently damage the finish.

Porcelain Drip Bowls

Clean bowls frequently. Remove soiled bowls by first removing the coil elements (see page 8). To clean by hand, soak in hot, sudsy water. Use a mild abrasive cleaner or soap-filled scouring pad for hard to remove soil.

Bowls may also be washed in an automatic dishwasher or placed on newspapers and sprayed with commercial oven cleaner. For heavy soils, spray with oven cleaner and place in plastic bag overnight. Follow the manufacturer's instructions. **CAUTION:** When using oven cleaner, spray carefully. Spraying other areas could damage finishes.

Manual-Clean Oven (select models)

Clean as directed in the cleaning chart on pages 14-15.

Self-Clean Oven (select models)

A self-clean oven uses above normal cooking temperatures to automatically clean the entire oven. The separate clean cycle eliminates soil completely or reduces it to a gray ash which is easily wiped up with a damp cloth when the cycle is complete and the oven has cooled.

It is better to clean the oven regularly than to wait until there is a heavy build-up of soil in the oven.

It is normal for the cooktop, oven door and window to become hot during a clean cycle. Therefore, avoid touching these areas during a clean cycle. As the oven heats and cools, you may hear the sounds of metal parts expanding and contracting. This is normal and will not damage your oven.

The first few times the oven is cleaned, some smoke and odor may be detected. This is normal and will lessen or disappear with use. If the oven is heavily soiled, smoke and odor are common. During the cleaning process the kitchen should be well ventilated.

The oven will automatically begin to heat when the door is locked and the SELF CLEAN pad is pressed. **When the oven reaches cleaning temperature, the word "Lock" will light in the display. At this point, the oven door cannot be manually opened.**

To prevent damage to the door and lock lever, do not force the door open when the word "Lock" is displayed.

DO NOT USE COMMERCIAL OVEN CLEANERS IN THE SELF-CLEAN OVEN.

Preparing for the Self-Clean Cycle

1. Remove oven racks and any pans, utensils or the broiler pan from the oven. The oven racks should be washed by hand. **If left in the oven during the self-clean cycle, the racks will become permanently discolored and may not slide easily.**
2. Clean the oven frame and door frame with a non-abrasive cleaning agent such as Bon Ami. These areas are not exposed to cleaning temperatures and should be cleaned to prevent soil from baking on during the clean cycle.
3. Wipe up any excess grease or spillovers from the oven bottom to prevent excessive smoking and flare-ups during the clean cycle.

4. Wipe up acid spillovers such as lemon juice, tomato sauce or milk-based sauces and sugary spillovers. Porcelain enamel is acid resistant, not acid proof. **The porcelain finish may discolor if acid spills are not wiped up prior to a self-clean cycle.**
5. **Do not use oven cleaners or oven liner protective coatings of any kind on the self-clean oven finish or around any part of the oven as they will damage the oven finish.**
6. To prevent damage, do not clean or rub the gasket on the oven door. The gasket is designed to seal in heat during the clean cycle.
7. Turn off the oven light before starting the self-clean operation. If the oven light is left on during the clean cycle, the light bulb will burn out.

Setting the Controls for the Self-Clean Cycle

1. Close the oven door and move the door lock lever to the right until it rests in the lock position.
2. Press the SELF CLEAN pad. The words "Set Clean Time" will flash and "3:00" will appear in the display. Also, "Clean On" will light as the oven begins to heat. The oven will automatically set a clean cycle of three hours. A shorter (2 hours) or longer (4 hours) clean cycle can be selected by pressing the SELF CLEAN pad and pressing the ▲ or ▼ pad to select 2 to 4 hours.
3. Press the CLOCK pad and the current time of day will reappear in the display. "Clean" and "On" will remain in the display to show that the oven is in a clean cycle.

If the door is not locked properly, the word "door" will appear in the display and beeps will sound.

To Interrupt or Reset the Clean Cycle

If the door has not locked, the lock lever can be moved completely to the left to cancel the cycle.

If the door is locked, push the CANCEL pad. The door will not open until "Lock" turns off in the display. At that time, the door lock lever can be returned to its original position and the door can be opened. The oven will still be hot.

After the Self-Clean Cycle

About one hour after the clean cycle is complete, the word "Lock" will turn off in the display and the door lever can be returned to its original position. The oven will still be hot.

Some soil may leave a light gray, powdery ash which can be removed with a damp cloth. If soil remains, it indicates that the clean cycle was not long enough or a large spillover was not wiped up before the self-clean cycle. The soil should be removed during the next clean cycle.

If the oven racks were left in the oven during the self-clean cycle and do not slide smoothly, wipe the rack edges and rack supports with a small amount of vegetable oil to restore the ease of movement.

Fine hair-like lines may appear in the oven interior or oven door. This is a normal condition resulting from the heating and cooling of the porcelain finish. These lines do not affect the performance of the oven.

For more information on cleaning your Maytag range, refer to the following cleaning chart, pages 14-15.

RANGE CLEANING CHART

Cleaning Agents*

Many different cleaning agents are recommended for the various parts of the range. **Read product labels for specific recommendations.** The following brand names may help you to make an appropriate selection:

1. Mild abrasive cleaners such as Bon Ami, Soft Scrub, Smart Scrub, Baking Soda.
2. Mild liquid sprays such as Fantastik, Formula 409.
3. Glass cleaners such as Windex and Glass Plus.
4. Non-abrasive plastic and nylon scouring pads.

DO NOT USE abrasive cleansing powders such as Comet, soap-filled scouring pads like S.O.S. or Brillo, commercial oven cleaners, or an automatic dishwasher **except when indicated.**

Be certain all range parts are cool before removing any part or cleaning the unit to avoid damage. Any parts that are removed for cleaning should be replaced correctly.

*Brand names of cleaning agents are trademarks of the respective manufacturers.

Parts	Cleaning Agents	Tips and Precautions
Baked Enamel: Side Panels Storage Drawer Subtop	Soap and water Mild liquid cleaner Glass cleaner	Wash, rinse, dry with soft cloth. Do not use oven cleaner or abrasive agents.
Broiler Pan and Insert	Soap and water Plastic or soap-filled scouring pad Dishwasher	Pretreat the broiler pan and insert with a non-stick vegetable coating such as Pam or Mazola to make cleaning easier. Soaking makes cleaning easier.
Control Knobs	Soap and water Mild liquid sprays Glass cleaners	Remove knobs by pulling forward. Wash, rinse, dry with soft cloth. Do not soak knobs in water. Do not use abrasive cleaning agents.
Glass Oven Window/Door	Soap and water Glass cleaners	Avoid using excessive amounts of water which may seep under or behind glass.
Manual Clean Oven Interior (select models)	Soap and water Mild abrasive cleaners and plastic pads Commercial oven cleaner	Do not use metallic scouring pads because they will scratch the surface. When using commercial oven cleaners follow the manufacturer's instructions. Wipe up acid spills (lemon, tomato or milk based foods) as soon as oven is cool with soap and water. If the spill is not wiped up, it may discolor the porcelain. To make cleaning easier, remove oven door, if desired (see page 15).
Metal Finishes and Trim Door Handle	Soap and water Mild abrasive cleaners	Do not use oven cleaner or abrasive agents. Polish with a soft cloth.
Oven Racks	Soap and water Plastic scouring pads Cleansing powders Soap-filled scouring pads	If racks are left in oven during a self-clean cycle (select models) they will discolor and may become difficult to slide. A thin coat of vegetable oil on the rack edges will make sliding easier.

Continued on next page

Range Cleaning Chart (continued)

Parts	Cleaning Agents	Tips and Precautions
Plastic Finishes: Back Panel End Caps	Soap and water Mild liquid sprays	Do not use oven cleaner, abrasive or caustic cleaning agents on plastic finishes. These cleaning agents will scratch or mar the finish. To prevent staining or discoloration, remove fat, grease or acid (tomato, lemon, vinegar, milk, fruit juice, marinade) soils immediately with a dry paper towel or cloth. When surface is cool, clean with soap and water; rinse, and dry.
Porcelain Drip Bowls	Soap and water Mild abrasive cleaners Soap-filled scouring pads Dishwasher Commercial oven cleaners	Frequently wash, rinse and dry to prevent soil build-up. Soak in hot, sudsy water. Use mild abrasive cleaners and soap-filled scouring pads, if necessary. For difficult soils, remove, place on newspapers and spray carefully with commercial oven cleaner. Place in plastic bag overnight for heavy soils. Follow manufacturer's instructions. DO NOT COVER WITH ALUMINUM FOIL.
Porcelain Enamel Cooktop	Soap and water Mild abrasive cleaners Mild liquid sprays	Wipe up all spillovers immediately with a dry cloth—especially acid spills (milk, fruits, tomato, etc.). Never wipe a warm or hot surface with a damp cloth as cracking and chipping may result. NOTE: Do not use abrasive cleaning agents such as steel wool pads. These products will scratch the surface.
Self-Clean Oven Interior (select models)	Follow instructions on pages 12–13 for the self-clean cycle.	Never use oven cleaner on a self-clean oven. Do not clean or rub door gasket. Wipe up acid spills (lemon, tomato or milk based foods) as soon as oven is cool with soap and water. If the spill is not wiped up, it may discolor the porcelain.

To Remove Oven Door: Open the door to the “stop” position (opened about 6 inches) and grasp the door with both hands at each side. Do not use the door handle to lift the door. Lift up evenly until the door clears the hinge arms.

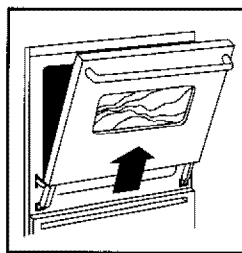

CAUTION: Hinge arms are spring mounted and will slam shut against the range if accidentally hit. **Never place your hand or fingers between the hinges and the front oven frame.** You could be injured if the hinge snaps back.

To Replace Oven Door: Grasp the door at each side, align the slots in the door with the hinge arms and slide the door down onto the hinge arms until it is completely seated on the hinges.

Do not attempt to open or close the door until the door is completely seated on the hinge arms. Never turn the oven on unless the door is properly in place. When baking, be sure the door is completely closed. Baking results will be affected if the door is not securely closed.

MAINTENANCE

Adjusting the Oven Thermostat

After using your oven the first few times, it may seem hotter or cooler than your previous oven. Oven thermostats, over a period of years, may drift from the factory setting and timing differences of 5 to 10 minutes are not unusual between an old and a new oven.

If you think the oven should be hotter or cooler, you can adjust it. To decide how much to change the thermostat, set the oven temperature 25°F higher or lower than the temperature in your recipe, then bake. The results of the "test" should indicate how much the thermostat should be adjusted.

To adjust the thermostat:

1. Press the OVEN TEMP pad.
2. Press the ▲ pad and select an oven temperature between 500°F and 550°F.
3. Press and hold the OVEN TEMP pad for about four seconds. The display will change to the oven adjustment display which reads 00°.
4. The oven thermostat can be adjusted up to +35°F hotter or -35°F cooler. Use the ▲ or ▼ pad to select the desired change in the display.
5. When you have made the adjustment, press the CANCEL pad to return to the time of day display. Use your oven as you would normally.

NOTE: This adjustment will not affect Broil or Self-Clean (select models) temperatures. The new temperature will be remembered if the power is interrupted.

Storage Drawer

The storage drawer in the range is a safe and convenient place for storing cookware. **Do not** store plastic, paperware, food or flammable material in this drawer. Remove the drawer to clean under the range.

To remove: Empty the drawer then pull it out to the first stop position. Lift up the front of the drawer and pull it to the second stop position. Grasp the sides and lift up and out to remove the drawer.

To replace: Fit the ends of the drawer glides onto the rails. Lift up the drawer front and gently push in to the first stop position. Lift up the drawer again and continue to slide the drawer to the closed position.

Leveling Legs

Some floors are not level. For proper baking, your range must be level. The leveling legs are located on each corner of the base of the range.

Place a level horizontally on an oven rack and check front-to-back and side-to-side. Level the range by turning the legs.

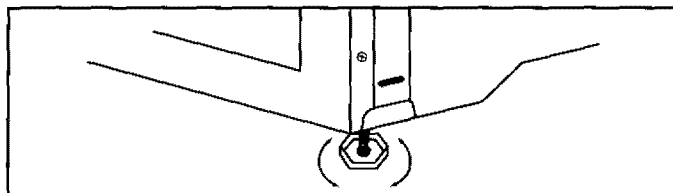

WARNING: To reduce the risk of accidental tipping of the range, it must be secured by an anti-tip device. To check if the device is installed properly, use a flashlight and look underneath the range to see that one of the rear leveling legs is engaged in the bracket slot.

Light Replacement

Before replacing the oven or panel light bulb, **disconnect power to range.** Be sure the bulb and range parts are cool. Do not touch a hot bulb with a damp cloth as the bulb may break.

To Replace Panel Light (select models)

Grasp the top trim of the back panel with your thumbs under the front edge and pull outward while lifting the trim. Remove the bulb and replace it with an 18 watt fluorescent tube. Snap the top trim back into place and restore the power. Reset the clock.

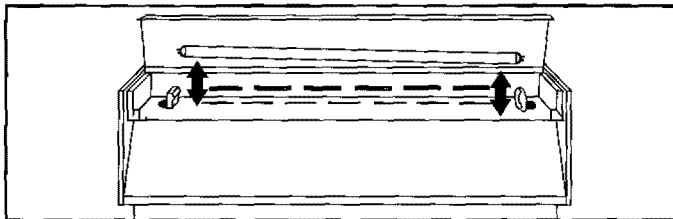

To Replace Oven Light

Carefully unscrew the lens cover (select models) with a dry potholder. Very carefully remove the bulb with the potholder. Replace with a 40 watt appliance bulb. Reconnect the power to the range and reset the clock.

BEFORE YOU CALL FOR SERVICE

Check these points if...

Part or all of your electric range does not operate

- Is the range plug loose or disconnected from the electrical outlet (if not wired direct to the electrical supply)?
- Are any house fuses blown or circuit breakers tripped?
- Has a range fuse blown (Canadian ranges only)?
- Has the power supply to the home been interrupted?
- Are the oven controls properly set?
- Was the door left in the locked position following a self-clean cycle (select models)?
- Is the oven set for a programmed oven operation?

Surface elements fail to turn on or heat the food properly

- Is the range plug loose or disconnected from the electrical outlet (if not wired direct to the electrical supply)?
- Has a range fuse blown (Canadian ranges only)?
- If the range has coil elements, are they properly plugged into the receptacles?
- Were appropriate pans used (See “Cooking Made Simple” booklet)?
- Are the surface element controls properly set?

Food not baking correctly

- Are the oven racks properly placed for baking (See “Cooking Made Simple” booklet)?
- Have you used aluminum foil correctly?
- Was the oven preheated as recommended?
- Are the controls for bake operations properly set?
- Is there 1 to 2 inches of space between pans and the oven walls? Are the range and oven racks level?
- Was good cookware/bakeware of the proper size used?
- Are you using a tested recipe from a reliable source? The oven thermostat on your new range may be more accurate than the one on your old range.
- Was the oven vent covered or blocked on the range surface?

Food does not broil properly

- Are the controls for broiling set properly? (See Broiling section, page 10.)
- Was the proper rack position used? (See Broiling section, page 10.)
- Did you allow time for the broil element to preheat?
- Was the broiler pan received with the range used?
- Was aluminum foil used on the broiler pan insert, blocking the slits for fat drainage?

Oven light does not operate

- Is the bulb loose or burned out?
- Is the light switch in the On position?

Oven will not self-clean (select models)

- Is the self-clean control set properly? (See Self-Clean instructions, pages 12–13.)
- Is the oven set for a programmed oven operation?

Oven door won't lock (select models)

- Are the proper controls set for the self-clean cycle? (See Self-Clean instructions, pages 12–13.)

Oven door will not unlock (select models)

- Has the self-clean cycle been finished for at least one hour?

“F” plus a number appears in the display (select models)

- These are fault codes. If a fault code appears in the display and a continuous beep sounds, press the CANCEL pad. If the fault code reappears, disconnect power to the range and call a qualified service technician.

Fan sound (select models)

- A fan will automatically turn on when the oven is operated to cool the clock controls. This is normal. It may continue to run even after the oven is turned off.

For further assistance contact your Maytag dealer or call Maytag Customer Service:

U.S. 1-800-688-9900

CANADA 1-800-688-2002

RANGE WARRANTY

Full One Year Warranty

For **one (1) year** from the date of original retail purchase, any part which fails in normal home use will be repaired or replaced free of charge.

Limited Warranty

After the first year from the date of original retail purchase through the second year, parts which fail in normal home use will be repaired or replaced free of charge for the part itself, with the owner paying all other costs, including labor, when the appliance is located in the United States or Canada.

Third Through Fifth Year

After the second year from the date of original retail purchase through the fifth year, all of the following components which fail in normal home use will be repaired or replaced free of charge for the part itself, with the owner paying all other costs, including labor, when the appliance is located in the United States or Canada.

These components include:

All Electronic Clocks: on electric or gas ranges.

Electric Heating Elements: Includes all surface elements (solid disc, coil and smooth top), glass cooking surfaces, broil elements and oven bake elements on electric ranges.

Third Through Tenth Year

After the second year from the date of original retail purchase through the tenth year, sealed gas burners on gas ranges which fail in normal home use will be repaired or replaced free of charge for the part itself, with the owner paying all other costs, including labor, when the appliance is located in the United States or Canada.

Canadian Residents

This warranty covers only those appliances installed in Canada that have been listed with Canadian Standards Association unless the appliances are brought into Canada due to transfer of residence from the United States to Canada.

Limited Parts Warranty Outside The United States Or Canada

For two (2) years from the date of original retail purchase, any part which fails in normal home use will be repaired or replaced free of charge for the part itself, with the owner paying all other costs, including labor, when the appliance is located outside the United States or Canada.

This Warranty gives you specific legal rights, and you may also have other rights which vary from state to state.

To Receive Warranty Service

To locate an authorized service company in your area contact the Maytag dealer from whom your appliance was purchased; or call Maytag Customer Service. Should you not receive satisfactory warranty service, call or write:

Maytag Customer Assistance
% Maytag Customer Service
P.O. Box 2370
Cleveland, TN 37320-2370
US 1-800-688-9900
CANADA 1-800-688-2002

When contacting Maytag Customer Service be sure to provide the model and serial numbers of your appliance, the name and address of the dealer from whom you purchased the appliance and the date of purchase.

Should you still have a problem, write to: Major Appliance Consumer Action Program, 20 North Wacker Drive, Chicago, Illinois 60606. MACAP is an industry sponsored but independent group of consumer experts who receive and act on complaints from appliance owners.

NOTE: When writing about an unsolved service problem, please include the following information:

- (a) Your name, address and telephone number;
- (b) Model number and serial number (found on the data plate) of your appliance;
- (c) Name and address of your dealer and date the appliance was bought;
- (d) A clear description of the problem you are having.

During the Self-Clean Cycle

The oven will automatically begin to heat up when the door lock lever is moved to the right and the SELF CLEAN pad is pressed. When the oven reaches cleaning temperature, the word Lock will light in the display. At this point, the oven door cannot be manually unlocked and opened.

The first few times the oven is cleaned, some smoke and odor may be detected. This is normal and will lessen or disappear with use. During the cleaning process the kitchen should be well ventilated. If the oven is heavily soiled, heavier smoke and odor may occur. Do not leave a soiled broiler pan in the oven during a self-clean cycle.

Avoid contact with the oven door and window since it will get warm during the self-clean cycle. As the oven heats and cools, you may hear sounds of the metal parts expanding and contracting. This is normal and will not damage your range.

To prevent damage to the door and the lock lever, do not force the door open when the word Lock is displayed.

After the Self-Clean Cycle

About one hour after the clean cycle is complete, the word Lock will turn off in the display and the door lever can be returned to its original position. The oven will still be hot.

Some soil may leave a light gray, powdery ash which can be removed with a damp cloth. If a stain remains, it indicates that the clean cycle was not long enough or a large spillover was not wiped up before the self-clean cycle. The stain should be removed during the next clean cycle.

If the oven racks were left in the oven during the self-clean cycle and do not slide smoothly, wipe the racks and embossed rack supports (on the oven walls) with a small amount of vegetable oil to restore the ease of movement.

Fine hair-like lines may appear in the oven interior or oven door. This is a normal condition resulting from the heating and cooling of the porcelain finish. These lines do not affect the performance of the oven.

For more information on cleaning your Maytag range, refer to the cleaning chart on pages 20 and 21.

Range Cleaning Chart

Cleaning Agents*

Many different cleaning agents are recommended for the various parts of the range. The following brand names may help you to make an appropriate selection:

1. Mild abrasive cleaners such as Bon Ami, Soft Scrub, Bar Keepers Friend, Cameo.
2. Mild liquid sprays such as Fantastik, Formula 409.
3. Glass cleaner such as Windex, Glass Plus, Cinch.
4. Non-abrasive plastic and nylon scouring pads.

DO NOT USE abrasive cleansing powders such as Zud, soap-filled scouring pads like S.O.S. or Brillo, commercial oven cleaners, or an automatic dishwasher detergent **except when indicated.**

Be certain all range parts are cool before removing any part or cleaning the unit to avoid damage. Any parts that are removed for cleaning should be replaced correctly.

* Brand names of cleaning agents are trademarks of the respective manufacturers.

Range Cleaning Chart

Parts	Cleaning Agents	Tips and Precautions
Baked Enamel: <ul style="list-style-type: none"> • Side Panels • Control Panel • Storage Drawer • Subtop 	<ul style="list-style-type: none"> • Soap and water • Mild liquid cleaner • Glass cleaner 	Wash, rinse, dry with soft cloth. Do not use oven cleaner or abrasive agents.
Black Porcelain Drip Bowls	<ul style="list-style-type: none"> • Soap and water • Mild abrasive cleaners • Plastic scouring pads • Self-clean oven • Dishwasher 	After each use, wash, rinse and dry to prevent difficult soils. To clean by hand, soak in hot sudsy water, then use mild abrasive cleaner and plastic scouring pad. Can be cleaned in self-clean oven. See page 18 for instructions. Right rear bowl has hole in it for oven venting. Do not cover with aluminum foil.
Broiler Pan and Insert	<ul style="list-style-type: none"> • Soap and water • Plastic or soap-filled scouring pad • Dishwasher 	Pretreat the broiler pan and insert with a non-stick vegetable coating such as Pam or Mazola to make cleaning easier. Soaking makes cleaning easier.
Chrome Drip Bowls and Rings <ul style="list-style-type: none"> • Brown food stains 	<ul style="list-style-type: none"> • Soap and water • Plastic scouring pads • Mild abrasive cleaners • Soap-filled scouring pads • Ammonia 	After each use, wash, rinse and dry to prevent difficult soils. If heavily soiled, place an ammonia-soaked paper towel on stains to loosen soil, then gently scrub with plastic scouring pad. If soil is allowed to burn on, may be impossible to remove (gently use scouring pads).
<ul style="list-style-type: none"> • Blue/gold heat stains 	<ul style="list-style-type: none"> • Flitz Metal Polish (Follow package directions) 	These stains are caused by overheating, normally occur over a period of time, and usually are permanent. To minimize: <ol style="list-style-type: none"> 1. Avoid excessive use of the high heat setting. Use it only to start cooking, then lower the heat setting to finish cooking. 2. Use flat bottom pans that do not extend more than two inches from the surface element. If large pans or canners are used, alternate the elements that are used. A non-abrasive metal polish such as Flitz may be used to help remove stains. Flitz is available in many automotive supply and hardware stores. Call 800-558-8611 for the distributor in your area
Control Knobs	<ul style="list-style-type: none"> • Soap and water • Mild liquid sprays • Glass cleaners 	Wash, rinse, dry with soft cloth. For ease of cleaning, remove knobs by pulling forward.

(Continued next page)

Range Cleaning Chart (continued)

Parts	Cleaning Agents	Directions
Glass (Select Models) • Oven Window/Door	<ul style="list-style-type: none"> • Soap and water • Glass cleaner 	Avoid using excessive amounts of water which may seep under or behind glass.
Metal Finishes and Trim	<ul style="list-style-type: none"> • Soap and water • Mild abrasive cleaners 	Do not use oven cleaner or abrasive agents. Remove stubborn soil with a paste of mild abrasive cleaner and water. Polish with a soft cloth.
Oven Racks	<ul style="list-style-type: none"> • Soap and water • Plastic scouring pad • Cleansing powders • Soap-filled scouring pads 	If racks are left in oven during a self-clean cycle they will discolor and may become difficult to slide. A thin coat of vegetable oil on the underside of the rack will make sliding easier.
Plastic Finishes: • Door Handle • Control Panel Trim • Endcaps	<ul style="list-style-type: none"> • Soap and water • Paste of baking soda and water 	Do not use oven cleaner, powder or liquid cleansers, abrasive or caustic cleaning agents on plastic finishes. These cleaning agents will scratch or mar the finish. To prevent staining or discoloration, remove fat, grease or acid (tomato, lemon, vinegar, milk, fruit juice, marinade) soils immediately with a dry paper towel or cloth. When surface is cool, clean with soap and water; rinse, and dry.
Porcelain Enamel Top and Back Panel	<ul style="list-style-type: none"> • Soap and water • Mild abrasive cleaners • Mild liquid sprays 	Wipe up all spillovers immediately with a dry cloth - especially acid spills (milk, fruits, tomato, etc.). Never wipe a warm or hot surface with a damp cloth as cracking and chipping may result.
Self-Clean Oven Interior	<ul style="list-style-type: none"> • Follow instructions on page 18 for the self-clean cycle. 	Never use oven cleaner on a self-clean oven. Do not clean or rub door gasket.

MAINTENANCE

Adjusting the Oven Thermostat

After using your oven the first few times, it may seem hotter or cooler than your previous oven. Oven thermostats, over a period of years, may drift from the factory setting and timing differences of 5 to 10 minutes are not unusual between an old and a new oven. You may be inclined to think that the new oven is not performing correctly; however, your new oven has been set correctly at the factory and is more likely to be accurate than the oven it replaced.

If you think the oven should be hotter or cooler, you can adjust it yourself. To decide how much to change the thermostat, set the oven temperature 25°F higher or lower than the temperature in your recipe, then bake. The results of the "test" should give you an idea of how much the thermostat should be changed.

To adjust the thermostat:

1. Press the OVEN TEMP pad.
2. Press the ▲ or ▼ pad and select an oven temperature between 500°F and 550°F.
3. Press and hold the OVEN TEMP pad for about four seconds. The display will change to the oven adjustment display which reads 00°.
4. The oven thermostat can be adjusted up to +35°F hotter or -35°F cooler. Use the ▲ or ▼ pad to select the desired change in the display.
5. When you have made the adjustment, press the CANCEL pad to return to the time of day display. Use your oven as you would normally.

NOTE: This adjustment will not affect Broil or Self-Clean temperatures. The new temperature will be remembered if the power is interrupted.

Leveling Legs

Some floors are not level. For proper baking, your range must be level. The leveling legs are located on each corner of the base of the range.

Place a level horizontally on an oven rack and check front-to-back and side-to-side. Level by turning the legs.

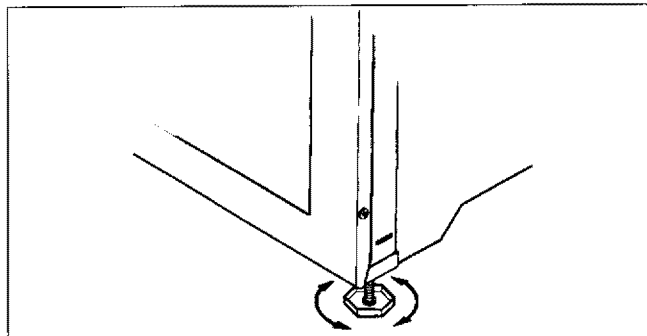

WARNING: To reduce the risk of accidental tipping of the range, it must be secured by a properly installed anti-tip device. To check if the device is installed properly, use a flashlight and look underneath the range to see that one of the rear leveling legs is engaged in the bracket slot. The anti-tip device secures the rear leveling leg to the floor, if properly engaged.

Fuses (Canadian Ranges Only)

Your range is equipped with seven (7) type "P" fuses. The fuses are located on the back wall. Remove the storage drawer for access to the fuses.

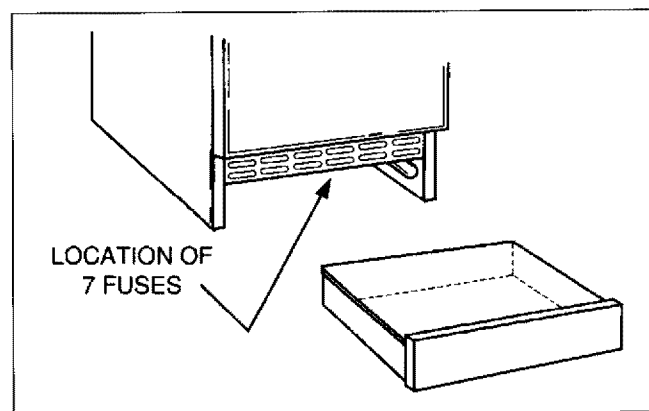

If part of your range does not operate, check to see if a fuse has blown. A gap in the fuse strip or a darkened window indicates a blown fuse. Replace with the same type and amperage "P" fuse.

Light Replacement

Before replacing the oven or panel light bulb, **disconnect power to range**. Be sure the bulb and range parts are cool. Do not touch a hot bulb with a damp cloth as the bulb may break.

To Replace Panel Light (select models)

Grasp the top trim of the backpanel with your thumbs under the front edge and pull outward while lifting to release the trim from the catches at each end. Remove the bulb and replace it with an 18 watt fluorescent tube. Snap the top trim back into place and restore the power. Reset the clock to the current time of day.

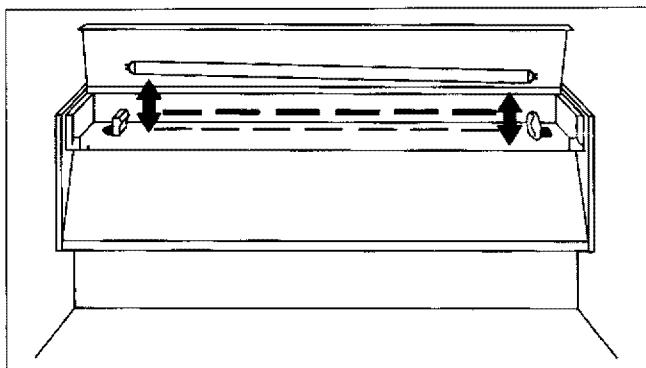

To Replace Oven Light

Very carefully unscrew the lens cover with a dry potholder to prevent possible harm to hands, then very carefully remove the bulb with a dry potholder. Replace with a 40 watt appliance bulb. Reconnect the power to the range and reset the clock to the current time of day.

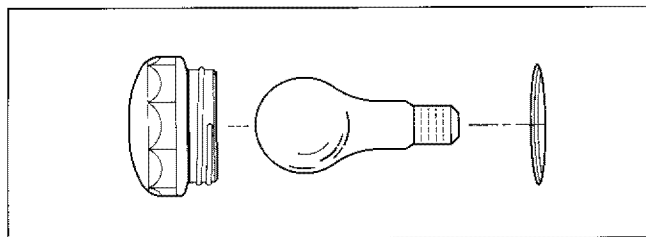

Oven Door

Do not place excessive weight on an open oven door or stand on an open oven door as, in some cases, it could damage the door, cause the appliance to tip over and possibly cause injury.

When opening the oven door, allow steam and hot air to escape before reaching into the oven to check, add or remove food.

To Remove Lift-Off Door

Open the oven door to the "stop" position (opened about 6 inches) and grasp the door with both hands at each side. Do not use door handle to lift door. Lift up evenly until the door clears the hinge arms. (Oven door window available on select models.)

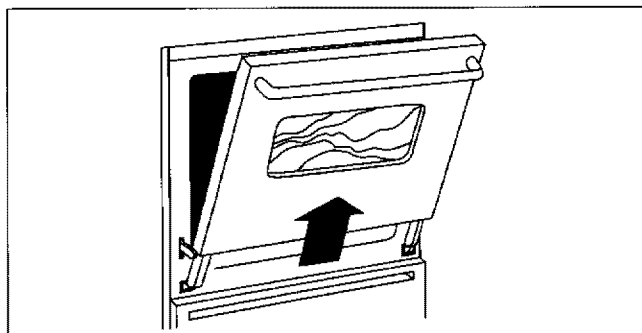

CAUTION: Hinge arms are spring mounted and will slam shut against the range if accidentally hit. **Never place your hand or fingers between the hinges and the front oven frame.** You could be injured if the hinge snaps back.

To Replace Door

Grasp the oven door at each side, align the slots in the door with the hinge arms and slide the door down onto the hinge arms until the door is completely seated on the hinges.

Do not attempt to open or close the oven door until the door is completely seated on the hinge arms. Never turn on oven unless the door is properly in place. When baking, be sure the door is completely closed. Baking results will be affected if the door is not securely closed.

BEFORE YOU CALL FOR SERVICE

Check these points if . . .

Part or all of your electric range does not operate

- Is the range plug loose or disconnected from the electrical outlet (if not wired direct to the electrical supply)?
- Are any house fuses blown or circuit breakers tripped?
- Has a range fuse blown (Canadian ranges only)?
- Has the power supply to the home been interrupted?
- Are the oven controls properly set?
- Was the electronic control (select models) correctly set?
- Was the door left in the locked position following a self-clean cycle? (select models).
- Is the oven set for delay start? (select models).

Surface elements fail to turn on or heat the food properly

- Is the range plug loose or disconnected from the electrical outlet (if not wired direct to the electrical supply)?
- Has a range fuse blown (Canadian ranges only)?
- If the range has coil elements, are they properly plugged into the receptacles?
- Were appropriate utensils used? (See Cookware Section).
- Are the surface element controls properly set?

Food not baking correctly

- Are the oven racks properly placed for baking? (See Baking Chart).
- Have you used aluminum foil correctly?
- Was the oven preheated as recommended?
- Are the controls for bake operations properly set?
- Is there 1 to 2 inches of space between pans and the oven walls? Are the range and oven racks level?
- Was good cookware/bakeware of the proper size used?

- Are you using a tested recipe from a reliable source? The oven thermostat on your new range may be more accurate than the oven on your old range.
- Was the oven vent covered or blocked on the range surface?

Food does not broil properly

- Are the controls for broiling set properly? (see Broiling section).
- Was the proper rack position used? (see Broiling section)
- Did you allow time for the broil element to preheat?
- Was the broiler pan received with the range used?
- Was aluminum foil used on the broiler pan insert, blocking the slits for fat drainage?

Oven light does not operate

- Is the bulb loose or burned out?
- Is the light switch in the On position.

Oven will not self-clean (select models)

- Is the self-clean control set properly? (see Self-Clean instructions).
- Is the oven set for delay start?

Oven door won't lock (select models)

- Are the proper controls set for the self-clean cycle? (see Self-Clean instructions).

Oven door will not unlock (select models)

- Has the self-clean cycle been finished for at least one hour?

"F" plus a number appears in the display (select models)

- These are fault codes. If a fault code appears in the display and a continuous beep sounds, press the CANCEL button. If the fault code reappears, disconnect power to the range and call a qualified service technician.

This appliance has been tested for safe performance using conventional cookware. Do not use any devices or accessories that are not specifically recommended in this manual. Do not use eyelid covers for the surface units, stove top grills,

or add-on oven convection systems. The use of devices or accessories that are not expressly recommended in this guide can create serious safety hazards, result in performance problems, and reduce the life of the components of the appliance.

Fault Codes

Your range is equipped with an electronic control featuring built-in, self-diagnostic software. This software continuously monitors the control to ensure safe and proper operation. If the software should detect a questionable situation, a FAULT CODE (F plus a number) will appear in the display and continuous beeps will sound.

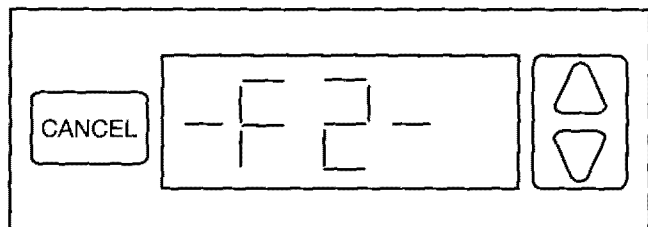

A fault code indicates that there may be a functional error. As a safety precaution, the control will automatically cancel the program. Follow the procedures described below to check the range.

During Normal Oven Cooking

If a fault code appears in the display, press the CANCEL pad and reprogram the cooking operation. If the fault code reappears, call a qualified service technician. Do not use the oven until the control has been serviced. The cooktop can be used.

During a Self-Clean Cycle

If the oven is heavily soiled, excessive smoke and flaring may result in a fault code. If this occurs, press the CANCEL pad and allow the oven to cool for an hour. Then, reprogram the oven for the clean cycle.

If the fault code reappears in the display, call a qualified service technician. Do not use the oven until the control has been serviced. The cooktop can be used.

RANGE WARRANTY

Full One Year Warranty

For one (1) year from the date of original retail purchase, any part which fails in normal home use will be repaired or replaced free of charge.

Limited Warranty

After the first year from the date of original retail purchase, through the second year, parts which fail in normal home use will be repaired or replaced free of charge for the part itself, with the owner paying all other costs, including labor, when the appliance is located in the United States or Canada.

Electric Heating Elements: After the second year from the date of original retail purchase, through the fifth year, all surface elements (solid disc, coil and smooth top), glass cooking surfaces, broil elements and oven bake elements on electric ranges, which fail in normal home use will be repaired or replaced free of charge for the part itself, with the owner paying all other costs, including labor, when the appliance is located in the United States or Canada.

Sealed Gas Burners: After the second year from the date of original retail purchase, through the tenth year, sealed gas burners on gas ranges, which fail in normal home use will be repaired or replaced free of charge for the part itself, with the owner paying all other costs, including labor, when the appliance is located in the United States or Canada.

Canadian Residents

This warranty covers only those appliances installed in Canada that have been listed with Canadian Standards Association unless the appliances are brought into Canada due to transfer of residence from the United States to Canada.

Limited Parts Warranty Outside The United States Or Canada

For two (2) years from the date of original retail purchase, any part which fails in normal home use will be repaired or replaced free of charge for the part itself, with the owner paying all other costs, including labor, when the appliance is located outside the United States or Canada.

This Warranty gives you specific legal rights, and you may also have other rights which vary from state to state.

To Receive Warranty Service

First: To locate an authorized service company in your area, contact the Maytag dealer from whom your appliance was purchased or call Maytag Customer Service:

USA 1-800-688-9900
CANADA 1-800-688-2002

Second: Should you not receive satisfactory warranty service from the dealer or authorized service firm, or need further assistance, call or write:

Maytag Customer Service
A division of Maytag Corporation
P.O. Box 2370
Cleveland, TN 37311
USA 1-800-688-9900
CANADA 1-800-688-2002

When contacting Maytag Customer Service be sure to include the model and serial numbers of your appliance, the name and address of the dealer from whom you purchased the appliance and the date of purchase.

Should you still have a problem, write to: Major Appliance Consumer Action Panel, 20 North Wacker Drive, Chicago, Illinois 60606. MACAP is an industry sponsored but independent group of consumer experts who receive and act on complaints from appliance owners.

NOTE: When writing about an unsolved service problem, please include the following information:

- (a) Your name, address and telephone number;
- (b) Model number and serial number (found on the data plate located on the frame around the storage drawer) of your appliance;
- (c) Name and address of your dealer and date the appliance was bought;
- (d) A clear description of the problem you are having.

MAYTAG • Newton, Iowa 50208

No question about it, cooking is a popular pastime. The secret to successful food preparation is to know and practice the basics. This booklet along with your cooking appliance User's Guide will help you solve any problem you may have.



Table of Contents

Surface Cooking	3-5
Proper Cookware	3-5
Heat Settings	5
Using Your Oven	6-7
General Tips	6
Baking Pans	7
Rack Positions	7
Pan Positions	7
Common Baking Problems and Causes	8-9
Roasting	10-11
Roasting Tips	10
Roasting Chart	11
Convection Baking and Roasting	12
General Convection Tips	13
Broiling	14-15
Broiling Tips	14-15
Other Publications Available From Maytag	15

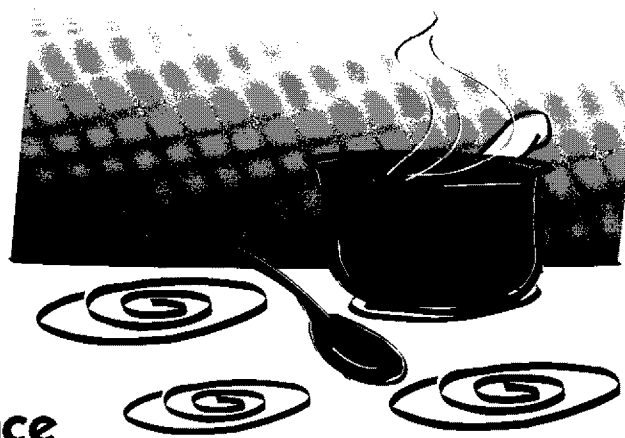

Surface Cooking

Regardless of the cooking surface used - coil elements, ceramic glass, standard gas burners or sealed gas burners - good results depend on several factors. Cookware construction, size and material; plus proper heat setting or flame size are critical for good results.

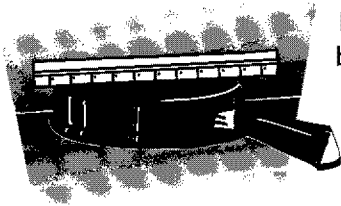

Proper Cookware

Proper pans will reduce cooking times, use less energy and cook food more evenly. Optimum cooking performance can be achieved when heavy gauge, flat, smooth bottom, metal pans with straight sides and tight fitting lids are used. When selecting cookware consider construction, material and size.

Flat Bottom Construction

Heat transfers primarily by conduction (contact). If the pan is not flat, heat is not transferred as well and food will cook unevenly and take longer. To determine the flatness of the bottom of a pan, try one of these tests:

Cooking Test: Put an inch of water into the pan. Place it on the cooktop and turn the control to High. As the water heats, observe the bubble formation. If the bubbles are uniform across the bottom of the pan, it will perform satisfactorily. Uneven bubble formation indicates poor pan/cooktop contact which causes hot spots and uneven cooking.

Ruler Test: Place the edge of a ruler across the bottom of the pan. Hold it up to the light. Little or no light should be visible under the ruler.

Pan Material

The pan material determines how evenly and quickly heat is transferred from the heat source to the pan bottom. Some widely used pan materials are:

Aluminum

Excellent heat conductor. Some foods will cause it to darken or pit. Anodizing improves stain resistance and pitting. Often used as a bottom coating to improve the heating of other pan materials. NOTE: Some aluminum pans will cause metal marks or scratches on glass ceramic cooktops if you slide them across the cooktop. Remove metal marks immediately.

Copper

Excellent heat conductor. Discolors easily, requires frequent polishing. Often used as a bottom coating to improve the heating of other pan materials.

Stainless Steel

Slow heat conductor. Develops hot spots and produces uneven cooking results. Durable, attractive, easy to clean and stain resistant. Will distribute heat better if other metals (aluminum or copper) are combined or sandwiched together as a bottom coating.

Cast Iron

Slow heat conductor. Needs seasoning to make cleaning easier and to prevent sticking and rusting.

Glass-Ceramic

Slow heat conductor. Easy to clean. Not recommended for ceramic glass surfaces as it may scratch the glass. Some types may only be used in the oven.

Porcelain-Enamel

Glass-like substance fused to metal. Heating characteristics depend on base material (usually aluminum, steel or cast iron). Available in colors and easy to clean.

Note: Brands of metal cookware that generally perform well on all types of cooktops are Magnalite Professional, Calphalon, some Revere Ware, and smooth bottom Club Aluminum.* Follow the manufacturer's recommendations.

*Brand names are the trademarks of respective manufacturers.

Pan Size

On electric cooktops, match the size of the pan to the coil element or indicated cooking area. Ideally, **the pan should not extend more than 1/2 -1" over the cooking area on ceramic glass cook-tops and not more than 2" beyond the element on coil cooktops.** Avoid using small pans on large elements to reduce energy loss and for safety reasons.

On gas cooktops, **adjust the burner flame so it does not extend beyond the edge of the pan.** This is for safety reasons and also to save energy.

Do not use oversized pans or pans that rest across two elements or burners. These may transfer heat to the porcelain cooktop which causes cracking or chipping. Likewise, on ceramic glass cooktops oversized pans (more than 1" beyond indicated cooking area) lengthen cooking times.

Home Canning Recommendations

Acceptable water-bath or pressure canners should not be oversized and should have flat bottoms. When canners do not meet these standards, cooking times may be extended and cooktops may be damaged. For best results, use a canner not more than 1" larger than the cooking area on a ceramic glass surface and not more than 2" larger than a coil element or gas burner.

When canning, use the High setting just until the water comes to a boil or pressure is reached in the pressure canner, then reduce to the lowest heat setting that maintains the boil or pressure. If the heat is not turned down, the cooktop may be damaged.

For more information on canning procedures, contact your local county Extension Office.

Heat Settings

It is better to select a lower setting and increase to a higher one later if needed. There are many factors that affect the choice of the heat setting.

Among these factors are:

- the type, flatness and size of the cookware.
- the cooking action desired.
- the quantity and type of food being cooked.
- the use of a lid (covering pans speeds cooking and saves energy).
- the voltage or gas type used.

Keep in mind that food does not cook any faster at a higher setting or flame size than that which maintains a gentle boil. Water boils at the same temperature, whether boiling vigorously or gently. If too high a setting is used, food may burn on the bottom before it is completely cooked.

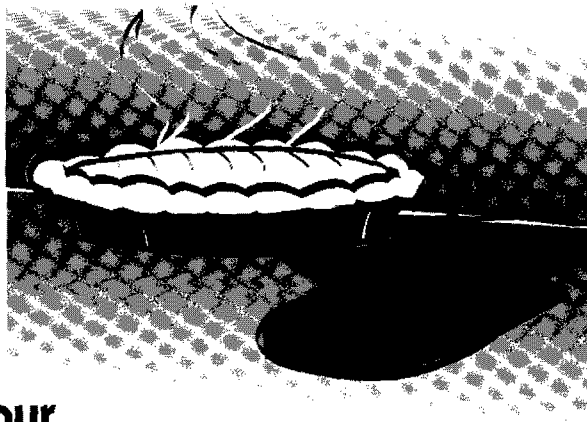

Using Your Oven

Delicious baking and roasting results depend on the recipe, type of pan used and the rack and pan positions.

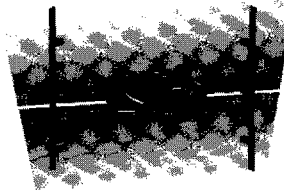

Pan Positions

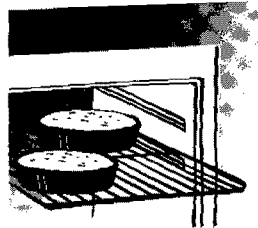

General Tips

As ranges and wall ovens get older, it is not uncommon for the oven temperature to shift. It is normal to notice some cooking time differences between a new oven and an old one. Compare your recipes with tested recipes for proper recommendations.

Use tested recipes from dependable cookbooks. Follow directions carefully and use fresh ingredients. Measure and mix as instructed and use the recommended pan size.

Preheat the oven if called for in the recipe or on the package directions. Preheating is NOT necessary for roasting. Selecting a temperature higher than the desired temperature will not preheat the oven any faster. In fact, this may have a negative effect on baking results.

Do not cover the entire oven rack or oven bottom with aluminum foil or place it directly under a pan. If needed to catch spill-overs from baked items, place a piece of foil cut a little larger than the pan on the rack below the pan. However, foil will reduce air flow and may cause poor baking results. In a gas oven, placing foil on the oven bottom may cause permanent damage to the porcelain enamel.

Most recipes provide minimum and maximum baking times such as “bake 35-45 minutes.” Check the baking progress at the minimum time. **DO NOT** open the door until the minimum time has elapsed. If the door is opened too frequently, heat will escape, which can affect baking results.

Baking Pans

Always use the pan size recommended in the recipe. Many pans have the measurements marked on them. If there are no measurements, measure **inside** width and length of the pan.

The finish on the pan affects the amount of browning.

- Dark or dull pans absorb heat resulting in darker browning, faster cooking and crisper crusts. Use this type of pan for pies and breads.
- Shiny, bright pans reflect heat, resulting in a lighter, more delicate browning. Cakes and cookies require this type of pan.
- When baking in glass and some very dark pans, lower the recommended oven temperature by 25°F. (This is not necessary when baking pies, breads or casseroles.)

Cookies baked in pans with short sides all around may result in lighter top browning or uneven top browning. **For best results select cookie sheets without sides.**

Frozen pies in foil pans should be placed on pans with dark or dull finishes for baking. The shiny foil pan reflects heat away from the pie decreasing browning while the dark pan helps absorb the heat and improves bottom browning.

Rack Positions

The correct rack position depends on the kind of food and the browning desired. As a general rule, center the rack in the middle of the oven. If food is placed on a rack toward the top of the oven, top browning may be too dark. If food is placed on a rack located near the bottom of the oven, the food may be too dark on the bottom. **Refer to the User's Guide for specific rack positions.**

Pan Positions

When baking foods in one pan, place pan in the center of the oven rack. When baking in more than one pan, allow one to two inches between the pans and the edge of the pan(s) and the oven walls.

If baking on more than one rack, stagger the pans so one pan is not directly over another pan.

Do not crowd a rack with pans. Never place more than one 9x13-inch or larger pan on one rack.

Do not place pans directly on the oven bottom.

Common Baking Problems and Causes

If you have carefully followed the basic instructions and still experience poor results, these suggestions may be helpful.

Problem

Slow baking
or roasting.

Cakes are
uneven.

Cakes high in
middle.

Cakes fall.

Cakes, cookies,
biscuits don't
brown evenly.

Cakes don't
brown on top.

Cakes, cookies,
biscuits too
brown on
bottom or top.

Cause

- Baking or roasting time too short.
- Temperature too low.
- Incorrect use of aluminum foil.
- Oven not preheated.
- Oven door opened frequently.
- Too many pans on rack.
- Oven out of calibration.
- Old oven out of calibration.

- Pans touching each other or oven walls.
- Batter uneven in pans.
- Uneven heat distribution in oven.
- Oven not level.
- Undermixing.
- Too much liquid.

- Temperature too high.
- Overmixing.
- Too much flour.
- Pans touching each other or oven walls.

- Too much shortening or sugar.
- Too much or too little liquid.
- Temperature too low.
- Old or too little baking powder.
- Pan too small.
- Oven door opened frequently.

- Incorrect rack position.
- Incorrect use of aluminum foil.
- Oven not preheated.
- Pans darkened, dented or warped.

- Incorrect rack position.
- Oven temperature too low.
- Overmixing.
- Too much liquid.
- Incorrect pan size or too little batter in pan.
- Oven door opened too often.

- Oven not preheated.
- Pans touching each other or oven walls.
- Using glass, darkened, warped or dull finish metal pans.
- Incorrect rack position.
- Incorrect use of aluminum foil.
- Oven temperature too high.

Crumbly or
dry texture

Uneven
texture

Cakes have
turners

Cakes crack
on top

Cakes not done
in center

Pie crust edges
too brown

Pies don't brown
on bottom

Pies slide
out of pans

Cause

- Too little leavening.
- Overmixing.
- Pan too large.
- Oven temperature too high.
- Baking time too long.
- Pans too close to each other or oven wall.
- Improper ingredient measurements.
- Old baking powder.
- Oven temperature too high.
- Baking time too long.
- Too much liquid.
- Undermixing.
- Oven temperature too low.
- Baking time too short.
- Not enough shortening.
- Overmixing.
- Oven temperature too high.
- Batter overmixed.
- Oven temperature too high.
- Too much leavening.
- Incorrect rack position.
- Baking pan too deep.
- Temperature too high.
- Pan too small.
- Baking time too short.
- Oven temperature too high.
- Pans touching each other or oven wall.
- Edges of crust too thin.
- Incorrect rack position.
- Using shiny metal pans.
- Temperature set too low.
- Temperature too low at start of baking.
- Filling too juicy.
- Using shiny metal pans.

*If similar problems occur when convection baking is done, make sure the oven temperature has been decreased by 25°F.

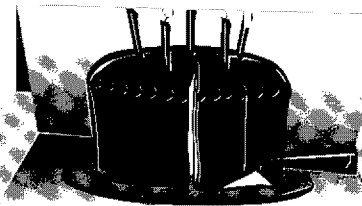



Roasting

Roasting is the method for cooking large, tender cuts of meat uncovered, without adding moisture.

For more information on roasting, contact the USDA Meat and Poultry Hotline at 1-800-535-4555.

Roasting Tips

- Preheating is not necessary.
- Place the oven rack in either of the two lowest rack positions.
- Use open pan roasting for tender cuts of meat, weighing three pounds or more. Place meat or poultry on the slotted portion of the two-piece broiler pan included with the oven. Do not add water to the pan.
- Place meat fat-side-up to allow self-basting of the meat during roasting.
- Cooking time for roasting is determined by the weight of the meat and the desired doneness. Use a meat thermometer for best results. Insert the thermometer so the tip end is in the center of the thickest part of the meat. It should not touch fat or bone. **Refer to the Roasting Chart on page 11 for best results.**
- Remove the roast from the oven when the thermometer registers approximately 5° below the doneness desired. Cooking will continue after the meat is removed from the oven.
- Less tender cuts of meat need to be roasted in a covered pan or in an oven cooking bag.

Regular & Convection Roasting Chart (Thawed Meats Only)

Cut of Meat	Approx. Weight (Pounds)	Oven Temperature (in °F)	Internal Temperature	REGULAR Approximate Roasting Time (min. per lb.)	CONVECTION Approximate Roasting Time (min. per lb.)
Beef					
Rib Roast (cut-side down)	4 to 8	325°F	145°F (med/rare) 160°F (med)	25-35 30-35	20-30 25-30
Rib Eye Roast	4 to 6	350°F	145°F (med/rare) 160°F (med)	25-35 30-35	20-30 25-30
Tenderloin Roast	2 to 3	400°F	145°F (med/rare)	20-30	15-25
Pork, Fresh					
Shoulder Blade Roast (boneless)	4 to 6	325°F	170°F	35-45	30-40
Shoulder Blade Roast	4 to 6	325°F	160°F	30-40	20-30
Loin Blade or Sirloin Roast	3 to 4	325°F	160°F	35-45	25-35
Boneless Pork Loin	6 to 8	325°F	160°F	25-30	20-25
Pork, Smoked					
Ham Half (fully cooked boneless)**	5 to 7	325°F	140°F	25-35	N/A
Ham Half (cook-before-eating)	5 to 7	325°F	160°F	35-45	30-40
Poultry					
Turkey, unstuffed***	12 to 16	325°F	180-185°F	18-20	12-16
" "	16 to 20	325°F	180-185°F	16-18	10-15
" "	20 to 24	325°F	180-185°F	14-16	8-10
Turkey Breast	3 to 8	325°F	170°F	30-40	25-35
Chicken Fryer	2 to 3 1/2	350-375°F	180-185°F	20-25	15-22
Chicken Roaster	4 to 6	350-375°F	180-185°F	20-25	15-20
Lamb					
Leg (boneless)	2 to 3	325°F	160°F (med) 170°F (well)	35-40 40-45	30-35 35-40
Whole Leg	5 to 7	325°F	160°F (med) 170°F (well)	30-35 35-40	25-30 30-35

- Cooking times are approximate and may vary depending on the shape of the roast.
- **Add water and follow package directions. Not recommended for Convection Roasting.
- ***Stuffed turkey requires additional roasting time. Shield legs and breast with foil to prevent overbrowning and drying of skin.

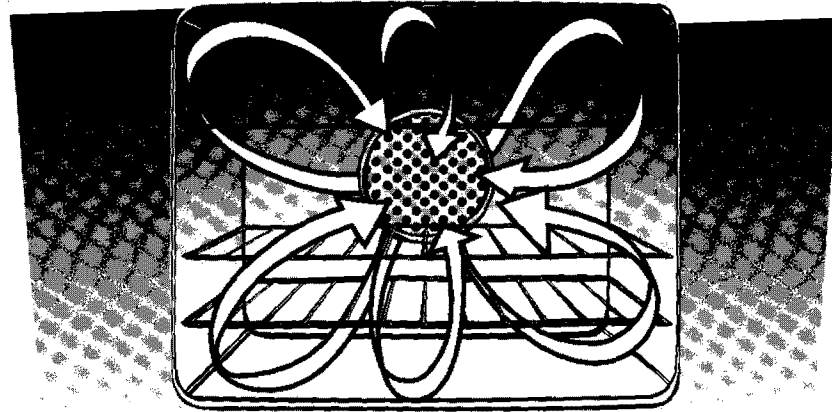

Convection Baking and Roasting

In a convection oven, a fan circulates hot air evenly over, under and around the food. As a result, foods are evenly cooked and browned - often in shorter cooking times at lower temperatures and with the flexibility of using more racks at one time.

Which Method Works Best for

Baking

- Convection baking is good for large quantities of baked foods such as cookies, biscuits, muffins, brownies, cupcakes, sweet rolls and bread.
- Foods such as layer cakes or quick breads have a more even top when baked with the regular conventional baking method.

Roasting

- Convection roasting, in most cases, takes less time and is good for large tender cuts of meat. Use uncovered roasting pans with low sides. Meats are generally dark brown on the outside and tender and juicy inside.
- Less tender cuts of meat are best roasted with the regular conventional method. The regular conventional method is also best when an oven cooking bag or covered dish is required.

General Convection Tips

Baking:

Reduce the oven temperature by 25° for convection baking. Times will be similar to or a few minutes less than recipe recommendations.

For multi-rack baking, it may be necessary to remove the pan on the bottom rack and/or top rack 1-2 minutes before the set time to prevent overbrowning.

Cookie sheets should be made of shiny metal without sides.

Three Rack Baking - For optimal browning, **place cookie sheets or rectangular (9"x13") pans lengthwise, front to back on the oven racks.** Arrange pans so they are directly over each other. Stacking pans one above the other centers the food in front of the convection fan which improves air circulation and browning. If pans are too long to place front-to-back, center the pans side-to-side on the racks.

Four Rack Baking - (This is based on the use of rack positions 2, 3, 4 and 5 with the lowest position being #1—recommended only on 30 inch width ovens.) Stagger the pans on the racks so that one pan is NOT directly over another pan. For example, on rack 2 place the pan within one inch of the left wall of the oven, on rack 3 place the pan within one inch of the right wall and so on.



Roasting:

Do not reduce oven temperature by 25° for convection roasting. However, **roasting times can be reduced up to 25% when using convection heat.**

Refer to the Roasting Chart on page 11 for best results.

Do not use a roasting pan with high sides.

Do not cover meat.

Since the breast meat and drumsticks on a turkey cook more quickly than the thigh areas, place a "foil shield" over these areas after desired brownness is reached to prevent overbrowning.



Broiling

Broiling is used for tender cuts of meat or marinated meats, fish and some fruits and vegetables. The food is placed directly under the top element or under the gas flame. The desired doneness is determined by the distance between the food and the heat source and the cooking time.

Broiling Tips

- When broiling in an electric oven, preheat 3-4 minutes for optimal browning.
- For best results, steaks and chops should be at least 3/4" thick. Thinner cuts should be panbroiled.
- Before broiling, trim excess fat to prevent excessive spattering or smoking. Cut slashes in the outer edges of the fat to prevent curling during cooking.
- Season meat after cooking. Salt tends to draw juices out of the meat and delay browning.
- Use the broiler pan supplied with your oven. It is designed to drain excess liquid and fat away from the cooking surface to prevent spatters and smoke.
- Do not cover the broiler insert with aluminum foil. This prevents fat from draining into the pan bottom. However, for easier clean-up, line the broiler pan (bottom portion) with foil and spray the insert with non-stick vegetable coating.
- The rack position selected for broiling depends on the thickness of the meat and the desired doneness. Thin cuts (3/4 to 1 inch) should be placed 2-3 inches from the heat; thicker cuts should be placed 3-6 inches from the heat.

Generally for a brown exterior and rare interior, the meat should be close to the element or flame. If you want the meat well done, place the broiler pan farther from the element or flame.

Increasing the distance between the meat and the heat source will decrease spattering and smoking.

When broiling in an electric oven, the door should be opened to the broil stop position (about 4"). When broiling with a gas oven, the door should be closed.

If the food requires turning, broil until the top side is brown. Turn only once during broiling. Meat should be approximately half cooked by the time the top is browned.

Consult the User's Guide for specific broiling times and rack positions.

Consumer Publications

For more information, order the following booklets from Maytag at the prices indicated. Send your name, address, booklet title, form number and payment to:

Maytag Consumer Education
One Dependability Square
Newton, IA 50208

Allow 4-6 weeks for delivery.

Cooktop Choices - 298YG	50¢
Energy Savings Tips - 392YG	50¢
Appliance Buying Guides	50¢ each
Washer	211YG
Dryer	212YG
Dishwasher	213YG
Refrigerators	276YG
Cooking Appliances	277YG

For more information contact:



Consumer Education
One Dependability Square
Newton, IA 50208
(515) 791-8402