

Installation Instructions

30" Gas Self-Clean Slide-In Range

Questions? Call 800.GE.CARES (800.432.2737) or visit our Website at: GEAppliances.com
In Canada, call 1.800.561.3344 or visit our Website at: www.GEAppliances.ca

BEFORE YOU BEGIN

Read these instructions completely and carefully.

- **IMPORTANT** — Save these instructions for local inspector's use.
- **IMPORTANT** — Observe all governing codes and ordinances.
- **Note to Installer** — Leave these instructions with appliance after installation is complete.
- **Note to Consumer** — Keep these instructions for future reference.
- **Note to Servicer** — The electrical diagram is in an envelope attached to the back of the range.
- Proper installation is the responsibility of the installer. Product failure due to improper installation is not covered under the Warranty.
- Installation of the range must conform with local codes or, in the absence of local codes, with the National Fuel Gas, ANSI Z223.1/NFPA 54, latest edition. In Canada, installation must conform with the current Natural Gas Installation Code, CAN/CSA-B149.1 or the current Propane Installation Code, CAN/CSA-B149.2, and with local codes where applicable. This range has been design-certified by Underwriter's Laboratories for use in the United States and Canada.

⚠ WARNING:

Fire and Explosion Hazard:

If the information in the manual is not followed exactly, a fire or explosion may result causing property damage, personal injury, or death.

- If you smell gas:
 - Open windows
 - Don't touch electrical switches.
 - Extinguish any open flame.
 - Immediately call your gas supplier.
- Do not store or use combustible materials, gasoline or other flammable vapors and liquids in the vicinity of this or any other appliance.
- Installation and service must be performed by a qualified installer, service agency or the gas supplier.
- Remove all packing material and literature from oven before connecting gas and electrical supply to the range.

IN THE COMMONWEALTH OF MASSACHUSETTS:

- This product must be installed by a licensed plumber or gas fitter.
- When using ball-type gas shut-off valves, they shall be the T-handle type.
- A flexible gas connector, when used, must not exceed 3 feet (91.4 cm).



⚠ WARNING

- All ranges can tip.
- BURNS or other SERIOUS INJURIES can result.
- INSTALL and CHECK the ANTI-TIP bracket following the instructions supplied with the bracket.

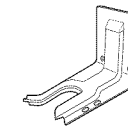

Anti-Tip Bracket
Kit Included

If you did not receive an anti-tip bracket with your purchase, call 1.800.626.8774 to receive one at no cost. (In Canada, call 1.800.561.3344.) For installation instructions of the bracket, visit: www.GEAppliances.com. (In Canada, www.GEAppliances.ca.)

⚠ WARNING:

Electrical Shock Hazard:

This appliance must be properly grounded in accordance with local codes or, in the absence of local codes, in accordance with the National Electrical Code (ANSI/NFPA 70, latest edition). In Canada, electrical grounding must be in accordance with the current CSA C22.1 Canadian Electrical Code Part 1 and/or local codes. See the Electrical Requirements section.

PRESSURE TEST INFORMATION

The maximum allowable supply pressure for the regulator is 14" W.C. The minimum supply pressure needed to check the regulator setting is 7" W.C. for natural gas and 10" W.C. for LP gas.

⚠ WARNING: The range and its individual shut-off valve must be disconnected from the gas supply piping system during any pressure testing of the gas supply system at test pressures of more than 1/2 psig (pounds per square inch gauge). The range must be isolated from the gas supply piping system by closing its individual shut-off valve during any pressure testing of the gas supply system at test pressures equal to or greater than 1/2 psig. NOTE: 1/2 psig = 13.855" w.c.

MATERIALS YOU MAY NEED

CSA-Approved Flexible Gas Line 3/8" Min. ID, 1/2" NPT Connection
Shut-Off Valve
Joint Sealant
Pipe Fittings

TOOLS YOU WILL NEED

Drill with 1/8" Bit
Safety Glasses
Adjustable Wrench
Pipe Wrench

Level
Tape Measure
Pliers
1/4" Nut Driver

Phillips-Head Screwdriver
Flat-Blade Screwdriver

1 REMOVE PACKAGING MATERIALS

Failure to remove packaging materials could result in damage to the appliance. Remove all packing parts from oven, racks and drawer. Also, remove protective film and labels on the door, cooktop and backguard. However, do not remove protective channel from sides of glass cooktop, if applicable, until later in installation.

Protective Channels

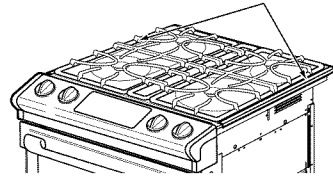

Move Range Indoors in Front of Cabinet Opening:

Do not use hand trucks when moving the unpacked range, as damage to the cooktop may occur.

Protect the Kitchen Floor: Flatten and place a piece of the shipping carton in front of the installation location to protect the flooring.

2 PREPARE THE OPENING (FOR INDOOR USE ONLY)

If the countertop area is not flat, excess tension may be applied to the cooktop causing damage and voiding the warranty. Make sure the wall covering, countertop, flooring and cabinets around the range can withstand the heat (up to 200°F [93.3°C]) generated by the range.

A. Allow 30" (76.2 cm) minimum clearance between burners and bottom of unprotected wood or metal cabinet, or allow a 24" (61 cm) minimum when bottom of wood or metal cabinet is protected by no less than 1/4" (6.4 mm) thick flame-retardant millboard covered with no less than No. 28 MSG sheet metal (.015" [.38 mm] thick), .015" (.38 mm) thick stainless steel, .025" (0.64 mm) aluminum or .020" (0.5 mm) copper.

B. Side wall clearance requirement:

6" (15.2 cm) clearance for models JGSP28, JGS905, JGS968 and PGS968

9 1/2" (24.1 cm) clearance for models PGS908 and PGS975

To reduce the risk of burns or fire when reaching over burners, cabinet storage space above the cooktop should be avoided. If cabinet storage space is to be provided above the cooktop, the risk can be reduced by installing a range hood that projects at least 5" (12.7 cm) beyond the front of the cabinets. Cabinets installed above the cooktop must be no deeper than 13" (33 cm).

Seal any openings in the wall behind the range and the floor under the range.

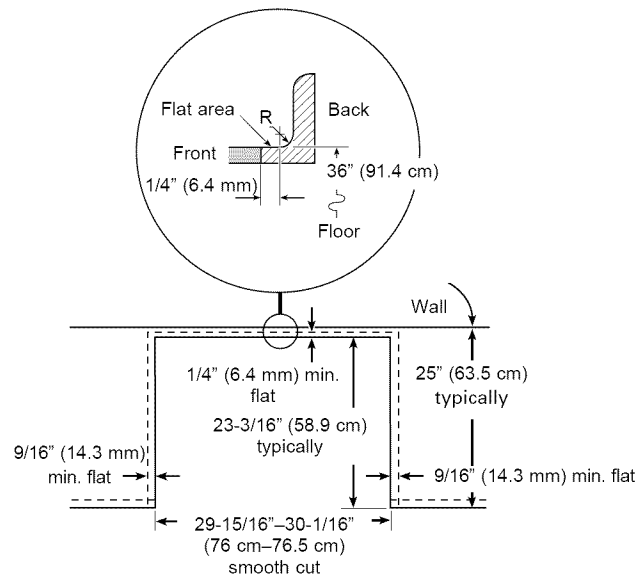

2 PREPARE THE OPENING (CONT.)

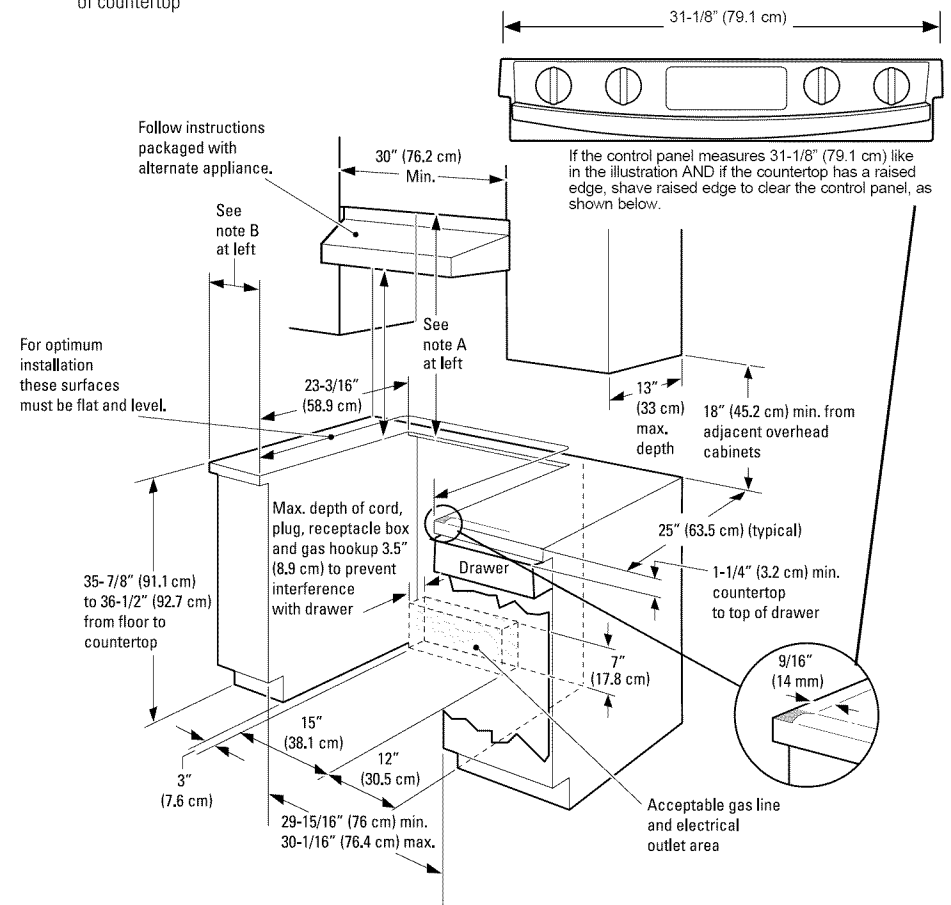
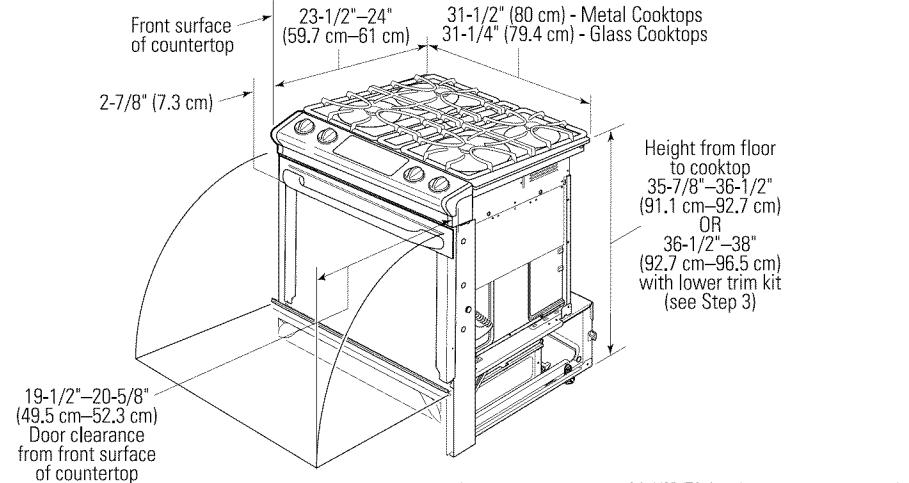

3 ALTERNATE INSTALLATION/ CONSTRUCTION KITS

Backguard Kit: Used when replacing a free-standing range with a slide-in range. Adds a decorative backguard to the rear of the range. This kit can only be used when the opening in the countertop is 25" (63.5 cm) deep.

Maintop Filler Kit: Adds a filler strip to the rear of the range. This kit can only be used when the opening in the countertop is 25" (63.5 cm) deep. This kit cannot be used with a backguard kit.

Maintop Filler Kit Numbers: **WB07T10680 (Black)**
WB07T10681 (White)
WB07T10682 (Bisque)

Body Side Kit: Used when cabinets are absent on one side of the range. Contains a color-matched side panel which can be used to create a finished appearance on either side of the range.

Lower Trim Kit: Contains a color-matched toe kick and extra-long leveling legs. Designed to be used when the range needs to be raised higher than 36-1/2" (92.7 cm) to 38" (96.5 cm).

To order accessory kits, call 1.866.775.4557, or visit www.GEAppliances.com.

4 PREPARE THE RANGE

STORAGE DRAWER REMOVAL

- Pull drawer out until it stops.
- Lift front of drawer until the stops clear the guide.
- Pull forward and remove the drawer.

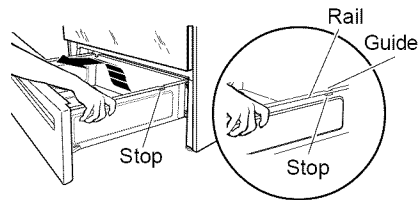

DOOR REMOVAL (optional)

Door removal is not a requirement for installation of the product but is an added convenience.

To remove the door:

- Open the oven door as far as it will go.
- Push both hinge locks down toward the door frame to the unlock position. Hinge locks require a flat-blade screwdriver.
DO NOT LIFT THE DOOR BY THE HANDLE!
- Place hands on both sides of the door, and close the oven door to the hinge arm position. (Approximately 1"-2" [2.5 cm-5.1 cm] from the closed position.)
- Lift door up and out until the hinge arms clear the slots.

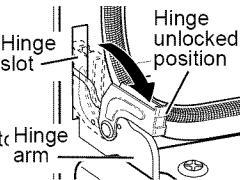

NOTE: The oven door is very heavy. Be sure you have a firm grip before lifting the oven door off the hinges. Use caution once the door is removed. Do not lay the door on its handle. This could cause dents or scratches.



5 ELECTRICAL REQUIREMENTS

WARNING: This appliance must be properly grounded.

IMPORTANT: This appliance must be electrically grounded in accordance with local codes or, in the absence of local codes, with the National Electrical Code, ANSI/NFPA 70 or Canadian Electrical Code, CSA C22.1.

This appliance must be supplied with 120 VAC / 60 Hz power. It must be connected to a properly grounded branch circuit, protected by a 15-amp or 20-amp circuit breaker or fuse. We recommend that a separate circuit serving only this appliance be provided.

The power cord of this appliance is equipped with a three-prong (grounding) plug which mates with a standard three-prong grounding wall receptacle. The customer should have the wall receptacle checked by a qualified electrician to make sure the receptacle is properly grounded. Where a standard two-prong wall receptacle is encountered, it is the personal responsibility and obligation of the customer to have it replaced with a properly grounded three-prong wall receptacle.

Do not, under any circumstances, cut or remove the third prong (ground) from the power cord.

Because of potential safety hazards under certain conditions, we strongly recommend against the use of an extension cord. However, if you still elect to use an extension cord, it is absolutely necessary that it is a UL-listed 3-wire grounding-type appliance extension cord, and that the current-carrying rating of the cord in amperes is equivalent to, or greater than, the branch circuit rating.

Installation of this product in a mobile home must conform with the Manufactured Home Construction and Safety Standard, Title 24 CFR, Part 3280. If this standard does not apply, you must follow the standard for the Manufactured Home Installations, ANSI A225.1 and Manufactured Home Installations, Sites and Communities and ANSI/NFPA 501A or with local codes.

31-10675-1

31-10737-1 = French version

31-10738-1 = Spanish version

6 MAKE GAS CONNECTIONS

⚠ WARNING: Never reuse old flexible connectors. The use of old flexible connectors can cause gas leaks and personal injury. Always use new flexible connectors when installing a gas appliance.

⚠ WARNING: Do not use a flame to check for gas leaks. Use liquid leak detector at all joints and connections to check for leaks in the system.

- Install a manual shut-off valve in the gas supply line in an easily accessible location.
- Know how and where to shut off the gas supply to the range.
- Shut off gas supply before removing an old range. Leave it off until hookup of new range is finished.
- Because solid pipe restricts moving the range, we recommend use of a C.S.A.-certified flexible metal appliance connector.
- Before making gas connections, make sure that the oven shut-off lever (visible at the back of range) is in the open position.

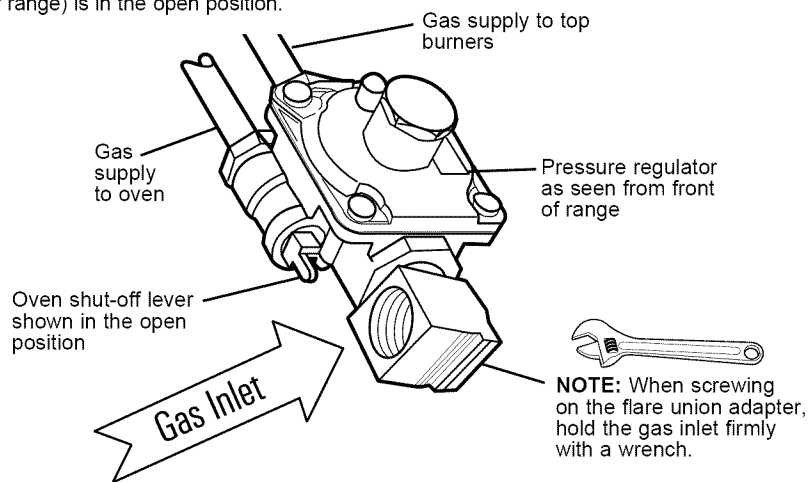

- To prevent gas leaks, put a pipe joint sealant or Teflon® tape on all male threads. **NOTE:** Make sure sealant or tape is compatible with Natural and LP gases.
- Install 1/2" flare union adapter to the 1/2" NPT elbow on pressure regulator.
- Connect flexible gas line to flare union.
- Move range into approximate position and connect flexible gas line to gas supply line with proper flare union adapter.

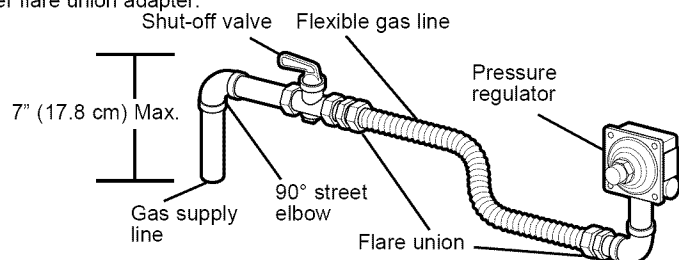

- When you are finished making connections, be sure that all range knobs are turned to OFF before you open the main gas supply valve.
- CHECK FOR LEAKS.** Turn the gas supply on and use a liquid leak detector (soap solution) at all joints and connections to check for leaks. **Do not use open flame to look for leaks.** Be sure all leaks are stopped before lighting burners.

7 ANTI-TIP DEVICE INSTALLATION



⚠ WARNING

- All ranges can tip.
- BURNS or other SERIOUS INJURIES can result.
- INSTALL and CHECK the ANTI-TIP bracket following the instructions supplied with the bracket.



To reduce the risk of tipping the range, the range must be secured by a properly installed anti-tip bracket. See installation instructions shipped with the bracket for complete details before attempting to install.

To check if the bracket is installed and engaged properly, remove the storage drawer or kick panel and look underneath the range to see that the leveling leg is engaged in the bracket. On models without a storage drawer or kick panel, carefully tip the range forward.

The bracket should stop the range within 4 inches (10.2 cm). If it does not, the bracket must be reinstalled. If the range is pulled from the wall for any reason, always repeat this procedure to verify the range is properly secured by the anti-tip bracket. Never completely remove the leveling legs or the range will not be secured to the anti-tip device properly.

8 SLIDE RANGE INTO OPENING

- Position the range in front of the cabinet opening. Make sure that the cooktop that overhangs the countertop clears the countertop. If necessary, raise the unit by lowering the leveling legs.
- Push while lifting the range into the opening until the range is within 2" (5.1 cm) of engaging the anti-tip bracket. Remove the protective channel from the side of glass (if provided).
- Using the adjustable pliers or wrench, carefully screw in the back leveling legs until the cooktop overhang touches the countertop. Then carefully screw in the front two leveling legs until the cooktop overhang touches the countertop.
- Carefully push the range into the opening until the unit is fully seated into the cabinet. The back cooktop overhang should cover the cutout opening. Plug the range cord into the receptacle. Locate the flexible gas line in the back of the range in a manner that it will not touch or be moved by the drawer.

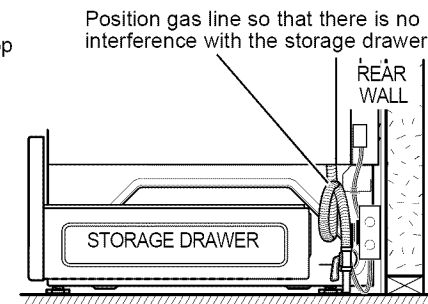
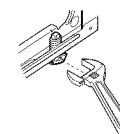

SIDE VIEW

9 REPLACING THE OVEN DOOR

NOTE: The oven door is heavy. You may need help lifting the door high enough to slide it into the hinge slots. Do not lift the door by the handle.

- Lift the oven door by placing one hand on each side. The door is heavy, so you may need help. Do not lift the door by the handle.
- With the door at the same angle as the removal position (approximately 1"–2" [2.5 cm–5.1 cm] from the closed position), seat the notch of the hinge arm into the bottom edge of the hinge slot. The notch of the hinge arm must be fully seated into the bottom of the slot.
- Fully open the door. If the door will not fully open, the indentation is not seated correctly in the bottom edge of the slot.
- Push the hinge locks up against the front frame of the oven cavity, to the locked position.
- Close the oven door.

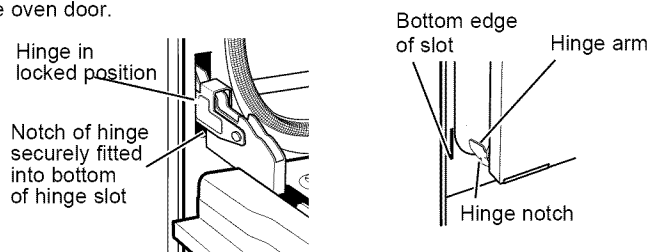
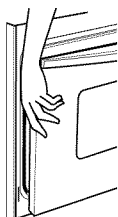

REPLACE THE STORAGE DRAWER

- Place the drawer rail on the guides. Push the drawer in until it stops.
- Lift the front of the drawer and push in until the stops clear the guides.
- Lower the front of the drawer and push in until it closes.

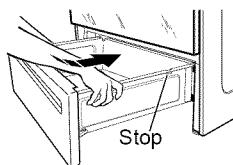

10 COOKTOP BURNERS

ASSEMBLE THE BURNERS

CAUTION: The electrode of the spark igniter is exposed. Be careful not to impact the electrode, as damage to the igniter could occur. Be careful not to turn on any cooktop controls while touching an electrode. A slight electrical shock may occur.

If you have a glass ceramic cooktop, skip to **B**.

A FOR METAL COOKTOPS

- Place burner heads over the electrodes on the cooktop, in the correct locations according to their sizes.

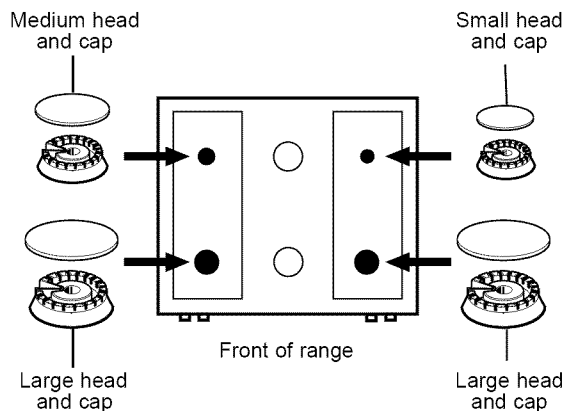

- Make sure the slot in the burner head is positioned over the electrode (on some models).

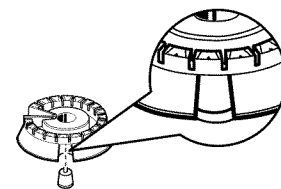

- Place the matching size caps onto the heads.

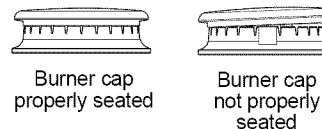

Make sure that the heads and caps are placed in the correct locations.

Place the vent cover, grates and air inlet cover onto the cooktop, making sure that the grates lock the vent cover in place.

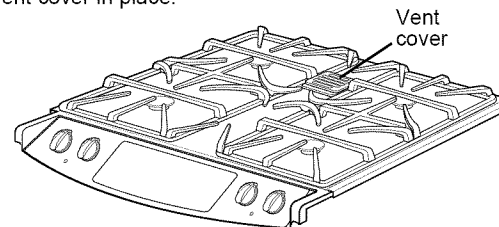

10 COOKTOP BURNERS (CONT.)

ASSEMBLE THE BURNERS (CONT.)

If you have a metal cooktop, skip to **C**.

B FOR GLASS CERAMIC COOKTOPS

A. Place burner heads over the electrodes on the cooktop, in the correct locations according to their sizes.

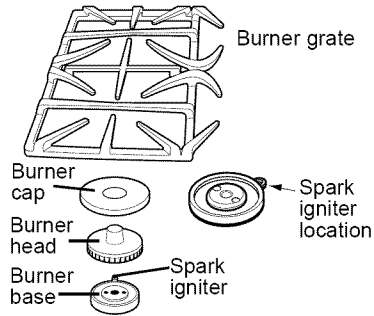

B. Place the matching size caps onto the heads.

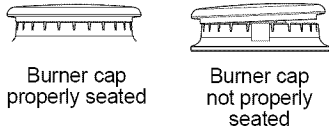

Make sure that the heads and caps are placed in the correct locations.

Place the vent cover, grates and air inlet cover onto the cooktop, making sure that the grates lock the vent cover in place.

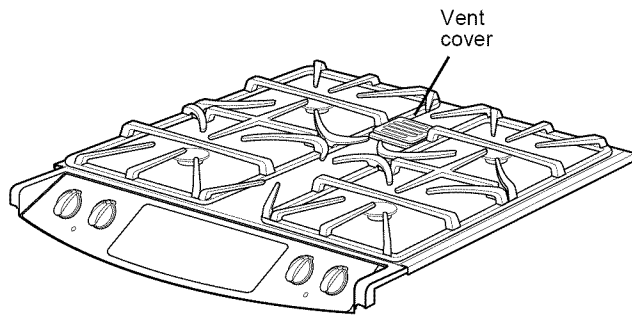

10 COOKTOP BURNERS (CONT.)

C CHECK THE IGNITERS

Operation of the electric igniters should be checked after the cooktop and supply line have been carefully checked for leaks and the cooktop has been connected to the electrical power.

- Turn on gas.
- Push and turn a burner valve to the LITE position.
 - The burner valve should light when gas is available to the burner.
 - Once the burner lights, it should be turned out of the LITE position.
- Try each valve separately until all burners have been checked.

D BURNER IGNITION

Cooktop Spark Ignition—When you turn the cooktop knob to LITE, the spark igniter makes a series of electric sparks (ticking sounds) which light the burner. During a power failure, the burners will not light automatically. In an emergency, a cooktop burner may be lit with a match by following the steps below.

⚠ WARNING: Lighting gas burners with a match is dangerous. You should match light the cooktop burners only in an emergency.

- Light a match and hold the flame near the burner you want to light. Wooden matches work best.
- Push in and turn the control knob slowly. Be sure you are turning the correct knob for the burner you are lighting.

NOTE: If the burner does not light within 5 seconds, turn the knob off and wait 5 minutes before trying again.

E BURNER FLAMES

Turn each burner on. Turn each burner knob to the high position. Flames should be blue in color with little or no trace of yellow. The burner flames should not flutter or blow away from the burner. The inner cone of the flame should be between 1/2" and 3/4" (12.7 mm and 19.1 mm) long. If the burner flames are yellow in color or not the proper length, call GE Service.

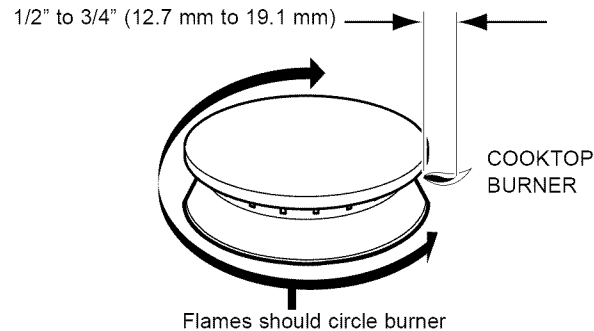

Burners should be checked frequently.

⚠ WARNING: If you attempt to measure the inner cone of the flame, please use caution. Burns could result.

11 BAKE AND BROIL BURNERS

A CHECKING THE OVEN BURNERS

To check the bake burner flames with the oven door in the closed position:

- A. Open the door and remove it. (Optional—see Step 4.)
- B. Remove the oven racks.
- C. Remove the oven bottom.

Lift the oven bottom up at the rear and pull forward.

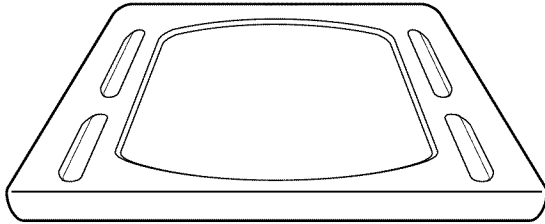

- D. Remove the four screws holding the burner baffle (flame spreader) to the burner box.

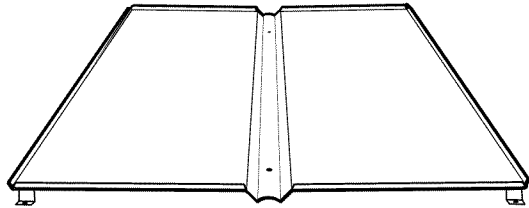

- E. Install and close the oven door.
- F. Turn on the bake burner.

The broil burner flames may be seen without removing the racks, oven bottom or bake baffles.

11 BAKE AND BROIL BURNERS (CONT.)

B ADJUST THE AIR SHUTTER

WHAT ADJUSTMENT TO MAKE:

- A. If the flames are yellow, open the air shutter more than the original setting.
- B. If the flames blow away or flutter from the burner, close the air shutter more than the original setting.

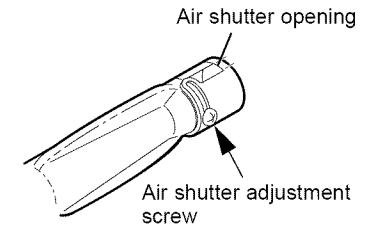

MAKING THE ADJUSTMENT:

- A. Bake burner: Remove the orifice fitting cover. The broil burner is located and accessible in the top rear of the oven.
- B. Using a screwdriver, loosen the air shutter adjustment screw.
- C. Make the air shutter adjustment.
- D. Retighten the air shutter screw.
- E. Check the inner cone of the flame. It should be between 1/2" and 3/4" (12.7 mm and 19.1 mm) long for the oven bake and broil burners.

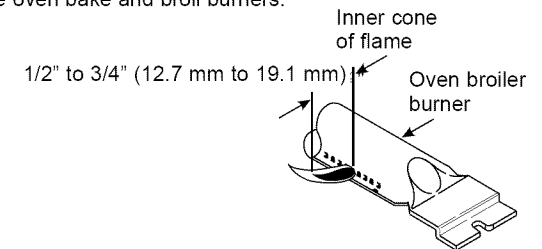
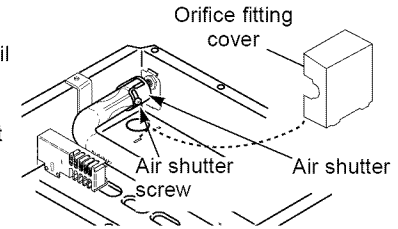

WHEN ALL ADJUSTMENTS ARE MADE AND THE RESULTS ARE SATISFACTORY:

- A. Replace the orifice fitting cover.
- B. Replace the burner baffle (flame spreader) and screws.
- C. Replace the oven bottom.
- D. Replace the oven door.

12 FINAL INSTALLATION CHECKLIST

- Check to make sure the circuit breaker is closed (RESET) or the circuit fuses are replaced.
- Be sure power is in service to the building.
- Check that all packing materials and tape have been removed. This will include tape on metal panel under control knobs (if applicable), adhesive tape, wire ties, cardboard and protective plastic. Failure to remove these materials could result in damage to the appliance once the appliance has been turned on and surfaces have heated.
- Check that the door and drawer are parallel to each other and that both operate smoothly. If they do not, repeat steps 4 and 9.
- Check to make sure that the rear leveling leg is fully inserted into the anti-tip bracket and that the bracket is securely installed.

OPERATION CHECKLIST

- Check that the oven control operates properly. If the oven control does not operate properly, recheck the wiring connections.
- Be sure all range controls are in the OFF position before leaving the range.