



Commercial Dryer

Operating Instructions

CDE3379WD/CDG3389WD
CDE3379WN/CDG3389WN

Please read this manual carefully. It provides instructions on safe installation, use, and maintenance.

Retain it for future reference.

Record the model and serial numbers of your machine and report this information to your dealer if your machine requires service.

Not for residential use.



PRODUCT FEATURES

■ OUTSTANDING PERFORMANCE

The dryer features the largest capacity, quick drying times, quiet operation, and an energy-saving system.

■ STAINLESS STEEL DRUM

Stainless steel drum doesn't rust.

■ ARTISTIC DESIGN

Modern front panel look and big clear glass door make your dryer look stylish

■ EASY OF USE

An entire selection of user-friendly functions makes operating the dryer easy.

■ ULTRA CAPACITY

The larger drum enables better tumbling and less tangling and wrinkling of the laundry.

CONTENTS

PART 1. IMPORTANT SAFETY INSTRUCTIONS	3
PART 2. SPECIFICATIONS	8
PART 3. IDENTIFICATION	9
PART 4. OPERATING YOUR DRYER	11
PART 5. PROGRAMMING MODE	12
PART 6. ERROR MODE	37
PART 7. POWER FAIL RECOVERY	37
PART 8. DEFAULT DRYER SETTINGS	37
PART 9. WARRANTY	38

READ ALL INSTRUCTIONS BEFORE USE

⚠ WARNING For your safety, the information in this manual must be followed to minimize the risk of fire or explosion, electric shock, or to prevent property damage, personal injury, or loss of life.

Your Safety and the safety of others is very important.

We have provided many important safety messages in this manual and on your appliance. Always read and obey all safety messages.



This is the safety alert symbol.

This symbol alerts you to potential hazards that can kill or hurt you and others.

All safety messages will follow the safety alert symbol and either the word DANGER or WARNING. These words mean:

⚠ DANGER: You can be killed or seriously injured if you don't immediately follow instructions.

⚠ WARNING: You can be killed or seriously injured if you don't follow instructions. All safety messages will tell you what the potential hazard is, tell you how to reduce the chance of injury, and tell you what can happen if the instructions are not followed.

BASIC SAFETY PRECAUTIONS

⚠ WARNING: To reduce the risk of fire, electric shock, or injury to persons when using this appliance, follow basic precautions, including the following:

- Read all instructions before using the dryer.
- Before use, the dryer must be properly installed as described in this manual.
- Do not place items exposed to cooking oils in your dryer. Items contaminated with cooking oils may contribute to a chemical reaction that could cause a load to catch fire.
- Do not dry articles that have been previously cleaned in, washed in, soaked in, or spotted with gasoline, dry-cleaning solvents, or other flammable or explosive substances as they give off vapors that could ignite or explode.
- Do not reach into the dryer if the drum or any other part is moving.
- Do not repair or replace any part of the dryer or attempt any servicing unless specifically recommended in this Use and Care Guide or in published user-repair instructions that you understand and have the skills to carry out.
- Do not tamper with controls.
- Before the dryer is removed from service or discarded, remove the door to the drying compartment.
- Do not allow children to play on or in the dryer. Close supervision of children is necessary when the dryer is used near children.
- Do not use fabric softeners or products to eliminate static unless recommended by the manufacturer of the fabric softener or product.
- Do not use heat to dry articles containing foam rubber or similarly textured rubber-like materials.
- Keep area around the exhaust opening and adjacent surrounding areas free from the accumulation of lint, dust, and dirt.
- The interior of the dryer and exhaust vent should be cleaned periodically by qualified service personnel.
- Do not install or store the dryer where it will be exposed to the weather.
- Always check the inside of the dryer for foreign objects.
- Clean lint screen before or after each load.

READ ALL INSTRUCTIONS BEFORE USE

▲ WARNING For your safety, the information in this manual must be followed to minimize the risk of fire or explosion, electric shock, or to prevent property damage, personal injury, or loss of life.

- Do not store or use gasoline or other flammable vapors and liquids in the vicinity of this appliance or any other appliances.
- Installation and service must be performed by a qualified installer, service agency, or the gas supplier.

WHAT TO DO IF YOU SMELL GAS:

1. Do not try to light a match or cigarette, or turn on any gas or electrical appliance.
2. Do not touch any electrical switches. Do not use any phone in your building.
3. Clear the room, building, or area of all occupants.
4. Immediately call your gas supplier from a neighbor's phone. Follow the gas supplier's instructions carefully.
5. If you cannot reach your gas supplier, call the fire department.

CALIFORNIA SAFE DRINKING WATER AND TOXIC ENFORCEMENT ACT

This act requires the governor of California to publish a list of substances known to the state to cause cancer, birth defects, or other reproductive harm and requires businesses to warn customers of potential exposure to such substances.

Gas appliances can cause minor exposure to four of these substances, namely benzene, carbon monoxide, formaldehyde, and soot, caused primarily by the incomplete combustion of natural gas or LP fuels.

Properly adjusted dryers will minimize incomplete combustion. Exposure to these substances can be minimized further by properly venting the dryer to the outdoors.

READ ALL INSTRUCTIONS BEFORE USE

⚠ WARNING For your safety, the information in this manual must be followed to minimize the risk of fire or explosion, electric shock, or to prevent property damage, personal injury, or loss of life.

GROUNDING INSTRUCTIONS

This appliance must be grounded. In the event of malfunction or breakdown, grounding will reduce the risk of electric shock by providing a path of least resistance for electric current. This appliance must be equipped with a cord having an equipment-grounding conductor and a grounding plug. The plug must be plugged into an appropriate outlet that is properly installed and grounded in accordance with all local codes and ordinances.

⚠ WARNING — Improper connection of the equipment-grounding conductor can result in a risk of electric shock. Check with a qualified electrician or service

person if you are in doubt as to whether the appliance is properly grounded.

Do not modify the plug provided with the appliance. If it will not fit the outlet, have a proper outlet installed by a qualified electrician.

This appliance must be connected to a grounded metal, permanent wiring system or an equipment-grounding conductor must be run with the circuit conductors and connected to the equipment-grounding terminal or lead on the appliance.

Electrical shock can result if the dryer is not properly grounded.

SAFETY INSTRUCTIONS FOR INSTALLATION

⚠ WARNING To reduce the risk of fire, electric shock, or injury to persons when using this appliance, follow basic precautions, including the following:

- **Properly ground dryer to conform with all governing codes and ordinances.** Follow details in the installation instructions. Electrical shock can result if the dryer is not properly grounded.
- **Before use, the dryer must be properly installed as described in this manual.**
Electrical shock can result if the dryer is not properly grounded.
- **Install and store the dryer where it will not be exposed to temperatures below freezing or exposed to the weather.**
- **All repairs and servicing must be performed by an authorized servicer unless specifically recommended in this Owner's Guide. Use only authorized factory parts.** Failure to follow this warning can cause serious injury, fire, electrical shock, or death.
- **To reduce the risk of electric shock, do not install the dryer in humid spaces.** Failure to follow this warning can cause serious injury, fire, electrical shock, or death.
- **Connect to a properly rated, protected, and sized power circuit to avoid electrical overload.** Improper power circuit can melt, creating electrical shock and/or fire hazard.
- **Remove all packing items and dispose of all shipping materials properly.** Failure to do so can result in death, explosion, fire, or burns.
- **Place dryer at least 18 in. above the floor for a garage installation.** Failure to do so can result in death, explosion, fire, or burns.
- **Keep all packaging from children.** Packaging material can be dangerous for children. There is a risk of suffocation.

READ ALL INSTRUCTIONS BEFORE USE

▲ WARNING For your safety, the information in this manual must be followed to minimize the risk of fire or explosion, electric shock, or to prevent property damage, personal injury, or loss of life.

SAFETY INSTRUCTIONS FOR INSTALLATION

Exhaust/Ducting:

- **Gas dryers MUST be exhausted to the outside.** Failure to follow these instructions can result in fire or death.
- **The dryer exhaust system must be exhausted to the outside of the dwelling. If the dryer is not exhausted outdoors, some fine lint and large amounts of moisture will be expelled into the laundry area.** An accumulation of lint in any area of the home can create a health and fire hazard.
- **Use only rigid metal or flexible metal 4-in. diameter ductwork inside the dryer cabinet or for exhausting to the outside. Use of plastic or other combustible ductwork can cause a fire.** Punctured ductwork can cause a fire if it collapses or becomes otherwise restricted in use or during installation.
- **Ductwork is not provided with the dryer, and you should obtain the necessary ductwork locally. The end cap should have hinged dampers to prevent backdraft when the dryer is not in use.** Failure to follow these instructions can result in fire or death.
- **The exhaust duct must be 4 in. (10 cm) in diameter with no obstructions. The exhaust duct should be kept as short as possible. Make sure to clean any old ducts before installing your new dryer.** Failure to follow these instructions can result in fire or death.
- **Rigid or semi rigid metal ducting is recommended for use between the dryer and the wall. In special installations when it is impossible to make a connection with the above recommendations, a UL-listed flexible metal transition duct may be used between the dryer and wall connection only. The use of this ducting will affect drying time.** Failure to follow these instructions can result in fire or death.
- **DO NOT use sheet metal screws or other fasteners which extend into the duct that could catch lint and reduce the efficiency of the exhaust system.** Secure all joints with duct tape. For complete details, follow the Installation Instructions. Failure to follow these instructions can result in fire or death.

SAFETY INSTRUCTIONS FOR STEAM FUNCTIONS

▲ WARNING: To reduce the risk of fire, electric shock, or injury to persons when using this appliance, follow basic precautions, including the following:

- **Do not open the dryer door during steam cycles.** Failure to follow these instructions can result in a burn hazard.
- **Do not dry articles that have been previously cleaned in, washed in, soaked in, or spotted with gasoline, dry-cleaning solvents, or other flammable or explosive substances as they give off vapors that could ignite or explode.** Failure to follow these instructions can result in fire or death.
- **Do not fill the steam feeder with gasoline, dry-cleaning solvents, or other flammable or explosive substances.** Failure to follow these instructions can result in fire or death.
- **Do not touch the steam nozzle in the drum during or after the steam cycle.** Failure to follow these instructions can result in a burn hazard.
- **Do not fill the steam feeder with hot water (over 86° F / 30° C).** Failure to follow these instructions can result in a burn hazard.

READ ALL INSTRUCTIONS BEFORE USE

▲ WARNING For your safety, the information in this manual must be followed to minimize the risk of fire or explosion, electric shock, or to prevent property damage, personal injury, or loss of life.

SAFETY INSTRUCTIONS FOR CONNECTING ELECTRICITY

▲ WARNING: To reduce the risk of fire, electric shock, or injury to persons when using this appliance, follow basic precautions, including the following:

- **Do not, under any circumstances, cut or remove the ground prong from the power cord.** To prevent personal injury or damage to the dryer, the electrical power cord must be plugged into a properly grounded outlet.
- **For personal safety, this dryer must be properly grounded.** Failure to do so can result in electrical shock or injury.
- **Refer to the installation instructions in this manual for specific electrical requirements for your model.** Failure to follow these instructions can create an electrical shock hazard and/or a fire hazard.
- **This dryer must be plugged into a properly grounded outlet. Electrical shock can result if the dryer is not properly grounded. Have the wall outlet and circuit checked by a qualified electrician to make sure the outlet is properly grounded.** Failure to follow these instructions can create an electrical shock hazard and/or a fire hazard.
- **The dryer should always be plugged into its own individual electrical outlet which has a voltage rating that matches the rating plate.** This provides the best performance and also prevents overloading house wiring circuits which could cause a fire hazard from overheated wires.
- **Never unplug your dryer by pulling on the power cord. Always grip plug firmly and pull straight out from the outlet.** The power cord can be damaged, resulting in a risk of fire and electrical shock.
- **Repair or replace immediately all power cords that have become frayed or otherwise damaged. Do not use a cord that shows cracks or abrasion damage along its length or at either end.** The power cord can melt, creating electrical shock and/or fire hazard.
- **When installing or moving the dryer, be careful not to pinch, crush, or damage the power cord.** This will prevent injury and prevent damage to the dryer from fire and electrical shock.

SAVE THESE INSTRUCTIONS

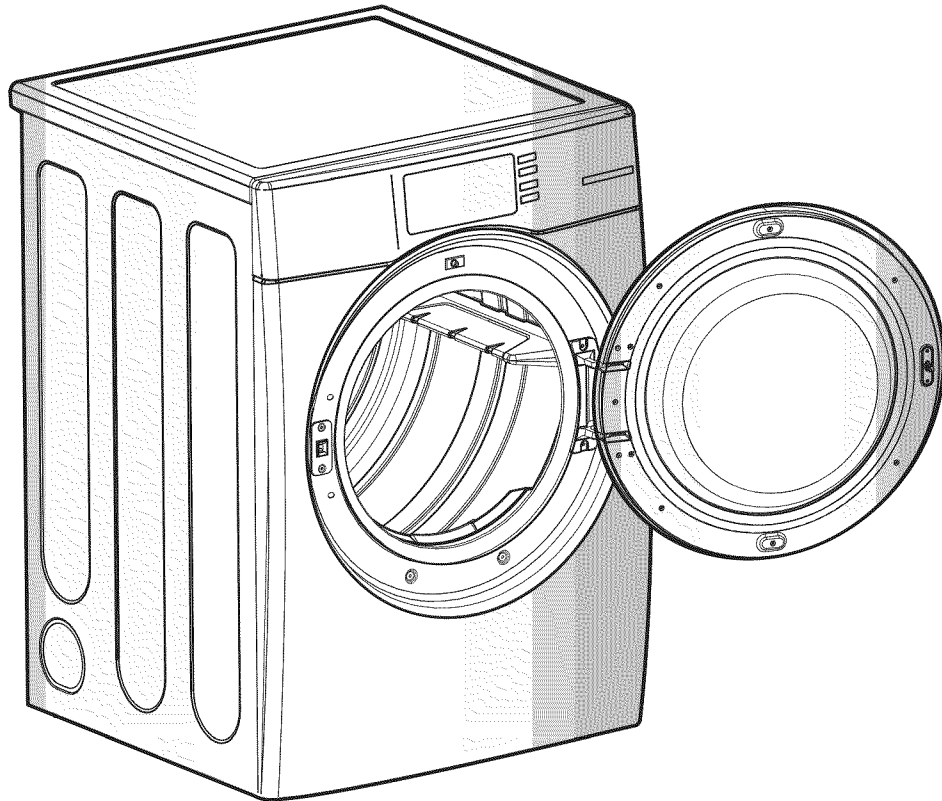

- Type: Electric or Gas Dryer
- Rating: Please refer to the rating label regarding detailed information.
- Size: 27 x 29.9 x 38.7 (inch)
- Capacity: IEC 7.3 cu. ft. (22.5 lbs.)
- Weight: 126 lbs (57.2 kg)

Note

Specifications subject to change by manufacturer.

■ **CARD TYPE (CDE3379WD/CDG3389WD)**

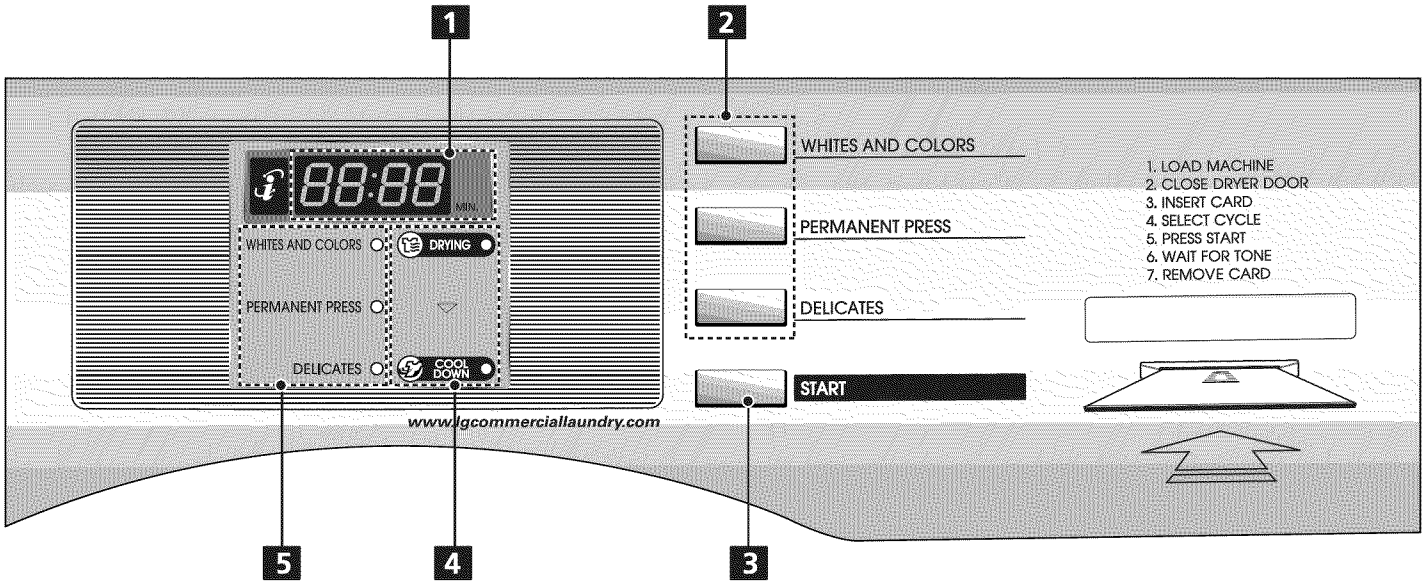

■ **COIN TYPE (CDE3379WN/CDG3389WN)**

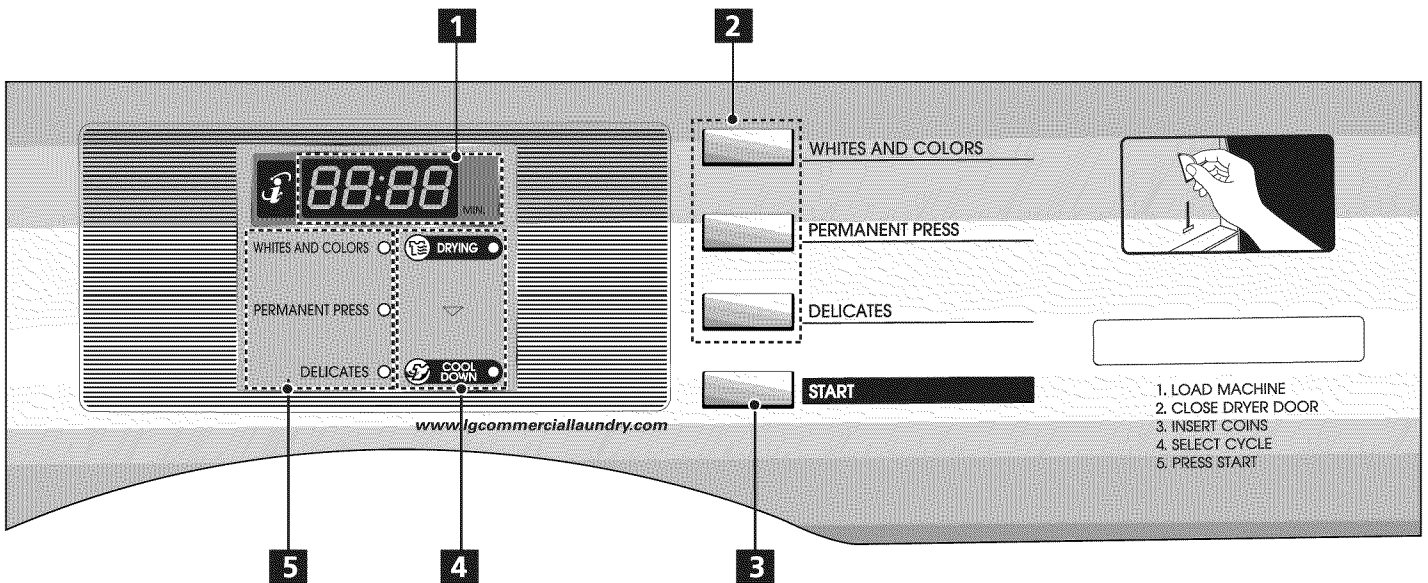

- 1. DISPLAY LED
- 2. CYCLE BUTTON
- 3. START BUTTON

- 4. STATUS LED
- 5. CYCLE LED

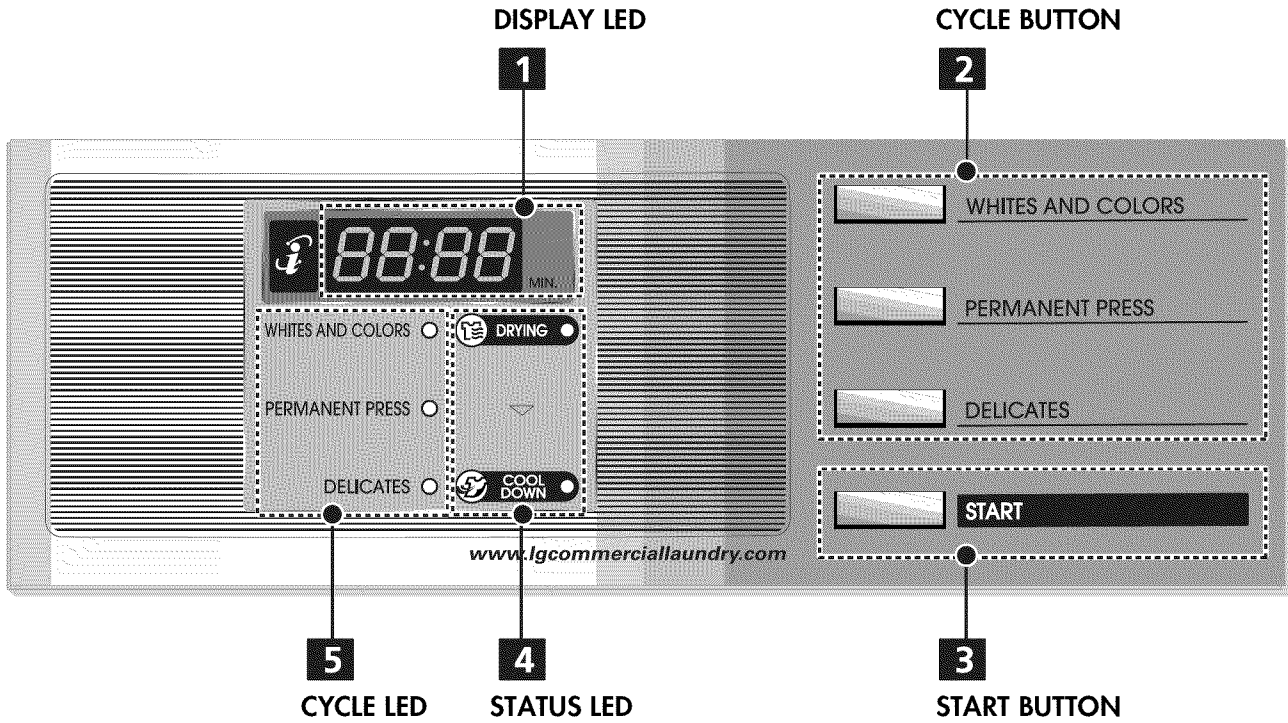

1 DISPLAY LED

The Display shows the vend price, remaining time, and programming options. Error codes are also displayed here.



2 CYCLE BUTTON

Press the cycle button to Select the desired cycle based on laundry types and conditions.

WHITES AND COLORS

Use this cycle to get high heat for heavy fabrics, such as jeans corduroys or work clothes (High heat).

PERMANENT PRESS

Use for drying sturdy fabrics such as work casual clothes (Medium heat).

DELICATES

Use for drying synthetic fabrics, washable knit fabrics and no-iron finishes (Low heat).

3 START BUTTON

The START LED flashes when the full vend price has been satisfied then the cycle has been chosen or the machine is paused. The START LED flashes when a card is inserted to add time to the current cycle.

4 STATUS LED

- **DRYING** LED flashes whenever the heating cycle is in operation.
- **COOL DOWN** LED flashes whenever the cool down cycle is in operation.

5 CYCLE LED

WHITES AND COLORS, PERMANENT PRESS, or DELICATES LED is lit to indicate that heated portion of a cycle is in operation.

1 Ready mode

The display LED shows each cycle price and cycle LED toggle.

2 Insert card/coin

- Insert a cash card that has a sufficient balance. The card balance should be more than the programmed vend price for a selected cycle.

Note

When the card balance is not enough, machine displays the balance for 5 seconds and then displays **ERR** message repetitively

- Insert a sufficient amount of change that is a more than the programmed vend price for a selected cycle.

Note

When the coin amount is not enough, the machine will not start.

3 Select the cycle

Press the desired cycle and the start button. The display LED will show the remaining time and the selected cycle starts.

Note

The last 2 minutes of the remaining time are always for the cool down portion.

4 Top off (To add more time)

- After a debit card is inserted, the operating time can be increased to 15 minutes/25¢ (default), when the START button or the chosen course button has been pressed. (The card should have enough balance to satisfy increasing time.)
- The operating time can be increased to 15 minutes/25¢ (default) by adding more coins.

Note

Owner can control the additional time and money setting (top off price).

When the COOL DOWN has been working, if time is added, it goes back to the DRYING. Time can be added up 99 minutes.

5 Change cycle

- You cannot change the cycle while the machine is running.
- But if the door is opened, the machine stops temporarily and the cycle can be changed.

6 Cycle finish

- After the COOL DOWN of cycle, the machine stops and LED display shows End. If you press any key or open the door, the dryer defaults to the ready mode.

1 Programming mode

You can check machine information or change setting on Program setup or Diagnostic test. There are two methods that you can enter programming mode.

2 Check the programming mode by button

■ How to enter "Programming mode"

You can enter programming mode only for Idle state and pause state.

- Card Type

- 1) Insert service card.
- 2) Display will show **900**

- Coin Type

- 1) Open the Service door.
- 2) Display will show **900**

■ How to use button

You can change Dryer vend price, cycle time and Cycle parameters, etc.

Press button	Description
WHITES AND COLORS	Move to upper level
PERMANENT PRESS	Move to the mode in the same level (+)
DELICATES	Move to the modes in the same level (-)
START	Enter the selected mode

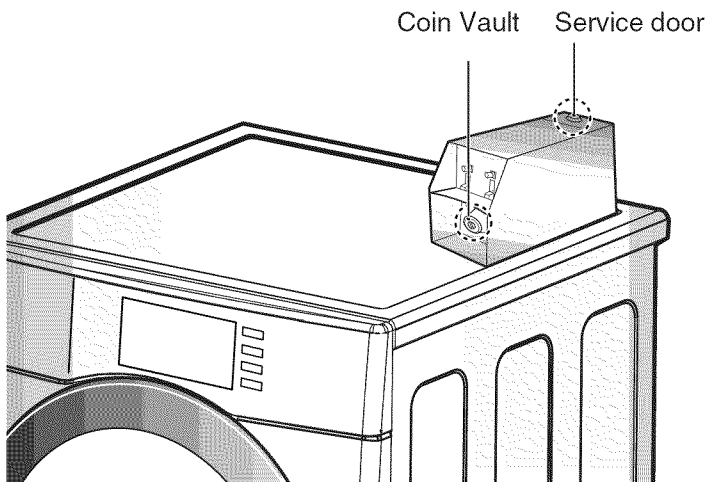

COIN TYPE

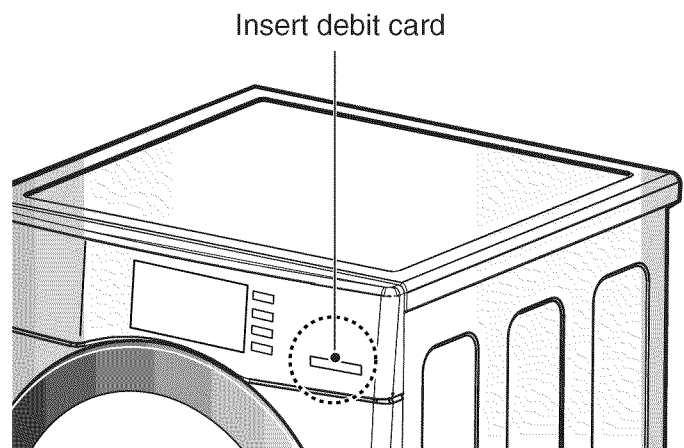

CARD TYPE

Note

- If you turn on the power without connecting the meter case for the first time, the machine will display **900**.
- When the machine comes from the factory, it is set in the coin type. You can change Card/Coin type by button. (For more information refer to SETUP mode's **FEA1**.)

- Algorithm Flow Chart shows how to control programming mode.
- Before program set, check the structure of programming mode.

1. Open the service door or Insert the service card to entering set up mode.
2. Press **WHITES AND COLORS** button to move the upper level.
3. Press **PERM PRESS(+)** or **DELICATES(-)** button if you want to be at the same level.
4. Press **START** button to enter the details of Set up, Diagnostic Tests mode.

SE UP is to set price value, time value and vend type etc.

EE SE consists of line test, reset, free cycle and kill cycle.

CL CE is to collect the usage data.

■ STRUCTURE OF PROGRAMMING MODE

SE UP		EE SE	CL CE		
79P7	SP6E	L9C1	79P7	1EUC	1E77
79CP	SP6E	L9C2	79CP	1EFC	1E6E
797P	7P6E	LIFE	797P	AC7C	1E Pd
79HP	SP6E	EEPE	79HP	ACCC	1E dd
SPP7	CCCE	E13E	DEL C	ACAC	1E Ad
SPP7	77PE	COU7	1E7C	ACHC	1E UC
SPP7	77PE	KILL	1ECC	ACSC	1E AC
SPHP	E55d		1EAC	AC6F	EL do
SCPA	C01		1EHC	ACUC	EL Co
SPCE	C02		1ESC	ACFC	EP do
FEA1	P1Po		1E6F	AC7E	EP Co
SPPd	EoPE				SCP7
					EoP7









Note

- Do not use **L9C2**, **LIFE**.
- It is only used in inspecting the machine.

Setup Mode :  (display)

- You can change dryer vend price, cycle time, and cycle parameters, etc.
- Entering set up mode
 - Coin type-Open the service door.
 - Card type-Insert the service card.
 - Then, dryer displays .









1 How to change regular price.

	Button	Display
<p>Entering set up mode. You will see LqC1</p> 	Press the WHITES AND COLORS button.	
	Press the PERMANENT PRESS or the DELICATES button until  appears in the display.	
	Press the START button.	
	Press the START button. Display previous regular price.	
	Press PERMANENT PRESS(+) or DELICATES(-) button to set regular price. (The vend price can be set from 0 to \$9.95 in 5¢ increments.)	
	Press the START button. The machine sets up the regular price, then advances to the next process automatically.	
	<ol style="list-style-type: none"> 1. Continue to set up the next price. 2. Stop the change of setup value and go back to ready mode. <ul style="list-style-type: none"> • Coin type - Close the service door. • Card type - Pull the service card. 	

Note

- rgCP (regular cold price) is not available in dryer.
- rgrP (regular warm price) is not available in dryer.
- rgHP (regular hot price) is not available in dryer.





2 How to change special price

	Button	Display
<p>Entering set up mode. You will see LqC1</p> 	<p>Press the WHITES AND COLORS button.</p>	
	<p>Press the PERMANENT PRESS or the DELICATES button until SEUP appears in the display.</p>	
	<p>Press the START button.</p>	
	<p>Press the PERMANENT PRESS or the DELICATES button until SPPr appears in the display.</p>	
	<p>Press the START button. Display previous special price.</p>	
	<p>Press PERMANENT PRESS(+) or DELICATES(-) button to set special price. (The vend price can be set from 0 to \$9.95 in 5¢ increments.)</p>	
	<p>Press the START button. The machine sets up the regular price, then advances to the next process automatically.</p>	
	<p>1. Continue to set up the next price. 2. Stop the change of setup value and go back to ready mode. • Coin type - Close the service door. • Card type - Pull the service card.</p>	

Note

- SPcP (special cold price) is not available in dryer.
- SPPr (special warm price) is not available in dryer.
- SPHP (special hot price) is not available in dryer.
- SCPA (add super cycle price) is not available in dryer.
- SPCT (add super wash type) is not available in dryer.

3 How to enter the **FEA1**

	Button	Display
Entering set up mode. You will see LqC1 	Press the WHITES AND COLORS button.	
	Press the PERMANENT PRESS or the DELICATES button until SEUP appears in the display.	
	Press the START button.	
	Press the PERMANENT PRESS or the DELICATES button until FEA1 appears in the display.	



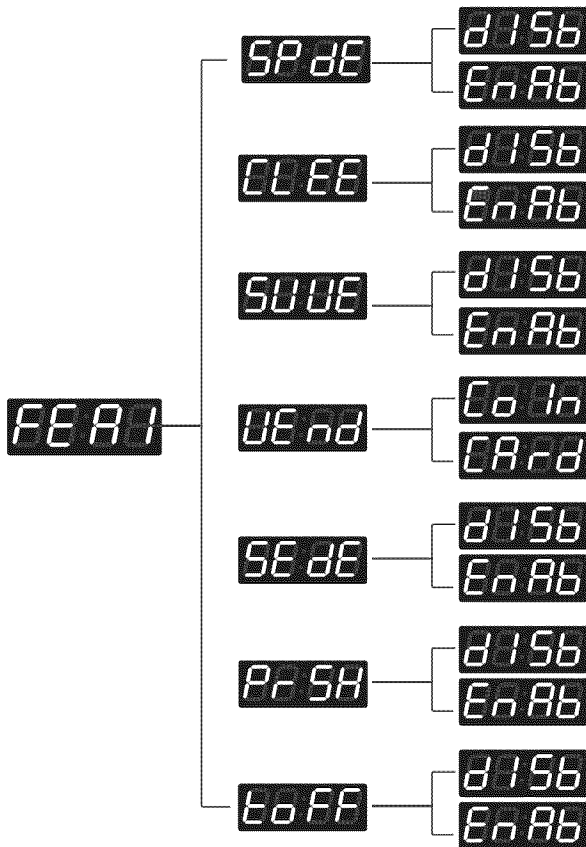







■ Structure of **FEA1**



■ Content of **FEA1**

SPdE	• Special price days apply or not
CL EE	• Clear escrow enable or not (coin type only)
SUUE	• Add super wash apply or not
UE nd	• Select vend type
SE dE	• Sense dry apply or not (only for dryer)
Pr SH	• Pre-wash apply or not
toFF	• Top off apply or not (only for dryer)
d15b	• Disable
EnAb	• Enable











3-1 Special price day setup

	Button	Display
Entering set up mode. You will see LqC1	Press the WHITES AND COLORS button.	 
	Press the PERMANENT PRESS or the DELICATES button until SE UP appears in the display.	
	Press the START button.	
	Press the PERMANENT PRESS or the DELICATES button until FERR appears in the display.	
	Press the START button. Display SP DE .	
	Press the START button. Press PERMANENT PRESS or DELICATES button and then select d156 or EnAb .  Disable  Enable	One or the other will display.  
	Press the START button. The machine sets up the special price, then advances to the next process automatically.	
	1. Continue to set up the next mode. 2. Stop the change of setup value and go back to ready mode. <ul style="list-style-type: none"> • Coin type - Close the service door. • Card type - Pull the service card. 	

Note

- CLEE (clear escrow enable or not) is not available in dryer.
- SUUE (add super wash apply or not) is not available in dryer.













3-2 Vend type setup - card type or coin type setup

	Button	Display
<p>Entering set up mode. You will see LqC1</p> 	<p>Press the WHITES AND COLORS button.</p>	
	<p>Press the PERMANENT PRESS or the DELICATES button until SE UP appears in the display.</p>	
	<p>Press the START button.</p>	
	<p>Press the PERMANENT PRESS or the DELICATES button until FEAR appears in the display.</p>	
	<p>Press the START button. Display SPdE .</p>	
	<p>Press the PERMANENT PRESS or the DELICATES button until UEnd appears in the display.</p>	
	<p>Press the START button. Press PERMANENT PRESS or DELICATES button and then select CoIn or CARD .</p>  Coin type  Card type	<p>One or the other will display.</p>  
	<p>Press the START button. The machine sets up the vend type, then go to the idle mode automatically.</p>	







Note

- SEdE (sensor dry apply or not) is not available in dryer.
- PrSH (Pre-wash apply or not) is not available in dryer.

3-3 Top off apply or not setup

	Button	Display
<p>Entering set up mode. You will see LqC1</p> 	<p>Press the WHITES AND COLORS button.</p>	
	<p>Press the PERMANENT PRESS or the DELICATES button until SEUP appears in the display.</p>	
	<p>Press the START button.</p>	
	<p>Press the PERMANENT PRESS or the DELICATES button until FEAR appears in the display.</p>	
	<p>Press the START button. Display SPdE.</p>	
	<p>Press the PERMANENT PRESS or the DELICATES button until LoFF appears in the display.</p>	
	<p>Press the START button. Press PERMANENT PRESS or DELICATES button and then select d15b or EnAb.</p> <div style="display: flex; justify-content: space-around;"> <div data-bbox="459 1353 789 1432">  <p>Disable</p> </div> <div data-bbox="459 1449 784 1527">  <p>Enable</p> </div> </div>	<p>One or the other will display.</p> <div style="display: flex; justify-content: space-around;">   </div>
	<p>Press the START button. The machine sets up the Vend type, then advances to the next process automatically.</p>	
	<ol style="list-style-type: none"> 1. Continue to set up the next mode. 2. Stop the change of setup value and go back to ready mode. <ul style="list-style-type: none"> • Coin type - Close the service door. • Card type - Pull the service card. 	







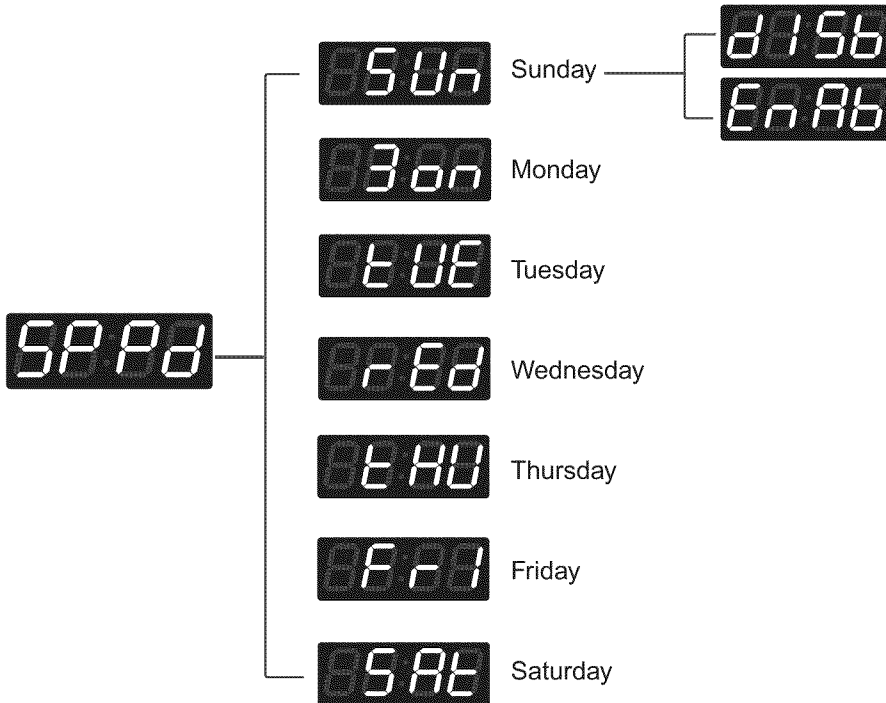



4 How to enter the special price day setup

	Button	Display
Entering set up mode. You will see LqC1 	Press the WHITES AND COLORS button.	
	Press the PERMANENT PRESS or the DELICATES button until SEUP appears in the display.	
	Press the START button.	
	Press the PERMANENT PRESS or the DELICATES button until SPPd appears in the display.	
	Press the START button. Display SUn .	

■ Structure of **SPPd**









4-1 How to change sunday

	Button	Display
<p>Entering set up mode. You will see LqC1</p> 	<p>Press the WHITES AND COLORS button.</p>	
	<p>Press the PERMANENT PRESS or the DELICATES button until SEUP appears in the display.</p>	
	<p>Press the START button.</p>	
	<p>Press the PERMANENT PRESS or the DELICATES button until SPPd appears in the display.</p>	
	<p>Press the START button. Display SUn.</p>	
	<p>Press the START button. Press PERMANENT PRESS or DELICATES button and then select d15b or EnAb.</p> <div style="display: flex; justify-content: space-around; margin-top: 10px;"> <div data-bbox="464 1219 792 1300">  <p>Disable</p> </div> <div data-bbox="464 1310 787 1391">  <p>Enable</p> </div> </div>	<p>One or the other will display.</p> <div style="display: flex; justify-content: space-around; margin-top: 10px;">   </div>
	<p>Press the START button. The machine sets up the special price day (Sunday), then advances to the next process automatically.</p>	
	<ol style="list-style-type: none"> 1. Continue to set up the next mode. 2. Stop the change of setup value and go back to ready mode. <ul style="list-style-type: none"> • Coin type - Close the service door. • Card type - Pull the service card. 	







Note

As explained on the previous page, other days can be set up by the same method.

5 Special price beginning time setup

	Button	Display
<p>Entering set up mode. You will see LqC1</p> 	<p>Press the WHITES AND COLORS button.</p>	
	<p>Press the PERMANENT PRESS or the DELICATES button until SEUP appears in the display.</p>	
	<p>Press the START button.</p>	
	<p>Press the PERMANENT PRESS or the DELICATES button until SP6E appears in the display.</p>	
	<p>Press the START button. Display previous special price beginning time.</p>	
	<p>Press PERMANENT PRESS(+) or DELICATES(-) button to select time between 0 and 23.</p>	
	<p>Press the START button. The machine sets up the special price beginning time, then advances to the next process automatically.</p>	
	<p>1. Continue to set up the next mode. 2. Stop the change of setup value and go back to ready mode. • Coin type - Close the service door. • Card type - Pull the service card.</p>	







6 Special price ending time setup

	Button	Display
Entering set up mode. You will see LqC1 	Press the WHITES AND COLORS button.	
	Press the PERMANENT PRESS or the DELICATES button until SETUP appears in the display.	
	Press the START button.	
	Press the PERMANENT PRESS or the DELICATES button until SPEED appears in the display.	
	Press the START button. Display previous special price ending time.	
	Press PERMANENT PRESS(+) or DELICATES(-) button to select time between 0 and 23 .	
	Press the START button. The machine sets up the special price ending time, then advances to the next process automatically.	
	1. Continue to set up the next mode. 2. Stop the change of setup value and go back to ready mode. <ul style="list-style-type: none"> • Coin type - Close the service door. • Card type - Pull the service card. 	







Note

When setting up a special price period, the ending time must be later than the beginning time.

7 Regular priced dryer cycle time

	Button	Display
<p>Entering set up mode. You will see LqC1</p> 	<p>Press the WHITES AND COLORS button.</p>	
	<p>Press the PERMANENT PRESS or the DELICATES button until SEUP appears in the display.</p>	
	<p>Press the START button.</p>	
	<p>Press the PERMANENT PRESS or the DELICATES button until RPDC appears in the display.</p>	
	<p>Press the START button. Display previous regular priced dryer cycle time.</p>	
	<p>Press PERMANENT PRESS(+) or DELICATES(-) button to select time between 10 and 99.</p>	
	<p>Press the START button. The machine sets up the regular priced dryer cycle time, then advances to the next process automatically.</p>	
	<p>1. Continue to set up the next mode. 2. Stop the change of setup value and go back to ready mode. • Coin type - Close the service door. • Card type - Pull the service card.</p>	







8 Special priced dryer cycle time

	Button	Display
Entering set up mode. You will see LqC1 	Press the WHITES AND COLORS button.	
	Press the PERMANENT PRESS or the DELICATES button until SEUP appears in the display.	
	Press the START button.	
	Press the PERMANENT PRESS or the DELICATES button until SPDC appears in the display.	
	Press the START button. Display previous special priced dryer cycle time.	
	Press PERMANENT PRESS(+) or DELICATES(-) button to select time between 10 and 99 .	
	Press the START button. The machine sets up the special priced dryer cycle time, then advances to the next process automatically.	
	1. Continue to set up the next mode. 2. Stop the change of setup value and go back to ready mode. <ul style="list-style-type: none"> • Coin type - Close the service door. • Card type - Pull the service card. 	







Note

- CCCC (washing time) is not available in dryer.
- nrPC (rinsing times per cycle) is not available in dryer.
- rt (rinsing time setup) is not available in dryer.
- tSSd (top spin speed) is not available in dryer.

9 Value of coin 1

	Button	Display
<p>Entering set up mode. You will see LqC1</p> 	<p>Press the WHITES AND COLORS button.</p>	
	<p>Press the PERMANENT PRESS or the DELICATES button until SEUP appears in the display.</p>	
	<p>Press the START button.</p>	
	<p>Press the PERMANENT PRESS or the DELICATES button until Co1 appears in the display.</p>	
	<p>Press the START button. Display previous coin 1 value.</p>	
	<p>Press PERMANENT PRESS(+) or DELICATES(-) button to select value of coin 1 (The value can be set from 0 to 9.95 in 5¢ increments.)</p>	
	<p>Press the START button. The machine sets up the value of coin 1, then advances to the next process automatically.</p>	
	<p>1. Continue to set up the next mode. 2. Stop the change of setup value and go back to ready mode.</p> <ul style="list-style-type: none"> • Coin type - Close the service door. • Card type - Pull the service card. 	

10 Value of coin 2 (Set up for top off price and e-suds coin pulse)







	Button	Display
Entering set up mode. You will see LqC1 	Press the WHITES AND COLORS button.	
	Press the PERMANENT PRESS or the DELICATES button until SEUP appears in the display.	
	Press the START button.	
	Press the PERMANENT PRESS or the DELICATES button until C02 appears in the display.	
	Press the START button. Display previous coin 2 value.	
	Press PERMANENT PRESS(+) or DELICATES(-) button to select value of coin 2 (The value can be set from 0 to 9.95 in 5¢ increments.)	
	Press the START button. The machine sets up the value of coin 2, then advances to the next process automatically.	
	1. Continue to set up the next mode. 2. Stop the change of setup value and go back to ready mode. <ul style="list-style-type: none"> • Coin type - Close the service door. • Card type - Pull the service card. 	

Note

- Coin type : Value of coin 2 is same function as setting for the e-Suds coin pulse.
- Card type : Value of coin 2 is same function as the top off price.
 (As changing the value of coin 2, you can change the top off price and e-Suds coin pulse.)

11 Penny increment pricing offset







This represents the cent increment price offset used when debit card is setup.

	Button	Display
Entering set up mode. You will see LqC1 	Press the WHITES AND COLORS button.	
	Press the PERMANENT PRESS or the DELICATES button until SEUP appears in the display.	
	Press the START button.	
	Press the PERMANENT PRESS or the DELICATES button until PIPo appears in the display.	
	Press the START button. Display previous penny increment pricing offset.	
	Press PERMANENT PRESS(+) or DELICATES(-) button to select value of PIPo. (0~4)	
	Press the START button. The machine sets up the PIPo, then advances to the next process automatically.	
	1. Continue to set up the next mode. 2. Stop the change of setup value and go back to ready mode. <ul style="list-style-type: none"> • Coin type - Close the service door. • Card type - Pull the service card. 	

Note

- Penny increment pricing offset is available only in card type.
(It hasn't affected on the coin type's price setting.)

12 Top off time

	Button	Display
<p>Entering set up mode. You will see LqC1</p> 	<p>Press the WHITES AND COLORS button</p>	
	<p>Press the PERMANENT PRESS or the DELICATES button until SEUP appears in the display.</p>	
	<p>Press the START button.</p>	
	<p>Press the PERMANENT PRESS or the DELICATES button until LoPE appears in the display.</p>	
	<p>Press the START button. Display previous top off time.</p>	
	<p>Press PERMANENT PRESS(+) or DELICATES(-) button to select time between 1 and 30.</p>	
	<p>Press the START button. The machine sets up the top off time, then advances to the next process automatically.</p>	
	<p>1. Continue to set up the next mode. 2. Stop the change of setup value and go back to ready mode. • Coin type - Close the service door. • Card type - Pull the service card.</p>	

Diagnostic tests : **EESE (display)**

This program has been added for testing the dryer and detecting errors.

Entering the test mode

Data Name	Button	Display	Description
Entering the test mode	1. Entering programming mode	L9C1	Insert service card (card type), open the service door (coin type).
	2. WHITES AND COLORS	EESE	Press the WHITES AND COLORS button. Then EESE appears in the display.
	3. START	L9C1	Enter the diagnostic test mode.

1 **L9C1**

Pressing the **START** button cycles to the next test function.









Number of times the START button is pressed	Checking point	Display
None		LqC 1
1 time	Check the version and code of machine. ■ ELECTRIC TYPE : US:0E ■ GAS TYPE : US:0g	Version and code of machine (All LED on) Display US:0E or US:0g and EU:XX alternately. XX is the version number.
2 times	Motor runs.	Measured moisture value (70~239)
3 times	■ ELECTRIC TYPE: Heater runs. Motor + Heater 1 (2700W) ■ GAS TYPE: GAS valve runs. Motor + Valve	Current temperature (5~70) (Displays the temperature inside the drum in ° Celsius.)
4 times	■ ELECTRIC TYPE: Heater runs. Motor + Heater 1 +Heater 2 (5400W) ■ GAS TYPE: GAS valve runs. Motor+Valve	Current temperature (5~70) (Displays the temperature inside the drum in ° Celsius.)
5 times	LED & KEY CHECK Press WHITES AND COLORS button. Press PERMANENT PRESS button. Press DELICATES button.	Version and code of machine
6 times	Test ends.	LqC1
During check, if the door is open.	Door switch (Motor & Heater Off, Buzzer beeps seven times)	dE (The door is open. Please close the door completely)
During check, if the door is closed	Test goes back at step 2. (Motor on & Heater Off)	Measured moisture value (70~239)

Note

During LqC1 test, if no buttons are pressed for 4 minutes, machine will be turned off automatically.
Do not use **L9C2**.

2 Factory reset - EEPT













After a factory reset, all values are reset to the default values.

	Button	Display
Entering set up mode. You will see LqC1 	Press the PERMANENT PRESS or the DELICATES Button until  appears in the display.	
	Press the START button.	
	Press the PERMANENT PRESS button until  appears in the display.	
	Press the START button, then factory reset is done.  is displayed.	
	1. Continue to set up the next mode. 2. Stop the change of setup value and go back to ready mode. <ul style="list-style-type: none"> • Coin type - Close the service door. • Card type - Pull the service card. 	

Note









- Dryer default value
 - Drying time 45 Minute
 - Top off time 15 Minute

3 Time Set Up

	Button	Display
<p>Entering set up mode. You will see LqC1</p> 	<p>Press the PERMANENT PRESS or the DELICATES button until  appears in the display.</p>	
	<p>Press the START button. The display cycles through 2000 --> 0101 --> Sat --> 0000.</p>	
	<p>Press the START button.</p>	
	<p>Press PERMANENT PRESS (+) or DELICATES(-) button to select year between 2000 and 2099.</p>	
	<p>Press the START button. The machine sets up the year, then advances to the next process automatically.</p>	
	<p>Press PERMANENT PRESS (+) or DELICATES(-) button to select month between 01 and 12.</p>	
	<p>Press the START button. The machine sets up the month, then advances to the next process automatically.</p>	
	<p>Press PERMANENT PRESS (+) or DELICATES(-) button to select day between 01 and 31.</p>	
	<p>Press the START button. The machine sets up the day, then advances to the next process automatically.</p>	
	<p>Press PERMANENT PRESS (+) or DELICATES(-) button to select hour between 00 and 23.</p>	
	<p>Press the START button. The machine sets up the hour, then advances to the next process automatically.</p>	
	<p>Press PERMANENT PRESS (+) or DELICATES(-) button to select minute between 00 and 59.</p>	
	<p>Press the START button. The machine sets up the minute.</p>	
<p>1. Continue to set up the next mode. 2. Stop the change of setup value and go back to ready mode. • Coin type - Close the service door. • Card type - Pull the service card.</p>		







4 Courtesy cycle

Courtesy cycle is like a complimentary cycle given to the customer when the dryer goes out of order when the customer has made the payment to dry one's clothes.



	Button	Display
<p>Entering set up mode. You will see LqC1</p> 	<p>Press the PERMANENT PRESS or the DELICATES Button until  appears in the display.</p>	
	<p>Press the START button.</p>	
	<p>Press the PERMANENT PRESS button until  appears in the display.</p>	
	<p>Press the START button. Display will show .</p>	
	<p>Select the course you desire.</p> <p>Note</p> <ul style="list-style-type: none"> In case of dryer card type, it has to insert the cash card after removing the service card. Then press the cycle course and the start button. (It is only applicable to the dryer's card type specially and there is no subtraction in card balance at the Courtesy cycle.) 	
	<p>Press the START button. Display will show the remaining time and start.</p>	

5 Cycle Kill

■ **Coin type**

<p>Opening the service door.</p> <p>You will see LqC1</p> 	Button	Display
	Press the PERMANENT PRESS or the DELICATES Button until HILL appears in the display.	
	Press the START button.	
	Press the PERMANENT PRESS button until  appears in the display.	
	Press the START button.	
	Display done with beeping.	
	Display End with beeping.	
	Go back to ready mode.	





■ **Card type**

<p>Insert cycle kill card.</p>	Descriptions	Display
	Display the current time and done .	
	Display End with beeping.	
Go back to ready mode.		

Collect Information Data : CLCt (display)

The dryer collects the usage data so that the owner can check various information like number of various cycles used, how many times card or coins used, etc.

Entering the collect mode

Data Name	Step (Button)	LED Display	Description
Entering the collect mode	1. Entering the programming mode.		Insert service card(card type), open the service door(coin type).
	2. WHITES AND COLORS		Press the WHITES AND COLORS button until "tEST" appears in the display.
	3. DELICATES		Press the PERMANENT PRESS or DELICATES button until "CLCt" appears in the display.
	4. START		Enter the Collect information data.
	5. PERMANENT PRESS or DELICATES		Move to each data list that you want to check by pressing with PERMANENT PRESS or DELICATES button.
	6. START		Display the value of selected data list

❖ Check the collect information reference to the follow lists. The Lists are displayed by abbreviations.

■ Collect Mode Data lists

No.	Abbreviation	Meaning	Description
1	rgPr	Regular Price	0~199 nickels (\$.00~\$9.95)
2	rgCP	Regular Cold Price	rgCP is not available in dryer. (It can't enter.)
3	rgrP	Regular Warm Price	rgrP is not available in dryer. (It can't enter.)
4	rgHP	Regular Hot Price	rgHP is not available in dryer. (It can't enter.)
5	dELC	Dryer Moisture Sense	dELC is not available in dryer. (It can't enter.)
6	ltrC	Interval Regular Cycles	Number of Regular cycles (0~65535)
7	ltCC	Interval Regular Cold Cycles	ltCC is not available in dryer. (It can't enter.)
8	ltAC	Interval Regular Warm Cycles	ltAC is not available in dryer. (It can't enter.)
9	ltHC	Interval Regular Hot Cycles	ltHC is not available in dryer. (It can't enter.)
10	ltSC	Interval Super Cycles	ltSC is not available in dryer. (It can't enter.)
11	lttF	Interval Topoff Cycles (Dryer Only)	Number of Topoff cycles (0~65535)
12	ltUC	Interval Service Cycles	Number of Service cycles (0~65535)
13	ltFC	Interval Token Cycles	Number of Token cycles (0~65535)
14	ACrC	Accumulated Regular Cycles	Number of Regular cycles (0~65535)
15	ACCC	Accumulated Regular Cold Cycles	ACCC is not available in dryer. (It can't enter.)
16	ACAC	Accumulated Regular Warm Cycles	ACAC is not available in dryer. (It can't enter.)
17	ACHC	Accumulated Regular Hot Cycles	ACHC is not available in dryer. (It can't enter.)
18	ACSC	Accumulated Super Cycles (Washer Only)	ACSC is not available in dryer. (It can't enter.)
19	ACTF	Accumulated Topoff Cycles (Dryer Only)	Number of Topoff cycles (0~65535)
20	ACUC	Accumulated Service Cycles	Number of Service cycles (0~65535)

* Interval Cycles('Interval' means 'Since last data collecting')

* Accumulated Cycles('Accumulated'means 'Total cycles in washer/dryer's life time not include service cycles or trouble cycles')

■ Collect Mode Data lists

No.	Abbreviation	Meaning	Description
21	ACFC	Accumulated Token Cycles	Number of Token cycles (0~65535)
22	ACrt	Accumulated Run Time	Number of Running minutes (0~65535)
23	ltnr	Interval No Runs	ltnr is not available in dryer.
24	ltnb	Interval Trouble Cycles	ltnb is not available in dryer.
25	ltpd	Interval Power Downs	Number of power down
26	ltdd	Interval Unauthorized Service Door Openings	Number of Unauthorized Service Door Openings (0~ 255)
27	ltad	Interval Authorized Service Door Openings	Number of Unauthorized Service Door Openings (0~ 255)
28	ltuc	Interval Unauthorized Coin Vault Openings	Number of Authorized Service Door Openings (0~ 255)
29	ltac	Interval Authorized Coin Vault Openings	Number of Authorized Service Door Openings (0~ 255)
30	tlldo	Time of Last Service Door Opening	tlldo is not available in dryer.(It can't enter.)
31	tlldo	Time of Last Coin Vault Opening	tlldo is not available in dryer.(It can't enter.)
32	tlldo	Time of Previous Service Door Opening	tlldo is not available in dryer.(It can't enter.)
33	tlldo	Time of Previous Coin Vault Opening	tlldo is not available in dryer.(It can't enter.)
34	scpr	Super Cycle Price	Scpr is not available in dryer. (It can't enter.)
35	topr	Top Off Price	0~199 nickels (\$.00~\$9.95)

- * Authorized: Service Door Openings with PDA Communication
(Open Service door Within 30 minutes After communicating with PDA)
- * Unauthorized: Service Door Openings without PDA Communication
- * These items (No.30~33) are not applied this program.

Part 6

ERROR MODE

- Meaning of Error Codes that LED displays during occurrence or problem.

Dryer error code

PROBLEM	POSSIBLE CAUSE	SOLUTION
EE1	It is displayed when thermistor is open.	Thermistor should be replaced.
EE2	It is displayed when thermistor is shorted.	Thermistor should be replaced.
CAE	Disconnection of card reader wire.	Check the card reader wire.

Part 7

POWER FAIL RECOVERY

In case of power failure the machine stops running but the time display remains on, showing the time just before power failure.

Press the **START** button after the power is restored, then the machine will restart.

Part 8

DEFAULT DRYER SETTINGS

Default Settings	Default
Cycle Time (Minutes)	45 Minutes
Cool Down Time Cycle	2 Minutes
High Temperature	154.4° F (68° C)
Medium Temperature	140° F (60° C)
Low Temperature	125.6° F (52.5° C)
Top Off Time (Minutes per coin)	15 Minutes
Coin #1 Value	25¢
Coin #2 Value	25¢
Minutes/Minutes and seconds	Minutes
Fahrenheit/Celsius	Fahrenheit
Error Mode	On

**LG ELECTRONICS, INC.
LG COMMERCIAL DRYER LIMITED WARRANTY - USA**

Should any part in your LG Commercial Dryer fail due to a defect in material or workmanship under normal use, during the warranty period set forth below, LG will provide a replacement part. This limited warranty is valid only to the original purchaser of the product and applies only when used within the United States, excluding U.S. Territories. Proof of original purchase is required to obtain a replacement part under this limited warranty.

<p>WARRANTY PERIOD (Please see OPL* below): PARTS ONLY, does NOT include Labor and/or shipping. Note: If the original date of purchase can not be verified, the warranty will begin 60 days from the date of manufacture.</p>	
<p>TWO (2) YEARS from the date of original purchase</p>	<p>THREE (3) YEARS from the date of original purchase</p>
<p>All parts.</p>	<p>Electronic controls: Main control board and user interface board. Motor, electric element and stainless steel drum. In addition, the following cabinet parts are warranted against rust through: top plate, cabinet, base and door.</p>

- * OPL (On Premise Laundry), defined as non-vented commercial products used in locations such as hotels, hospitals, health clubs, businesses, etc. will have one (1) full year parts only warranty. Labor and shipping are NOT included.
- ☛ Replacement Units and Repair Parts may be new or remanufactured.
- ☛ Replacement Units and Repair Parts are warranted for the remaining portion of the original warranty period.

THIS WARRANTY IS IN LIEU OF ANY OTHER WARRANTY, EXPRESS OR IMPLIED, INCLUDING WITHOUT LIMITATION, ANY WARRANTY OF MERCHANTABILITY OR FITNESS FOR A PARTICULAR PURPOSE. TO THE EXTENT ANY IMPLIED WARRANTY IS REQUIRED BY LAW, IT IS LIMITED IN DURATION TO THE EXPRESS WARRANTY PERIOD ABOVE. NEITHER THE MANUFACTURER NOR ITS U.S. DISTRIBUTOR SHALL BE LIABLE FOR ANY INCIDENTAL, CONSEQUENTIAL, INDIRECT, SPECIAL, OR PUNITIVE DAMAGES OF ANY NATURE, INCLUDING WITHOUT LIMITATION, LOST REVENUES OR PROFITS, OR ANY OTHER DAMAGE WHETHER BASED IN CONTRACT, TORT, OR OTHERWISE. Some states do not allow the exclusion or limitation of incidental or consequential damages or limitations on how long an implied warranty lasts, so the above exclusion or limitation may not apply to you. This warranty gives you specific legal rights and you may also have other rights that vary from state to state.

THIS LIMITED WARRANTY DOES NOT APPLY TO:

1. Service trips to deliver, pick up, install, or repair the product.
2. Failure of product to perform during power failures and interruptions or inadequate electrical service.
3. Damage caused by leaky or broken water pipes, frozen water pipes, restricted drain lines, inadequate or interrupted water supply or inadequate supply of air.
4. Damage resulting from running the product in a corrosive atmosphere or contrary to the instructions outlined in the product owner's manual.
5. Damage to the product caused by accidents, pest and vermin, lightning, wind, fire, floods, or acts of God.
6. Damage resulting from misuse, abuse, improper installation, repair, or maintenance. Improper repair include use of parts not approved or specified by LG.
7. Damage or failure caused by unauthorized modification or alteration, or if it is used for other than intended purpose.
8. Damage or failure caused by incorrect electrical current ,voltage or plumbing codes, or use of accessories, components or consumable cleaning products that are not approved by LG.
9. Damage caused by transportation and handling, including scratches, dents, chips, and/or other damage to the finish of your product, unless such damage results from defects in materials or workmanship and is reported within one (1) week of delivery.
10. Damage to any display, open box, discounted, or refurbished product.
11. Products with original serial numbers that have been removed, altered or can not be readily determined.
12. Increases in utility costs and additional utility expenses.
13. Replacement of light bulbs, filters or any consumable parts.

The cost of repair or replacement under these excluded circumstances shall be borne by the consumer.

For complete warranty details or any questions,

please call or write:

LG Commercial Product Support:

P. O. Box 240007

201 James Record Road

Huntsville, Alabama 35813

Call: 1-888-865 -3026 and select the appropriate option from the menu.

Product Registration Information

Model:

Serial Number:

Date of Purchase:

Please be prepared to provide proof of purchase, model and serial number.

