



ENGLISH

ESPAÑOL

# OWNER'S MANUAL GAS DOUBLE OVEN RANGE

Please read this guide thoroughly before operating  
and keep it handy for reference at all times.

LDG3011ST



P/No.: MFL33029610

[www.lg.com](http://www.lg.com)

### **3 PRODUCT FEATURES**

---

### **4 IMPORTANT SAFETY INSTRUCTIONS**

---

### **10 BEFORE USE**

---

- 10 Accessories
- 11 Components

### **12 HOW TO USE**

---

- 12 Gas Surface Burners
  - 12 - Before Use
  - 13 - Gas Burners
  - 13 - Using the Gas Surface Burners
  - 14 - Top-of-Range Cookware
- 15 How to Use the Oven
  - 15 - Before Use
  - 17 - Using the Control Panel
  - 19 - Operating Instructions
  - 22 - Removing and Replacing the Oven Racks
  - 23 - BAKE (Upper & Lower Oven)
  - 24 - Preheating and Pan Placement
  - 25 - BROIL (Upper Oven)
  - 27 - TIMED COOK (Upper & Lower Oven)
  - 27 - DELAYED TIMED COOK (Upper & Lower Oven)
- 28 Special Features
  - 28 - PIZZA (Upper Oven)
  - 28 - WARM (Upper & Lower Oven)
  - 29 - PROOF (Lower Oven)
  - 30 - SABBATH (Upper & Lower Oven)

### **31 CARE AND CLEANING**

---

- 31 Gas Surface Burner
  - 31 - Removing and Replacing the Gas Surface Burner
  - 31 - Burner Heads/Caps
  - 32 - Burner Grates
  - 33 - Cooktop Surface
  - 33 - Stainless Steel Surfaces
  - 33 - Oven Air Vents
  - 33 - Control Panel
  - 33 - Front Manifold Panel and Knobs
  - 34 - Oven Door
  - 34 - Removing and Replacing the Doors
- 36 Inside of the Oven
  - 36 - SELF CLEAN (Upper & Lower Oven)
  - 38 - Changing the Oven Light
  - 38 - Broiler Pan and Grid (Sold separately)
  - 38 - Oven Racks

### **39 BEFORE REQUESTING SERVICE**

---

### **41 WARRANTY**

---

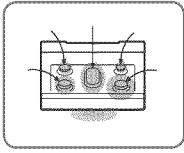

**MULTIPLE GAS BURNER SIZES**

Choose a burner to fit the size of your cookware.  
Cooking multiple items at once is possible by using different burners at the same time.



**SAFE, CONVENIENT AND GREEN GAS RANGE**

Provides safety and convenience for cooking, as well as green technology.  
Superboil (17000 BTU) can quickly bring a pot of water to a boil.



**UPPER OVEN / LOWER OVEN**

Separate upper and lower ovens.  
Choose to use either oven, or both, depending on the size of your food.

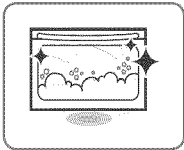

**SELF CLEAN**

Good for easy cleaning.



## IMPORTANT SAFETY INSTRUCTIONS

Always comply with the following precautions to avoid dangerous situations and to ensure the peak performance of your product.

### WARNING

Indicates a hazardous situation which, if not avoided, could result in death or serious injury.

### CAUTION

Indicates a hazardous situation which, if not avoided, could result in minor or moderate injury.

## WHAT TO DO IF YOU SMELL GAS

1. Open windows.
2. **DO NOT** try to light any appliance.
3. **DO NOT** touch any electrical switch.
4. **DO NOT** use any phone in your building.
5. Immediately call your gas supplier from a neighbor's phone. Follow the gas supplier's instructions.
6. If you cannot reach your gas supplier, call the fire department.

## ANTI-TIP DEVICE

### WARNING

- ALL RANGES CAN TIP
- INJURY TO PERSONS COULD RESULT
- INSTALL ANTI-TIP DEVICES PACKED WITH RANGE
- SEE INSTALLATION INSTRUCTIONS



- **DO NOT** step or sit on the door. Install the Anti-Tip Bracket packed with this range.
  - The range could be tipped and injury might result from spilled hot liquid, food, or the range itself.
  - If the range is pulled away from the wall for cleaning, service, or any other reason, ensure that the Anti-Tip Device is properly reengaged when the range is pushed back against the wall.

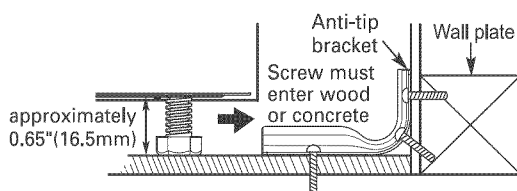

- To reduce the risk of the range tipping over, the range must be secured by properly installing the anti-tip devices.
- To check that the anti-tip bracket is properly installed: Remove any items on the cooktop. Grasp the top rear edge of the range back guard and carefully attempt to tilt it forward. Verify that the anti-tip devices are engaged.
- Remove the warming or storage drawers and visually inspect that the rear leveling leg is fully inserted into the anti-tip bracket.
- Refer to the installation manual for proper anti-tip bracket installation.

## IMPORTANT SAFETY NOTICE

Enforcement Act requires the Governor of California to publish a list of substances known to the state to cause birth defects or other reproductive harm, and requires businesses to warn customers of potential exposure to such substances.

Gas appliances can cause minor exposure to four of these substances, namely benzene, carbon monoxide, formaldehyde and soot, caused primarily by the imperfect combustion of natural or LP gas.

Correctly adjusted burners, indicated by a bluish rather than a yellow flame, will minimize imperfect combustion. Exposure to these substances can be minimized by opening windows or using a ventilation fan or hood.

## SAFETY PRECAUTIONS

**Have the installer show you the location of the range gas shut-off valve and how to shut it off if necessary.**

- Make sure your range is properly installed and grounded by a qualified installer, according to the installation instructions. Any adjustment and service should be performed only by qualified gas range installers or service technicians.
- Plug your range into a 120-volt grounded outlet only. Do not remove the round grounding prong from the plug. If in doubt about the grounding of the home electrical system, it is your personal responsibility and obligation to have an ungrounded outlet replaced with a properly grounded, three-prong outlet in accordance with the National Electrical Code. Do not use an extension cord with this range.
- **DO NOT** use an adapter plug, an extension cord, or remove the grounding prong from the electrical power cord to prevent fire hazard or electrical shock. Failure to follow this warning can cause serious injury, fire or death.
- To prevent poor air circulation, place the range out of kitchen traffic path and out of drafty locations.
- **DO NOT** attempt to repair or replace any part of your range unless it is specifically mentioned in this manual. All other services should be referred to a qualified technician.
- Make sure that all packaging materials are removed from the range before operating it to prevent fire or smoke damage should the packaging material ignite.
- Make sure your range is properly adjusted by a qualified service technician or installer for the type of gas (natural or LP) that is to be used. Your range can be converted for use with either type of gas. See the installation instructions.
- In an emergency situation or if you want to shut off the gas supply, remove the packing rubber from the regulator in the backside, and then close the regulator's valve by positioning the lever as shown in the figure below.

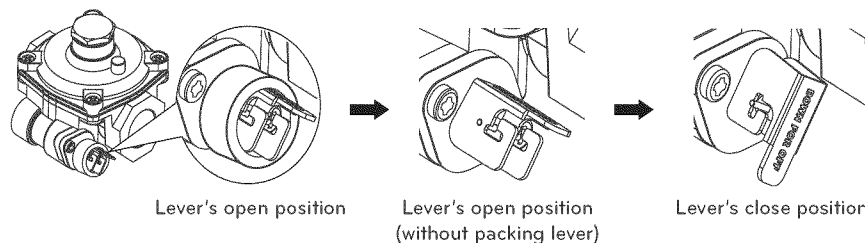

### WARNING

These adjustments must be done by a qualified service technician according to the manufacturer's instructions and all codes and requirements of the authority having jurisdiction. Failure to follow these instructions could result in serious injury or property damage. The qualified agency performing these adjustments assumes responsibility for the conversion.

- After using your range for a long time, high floor temperatures may result and many floor coverings will not withstand this kind of use.
- **NEVER** install the range over vinyl tile or linoleum that cannot withstand such type of use. Never install it directly over interior kitchen carpeting.

### CAUTION

Items of interest to children should not be placed in cabinets above a range or on the backsplash of a range—children climbing on the range to reach items could be seriously injured.

- **DO NOT** leave children alone or unattended where a range is hot or in operation. They could be seriously burned.
- **DO NOT** let anyone climb, stand or hang on the oven door, warming drawer or cooktop. They could damage the range and even tip it over, causing severe personal injury.

 **WARNING**

- **NEVER** use your range as a space heater to heat or warm the room. Doing so may result in carbon monoxide poisoning and overheating of the oven.
- **NEVER** wear loose fitting or hanging garments while using the appliance. Be careful when reaching for items placed in cabinets over the range. Flammable materials could be ignited if brought in contact with flame or hot oven surfaces and may cause severe burns.
- **DO NOT** place flammable materials in the oven or near the cooktop.
- **DO NOT** place or use combustible materials such as gasoline or other flammable vapors and liquids in the vicinity of this or any other appliance.
- **DO NOT** allow cooking grease or other flammable materials in or near the range.
- **DO NOT** use water on grease fires. Never touch a flaming pan. Turn the controls off. Smother a flaming pan on a surface burner by covering the pan completely with a well-fitting lid, cookie sheet or flat tray. Use a multi-purpose dry chemical or foam-type fire extinguisher.  
A grease fire can be put out by covering it with baking soda or, if available, by using a multi-purpose dry chemical or foam-type fire extinguisher.
- Flame in the upper oven or lower oven can be smothered completely by closing the oven door and turning the control to off or by using a multi-purpose dry chemical or foam-type fire extinguisher.
- **DO NOT** use the oven or the drawer for storage.
- Let the burner grates and other surfaces cool before touching them.
- **NEVER** block the vents (air holes) of the range. They provide the air inlet and outlet that are necessary for the range to operate properly with correct combustion. Air openings are located at the rear of the cooktop, at the top and bottom of the oven door, and at the bottom of the range.
- **NEVER** cover any slots, holes or passages in the oven bottom or cover an entire rack with materials such as aluminum foil. Doing so blocks air flow through the oven and may cause carbon monoxide poisoning. Aluminum foil linings may also trap heat, causing a fire hazard.
- **NEVER** obstruct the flow of combustion and ventilation air by blocking the oven vent or air intakes. Doing so restricts air to the burner and may result in carbon monoxide poisoning.
- Large scratches or impacts to glass doors can lead to broken or shattered glass.
- Stepping, leaning or sitting on the doors or drawers of this range can result in serious injuries and also cause damage to the range. Do not allow children to climb or play around the range. The weight of a child on an open door may cause the range to tip, resulting in serious burns or other injury.
- Gas leaks may occur in our system and result in a dangerous situation. Gas leaks may not be detected by smell alone. Gas suppliers recommend you to purchase and install a UL approved gas detector. Install and use in accordance with the gas detector manufacturer's instructions.
- Leak testing of the appliance shall be conducted according to the manufacturer's instructions.
- **DO NOT** use commercial oven cleaners on the oven finish or around any part of the oven. They will damage the finish of parts.
- To prevent staining or discoloration, clean appliance after each use.
- **DO NOT** attempt to open or close the door or operate the oven until the door is properly installed.
- **NEVER** place fingers between the hinge and front oven frame. Hinge arms are spring mounted. If accidentally hit, the hinge will slam shut against the oven frame and could injure your fingers.

 **CAUTION**

- **DO NOT** use the oven for storing food or cookware.
- To prevent damage to the oven door, do not attempt to open the door when Lock is displayed.
- **DO NOT** place excessive weight or stand on an open door. This could cause the range to tip over, break the door, or injure the user.
- **DO NOT** use delayed baking for highly perishable foods such as dairy products, pork, poultry, or seafood.

 **WARNING**

- Disconnect electrical supply before servicing the appliance.
- **NEVER** use appliance door as a step stool or seat, as this may result in possible tipping of the appliance and serious injuries.
- This product should not be installed below ventilation type hood systems that directs air in a downward direction. Doing so may cause ignition and combustion problems with the gas burners resulting in personal injury and may affect the cooking performance of the unit.

## SURFACE BURNERS

### WARNING

- Even if the top burner flame goes out, gas is still flowing to the burner until the knob is turned to the "OFF" position. If you smell gas, immediately open a window and ventilate the area for five minutes prior to using the burner. Do not leave the burners "ON" unattended.
- **Use proper pan size - DO NOT** use pans that are unstable or that can be easily tipped. Select cookware with flat bottoms large enough to cover burner grates. To avoid spillovers, make sure the cookware is large enough to contain the food properly. This will both save cleaning time and prevent hazardous accumulations of food, since heavy spattering or spillovers left on the range can ignite. Use pans with handles that can be easily grasped and remain cool.

### CAUTION

- Be sure that all surface controls are set in the "OFF" position prior to supplying gas to the range.
- **NEVER** leave the surface burners unattended at high flame settings. Boilovers may cause smoke and greasy spillovers that may catch on fire.
- Always turn the knobs to the "LITE" position when igniting the top burners and make sure the burners have ignited.
- Control the top burner flame size so it does not extend beyond the edge of the cookware. Excessive flame is hazardous.
- Only use dry pot holders—moist or damp pot holders on hot surfaces may result in burns from steam. Do not let pot holders come near open flames when lifting cookware. Do not use towels or other bulky cloth items. Use a pot holder.
- Using glass cookware—make sure the cookware is designed for top-of-range cooking.
- To prevent burns from ignition of flammable materials and spillage, turn cookware handles toward the side or back of the range without extending over adjacent burners.
- **NEVER** leave any items on the cooktop. The hot air from the vent may ignite flammable items and will increase pressure in closed containers, which may cause them to burst.
- Carefully watch foods being fried at a high flame setting.
- Always heat fat slowly, and watch as it heats.
- If frying combinations of oils and fats, stir together before heating.
- Use a deep fat thermometer if possible to prevent overheating fat beyond the smoking point.
- Use the least possible amount of fat for effective shallow or deep-fat frying. Filling the pan with too much fat can cause spillovers when food is added.
- **DO NOT** cook foods directly on an open flame on the cooktop.
- **DO NOT** use a wok on the surface burners if the wok has a round metal ring that is placed over the burner grate to support the wok. This ring acts as a heat trap, which may damage the burner grate and burner head. It may also cause the burner to work improperly. This may cause carbon monoxide levels which are higher than what is allowed by current standards, resulting in a health hazard.
- Foods for frying should be as dry as possible. Frost or moisture on foods can cause hot fat to bubble up and spillover the sides of the pan.
- **NEVER** try to move a pan of hot fat, especially a deep fat fryer. Wait until the fat is cool.
- **DO NOT** place plastic items on the cooktop—they may melt if left too close to the vent.
- Keep all plastics away from the surface burners.
- To prevent burns, always be sure that the controls for all burners are in the "OFF" position and all grates are cool before attempting to remove them.
- If you smell gas, turn off the gas to the range and call a qualified service technician. Never use an open flame to locate a leak.
- Always turn the knobs to the "OFF" position before removing cookware.
- **DO NOT** lift the cooktop. Lifting the cooktop can cause damage and improper operation of the range.
- If the range is located near a window, do not hang long curtains that could blow over the surface burners and catch on fire.

## COOK MEAT AND POULTRY THOROUGHLY

To protect against foodborne illnesses, cook meat and poultry thoroughly—meat to at least an INTERNAL temperature of 160°F and poultry to at least an INTERNAL temperature of 180°F.

## SELF CLEANING OVEN

Make sure to wipe off excess spillage before operating the self clean function.

### CAUTION

- **DO NOT** leave food, cooking utensils, racks, etc. in the oven during the self clean cycle.
- **DO NOT** use oven cleaners. No commercial oven cleaner or oven liner protective coating of any kind should be used in or around any part of the oven. Residue from oven cleaners will damage the inside of the oven when the self clean cycle is used.
- Remove oven racks and other items from both upper and lower ovens before starting the self clean cycle.
- Only clean the parts listed in this manual.
- **DO NOT** clean the door gasket. The door gasket is necessary for a good seal. Care should be taken not to rub, damage or move the gasket.
- If the self cleaning mode malfunctions, turn the range off and disconnect the power supply. Have it serviced by a qualified technician.
- It is normal for parts of the oven to become hot during a self clean cycle.
- Avoid touching the door, window or oven vent area during a clean cycle.

## OVEN

When opening the door of a hot oven, stand away from the range. The hot air and steam that escape can cause burns to hands, face and eyes.

### WARNING

**NEVER** block any slots, holes or passages in the oven bottom or cover an entire rack with materials such as aluminum foil. Doing so blocks air flow through the oven and may cause carbon monoxide poisoning. Aluminum foil linings may also trap heat, causing a fire hazard.

- **DO NOT** heat food in closed containers. Pressure inside the container could increase and burst, causing an injury.
- **DO NOT** use aluminum foil anywhere in the oven except as described in this manual. Doing so could create a fire hazard or cause damage to the range.
- **DO NOT** use the oven for storage. Items stored in the oven can catch on fire.
- Keep the oven free from grease buildup.
- Insert the oven racks in the desired position while the oven is cool.
- To prevent burns when removing food, slide racks out until the stop engages, then remove food items.  
This may also protect you from getting burnt from touching hot surfaces of the door or oven walls.
- When placing or removing a griddle, always wear oven mitts.
- When using cooking or roasting bags in the oven, follow the manufacturer's directions.
- Use only glass cookware that is recommended for use in gas ovens.
- Always remove the broiler pan from the range after you finish broiling. Grease left in the pan can catch fire if oven is used without removing the grease from the broiler pan.
- If meat is too close to the flame while broiling, the fat may ignite. Trim excess fat to prevent excessive flare-ups.
- Make sure the broiler pan is in place correctly to minimize the possibility of grease fires.



- If you should have a grease fire in the broiler pan, press the "UPPER CLEAR/OFF" or "LOWER CLEAR/OFF" key, and keep the oven door closed to contain fire until it burns out.
- For safety and better cooking performance, always bake and broil with the oven door closed. Open door baking or broiling can cause damage to the knobs or valves. **DO NOT** leave the oven door open during cooking or cool down.

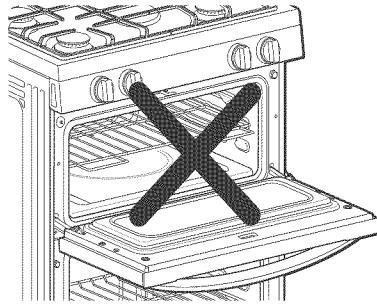

*READ ALL INSTRUCTIONS BEFORE USING THE APPLIANCE.*

**SAVE THESE INSTRUCTIONS**

## BEFORE USE

### Accessories

Make sure that all parts are included after purchasing this product.

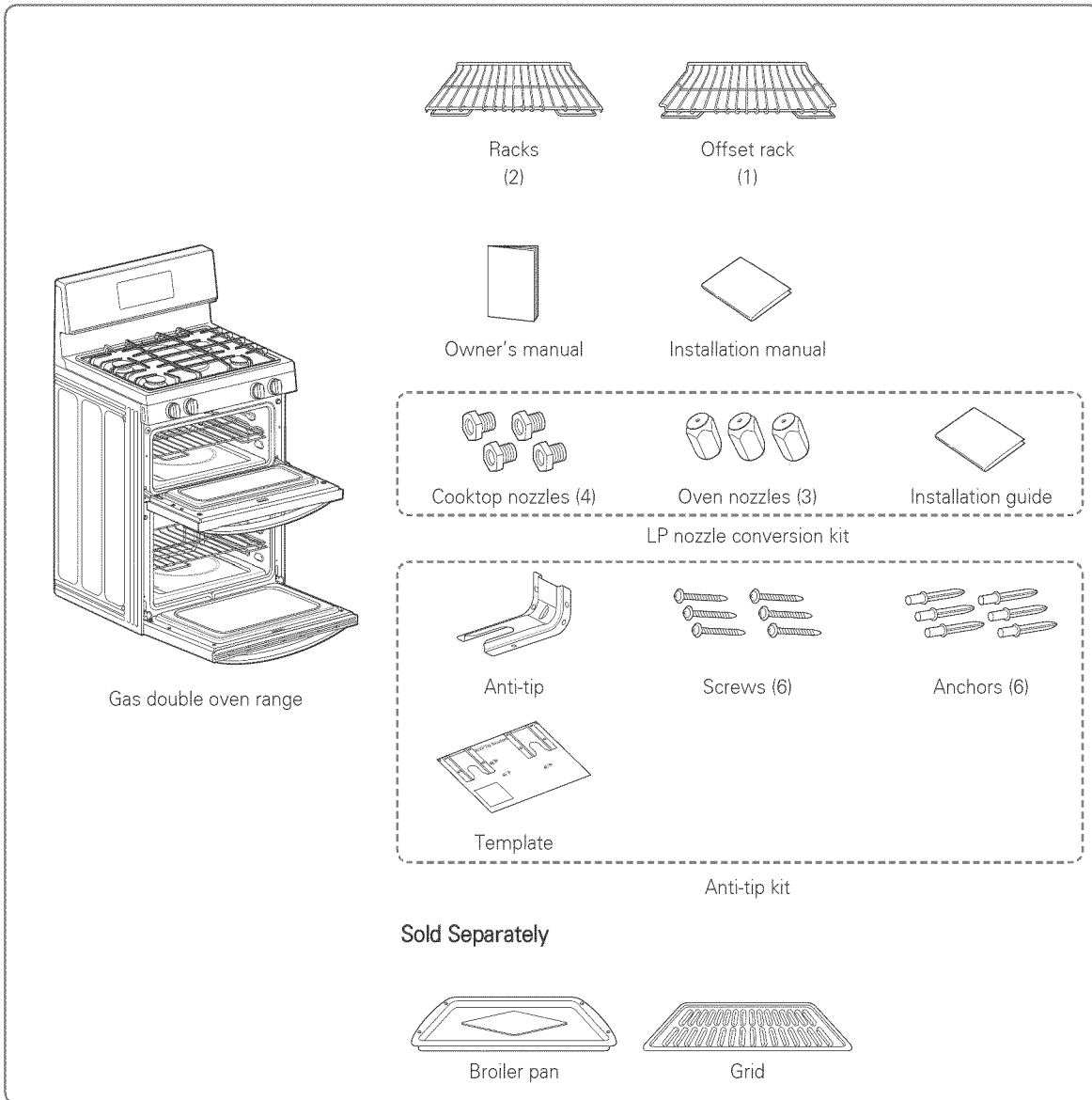

### NOTE

- Contact LG Customer Service if any accessories are missing.
- For your safety and for extended product life, only use authorized components.
- The manufacturer is not responsible for product malfunction or accidents caused by the use of separately purchased, unauthorized components or parts.
- The images in this guide may be different from the actual components and accessories, and are subject to change by the manufacturer without prior notice for product improvement purposes.

## Components

Make sure to understand the names and function of each part.

\* Throughout this manual, the features and appearance may vary depending on your model.

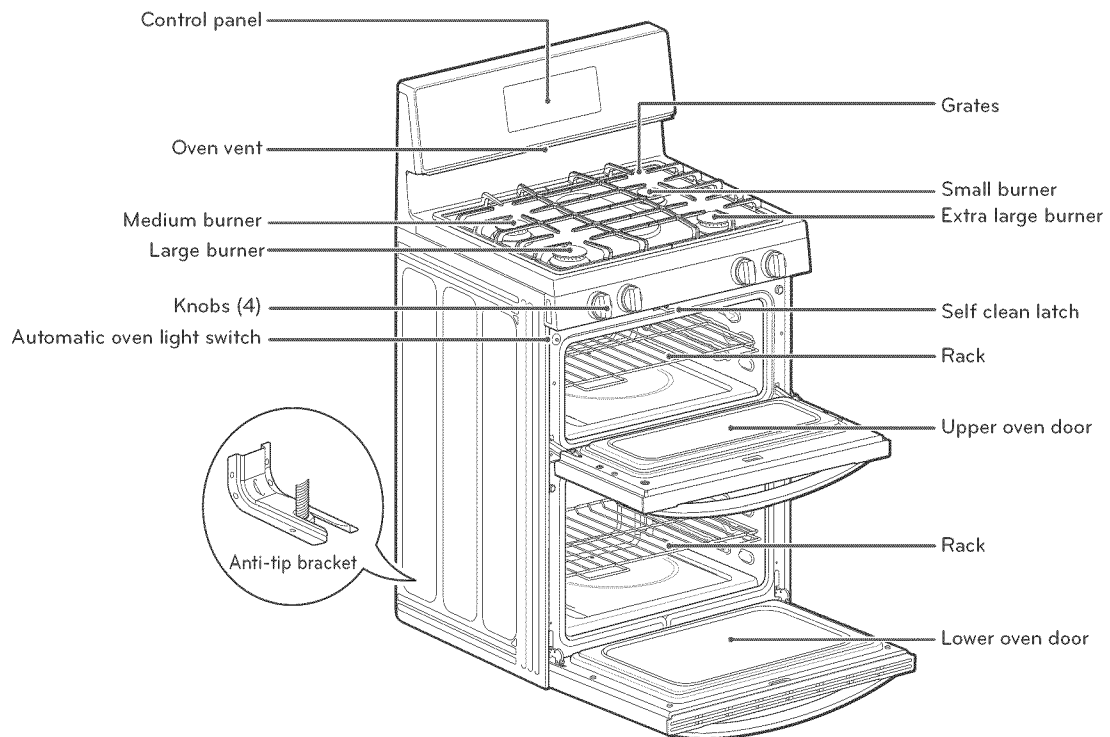

### NOTE

- The model and serial tag is located behind the control panel.

## HOW TO USE

### Gas Surface Burners

#### Before use

Read all instructions before using.

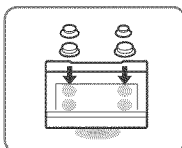

Make sure that all burners are properly placed.

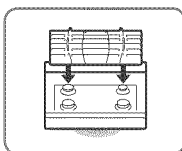

Make sure that all grates are properly placed before using the burner.



#### CAUTION

**DO NOT** operate the burner for an extended period of time without cookware on the grate.  
The finish on the grate may chip without cookware to absorb the heat.

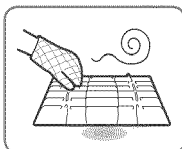

Make sure the burners and grates are cooled down before you place your hand, pot holder, cleaning cloth, or other materials on burners and grates.

Touching grates before cooling down may cause burns.



#### CAUTION

##### WHAT TO DO IF YOU SMELL GAS

1. Open windows.
2. **DO NOT** try to light any appliance.
3. **DO NOT** touch any electrical switch.
4. **DO NOT** use any phone in your building.
5. Immediately call your gas supplier from a neighbor's phone.  
Follow the gas supplier's instructions.
6. If you cannot reach your gas supplier, call the fire department.

## Gas burners

Your gas range cooktop has four sealed gas burners. These can be assembled and separated. Follow the guide below.

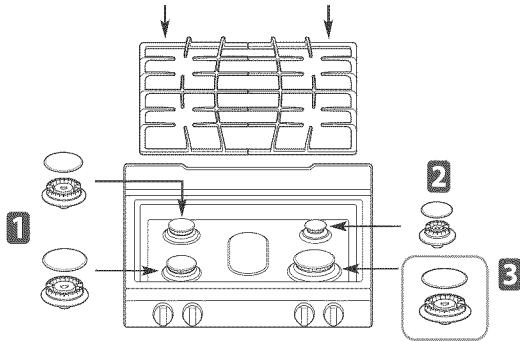

### 1 Medium and Large Burner

The medium and large burners are the primary burners for most cooking. These general purpose burners can be turned down from "HI" to "LO" to suit a wide range of cooking needs.

### 2 Small Burner

The smallest burner is used for delicate foods such as sauces or foods that require low heat for a long cooking time.

### 3 Extra large burner

The extra large burner is the maximum output burner. Like the other four burners, it can be turned down from "HI" to "LO" for a wide range of cooking applications. This burner is also designed to quickly bring large amounts of liquid to a boil. It can be used with cookware 10 inches or larger in diameter.

## Using the gas surface burners

- 1 Be sure that all of the surface burners are placed in the correct positions.
- 2 Put cookware on the burner. (Example: pot, frying pan, etc.)
- 3 Push and turn the control knob to the "LITE" position.

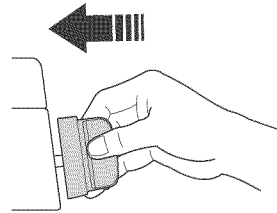

You will hear a clicking noise from the electric spark ignition system.

- 4 Turn the control knob to control the flame size.

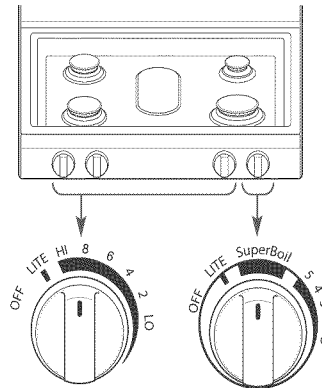

### CAUTION

**DO NOT** attempt to disassemble or clean around any burner while another burner is on. When turning a burner to "LITE", all the burners spark. An electric shock may result, which could cause you to knock over hot cookware.

## Selecting the Flame Size

Watch the flame, not the knob, as you reduce heat. When fast heating is desired, the flame size on a gas burner should match the cookware that you are using.

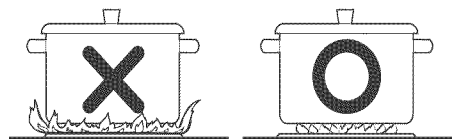

### CAUTION

**NEVER** let the flames extend up the sides of the cookware.

### In Case of Power Failure:

In case of a power failure, you can light the gas surface burners on your range with a match.

Surface burners in use when an electrical power failure occurs will continue to operate normally.

- 1 Hold a lit match to the burner, then push in the control knob.
- 2 Turn the control knob to the "Lo" position.



**CAUTION**

Use extreme caution when lighting burners with a match. It can cause burn and damage.

### Top-of-range cookware

|                         |   |
|-------------------------|---|
| Aluminum                | Medium-weight cookware is recommended because it heats quickly and evenly. Most foods brown evenly in an aluminum skillet. Use saucepans with tight fitting lids when cooking with minimum amounts of water.  |
| Cast-Iron               | If heated slowly, most skillets will give satisfactory results.   |
| Stainless Steel         | This metal alone has poor heating properties and is usually combined with copper, aluminum or other metals for improved heat distribution. Combination metal skillets work satisfactorily if they are used with medium heat as the manufacturer recommends. |
| Enamelware              | Under some conditions, the enamel of this cookware may melt. Follow cookware manufacturer's recommendations for cooking methods.  |
| Glass                   | There are two types of glass cookware - those for oven use only and those for top-of-range cooking.   |
| Heatproof Glass Ceramic | Can be used for either surface or oven cooking. It conducts heat very slowly and cools very slowly. Check cookware manufacturer's directions to be sure it can be used on gas ranges.   |

### Using a Wok:

If using a wok, it is recommended that you use a 14-inch or smaller flat-bottomed wok. Make sure that the wok bottom sits flat on the grate.

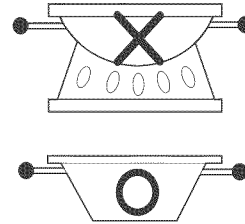

Use a flat-bottomed wok.



**CAUTION**

**DO NOT** use a wok support ring. Placing the ring over the burner or grate may cause the burner to work improperly, resulting in carbon monoxide levels above allowable standards. This can be hazardous to your health.

### Using Stove-top Grills:

Do not place stove-top grills on the burner.



**CAUTION**

**DO NOT** use stove top grills on your surface burners. Using a stove top grill on the surface burner will cause incomplete combustion and can result in exposure to carbon monoxide levels above allowable current standards. This can be hazardous to your health.

## How to Use the Oven

### Before use

Read all instructions before using.

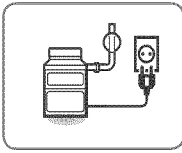

**Make sure the electrical power cord and the gas valve are properly connected.**

Check it for safety.

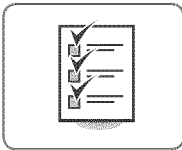

**Check the correct use of the range depending on the type of food you will cook.**

Make sure you know how to use the oven (temperature setting, time setting and recipe) for best results.

### CAUTION

#### WHAT TO DO IF YOU SMELL GAS

1. Open windows.
2. **DO NOT** try to light any appliance.
3. **DO NOT** touch any electrical switch.
4. **DO NOT** use any phone in your building.
5. Immediately call your gas supplier from a neighbor's phone.  
Follow the gas supplier's instructions.
6. If you cannot reach your gas supplier, call the fire department.



**Choose the upper or lower oven for proper cooking.**

Use the upper oven to cook a small amount of food.

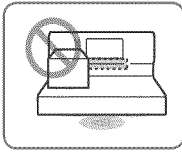

### Do not block, touch or place items around the oven vent during cooking.

Your oven is vented through ducts at the center above the burner grate. Do not block the oven vent when cooking to allow for proper air flow. Do not touch vent openings or nearby surfaces during the use of any cooking operation.

#### CAUTION

- **DO NOT** place plastic or flammable items on the cooktop—they may melt or ignite if left too close to the vent.
- **DO NOT** place closed containers on the cooktop. The pressure in closed containers may increase, which may cause them to burst.
- Metal items will become very hot if they are left on the cooktop, and could cause burns.
- Handles of pots and pans on the cooktop may become hot if left too close to the vent.

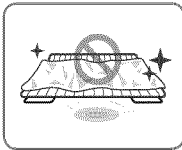

### Do not cover rack or bottom with aluminum foil.

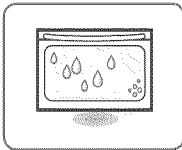

### As your oven heats up, the temperature increase of the air in the oven may cause water drops to occur on the door glass.

These water drops are harmless and will evaporate as the oven continues to heat up.

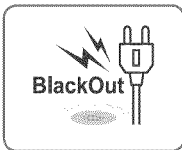

### In case of power failure, do not use the oven.

The oven and broiler can not be used during a power outage. If the oven is in use when a power failure occurs, the oven burner shuts off and cannot be re-lit until power is restored. Once power is restored, you will need to reset the oven (or broil function).

#### CAUTION

**DO NOT** attempt to operate the electric ignition during an electrical power failure.

#### NOTE

##### PF (Power Failure) Message

The PF message will appear if the appliance has a power interruption. To clear the PF message, press

**UPPER CLEAR/OFF** or **LOWER CLEAR/OFF** control key to reset the appliance. Be sure to also reset the clock with the correct time of day.



## Using the Control Panel

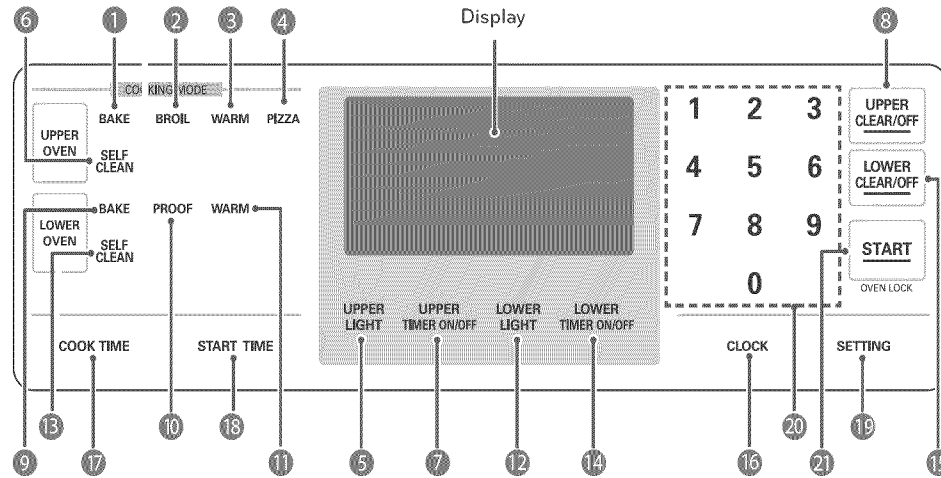

### Upper Oven:

| Name                 | Description   |
|----------------------|---|
| ① BAKE               | Traditional bake function. Refer to "BAKE" in the How To Use section.   |
| ② BROIL              | Traditional broil function. Refer to "BROIL" in the How To Use section.   |
| ③ WARM               | Warms food in the oven.<br>Refer to "WARM" in the How To Use section.   |
| ④ PIZZA              | Cooks pizza. Refer to "PIZZA" in the How To Use section.  |
| ⑤ UPPER LIGHT        | Turns on/off the upper oven light.  |
| ⑥ UPPER SELF CLEAN   | Cleans the inside of the UPPER OVEN automatically.<br>Refer to "SELF CLEAN" in the How To Use section.                                  |
| ⑦ UPPER TIMER ON/OFF | Sets, starts or cancels the timer function of the UPPER OVEN.<br>Refer to "How to use the timer" in the Operating Instructions section. |
| ⑧ UPPER CLEAR/OFF    | Stops cooking or cancels the setting in the UPPER OVEN.   |

## Using the Control Panel (continued)

### Lower Oven:

| Name                  | Description   |
|-----------------------|---|
| 9 BAKE                | Traditional bake function. Refer to "BAKE" in the Operating Instructions section.   |
| 10 PROOF              | To proof a piece of bread. Refer to "PROOF" in the Operating Instructions section.  |
| 11 WARM               | Warms food in the oven.<br>Refer to "WARM" in the Operating Instructions section.   |
| 12 LOWER LIGHT        | Turns on/off the lower oven light.  |
| 13 LOWER SELF CLEAN   | Cleans the inside of the LOWER OVEN automatically.  |
| 14 LOWER TIMER ON/OFF | Sets, starts or cancels the timer function of the LOWER OVEN.<br>Refer to "How to use the timer" in the Operating Instructions section. |
| 15 LOWER CLEAR/OFF    | Stops cooking or cancels the setting in the LOWER OVEN.   |

### Common Functions:

| Name                    | Description   |
|-------------------------|---|
| 16 CLOCK                | Sets the time of day.<br>Refer to "How to set the clock" in the Operating Instructions section.     |
| 17 COOK TIME            | Sets the length of cook time. It is automatically turned off if the desired cook time is reached.   |
| 18 START TIME           | Sets the desired cooking start time. The oven automatically starts cooking at the set time.         |
| 19 SETTING              | Sets various functions.   |
| 20 NUMBER KEY           | Use to set time, timer, temperature and all times.  |
| 21 START (CONTROL LOCK) | Starts all functions except for the timer. To activate OVEN LOCK, press and hold for three seconds. |

## Operating Instructions

The value of setting can be changed by pressing “**SETTING**” key.

The items are different from each model. Refer to “Setting item chart”

### SETTING ITEM CHART

| Operating Instruction            | LDG3011ST   |
|----------------------------------|-------------|
| Temperature Setting (Lower oven) | Once        |
| Temperature Setting (Upper oven) | Twice       |
| Preheating Alarm light On/off    | Three times |
| Beeper Volume                    | Four times  |
| Fahrenheit or Celsius            | Five times  |

### How to adjust the temperature settings:

You may find that your new oven cooks differently than the one it replaced. Use your new oven for a few weeks to become more familiar with it before changing the temperature settings. After familiarizing yourself with the new oven, and you still think that it is too hot or too cold, you can adjust the thermostat yourself.

#### CAUTION

DO NOT use thermometers, such as those found in grocery stores, to check the temperature setting of your oven. These thermometers may vary 20–40 degrees.

- Determine which oven you would like to adjust (upper or lower).
- For the lower oven, Press the **SETTING** key until **L-RJ** will appear in the display.  
For the upper oven, Press the **SETTING** key until **U-RJ** will appear in the display.
- Using the number keys, enter the amount of degrees that you wish to adjust the oven up or down. To adjust the temperature down, press the **SETTING** key after entering in the numbers. **Example:**  
  
To adjust the oven temperature **up** 15 degrees, press **1, 5**.  
  
To Adjust the oven temperature **down** 15 degrees, press **1, 5, SETTING**
- Press the **START** key to accept the change.

#### NOTE

- This adjustment will not affect the broiling or the Self Clean temperatures. The adjustment will be retained in memory after a power failure. The oven temperature can be increased (+) or decreased (-) as much as 35°F or 19°C.
- To decrease or increase temperature during cooking
  - Using the number keys, enter the new temperature.
  - Press the **SETTING** key once.
  - Press the **START** key to accept the choice.

### How to Set Preheating Alarm Light On/Off

When the oven reaches its set-temperature, the preheat light will flash until the oven door is opened. You can activate or deactivate the preheat alarm light.

- Press the **SETTING** key until **PrE** will display.
- Press the number **1** key to select **On / OFF**.
- Press the **START** key to accept the change.

### How to turn the interior oven light on/off:

The interior oven light automatically turns on when the oven door is opened.

Press the **UPPER LIGHT** or **LOWER LIGHT** key to turn the oven lights on or off.

### How to Adjust the Beeper Volume:

- Press the **SETTING** key until **BEEP** will display.
- Press the **1** key continuously to scroll through the volume options: **L o, H i, OFF**.
- Press the **START** key to accept the change.

## How to select Fahrenheit or Celsius

The oven temperature settings can either be set to Fahrenheit or Celsius. The oven defaults to Fahrenheit unless changed by the user.

- 1 Press the **SETTING** key until "F/C" will display.
- 2 Press the number **1** key to select Fahrenheit or Celsius.
- 3 Press the **START** key to accept the change.

## How to Set the Clock (12 or 24 hour):

- 1 Press and hold the **CLOCK** key for three seconds.
- 2 Press the **1** key once for a 24 hour clock. Press it again for a 12 hour clock.
- 3 Press the **START** key.

### NOTE

- The time of day cannot be changed during a timed baking or Self Clean cycle.
- To check the time of day when the display is showing other information, simply press the **CLOCK** key.
- If number keys are not pressed within 30 seconds after you press the **CLOCK** key, the display reverts to the original setting. If this happens, press the **CLOCK** key and reenter the time of day.
- If the display time is blinking, you may have experienced a power failure. Reset the time.

## How to Set the Clock Time:

The clock must be set to the correct time of day in order for the automatic oven timing functions to work properly.

- 1 Press the **CLOCK** key once.
- 2 Press the number keys to select the desired time.  
**Example** : To set 12:34, press the number keys **1, 2, 3** and **4** in that order.
- 3 Press the **START** key to accept the change.

## Minimum & Maximum default settings:

All of the features listed have minimum and maximum time or temperature settings that may be entered into the control. An entry acceptance beep will sound each time a control key is pressed.

An entry error tone (two short tones) will sound if the entry of the temperature or time is below the minimum or above the maximum settings for the feature.

| FEATURE       | MIN. TEMP. / TIME | MAX. TEMP. / TIME   | DEFAULT          |        |
|---------------|-------------------|---------------------|------------------|--------|
| CLOCK TIME    | 12 Hr.            | 1:00 Hr. / Min.     | 11:59 Hr. / Min. |        |
|               | 24 Hr.            | 0:00 Hr. / Min.     | 23:59 Hr. / Min. |        |
| KITCHEN TIMER | 12 Hr.            | 0:01 Min.           | 11:59 Hr. / Min. |        |
|               | 24 Hr.            | 0:01 Min.           | 11:59 Hr. / Min. |        |
| COOKING TIME  | 12 Hr.            | 0:01 Min.           | 11:59 Hr. / Min. |        |
|               | 24 Hr.            | 0:01 Min.           | 11:59 Hr. / Min. |        |
| BROIL TEMP.   | Lo-300°F / 149°C  | Hi - 400°F / 204°C  |                  | 3 Hr.  |
| BAKE TEMP.    | 170°F / 77°C      | 550°F / 288°C       |                  | 12 Hr. |
| PROOF         |                   |                     |                  | 12 Hr. |
| WARM          |                   | 170°F/75°C, 3 hours |                  | 3 Hr   |
| SELF CLEAN    | 2 Hr.             | 4 Hr.               |                  | 3 Hr.  |

## How to Use the Timer

The upper or lower TIMER ON/OFF serves as an extra timer in the kitchen that will sound when the set time has run out. It does not start or stop cooking.

The upper or lower TIMER ON/OFF feature can be used during any of the other oven control functions. The upper and lower TIMER can be operated independently of each other.

### 1 To set minutes and seconds:

Press the **UPPER** **TIMER ON/OFF** or **LOWER** **TIMER ON/OFF** key once.

### To set hours and minutes:

Press the **UPPER** **TIMER ON/OFF** or **LOWER** **TIMER ON/OFF** key twice.

### 2 Use the number keys to set the timer.

For Example, to set 5 minutes:

a) Press **UPPER** **TIMER ON/OFF** or **LOWER** **TIMER ON/OFF** key twice.  
000 will appear in the display.

b) Press **5** in the number key.  
005 will appear in the display.

### 3 To start the timer, press **UPPER** **TIMER ON/OFF** or **LOWER** **TIMER ON/OFF** key once. The time will count down and show in the display.

To Cancel the timer before the set time has elapsed, press **UPPER** **TIMER ON/OFF** or **LOWER** **TIMER ON/OFF** (depending on which oven timer you would like to cancel).

#### NOTE

If **UPPER** **TIMER ON/OFF** or **LOWER** **TIMER ON/OFF** is not pressed, the timer will return to the time of day.

### 4 When the time is up, **End** will appear on the display and a tone will sound. The tone will sound every 15 seconds until **UPPER** **TIMER ON/OFF** or **LOWER** **TIMER ON/OFF** is pressed.

#### NOTE

If the remaining time is not in the display, recall the remaining time by pressing the **UPPER** **TIMER ON/OFF** or **LOWER** **TIMER ON/OFF**.

## How to Use the Oven Lockout Feature

The oven lockout feature automatically locks the oven door and prevents most oven controls from being turned on. It does not disable the clock, timer or the interior oven light.

### 1 Press and hold the **START** key for three seconds.

A tone will sound, **Loc** will appear, and **⓪** will blink in the display. Once the oven door is locked, the oven lockout indicator will stop blinking and remain on.

### 2 To deactivate the lockout feature, press and hold the **START** key for three seconds.

**Loc** and **⓪** will disappear from the display once the oven door and controls are unlocked.

#### NOTE

If the lockout feature is activated with either of the doors open, the doors will not close completely until the Lockout feature is deactivated.

## Removing and Replacing the Oven Racks

### ⚠ CAUTION

- Replace the oven rack before turning the oven on to prevent burns.
- **DO NOT** cover the rack with aluminum foil, or any other material, or place anything on the bottom of the oven. Doing so will result in poor baking and may damage the oven bottom.
- Only arrange oven racks when the oven is cool.

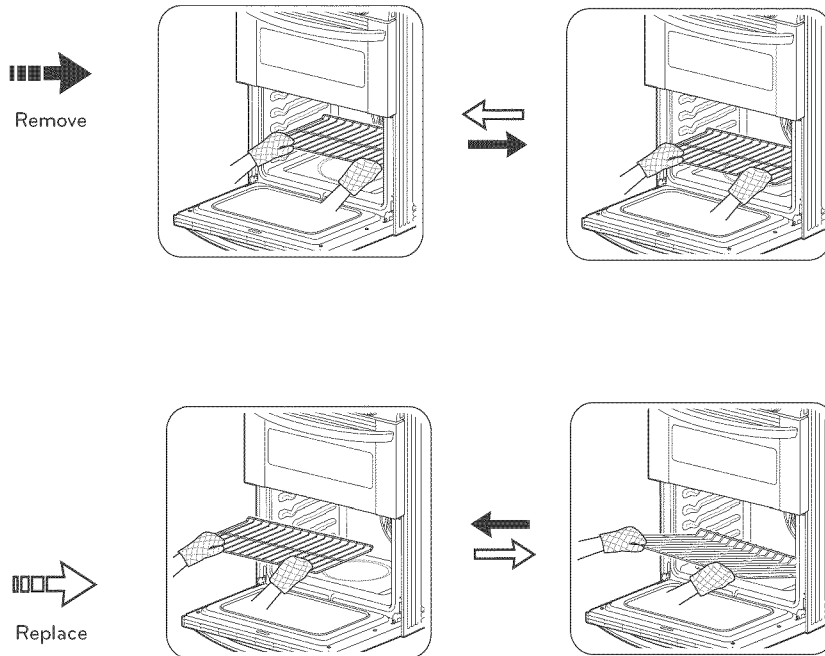

### To Remove Racks

- 1 While wearing oven mitts, grasp the oven rack.
- 2 Pull the rack straight out until it stops.
- 3 Lift up the front of the rack.
- 4 Pull out the rack.

### To Replace Racks

- 1 While wearing oven mitts, place the end of the rack on the support.
- 2 Tilt the front end of the rack up.
- 3 Push the rack in.
- 4 Check that the rack is properly in place.

\*You can also adjust the racks position before using the oven.

## BAKE (Upper & Lower Oven)

**BAKE** is used to prepare foods such as pastries, bread, casseroles and roasts. The oven can be programmed to bake at any temperature from 170°F (77°C) to 550°F (288°C). The default temperature is 350°F (177°C).

To set the oven to **BAKE** (example to 375°F):

- 1 Press the upper or lower oven **BAKE** key.
- 2 Set the oven temperature using the number keys (ex: press **3, 7, 5**).
- 3 Press the **START** key.

As the oven preheats, the temperature is displayed and rises in 5 degree increments. Once the oven reaches the desired temperature, a tone will sound and the oven light will blink on and off.

### NOTE

- Preheating is necessary for better cooking results. Place the food in the oven after preheating.
- You may also change the temperature while cooking by following steps 1-3.

- 4 When cooking is complete, press the **UPPER CLEAR/OFF** or **LOWER CLEAR/OFF** key.
- 5 Remove food from the oven.

BAKE mode display (Example)

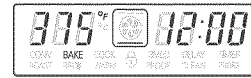

Upper oven only

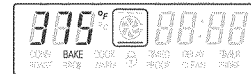
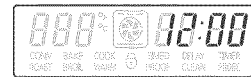

Lower oven only

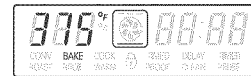
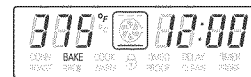

Upper & Lower oven at the same time

## Preheating and Pan Placement

- To preheat, set the oven at the required recipe temperature. Wait until the oven reaches its set temperature before placing the food in the oven. Preheating is necessary for satisfactory results when baking cakes, cookies, pastry and breads.
- For best baking results, pans should be centered on the racks. If baking with more than one pan, place the pans so that each one has at least 1" to 1 1/2" of air space around them.

If cooking on multiple racks in the lower oven, place the oven racks in position C(rack) and E(rack). Place the cookware as shown in Fig.1.

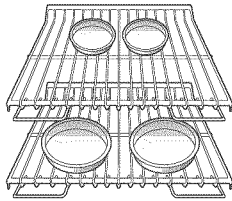

Figure 1

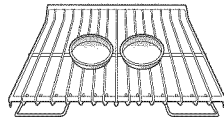
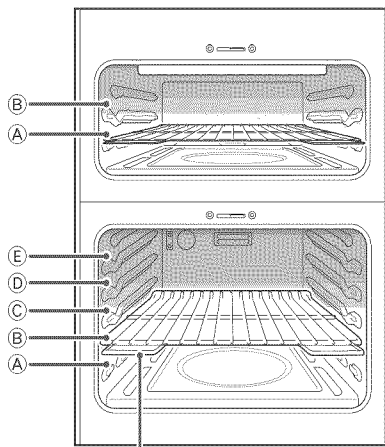

Figure 2



Rack

## Baking chart

This chart is only for reference and can be used for both the upper and lower ovens. Adjust the cook time according to your recipe.

| Food                         | Oven Temperature | Shelf position baking time |            | Baking time (Minutes) |
|------------------------------|------------------|----------------------------|------------|-----------------------|
|                              |                  | Upper oven                 | Lower oven |                       |
| <b>Cakes</b>                 |                  |                            |            |                       |
| - Layer cake                 | 350°F(177°C)     | A                          | C          | 32 - 35               |
| - Bundt cake                 | 350°F(177°C)     | A                          | C          | 37 - 43               |
| - Cup cakes                  | 350°F(177°C)     | A                          | C          | 20 - 30               |
| - Pound cake                 | 350°F(177°C)     | A                          | C          | 48 - 52               |
| - Carrot cake (from scratch) | 350°F(177°C)     | A                          | C          | 30 - 45               |
| <b>Cookies</b>               |                  |                            |            |                       |
| - Sugar                      | 350°F(177°C)     | A                          | C          | 12 - 20               |
| - Chocolate chip             | 350°F(177°C)     | A                          | C          | 9 - 16                |
| - Brownies                   | 350°F(177°C)     | A                          | C          | 30 - 35               |
| <b>Pizza</b>                 |                  |                            |            |                       |
| - Fresh                      | 425°F(218°C)     | A                          | C          | 10 - 15               |
| - Frozen                     | 400°F(204°C)     | A                          | C          | 23 - 27               |
| <b>Breads</b>                |                  |                            |            |                       |
| - Biscuits (canned)          | 350°F(177°C)     | A                          | C          | 13 - 17               |
| - Biscuits (scratch)         | 425°F(218°C)     | A                          | C          | 10 - 12               |
| - Muffins                    | 425°F(218°C)     | A                          | C          | 9 - 15                |
| <b>Fruits and Vegetables</b> |                  |                            |            |                       |
| - Apples (baked)             | 375°F(190°C)     | A                          | C          | 40 - 45               |
| - Potatoes (baked)           | 375°F(190°C)     | A                          | C          | 60 - 80               |



## BROIL (Upper Oven)

Your oven is designed for closed door broiling.

**BROIL** uses an intense heat radiation from the upper gas burner. The Broil function works best when broiling thin, tender cuts of meat (1" or less), poultry or fish.

### CAUTION

- **DO NOT** use a broiler pan without a grid. Oil can cause a grease fire.
- **DO NOT** cover the grid and broiler pan with aluminum foil. Doing so will cause a fire.

### NOTE

- Use a **Lo** broil to broil foods such as poultry and thick cuts of meat.
- Remove the pan from the oven to cool down for easy cleaning.
- For best results, use a pan designed for broiling, as shown below. The broiler pan will catch grease spills and the grid will help prevent grease splatters.

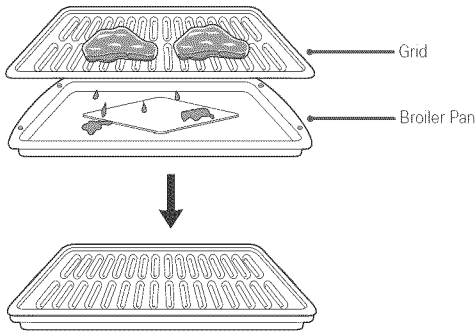

When broiling on rack position 'B' in the upper oven, use the offset rack provided for better cooking results.

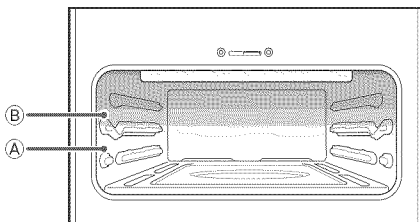

\*B: The position where you use the offset rack.

## To set the upper oven to BROIL

- 1 Press the **BROIL** key once for **Hi**, and twice for **Lo**.
- 2 Press the **START** key.
- 3 Allow the broiler to preheat for five minutes.
- 4 Place food in the upper oven.
- 5 Closed the oven door. The oven door must be closed during broiling.

### NOTE

If the oven door remains open for more than 15 seconds during broil, the burner will shut off. The broil burner will automatically come back on once the door is closed.

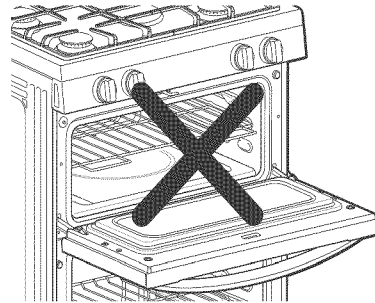

- 6 When broiling is finished, press the **UPPER CLEAR/OFF** key.

### NOTE

During any Broil function, it is normal for the broiler to cycle on and off.

## BROIL mode display (example)

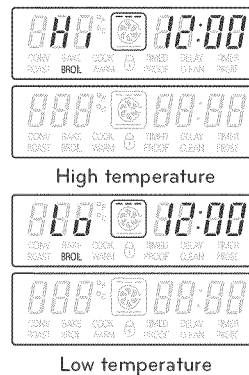

## BROILING CHART

| Food                             | Quantity and/or Thickness                        | Upper oven     |                      |                       | Comments   |
|----------------------------------|--|----------------|----------------------|-----------------------|--|
|                                  |  | Shelf Position | First side (Minutes) | Second side (Minutes) |  |
| <b>Ground beef</b><br>Well done  | 1 lb. (4 patties)<br>1/2 to 3/4" thick           | A              | 5-7                  | 3-5                   | Space evenly. Up to 8 patties may be broiled at once.  |
| <b>Beef Steaks</b>               |  |                |                      |                       | Steaks less than 1" thick cook through before browning. Pan frying is recommended. Slash fat   |
| Rare                             | 1" thick   | A              | 6-7                  | 2-3                   |  |
| Medium                           | 1 to 1 1/2 lbs.                                  | A              | 7-8                  | 3-4                   |  |
| Well Done                        |  | A              | 8-9                  | 4-5                   |  |
| Rare                             | 1 1/2" thick                                     | A              | 8                    | 3-4                   |  |
| Medium                           | 2 to 2 1/2 lbs.                                  | A              | 9                    | 4-5                   |  |
| Well Done                        |  | A              | 10                   | 5-6                   |  |
| <b>Chicken</b>                   | 1 whole cut up 2 to 2 1/2 lbs., split lengthwise | A              | 8-10                 | 5-7                   | Broil skin-side-down first.  |
|                                  | 2 breasts  | A              | 8-9                  | 5-6                   |  |
| <b>Fish Fillets</b>              | 1/4 to 1/2" thick                                | A              | 5                    | 2-4                   | Handle and turn very carefully. Brush with lemon butter before and during cooking, if desired. |
| <b>Ham Slices</b><br>(precooked) | 1/2" thick                                       | A              | 6-7                  | 2-3                   | Increase time 5 to 10 minutes pre side for 1 1/2" thick or home-cured ham.                     |
| <b>Pork chops</b>                | 1 (1/2" thick)                                   | A              | 4-6                  | 3-5                   | Slash fat.   |
| Well Done                        | 2 (1" thick) about 1lb.                          | A              | 7-9                  | 5-7                   |  |
| <b>Lamb Chops</b>                |  |                |                      |                       | Slash fat.   |
| Medium                           | 2 (1" thick) about 10 to 12 oz.                  | A              | 7-8                  | 2-3                   |  |
| Well Done                        |  | A              | 8-9                  | 3-4                   |  |
| Medium                           | 2 (1/2" thick) about 1lb.                        | A              | 6-7                  | 2-3                   |  |
| Well done                        |  | A              | 7-8                  | 3-4                   |  |
| <b>Salmon Steaks</b>             | 2 (1" thick)                                     | A              | 7-9                  | 3-5                   | Grease pan. Brush steaks with melted butter.   |
|                                  | 4 (1" thick) about 1lb.                          | A              | 8-10                 | 3-5                   |  |

This chart is only for reference. Adjust cook time according to your preference.

### NOTE

- Broiling times may be affected by the size, weight, thickness, starting temperature and your preference of doneness. This guide is based on meats at refrigerated temperatures.

### NOTE

- The U.S. Department of Agriculture says "Rare beef is popular, but you should know that cooking it to only 140 °F. means some food poisoning organisms may survive." (Source: Safe Food Book. Your Kitchen Guide. USDA Rev. June 1985.)

## TIMED COOK (Upper & Lower Oven)

The TIMED COOK feature allows you to set the oven to cook for a specific length of time. This feature can only be used while baking.

**To set TIMED COOK** (example: to BAKE at 300°F for 30 minutes):

- 1 Press the upper or lower **BAKE** key. **350°F** will appear in the display.
- 2 Use the number keys to set the temperature (ex. press **3, 0, 0**).
- 3 Once the oven has preheated to 300°, press the **COOK TIME** key. **300°F** will appear in the display.
- 4 Set the desired baking time (ex. press **3, 0**).  
The baking time can be set for any amount of time between 1 minute and 11 hours and 59 minutes.
- 5 Press the **START** key. The oven will turn on and the display will show the cooking time countdown.

### NOTE

- To set the WARM function to engage at the end of the timed cook cycle, repeat steps 1-5 and then press the **WARM** key. WARM will appear in the display. (Refer to "WARM" in the How to Use section for more information on warming.)
- To cancel the TIMED COOK function, press **UPPER CLEAR/OFF** or **LOWER CLEAR/OFF**.

The oven will continue to cook for the set amount of time and then turn off automatically. When the cooking time has elapsed:

- **End** and the time of day will show in the display.
- The cook end indicator tone will sound every 60 seconds until the **UPPER CLEAR/OFF** or **LOWER CLEAR/OFF** key is pressed.
- When WARM function is set, warm function is activated after cooking for the set time.

**To change the cook time while operating the oven:** (example: to change the cook time from 30 minutes to 1 hour 30 minutes):

- 1 Press the **COOK TIME** key.

### NOTE

If operating both the upper & lower oven at the same time, press the **COOK TIME** key once to set the cook time for the lower oven and twice for the upper oven.

- 2 Use the number keys to change the baking time (ex. press **1, 3, 0**).
- 3 Press **START** to accept the change.

## DELAYED TIMED COOK (Upper & Lower Oven)

The automatic timer of the DELAYED TIMED COOK will turn the oven ON and OFF at the time you select. This feature can only be used for baking.

**To set the oven for Delayed Start** (example: to BAKE at 300°F for 30 minutes and start operating the bake mode at 4:30pm):

- 1 Be sure that the clock is set for the correct time of day.
- 2 Arrange the interior oven rack(s) and place the food in the oven.
- 3 Press the **BAKE** key. **350°F** will appear on the display.
- 4 Use the number keys to set the oven temperature (ex. press **3, 0, 0**).
- 5 Press the **COOK TIME** key.
- 6 Set the desired baking time (ex. press **3, 0**).  
The baking time can be set for any amount of time from 1 minute to 11 hours and 59 minutes.
- 7 Press the **START TIME** key.
- 8 Set the desired start time (ex. press **4, 3, 0**).
- 9 Press the **START** key. At the set time, a short beep will sound and the oven will begin baking.

### NOTE

- To cancel the TIMED COOK function, press **UPPER CLEAR/OFF** or **LOWER CLEAR/OFF** key at any time.
- If you would like to change the cook time, repeat steps 5-6 and press **START**.

The oven will continue to cook for the set amount of time and then turn off automatically. When the cooking time has elapsed:

- **End** and the time of day will show in the display.
- The cook end indicator tone will sound every 60 seconds until the **UPPER CLEAR/OFF** or **LOWER CLEAR/OFF** key is pressed.
- When WARM function is set, warm function is activated after cooking for the set time.

### NOTE

If your oven clock is set as a 12 hour clock, you can delay the cook time for 12 hours. If your oven clock is set as a 24 hour clock, you can delay the cook time for 24 hours.

### CAUTION

- Use the automatic timer when cooking cured or frozen meats and most fruits and vegetables. Foods that can easily spoil, such as milk, eggs, fish, meat or poultry, should be chilled in the refrigerator. Even when chilled, they should not stand in the oven for more than 1 hour before cooking begins, and should be removed promptly when cooking is completed.
- Eating spoiled food can result in sickness from food poisoning.

## Special Features

### PIZZA (Upper Oven)

This function will automatically preheat the upper oven temperature to cook either regular or rising crust frozen pizza. Simply choose the type of crust (P1 for regular crust and P2 for rising crust) and set the desired cook time.

#### To set the oven for frozen pizza:

- 1 Press the **PIZZA** key once for regular crust and twice for rising crust. Either **P 1** (regular crust) or **P 2** (rising crust) will appear in the display.
- 2 Press the **START** key.
- 3 "PrE" will appear in the display to indicate preheat. Alarm will sound once preheat is complete.
- 4 Place pizza in the oven, close the door and then set the timer as per the chart below.
- 5 When cooking is complete press the **UPPER CLEAR/OFF** key.
- 6 Remove food from the oven.

#### Display Screen (example):

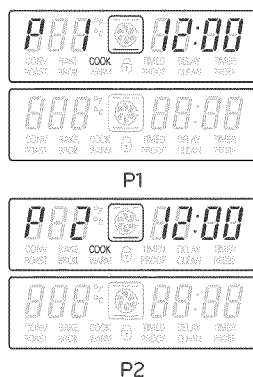

**NOTE**

- Preheating is necessary for better cooking results. Place the food in the oven after preheating.

#### PIZZA Chart

| Food                            | Recommended Size | Shelf Position | Recommended Time (minutes) |
|---------------------------------|------------------|----------------|----------------------------|
| Frozen Pizza with Regular Crust | 12"              | A              | 13-17                      |
| Frozen Pizza with Rising Crust  | 12"              | A              | 25-28                      |

This chart is for reference only. Adjust the cook time according to the recipe.

### WARM (Upper & Lower Oven)

This function will maintain an oven temperature of 170°F. The **WARM** function will keep cooked food warm for serving up to 3 hours after cooking has finished. The Warm function may be used without any other cooking operations or can be used after cooking has finished using **TIMED BAKE** or **DE-LAYED TIMED BAKE**.

**NOTE**

- The **WARM** function is intended to keep food warm. Do not use it to cool food down.
- When the lower oven is above 475°F, the **WARM** function of the upper oven cannot be used. **Hot** will appear on the display.

#### To set the WARM function:

- 1 Press the **WARM** key of the upper and/or lower oven
- 2 Press the **START** key.

#### Display Screen (example):

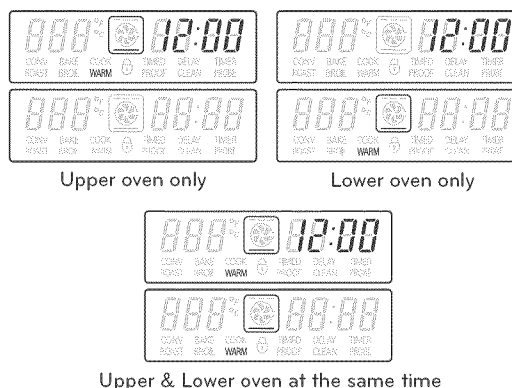

#### To set the warm function after Timed Cooking:

- 1 Set either **TIMED COOK** or **DELAyed TIMED COOK** (refer to "TIMED COOK" or "DELAyed TIMED COOK" in the How to Use section).
- 2 Press the **START** key.
- 3 Press the **WARM** key.  
The Warm mode is set to turn on automatically after completing the timed cooking or delayed cooking time.

**NOTE**

- To cancel the **WARM** function, press the **UPPER LOWER CLEAR/OFF** key at any time.
- If **UPPER CLEAR/OFF** or **LOWER CLEAR/OFF** is pressed prior to the delay functions, all cooking settings will be canceled.

## PROOF (Lower Oven)

This feature maintains a warm oven for rising yeast leavened products before baking.

### To set the PROOF function:

- 1 Use rack B or C for proofing.
- 2 Press the **PROOF** key.
- 3 Press the **START** key.

### Display Screen (example):

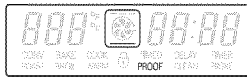
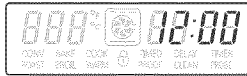

Lower oven only

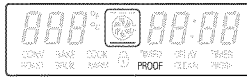
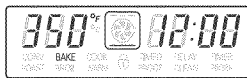

Upper & Lower oven at the same time

- 4 When proofing is finished, press the **LOWER CLEAR/OFF** key.

## NOTE

- To avoid lowering the oven temperature and lengthening proofing time, do not open the oven door unnecessarily. Check bread products early to avoid over-proofing.
- Do not use the proofing mode for warming food or keeping food hot. The proofing oven temperature is not hot enough to hold foods at safe temperatures. Use the WARM feature to keep food warm. Proofing will not operate when the oven is above 125°F. *Hot* will show in the display.

## SABBATH (Upper & Lower Oven)

The SABBATH mode is typically used on the Jewish Sabbath and Holidays. When the SABBATH mode is activated, the oven does not turn off until the SABBATH mode is deactivated. In SABBATH mode, all function keys, except for the **UPPER CLEAR/OFF** and **LOWER CLEAR/OFF** keys, are inactive. **5b** will appear in oven display.

### NOTE

- IF the oven light is turned ON and the SABBATH mode is active, the oven light will remain ON until the SABBATH mode is turned OFF. If the oven light needs to be OFF, be sure to turn the oven light OFF before activating the SABBATH mode.
- SABBATH mode can only be used while baking (BAKE mode) in either the top, bottom, or both ovens.
- You can use TIMED COOK in another oven while either the upper oven or lower oven is activated. Refer to "TIMED COOK" in the Using Oven section.

To set the SABBATH mode:

- 1 Press the **BAKE** key.
- 2 Using the number keys, enter the desired temperature.
- 3 Press the **START** key.
- 4 Press and hold the **SETTING** key for three seconds.

Display Screen (example):

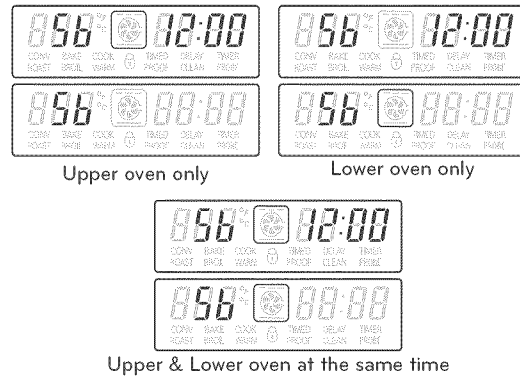

### NOTE

- To cancel the BAKE function, press the **UPPER CLEAR/OFF** or **LOWER CLEAR/OFF** key at any time.
- To cancel the SABBATH mode, press and hold the **SETTING** key for three seconds.

To change the temperature while in SABBATH mode (no tones sound & no display change):

- 1 Press the upper or lower oven **BAKE** key.
- 2 Using the number keys, set the desired temperature.
- 3 Press the **START** key.

### NOTE

- There is a 15 second delay before the unit will recognize the temperature change.

## CARE AND CLEANING

### Gas Surface Burner

#### ⚠ CAUTION

- **DO NOT** clean this appliance with bleach.
- To prevent burns, wait until the cooktop has cooled down before touching any of its parts.

### Removing and Replacing the Gas Surface Burner

Grates and burner caps/heads can be removed for care and cleaning.

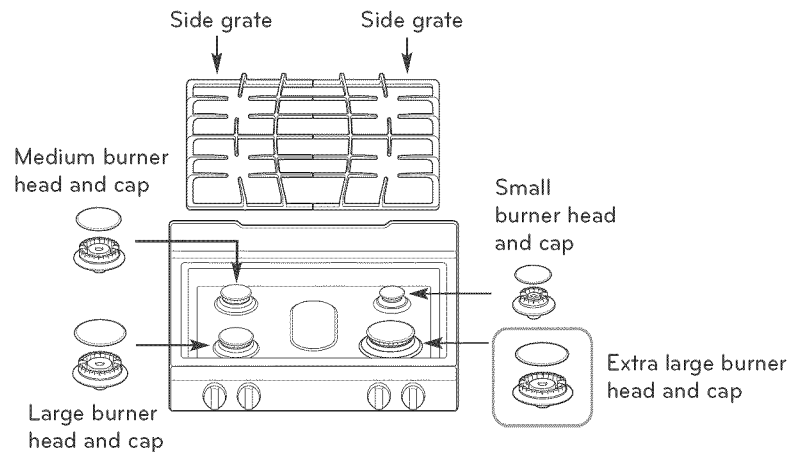

|                                 | General burner |
|---------------------------------|----------------|
| Burner cap is properly set.     |                |
| Burner cap is NOT properly set. |                |

### Burner Heads/Caps

For even and unhampered flame, the slits in the burner heads must be kept clean at all times. The burner heads and (the oval burner head) & Cap assembly can be lifted off.

- Wash the burner caps in hot soapy water and rinse with clean water.
- Any spills on or around an electrode must be carefully cleaned.
- To remove burnt-on food, soak the burner heads in a solution of mild liquid detergent and hot water for 20–30 minutes. For stubborn stains, use a toothbrush.
- The burners will not operate properly if the burner ports or electrodes are clogged or dirty.
- Burner caps and heads should be cleaned routinely, especially after bad spillovers.
- Burners will not light if the cap is removed.

### After Cleaning the Burner Heads/Caps

Shake out any excess water and then let them dry thoroughly. Replace the burner heads and caps over the electrodes on the cooktop, in the correct locations according to their size. Make sure the hole in the burner head is positioned over the electrode.

#### ⚠ CAUTION

- **DO NOT** hit the electrodes with anything hard. Doing so could damage them.
- **DO NOT** use steel wool or scouring powders to clean the burners.

## Burner Grates

The range consists of two separate professional-style grates. For maximum stability, these grates should only be used when in their proper position. The two side grates can be interchanged from left to right and front to back.

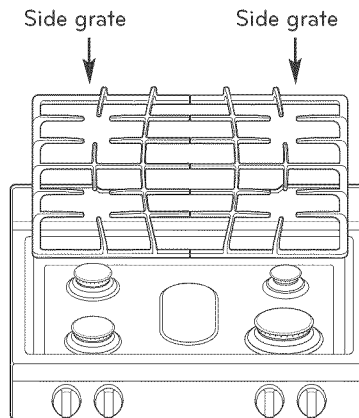

### NOTE

Do not operate a burner for an extended period of time without cookware on the grate. The finish on the grate may chip without cookware to absorb the heat.

### Cleaning the Burner Grates

- Do not lift the grates out until they have cooled.
- Grates should be washed regularly and after spillovers.
- Wash the grates in hot, soapy water and rinse with clean water.
- The grates are dishwasher safe.
- After cleaning the grates, let them dry completely and securely position them over the burners.

### CAUTION

**DO NOT** put the grate in the oven during self cleaning mode.



## Cooktop Surface

To avoid burns, do not clean the cooktop surface until it has cooled. Foods with high acid or sugar content could cause a dull spot if allowed to set. Wash and rinse when the surface has cooled. For other spills such as oil/grease spattering, etc., wash with soap and water when the surface has cooled. Then rinse and polish with a dry cloth.

### NOTE

Do not lift the cooktop surface. Lifting the cooktop surface can lead to damage and improper operation of the range.

## Stainless Steel Surfaces

To inquire about purchasing stainless steel appliance cleaner or polish, or to find the location of a dealer nearest you, please call our toll-free customer service number:

1-800-243-0000 or visit our website at: [us.lgservice.com](http://us.lgservice.com)

### NOTE

- Do not use a steel wool pad; it will scratch the surface.
- To clean the stainless steel surface, use warm sudsy water or a stainless steel cleaner or polish.
- Always wipe in the direction of the metal surface finish.

## Oven air vents

Air openings are located at the rear of the cooktop, at the top and bottom of the oven door, and at the bottom of the range.

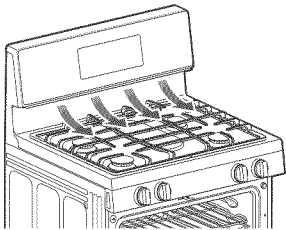

### NOTE

Do not block the vents and air openings of the range. They provide the air inlet and outlet that are necessary for the range to operate properly with correct combustion.

## Control Panel

To prevent activating the control panel during cleaning, unplug the range. Clean up splatters with a damp cloth using a glass cleaner. Remove heavier soil with warm, soapy water. Do not use abrasives of any kind.

## Front manifold panel and knobs

It is best to clean the manifold panel after each use of the oven. For cleaning, use a damp cloth and mild soapy water or a 50/50 solution of vinegar and water. For rinsing, use clean water and polish dry with a soft cloth.

### NOTE

- Do not use abrasive cleansers, strong liquid cleaners, plastic scouring pads or oven cleaners on the manifold panel. Doing so will damage the finish.
- Do not try to bend the knobs by pulling them up or down or by hanging a towel or other objects on them. This can damage the gas valve shaft.
- The control knobs may be removed for easy cleaning.
- To clean the knobs, make sure that they are in the "OFF" position and pull them straight off the stems.
- To replace the knobs, make sure the knob has the "OFF" position centered at the top, and slide the knob directly onto the stem.

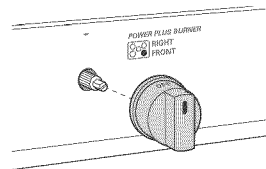

### NOTE

To prevent scratching, do not use abrasive cleaners on any of these materials.

## Oven Door

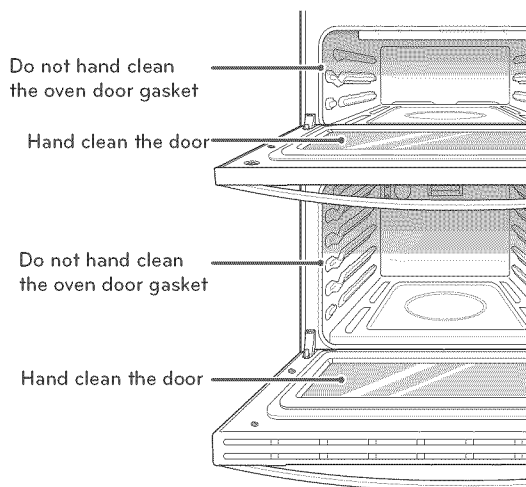

- Use soapy water to thoroughly clean the oven door. Rinse well. **DO NOT** immerse the door in water.
- You may use a glass cleaner on the outside glass of the oven door. **DO NOT** spray water or glass cleaner on the door vents.
- **DO NOT** use oven cleaners, cleaning powders, or harsh abrasive cleaning materials on the outside of the oven door.
- **DO NOT** clean the oven door gasket. The oven door gasket is made of a woven material that is essential for a good seal. Care should be taken not to rub, damage, or remove this gasket.

### NOTE

Do not use cleaners or harsh abrasive cleaning materials on the outside of the oven door. Doing so can cause damage.

## Removing and replacing the doors

Do not close the oven door until all of the oven racks are completely in place.

### CAUTION

- Be careful when removing and lifting the door.
- **DO NOT** lift the door by the handle.
- **DO NOT** hit the glass with pots, pans, or any other object.
- Scratching, hitting, jarring or stressing the glass may weaken its structure, causing an increased risk of breakage at a later time.

## Removing the Upper Oven Door

- 1 Fully open the door. Lift up the hinge locks toward the oven frame until they stop.

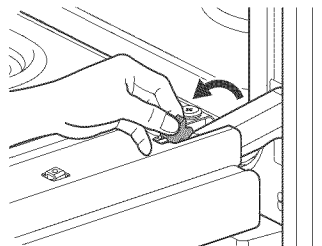

- 2 Close the door to approximately 30 degrees.

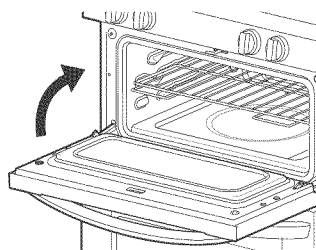

- 3 Press down the release buttons on each hinge on both sides of the door.

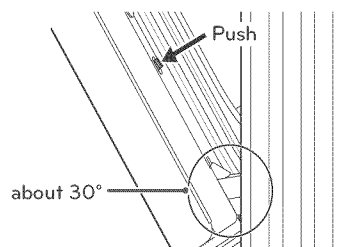

- 4 Lift up the door until it is clear off the hinge.

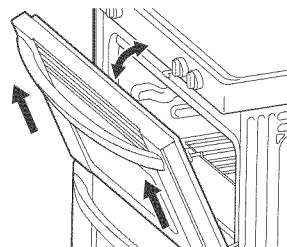

## Replacing the Upper Oven Door

- 1 Be sure that the hinges are lined up at a 30 degree position.

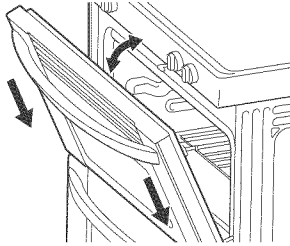

- 2 Slide the door back into the hinges until you hear a solid click and the release buttons have engaged.

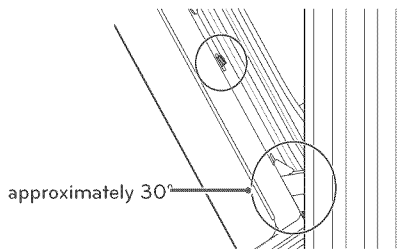

- 3 Fully open the door. Push the hinge locks down onto the hinge.

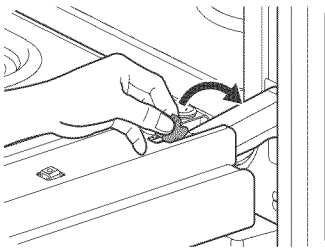

- 4 Close the oven door.

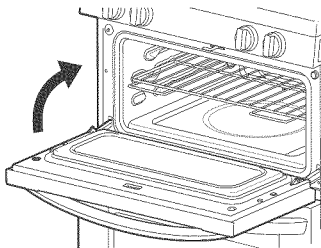

## Removing the Lower Oven Door

- 1 Fully open the door. Lift up the hinge locks toward the oven frame until they stop.

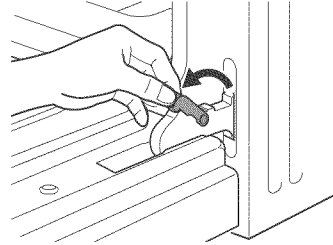

- 2 Close the door to the removal position (approximately five degrees).

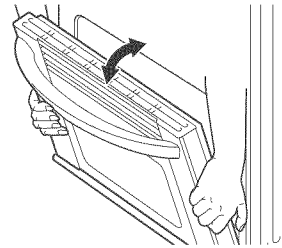

- 3 Lift the door up and out until the hinge arm is clear off of the slot. Put the door on the floor.

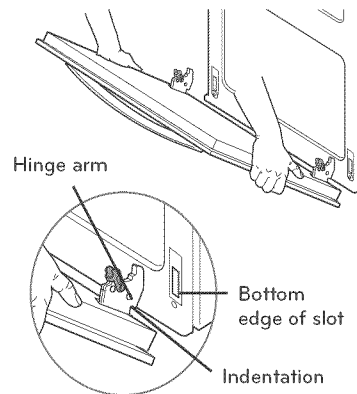

## Replacing the Lower Oven Door

- 1 Firmly grasp both sides of the door at the top and close the door to the removal position (approximately five degrees).

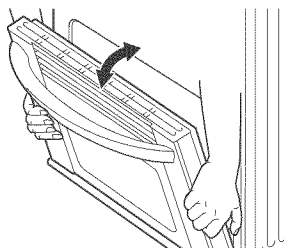

- 2 Seat the indentation of the hinge arm into the bottom edge of the hinge slot.

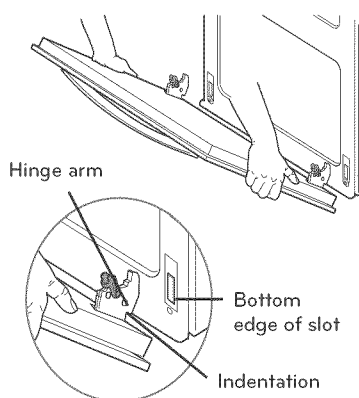

- 3 Open the door to its full extension. Push the hinge locks down against the front frame of the oven cavity to the locked position. Close the oven door.

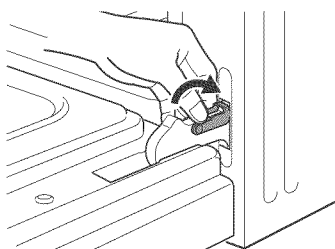

### NOTE

If the door will not fully open, the indentation is not seated correctly in the bottom edge of the slot.

## Inside of the Oven

### Cleaning Guide

| Soil Level                    | Cycle Setting             |
|-------------------------------|---------------------------|
| Lightly Soiled Oven Cavity    | 2 Hour Self Clean (p. 40) |
| Moderately Soiled Oven Cavity | 3 Hour Self Clean (p. 40) |
| Heavily Soiled Oven Cavity    | 4 Hour Self Clean (p. 40) |

### SELF CLEAN (Upper & Lower Oven)

The SELF CLEAN cycle uses above normal cooking temperatures to clean the oven cavity. You may see some smoke and smell an odor the first few times the oven is cleaned. This is normal and will lessen in time. Smoke may also occur if the oven is heavily soiled. During self clean, the kitchen should be well ventilated to minimize the odors from cleaning. The upper and lower oven SELF CLEAN cannot be operated simultaneously.

### CAUTION

- **DO NOT leave small children unattended near the appliance.** During the self cleaning cycle, the outside of the range can become very hot to the touch.
- **If you have a pet bird, move it to another well-ventilated room.** Some birds are extremely sensitive to the fumes given off during the self cleaning cycle of any range.
- **DO NOT wrap the oven walls, racks, bottom or any other part of the range with aluminum foil or any other material.** Doing so will destroy the heat distribution, produce poor baking results, and cause permanent damage to the interior of the oven (aluminum foil will melt to the interior surface of the oven).
- **DO NOT force the door open.** This can cause damage to the automatic door locking system. Use care when opening the oven door after the Self Cleaning cycle. Stand to the side of the oven when opening the door to allow hot air or steam to escape. The oven may still be very hot.
- **Do not touch the oven broil element until it has completely cooled.**

## Before Starting SELF CLEAN

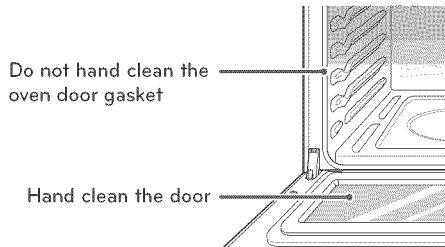

- Remove the oven racks, broiler pan, broiler grid, all cookware, aluminum foil or any other material from the oven.
- The kitchen should be well ventilated to minimize the odors from cleaning.
- If running a self clean in one of the ovens, the other oven can not be used.
- Wipe any heavy spillovers on the bottom of the oven.
- Make sure that the oven light bulb cover is in place and the oven light is off.
- The oven light cannot be turned on during a self clean cycle. The oven light cannot be turned on until the oven temperature has cooled below 500°F (260°C) after a self clean cycle is complete.
- Fine lines may appear in the porcelain because it went through heating and cooling. This is normal and will not affect performance.

### NOTE

- Clean the frame of the oven and door with hot soapy water. Rinse well.
- Do not clean the oven door gasket. The oven door gasket is made of a woven material that is essential for a good seal. Care should be taken not to rub, damage, or remove this gasket.
- Do not open the oven door until the self clean cycle is complete.
- The oven door can become extremely hot. Do not touch the oven door until it has cooled down.
- You may see some smoke and smell an odor the first few times the oven is cleaned. This is normal.
- As the oven heats, you may hear sounds of metal parts expanding and contracting. This is normal.
- A self clean cycle cannot be started if the Oven Lock-out feature is active.

## To Set Self Clean

- 1 Press the **SELF CLEAN** key.  
The oven defaults to the recommended three hour self clean for a moderately soiled oven. Press twice for a four hour self clean and three times for a two hour self clean.
- 2 Press the **START** key.

Once the self clean is set, the oven door will lock automatically and **L** will display. You will not be able to open the oven door until the oven is cooled. The lock will release automatically when the oven has cooled.

### CAUTION

**DO NOT** force the oven door open when **L** is displayed. The oven door will remain locked until the oven temperature has cooled. Forcing the door open will damage the door.

## To Set Self Clean with a Delayed Start

(example: set for 3:00 AM/PM)

- 1 Press the **SELF CLEAN** key.  
The oven defaults to the recommended three hour self clean for a moderately soiled oven. Press twice for a four hour self clean and three times for a two hour self clean.
- 2 Press the **START TIME** key.
- 3 Use the keypad to enter in the time of day that you would like the oven to start the Self Clean cycle (ex. **3, 0, 0**).

### NOTE

The Delayed Self Clean start time can only be set 11 hours and 59 minutes ahead. To set for 12- 24 hours in advance, see "How to change hour mode on clock."

- 4 Press the **START** key

Once the self clean is set, the oven door will lock automatically and **L** will display. You will not be able to open the oven door until the oven is cooled. The lock will release automatically when the oven has cooled.

### NOTE

It may become necessary to cancel or interrupt a self clean cycle due to excessive smoke or fire in the oven. To Cancel the Self Clean function, press the **UPPER CLEAR/OFF** or **LOWER CLEAR/OFF** key.

## After Self Clean

- You may notice some white ash in the oven. Wipe it off with a damp cloth after the oven cools.
- If the oven is not clean after one clean cycle, repeat the clean cycle.
- If the oven racks were left in the oven and do not slide smoothly after a clean cycle, wipe racks and rack supports with a small amount of vegetable oil to make them glide easier.

## Changing the Oven Light

The oven light is a standard 40-watt appliance bulb. It will turn on when the oven door is open. When the oven door is closed, press the **UPPER LIGHT** or **LOWER LIGHT** key to turn the light on or off.

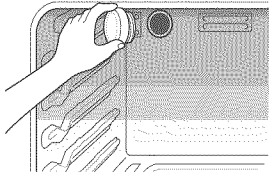

### To replace the oven light

- 1 Unplug the range or disconnect power.
- 2 Turn the glass bulb cover in the back of the oven counterclockwise to remove.
- 3 Turn the bulb counterclockwise to remove from socket.
- 4 Insert the new bulb and turn it clockwise.
- 5 Insert the glass bulb cover and turn it clockwise.
- 6 Plug in the range or reconnect the power.

#### **!** WARNING

- Make sure that the oven and bulb are cool.
- DISCONNECT the electrical power to the range at the main fuse or circuit breaker panel. Failure to do so can result in severe personal injury, death, or electrical shock.

## Broiler Pan and Grid (sold separately)

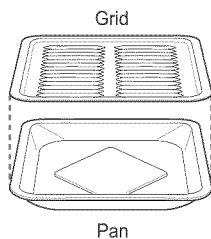

#### **!** NOTE

Remove the broiler pan and grid from the oven before operating the self clean cycle.

- 1 After broiling, remove the broiler pan from the oven. Remove the grid from the pan.
- 2 Carefully pour out the grease from the pan into a proper container.

- 3 Wash and rinse the broiler pan and grid in hot water with a soap-filled or plastic scouring pad. If food has burnt on, sprinkle the grid with cleaner (while hot) and cover it with wet paper towels or a dishcloth. Soaking the pan will remove burnt-on foods. Both the broiler pan and grid may be cleaned with a commercial oven cleaner. Both the broiler pan and grid can also be cleaned in a dishwasher.

## Oven racks

Remove the oven racks before operating the self clean cycle.

- 1 Food spilled into the tracks could cause the racks to become stuck. Clean with a mild, abrasive cleaner.
- 2 Rinse with clean water and dry.

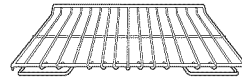

#### **!** NOTE

If the racks are cleaned using the self clean cycle (not recommended), the color will turn slightly blue and the finish will become dull. After the self clean cycle is complete, and the oven has cooled, rub the sides of the racks with wax paper or a cloth containing a small amount of oil. This will make the racks glide easier into the rack tracks.

## BEFORE REQUESTING SERVICE

| Symptoms and Questions                          | Possible Cause/Solution  |
|---|--|
| Top burners do not light or do not burn evenly. | <ul style="list-style-type: none"> <li>• Make sure that the electrical plug is inserted into a live, properly grounded outlet.</li> <li>• Remove the burners and clean them. Check the electrode area for burnt-on food or grease. See "Burner caps/burner head cleaning" in the Care and Cleaning section.</li> <li>• Make sure that the burner parts are installed correctly. See "Burner caps/heads cleaning" in the Care and Cleaning section.</li> </ul>  |
| Burner flames are very large or yellow.         | If the range is connected to LP gas, contact the technician who installed your range or made the conversion.   |
| Surface burners light but the oven does not.    | Make sure that the oven gas shut-off valve, located behind the range, is fully open.   |
| Food does not bake or roast properly.           | <ul style="list-style-type: none"> <li>• Incorrect oven control settings. See "Using control panel" in the How to Use section.</li> <li>• Incorrect rack position. See "Replace and remove Oven rack" or "Shelf position Baking time" in the How To Use section.</li> <li>• Incorrect cookware is being used. See "Roast" or "Bake" in the How To Use Section.</li> <li>• Oven thermostat needs adjustment. See "How to adjust the temperature" in the Operating Instructions section.</li> <li>• The Clock is not set correctly. See "How to set the clock and the timer" in the Operating Instructions section.</li> <li>• Aluminum foil used improperly in the oven. See "Using the oven."</li> </ul> |
| Food does not broil properly in the oven.       | <ul style="list-style-type: none"> <li>• Incorrect oven control settings. See "Using control panel" in the How to Use section.</li> <li>• The oven door is not closed. See "Using the oven" in the How to Use section.</li> <li>• Aluminum foil used on the broiling pan and grid is not fitted properly.</li> </ul>   |
| Oven temperature is too hot or too cold.        | The oven thermostat needs adjustment. See "How to adjust the temperature" in the Operating Instructions section.   |
| Clock and timer does not work.                  | <ul style="list-style-type: none"> <li>• Make sure the electrical plug is inserted into a live, properly grounded outlet. Replace the fuse or reset the circuit breaker.</li> <li>• Improper oven control settings. See "How to set the clock and the timer" in the Operating Instructions section.</li> </ul>   |
| Oven light does not work.                       | <ul style="list-style-type: none"> <li>• The light bulb is loose or defective. Tighten or replace the bulb.</li> <li>• The plug on the range is not completely inserted in the electrical outlet. Make sure the electrical plug is inserted into a live, properly grounded outlet.</li> </ul>  |
| Self clean is not working.                      | <ul style="list-style-type: none"> <li>• The oven temperature is too high to set a self clean operation. Allow the range to cool down to room temperature and reset the controls.</li> <li>• Improper oven control settings. See "SELF CLEAN" in the Care and Self Cleaning section.</li> </ul>  |
| "Crackling" or "popping" sound.                 | This is the sound of the metal heating up and cooling down during both the cooking and cleaning functions. This is normal.   |

| Symptoms and Questions   | Possible Cause/Solution   |
|--|---|
| Too much smoke during the self clean cycle.                                | Too much soil in the oven. Open the windows to get rid of the smoke from the room. Press the <b>UPPER CLEAR/OFF</b> or <b>LOWER CLEAR/OFF</b> key. Wait until the <b>⓪</b> light goes off before trying to open the oven door. Wipe up the excess soil and reset the clean cycle.   |
| The oven door does not open after a self clean cycle.                      | The oven temperature is too high. Wait up to one hour to cool down.   |
| The oven door is not clean after a self clean cycle.                       | <ul style="list-style-type: none"> <li>• Incorrect oven control settings. See "SELF CLEAN" in the Care and Cleaning section.</li> <li>• The oven was heavily soiled. Clean up heavy spills before beginning the self clean cycle. Heavily soiled ovens may need either a longer self clean or two self clean cycles.</li> </ul>   |
| "CLOSE DOOR TO CONTINUE BROILING" or "DOOR OPENED" appears in the display. | Close the oven door.  |
| "DOOR LOCKED" message appears when you want to cook.                       | The oven door is locked because the temperature inside of the oven is too high. Press the <b>UPPER CLEAR/OFF</b> or <b>LOWER CLEAR/OFF</b> key.   |
| Oven control beeps and displays an F error code.                           | <ul style="list-style-type: none"> <li>• Press the <b>UPPER CLEAR/OFF</b> or <b>LOWER CLEAR/OFF</b> key and wait for one hour.</li> <li>• Check the main gas shut-off valve or the oven gas shut-off valve and call for service.</li> <li>• Remove the power from the range for five minutes and then reconnect the power. If the function error code repeats, call for service.</li> </ul> |
| The oven racks were cleaned in a self clean cycle.                         | Apply a small amount of vegetable oil to a paper towel and wipe the edges of the oven racks. Do not use lubricant sprays.   |
| Clock is flashing.   | Power outage or surge. Reset the clock. If the oven was in use, you must reset it by pressing the <b>UPPER CLEAR/OFF</b> or <b>LOWER CLEAR/OFF</b> key. Reset the clock and any cooking function.   |
| "Burning" or "oily" odor emitting from the vent.                           | This is normal in a new oven. To speed the process, set a self clean cycle for a minimum of three hours. See "SELF CLEAN" in the Care and Cleaning section.   |
| Strong odor.   | An odor from the insulation around the inside of the oven is normal for the first few times the oven is used.   |
| Fan noise (convection models)  | The convection fan may turn on and off automatically. This is normal.   |
| Convection fan not working (convection models).                            | The preheating temperature has not been reached. The Fan will start automatically once the preheating temperature is reached.   |
| Burners are not lighting properly after cleaning the cooktop surface.      | Make sure that the burner heads and caps are completely dry and properly positioned.  |



LG Electronics Inc. will repair or replace your product, at LG's option, if it proves to be defective in material or workmanship under normal use, during the warranty period set forth below, effective from the date of original consumer purchase of the product. This limited warranty is good only to the original purchaser of the product and effective only when used in U.S.A.

| WARRANTY PERIOD  | HOW SERVICE IS HANDLED  |
|--|---|
| <b>One Year</b><br>From the date of the original purchase. | <b>Any part</b> of the oven that fails due to a defect in materials or workmanship. During this <b>full one-year warranty</b> , LG will also provide, <b>free of charge</b> , all labour and in-home service to replace the defective part. |

THIS WARRANTY IS IN LIEU OF ANY OTHER WARRANTIES, EXPRESS OR IMPLIED, INCLUDING WITHOUT LIMITATION, ANY WARRANTY OF MERCHANTABILITY OR FITNESS FOR A PARTICULAR PURPOSE. TO THE EXTENT ANY IMPLIED WARRANTY IS REQUIRED BY LAW, IT IS LIMITED IN DURATION TO THE EXPRESS WARRANTY PERIOD ABOVE. LG WILL NOT BE LIABLE FOR ANY CONSEQUENTIAL, INDIRECT, OR INCIDENTAL DAMAGES OF ANY KIND, INCLUDING LOST REVENUES OR PROFITS, IN CONNECTION WITH THE PRODUCT. SOME STATES DO NOT ALLOW LIMITATION ON HOW LONG AN IMPLIED WARRANTY LASTS OR THE EXCLUSION OF INCIDENTAL OR CONSEQUENTIAL DAMAGES, SO THE ABOVE LIMITATIONS OR EXCLUSIONS MAY NOT APPLY TO YOU.

**THIS LIMITED WARRANTY DOES NOT APPLY TO:**

1. Service calls to correct the installation of your appliance, to instruct you how to use your appliance, to replace house fuses or correct house wiring, or to replace owner-accessible light bulbs.
2. Repairs when your appliance is used in other than normal, single-family household use.
3. Pickup and delivery. Your appliance is designed to be repairable in the home.
4. Damage resulting from accident, alteration, misuse, abuse, fire, flood, improper installation, acts of God, or use of products not approved by LG Corporation.
5. Repairs to parts or systems resulting from unauthorized modifications made to the appliance.
6. Replacement parts or repair labour costs for units operated outside the united states.
7. Any labour costs during the limited warranty period.

This warranty is extended to the original purchaser for products purchased for home use within the U.S.A. In Alaska, the warranty excludes the cost of shipping or service calls to your home.

Some states do not allow the exclusion or limitation of incidental or consequential damages, so this exclusion or limitation may not apply to you. This warranty gives you specific legal rights, and you may also have other rights which vary from state to state. To know what your legal rights are, consult your local or state consumer affairs or your state's Attorney General.

**CUSTOMER ASSISTANCE INFORMATION:**

|  |  |
|--|--|
| To Prove Warranty Coverage   | <b>Retain your Sales Receipt to prove date of purchase.</b><br>A copy of your Sales Receipt must be submitted at the time warranty service is provided.  |
| To Obtain the Nearest Authorized Service Center or Sales Dealer, or to Obtain Product, Customer, or Service Assistance | <b>Call 1-800-243-0000</b> (Phone answered 24 hours - 365 days a year) and choose the appropriate prompt from the menu; or visit our website at: <a href="http://us.lgservice.com">http://us.lgservice.com</a> . |

MEMO



**LG Customer Information Center**

1-800-243-0000 USA, Consumer User  
1-888-865-3026 USA, Commercial User  
1-888-542-2623 CANADA

**Register your product Online!**

[www.lg.com](http://www.lg.com)



Printed on 100% Recycled Paper

Printed in Mexico