

Operator's Manual

**CRAFTSMAN®**

**NEXTEC**

**HAMMERHEAD™**

**12.0-VOLT  
LITHIUM-ION CORDLESS  
ARTICULATING AUTO-HAMMER**

Model No. 320.30261

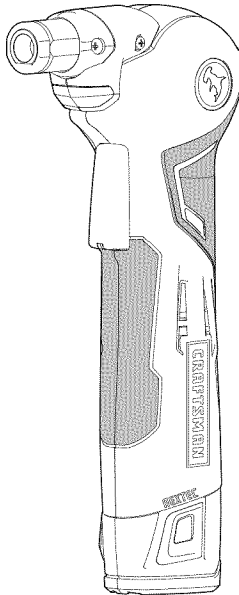

- WARRANTY
- SAFETY
- ASSEMBLY
- DESCRIPTION
- OPERATION
- MAINTENANCE
- ESPAÑOL

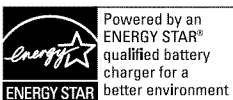

**⚠ WARNING:** To reduce the risk of injury, the user must read and understand the operator's manual before using this product.

Sears Brands Management Corporation Hoffman Estates, IL 60179 U.S.A.

[www.craftsman.com](http://www.craftsman.com)

## TABLE OF CONTENTS

Warranty	page 2
Safety Symbols	page 3-4
Safety Instructions	page 5-8
Unpacking	page 9
Description	page 10-11
Operation	page 12-15
Maintenance	page 16-17
Troubleshooting	page 17
Exploded View and Part List	page 18
Sears Repair Parts Phone Number	Back Cover

### **CRAFTSMAN ONE YEAR LIMITED WARRANTY**

FOR ONE YEAR from the date of purchase, this product is warranted against any defects in material or workmanship. With proof of purchase, defective product will be replaced free of charge.

**For warranty coverage details to obtain free replacement, visit the web site: [www.craftsman.com](http://www.craftsman.com)**

This warranty does not cover the pry bar, which is an expendable part that can wear out from normal use within the warranty period.

This warranty is void if this product is ever used while providing commercial services or if rented to another person.

This warranty gives you specific legal rights, and you may also have other rights which vary from state to state.

Sears Brands Management Corporation, Hoffman Estates, IL 60179

**⚠ WARNING:** Some dust created by using power tools contains chemicals known to the state of California to cause cancer and birth defects or other reproductive harm.

### **SAVE THESE INSTRUCTIONS! READ ALL INSTRUCTIONS!**

This cordless auto-hammer has many features for making its use more pleasant and enjoyable. Safety, performance, and dependability have been given top priority in the design of this product, making it easy to maintain and operate.

## SAFETY ALERT SYMBOLS

The purpose of safety symbols is to attract your attention to possible dangers.

The safety symbols and the explanations with them deserve your careful attention and understanding. The symbol warnings do not, by themselves, eliminate any danger. The instructions and warnings they give are no substitutes for proper accident prevention measures.

**⚠ WARNING:** Be sure to read and understand all safety instructions in this manual, including all safety alert symbols such as “**DANGER**,” “**WARNING**,” and “**CAUTION**,” before using this auto-hammer. Failure to follow all instructions listed in this manual may result in electric shock, fire and/or serious personal injury.

### SYMBOL MEANNING

**⚠ DANGER:** Indicates a hazardous situation which, if not avoided, will result in death or serious injury.

**⚠ WARNING:** Indicates a hazardous situation which, if not avoided, could result in death or serious injury.

**⚠ CAUTION:** Indicates a hazardous situation which, if not avoided, could result in minor or moderate injury.

### Damage Prevention and Information Messages

These inform the user of important information and/or instructions that could lead to equipment or other property damage if they are not followed. Each message is preceded by the word “NOTICE,” as in the example below:

**NOTICE:** Equipment and/or property damage may result if these instructions are not followed.









**⚠ WARNING:** To ensure safety and reliability, all repairs should be performed at a Sears Parts & Repair Service Center.

**⚠ WARNING:** The operation of any power tools can result in foreign objects being thrown into your eyes, which can result in severe eye damage. Before beginning power tool operation, always wear safety goggles or safety glasses with side shield and a full face shield when needed. We recommend a Wide Vision Safety Mask for use over eyeglasses or standard safety glasses with side shields. Always use eye protection which is marked to comply with ANSI Z87.1



## SAVE THESE INSTRUCTIONS

Some of the following symbols may be used on this tool. Please study them and learn their meaning. Proper interpretation of these symbols will allow you to operate the tool better and more safely.

SYMBOL	NAME	DESIGNATION/EXPLANATION
V	Volts	Voltage
A	Amperes	Current
Hz	Hertz	Frequency (cycles per second)
W	Watt	Power
min	Minutes	Time
~	Alternating Current	Type of current
≡	Direct Current	Type or a characteristic of current
$n_0$	No Load Speed	Rotational speed, at no load
	Class II Construction	Double-insulated construction
.../min	Per Minute	Revolutions, strokes, surface speed, orbits, etc., per minute
	Wet Conditions Alert	Do not expose to rain or use in damp locations.
	Read The Operator's Manual	To reduce the risk of injury, user must read and understand operator's manual before using this product.
	Eye Protection	Always wear safety goggles or safety glasses with side shields and a full face shield when operating this product.
	Safety Alert	Precautions that involve your safety.
	No Hands Symbol	Failure to keep your hands away from the blade will result in serious personal injury.
	No Hands Symbol	Failure to keep your hands away from the blade will result in serious personal injury.
	No Hands Symbol	Failure to keep your hands away from the blade will result in serious personal injury.
	No Hands Symbol	Failure to keep your hands away from the blade will result in serious personal injury.
	Hot Surface	To reduce the risk of injury or damage, avoid contact with any hot surface.

# SAFETY INSTRUCTIONS

## GENERAL POWER TOOL SAFETY WARNINGS

**▲ WARNING: Read all safety warnings and instructions.** Failure to follow the warnings and instructions may result in electric shock, fire and/or serious injury.

**Save all warnings and instructions for future reference.**

The term “power tool” in the warnings refers to your mains-operated (corded) power tool or battery-operated (cordless) power tool.

## READ AND SAVE THESE INSTRUCTIONS

- **Know your Auto-Hammer. Read the operator’s manual carefully. Learn the tool’s applications and limitations, as well as the specific potential hazards related to this Auto-Hammer.** Following this rule will reduce the risk of electric shock, fire or serious injury.
- **Use only the recommended battery pack and charger.** Any attempt to use another battery pack will cause damage to the auto-hammer, which could then possibly explode, or cause a fire or personal injury.
- **Use only the battery and chargers listed below.**

BATTERY PACK	CHARGER
320.11221	320.10006
	320.29497
	320.14300

- **Remove the battery pack from the Auto-Hammer before performing any routine maintenance or cleaning**
- **Do not disassemble the Auto-Hammer.**
- **Do not place the Auto-Hammer or battery pack near fire or heat.** They may explode. Do not incinerate the battery, even if it is severely damaged or completely worn out. The battery may explode in fire.
- **Do not operate the Auto-Hammer or charger near flammable liquids or in a gaseous or explosive environment.** Internal sparks may ignite fumes.
- **To reduce the risk of electric shock, do not put the Auto-Hammer, battery, or charger in water or other liquid.** Do not place or store the product where it can fall or be pulled into a tub or sink.
- **Do not store the Auto-Hammer in a damp or wet location. Do not store it in locations where the temperature is less than 32°F (0°C) or more than 104°F (40°C).** Do not store it outside or in vehicles.
- **Do not permit children to use the Auto-Hammer unsupervised.** It is not a toy.
- **The auto-hammer may become hot after being used for a period of time.** This increased temperature can cause a burn injury if touched.

- **Keep the Auto-Hammer dry, clean, and free from oil and grease.** Always use a clean cloth when cleaning. Never use brake fluids, gasoline, petroleum-based products or any strong solvent to clean the hammer.
- **Do not expose the Auto-Hammer to rain or wet conditions.** Water entering the tool will increase the risk of electric shock.
- **Do not overreach. Keep proper footing and balance at all times.** This enables better control of the auto-hammer in unexpected situations. Do not use on a ladder or unstable support.

## WORK AREA SAFETY

- **Keep the work area clean and well lit.** Cluttered or dark areas invite accidents.
- **Do not operate power tools in explosive atmospheres, such as in the presence of flammable liquids, gases or dust.** Power tools create sparks which may ignite the dust or fumes.
- **Keep children and bystanders away while operating a power tool.** Distractions can cause you to lose control.

## ELECTRICAL SAFETY

- **Power tool plugs must match the outlet. Never modify the plug in any way. Do not use any adapter plugs with earthed (grounded) power tools.** Unmodified plugs and matching outlets will reduce risk of electric shock.
- **Avoid body contact with earthed or grounded surfaces such as pipes, radiators, ranges and refrigerators.** There is an increased risk of electric shock if your body is earthed or grounded.
- **Do not expose power tools to rain or wet conditions.** Water entering a power tool will increase the risk of electric shock.
- **Do not abuse the cord. Never use the cord for carrying, pulling or unplugging the power tool. Keep the cord away from heat, oil, sharp edges or moving parts.** Damaged or entangled cords increase the risk of electric shock.
- **When operating a power tool outdoors, use an extension cord suitable for outdoor use.** Use of a cord suitable for outdoor use reduces the risk of electric shock.
- **If operating a power tool in a damp location is unavoidable, use a ground fault circuit interrupter (GFCI) protected supply.** Use of a GFCI reduces the risk of electric shock.

## PERSONAL SAFETY

- **Stay alert, watch what you are doing and use common sense when operating a power tool. Do not use the tool while tired or under the influence of drugs, alcohol, or medication.** A moment of inattention while operating power tools may result in serious personal injury.

- **Use personal protective equipment. Always wear eye protection.** Protective equipment such as dust mask, non-skid safety shoes, hard hat, or hearing protection, used for appropriate conditions, will reduce personal injuries.
- **Prevent unintentional starting. Ensure that the switch is in the off-position before connecting to a power source and/or battery pack, picking up or carrying the tool.** Carrying power tools with your finger on the switch or energizing power tools that have the switch on invites accidents.
- **Remove any adjusting key or wrench before turning the power tool on.** A wrench or a key left attached to a rotating part of the power tool may result in personal injury.
- **Do not overreach. Keep proper footing and balance at all times.** This enables better control of the power tool in unexpected situations.
- **Dress properly. Do not wear loose clothing or jewelry. Keep your hair, clothing and gloves away from moving parts.** Loose clothes, jewelry or long hair can be caught in moving parts.
- **If devices are provided for the connection of dust extraction and collection facilities, ensure that these are connected and properly used.** Use of these devices can reduce dust-related hazards.

## POWER TOOL USE AND CARE

- **Do not force the power tool. Use the correct power tool for your application.** The correct power tool will do the job better and more safely at the rate for which it was designed.
- **Do not use the power tool if the switch does not turn it on and off.** Any power tool that cannot be controlled with the switch is dangerous and must be repaired.
- **Disconnect the plug from the power source and/or the battery pack from the power tool before marking any adjustments, changing accessories, or storing power tools.** Such preventive safety measures reduce the risk of starting the power tool accidentally.
- **Store idle power tools out of the reach of children and do not allow persons unfamiliar with the power tool or these instructions to operate the power tool.** Power tools are dangerous in the hands of untrained users.
- **Maintain power tools. Check for misalignment or binding of moving parts, breakage of parts and any other condition that may affect the power tool's operation. If damaged, have the power tool repaired before use.** Many accidents are caused by poorly maintained power tools.
- **Keep cutting tools sharp and clean.** Properly maintained cutting tools with sharp cutting edges are less likely to bind and are easier to control.
- **Use the power tool, accessories, tool bits, etc. in accordance with these instructions, taking into account the working conditions and the work to be performed.** Use of the power tool for operations different from those intended could result in a hazardous situation.

## BATTERY TOOL USE AND CARE

- **Recharge only with the charger specified by the manufacturer.** A charger that is suitable for one type of battery pack may create a risk of fire when used with another battery pack.
- **Use power tools only with specifically designated battery packs.** Use of any other battery packs may create a risk of injury and fire.
- **When the battery pack is not in use, keep it away from other metal objects, such as paper clips, coins, keys, nails, screws or other small metal objects that can make a connection from one terminal to another.** Shorting the battery terminals together may cause burns or a fire.
- **Under abusive conditions, liquid may be ejected from the battery; avoid contact. If contact accidentally occurs, flush with water. If liquid contacts eyes, additionally seek medical help.** Liquid ejected from the battery may cause irritation or burns.

## SERVICE

- **Have your power tool serviced by a qualified repair person using only identical replacement parts.** This will ensure that the safety of the power tool is maintained.
- **When servicing a power tool, use only identical replacement parts.**
- **Follow instructions in the Maintenance section of this manual.** Use of unauthorized parts or failure to follow Maintenance instructions may create a risk of shock or injury.

## SPECIFIC SAFETY RULES FOR CORDLESS AUTO-HAMMER

- **Hold power tools by the insulated gripping surfaces when performing an operation where the tool may contact hidden wiring or its own cord.** Contact with a “live” wire will also make exposed metal parts of the tool “live” and shock the operator.
- **Do not insert or try to insert your finger into the hammer sleeve at any time,** failure to do so could result in personal injury. Your finger may get hurt.
- **Do not stare into the LED worklight directly;** never project the worklight to others’ eyes.
- **Never put your hand continuously on the nail when hammering.** Only use your hand to hold the nail on the workpiece at the beginning of hammering.
- **This auto-hammer is to be used for the nails with nail head diameter less than 7/16 inch and length less than 3-1/2 inches.**
- **Use clamps or another practical way to secure and support the workpiece to a stable platform before hammering.** Holding the work by hand against your body leaves it unstable and may lead to loss of control.



**WARNING:** Wear ear protection. Exposure to noise can cause hearing loss.



**WARNING!** To reduce the risk of injury, user must read instruction manual.



## UNPACKING

**⚠ WARNING:** Always remove the battery from the auto-hammer before assembling parts, making adjustments, installing or removing bits, cleaning, or when it is not in use. This will prevent accidental starting, which could cause serious personal injury.

When unpacking the box, do not discard any packing materials until all of the contents are accounted for:

1. Carefully lift the auto-hammer out of the carton and place it on a stable, flat surface.
2. Open the carton to locate the following:
  - Pry bar
  - Battery pack
  - Charger
  - Manual
3. Inspect the items carefully to make sure that no breakage or damage has occurred during shipping. If any of the items mentioned is missing, return the auto-hammer to your nearest Sears store to have the auto-hammer replaced.

**⚠ WARNING:** If any part is broken or missing, do not attempt to assemble the hammer, attach the battery pack, or operate the hammer until the broken or missing part is replaced. Failure to do so could result in possible serious injury.

## DESCRIPTION

### KNOW YOUR AUTO-HAMMER (Fig. 1)

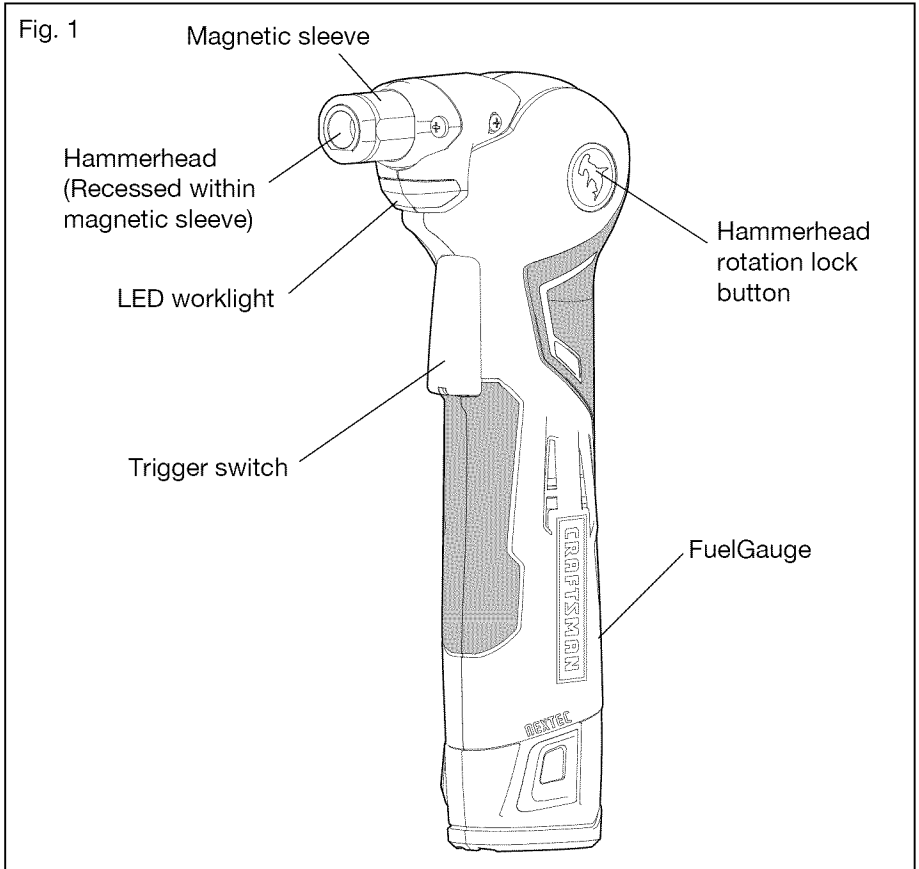

### PRODUCT SEPCIFICATIONS

Motor	12.0 Volt DC
Clamp	7/16 inch
Hammerhead adjustment angles	0°, 45°and 90°
Hammer Weight (without battery)	1.1 lbs
Battery Type	Lithium-Ion
Battery Voltage	12.0 Volt DC
Charger Input	120-Volts, 60 Hz AC only
Optimum Charging Temperature	32°F (0° C) -104°F (40°C)

**⚠ WARNING:** The safe use of this product requires an understanding of the information on the tool and in this operator's manual as well as knowledge of the project you are attempting. Before using this product, familiarize yourself with all operating features and safety rules.

## HAMMERHEAD

The hammerhead impacts the nails automatically when the tool is turned on and the impact mechanism is pressed onto a nail.

## HAMMERHEAD ARTICULATION ADJUSTMENT

The hammerhead lock button allows you to set the head at 0°, 45° and 90°.

## MAGNETIC SLEEVE (Fig. 2)

The magnetic sleeve holds the head of the inserted nail against the recessed hammerhead for the beginning of nail driving. The sleeve retracts at the end of nail driving to allow the hammerhead to drive the nail head flush to the workpiece.

## LED WORKLIGHT

The LED worklight, located on the front of the hammer, illuminates when the trigger switch is depressed. This feature provides extra light for increased visibility.

## FUELGAUGE

The FuelGauge indicates the battery-pack charge level.

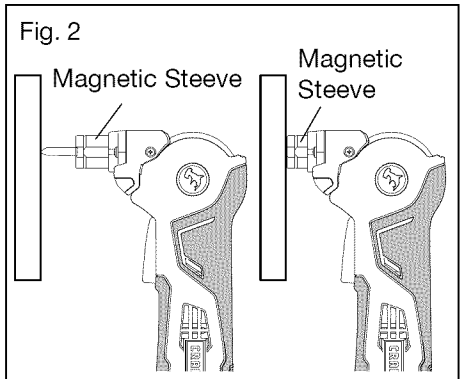

## OPERATION

### LOW BATTERY CAPACITY INDICATOR

- If the FuelGauge shines red when the trigger switch on the auto-hammer is depressed it means that the battery pack power has run out and the battery pack should be recharged.
- Unlike other battery-pack types, Lithium-Ion battery packs deliver fade-free power for their entire run time. The tool will not experience a slow, gradual loss of power as you work. To signal that the battery pack is at the end of its run time and needs to be charged, the power to the tool will drop quickly.

**NOTICE:** The LED may also flash due to an overload or high temperature (see BATTERY PROTECTION).

### BATTERY PROTECTION

The circuitry protects the battery pack from extreme temperature, over-discharge, and over-charge. To protect the battery from damage and prolong its life, the battery pack circuitry will turn off the battery pack if it becomes overloaded or if the temperature becomes too high during use. This may happen in extremely high torque, binding, and stalling situations. This intelligent system will shut down your battery pack if its operating temperature exceeds 176°F (80°C) and will begin normal operation when it returns to 32°F (0°C) - 122°F (50°C).

- The LED light will begin to flash slowly if the battery circuitry detects a momentary overload.

**NOTICE:** The battery can automatically reset. If the LED continues to flash, that indicates that the battery charge is depleted. Place the battery on the charger for charging (see LOW BATTERY CAPACITY INDICATOR, above).

### TO ATTACH BATTERY PACK (Fig. 3)

**⚠ CAUTION:** Avoid the possibility of accidental starting: always take care not to activate the trigger switch when you are attaching the battery pack.

1. Align the raised portion on the battery pack with the grooves in the handle of hammer, and then insert the battery pack in to the hammer as shown in Fig. 3.
2. Make sure that the latch on the battery pack snaps into place and the battery pack is secured to the tool before beginning operation.

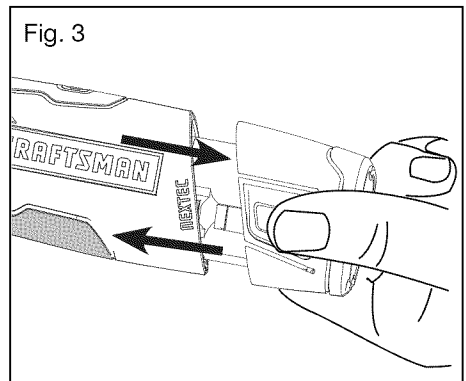

**⚠ CAUTION:** When placing the battery pack in the tool, be sure that the raised rib on the battery pack aligns with the groove inside the auto-hammer and that the battery snaps into place properly. Improper assembly of the battery pack can cause damage to internal components.

### TO DETACH BATTERY PACK (Fig. 3)

**⚠ CAUTION:** Avoid the possibility of accidental starting: always take care not to activate the trigger switch when attaching the battery pack.

1. Depress both battery-release buttons located on the sides of the battery pack to release the battery pack.
2. Pull the battery pack out and remove it from the tool.

### TRIGGER SWITCH (Fig.4)

To turn the hammer on, depress the trigger switch. To turn it off, release the trigger.

### LED WORKLIGHT (Fig. 5)

The LED worklight, located on the front of the auto-hammer, will turn on when the trigger switch is depressed. The LED worklight will turn off when the trigger switch is released. This provides additional lighting on the surface of the workpiece for operation in lower-light areas.

### FUELGAUGE (Fig. 6)

This tool is equipped with a FuelGauge which indicates the battery-pack charge level.

The green LED on the FuelGauge indicates that the battery is fully charged.

The orange LED on the FuelGauge indicates that the battery has used approximately one half of its charge.

The red LED on the FuelGauge indicates the battery pack is depleted and needs to be charged.

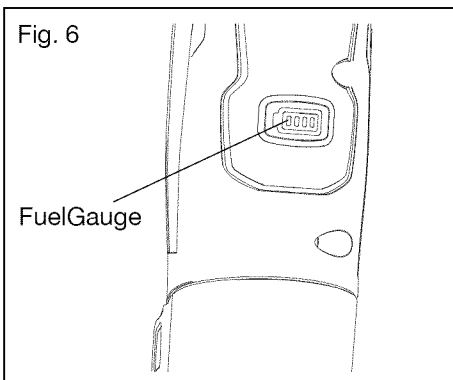
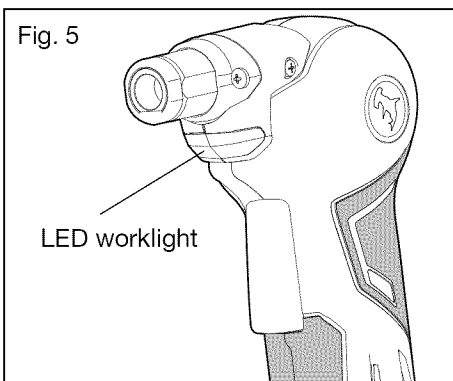
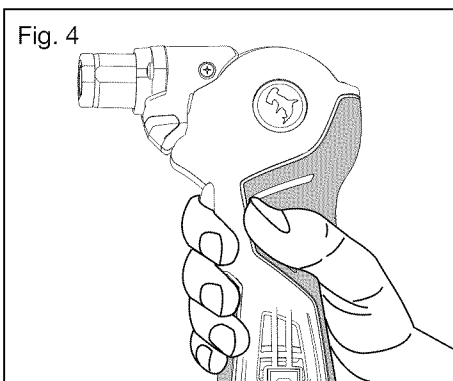

## HAMMERHEAD ARTICULATION (Fig. 7)

The hammerhead rotation lock button allows you to set the head at 0°, 45° and 90°.

Depress the hammerhead lock button to release the hammerhead. Tilt the head at the appropriate angle for your operation and then release the lock button.

## HAMMERING NAILS

1. Attach the battery pack to the auto-hammer.
2. Secure the material to be nailed with clamps to keep it from turning when hammering.
3. Adjust the hammerhead to the appropriate angle for your job.
  - For hammering nails on the floor or ceiling, set your hammerhead at 0° as shown in Fig. 8.
  - For hammering nails on the walls or doors or other vertical surfaces, set your hammerhead at 90° (Fig. 8a).
  - For hammering nails on an angle or in tight places, set your hammerhead at 45° (Fig. 8b).
5. Insert the head of the nail into the magnetic sleeve and up against the hammerhead, where it will be held in place by magnetism. Place the tip of the nail against the workpiece.

**⚠ WARNING:** Before depressing the trigger switch to start hammering, make sure that the rotational head of the auto-hammer is locked in place. Otherwise, the hammerhead would move, causing serious personal injury.

6. Holding the shaft of the nail steady with your hand, push down on the tool and press the trigger switch to initiate the hammering action, and drive the nail far enough into the workpiece so that it stands on its own. Release trigger switch and remove your hand from the nail.

Fig. 7

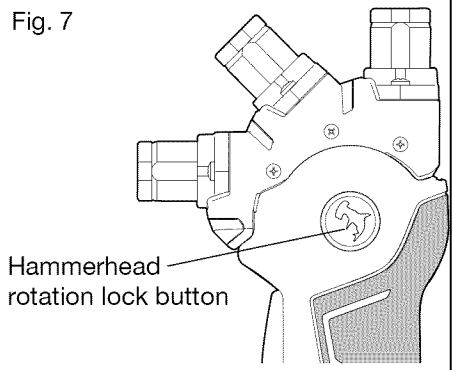

Fig. 8

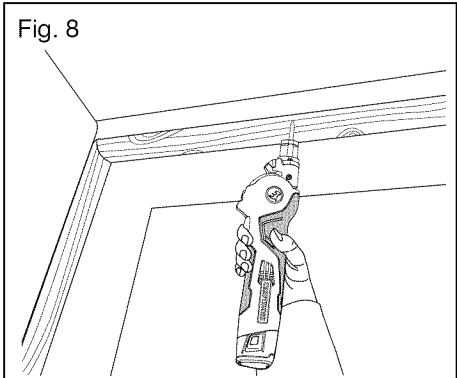

Fig. 8a

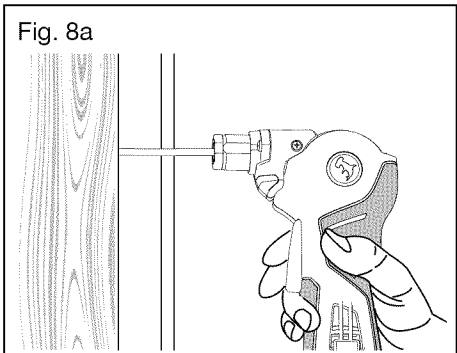
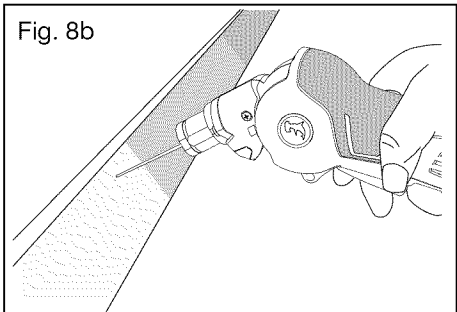

Fig. 8b



**⚠ CAUTION:** Be especially careful when driving shorter nails, such as brads, that you remove your hand as soon as the nail stands on its own in the workpiece.

- Resume pushing down on tool and pressing the trigger switch to continue hammering until the nail is fully driven into the workpiece. Near the end of hammering, the magnetic sleeve will retract to allow the hammerhead to drive the nail head flush to the workpiece.

**⚠ WARNING:** To avoid possible serious injury, do not overly force the hammer or apply side pressure. Hold the tool firmly while pushing steadily to allow the hammerhead to drive the nail automatically.

### Recommended Nails to Use

The auto-hammer is versatile for use with a variety of nails. Nails with diameters less than 7/16 inch and length equal to or less than 3-1/2 inches are recommended for use with this auto-hammer.

Refer to below table for recommended nails to use with:

No	Nail Type	Size	Shank Diameter	Head Diameter	Length
1	Bright Common	4d	0.1"	1/4"	1-1/2 in.
2	Bright Finish	6d	0.091"	9/64"	2 in.
3	Bright Finish	4d	0.072"	7/64"	1-1/2 in.
4	Coated Sinker	4d	0.08"	13/64"	1-3/8 in.
5	Electro Galvanized Roofing	4d	0.12"	1/4"	1-1/2 in.
6	Framing nails	10d	0.115"	3/8"	3 in.
7	Tempered Hard Trim	6d	0.07"	9/64"	2 in.
8	Framing nails	16d	0.1495"	5/16"	3-1/2 in.

### Recommended Nailing Materials for the Auto-Hammer

The auto-hammer may be used for nailing into all types of woods, wood-like materials, and plaster board.

**⚠ NOTICE:** The tool is not suitable for nailing in hard metal or concrete.

### Use of Nail Remover (Fig. 9)

You auto hammer comes with a 5 1/2" pry bar for use with most of the finishing nails that can be used with this tool.

- Slip the front tip underneath the nail head.
- Pull out nails as shown in Fig. 9.

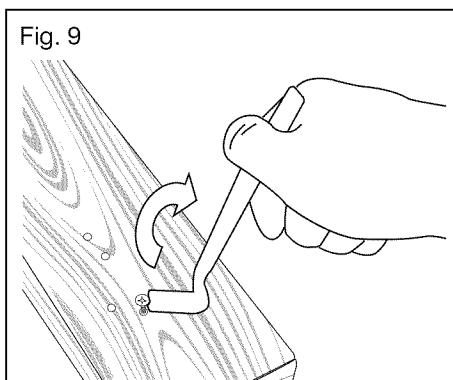

## MAINTENANCE

**⚠ WARNING:** To avoid serious personal injury, always remove the battery pack from the tool when cleaning or performing any maintenance.

**⚠ WARNING:** When servicing, use only identical craftsman replacement parts. Use of any other parts may create a hazard or cause product damage.

**⚠ WARNING:** The use of compressed dry air to clean the auto-hammer is not recommended. If cleaning with compressed air is the only method to available, always wear safety goggles or safety glasses with side shields when using compressed air to clean the tool. If the operation is dusty, also wear a dust mask.

### GENERAL MAINTENANCE

Avoid using solvents when cleaning plastic parts. Most plastics are susceptible to damage from various types of commercial solvents and may be damaged by their use. Use clean cloths to remove dirt, dust, oil, grease, etc.

**⚠ WARNING:** Do not at any time let brake fluids, gasoline, petroleum-based products, penetrating oils, etc. come in contact with plastic parts. Chemicals can damage, weaken or destroy plastic which may result in serious personal injury.

**⚠ WARNING:** When servicing, use only identical Craftsman replacement parts. Use of any other parts may create a hazard or cause product damage. To ensure safety and reliability, all repairs should be performed by a qualified service technician at a Sears Service Center.

### BATTERIES:

The battery pack is equipped with Lithium-Ion rechargeable batteries. The duration of use from each charge will depend on the type of work performed.

The batteries in this tool have been designed to provide maximum trouble-free life. Like all batteries, they will eventually wear out. Do not disassemble the battery pack or attempt to replace the batteries. Handling of the batteries, especially when wearing rings and jewelry, could result in a serious burn.

To obtain the longest possible battery life, read and understand the operator's manual.

- It is good practice to unplug the Charger and remove the Lithium-Ion battery pack when not in use.

For Lithium-Ion battery pack storage longer than 30 days:

- Store the Lithium-Ion battery pack where the temperature is below 80°F(26°C) and free of moisture.
- Store Lithium-Ion battery packs in a 30%-50% charged condition.
- Every six months of storage, fully charge the Lithium-Ion battery pack.
- Battery pack exterior may be cleaned with a cloth or soft non-metallic brush.



## BATTERY PACK REMOVAL AND PREPARATION FOR RECYCLING

To preserve natural resources, please recycle or dispose of batteries properly. This product contains lithium-ion batteries. Local, state, or federal laws may prohibit disposal of lithium-ion batteries in ordinary trash. Consult your local waste authority for information regarding available recycling and/or disposal options.

**⚠ WARNING:** Upon removal of the battery pack for disposal or recycling, cover the battery pack's terminals with heavy-duty adhesive tape. Do not attempt to destroy or disassemble the battery pack or remove any of its components. Lithium-Ion batteries must be recycled or disposed of properly. Also, never touch the terminals with metal objects and/or body parts as a short circuit may result. Keep away from children. Failure to comply with these warnings could result in fire and/or serious injury.



## TROUBLESHOOTING

PROBLEM	CAUSE	SOLUTION
The Auto-Hammer does not work	1. Battery is depleted 2. The auto-hammer is too hot after continuous usage	1. Charge the battery 2. Allow the auto-hammer to cool
	1. Battery is too hot after continuous usage	1. Allow battery to cool or replace with a cool battery

## PART LIST

### 12.0-VOLT LITHIUM-ION CORDLESS ARTICULATING AUTO-HAMMER MODEL NUMBER 320.30261

The Model Number will be found on the Nameplate attached to the handle of the tool. Always mention the Model Number when ordering parts for this tool.

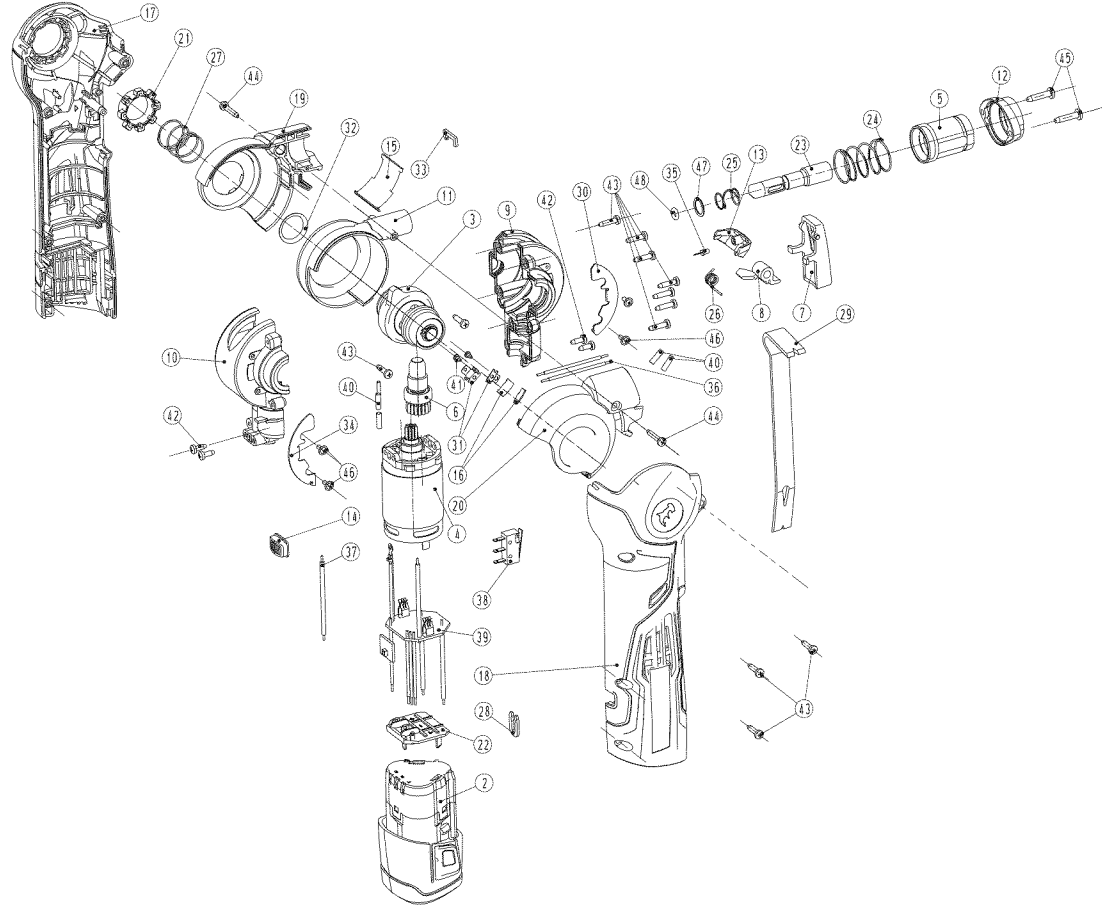

## PART LIST

No	Part No	Part Name	QTY
2	2770153000	5120 Power Pack	1
3	2823066000	Impact Block Assembly	1
4	2823067000	Motor&Gear Assembly	1
5	2823092000	Top Cover Assembly	1
6	2823097000	Gear Set	1
7	3125764000	Switch Trigger	1
8	3125765000	Push Button	1
9	3125766000	Right Gear Case	1
10	3125767000	Left Gear Case	1
11	3125847000	Spindle Bush	1
12	3125848000	Support	1
13	3125849000	LED Cover	1
14	3125850000	Light Guide Pole	1
15	3125974000	Cover	1
16	3126235000	Rubber Gasket	2
17	3321159000	Left Housing Assembly	1
18	3321160000	Right Housing Assembly	1
19	3321181000	Left Rotating Cover	1
20	3321182000	Right Rotating Cover	1
21	3321229000	Lock Button	1
22	3402298000	Contact Receptacle Assembly	1
23	3421207000	Shaft	1
24	3660376000	Spring	1
25	3660516000	Compression Spring	1
26	3660487000	Torsion Spring	1
27	3660497000	Compression Spring	1
28	3704254000	Handle Hoop	1
29	3704397000	pry bar	1
30	3704922000	Connecting Plate	1

No	Part No	Part Name	QTY
31	3704923000	Connecting Piece	2
32	3704997000	Hoop	1
33	3705046000	Handle Hoop	1
34	3705097000	Connecting Plate	1
35	4360225000	LED	1
36	4860004000	Inner Wire	2
37	4860007000	Inner Wire	2
38	4870064000	Switch	1
39	4890789000	6503 PCB Assembly	1
40	4920154000	Shrinkable Tube	5
41	5610004000	Tapping Screw	2
42	5610010000	Tapping Screw	4
43	5610012000	Tapping Screw	12
44	5610013000	Tapping Screw	2
45	5610024000	Tapping Screw	2
46	5620176000	Screw With Washer	4
47	5650249000	Washer	1
48	5690018000	O Ring	1

**NOTE**

**NOTE**

**NOTE**

# Get it fixed, at your home or ours!

## Your Home

For troubleshooting, product manuals and expert advice:



[www.managemylife.com](http://www.managemylife.com)

For repair – **in your home** – of **all** major brand appliances, lawn and garden equipment, or heating and cooling systems, **no matter who made it, no matter who sold it!**

For the replacement parts, accessories and owner's manuals that you need to do-it-yourself.

For Sears professional installation of home appliances and items like garage door openers and water heaters.

**1-800-4-MY-HOME®**

(1-800-469-4663)

[www.sears.com](http://www.sears.com)

Call anytime, day or night

(U.S.A. and Canada)

[www.sears.ca](http://www.sears.ca)

## Our Home

For repair of carry-in items like vacuums, lawn equipment, and electronics, call anytime for the location of the nearest

**Sears Parts & Repair Service Center**

**1-800-488-1222** (U.S.A.)

[www.sears.com](http://www.sears.com)

**1-800-469-4663** (Canada)

[www.sears.ca](http://www.sears.ca)

To purchase a protection agreement on a product serviced by Sears:

**1-800-827-6655** (U.S.A.)

**1-800-361-6665** (Canada)

Para pedir servicio de reparación a domicilio, y para ordenar piezas:

**1-888-SU-HOGAR®**

(1-888-784-6427)

[www.sears.com](http://www.sears.com)

Au Canada pour service en français:

**1-800-LE-FOYER<sup>MC</sup>**

(1-800-533-6937)

[www.sears.ca](http://www.sears.ca)

# Sears