

The Samsung logo, consisting of the word "SAMSUNG" in a bold, sans-serif font, is enclosed within a dark, horizontally-oriented oval shape.

Samsung SMART CAMCORDER

USER MANUAL



HMX-Q20BN/HMX-Q20TN/HMX-Q20RN
HMX-Q200BN/HMX-Q200TN/HMX-Q200RN
HMX-QF20BN

www.samsung.com/register

For video recording, use a memory card that supports faster write speeds.

- Recommended Memory Card: 6MB/s (Class 6) or above.

Important safety instructions

	CAUTION RISK OF ELECTRIC SHOCK. DO NOT OPEN.	
CAUTION: TO REDUCE THE RISK OF ELECTRIC SHOCK, DO NOT REMOVE COVER (OR BACK). NO USER-SERVICEABLE PARTS INSIDE. REFER SERVICING TO QUALIFIED SERVICE PERSONNEL.		

	This symbol indicates that dangerous voltage constituting a risk of electric shock is present within this unit.
--	---

	This symbol indicates that there are important operating and maintenance instructions in the literature accompanying this unit.
--	---

Warning

To Reduce The Risk Of Fire Or Electric Shock, Do Not Expose This Apparatus To Rain Or Moisture.

Caution

Apparatus shall not be exposed to dripping or splashing and no objects filled with liquids, such as vases, shall be placed on the apparatus.

To disconnect the apparatus from the mains, the plug must be pulled out from the mains socket, therefore the mains plug shall be readily operable.

- 1 Read these instructions.
- 2 Keep these instructions.
- 3 Heed all warnings.

- 4 Follow all instructions.
- 5 Do not use this apparatus near water.
- 6 Clean only with dry cloth.
- 7 Do not block any ventilation openings. Operate in accordance with the manufacturer's instructions.
- 8 Do not place near any heat sources such as radiators, heat registers, stoves, or other apparatus (including amplifiers) that produce heat.
- 9 Do not defeat the safety purpose of the polarized or grounding-type plug. A polarized plug has two blades with one wider than the other. A grounding type plug has two blades and a third grounding prong. The wide blade or the third prong is provided for your safety. If the provided plug does not fit into your outlet, consult an electrician for replacement of the obsolete outlet.
- 10 Protect the power cord from being walked on or pinched particularly at the plug, at wall outlets, and at the point where the cord exits from the apparatus.
- 11 Only use attachment/accessories specified by the manufacturer.
- 12 Use only with the cart, stand, tripod, bracket, or table specified by the manufacturer, or sold with the apparatus. When a cart is used, use caution when moving the cart/apparatus combination to avoid injury from tipover.
- 13 Unplug this apparatus during lightning storms or when you leave it unused for long periods of time.



Important safety instructions

- 14** Refer all servicing to qualified service personnel. Servicing is required when the apparatus has been damaged in any way, such as when the power supply cord or plug is damaged, liquid has been spilled or objects have fallen into the apparatus, the apparatus has been exposed to rain or moisture, does not operate normally, or has been dropped.
- 15** Do not expose this apparatus to dripping or splashing. Do not put objects filled with liquid, such as a vase, on this apparatus.
- 16 VENTILATION:**
Slots and openings in the cabinet are provided for ventilation to ensure reliable operation of the CAMCORDER and to protect it from overheating. These openings must not be blocked or covered. Never place your CAMCORDER on a bed, sofa, rug, or other similar surface or on or near a radiator or heat register. This CAMCORDER should not be placed in a built-in installation such as a bookcase or rack unless proper ventilation is provided or the manufacturer's instructions have been adhered to.
- 17 POWER SOURCES:**
Operate the CAMCORDER using only the types and sources of power indicated on the label. If you are not sure of the type of power supplied to your home, consult your local power company. This CAMCORDER is intended to be powered by a rechargeable battery or by its power supply. Refer to the operating instructions.
- 18 GROUNDING OR POLARIZATION:**
This CAMCORDER may be equipped with either a polarized 2-wire AC line plug (a plug having one blade wider than the other) or a 3-wire grounding type plug (a plug having a third pin for grounding). If you are unable to insert the plug fully into the outlet, try reversing the plug. If the plug still fails to fit, contact your electrician to replace your outlet. Do not defeat the safety purpose of the polarized plug.
- 19 POWER-CORD PROTECTION:**
Route power supply cords so that they are not likely to be walked on or pinched by items placed on or against them. Pay particular attention to the plug, areas around wall outlets, and the point where the cord exits from the unit.
- 20 LIGHTNING:**
To protect the CAMCORDER during a lightning storm or when you leave it unattended and unused for long periods of time, unplug it from the wall outlet. This will prevent damage to the CAMCORDER due to lightning and powerline surges.
- 21 OVERLOADING:**
Do not overload wall outlets and extension cords as this can result in a risk of fire or electric shock.
- 22 OBJECTS AND LIQUIDS:**
Never push objects of any kind into the CAMCORDER through the openings in its case. The objects may touch dangerous voltage points or short out a part that could result in a fire or electric shock. Never spill liquids of any kind onto the CAMCORDER. Should spillage occur, unplug the unit and have it checked by a technician before use.

Important safety instructions

23 SERVICING:

Do not attempt to service this CAMCORDER yourself. Opening or removing the covers may expose you to dangerous voltage or other hazards. Refer all servicing to qualified service personnel.

24 DAMAGE REQUIRING SERVICE:

Unplug this CAMCORDER from the wall outlet and refer servicing to qualified service personnel under the following conditions:

- a. When the power-supply cord or plug is damaged.
- b. If any liquid has been spilled onto or objects have fallen into the CAMCORDER.
- c. If the CAMCORDER has been exposed to rain or water.
- d. If the CAMCORDER does not operate normally when you follow the operating instructions. Do not continue to adjust the controls. Improper adjustment of the controls may result in severe damage. If this occurs, it will often require extensive work by a qualified technician to restore the CAMCORDER to its normal operation.
- e. If the CAMCORDER has been dropped or the case has been damaged.
- f. When the CAMCORDER exhibits a distinct change in performance.

25 REPLACEMENT PARTS:

When replacement parts are required, be sure the service technician has used replacement parts specified by the manufacturer that have the same characteristics as the original part. Unauthorized substitutions may result in fire, electric shock or other hazards.

26 SAFETY CHECK:

After the CAMCORDER has been serviced or repaired, ask the service technician to perform safety checks on the unit to confirm that the CAMCORDER is in safe operating order.

27 To prevent damage which may result in a fire or shock hazard, do not expose this appliance to rain or moisture.

28 Before using the power supply with a 240V AC wall outlet, attach a plug adaptor that matches the design of local wall outlets to the power supply's plug.

Important safety instructions

USER INSTALLER CAUTION:

Your authority to operate this FCC certified equipment could be voided if you make changes or modifications not expressly approved by this party responsible for compliance to part 15 FCC rules.

NOTE:

(Hg) LAMP(S) INSIDE THIS PRODUCT CONTAIN MERCURY AND MUST BE RECYCLED OR DISPOSED OF ACCORDING TO LOCAL, STATE OR FEDERAL LAWS. For details see lamprecycle.org, eiae.org, or call 1-800-Samsung (7267864)

CALIFORNIA USA ONLY

This Perchlorate warning applies only to primary CR (Manganese Dioxide) Lithium coin cells in the product sold or distributed ONLY in California USA. Perchlorate Material - special handling may apply, See www.dtsc.ca.gov/hazardouswaste/perchlorate".

NOTE:

This equipment has been tested and found to comply with the limits for a Class B digital device, pursuant to part 15 of the FCC Rules.

These limits are designed to provide reasonable protection against harmful interference in a residential installation.

This equipment generates, uses and can radiate radio frequency energy and, if not installed and used in accordance with the instructions, may cause harmful interference to radio communications. However, there is no guarantee that interference will not occur in a particular installation.

If this equipment does cause harmful interference to radio or television reception, which can be determined by turning the equipment off and on, the user is encouraged to try to correct the interference by one or more of the following measures:

- Reorient or relocate the receiving antenna. - Increase the separation between the equipment and receiver.
- Connect the equipment into an outlet on a circuit different from that to which the receiver is connected.
- Consult the dealer or an experienced radio/TV technician for help and for additional suggestions. The user may find the following booklet prepared by the Federal Communications Commission helpful: "How to Identify and Resolve Radio-TV Interference Problems." This Booklet is available from the U.S. Government Printing Office, Washington, D.C. 20402, Stock No. 004-000-00345-4.

FCC Warning



The user is cautioned that changes or modifications not expressly approved by the manufacturer could void the user's authority to operate the equipment. This device complies with Part 15 of FCC Rules. Operation is subject to the following two conditions;

- (1) This device may not cause harmful interference, and
- (2) This device must accept any interference received, including interference that may cause undesired operation.



Before reading this user manual

Before reading this user manual, review the following.

Safety warnings

Icon	Definition	Meaning
	Warning	There is a potential risk of death or serious injury.
	Caution	There is a potential risk of personal injury or damage to the product.

Icons used in this manual

Icon	Definition	Meaning
	Caution	To reduce the risk of fire, explosion, electric shock, or personal injury when using your camcorder, follow these basic safety precautions.
	Note	Here are hints or page number references you will find helpful when you operate the camcorder.
	Definition	Here are additional definitions or information you will find helpful when you operate the camcorder.

These warning icons are here to prevent injury to you and others or to help you operate your camcorder better. Please follow them explicitly. After reading this section, keep it in a safe place for future reference.

Precautions

Warning!

- When using the AC power adaptor with your camcorder, connect the adaptor to an outlet with protective grounding.
- Do not expose the camcorder battery to direct sunlight, heaters, radiators, fire, or any other source of excessive heat.

Caution

If you replace the battery with the wrong battery, you can cause an explosion. Replace only with the same battery or an equivalent type.

If you plug the AC adaptor into a 240V AC outlet, be sure to use a suitable plug adaptor that matches the design of local wall outlets.



Proper recording etiquette

- Do not record videos and photos of people without their authorization or consent.
- Do not record videos and photos in forbidden recording places.
- Do not record videos and photos in private places.

Before reading this user manual

Important information on use

About this user manual

Thank you for purchasing this Samsung Camcorder. Please read this user manual carefully before you use the camcorder and keep it handy for future reference. Should your camcorder fail to operate correctly, refer to Troubleshooting. ➔pages 108~120

This User Manual covers HMX-Q20, HMX-Q200, and HMX-QF20 models.

- Illustrations of model HMX-Q20 are used in this user manual.
- The HMX-QF20 has the wireless networking function. ➔pages 72~80
Although some features of HMX-Q20, HMX-Q200, and HMX-QF20 are different, they operate in the same way.
- The displays in this user manual may not be exactly the same as those you see on the LCD screen.
- The design and specifications of the camcorder and other accessories are subject to change without notice.
- Before use, read the 'Safety information' carefully and then operate the product properly.
- In this manual, a 'memory card (card)' means an SD, SDHC, or SDXC.
- In this user manual's function description tables, the icon shown in a description of a submenu item indicates it will appear on the screen when you set the corresponding function.
Ex) **Tele Macro** Submenu item ➔page 97
- **On** (👁): Set to record close-up images of very small objects.
If set to **On**, the corresponding icon (👁) will appear on the screen.
- Samsung is not responsible for any injury or damage caused by not following the user manual.

Before using this camcorder

- **This camcorder records video in H.264 (MPEG4/AVC) format.**
- **You can play back and edit the video recorded by the camcorder on a personal computer using the internal software of this camcorder.**
- **Please note that this camcorder is not compatible with other digital video formats.**
- **Before recording an important video, make a trial recording.**
Play back your trial recording to make sure the video and audio have been recorded properly.
- **Recorded contents may be lost due to errors in handling the camcorder or memory card, etc.**
Samsung will not provide compensation for damages caused by the loss of recorded contents.
- **Make a backup of important recorded data.**
Protect your important recorded data by copying the files to a PC. We also recommend you copy them from your PC to other recording media for storage. Refer to the software installation and USB connection guide.
- **Copyrights: Please note that this camcorder is intended for individual use only.**
Data recorded on the storage media in this camcorder using other digital/analog media or devices is protected by the Copyright Act and cannot be used without permission of the owner of the copyright, except for personal enjoyment. Even if you record an event such as a show, performance, or exhibition for personal enjoyment, we strongly recommend that you obtain permission beforehand.

Before reading this user manual

- **The wireless version of this camcorder may emit radio interference. Avoid using it near pacemakers and similar medical equipment.**
- **Always use caution when transferring files via Wi-Fi. There is a danger that your data could be intercepted.**
- **Take the appropriate security precautions when using wireless network products.** Samsung is not responsible for any damages that may arise from security problems caused by the failure to implement security measures or from unavoidable circumstances associated with the use of a wireless network.
- **For Open Source licenses information, refer to the 'Opensource-Q20.pdf' in the provided CD-ROM.**
- Flickr is a trademark of Yahoo.
- Facebook is a trademark of Facebook Inc.
- Twitter is a trademark of twitter Inc.
- Picasa is a trademark of Google Inc.
- HDMI, the HDMI logo and High-Definition Multimedia Interface are trademarks or registered trademarks of HDMI Licensing LLC.
- Adobe, the Adobe logo, and Adobe Acrobat are either registered trademarks or trademarks of Adobe Systems Incorporated in the United States and/or other countries.
- Wi-Fi®, the Wi-Fi CERTIFIED logo, and the Wi-Fi logo are registered trademarks of the Wi-Fi Alliance.
- AllShare™ is a Samsung's trademark.

Notes regarding trademarks

- All the trade names and registered trademarks mentioned in this manual or other documentation provided with your Samsung product are trademarks or registered trademarks of their respective holders. Furthermore, '™' and '®' are not mentioned in each case in this manual.
- The SD, SDHC and SDXC logos are trademarks of SD-3C, LLC.
- Microsoft®, Windows®, Windows Vista®, Windows® 7, and DirectX® are either registered trademarks or trademarks of the Microsoft Corporation in the United States and/or other countries.
- Intel®, Core™, Core 2 Duo®, and Pentium® are the registered trademarks or trademarks of the Intel Corporation in the United States and other countries.
- AMD and Athlon™ are either registered trademarks or trademarks of AMD in the United States and other countries.
- Macintosh, Mac OS are either registered trademarks or trademarks of Apple Inc. in the United States and/or other countries.
- YouTube is a trademark of Google Inc.

Safety information

The safety precautions illustrated below are to prevent personal injury or material damages. Heed all instructions carefully.



WARNING There is a potential risk of death or serious injury.



Do not overload outlets or extension cords as this may result in abnormal heat or fire.



Using the camcorder at temperatures over 140°F (60°C) may result in fire. Keeping the battery at a high temperature may cause an explosion.



Do not allow water, metal or inflammable matter to enter the camcorder or AC power adaptor. Doing so may pose a fire hazard.



No sand or dust! Fine sand or dust entering the camcorder or AC power adaptor can damage both units and cause them to malfunction.



No oil! Oil entering the camcorder or AC power adaptor can damage both units, cause them to malfunction, and poses a risk of electric shock.



Do not aim the camcorder directly into the sun. Doing so could cause eye injuries and cause internal parts of the product to malfunction.



Do not bend the power cord or damage the AC power adaptor by pressing on it with a heavy object. A damaged power cord or power supply can cause a fire and poses a risk of electric shock.



Do not disconnect the AC adaptor by pulling on its power-cord. This can damage the power-cord.



Do not use the AC adaptor if it has damaged, split, or broken cords or wires. A damaged power cord can cause a fire and poses a risk of electric shock.

Safety information



WARNING There is a potential risk of death or serious injury.



Do not plug in the AC adaptor unless the plug can be fully inserted into the wall outlet with no part of the blades exposed.



Do not dispose of the battery in a fire. The heat from the fire could cause the battery to explode.



Never use cleaning fluid or similar chemicals to clean the camcorder. Do not spray cleaners directly on the camcorder. Doing so may pose a fire hazard.



Keep the camcorder away from water when using it near the beach or pool or when it rains. Getting water inside the camcorder can cause it to malfunction and poses a risk of electric shock.



Do not plug in or unplug the power cord with wet hands. You could receive an electric shock.



Keep the used lithium battery or memory card out of the reach of children. If the lithium battery or memory card is swallowed by a child, consult a physician immediately.



Keep the power supply's power-cord unplugged when not using the power supply or during lightning storms. There is a risk of fire.



When cleaning the AC adaptor, unplug the power-cord. Leaving the adaptor plugged in can cause it to malfunction and poses a risk electric shock.



If the camcorder emits an abnormal sound or smell or smokes, unplug the power-cord immediately and request service from a Samsung service center. There is a risk of fire or personal injury.



If the camcorder malfunctions, immediately detach the AC adaptor or battery from the camcorder. There is a risk of fire or injury.



To avoid a risk of fire or electric shock, do not attempt to disassemble, repair, or modify the camcorder or the AC adaptor.

Safety information



CAUTION There is a potential risk of personal injury or damage to the product.



Do not press the surface of the LCD with force, or hit it with a sharp object. If you press or strike the LCD surface, you can cause display unevenness or damage the display.



Do not drop or expose the camcorder, battery, AC adaptor, or other accessories to severe vibrations or impact. Severe vibration or impact can cause these items to malfunction and lead to personal injury.



Do not use the camcorder on a tripod (not supplied) in a place where it is subject to severe vibrations or impact.



Do not use the camcorder in direct sunlight or near heating equipment. Excess heat can cause the camcorder to malfunction and lead to personal injury.



Do not leave the camcorder in a closed vehicle for a long time where the temperature is very high.



Do not expose the camcorder to soot or steam. Thick soot or steam could damage the camcorder case or cause a malfunction.



Do not use the camcorder near dense exhaust gas generated by gasoline or diesel engines, or near a corrosive gas such as hydrogen sulfide. Doing so may corrode the external or internal terminals, disabling normal operation.



Do not expose the camcorder to insecticide. Insecticide entering the camcorder could cause the product to operate abnormally. Turn the camcorder off and cover it with vinyl sheet, etc. before using insecticide.



Do not expose the camcorder to sudden changes in temperature or high humidity. Use care when operating the camcorder outdoors during a lightning storm. Rapid temperature changes and high humidity can damage the camcorder and lightning storms pose the threat of electric shock.



Do not put the camcorder down with the LCD screen open.



Do not wipe the camcorder body with benzene or thinner. The exterior coating could peel off or the surface could deteriorate.



Do not leave the LCD screen open when not using the camcorder.

Safety information



CAUTION There is a potential risk of personal injury or damage to the product.



Do not hold the camcorder by the LCD monitor when lifting it. The LCD screen could detach and the camcorder may fall.



Do not use the camcorder near a TV or radio. This could cause distortion on the TV screen or interference in the radio broadcasts.



Do not use the camcorder near sources of strong radio waves or magnetism such as speakers or large motors. Noise from these sources could distort the video or audio you are recording.



Use Samsung-approved accessories only. Using products from other manufacturers may lead to overheating, fire, explosion, electric shock or personal injuries caused by abnormal operation.



Place the camcorder on a stable surface that is well ventilated.



Store important data separately from the camcorder on a PC, DVD disc, CD disc, etc. Samsung is not responsible for data loss.



Only plug the adaptor plug into a socket that is easily accessible. If any problem occurs with the product, you must pull the plug out of the socket to disconnect the power completely. Turning off the power button on the product does not completely disconnect the power.



Manufacturers of unauthorized accessories compatible with this camcorder are responsible for their own products. Use the optional accessories according to their safety instructions. Samsung is not responsible for any malfunctions, for fires or electric shocks, or for damage caused by unauthorized accessories.

Contents

Getting Started	11	Extended functions	44
Unpacking	12	Using the Manual modes	45
Camcorder layout	13	White Balance	45
Inserting/Ejecting the battery and memory card	15	EV (Exposure Value)	46
Inserting/ejecting the battery	15	Back Light	47
Inserting/ejecting a memory card (not supplied)	16	Focus	48
Charging the battery	20	Super C.Nite	49
Checking the battery state	21	Self Timer	50
Turning your camcorder on/off	24	Cont. Shot	50
Using the touch screen	25	Using the Art Film modes	51
Performing the initial setup	28	Fader	51
Selecting the language	29	Digital Effect	52
Learning icons	30	Using the Art Time Lapse mode	53
Using the Home screen	34	Playback/Editing	55
Accessing the Home screen	34	Viewing videos or photos in playback mode	56
Icons on the Home screen	34	Starting the playback mode	56
Using the grip belt	35	Playing back videos	57
Basic functions	36	Tagging great moments during playback	60
Recording videos	37	Viewing photos	61
Recording videos in portrait mode	39	Editing videos or photos	63
Tagging great moments while recording (My Clip function)	40	Share (HMX-QF20 only)	63
Recording photos	41	Delete	65
Recording with ease for beginners (SMART AUTO)	42	Delete My Clip	66
Zooming	43	My Clip Creation	66
		Protect	67
		Smart BGM	67
		Divide	68

Contents

Combine	69	Transferring files to your Windows computer	88
File Info.....	70	Transferring files with Intelli-studio	89
Wireless network (HMX-QF20 only)	71	Transferring files by connecting the camcorder as a removable disk.....	93
Connecting to a WLAN and configuring network settings..	72	Settings	95
Connecting to a WLAN	72	Settings menu	96
Configuring the network settings.....	73	Accessing the settings menu	96
Manually setting the IP address	74	Shooting	97
Network connection tips	75	Playback	98
Entering text	75	Display	101
Using video or photo sharing web sites.....	76	Connectivity.....	103
Accessing a web site.....	76	General	104
Uploading videos or photos.....	76	Appendixes	107
Viewing videos or photos on a TV Link-enabled TV.....	77	Troubleshooting	108
Using Auto Backup to send videos or photos	78	Warning icons and messages	108
Installing the program for Auto backup on your PC	78	Symptoms and solutions.....	114
Sending photos or videos to a PC.....	78	Maintenance	121
About the Wakeup on LAN (WOL) feature	79	Using your camcorder abroad	123
Using with other devices	81	Glossary	124
Connecting to a TV.....	82	Specifications.....	125
Connecting to a high definition TV with HDMI	82		
Connecting to a regular TV.....	83		
Viewing on a TV screen.....	84		
Dubbing videos to VCR or DVD/HDD recorders	85		
Printing photos with a PictBridge photo printer.....	86		



Getting Started

Learn about your camcorder's layout, icons, and home screen.

Unpacking	12
Camcorder layout.....	13
Inserting/Ejecting the battery and memory card.....	15
Inserting/ejecting the battery	15
Inserting/ejecting a memory card (not supplied).....	16
Charging the battery.....	20
Checking the battery state	21
Turning your camcorder on/off.....	24
Using the touch screen	25
Performing the initial setup.....	28
Selecting the language.....	29
Learning icons.....	30
Using the Home screen.....	34
Accessing the Home screen	34
Icons on the Home screen	34
Using the grip belt	35

Unpacking

Your new camcorder comes with the following accessories. If any of these items is missing from your box, call Samsung's Customer Care Center.

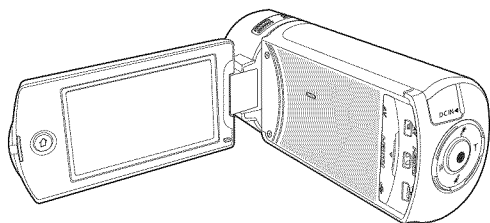

Model name	Color	Internal memory	Lens	WiFi module
HMX-Q20BN HMX-Q200BN	Black	No	X20 (Optical) X40 (Digital)	No
HMX-Q20TN HMX-Q200TN	Titan			
HMX-Q20RN HMX-Q200RN	Wine Red			
HMX-QF20BN	Black			Yes

 Although some features of the models are different, they operate in the same way.

Checking your accessories



Battery
(BP125A)
(AD43-00197A)



AC power adaptor
(AA-MA9)
(AD44-00151A)



USB cable
(AD39-00194A)



User manual CD
(AD46-00423A)



Quick start guide
(AD68-06831A)

Optional accessories



Audio/Video cable
(AD39-00184A)



Micro HDMI cable
(AD39-00179A)



External battery charger
(A-BC9UA4)



Carrying case
(AD69-00929A)



Memory card



- The exact appearance of each item may vary by model.
- The contents may vary depending on the sales region.
- You can purchase parts and accessories. Consult your local Samsung dealer.
- SAMSUNG is not responsible for reduced battery life time or malfunctions caused by any unauthorized use of accessories such as the AC power adaptor or the batteries.
- A memory card is not included. See page 17 for memory cards compatible with your camcorder.
- Your camcorder includes the user manual CD and printed quick start guide.

Camcorder layout

Top/Front/Left

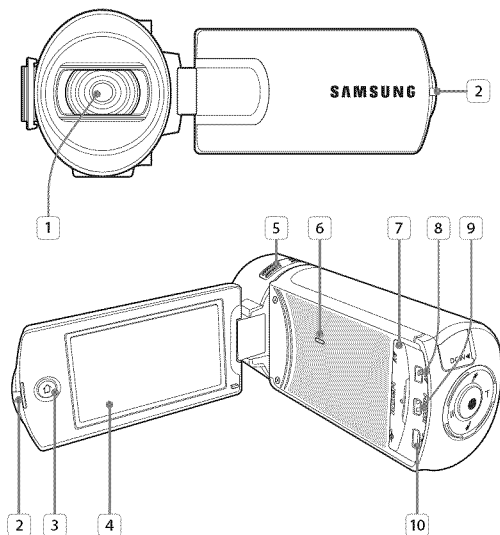

- 1 Lens
- 2 Charging indicator
- 3 Home (🏠) button
- 4 LCD screen (Touch screen)
- 5 Internal microphone
- 6 Internal speaker
- 7 Jack cover (AV/HDMI/micro USB)
- 8 AV (Audio/Video) jack
- 9 HDMI jack
- 10 micro USB jack



Be careful not to cover the internal microphone and lens during recording.

Camcorder layout

Rear/Right/Bottom

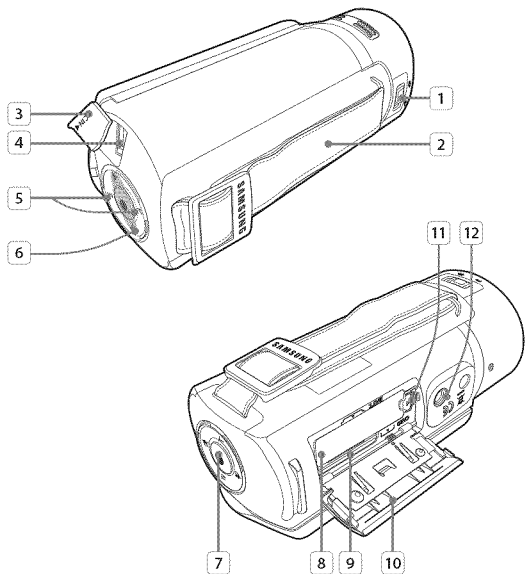

1 Lens open/close switch

2 Grip belt

3 Jack cover (DC IN)

4 DC IN jack

5 Zoom (T/W) button

6 My Clip (📌/📌) button

7 Recording start/stop button

8 Battery slot

9 Memory card slot

10 Battery/Memory card cover

11 Battery release switch

12 Tripod receptacle

Inserting/Ejecting the battery and memory card

Inserting/ejecting the battery

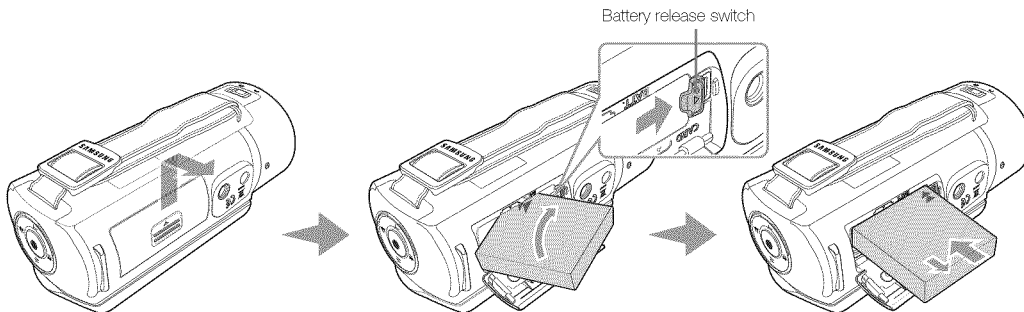

To insert the battery

- 1 Slide, and then open the battery slot cover as shown in the figure.
- 2 Insert the battery into the battery slot until it locks.
 - Make sure that the SAMSUNG logo is facing down and the battery is placed as shown in the figure.
- 3 Close the battery slot cover.

To eject the battery

- 1 Slide, and then open the battery slot cover as shown in the figure.
- 2 Slide the Battery release switch in the direction shown in the figure, and then pull out the battery.
- 3 Close the battery slot cover.



- Samsung is not responsible for problems that are caused by using unapproved batteries. If you use batteries from other manufacturers, there is a danger of overheating, fire, or explosion.
- Purchase extra batteries to allow continuous use of your camcorder.

Inserting/Ejecting the battery and memory card

Inserting/ejecting a memory card (not supplied)

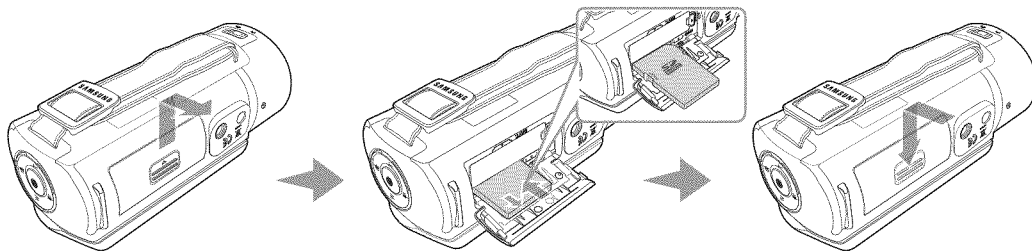

To insert a memory card

- 1 Slide, and then open the memory card cover as shown in the figure.
- 2 Insert the memory card into the card slot until it softly clicks.
 - Make sure that the label portion of the card is facing up and the camcorder is placed as shown in the figure.
- 3 Close the memory card cover.

To eject a memory card

- 1 Slide, and then open the memory card cover as shown in the figure.
- 2 Gently push the memory card to eject it.
- 3 Close the memory card cover.



- To avoid the data loss, turn off the camcorder by pressing and holding the [Home (⬆)] button before inserting or ejecting the memory card.
- Be careful not to push the memory card too hard. The memory card may suddenly pop out.

Inserting/Ejecting the battery and memory card

Compatible memory cards

- You can use SD, SDHC, and SDXC cards with this camcorder. We recommend you use an SDHC card. This camcorder supports SD cards up to 2GB. We cannot guarantee normal operation with SD cards bigger than 2GB.
- MMC (Multi Media Card) and MMC Plus are not supported.
- Compatible memory card capacity:
 - SD: 1GB~2GB
 - SDHC: 4GB~32GB
 - SDXC: ~up to 64GB
- When you use unauthorized memory cards, the camcorder cannot record videos correctly and your recordings may be lost.
- The memory cards released after the release date of this camcorder may not be compatible with the camcorder.
- To ensure stable operation, use 6MB/S (Class 6) or above memory cards.
- SD/SDHC/SDXC memory cards have a mechanical write-protection switch. Setting the switch prevents accidental erasure of files recorded on the card. To enable writing, move the switch up in the direction of the terminals. To set write protection, move the switch down.
- SDHC/SDXC cards are a higher version of SD memory cards and provide more memory capacity than SD memory cards.
- SD cards can be used with current SD enabled host devices.

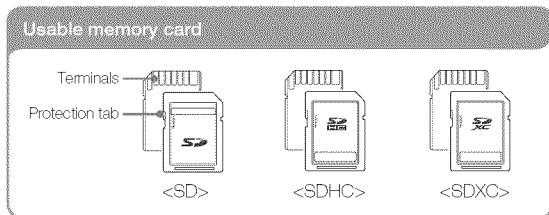

Inserting/Ejecting the battery and memory card

Handling a memory card

- Damaged data may not be recoverable. We recommend you make a back-up of important data separately on the hard disk of your PC.
- Turning the power off or removing a memory card during an operation such as formatting, deleting, recording, and playback may cause data loss.
- If you modify the name of a file or folder stored in the memory card with your PC, your camcorder may not recognize the modified file.
- The memory card does not support any data recovery mode. Therefore, care should be taken in case the memory card is damaged while recording.
- Make sure to format the memory card on this camcorder. If the memory card had been formatted by a PC or other device, using it on this camcorder without reformatting it on the camcorder may result in trouble with recording and/or playback. Samsung is not responsible for damage to recorded contents caused by a failure to format the memory card properly.
- You have to format newly-purchased memory cards and memory cards with data that your camcorder cannot recognize or with data saved by other devices. Note that formatting erases all data on the memory card and deleted data cannot be recovered.
- A memory card has a certain life span. If you cannot record new data, you have to purchase a new memory card.
- Do not bend, drop, or subject the card to strong impacts.
- Do not place foreign substances on the memory card terminals. Use a soft dry cloth to clean the terminals if required.
- Do not paste anything other than the label provided with the card on the label pasting area of the card.
- Do not use a damaged memory card.
- Be careful to keep the memory card out of the reach of children, who might swallow it.

The camcorder supports SD, SDHC, and SDXC memory cards, giving you a wider choice of cards!

The data storage speed of cards may differ, depending on the manufacturer and production system.

- SLC (single level cell) system: faster write speed enabled.
- MLC (multi level cell) system: only lower write speed is supported.

For best results, we recommend using a memory card that supports a faster write speed.

Using a lower write speed memory card for recording video may cause difficulties when storing.

You may even lose your video data during the recording. In an attempt to preserve every bit of the recorded video on a low speed card, the camcorder forcibly stores the video on the memory card and displays a warning:

Low speed card. Please record at a lower resolution.

If you are unavoidably using a low speed memory card, the resolution and quality of the recording may be lower than the value you set. ▶page 97

The higher the video resolution and quality, the more memory the camcorder uses.



- Samsung is not responsible for data loss due to misuse, including loss caused by any PC virus.
- We recommend using a memory card case to avoid data loss that can be caused by moving the card or by static electricity.
- After a period of use, the memory card may get warm. This is normal and is not a malfunction.

Inserting/Ejecting the battery and memory card

Recording time available for video in minutes

Resolution	Storage media (Capacity)						
	1GB	2GB	4GB	8GB	16GB	32GB	64GB
Full HD 1080/60i	7	14	30	61	123	247	497
HD 720/60p	10	21	42	86	174	349	702
Web/HD	9	19	40	81	167	336	665

(Unit: Approximate minutes of recording)

Recordable number of photos

Resolution	Storage media (Capacity)						
	1GB	2GB	4GB	8GB	16GB	32GB	64GB
5.3M 3072X1728	878	1847	2832	5770	9999	9999	9999
2M 1920X1080	1097	2309	4602	9352	9999	9999	9999

(Unit: Approximate number of images)

1GB \approx 1,000,000,000 bytes : Actual formatted capacity may be less as the internal firmware uses a portion of the memory.



- Actual recording times may differ depending on the recording conditions and the subject.
- The higher the quality and resolution, the more memory the camcorder uses.
- Lower resolution and quality increases the recording time, but the image quality may suffer.
- The bit rate automatically adjusts to the image being recorded. Accordingly, the recording time may vary.
- Memory cards bigger than 64GB may not operate normally.
- The maximum video file size is 1.8GB. When a video file exceeds 1.8GB, a new video file is created automatically.
- When recording in Web/HD resolution, you can record a video up to 10 minutes.
- The maximum number of recordable photo and video files is 9999, respectively.
- The recording length of Art Time Lapse may vary depending on settings.

Charging the battery

Charge the battery using the AC power adaptor or the USB cable.

The charging indicator lights up and charging starts. After the battery is fully charged, the charging indicator turns green.

Using the AC power adaptor

Connect the AC power adaptor to the camcorder properly, and then plug the AC Power adaptor in the wall outlet.

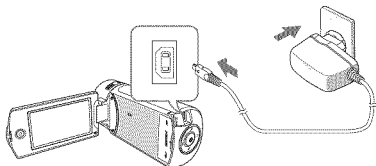

Using the USB cable

Connect the USB cable to the camcorder properly, and then connect the other end to a USB port of a PC.

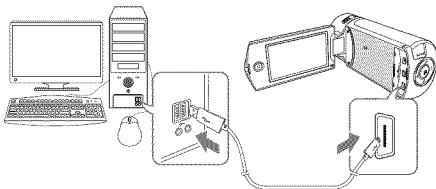

- Make sure that there are no foreign substances on the plug and in the socket when you connect the AC power supply to the camcorder.
- Make sure to turn off the camcorder before disconnecting the AC power adaptor. Otherwise, you can damage the storage media or data.
- Use a nearby wall outlet when using the AC power adaptor. Disconnect the AC power adaptor from the wall outlet immediately if any malfunction occurs while using your camcorder.
- Do not place the AC Adaptor in a confined space when you use it, such as between a wall and a piece of furniture.



- When charging, if both the USB cable and AC power adaptor are connected, the AC power adaptor will override the USB.
- You cannot operate the camcorder using USB power only. Use the AC power adaptor or battery to power the camcorder.
- USB charging time may depend on the type of USB host on your PC.
- If you use the camcorder while you are charging the battery, charging may take longer.
- Be sure to use the included AC power adaptor to power the camcorder. Using other AC power adaptors could cause electric shock or result in fire.
- You can use the AC power adaptor around the world. However, you will need an AC plug adaptor that matches the design of local wall outlets in some foreign countries. If you need an adaptor, purchase it from your distributor.

Charging the battery

Checking the battery state

You can check the charging state and remaining battery capacity.

To check the charging state

The color of the LED indicates the power or charging state.

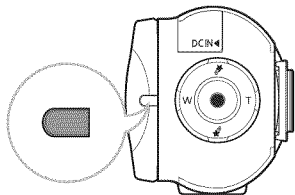

LED color	Description
(Orange)	Charging
(Green)	Fully charged
(Orange Blink)	Error

Battery level display

The battery level display shows the amount of battery power remaining in the battery.



Battery level icon	State	Message
	Fully charged	-
	25~50% used	-
	50~75% used	-
	75~95% used	-
	95~98% used	-
	Exhausted (flickers): The camcorder will be forced to turn off after 3 minutes. Change the battery as soon as possible.	-
-	After 3 seconds, the camcorder turns off.	Low Battery



The figures above are based on a fully charged battery at a normal temperature. Low ambient temperature may affect the use time.

Charging the battery

Available charging and running time for the battery

Battery type	BP125A	
Charging time	Using the AC power adaptor: approx. 130 min. Using the USB cable: approx. 270 min.	
Video resolution	Full HD	HD
Continuous recording time	Approx. 105 min.	Approx. 120 min.
Playback time	Approx. 140 min.	Approx. 160 min.

- Charging time: Approximate time in minutes required to fully charge a completely exhausted battery.
- Recording/Playback time: Approximate time available when you have fully charged the battery.
- Times shown above are measured under Samsung's test conditions. Your times may differ, depending on your usage and conditions.

Continuous Recording (without zoom)

The continuous recording time above shows the available recording time when you record without using any other function after recording starts. The battery may discharge 2-3 times faster than this reference if you use the recording start/stop, the zoom, and the playback functions. Prepare additional batteries with the expectation that the actual recording time is about 1/3 to 1/2 of the times listed above.

Using an AC power source

We recommend that you use the AC power adaptor to power the camcorder from a household AC outlet when recording and playing the camcorder indoors. The connection is the same as that for battery charging. [▶ page 20](#)



- The charging time will vary depending on the charge remaining in the battery.
- Depending on your PC specifications, the charging time can be prolonged.
- The battery is charged over 95% after about 2 hours, and the indicator color changes to green. It takes about 2 hours and 40 minutes for the battery to charge 100%.
- The recording and playback times will be shorter when you use your camcorder in low temperatures.
- We recommend using the AC power adaptor when using the Art Time Lapse function.

Charging the battery

About the battery

- **Battery properties**

A lithium-ion battery is small-sized and has a high capacity. Low ambient temperature (below 50°F (10°C)) may shorten its usage time and affect its function. Before recording in low temperatures, put the battery into your pocket to warm it, then install it in the camcorder.

- **Make sure to store the battery separately after use.**

- A small amount of battery power is consumed when the battery is stored in the camcorder even if the camcorder power is off.
- The battery may be completely discharged, if it has been installed and left in the camcorder for a long period of time. If this occurs, the battery may not fully operate even if you charge it.
- If the battery is not used for a long time, fully charge the battery and then, using your camcorder, drain the charge completely once every 3 months to keep the battery functioning properly. To store the battery, remove it from your camcorder and put it in a cool, dry place.

- **Charge an extra battery before using the camcorder outdoors in cold temperatures.**

- The cold temperature may shorten the available recording time.
- Carry the supplied AC power adaptor to charge the battery while travelling.

- **Check whether the battery terminal is damaged if the battery falls or is dropped.**

- If you install a battery with the damaged terminal into the camcorder, you can damage the camcorder.

- **Remove the battery and the memory card from the camcorder and disconnect the power adaptor after use.**

- Store the battery in a stable, cool and dry place.
(Recommended temperature : 59°F~77°F (15°C~25°C), recommended humidity: 40%~60%)
- Temperatures that are too high or too low shorten the battery lifetime.
- The battery terminals can become rusty or malfunction if the battery is stored in a smoky or dusty location.

- **Recycle or dispose of your dead batteries properly.**

- **The battery lifetime is limited.**

- Battery capacity decreases over time and through repeated use. If decreased usage time between charges becomes significant, it is probably time to replace the battery with a new one.
- Each battery's life is affected by storage, operating, and environmental conditions.

Turning your camcorder on/off

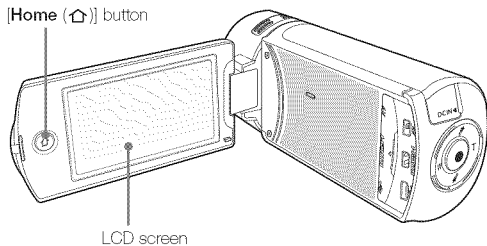

- 1 Turn on the camcorder by opening the LCD screen.
 - Your camcorder turns on automatically when you open the LCD screen.
 - To turn the camcorder on when the LCD screen is already open, press and hold the [Home (⏠)] button.
- 2 To turn off the camcorder, press and hold the [Home (⏠)] button.
 - Your camcorder turns off even when you close the LCD screen.



- The camcorder operates the self-diagnosis function when you turn it on. ➔ pages 108~113
- If the Quick On STBY function is set to **5 Min** and you close the LCD screen when the power is on, the power saving mode activates. ➔ page 105
- The camcorder turns on automatically if you connect the AC power adaptor or insert the battery into the camcorder with the LCD screen open.



When using this camcorder for the first time

When you use your camcorder for the first time or reset it, the time zone screen appears at start-up. Select your geographical location and then set the date and time. ➔ page 28

If you do not set the date and time, the time zone screen appears every time you turn on the camcorder.

Using the touch screen

The touch screen lets you playback and recording with a simple touch of your finger. Place your hand on the rear side of the LCD screen to support it. Then, touch the items displayed on the screen.

Drag

Drag the touch screen up, down, left, or right to select the desired items or files.

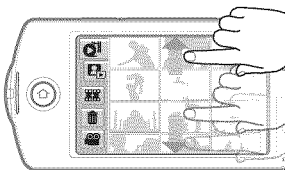
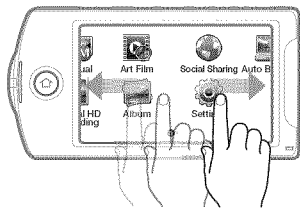

Touch

Lightly touch items with your finger to select or execute.

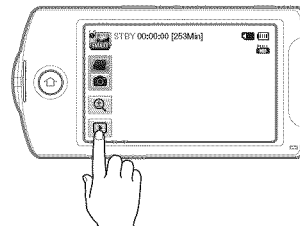

- Do not place any protective film on the LCD screen.
- If you leave a film attached for a long time, strong adhesion between the film and the surface of the screen may cause a malfunction of the touch screen.



- Be careful not to accidentally press the button near the LCD screen while using the touch screen.
- The tabs and icons that appear on the LCD screen depend on the current recording/playback status of your camcorder.
- The camcorder does not recognize touches if you touch more than two points on the screen at the same time. Touch one point at a time.

Using the touch screen

Switching the information display mode

You can switch the on-screen information display mode. Each time you touch the LCD screen, the full and minimum display modes alternate.

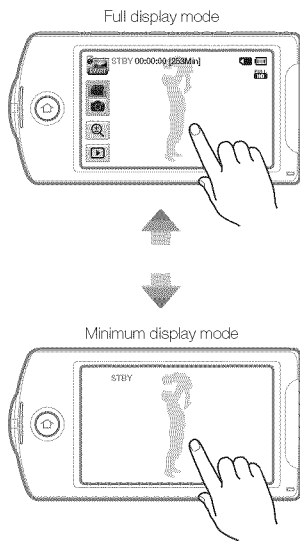

Warning icons and messages may appear, depending on the recording conditions. → pages 108~113

Using the touch screen

Adjusting the LCD screen

The wide LCD screen on your camcorder offers high quality image viewing.

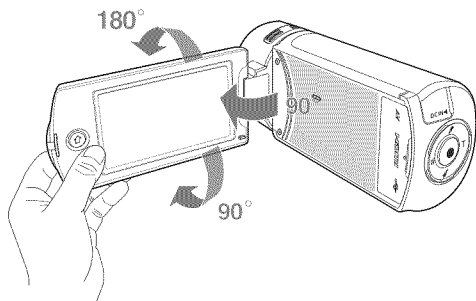

- 1 Open the LCD screen with your finger.
 - The screen opens up to 90°.
- 2 Rotate the LCD screen towards the lens.
 - You can rotate it up to 180° towards the lens and up to 90° backward. To view recordings more conveniently, rotate the screen by 180° towards the lens, then fold it back to the body.

 When you reverse and close the LCD screen by rotating it to 180° towards the lens, the camcorder switches to the playback mode automatically.

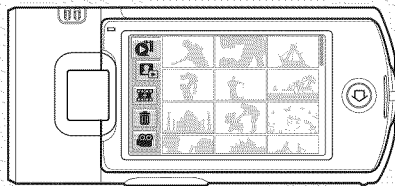



 Excessive rotation may damage the connective hinge between the screen and the camcorder.

 Clean fingerprints or dust on the screen with a soft cloth.

Performing the initial setup

Set the date and time of your local area when turning on this camcorder for the first time.

- 1 Open the LCD screen to turn on the camcorder.
 - The time zone (**Home**) screen appears based on Lisbon and London (Greenwich Mean Time).
- 2 Select your local area on the map by touching the  or  tab on the LCD screen, and then press the **OK** tab.



- 3 Touch the up or down arrows to set the date.

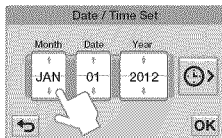

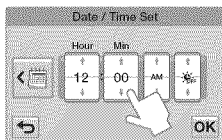

- 4 Touch the time () tab, and then set the time.



- 5 Make sure the clock is correctly set, and then touch the **OK** tab.
 - The date/time setting is complete.



- You can set the year up to 2037, based on **Home**.
- Set **Date/Time Display** to On.  page 102
- Activating the  icon moves the time forward by 1 hour.



Internal rechargeable battery

- Your camcorder includes a internal rechargeable battery that retains the date and time settings even after the power is turned off.
- If the battery is depleted, the current date/time values are reset to the default values. If this occurs, you need to recharge the internal rechargeable battery (see below), and then re-set the current date and time.

Charging the internal rechargeable battery

- The internal battery is always recharged while your camcorder is connected to AC power or while the battery is attached.
- If you have not used the camcorder for about 2 weeks and you have not connected the AC power or the battery to it, the internal battery fully discharges. If this occurs, charge the internal battery by connecting the camcorder to the supplied AC adaptor for 24 hours.

Selecting the language

You can select the language in which the camcorder displays the menu screen or messages. The camcorder retains the language setting even when you turn it off.

- 1 Press the [Home (🏠)] button, and then drag the Home screen left.

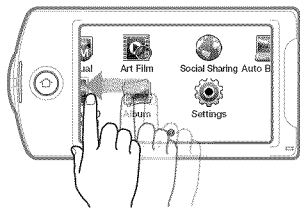
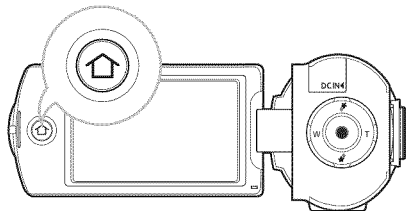

- 2 Touch **Settings** → **General** → **Language**.

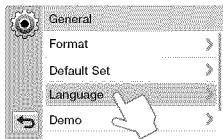

- 3 Touch the desired language.



- 4 Touch the Return (↩) tab to complete the setting.
 - The camcorder displays the menus screen and messages in the language you selected.



- **Language** options may be changed without prior notice.
- The camcorder retains the language you select even when not connected to the battery or AC power.
- The date and time format may change depending on the language you selected.

Learning icons

The available functions vary depending on the operation mode you have selected. Different icons appear depending on the setting values.

Video recording mode

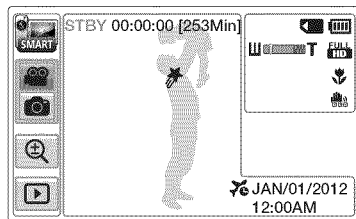

Left of the LCD screen

Icon	Description
	Smart Auto mode/Manual mode/Art Film mode/Art Time Lapse mode/Vertical HD Recording mode
	Video/Photo recording mode tab
	Zoom tab
	Playback tab

Right of the LCD screen

Icon	Description
	Storage media (Memory card)
	Battery information (remaining charge level)
	Optical zoom/Digital zoom bar
	Video resolution
	Tele Macro
	OIS Duo

Center of the LCD screen

Icon	Description
	Operating status (standby/recording/pause)
	Time counter (video recording time)
	Remaining recordable time
	My Clip
	Time Zone (Visit)
	Date/Time



- The settings of functions marked with a * are lost when the product turns off.
- The icons are based on an 32GB SDHC memory card capacity.
- The screen above is an example and may differ from the actual display.
- For warning icons and messages, see pages 108~113.
- The illustrated items above and their positions can be changed without notice to improve performance.

Learning icons

Photo recording mode

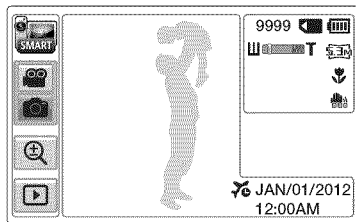

Left of the LCD screen

Icon	Description
	Smart Auto mode/Manual mode/ Art Film mode
	Video/Photo recording mode tab
	Zoom tab
	Playback tab

Right of the LCD screen

Icon	Description
9999	Photo image counter (total number of recordable photos)
	Storage media (Memory card)
	Battery information (remaining charge level)
	Optical zoom/Digital zoom bar
	Photo resolution
	Tele Macro
	OIS Duo

Center of the LCD screen

Icon	Description
	Time Zone (Visit)
JAN/01/2012 12:00 AM	Date/Time



- The settings of functions marked with a * are lost when the product turns off.
- The total number of recordable photos is based on available space on the storage media.
- The largest number the OSD Image Counter can display is 9999.

Learning icons

Video playback mode: Thumbnail view

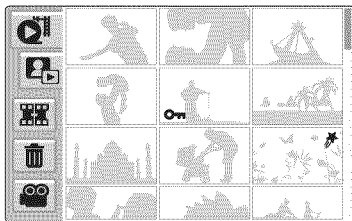

Icon	Description
	Video thumbnail view tab
	Photo thumbnail view tab
	Combine tab
	Delete tab
	Video recording mode tab

Icon	Description
	Erase protection
	My Clip

Video playback mode: Single view

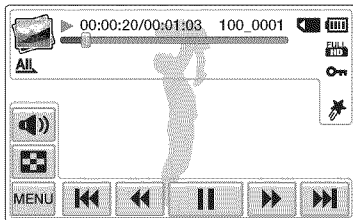

Top of the LCD screen

Icon	Description
	Video playback mode
	Operating status (playback/pause etc.)
00:00:20/00:01:03	Time code (elapsed time/recorded time)
100_0001	File name (File number)
	Storage media (memory card)
	Battery information (remaining battery level)
	Playback progress bar
	Video resolution
	Video playback option
	Erase protection
	My Clip





Bottom of the LCD screen

Icon	Description
	Volume tab
	Thumbnail view tab
	MENU tab
	Playback related function tab (skip/search/pause/playback/slow playback/frame by frame playback)

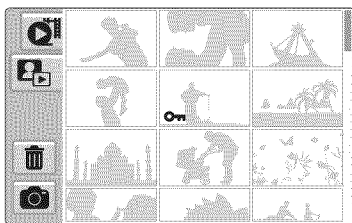
Learning icons

Photo playback mode: Thumbnail view





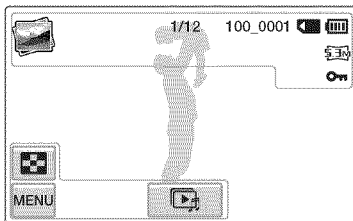

Icon	Description
	Video thumbnail view tab
	Photo thumbnail view tab
	Delete tab
	Photo recording mode tab

Icon	Description
	Erase protection



Photo playback mode: Single view



Top of the LCD screen

Icon	Description
	Photo playback mode
1/12	Photo image counter (current image/ total number of recorded images)
100_0001	File name (file number)
	Storage media (memory card)
	Battery information (remaining battery level)
	Photo resolution
	Erase protection

Bottom of the LCD screen

Icon	Description
	Thumbnail view tab
	MENU tab
	Slide show start tab

Using the Home screen

Accessing the Home screen

You can select an operating mode or access the settings menu by touching the icons on the Home screen.

Press the **[Home (🏠)]** button to access the Home screen.

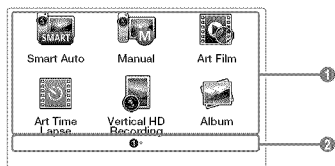
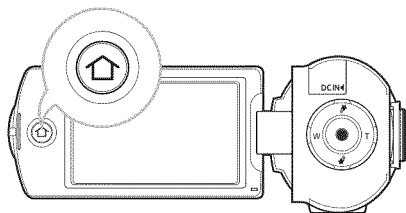

No.	Description
①	Touch an icon to access a mode or function. Drag or flick your finger on the LCD screen to move to the next page.
②	The number of the current page (①, ②)

Icons on the Home screen

Icon	Description
	Smart Auto: Record a video or photo using a scene mode selected automatically by the camcorder. ➔ page 42
	Manual: Record a video or photo using functions you set manually. ➔ pages 45~50
	Art Film: Record a video or photo using items for a fun and unique look. ➔ pages 51~52
	Art Time Lapse: Record a time lapse video using Art Time Lapse functions. ➔ pages 53~54
	Vertical HD Recording: Record a video in portrait mode. ➔ page 39
	Album: Views videos or photos using playback or editing functions. ➔ pages 56~70
	Social Sharing: Upload videos or photos to share web sites. ➔ page 76 (HMX-QF20 model only)
	Auto Backup: Send videos or photos to a PC using Auto Backup. ➔ pages 78~80 (HMX-QF20 model only)
	TV Link: View videos or photos on a TV Link-enabled TV. ➔ page 77 (HMX-QF20 model only)
	Settings: Adjust settings to match your preferences. ➔ pages 96~106

Using the grip belt

Adjust the length of the grip belt so that the camcorder is stable when you press the **[Recording start/stop]** button with your thumb.

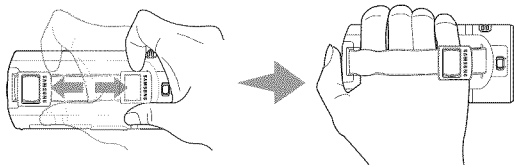

90° Vertical grip

Select **Vertical HD Recording** to record in a vertical position.

➡ page 39

Rotate your camcorder to the vertical position.

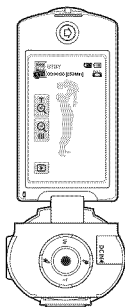

180° Switch grip

The camcorder is designed so you can use it conveniently with either your right or left hand. If you want to use this function, set **Switch Grip** to **On** in the Settings menu. ➡ page 105

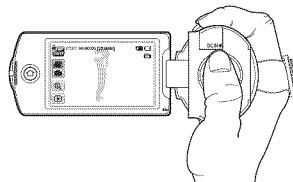

<When you hold the camcorder with your right hand>

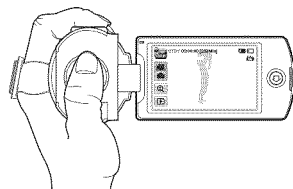

<When you hold the camcorder with your left hand>



- If you make the grip belt too tight and use excessive force to insert your hand, the grip belt hook of the camcorder may be damaged.
- When you change the Switch Grip direction while recording, the recording may be temporarily interrupted.



Basic functions

Learn about basic functions for video and photo shooting.

Recording videos	37
Recording videos in portrait mode	39
Tagging great moments while recording (My Clip function)	40
Recording photos	41
Recording with ease for beginners (SMART AUTO)	42
Zooming	43

Recording videos

Learn how to record videos easily and quickly in the video recording mode.

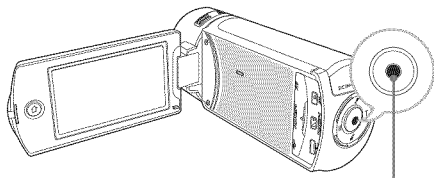

[Recording start/stop] button

- 1 In STBY mode, touch the Video recording mode (📹) tab.

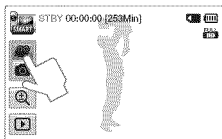

- 2 Select a subject to record.

- Adjust the LCD screen to the best angle for recording.
- Use the [Zoom (T/W)] button or Zoom (🔍) tab on the LCD screen to adjust the size of the subject. → page 43

- 3 Press the [Recording start/stop] button.

- The recording (●) icon appears and recording starts.



- 4 To stop recording, press the [Recording start/stop] button again.



Recording pause/resume

The camcorder allows you to pause temporarily while recording a video. With this function, you can record your favorite scenes as a single video.

Touch the Pause (⏸) tab to pause while recording. Touch the Recording (●) tab to resume.

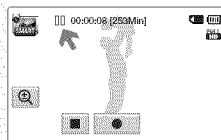

Recording videos



- If the power is interrupted or an error occurs during recording, the video may not be recorded/edited.
- Samsung is not responsible for any damage caused by a failure of normal recording or playback operation because of memory card error.
- Note that damaged data cannot be recovered.
- Do not turn off the camcorder or remove the memory card while accessing the storage media. Doing so may damage the storage media or the data in the storage media.



- Videos are compressed in the H.264 (MPEG-4.AVC) format.
- Eject the battery when you have finished recording to prevent unnecessary battery power consumption.
- For the on-screen information display, see page 30.
- For approximate recording time, see page 19.
- Sound is recorded by the internal stereo microphone located on the front of the camcorder. Make sure that the microphone is not blocked.
- Before recording an important video, make sure to test the recording function to see if there are any problems with the audio or video recording.
- For various functions available during recording, see pages 45~54.
- If the power cable/battery is disconnected or recording is disabled during recording, the system is switched to the data recovery mode. While data is being recovered, no other function is enabled. When the recording time is short, the data recovery might fail.
- You can adjust the brightness of the LCD screen in the menu options. Adjusting the LCD screen does not affect the image being recorded. ➔ page 101
- The menu setting tabs shown on the LCD screen do not affect the image being recorded.
- The [Home (🏠)] button cannot be used during video recording.
- Recording videos in a quiet environment increases microphone sensitivity that may record surrounding ambient noise. The increasing microphone sensitivity can let the camcorder record zoom noises during zooming (the sound of the zoom mechanism etc).
- When you record indoors or in the dark places, ISO sensitivity is automatically adjusted. If the recording environment is too dark, this can cause interference effects on images and prevent images from being recorded correctly. We recommend you use a professional camcorders such as an infrared camcorder when recording at night.
- Images can be distorted if the OIS Duo function is enabled and the camcorder is mounted on a tripod or fixed in place. Turn off the OIS Duo function when the camcorder is mounted on a tripod.

Recording videos

Recording videos in portrait mode

The camcorder can record videos in portrait mode. Set your camcorder to the vertical position.

- 1 Press the [Home (⏠)] button → touch **Vertical HD Recording**.

- The camcorder switches to portrait mode (vertical position).

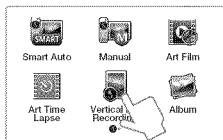

- 2 Rotate the camcorder to 90° for vertical recording.

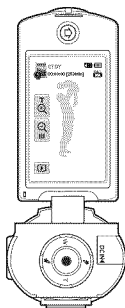

- 3 Select a subject to record.

- 4 Press the [Recording start/stop] button.

- The recording (●) icon appears and recording starts.

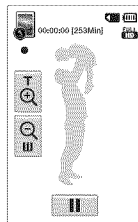

- 5 To stop recording, press the [Recording start/stop] button again.



In portrait mode, you can record videos in Full HD (1920x1080/60i) resolution only.

Recording videos

Tagging great moments while recording (My Clip function)

Using the My Clip function, you can tag good scenes while recording, and then extract the scenes tagged as My Clip (👉) from a long video later for viewing.

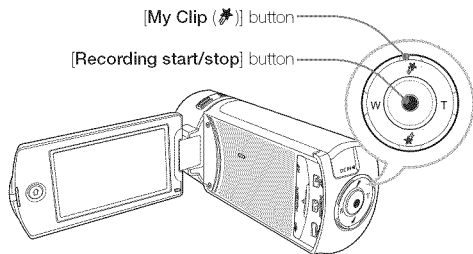

- 1 In STBY mode, touch the Video recording mode (📹) tab.

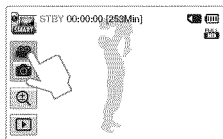

- 2 Select a subject to record.
- 3 Press the [Recording start/stop] button.
 - The recording (●) icon appears and recording starts.
- 4 Press the [My Clip (👉)] button every great moment while recording.

- The camcorder tags the scene as My Clip (👉).



- 5 To stop recording, press the [Recording start/stop] button again.

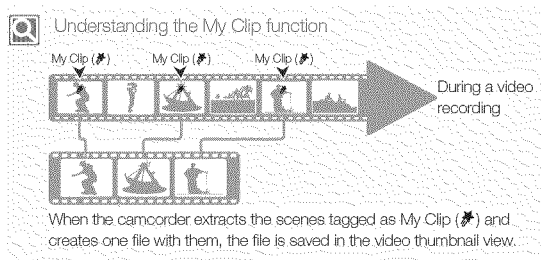

- The camcorder tags the scene so that it starts 3 seconds before you pressed the [My Clip (👉)] button and ends 5 seconds after. You can also tag any scenes in a video by pressing the [My Clip (👉)] button during a video playback. → page 60
- To skip boring parts of a video and enjoy exciting parts, you can combine the tagged scenes sequentially. → page 66
- The camcorder can tag up to 999 scenes from a video as My Clip (👉) scenes.

Recording photos

Learn how to capture photos easily and quickly in the photo recording mode.

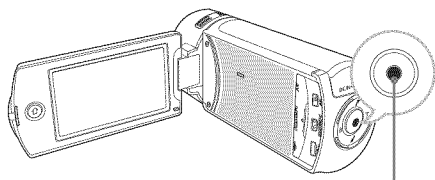

[Recording start/stop] button

- 1 In STBY mode, touch the Photo recording mode (📷) tab.

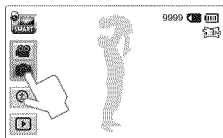

- 2 Select a subject to record.

- Adjust the LCD screen to the best angle for recording.
- Use the [Zoom (T/W)] button or Zoom (🔍) tab on the LCD screen to adjust the size of the subject. ➡ page 43

- 3 Center the subject in the LCD screen, and then press the [Recording start/stop] button.

- The shutter sound is heard and the photo is recorded.



Do not turn off the camcorder or remove the memory card when taking photos as it may damage the storage media or data.



- The recordable number of photos varies depending on the photo resolution. ➡ page 19
- The camcorder does not record audio when you take photos.
- You can adjust the brightness of the LCD screen in the menu options. Adjusting the LCD screen does not affect the image being recorded. ➡ page 101
- For on-screen display information, see page 31.
- For various functions available during recording, see pages 45~52.
- Photo files conform to the DCF (Design rule for Camera File system) standard, established by JEITA (Japan Electronics and Information Technology Industries Association.)

Recording with ease for beginners (SMART AUTO)

User-friendly SMART AUTO optimizes your camcorder to the recording conditions automatically, providing beginners with the best performance.

1 Press the [Home (🏠)] button → touch **Smart Auto**.

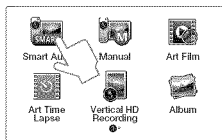

2 Align your subject in the frame.

- The camcorder automatically detects the scene (Landscape, etc.) and adjusts the camcorder settings accordingly.
- The appropriate scene icon appears on the LCD screen.



3 To record the video or photo, press the [Recording start/stop] button.

Icon	Description
	Appears when the camcorder fails to recognize the recording situations.
	Appears when recording at night. (Night)
	Appears when recording images of landscapes with backlighting. (Backlight)
	Appears when recording people. (Portrait)
	Appears when recording a very bright scene. (White)
	Appears when recording an outdoor scene. (Landscape)
	Appears when recording images using close-up. (Macro)
	Appears when recording images of clear skies. (Blue sky)
	Appears when recording images of forested areas. (Natural green)
	Appears when recording images of sunsets. (Sunset)



- Most settings are automatically adjusted in the Smart Auto mode. To set or adjust functions on your own, select **Manual** on the Home screen.
- The camcorder may not select the correct scene depending on shooting conditions, such as camcorder shake, lighting, and distance to the subject.
- The camcorder may not detect the portrait mode depending on the orientation or the brightness of faces.

Zooming

This camcorder allows you to record using optical X20 zoom and digital X40 zoom by pressing the **[Zoom (T/W)]** button or touching the Zoom () tab on the LCD screen.

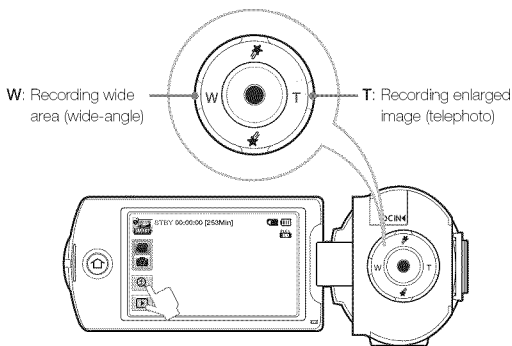



To zoom in

Press the **[Zoom (T)]** button (telephoto). Or touch the Zoom () tab, and then touch the Telephoto () tab.

- The distant subject is gradually magnified.
- The highest zoom magnification ratio is X20 in the normal zoom-in.

To zoom out

Press the **[Zoom (W)]** button (wide-angle). Or touch the Zoom () tab, and then touch the Wide-angle () tab.

- The subject gets smaller and further away.
- The smallest zoom ratio is the subject's original size in the zoom-out.



Example of zoom-in/out

T: Telephoto



W: Wide-angle



- Using the optical zoom function does not degrade the image quality and clarity.
- Use the digital zoom function when you want to zoom more than the optical zoom range. [▶ page 98](#)
- Focusing may become unstable when you record with a fast zoom or zoom into a subject standing too far away. If this occurs, use the manual focus function. (Video recording mode only) [▶ page 48](#)
- The minimum distance you can have between the camcorder and subject while maintaining sharp focus is about 1cm (about 0.4 inches) for wide angle and about 1m (about 40 inches) for telephoto. If you want to shoot the subject close to the lens at a wide angle, use the Tele Macro function. [▶ page 97](#)
- Frequent use of the zoom function consumes more power.
- The camcorder can record the sound of the zoom mechanism.
- The Zoom () tab on the LCD screen moves slowly and the **[Zoom (T/W)]** button moves more quickly. Use the Zoom () tab on the LCD screen to use the zoom function with accuracy.



Extended functions

Learn how to record a video and photo by selecting a mode.

Using the Manual modes	45
White Balance	45
EV (Exposure Value).....	46
Back Light	47
Focus	48
Super C.Nite	49
Self Timer.....	50
Cont. Shot	50
Using the Art Film modes.....	51
Fader	51
Digital Effect	52
Using the Art Time Lapse mode.....	53

Using the Manual modes

White Balance

The color of your image depends on the type and quality of the light source. If you want the color of your image to be realistic, select a white balance setting that matches the kind of light illuminating your scene (Fluorescent, Tungsten, Daylight, etc.).

- 1 Press the [Home (🏠)] button → touch **Manual** → **White Balance** (📷) tab.
- 2 Touch the desired submenu item.

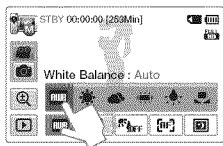

Icon	Description
	Auto: Adjusts the white balance automatically according to the recording conditions.
	Daylight: Use outdoors in normal daylight. Adjusts the white balance according to outdoor lighting conditions.
	Cloudy: Use when recording in the shade or cloudy weather.
	Fluorescent: Use when recording under white fluorescent lights.
	Tungsten: Use when recording under halogen lamps and incandescent lights.
	Custom WB: Manually adjust the white balance to match the light source or situation.

To set the white balance manually

- 1 In Manual mode, touch **White Balance** (📷) tab → **Custom WB** (📷) tab.
 - The **Set White Balance** icon appears.
- 2 Fill the screen with a white object, and then touch the **OK** tab.
 - The white balance setting is stored.
 - The stored white balance setting will be applied the next time you record.

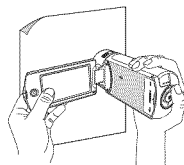

- When setting the white balance manually, the subject must be white, otherwise, your camcorder may not detect an appropriate setting value.
- The adjusted setting remains until you set the white balance again.
- During normal outdoor recording, setting to **Auto** may provide better results.
- Cancel the digital zoom function for clear and precise setting.
 - ➔ page 98
- Reset the white balance if light conditions change.

Using the Manual modes

EV (Exposure Value)

Depending on the intensity of the ambient light, your videos and photos may be too bright or dark. In these cases, you can adjust the exposure to get a better videos and photos.

- 1 Press the [Home ()] button → touch **Manual** → **EV** () tab.
- 2 Touch the / tab to adjust the setting values.
 - The setting values range from -2.0 to +2.0

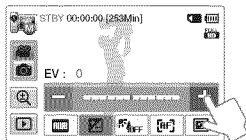

Understanding EV (Exposure Value)

Exposure value is the total amount of light allowed to fall on the photographic medium (Image sensor) during the process of taking photos or videos. The higher the number, the greater the exposure. For example, +0.3 lets in more light than -0.3.



EV: 0

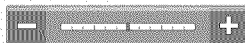

Using the Manual modes

Back Light

When a subject is lit from behind, this function compensates for back lighting so that the subject does not appear too dark.

- 1 Press the [Home (🏠)] button → touch **Manual** → **Back Light** (🔦) tab.
- 2 Touch the desired submenu item.

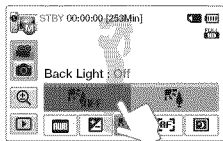

Icon	Description
	Off: Disables the function.
	On: Backlight compensation brightens the subject.



Back lighting causes the subject to be darker than the background.

It typically occurs when:



- The subject is in front of a window.
- The person you want to record is wearing white or shiny clothes and is placed against a bright background. The person's face is too dark to distinguish his/her features.
- The subject is outdoors and the background is overcast.
- The light sources are too bright.
- The subject is in front of a snowy background.









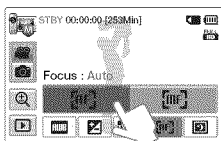

Using the Manual modes

Focus

The camcorder usually focuses on a subject automatically (auto focus). When you turn the camcorder on, focus is always set to automatic. You can also set the focus manually.

- 1 In STBY mode, touch the Video recording mode () tab.
- 2 Press the [Home ()] button → touch **Manual** → **Focus** () tab.
- 3 Touch the desired submenu item.



Icon	Description
	Auto: In most situations, it is better to use the automatic focus feature, as it lets you concentrate on the creative side of your recording.
	Manual: You may need to focus manually under conditions in which automatic focusing is difficult or unreliable. To adjust the focus, place and hold your finger on the  for a nearer subject, and on the  tab for a farther subject. The nearer or farther icon ( / ) appears when focus adjustment reaches the end. The camcorder applies the adjusted value right after you touch the  or  tab.





- The Auto Focus (AF) setting is useful when you operate the zoom function because you might not be able to keep accurate focus after the zoom ratio has been changed.
- When the camcorder exits from Manual mode or switches to the photo recording mode, the Focus function is automatically set to **Auto**.



Using the Manual modes

Super C.Nite

You can adjust the shutter speed when recording a slow moving object or recording a brighter image in dark places without compromising color.

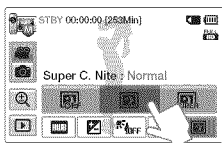
- 1 In STBY mode, touch the Video recording mode () tab.
- 2 Press the [Home ()] button → touch **Manual** → **Super C. Nite** () tab.
- 3 Touch the desired submenu item.



Icon	Description
	Off: Disables the function.
	Normal: The shutter opens for 1/60 of a second in the normal mode and automatically switches to open for 1/30 of a second in a dark place. Use this function to get bright images in a dark place.
	Super: The shutter opens for 1/60 of a second in the normal mode and automatically switches to open for 1/15 of a second in a dark place. Use this function to get bright images in a darker place.

 Images you record when using Super C.Nite may not appear smooth because the camcorder has recorded them at a low shutter speed.

Using the Manual modes

Self Timer

When the self-timer is enabled, there is a time delay of 10 seconds before recording starts. You can take photos of yourself.

- 1 In STBY mode, touch the Photo recording mode (📷) tab.
- 2 Press the [Home (🏠)] button → touch **Manual** → **Self Timer** (🕒) tab.
- 3 Touch the desired submenu item.

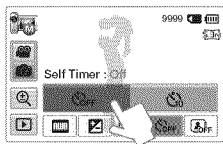

Icon	Description
🕒	Off: Disables the function.
🕒	10 Sec: There is a time delay of 10 seconds after you press the [Recording Start/Stop] button.



- The camcorder automatically turns the Self Timer function off after it has been used once. You must turn it on each time you want to use it.
- When the camcorder exits from Manual mode, the Self Timer function is automatically set to **Off**.

Cont. Shot

The Continuous Shot function lets you capture up to eight photos in rapid succession.

- 1 In STBY mode, touch the Photo recording mode (📷) tab.
- 2 Press the [Home (🏠)] button → touch **Manual** → **Cont. Shot** (👤) tab.
- 3 Touch the desired submenu item.

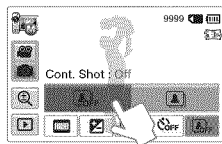

Icon	Description
👤	Off: The camcorder records only one photo image.
👤	On: When you press the [Recording start/stop] button, the camcorder can take up to 8 photos in one second.





- When an error occurs (Card Full, etc.) during continuous shot, the recording stops and an error message appears.
- When the Cont. Shot is **On**, the photo resolution is fixed at **2M 1920x1080**.
- When the camcorder exits from Manual mode, the Cont. Shot function is automatically set to **Off**.



Using the Art Film modes

Fader

You can give your recording a professional look by using special effects such as fade in at the beginning of a sequence or fade out at the end of a sequence.

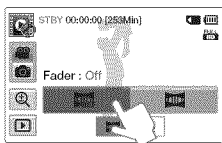
- 1 In STBY mode, touch the Video recording mode () tab.
- 2 Press the [Home ()] button → touch **Art Film** → **Fader** () tab.
- 3 Touch the desired submenu item.



Icon	Description
	Off: Disables the function.
	On: When you start or stop recording, the recording fades in or fades out accordingly.



Recording a video with Fade effect

Fade In (Approx.3 seconds)

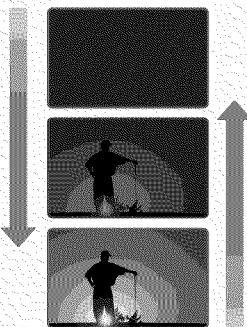

Fade Out (Approx. 3 seconds)

Fade in

With **Fader** set to **On**, press the [Recording start/stop] button. The recording starts with a dark screen, and then the image and sound fade in.

Fade out

With **Fader** set to **On**, press the [Recording start/stop] button to stop recording. The image and sound fade out, the screen goes black, and then the recording stops.



- The camcorder automatically turns the Fader function off after it has been used once. You must reset it each time you want to use it.
- When the camcorder exits from the Art Film mode, the Fader function is automatically set to **Off**.

Using the Art Film modes

Digital Effect

Using the Digital Effect function gives your recording a creative look.

- 1 Press the [Home (🏠)] button → touch **Art Film** → **Digital Effect** (🎨) tab.
- 2 Touch the desired submenu item.
 - You can view the hidden items by dragging the LCD screen left or right or touching the ⏪ / ⏩ tab.



You can also apply digital effects in order easily by shaking the camcorder in the Art Film mode. You do not need to set the Digital Effect function manually. →page 98.

Icon	Description
	Off: Without any Digital Effect, a normal, natural image is displayed during recording or playback.
	Black & White: This mode changes the image to black and white.
	Sepia: This mode gives the image a reddish brown look.
	Negative: This mode reverses the colors, creating a negative image.
	Art: This mode helps adjust for facial imperfections.
	Noir: This mode creates a stronger image by increasing contrast.
	Western: This mode creates a faded and old film vintage look.
	Dazzle: This mode creates a brighter image by increasing color saturation.
	Ghost: This mode creates a drawn out image effect like an apparition or ghost. (Video recording mode only)

Using the Art Time Lapse mode

Using the Art Time Lapse function, you can set the camcorder to add emotion and something different experience on a dry and boring time lapse video.

- 1 In STBY mode, touch the Video recording mode (📹) tab.
- 2 Press the [Home (🏠)] button → touch **Art Time Lapse**.
- 3 Touch the desired menu.

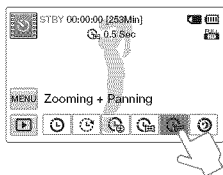

- 4 Touch the MENU (MENU) tab.
- 5 Touch the desired submenu.

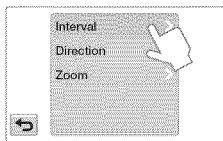

- 6 Touch the desired submenu item.
- 7 After setting the Art Time Lapse mode, press the [Recording start/stop] button.
 - The Art Time Lapse recording starts.

- In Art Time Lapse mode, you can record videos in 1920x1080/30p resolution only.
- Press the [Recording start/stop] button if you want to stop the Art Time Lapse mode.

Icon	Description
	Normal: Set to record frames at an interval that you define. <ul style="list-style-type: none">• Interval: An image of a scene is captured once every 0.1, 0.5, 1, 3, or 5 seconds.
	Jumping: Set to record frames of a jumping time lapse video at an interval that you define. <ul style="list-style-type: none">• Interval: The scene is recorded for 3 seconds in every 1, 3, 5, 10, or 20 seconds. Audio is also recorded.
	Zooming: Set a zoom effect for a time lapse video. <ul style="list-style-type: none">• Interval: An image of a scene is captured once every 0.1, 0.5, 1, 3, or 5 seconds.• Zoom: Adds the zoom in/out effect to a time lapse video.
	Panning: Set a panning effect for a time lapse video. <ul style="list-style-type: none">• Interval: An image of a scene is captured once every 0.1, 0.5, 1, 3, or 5 seconds.• Direction: Adds the panning effect (left/right/up/down) to a time lapse video.
	Zooming + Panning: Set a zoom and panning effect to add them simultaneously. <ul style="list-style-type: none">• Interval: An image of a scene is captured once every 0.1, 0.5, 1, 3, or 5 seconds.• Direction: Adds the panning effect (left/right/up/down) to a time lapse video.• Zoom: Adds the zoom in/out effect to a time lapse video.
	Night: Set night motion for a time lapse video.

Using the Art Time Lapse mode

Example of Art-Time Lapse recording

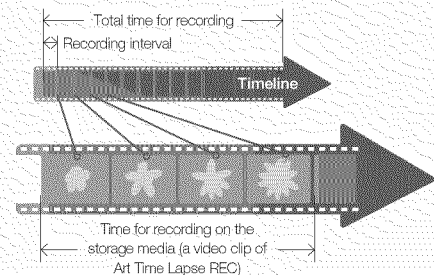

The Art Time Lapse function records image frames at a predefined interval over the total recording time to produce a time-lapse video.

Art Time Lapse is useful for filming the following subjects:

- Blooming flowers
- A bird building a nest
- Clouds rolling by in the sky

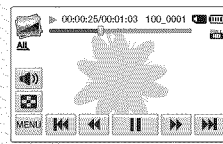
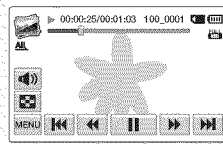
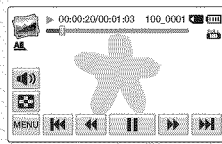
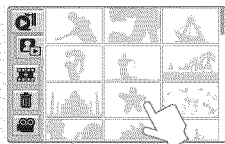

- During Art Time Lapse recording, the Super C.Nite function does not work.
- Art Time Lapse recording is turned off once recording is finished. To start another Art Time Lapse mode, repeat steps 1 to 7.
- 30 captured images compose a video of 1 second length. Since the minimum length of a video that your camcorder can save is one second, the interval defines the total minimum recording time for the Art Time Lapse mode. For example, if you set the interval to **5 Sec**, you need to set the recording time for the Art Time Lapse mode to at least 2 minutes and 30 seconds to record a minimum video length of 1 second (30 images).
- You cannot pause recording during Time lapse recording.
- Audio is not recorded during Art Time Lapse recording. (Audio is recorded only during Jumping recording in Art Time Lapse mode.)
- The maximum video file size is 1.8GB. When a video file exceeds 1.8GB, a new video file is created automatically.
- We recommend using the power adaptor instead of the battery for Art Time Lapse.
- If the battery charge is exhausted during Art Time Lapse recording, the camcorder saves recording up to that point and switches to standby mode. After a while, it displays a warning message, and then turns off automatically.
- If the storage media becomes full during Art Time Lapse recording, the camcorder switches to the standby mode after saving the recording up to the maximum memory available.
- During Art Time Lapse recording, the Switch Grip function does not work.



Playback/Editing



Learn how to play back and edit videos and photos.

Viewing videos or photos in playback mode.....	56
Starting the playback mode.....	56
Playing back videos	57
Tagging great moments during playback.....	60
Viewing photos	61
Editing videos or photos	63
Share (HMX-QF20 only)	63
Delete	65
Delete My Clip	66
My Clip Creation	66
Protect	67
Smart BGM	67
Divide	68
Combine	69
File Info.....	70

Viewing videos or photos in playback mode

Starting the playback mode

You can switch to the playback mode by selecting **Album** on the Home screen. You can also switch the operation mode directly into the playback thumbnail display by touching the Playback () tab on the LCD screen.

- The most recently created file is highlighted in the thumbnail view.
- The camcorder selects the thumbnail display options based on the standby mode that was last used. However, you can choose the video or photo thumbnail view display options by touching the Video thumbnail view () or Photo thumbnail view () tab on the LCD screen.

Using the Playback () tab

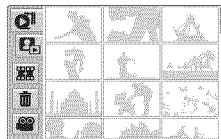
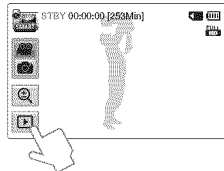

<Video thumbnail view>



<Photo thumbnail view>



Using the [Home ()] button

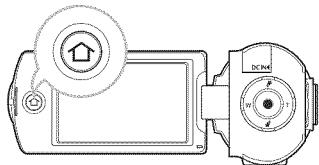

<Home screen>



<Video thumbnail view>



- You can choose the thumbnail display type you want by selecting **Thumbnail** in the Settings menu.  page 98
- You can switch the playback mode to the recording mode by pressing the [Recording start/stop] button.

Viewing videos or photos in playback mode

Playing back videos

You can preview recorded videos in the thumbnail view and find and play your desired video directly.

- 1 Select the video playback mode. ➔ page 56
- 2 Touch the thumbnail of the desired video clip.
 - The camcorder plays the video you selected.
 - If you select a video tagged as My Clip, the My Clip (👤) icon on the LCD screen appears. The color of the My Clip icon is changed for 8 seconds when the scenes tagged as My Clip appear.

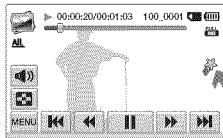
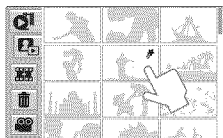

- 3 To stop playback and return to the thumbnail view, touch the Thumbnail view (🖼️) tab.



Find videos in various ways

Drag the thumbnails up or down on the LCD screen to search for the thumbnails you want.

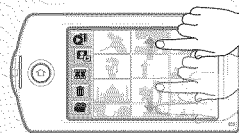

When playback is paused, drag the image left or right on the LCD screen to go to the previous or next file.

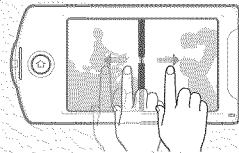

Touch a point or drag the pointer in the playback progress bar on the LCD screen left or right to move directly to the section of the video you want.

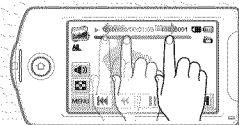

Viewing videos or photos in playback mode

- ⚠ Do not power off or eject the memory card during photo playback. Doing so may damage the recorded data.

- ✔ It may take some time to start playback, depending on the size and quality of the selected video.
- The camcorder may not play back the following video files:
 - A video recorded on another device.
 - A video whose file format is not supported by the camcorder.
- You can use various playback options during the video playback.
➔ page 59
- You can set playback settings using the **Video Play Option** menu.
➔ page 98
- You can play back the recorded videos on a TV or PC.
➔ pages 82-83, 88-91
- If you touch the MENU (MENU) tab or press the [Home (🏠)] button during playback, the video playback is paused and the menu screen appears.

To adjust the volume during video playback

You can hear the sound through the internal speaker of the camcorder while the video is playing back on the LCD screen.

- 1 Touch the Volume (🔊) tab on the LCD screen.

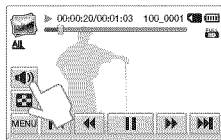

- 2 Touch the [-] / [+] tab to increase or decrease audio volume.

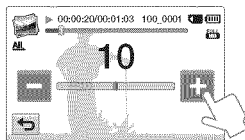

- ✔ The sound level is adjusted between 0-20. When the level is at 0, you cannot hear sound.
- When the camcorder is connected to a TV, you will not hear the sound from the speaker on the camcorder.

Viewing videos or photos in playback mode

Playback/Pause/Stop

- Playback and pause alternate when you touch the Playback (▶) / Pause (⏸) tab during playback.
- Touch the Thumbnail view (🖼️) tab to stop playback and return to the thumbnail.

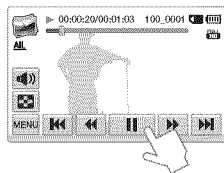

Search playback

During playback, touching the Reverse search (⏮️) / Forward search (⏭) tab increases the playback speed:

- For RPS (Reverse Playback Search) / FPS (Forward Playback Search), each touch changes the speed in the following order: $x2 \rightarrow x4 \rightarrow x8 \rightarrow x2$

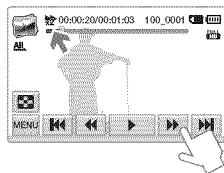

Skip playback

Touch the Reverse skip (⏮️) / Forward skip (⏩) tab during playback.

- Touching the Forward skip (⏩) tab plays the next video.
- Touching the Reverse skip (⏮️) plays the beginning of the scene. If reverse skip (⏮️) is touched within 3 seconds from the start of the file, the previous video plays.
- Place and hold your finger on the Reverse skip (⏮️) / Forward skip (⏩) tab to search for a video quickly. When you lift off your finger, the selected video plays.

Slow playback

When playback is paused, touching the Reverse slow (⏪) / Forward slow (⏩) tab reduces the playback speed:

- For Reverse/forward slow playback, each touch changes the speed in the following order: $x1/2 \rightarrow x1/4 \rightarrow x1/8 \rightarrow x1/2$

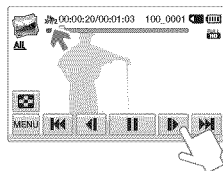

Frame by frame playback

When playback is paused, touching the Reverse frame advance (⏮️) / Forward frame advance (⏭) tab makes playback go in reverse or forward one frame at a time.



- Touch the Playback (▶) tab to play back at normal speed.
- You can hear sound only when the playback is at normal speed.
- When playing back the My Clip tags, the search playback and slow motion playback functions do not operate.

Viewing videos or photos in playback mode

Tagging great moments during playback

You can use My Clip (👉) to tag good scenes during playback, and then view only the scenes tagged as My Clip (👉) later.

- 1 Select the video playback mode. ➔ page 56
- 2 Touch the thumbnail of the desired video clip.
- 3 Press the [My Clip (👉)] button to tag great moments during playback.

[My Clip (👉)] button

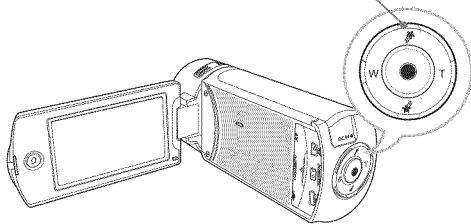

- The camcorder tags the scene as My Clip (👉).

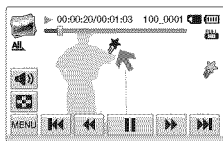

- 4 To stop playback and return to the thumbnail view, touch the Thumbnail view (🖼️) tab.



- The camcorder tags a scene 3 seconds and 5 seconds after you press the [My Clip (👉)] button.
- To skip boring parts of a video and enjoy exciting parts, you can combine the tagged scenes sequentially. ➔ page 66
- You can also tag a scene when you have paused video playback.
- You cannot use the My Clip function when a video tagged as My Clip (👉) plays back in the search playback and slow motion playback modes.
- If there is not enough storage space available in the media storage, you cannot use the My Clip function.

Viewing videos or photos in playback mode

Viewing photos

You can view recorded photos by using various playback functions.

- 1 Select the photo playback mode. ➔page 56
- 2 Touch the thumbnail of the desired photo.
 - The camcorder displays the photo you selected in full screen.

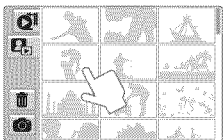

- 3 To return to the thumbnail view, touch the Thumbnail view (🗃️) tab.

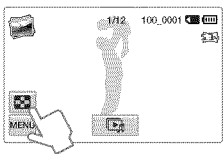

Do not power off or eject the memory card during photo playback.
Doing so may damage the recorded data.



Find photos in various ways

Drag the thumbnails up or down on the LCD screen to search for the thumbnails you want.

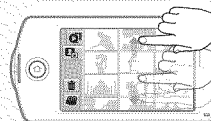

Drag the image left or right on the LCD screen to go to the previous or next file.

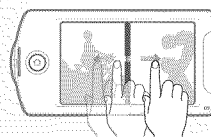

- Loading time may vary depending on the size and quality of the photo you selected.
- Your camcorder may not play back the following photo files normally:
 - A photo recorded on another device.
 - A photo with a file format not supported by this camcorder. (One that does not conform to DCF standards.)

Viewing videos or photos in playback mode

Viewing a slide show

You can view a photo slide show with background music.

- 1 Touch the Slide show () tab during photo playback.
 - The slide show starts from the current selected photo.
 - To pause the slide show, touch the LCD screen anywhere.

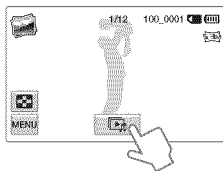

- 2 To stop the slide show, touch the Return () tab.

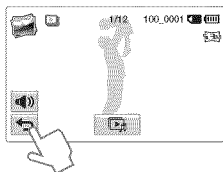

- All photos are played back depending on the slide show option function. [▶ page 101](#)
- You can adjust the background music's volume level using the Volume () tab.

Zooming during photo playback

You can magnify a playback image.

- 1 Touch the desired photo.
- 2 Adjust the magnification with the [Zoom (T/W)] button.
 - Magnification starts from the center of the photo.
 - You can zoom in from X1.1 to X8.0.
- 3 Drag the LCD screen up/down/left/right to view the area you want on the magnified photo.

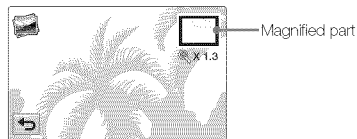

- 4 To cancel, touch the Return () tab.

- Photos recorded on other devices or those edited on a PC cannot be magnified.
- While the playback zoom is in use, the other images cannot be selected.

Editing videos or photos

Share (HMX-QF20 only)

During video or photo playback, you can upload the video or photo you are viewing to a sharing web site.

Sharing videos

- 1 Select the video playback mode. ➔ page 56
- 2 Touch a video recorded in the Web/HD resolution.
 - The camcorder plays the video you selected.
- 3 Touch the MENU (MENU) tab.

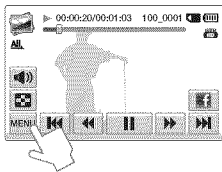

- 4 Touch Share.



- 5 Touch the desired submenu item.

Item	Description
Facebook	The camcorder searches for available AP devices and accesses Facebook to upload the video. ➔ page 76
YouTube	The camcorder searches for available AP devices and accesses YouTube to upload the video. ➔ page 76



Using the Share tab

You can access the last connected sharing web site by touching the Share tab on the right side of LCD screen. The Facebook (f) tab is the defaulting setting.

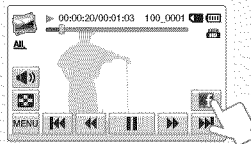

- You cannot share videos recorded in the Full HD (1920x1080/60i) and HD (1280x720/60p) resolutions.
- You cannot upload videos to Picasa.

Editing videos or photos

Sharing photos

- 1 Select the photo playback mode. ➔ page 56
- 2 Touch the thumbnail of the desired photo.
 - The camcorder displays the photo you selected in full screen.
- 3 Touch the MENU (MENU) tab.

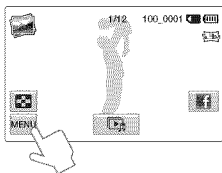

- 4 Touch Share.



- 5 Touch the desired submenu item.

Item	Description
Facebook	The camcorder searches for available AP devices and accesses Facebook to upload the photo. ➔ page 76
Picasa	The camcorder searches for available AP devices and accesses Picasa to upload the photo. ➔ page 76



Using the Share tab

You can access the last connected sharing web site by touching the Share tab on the right side of LCD screen. The Facebook (f) tab is the defaulting setting.

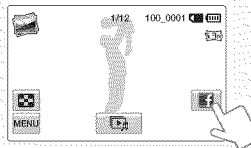

You cannot upload photos to YouTube.

Editing videos or photos

Delete

You can erase your recordings one by one or all at once.

1 Select the video or photo playback mode. ➔page 56

2 Touch the Delete (🗑️) tab on the thumbnail view.

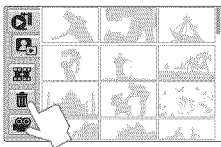

3 Touch thumbnails.

- The selection (✓) indicator appears on the selected files. Whenever you touch the thumbnail file, selection (✓) and release alternate.
- To delete all the files, touch the Select all (👤) tab. The selection (✓) indicator appears on all the thumbnails.
- To release the selection (✓) indicator for all photos at once, touch the Clear (🗑️) tab.

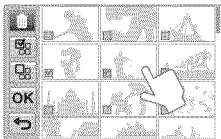

4 Touch the OK tab.

- A message appears asking for your confirmation.

5 Touch Yes.

- The camcorder deletes all the files having the selection (✓) indicator.



- Deleted images cannot be recovered.
- Do not eject a memory card or power off while deleting videos recorded on the storage media. Doing so may damage the storage media or data.



- You can also operate this function in the full and single image display mode.
- To protect important images from accidental erasure, activate the image protection function in advance. ➔page 67.
- You cannot delete protected files. Cancel the protect function first. ➔page 67.
- If the write protection tab on the memory card is set to lock, you cannot delete files. ➔page 17.
- The delete function does not work if the battery charge is insufficient. We recommend you use AC power to provide continuous power during the deletion.

Editing videos or photos

Delete My Clip

You can delete the My Clip tags from a video tagged as 'My Clip'.

- 1 Select the video playback mode. ➡ page 56
- 2 Touch a thumbnail tagged as My Clip (✳).
- 3 Touch the MENU (MENU) tab → **Delete My Clip**.



- 4 Touch **Yes**.
 - The camcorder will delete all My Clip tags from the video.

 This function is available in the video single view only.

My Clip Creation

You can extract the exciting scenes tagged as 'My Clip' from a video and create one file with them.

- 1 Select the video playback mode. ➡ page 56
- 2 Touch a thumbnail tagged as My Clip (✳).
- 3 Touch the MENU (MENU) tab → **My Clip Creation**.



- 4 Touch the desired submenu item.

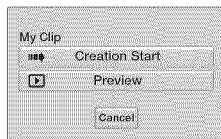

Item	Description
Creation Start	Combines the tagged scenes sequentially, and then saves the combined files as a single video file in the last file position of the video thumbnail view.
Preview	Previews the tagged scenes sequentially.



- While previewing the scenes tagged as 'My Clip', you cannot drag the progress bar on the LCD screen.
- If there is not enough storage space available in the media storage to create new files from videos tagged as 'My Clip' the **Creation Start** tab will be dimmed.



My Clip creation in the video thumbnail view.

In the video thumbnail view, the camcorder can extract and combine the tagged scenes from all videos tagged as 'My Clip' and create one file from them. The camcorder can only create a My Clip file from videos recorded in the same resolution. Press the [My Clip (✳)] button in the video thumbnail view.

[My Clip (✳)] button

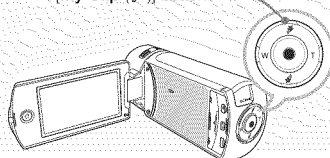

Editing videos or photos

Protect

You can protect important recordings from accidental erasure. The protected videos and photos cannot be deleted unless you format the memory card or cancel the protection.

- 1 Select the video or photo playback mode. ➔page 56
- 2 Touch a thumbnail to protect.
- 3 Touch the MENU (MENU) tab → **Protect**.

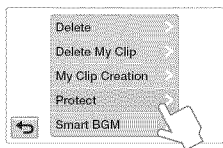

- 4 Touch the desired submenu item.

Item	Description
Off	Turns off protection on a protected image.
On	Protects the selected image.

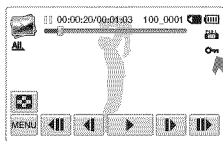

- You can operate this function in the single view only.
- If the write protection tab on the memory card is set to lock, you cannot apply this function. ➔page 17

Smart BGM

You can enjoy music during video playback. If the original sound in the video is loud, the volume of the background music will be decreased naturally. On the other hand, if the original sound in the video is quiet, the volume of the background music will be increased naturally.

- 1 Select the video playback mode. ➔page 56
- 2 Touch a video thumbnail.
- 3 Touch the MENU (MENU) tab → **Smart BGM**.

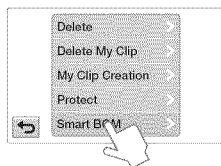

- 4 Touch the desired submenu item.

Item	Description
Off	Turns off the background music.
On	Turns on the background music.



- This function is available in the video single view only.
- You can also apply background music easily by shaking the camcorder during playback. You do not need to set the Smart BGM function manually. ➔page 101
- You can change the desired background music in the Settings menu. ➔page 98

Editing videos or photos

Divide

You can divide a video into two, and easily delete a section you no longer need. As this function edits the original file, make sure to back up the original before dividing it.

- 1 Select the video playback mode. → page 56
- 2 Touch a video thumbnail.
- 3 Touch the MENU (MENU) tab → **Divide**.

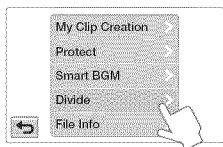

- 4 Find the point of division by touching the playback control tabs.
- Playback control tabs: [Play/Pause], [Stop], [Previous], [Next], [First], [Last]
 - Drag the playback progress bar left or right to move directly to the division point.

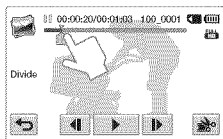

- 5 Touch the Pause (PAUSE) tab at the point of division → the Cutting (CUTTING) tab.

- A message appears asking for your confirmation.

- 6 Touch **Yes**.

- The video is divided into two video clips.
- The second portion of the divided video is displayed as the last thumbnail.
- After the division, you can partially delete unnecessary sections of the divided videos or combine them with other videos.
→ page 69



Do not eject a memory card or power off while editing a video recorded in the storage media. Doing so may damage the storage media or data.



- You can operate this function in the single view only.
- You cannot divide files that display the protect icon (PROTECT). Cancel the protect function first. → page 67.
- The beginning or end of the divided videos may drift by approx. 2 seconds before or after the division point.
- The Divide function is not available under the following conditions:
 - If the total recorded time of the video is less than 6 seconds.
 - If you try to divide sections without leaving 3 seconds at the beginning and the end.
 - If the remaining section of the memory space is less than 15MB.
- When the number of files reaches 9999.
- This function is available in the video single view only.
- You cannot divide videos recorded in the Web/HD resolution.
- When you divide a video with My Clip tags, the My Clip tags disappear.
- You cannot divide a video recorded in Art Time Lapse mode.



Editing videos or photos

Combine

You can combine two different videos. As this function edits the original files, make sure to back up the original files before combining them.

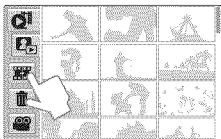
- 1 Select the video playback mode. → page 56
- 2 Touch the Combine () tab on the thumbnail view.



- 3 Touch the video thumbnails in the order you want them combined.
 - The selection () indicator and the order number appear on the selected videos. When you touch a video thumbnail, selection () and release alternate.
 - The checkbox on the video thumbnail does not appear if the video files have different resolutions.

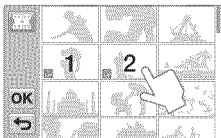

- 4 Touch the **OK** tab.
 - A message appears asking for your confirmation.
- 5 Touch **Yes**.
 - The camcorder combines the video files you selected in the order you designated, and then stores the combined videos as a single video file.



Do not eject a memory card or power off while editing a video recorded on the storage media. Doing so may damage the storage media or data.



- You cannot combine the files that are protected () . Cancel the protect function first. → page 67.
- The original videos are not preserved.
- The Combine function is not available under the following conditions:
 - If the Videos are in different resolution formats. For example, videos recorded at **Video Resolution: Full HD 1080/60i** and **Video Resolution: HD 720/60p** cannot be combined.
 - If the file size of the combined videos exceeds 1.8 GB.
 - If the remaining memory space on your memory card is less than 15MB.
 - If a video file format is not supported by the camcorder.
 - While the camcorder is playing a video file.
- You cannot combine videos recorded in the Web/HD resolution.
- When you combine a video with My Clip tags, the My Clip tags disappear.
- You cannot combine a video recorded in Art Time Lapse mode.

Editing videos or photos

File Info

You can see image information for each image.

- 1 Select the video or photo playback mode. → page 56
- 2 Touch a thumbnail.
- 3 Touch the MENU () tab → **File Info**.
 - The information for the selected file appears.

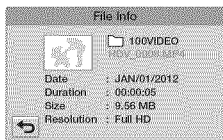

- 4 To exit the menu, touch the Return () tab.



Wireless network (HMX-QF20 only)

Learn to connect to wireless local area networks (WLANs) and use functions.

Connecting to a WLAN and configuring network settings..	72
Connecting to a WLAN	72
Configuring the network settings.....	73
Manually setting the IP address	74
Network connection tips	75
Entering text	75
Using video or photo sharing web sites.....	76
Accessing a web site.....	76
Uploading videos or photos.....	76
Viewing videos or photos on a TV Link-enabled TV.....	77
Using Auto Backup to send videos or photos	78
Installing the program for Auto backup on your PC	78
Sending photos or videos to a PC	78
About the Wakeup on LAN (WOL) feature	79

Connecting to a WLAN and configuring network settings

Connecting to a WLAN







You can connect to a WLAN using an AP (access point) in the wireless network service area.

- 1 Press the [Home (🏠)] button → touch **Social Sharing**.
 - To begin this process, you must have some video or photo files stored in the camcorder's memory card that you have not uploaded to a social network or photo/video file management site.
- 2 Touch the Wi-Fi setting (📶) tab on the bottom left.
 - The camcorder automatically searches for and then displays available AP devices.
 - If the desired AP is not on the AP devices list, drag the list down to the bottom, and then touch **Add Wi-Fi Network** to input and then search for the desired AP name manually.
- 3 To select an unsecured AP or an AP that requires a password, touch the AP. If you selected an unsecured AP, go to Step 7. If you selected an AP that requires a password, go to Step 4.





To select a WPS supported AP, touch the ➡ tab next to the AP, and then go to Step 5.

 - You can also connect to a WPS supported AP by dragging the list of APs down to the bottom, touching **WPS PBC**, and then pressing the [WPS] button on the AP device.
- 4 The virtual keyboard appears. Input the required password using the virtual key board. ➡ page 75
When done, press **OK**, and then go to Step 7.

- 5 The Wi-Fi Setting screen appears. Scroll to the bottom of the screen, and then touch **WPS PIN**.
- 6 Record the PIN code displayed on the screen, and then enter the PIN code at the Wi-Fi access point within two minutes.
- 7 The camcorder connects to the network you have chosen.

Icon	Description
	Ad hoc AP
	Secured AP
	WPS AP
	Signal strength
	Wi-Fi setting options
	Refreshing connectable APs

 You can check the signal strength in the top right corner of the screen.

Icon	Signal strength
	Not connected
	Very weak
	Weak
	Normal
	Very strong

Connecting to a WLAN and configuring network settings

Configuring the network settings

You can configure network settings manually. Note that configuring these settings manually is not necessary in most cases. If your camcorder connected to the network after you followed the directions on page 72, your camcorder has adjusted these settings and you do not need to configure them manually.

- 1 Press the [Home (🏠)] button → touch **Social Sharing**.
- 2 Touch the Wi-Fi setting (📶) tab.
 - The camcorder automatically searches for available AP devices.
- 3 Touch the ▶️ tab next to an AP.

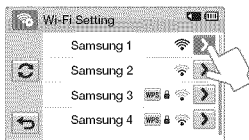

- 4 Touch each submenu and enter the required information.

Item	Description
Authentication	Select an authentication type according to your AP's setting. When you select Open or Shared , WPA is automatically set.
Data Encryption	Select an encryption type according to your AP's setting.
Network Password	Enter the password using the virtual keyboard. ➡ page 75
IP Setting	The default is Auto . You can select Manual to set the IP address manually.

- 5 Touch the **OK** tab.

- The camcorder connects to the network via the selected AP.



- Even if AP authentication and Data Encryption have been detected, set the authentication mode to **Open** or **Shared**.
- If the camcorder does not detect the AP automatically, you can set the network properties directly. ➡ page 74
- Data encryption settings by authentication type are below:
 - **Open** → **Disabled** or **WEP**
 - **Shared** → **WEP**
 - **WPA-PSK** → **TKIP, AES, or TKIP/AES Mixed**
- When the Data Encryption function is set to **WEP** or **TKIP** for 802.11n AP connection, you can access in the 802.11g mode. In the 802.11g mode, the network connection and speed are not guaranteed.

Connecting to a WLAN and configuring network settings

Manually setting the IP address

By entering the IP address, you can connect to a WLAN via an AP (access point) in the wireless network service area.

- 1 Press the [Home (🏠)] button → touch **Social Sharing**.
- 2 Touch the Wi-Fi setting (📶) tab.
 - The camcorder automatically searches for available AP devices.
- 3 Touch the ▶ tab next to an AP.
- 4 Touch **IP Setting** → **Manual**.

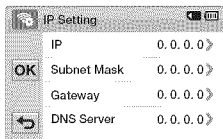

- 5 Touch each submenu item and then enter the required value using the virtual keyboard. ↪page 75

Item	Description
IP	Enter the static IP address.
Subnet Mask	Enter the subnet mask.
Gateway	Enter the gateway.
DNS Server	Enter the DNS address.

- 6 Touch the **OK** tab.
 - The camcorder connects to the network via the selected AP.



- For more information about the network settings, contact the network administrator or the service provider.
- The network settings may differ, depending on network conditions.
- Do not try to connect to a network that you have no permission to access.
- Use a fully charged battery while you are using network services.

Connecting to a WLAN and configuring network settings

Network connection tips

- Compatibility with an AP that has not been formally Wi-Fi certified cannot be guaranteed.
- The wireless network connection may not be stable, depending on the connected AP.
- When the distance from AP is large, the network connection takes longer and video stuttering may occur.
- If there is a device using the same frequency range as the network near the camcorder, you may experience wireless interference.
- If an AP device is named in a language other than English, it may not be displayed in the AP list or, if it is, it may appear in a corrupted format or font.
- For the network settings and password, contact the network administrator or the service provider.
- The letters and numbers used in passwords may differ, depending on the encryption type.
- You may not be able to connect to the wireless network, depending on the conditions.
- The AP search may find a printer that supports the wireless network, but you cannot use the printer to connect to the network.
- The service provider may charge you a fee for the wireless connection under the contract made between you and the service provider.
- Channels available for networking differ according to the region (country).
- Some countries may restrict wireless networking under local radio regulation laws. We recommend you connect your camcorder to networks only inside the country where you purchased it.
- If your AP name is not in English, the camcorder may not be able to locate the device or the name may appear incorrectly.
- If a WLAN requires authentication from the service provider, you may not be able to connect to it. To connect the WLAN, contact your network service provider.
- If you cannot connect to a WLAN, try another AP from the available AP list.
- You can also connect to free WLANs in some foreign countries.
- A login page may appear when you select free WLANs provided by some network service providers. Enter your ID and password to connect to the WLAN. For information about registering or the service, contact the network service providers.

- Be cautious when you enter personal information for an AP connection. Do not enter any payment or credit card information on your camcorder. The manufacturer is not liable for any problem caused by entering such information.

Entering text

You can use the virtual keyboard to enter your information and settings. Touch the desired characters, numbers, or symbols.

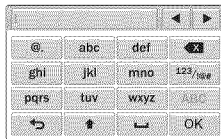

Item	Description
◀ ▶	Move the cursor.
@.	Enter '@'.
X	Delete the last letter.
123/!@#	In ABC mode, switch to 123 mode. In 123 mode, switch to symbol mode.
ABC	Switch to ABC mode.
↶	Return to the previous screen.
↑	In ABC mode, change the case.
␣	Enter a space.
OK	Save the displayed text.



- You can enter the information only in English, regardless of the language settings.
- You can enter up to 99 characters in the text field.

Using video or photo sharing web sites

Accessing a web site

- 1 Press the [Home (🏠)] button → touch **Social Sharing**.
- 2 Select a web site.
 - The camcorder will automatically attempt to connect to a WLAN via the most recently connected AP device.
 - If the camcorder has not previously been connected to a WLAN, it will search for available AP devices. ➤page 72

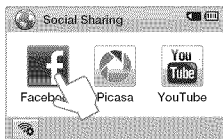

- 3 Enter your ID and password, and then touch the Login (Login) tab.
 - For information about entering text, refer to 'Entering text'. ➤page 75
 - To select an ID from the list, touch ▼ → an ID.
 - You may be logged in automatically, if you have previously logged in to the web site.

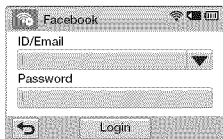

 You must have an existing account on the file sharing web site to use this feature.

Uploading videos or photos

- 1 Access a sharing web site with your camcorder.
- 2 Touch files → the **OK** tab.
- 3 Touch the Comment box → input your comments.
- 4 Touch the Upload (Upload) tab.

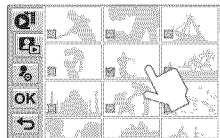

- The method of uploading videos or photos may differ depending on the selected web site.
- If you cannot access a web site because of firewall or user authentication settings, contact your network administrator or network service provider.
- The speed of your internet connection may affect how quickly videos or photos upload or web pages open.
- When there are no files in the camcorder memory, you cannot use this function.

Viewing videos or photos on a TV Link-enabled TV

View your videos or photos on a TV that supports the TV Link function. Your camcorder acts as a server and you can search for shared videos or photos with the TV remote control.

- 1 Press the [Home (🏠)] button → touch **TV Link** → the **Confirm** tab.
 - The camcorder will automatically attempt to connect to a WLAN via the most recently connected AP device.
 - If the camcorder has not previously been connected to a WLAN, it will search for available AP devices. ➔page 72
- 2 Connect your TV to a WLAN via an AP device.
 - Refer to your TV's user manual for more information.
- 3 On the TV, search for the camcorder and browse the shared videos or photos.
 - For information about searching for the camcorder and browsing the videos or photos on the TV, refer to the TV user manual.

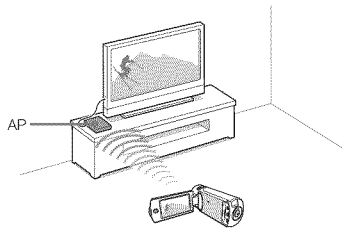

- On a TV, you can play back only the videos and photos recorded by the camcorder.
- The effective network connection range between the camcorder and the TV may differ depending on the AP.
- If the camcorder is turned off abnormally (ex: network disconnection) while you are playing a video or photo on the TV, the TV considers itself still connected to the camcorder.
- Depending on the size of the video or photo file, it may take longer to connect to the TV and display.
- You cannot enable this function if there are no recorded videos or photos in your camcorder.
- When playing HD quality videos on a TV, use an 802.11n AP and set it to 802.11n. Important: If you set the Data Encryption function on your network to WEP or TKIP, the network defaults to 802.11g and the camcorder cannot play HD quality videos on the TV.
- You can select up to 1000 photos and videos files to watch through your TV. The more files you select, the slower the camcorder operates. We recommend selecting fewer than 1000 files.
- This function may not operate properly on a Samsung HDTV that has no AllShare™ mark on it.
- Video stuttering may occur, depending on the TV type and network status.
- If video stuttering occurs, record videos you intend to play through a wireless connection at lower video resolution.
- If video stuttering occurs frequently when you use a wireless connection, change to HDMI or AV cable. ➔pages 82-83
- If you play back videos on a Samsung HDTV supporting AllShare™ and video stuttering occurs repeatedly for over 3 seconds, consult the Samsung call center. See the back cover for the phone number.
- We recommend you connect the TV and AP using a LAN (local area network) cable. If you connect them using a wireless connection, video stuttering can occur.

Using Auto Backup to send videos or photos

Installing the program for Auto backup on your PC

- 1 Connect the camcorder to a PC with the USB cable.
- 2 Turn on the camcorder.
 - The computer recognizes the camcorder and Intelli-studio launches automatically.
- 3 When the pop-up window for the Auto backup installation program appears on the PC screen, click **OK**.
 - To install the program, follow the instructions on the pop-up window.
 - After the installation is complete, disconnect the camcorder from the PC, and then reconnect the camcorder to the PC to confirm the server information message.
 - To run the program, disconnect the camcorder from the PC.

 This program is for backing up files to Windows PCs.

Sending photos or videos to a PC

- 1 Press the [Home (🏠)] button → touch **Auto Backup**.

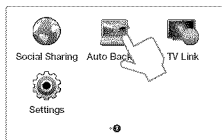

- 2 Touch the **Confirm** tab.

- The camcorder will automatically attempt to connect to a WLAN via the most recently connected AP device.
- If the camcorder has not previously been connected to a WLAN, it will search for available AP devices. ➔ page 72
- If your PC is on, the PC recognizes the camcorder and Intelli-studio launches automatically.
- If your PC supports the Wake on LAN (WOL) feature, you can turn on the PC automatically by searching for the PC from your camcorder. ➔ pages 79–80

- 3 The camcorder will prepare the files and then send them to the PC.

- You cannot select individual files to send. This function only sends files that have been newly stored on the camcorder.
- The progress will be shown on the PC monitor.



- The camcorder will search for available access points even if you are connecting to the same access point again.
- If you turn off the camcorder or remove the battery while sending files, the file transfer will be interrupted.
- While you are using this feature, the buttons on the camcorder will be disabled.
- You can connect only one camcorder to the PC at a time for sending files.
- The backup may be canceled due to network conditions.
- Videos or photos can be sent to a PC one time only.
- Files cannot be sent again even if you reconnect your camcorder.

Using Auto Backup to send videos or photos

About the Wakeup on LAN (WOL) feature



WOL (Wakeup on LAN)

WOL is a technology that allows you to turn on a PC from another location over a network connection or the Internet or to set a PC to wake up from sleep mode. With the WOL feature, you can automatically turn on or wake up a PC with your camcorder by touching **Auto Backup**.

Setting the PC to wake up from sleep mode

- 1 Click **Start**, and then open the **Control Panel**.
- 2 Configure the network connection.
 - Windows 7:
Click **Network and Internet** → **Network and Sharing Center** → **Change adapter settings**.
 - Windows Vista:
Click **Network and Internet** → **Network and Sharing Center** → **Manage network connections**.
 - Windows XP:
Click **Network and Internet Connection** → **Network Connection**.
- 3 Right click **Local Area**, and then click **Properties**.
- 4 Click **Configure** → the **Power manage** tab → **Allow this device to wake the computer**.
- 5 Click **OK**.
- 6 Restart the PC.

Setting the PC to turn on

- 1 Turn on the PC and press F2 while the PC is booting.
 - The BIOS setting menu will appear.
- 2 Select **Advanced** tab → **Power management Setup**.
- 3 Select **Resume on PME** → **Enabled**.
- 4 Press F10 to save your changes and continue booting.
- 5 Click **Start**, and then open the **Control Panel**.
- 6 Configure the network connection.
 - Windows 7:
Click **Network and Internet** → **Network and Sharing Center** → **Change adapter settings**.
 - Windows Vista:
Click **Network and Internet** → **Network and Sharing Center** → **Manage network connections**.
 - Windows XP:
Click **Network and Internet Connection** → **Network Connection**.

Using Auto Backup to send videos or photos

- 7 Select the driver for the network adapter.
- 8 Click the **Advanced** tab, and then set the WOL menu values.



Any changes to your PC's BIOS settings other than the ones described below may damage your PC. Samsung is not responsible for damage caused by your changing your PC's BIOS settings.



- You cannot use this feature across a firewall or if a security program has been installed.
- To turn on the PC with the WOL feature, the PC must have an active connection to the LAN. Ensure that the indicator light on the PC's LAN port is on, which shows that the LAN connection is active.
- Depending on your PC model, the camcorder may only be able to wake the PC.
- Depending on your PC's OS or drivers, the names of the WOL setting menu may vary.
 - examples of setting menu names: Enable PME, Wake on LAN etc.
 - examples of setting menu values: Enable, Magic packet etc.



Using with other devices

Learn how to connect your camcorder to your TV, VCR or DVD/HDD recorders, photo printer, or computer.

Connecting to a TV.....	82
Connecting to a high definition TV with HDMI	82
Connecting to a regular TV	83
Viewing on a TV screen.....	84
Dubbing videos to VCR or DVD/HDD recorders	85
Printing photos with a PictBridge photo printer	86
Transferring files to your Windows computer	88
Transferring files with Intelli-studio	89
Transferring files by connecting the camcorder as a removable disk.....	93

Connecting to a TV

Connecting to a high definition TV with HDMI

You can view High Definition (HD) quality videos recorded in HD resolution on an HDTV using an HDMI connection. This camcorder supports HDMI output to deliver high-definition video transfer.

Using a micro HDMI cable

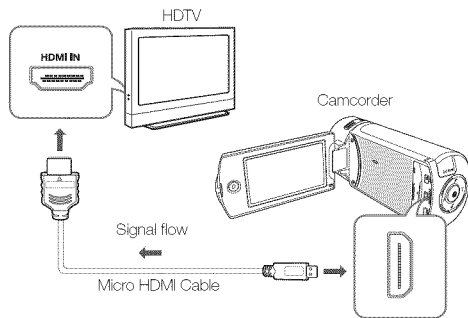

- 1 Turn on the camcorder.
 - If you do not turn on the camcorder first, the camcorder may fail to recognize the connected TV.
 - Use the AC power adaptor to power the camcorder when you attach it to a TV.
- 2 Select **HDMI TV Out**. ➔page 102
- 3 Connect the camcorder to the TV with a micro HDMI cable.

- 4 Set the TV's input or source selector to the HDMI input you've attached the camcorder to.
 - Refer to the TV's instruction manual to see how to select the TV's input or source.
- 5 Select the playback mode on your camcorder, and then start to play back videos or photos. ➔pages 56-62



Understanding the HDMI

HDMI (High Definition Multimedia Interface) is a compact audio/video interface for transmitting uncompressed digital data.

What is Anynet+ function?

The Anynet+ function lets you control all devices that support the Anynet+ function with the same remote. You can use the Anynet+ function on the camcorder if the camcorder is connected with an HDMI cable to an Anynet+ supported TV. For more information, refer to the Anynet+ supported TV's user manual.



- This camcorder is provided with the **TV Connect Guide** menu function. If you try to connect the camcorder to a TV and don't have your user's manual, you can use the **TV Connect Guide** menu function to view connection instructions on the camcorder's screen. ➔page 103
- You can use only a D to A type micro HDMI cable with this camcorder.
- The HDMI jack on the camcorder is for output only.
- If an Anynet+ supported TV is connected to the camcorder by an HDMI cable, turning on the camcorder may turn the TV's power on. (an Anynet+ function) If you don't want this to occur, set **Anynet+ (HDMI-CEC)** to **Off**. ➔page 103
- When the camcorder is connected to a TV with a micro HDMI cable, the wireless functions do not work. (HM-X-QF20 only)

Connecting to a TV

Connecting to a regular TV

You can view images recorded with your camcorder on a regular TV that supports standard definition. This camcorder supports the composite output for standard definition video transfer.

Connecting an Audio/Video cable for the composite output

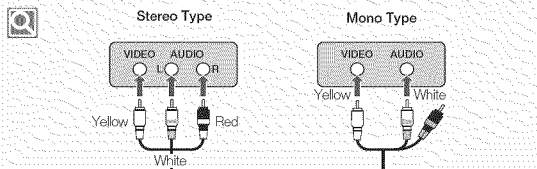
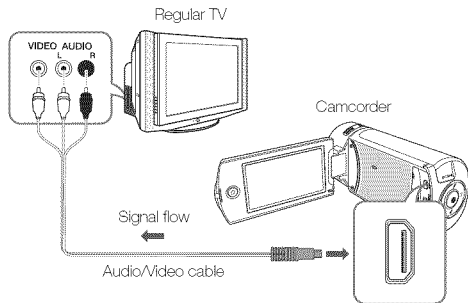

- 1 Connect the camcorder to a TV with an Audio/Video cable.
- 2 Set the TV's input or source selector to the input you've attached the camcorder to.
 - Refer to the TV's instruction manual to see how to select the TV input.
- 3 Select the playback mode on your camcorder, and then start to play back videos or photos. ➔pages 56~62





- Make sure you've connected the camcorder to the correct input jacks. The TV screen may not display the right video information if connected incorrectly.
- When connecting to a TV using the Audio/Video cable, match the color of the cables to the color of the corresponding jacks.
- Video input may appear green depending on the TV. If this occurs, connect the yellow plug of the Audio/Video cable to the green jack of the TV.
- When the camcorder is connected to a TV with more than one kind of cable, the camcorder outputs video signals in the following order of priority:
 - HDMI → Audio/Video (composite) output
- This camcorder is provided with the **TV Connect Guide** menu function. If you try to connect the camcorder to a TV and don't have your user's manual, you can use the **TV Connect Guide** menu function to view connection instructions on the camcorder's screen. ➔page 103
- If your TV has one audio jack (mono input), connect the yellow plug of the Audio/Video cable to the video jack, the white plug to the audio jack, and leave the red plug unconnected.
- When you connect the camcorder to a TV using the Audio/Video cable, images recorded in high-definition image quality (**Full HD 1080/60i** or **HD 720/60p**) are played back in standard definition image quality.

Connecting to a TV

Viewing on a TV screen

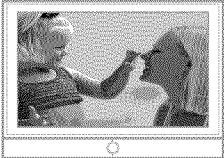
Image appearance depends on the TV screen aspect ratio

Recording ratio	Appearance on Wide (16:9) TV	Appearance on 4:3 TV
Images recorded in a 16:9 ratio		



- Adjust the volume to a moderate level. If the volume is too high, the video information may include noise.
- If **TV Display** is set to **Off**, the TV screen does not display the camcorder's OSD (On Screen Display) menus. ➔ page 102

Dubbing videos to VCR or DVD/HDD recorders

You can dub videos recorded on your camcorder to a VCR or DVD/HDD recorder.

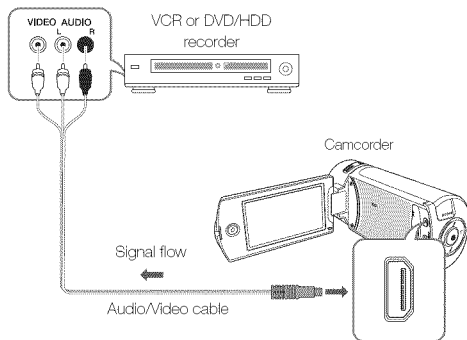

- 1 Connect your camcorder to the recording device (VCR or DVD/HDD recorder) with the Audio/Video cable.
 - Connect your camcorder to the input jacks of the recording device.
 - If your recording device has an input selector, set it to the correct input mode.
- 2 Insert the storage device (tape, disc, etc.) into the recording device.

- 3 Start the playback on your camcorder, and record it on the recording device.
 - Refer to the instruction manuals supplied with your recording device for details.
- 4 When dubbing is finished, stop the recording device, and then your camcorder.



- Videos recorded on this camcorder can only be dubbed using the Audio/Video cable in SD (standard definition) image quality, regardless of the recording resolution.
- You cannot dub to a recorder with an HDMI cable.
- To copy a video recorded in HD (high definition) image quality in HD, use the built-in software of your camcorder, and copy the video to your computer. ➔ page 89
- Because dubbing is performed via analog data transfer, the image quality may deteriorate.
- To hide the screen indicators (such as the counter, etc.) on the screen of the connected monitor device set **TV Display: Off** ➔ page 102
- To record the date/time, display it on the screen. ➔ page 102

Printing photos with a PictBridge photo printer

You can print photos directly by connecting your camcorder to a PictBridge printer (sold separately) using a USB cable.

- 1 Set **USB Connect to PictBridge**. [page 103](#)

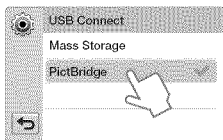

- 2 Use a USB cable to connect your camcorder to the printer.

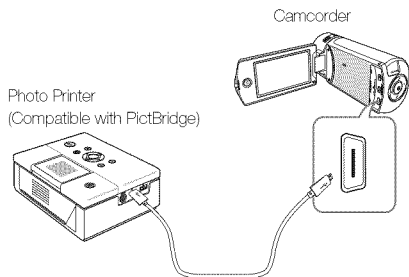

- 3 Turn your printer on.
 - The photo thumbnails appear on the LCD screen.

- 4 Touch the photo you want to print, and then touch the Print () tab.

- The corresponding message appears.

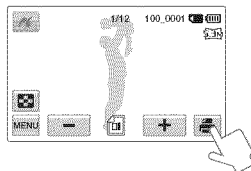



- 5 Touch **Yes**.

- The selected photo is printed.



To set the number of prints

Touch the   tab to set the number of copies to print.

To cancel the print setting

Touch the Thumbnail view () tab on the LCD screen.

To stop printing after printing starts

Touch **Cancel** on the screen.



- If the camcorder fails to recognize the printer, remove the USB cable, and then turn off the printer. Set **USB Connect to PictBridge**, and then connect the USB cable again.

- Use the supplied USB cable.

Printing photos with a PictBridge photo printer

To set the date/time imprint for Pictbridge printers

- 1 In the printer mode, touch the MENU (MENU) tab.

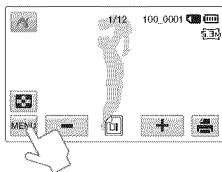

- 2 Touch the desired submenu item.

- The selected date and time display option is set.

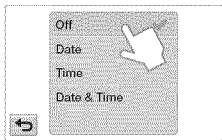

- 3 To exit the menu, touch the Return (RETURN) tab.

- The selected date and time will be printed on photos.



- The date/time imprint option may not be supported by all printers. Check with your printer manufacturer. The date/time imprint option cannot be setup if the printer does not support the option.
- PictBridge™ is a registered trademark of CIPA (Camera & Imaging Products Association), an image transfer standard developed by Canon, Fuji, HP, Olympus, Seiko Epson, and Sony.
- Use the AC power adaptor to power the camcorder during PictBridge printing. If the camcorder shuts off during printing, it might damage data on the storage media.
- You cannot print video images.
- You cannot print photos recorded on other devices.
- Various printing options are available depending on the printer. Refer to the printer's user manual for details.

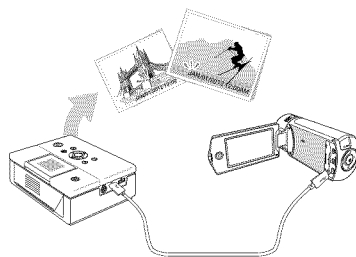

Transferring files to your Windows computer

Intelli-studio is a built-in program that allows you to play back and edit files. You can upload files to web sites, such as YouTube or Flickr.

System requirements

Your computer must meet the following requirements to run Intelli-studio:

Items	Requirement
OS	Microsoft Windows XP SP2, Windows Vista, or Windows 7
CPU	Intel® Core 2 Duo® 1.66 GHz or higher is recommended AMD Athlon™ X2 Dual-Core 2.2 GHz or higher is recommended (Notebook: Intel Core 2 Duo 2.2GHz or AMD Athlon X2 Dual-Core 2.6GHz or higher is recommended)
RAM	1GB or higher is recommended
Video Card	NVIDIA GeForce 8500 or higher, ATI Radeon HD 2600 series or higher
Display	1024 x 768, 16-bit color or higher (1280 x 1024, 32-bit color recommended)
USB	micro USB 2.0
Direct X	DirectX 9.0c or higher



- System requirements are recommendations. Even on a system that satisfies the requirements, Intelli-studio may not operate optimally.
- On a slower computer than recommended, video playback may skip frames or operate in an unexpected manner.
- If the version of DirectX on your computer is lower than 9.0c, install DirectX 9.0c or higher.
- We recommend transferring the recorded videos to a PC before playing back or editing the video data.
- To run Intelli-studio, a laptop computer requires better and faster components than a desktop PC.
- Intelli-studio is not Mac OS compliant.
- On 64-bit environment of Windows XP, Windows Vista, and Windows 7, Intelli-studio may be installed and work as 32-bit program.



Samsung is not responsible for any damage that results from using a computer that does not meet the requirements such as a computer you have assembled yourself.

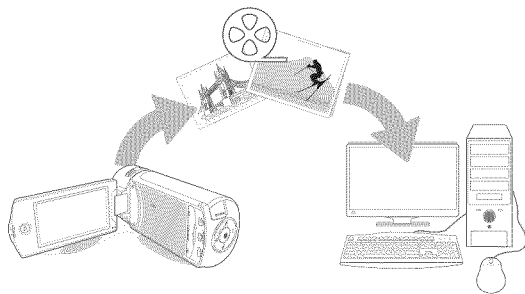

Transferring files to your Windows computer

Transferring files with Intelli-studio

When you connect the camcorder to a PC with a USB cable, Intelli-studio automatically launches.

Step 1. Connecting the USB cable

1 Set **USB Connect: Mass Storage** and **PC Software: On**.
▶ page 103

2 Connect the camcorder to a PC with the USB cable.

- A new file saving window appears along with the Intelli-studio main window. If your camcorder has no new files, the pop-up window for saving new files will not appear.
- Depending on your version of Windows, the Windows removable disk window may also appear.

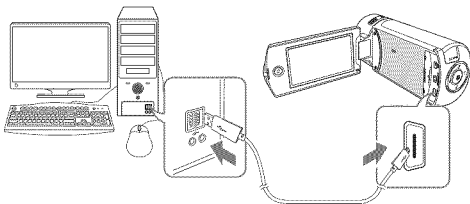

3 Click **Yes** in the new file saving window. The uploading procedure starts. Click **Yes** to confirm.

- If you do not want to save any new files, select **No**.



To disconnect the USB cable

To disconnect the USB cable after completing the file transfer, you must follow these steps:



1. Click the **Safely Remove Hardware** icon on the taskbar.
2. Select **USB Mass Storage Device**, and then click **Stop**.
3. If the **Stop a Hardware device** window appears, click **OK**.
4. Disconnect the USB cable from the camcorder and PC.



- Use the provided USB cable. (Supplied by Samsung)
- Make sure you insert the USB plug into the micro USB jack with the plug oriented correctly.
- Use the AC power adaptor to power the camcorder when transferring files to your computer.
- When the USB cable is connected, turning the camcorder on or off may cause the PC to malfunction.
- If you disconnect the USB cable from the PC or the camcorder while transferring files, the data transmission will stop and the data may be damaged.
- If you connect the camcorder to a PC via a USB HUB or simultaneously connect the camcorder along with other USB devices, the camcorder may not work properly. If this occurs, remove all USB devices from the PC, and then reconnect the camcorder.
- Intelli-studio may not automatically run. If this occurs, access My Computer or Windows Explorer, open the drive that corresponds to your camcorder, find Intelli-studio, and then run iStudio.exe.

Transferring files to your Windows computer

Step 2. About the Intelli-studio main window

When the Intelli-studio starts up, video and photo thumbnails appear in the main window.

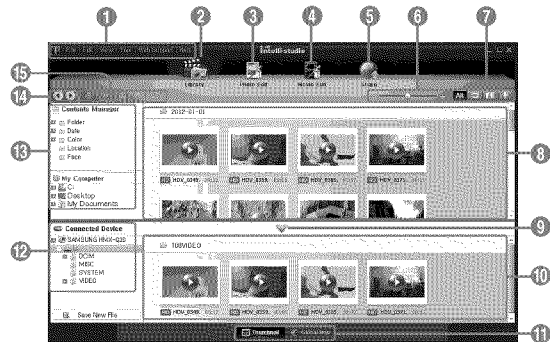

- If you install Intelli-studio on your PC, the program will launch more quickly. To install the program, select **Tool → Install Intelli-studio on PC**.
- You can update to the latest version of Intelli-studio software by clicking on **Web Support → Update Intelli-studio → Start Update**.
- The camcorder's built-in Intelli-studio software is intended for home use. It is not for precision or industrial productions. For these applications, we recommend an editing software designed for professional use.



For details, select **Help → Help on the Intelli-studio screen**.

No.	Description
1	Menu items
2	Display files in the selected folder.
3	Switch to Photo edit mode.
4	Switch to Video edit mode.
5	Switch to Share mode.
6	Enlarge or reduce the thumbnails in the list.
7	Select a file type.
8	View videos and photos of the selected folder on your computer.
9	Show or hide videos and photos of the connected device.
10	View videos and photos of the selected folder on the device.
11	View files as thumbnails or on a map
12	Browse folders in the connected device.
13	Browse folders stored on your computer
14	Move to the previous or next folder
15	Print files, view files on a map, store files in Contents Manager, register faces, or refresh content manager.

Transferring files to your Windows computer

Step 3. Playing back videos or photos

You can play back the recordings conveniently using the Intelli-studio application.

- 1 With Intelli-studio, click the desired folder to display your recordings.
 - Video or photo thumbnails appear on the screen, depending on the folder you selected.
- 2 Choose the video or photo that you want to play back.
 - You can view the file information by moving the mouse over the file.
 - If you click a video thumbnail once, the video plays back inside the thumbnail frame, allowing you to search for a desired scene with ease.
- 3 After you select the video or photo you want, double-click to play back.
 - Playback starts and the controls appear.



Intelli-studio supports the following file formats:

- Video formats: MP4 (Video: H.264, Audio: AAC), WMV (WMV 7/8/9)
- Photo formats: JPG, GIF, BMP, PNG, TIFF

Step 4. Editing videos or photos

You can edit the videos or photos in various ways with various functions. (Change Size, Fine-Tuning, Image Effect, Insert Frame, etc.) Before editing a video or photo in Intelli-studio, make a backup copy of the video or photo file and store it on your computer for safe-keeping using My Computer or Windows Explorer.

- 1 Choose the videos or photos you want to edit.
- 2 Click **Movie Edit** (🎬) or **Photo Edit** (🖼️) in the Intelli-studio browser according to the selected file.
 - The selected file appears in the editing window.
- 3 Edit a video or photo with various edit functions.



Transferring files to your Windows computer

Step 5. Sharing the videos/photos online

Share your contents with the world by uploading photos and videos directly to a web site with one click.

- 1 Choose the videos or photos you want to share.
- 2 Click **Share** () on the Intelli-studio browser.
 - The selected file appears in the sharing window.

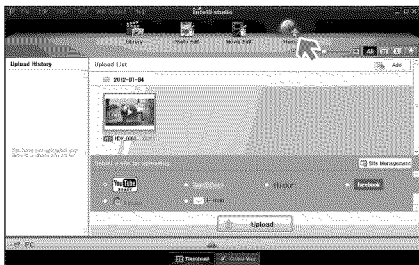

- 3 Click the web site you would like to upload files to.
 - You can choose **YouTube**, **twitter**, **Flickr**, **Facebook**, **Picasa**, **E-mail**, or another web site you want to use for your site management.

- 4 Click **Upload** to start uploading.

- A pop-up window appears containing your web browser displaying the selected site or a pop-up window appears asking for your ID and password.



- 5 Enter your ID and the password to access.

- Access to the web site contents can be limited depending on your web access environment.



The recording time and capacity available for uploading videos varies depending on each web site's policy.

Transferring files to your Windows computer

Transferring files by connecting the camcorder as a removable disk

You can copy video or photo files recorded by the camcorder to a Windows computer by connecting the camcorder to the computer using a USB cable.

Viewing the contents of storage media

- 1 Set **USB Connect to Mass Storage**. ↖page 103
- 2 Set **PC Software to Off**. ↖page 103
- 3 Insert a memory card. ↖page 16
- 4 Connect the camcorder to the PC with the USB cable.
↖page 89
 - The **Removable Disk** or **Samsung** window appears on the PC's screen after a moment.
 - Select **Open folders to view files using Windows Explorer**, and then click **OK**.

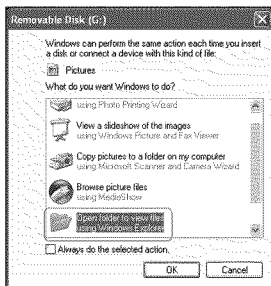

- 5 The folders in the storage media appear.
 - Different file types are stored in different folders.

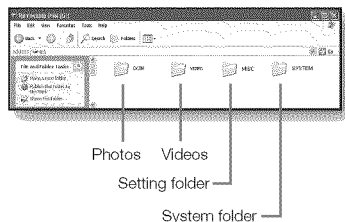

- 6 Copy and paste or drag and drop the files from the storage media to your PC.

- If the **Removable Disk** window does not appear, confirm the connection. (↖page 89) or perform steps 1 to 4 again. If the removable disk does not appear automatically, open the removable disk folder in My Computer.
- If the connected camcorder's disk drive does not open or the context menu that appears when right clicking your mouse (open or browse) appears broken, your computer may be infected by an Autorun virus. Please update your anti-virus software to its latest version and scan your disk drives.
- Depending on the functions of the camcorder, additional folders can be created.

Transferring files to your Windows computer

Video file (H.264) ①

- HD-quality videos have an HDV_####.MP4 name format.
- The file number used in the file name automatically increases when you create a new video file.
- A new folder is created when the file number has reached 999~1,000.
- The folder names are given in the following order: 100VIDEO, 101VIDEO, etc. The maximum number of folders is 999.
- The camcorder can create a maximum of 9,999 files in a storage media.

Photo file ②

- As with video files, the file number used in the file name automatically increases when you create a new photo file.
- Photos have a SAM_####.JPG name format.
- The folder names are given in the following order: 100PHOTO, 101PHOTO, etc.

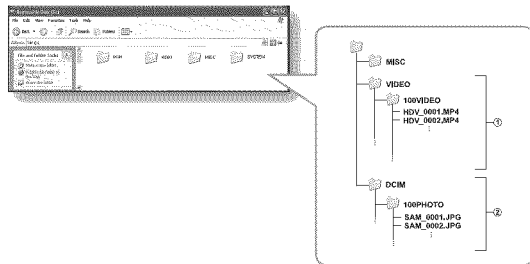

File format

Video files

- Video files are compressed in H.264 format. The file extension is '.MP4'.
- Refer to page 97 for the video resolution.

Photo files

- Photo images are compressed in JPEG (Joint Photographic Experts Group) format. The file extension is '.JPG'.
- Refer to page 97 for the photo resolution.



- File naming follows DCF (Design rule for Camera File System) rules
 - Do not modify the name of a video file recorded by the camcorder.
- For proper playback, the camcorder requires that files have their original folder and file names.



Settings

Refer to items to configure your camcorder's settings.

Settings menu	96
Accessing the settings menu	96
Shooting	97
Playback	98
Display	101
Connectivity.....	103
General	104





Settings menu

Accessing the settings menu

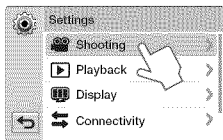
The instructions below are an example of how to access and use the Settings menu items. When you access and use other Settings menu items (pages 97~106), use this example as a guide.

- 1 Press the [Home (🏠)] button → touch **Settings**.
- 2 Touch a menu.



Menu	Description
	Shooting: Set the items in the video or photo recording mode. ↪ pages 97~98
	Playback: Set the items in the video or photo playback mode. ↪ pages 98~101
	Display: Customize the display settings. ↪ pages 101~102
	Connectivity: Set the connection items. ↪ page 103
	General: Change the settings for the camcorder system such as memory format and default set. ↪ pages 104~106

- 3 Touch a submenu.

- The OIS Duo function is used here as an example.

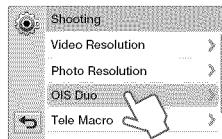

- 4 Touch the desired submenu item.

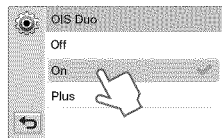

- 5 To exit the menu setting, touch the Return (⏪) tab.

Settings menu

Shooting

* : Default

Item	Description
Video Resolution	<p>Set the video resolution.</p> <ul style="list-style-type: none">• Full HD 1080/60i* (📺): Records in the Full HD (1920x1080/60i) format.• HD 720/60p (HD): Records in the HD (1280x720/60p) format.• Web/HD (📺): Records in the Web/HD format. Use for videos you intend to upload to Web sites. <p> <ul style="list-style-type: none">• 60i indicates the camcorder will record in interlaced scan mode at 60 fields per second.• 60p indicates the camcorder will record in progressive scan mode at 60 frames per second.• Recorded files are encoded using Variable Bit Rate (VBR). VBR is an encoding system that automatically adjusts the bit rate in response to the image being recorded.• The available video recording time differs according to the video resolution you select. ➤page 19• The videos recorded in Web/HD resolution are displayed in 1280x720/60p resolution in the video thumbnail view and in WQGA (432x240/30p) resolution in the Social Sharing mode. ➤page 76</p>
	Photo Resolution



* : Default

Item	Description
OIS Duo	<p>Set to compensate for camcorder shake/blur.</p> <ul style="list-style-type: none">• Off*: Disables the function.• On (📺): Enables to compensate for camcorder shake.• Plus (📺): Enables the function. <p> OIS Plus improves on existing Optical Image Stabilization by allowing the camcorder lens to shift over a wider range of motion in wide/tele zoom position. This allows the camcorder to compensate for greater degrees of camcorder shake and delivers a stunning level of image smoothness.</p>
	Tele Macro

Settings menu



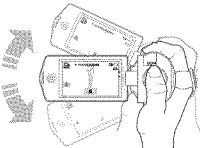

Shooting

* : Default

Item	Description
Digital Zoom	<p>Set to increase the amount of zoom available with a zoom lens.</p> <ul style="list-style-type: none"> Off*: Disables the digital zoom function. Only optical zoom is available. On: Enables higher digital zoom magnification. <p> When you use the digital zoom, the camcorder processes the image digitally more than in the optical zoom mode. As a result, the image resolution may deteriorate.</p> <p> The top of the bar shows the digital zooming zone. The zooming zone appears when you press the [Zoom (T/W)] button or use the Zoom () tab.</p>
	<p>Digital range Optical range Zoom indicator</p>
Shake It	<p>Set to apply digital effects by shaking the camcorder.</p> <ul style="list-style-type: none"> Off*: Disables the Shake It function. On: Enables the Shake It function. Each time you shake the camcorder in Art Film or Art Time Lapse mode, it applies a digital effect in order. 

Playback

* : Default

Item	Description
Thumbnail	<p>Set thumbnails to display in 3x3 or 4x4 format.</p> <ul style="list-style-type: none"> 3X3*: Displays thumbnails three across and three down. 4X4: Displays thumbnails four across and four down. <p> You can also change Thumbnail to 3x3 or 4x4 by pressing the [Zoom (T/W)] button in the thumbnail view.</p>
	<p>Set a specific playback style according to your preference.</p> <ul style="list-style-type: none"> Play All* (ALL): Plays video clips in succession starting from the selected video to the last one, then returns to the thumbnail view. Play One (1): Plays the selected video only, and returns to the thumbnail view. Repeat All (PA): Plays all the video clips repeatedly until the Thumbnail view () tab is touched. Repeat One (PO): Plays the selected video only repeatedly until the Thumbnail view () tab is touched.
Video Play Option	<p>Set background music to play back with your videos. You can select one of the 20 music files in the camcorder, from The Flea Waltz to The Four Seasons, or select the Random option, which plays back the music files randomly.</p> <p> You can also enjoy external songs by saving them into a memory card, as well as 20 music in Smart BGM Option of the camcorder. → pages 99-100</p>
Smart BGM Option	

Settings menu

Playback

Using external songs as background music (Smart BGM II)

You can enjoy external songs, as well as the music files in the **Smart BGM Option** of the camcorder, by saving the external songs to a memory card.

To set external songs as background music

Convert your songs to a compatible format using the Intelli-studio program built in to your camcorder so that the songs can be recognized by the camcorder.

- 1 Connect the camcorder to a PC with the USB cable to run the Intelli-studio program. → page 89
- 2 Click **Tool** on the Intelli-studio screen → **Sending song for Smart BGM**.



- 3 Click **Browse** on the Smart BGM screen to select the desired song.
- 4 Change the song's name so that it can be recognized by the camcorder, and then click **Send** → **Yes**.
 - The song is converted to a m4a file and transferred into the memory card in the camcorder.

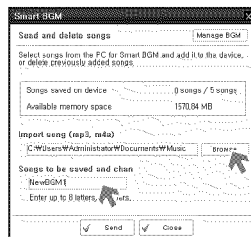

- 5 When the transfer is complete, click **OK**.
 - You can save up to 5 converted songs in the camcorder's memory card.
- 6 The song saved to the memory card appears on the **Smart BGM Option** menu in video playback mode. → page 98

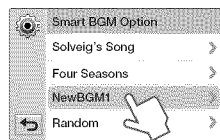

Settings menu

Playback

Using external songs as background music (Smart BGM II)

To delete the external songs from the memory card

You can delete external songs from **Manage BGM** in the Smart BGM screen or from the BGM folder in the memory card.

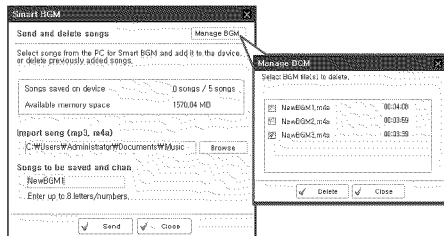

- The camcorder can recognize external songs converted by the IntelliStudio program only.
- The external songs you want to convert must be in the mp3 or m4a formats. Some MP3 files may not be supported.
- External songs are saved to the BGM folder in the memory card.
- If you transfer the converted m4a files into the BGM folder in the memory card, you can use them as Smart BGM files.

Settings menu





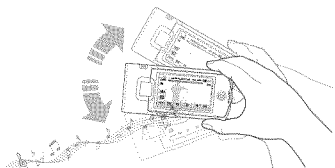

Playback

* : Default

Item	Description
Slide Show Option	<p>Set the playback options for a slide show, and then touch the OK tab.</p> <ul style="list-style-type: none">• Music: Turns the background music on or off. If the Music function is On when the slide show starts, the 20 melodies will play back in shuffle mode.• Interval: Continuously plays back photos at the interval you select. You can choose 1 sec. or 3 sec.• Effect: Continuously plays back photos using the fade in/out effect to transition between photos.
Shake It	<p>Set to play back background music by shaking the camcorder.</p> <ul style="list-style-type: none">• Off*: Disables the Shake It function.• On: Enables the Shake It function. Shake the camcorder while a video is playing to have the camcorder play background music. 

Display



* : Default

Item	Description
LCD Brightness	<p>Set the brightness of the LCD screen. Touch the  /  tab between 0 and 10.</p> <ul style="list-style-type: none">• If the surroundings are too bright, adjust the brightness of the LCD screen.• Adjusting the LCD screen does not affect the image you are recording.• A brighter LCD screen consumes more power.
Guideline	<p>Set a grid to help you compose a scene.</p> <ul style="list-style-type: none">• Off* (): Disables the function.• Cross (): Placing the subject at the center cross point puts the subject in the middle of the frame.• Grid (): For recording multiple subjects. Putting subjects at or near the grid cross points creates a balanced composition.• Safety Zone (): Positioning subjects within the Safety Zone rectangle ensures they will be recorded. <p> • Positioning a subject at the cross point of a guideline provides a balanced composition.</p> <ul style="list-style-type: none">• Guidelines are not recorded.

Settings menu

Display

* : Default

Item	Description
Date/Time Display	<p>Set to display the date and time on the camcorder's display.</p> <ul style="list-style-type: none">• Off*: Does not display the current date/time information.• Date: Displays the current date.• Time: Displays the current time.• Date & Time: Displays the current date and time. <p> <ul style="list-style-type: none">• The date/time will read JAN/01/2012 12:00 AM when the internal rechargeable battery is depleted.• The date and time displayed by this function depend on the Date Type and Time Type settings.<p>→page 104</p></p>
TV Display	<p>Set whether or not to display the camcorder's On Screen Display (OSD) on the TV screen.</p> <ul style="list-style-type: none">• Off: Displays the OSD menus only on the LCD screen.• On*: Displays the OSD menus on the LCD screen and the TV screen as well. <p> The menu screen, thumbnail display, and demo screens are displayed on a TV even if you set TV Display to Off.</p>

* : Default

Item	Description
HDMI TV Out	<p>Set the HDMI video output to match the TV you have connected the camcorder to.</p> <ul style="list-style-type: none">• Auto*: The video signals are output in the same format as the recorded file. Use this setting only when connecting to an HDTV.• 480p: The recorded file is output in the 720x480p format. Use this setting only when connecting to a standard, analog TV which supports SD (Standard Definition) progressive scan (480p) signals through its HDMI jacks.
Auto LCD Off	<p>Set to darken the LCD screen for low power consumption.</p> <ul style="list-style-type: none">• Off: Disables the function.• On*: When the camcorder is idle for more than 2 minutes in STBY mode, or for more than 5 minutes when recording a video, the power saving mode starts by dimming the LCD screen. <p> <ul style="list-style-type: none">• When the Auto LCD Off function is On, you can press any button on the camcorder to return LCD brightness to normal.• The Auto LCD Off function is Off in the following cases:<ul style="list-style-type: none">- When the camcorder has a cable connection. (USB cable, AC power adaptor, etc.)- While the Demo function is in operation.</p>

Settings menu

Connectivity

* : Default

Item	Description
PC Software	<p>Set to launch the built-in editing software (Intelli-studio) automatically when you connect the camcorder to your PC.</p> <ul style="list-style-type: none">• Off: Disables the function.• On*: Launches Intelli-studio when you connect the camcorder to your PC. <p> • The PC Software function is not available under the following conditions:</p> <ul style="list-style-type: none">- If USB Connect is set to PictBridge• To enable the PC Software function, set USB Connect to Mass Storage in the Setting menu.• The PC Software is compatible with Windows OS's only.
USB Connect	<p>Select a mode to use when connecting the camcorder to a PC or printer with a USB cable.</p> <ul style="list-style-type: none">• Mass Storage*: Connect to a PC to transfer videos or photos. ➔page 93• PictBridge: Connect to a PictBridge printer to print photos directly (when using the PictBridge function). ➔page 86





* : Default

Item	Description
TV Connect Guide	<p>View the connection instructions before connecting the camcorder to your TV set.</p> <ul style="list-style-type: none">• HDMI: Displays the HDMI guide.• Composite: Displays the Composite guide.
Anynet+ (HDMI-CEC)	<p>Set to control some functions of the camcorder with a Samsung TV remote control that supports Anynet+.</p> <ul style="list-style-type: none">• Off: Disables the function.• On*: Lets you operate some functions of the camcorder with a TV remote control when connecting the camcorder to a Samsung Anynet+ supported TV. <p> • When you turn the camcorder on and connect it to a Samsung Anynet+ supported TV with an HDMI cable, the TV automatically turns on.</p> <ul style="list-style-type: none">• For details on the Anynet+(HDMI-CEC) function, refer to the user manual of the Samsung Anynet+ supported TV.



Settings menu

General

* : Default

Item	Description
Card Info	<p>View the storage information of the inserted storage media such as memory space used and available memory space.</p> <p> • The actual capacity may be less than the capacity displayed on the LCD screen as the camcorder's system files occupy a part of the capacity.</p> <p>• If there is no storage media inserted, you cannot select the Card Info function and it will look dim in the menu.</p>
File No.	<p>Assign file names to the recorded images.</p> <ul style="list-style-type: none">• Series*: Assigns file numbers in sequence even after you replace or format the storage media or delete all files.• Reset: Resets the file number to 0001 after you run format, delete all files, or insert a new memory card. <p> When you set File No. to Series, each file is assigned a different number to avoid duplicating file names. This numbering scheme is very useful when you want to manage your files on a PC.</p>
Time Zone	<p>Set the time zone for your location.</p> <ul style="list-style-type: none">• Home*: Select the Home function when using your camcorder for the first time or returning the clock to your hometown date/time.• Visit (📍): Select the Visit function when traveling in a different time zone. Touch the / tab, and then the OK tab.
Date/Time Set	<p>Set the date and time. ➡page 28</p>



* : Default

Item	Description
Date Type	<p>Set a date format.</p> <ul style="list-style-type: none">• 2012/01/01: Displays the date in the year/month (two-digit)/day format.• JAN/01/2012*: Displays the date in the month/day/year format.• 01/JAN/2012: Displays the date in the day/month/year format.• 01/01/2012: Displays the date in the day/month (two-digit)/year format. <p> This function depends on the Date/Time Display setting. ➡page 102</p>
Time Type	<p>Set a time format.</p> <ul style="list-style-type: none">• 12 Hr*: Displays the time information in 12 hour units.• 24 Hr: Displays the time information in 24 hour units. <p> This function depends on the Date/Time Display setting. ➡page 102</p>
Beep Sound	<p>Set whether or not to play the beep sound.</p> <ul style="list-style-type: none">• Off: Disables the function.• On*: Turns on the beep sound. A beep sounds when you press buttons or touch tabs. <p> The Beep Sound function is disabled in the following cases:</p> <ul style="list-style-type: none">- During recording and playing- When the camcorder has a cable connection. (Audio/Video cable, micro HDMI cable, etc.)



Settings menu

General

* : Default

Item	Description
Shutter Sound	Set whether or not to play the shutter sound. <ul style="list-style-type: none">• Off: Disables the function.• On*: Turns on the shutter sound. Shutter "click" sounds when you take a photo by pressing the [Recording start/stop] button.  The Shutter Sound function is disabled in the following cases: <ul style="list-style-type: none">- When the camcorder has a cable connection. (Audio/Video cable, micro HDMI cable, etc.)
	Set the camcorder to automatically turn off if it performs no operations for 5 minutes. <ul style="list-style-type: none">• Off: Disables the function.• 5 Min*: Turns off the camcorder if it performs no operation for 5 minutes.  <ul style="list-style-type: none">• The Auto Power Off function does not work in the following situations:<ul style="list-style-type: none">- When the camcorder has a cable connection. (USB cable, AC power adaptor, etc.)- While the Demo function is in operation.- While you are recording (including the recording pause), playing (except pause), or running a photo slide show.• To turn the camcorder on again, close the LCD screen and then open it.
Auto Power Off	



* : Default

Item	Description
Quick On STBY	Use to reduce energy consumption and battery drain when recording frequently for an extended time. <ul style="list-style-type: none">• Off*: The camcorder turns off when you close the LCD screen.• 5 Min: The camcorder goes into the Quick On STBY mode a short period of time after you close the LCD screen. After 5 minutes in Quick On STBY mode, the camcorder turns off.  <ul style="list-style-type: none">• We recommend turning off the camcorder after use to reduce energy consumption. However, as an alternative, you can use the Quick On STBY function under most shooting conditions to reduce energy consumption effectively.• The charging indicator keeps blinking in Quick On STBY mode.• The Quick On STBY mode is not available under the following conditions:<ul style="list-style-type: none">- When the LCD screen is open.- When you operate the buttons on the camcorder.- While you are recording.
	Set to use the camcorder conveniently with either your right or left hand. <ul style="list-style-type: none">• Off: Disables the function.• On*: Lets you use the camcorder easily with either hand.  When you change the Switch Grip direction while recording, the recording may be temporarily interrupted.
Switch Grip	



Settings menu

General

* : Default

Item	Description
	<p>Use to delete all files completely or to correct problems on the storage media.</p> <p> • Do not remove the storage media or perform any other operation (such as turning off the power) during formatting. Also, be sure to use the provided AC power adaptor to power the camcorder while formatting the storage media. The storage media may be corrupted if the battery becomes exhausted during formatting.</p> <ul style="list-style-type: none">• If the storage media becomes corrupted, format it again.
Format	<p> • Do not format the storage media on a PC or other device. Make sure to format the storage media on this camcorder.</p> <ul style="list-style-type: none">• You cannot format a memory card with the protection tab set to lock. ▶page 17• If there is no storage media inserted, you cannot select the Format function, and its name will be dimmed on the menu.• Formatting completely deletes all files and options on a memory card, including protected files. By deleting all files and options, formatting typically corrects problems, enabling stable read/write speeds and operation.

* : Default

Item	Description
	<p>Reset all menu settings to the factory defaults (factory settings).</p> <p>Touch Yes if you want all the settings returned to the defaults.</p>
Default Set	<p> • Do not turn off the power while using this function.</p> <ul style="list-style-type: none">• Initializing the camcorder settings to factory defaults does not affect recorded images.
Language	<p>Select the language the camcorder uses to display the menu and messages. ▶page 29</p> <p>Show the major demo functions for the camcorder.</p> <ul style="list-style-type: none">• Off: Disables the function.• On*: Enables the Demo function.
Demo	<p> The Demo mode is canceled in the following cases:</p> <ul style="list-style-type: none">- If the LCD screen is touched.- If you press any button (Recording start/stop, Home (⬆), etc.). However, the camcorder enters the Demo mode automatically after 5 minutes in STBY mode if it is idle for 5 minutes without an operation. If you don't want the Demo function to start, set Demo to Off. <p> The Demo function does not work in the following case:</p> <ul style="list-style-type: none">- If you set Auto Power Off to 5 Min and you are using the battery to power the camcorder, the Auto Power Off function turns the camcorder off before the Demo function runs.



Appendixes

Get information about error messages, maintenance, and specifications.

Troubleshooting	108
Warning icons and messages	108
Symptoms and solutions.....	114
Maintenance.....	121
Using your camcorder abroad	123
Glossary	124
Specifications.....	125

Troubleshooting

Before contacting a Samsung authorized service center, perform the following simple checks. They may save you the time and expense of an unnecessary call.



Warning icons and messages

Problems may occur because of the following reasons. Check the information and take corrective action.

Battery





Message	Icon	Informs that...	Action
Low Battery	-	The battery is almost discharged.	<ul style="list-style-type: none">• Replace with a charged battery or connect the AC power adaptor.• Check whether the battery is authentic. If not, change to an authentic Samsung battery.• We recommend you use only genuine Samsung batteries in this camcorder.
Check authenticity of the battery.	-	The battery cannot pass authenticity check.	

Storage media

Message	Icon	Informs that...	Action
Insert Card		There is no memory card inserted in the memory card slot.	<ul style="list-style-type: none">• Insert a memory card.
Card Full		There is not enough space to record on the memory card.	<ul style="list-style-type: none">• Delete unnecessary files from the memory card.• Back-up files to a PC or another storage media, and then delete unneeded files.• Replace the memory card with another card that has enough free space.
Card Locked		The write protection tab on an SD or SDHC card has been set to lock.	<ul style="list-style-type: none">• Release the write protection tab.

Troubleshooting

Storage media

Message	Icon	Informs that...	Action
Card Error		The memory card has a problem and the camcorder cannot recognize it.	<ul style="list-style-type: none">• Replace the memory card with another card.
Not Formatted		The memory card is not formatted in this camcorder.	<ul style="list-style-type: none">• Format the memory card using this camcorder.
Not Supported Format		The memory card may have been formatted by another device and may still have existing images on it.	<ul style="list-style-type: none">• Files cannot be played as the memory card format is not supported by the camcorder.• Format the card using the camcorder or replace the card with a card formatted correctly.
Not Supported Card		The memory card is not supported in this camcorder.	<ul style="list-style-type: none">• Replace the memory card with a recommended card.
Low Speed Card. Please record at a lower resolution.	-	The memory card is not fast enough to record at this resolution.	<ul style="list-style-type: none">• Record video at a lower resolution and quality.• Replace memory card with a faster card.

Recording

Message	Icon	Informs that...	Action
Write Error	-	Some problem occurred while writing data to the storage media.	<ul style="list-style-type: none">• Turn the camcorder's power off and on for data recovery.• If a file is not recovered, use the camcorder to format the storage media after backing up important files to a PC or another storage media.
Recovering Data... Don't power off and keep card inside.	-	The file was not created normally.	<ul style="list-style-type: none">• Wait until data recovery is finished.• Never turn off the power or eject the memory card during recording.

Troubleshooting

Recording

Message	Icon	Informs that...	Action
The limit of video files is reached. Cannot record video.	-	The number of video files that can be stored is 9,999.	<ul style="list-style-type: none"> • Delete unnecessary files from the storage media. • Back up files to your PC or another storage media and delete files. • Change to another card which has enough free space. • Set File No. to Reset. • Format the storage media.
The limit of photo files is reached. Cannot take a photo.	-	The number of photo files that can be stored is 9,999.	<ul style="list-style-type: none"> • Delete unnecessary files on the storage media. • Back up files to your PC or another storage media and delete files. • Change to another card which has enough free space. • Set File No. to Reset. • Format the storage media.
File Limit is reached. Cannot record video.	-	The folder and file number have reached their maximum and you cannot record.	<ul style="list-style-type: none"> • Set File No. to Reset and format the storage media. Remember to back up important files before formatting.
File Limit is reached. Cannot take a photo.	-	The folder and file number have reached their maximum and you cannot record.	<ul style="list-style-type: none"> • Set File No. to Reset and format the storage media. Remember to back up important files before formatting.
Check the lens cover		Lens cover is closed.	<ul style="list-style-type: none"> • Open the lens cover.

Troubleshooting

Playback

Message	Icon	Informs that...	Action
Read Error	-	A problem has occurred while the camcorder was reading data from the storage media.	<ul style="list-style-type: none">• Use the camcorder to format the storage media after backing up important files to a PC or another storage device.
Corrupted file	-	This file cannot be read.	<ul style="list-style-type: none">• Use the camcorder to format the storage media after backing up important files to a PC or another storage device.

Editing videos

Message	Icon	Informs that...	Action
Cannot select different resolution.	-	The files you want to combine have different resolutions.	<ul style="list-style-type: none">• You cannot combine files that have different resolutions.
Not enough free space in Card.	-	You cannot edit due to insufficient space in the memory card.	<ul style="list-style-type: none">• Edit after deleting unnecessary files.
Select 2 files for combine.	-	Only two files can be combined.	<ul style="list-style-type: none">• Combine two files first, and then combine the resulting file with an additional file. Note that you cannot combine files if the total size of the combined files exceeds 1.8GB.
Total file size is over than 1.8GB.	-	The files whose total size is likely to exceed 1.8GB cannot be combined.	<ul style="list-style-type: none">• Perform a divide or partial delete function first to delete unnecessary parts of the files, and then perform the combine function.

Troubleshooting

Message	Icon	Informs that...	Action
Fail Printer Connecting Change 'USB Connect'	-	A problem occurred when connecting the camcorder via USB to a printer.	<ul style="list-style-type: none">• Check the USB cable.• Try the connection procedure again.• Switch USB Connect function to PictBridge.
Fail USB Connecting Change 'USB Connect'	-	A problem occurred when connecting the camcorder via USB to a PC.	<ul style="list-style-type: none">• Check the USB cable.• Try the connection procedure again.• Switch USB Connect function to Mass Storage.
Ink Error	-	There is a problem with an ink cartridge.	<ul style="list-style-type: none">• Check the ink cartridge.• Put a new ink cartridge into the printer.
Paper Error	-	There is a problem with the paper.	<ul style="list-style-type: none">• Check the paper in the printer. If there is no paper, insert paper.
File Error	-	There is a problem with the file.	<ul style="list-style-type: none">• Your camcorder does not support this file format.• Try another file recorded on your camcorder.
Printer Error	-	There is a problem with the printer.	<ul style="list-style-type: none">• Turn the printer's power off and on.• Contact the printer manufacturer's service center.
Print Error	-	A problem occurred during printing.	<ul style="list-style-type: none">• Do not remove power source or eject memory card during printing.

Troubleshooting

Wireless Network (HMX-QF20 Only)

Message	Icon	Informs that...	Action
Connection failed.	-	Camcorder's WLAN configuration does not match that of the AP.	<ul style="list-style-type: none">• Configure the IP settings (auto or manual) of your camcorder to match the AP's.
No response from server.	-	No renderer that can be connected to the camcorder is found in the connected network.	<ul style="list-style-type: none">• Check your network connection.

Troubleshooting

Symptoms and solutions

If these instructions do not solve your problem, contact your nearest Samsung authorized service center.

Power

Symptom	Explanation/Solution
The camcorder does not turn on.	<ul style="list-style-type: none">• The battery may not be installed in your camcorder. Insert the battery into the camcorder.• The inserted battery may be discharged. Charge the battery or replace it with a charged one.
The power turns off automatically.	<ul style="list-style-type: none">• If you use the AC power adaptor, make sure it is properly connected to a wall outlet.• Is Auto Power Off set to 5 Min? If no button is pressed for about 5 minutes, the camcorder is automatically turned off (Auto Power Off). To disable this option, change the setting of Auto Power Off to Off. ➔page 105
The power cannot be turned off.	<ul style="list-style-type: none">• The battery is almost exhausted. Charge the battery or replace it with a charged one.• Remove the battery or unplug the AC power adaptor, and connect the power supply to the camcorder again before turning it on.
The battery discharges quickly.	<ul style="list-style-type: none">• The temperature is too low.• The battery is not fully charged. Charge the battery again.• The battery has reached the end of its lifespan and cannot be recharged. Use another battery.

Display

Symptom	Explanation/Solution
The TV screen or LCD display has distorted images or has stripes at the top/bottom or on the left/right.	<ul style="list-style-type: none">• This can occur when recording or viewing a 16:9 ratio image on a 4:3 ratio TV, or vice versa. For more details, see the display specification. ➔page 84
Unknown image appears on the LCD screen.	<ul style="list-style-type: none">• The camcorder is in Demo mode. If you do not want to see Demo images, change the setting Demo to Off. ➔page 106

Troubleshooting

Display

Symptom	Explanation/Solution
Unknown icon appears on the screen.	<ul style="list-style-type: none">• A warning icon or message appears on the screen. ➤ pages 108~113
An afterimage remains on the LCD screen.	<ul style="list-style-type: none">• This occurs if you disconnect the AC power adaptor or remove the battery before turning the power off.
The image on the LCD screen looks dark.	<ul style="list-style-type: none">• Ambient light is too bright. Adjust the brightness and angle of the LCD.

Recording

Symptom	Explanation/Solution
Pressing the [Recording start/stop] button does not start recording.	<ul style="list-style-type: none">• Set your camcorder to the recording mode. ➤ page 37• There is not enough free space to record on the storage media.• Check if memory card is not inserted or write-protect tab is set to lock.
The actual recording time is less than the estimated recording time.	<ul style="list-style-type: none">• The estimated recording time may vary depending on content and features used.• When you record an object that moves fast, the actual recording time may be shortened.
The recording stops automatically.	<ul style="list-style-type: none">• There is no more free space for recording on the storage media. Back up important files on your PC and format the storage media or delete the unnecessary files.• If you make recordings or delete files frequently, the performance of the storage media deteriorates. If this occurs, format the storage media again.• If you use a memory card with low writing speed, the camcorder automatically stops recording videos and a corresponding message appears on the LCD screen.
When recording a subject illuminated by bright light, a vertical line appears.	<ul style="list-style-type: none">• This is not a malfunction.
When the screen is exposed to direct sunlight during recording, the screen becomes red or black for an instant.	<ul style="list-style-type: none">• This is not a malfunction.

Troubleshooting

Recording

Symptom	Explanation/Solution
During recording, the date/time does not display.	<ul style="list-style-type: none">• Date/Time Display is set to Off. Set the Date/Time Display to On. ↪page 102
You cannot record a photo image.	<ul style="list-style-type: none">• Set your camcorder to the photo recording mode. ↪page 41• Release the lock on the write-protection tab of the memory card if any.• The storage media is full. Use a new memory card or format the storage media. ↪page 106 Or remove unnecessary images. ↪page 65
You don't hear the shutter sound when you record a photo image.	<ul style="list-style-type: none">• Set Shutter Sound to On.• When the micro HDMI cable or Audio/Video cable is connected to the camcorder, the Shutter Sound is disabled temporarily.
You don't hear the beep sound.	<ul style="list-style-type: none">• Set Beep Sound to On.• The Beep sound is turned off temporarily when you record videos.• When the micro HDMI cable or Audio/Video cable is connected to the camcorder, the Beep Sound is disabled temporarily.
There is a time difference between the point where you press the [Recording start/stop] button and the point where the recorded video starts/stops.	<ul style="list-style-type: none">• On your camcorder, there may be a slight time delay between the point where you press the [Recording start/stop] button and the actual point where the recorded video starts/stops. This is not an error.
Horizontal stripes appear on the images.	<ul style="list-style-type: none">• This can occur when recording images under a fluorescent lamp, sodium lamp, or mercury lamp. This is not a malfunction.

Troubleshooting

Storage Media

Symptom	Explanation/Solution
Memory card functions do not operate.	<ul style="list-style-type: none">• Insert a memory card into your camcorder properly. ➔page 16• If you use a memory card formatted on a computer, format it again directly on your camcorder. ➔page 106
Image cannot be deleted.	<ul style="list-style-type: none">• Release the lock on the write-protect tab of the memory card (SDHC/SD memory card), if any. ➔page 17• You cannot delete a protected images. Release protection of the image using the Protect function. ➔page 67
You cannot format the memory card.	<ul style="list-style-type: none">• Release the lock on the write-protect tab of the memory card (SDHC/SD memory card), if any. ➔page 17• The memory card is not supported on your camcorder or card has some problems.
The data file name is not indicated correctly.	<ul style="list-style-type: none">• The file may be corrupted.• The file format is not supported by your camcorder.• Only the file name is displayed if the directory structure complies with the international standard.

Adjusting the image during recording

Symptom	Explanation/Solution
Focus does not adjust automatically.	<ul style="list-style-type: none">• Set Focus to Auto. (Video recording mode only) ➔page 48• The recording conditions are not suitable for auto focus. Adjust the focus manually. (Video recording mode only) ➔page 48• The lens is dusty on the surface. Clean the lens and check the focus.• Recording is being made in a dark location. Use a light to brighten the area.

Troubleshooting

Adjusting the image during recording

Symptom	Explanation/Solution
Image's color balance is not natural.	<ul style="list-style-type: none">The white balance is incorrect. Set the proper White Balance. ▶page 45
A subject passing quickly through the frame appears distorted.	<ul style="list-style-type: none">This is called the focal plane phenomenon. This is not a malfunction. Because of the way the image device (CMOS sensor) reads out video signals, a subject passing through a frame rapidly may appear to bend, depending on the recording conditions.

Playback on your camcorder

Symptom	Explanation/Solution
Playback (playback/pause) function does not work.	<ul style="list-style-type: none">Image files recorded using another device may not play back on your camcorder.Check memory card compatibility. ▶page 17
Photo images stored on a storage media are not displayed in the actual size.	<ul style="list-style-type: none">Photo images recorded on other devices may not appear in their actual size. This is not an error.
Playback is interrupted unexpectedly.	<ul style="list-style-type: none">Check if the AC power adaptor or battery back is properly connected and secure.

Playback on other devices (TV, etc.)

Symptom	Explanation/Solution
You cannot view the image on or hear the sound from the connected device.	<ul style="list-style-type: none">Make sure that the connection cable is connected to the proper jack.
The image appears distorted on a TV.	<ul style="list-style-type: none">This phenomenon is caused by connecting to a TV with 4:3 aspect ratio.
You cannot view the image on or hear the sound from a TV connected using the HDMI cable.	<ul style="list-style-type: none">The camcorder cannot output Images from the HDMI jack if the material is copyright protected.

Troubleshooting

Connecting/Dubbing with other devices (Recorder, PC, Printer, etc.)

Symptom	Explanation/Solution
You cannot dub correctly using the HDMI cable.	<ul style="list-style-type: none">You cannot dub images using the HDMI cable.
You cannot dub correctly using the Audio/Video cable.	<ul style="list-style-type: none">The Audio/Video cable is not connected properly. Make sure that the Audio/Video cable is connected to the proper jack, i.e. to the input jack of the device used for dubbing images from your camcorder. ➔page 85
Your PictBridge printer cannot print photos from your camcorder.	<ul style="list-style-type: none">Your printer may not print images edited on a computer or recorded using other devices. This is not an error.

Connecting to a computer

Symptom	Explanation/Solution
Your computer does not recognize your camcorder.	<ul style="list-style-type: none">Disconnect the USB cable from the computer and camcorder, restart the computer, and then connect the USB cable again correctly.
Cannot play back a video file properly on a PC.	<ul style="list-style-type: none">You need a video codec to play back the file recorded on your camcorder. Install the software provided with your camcorder. ➔page 89Make sure you insert the connector in the correct orientation, and connect the USB cable to the micro USB jack on your camcorder firmly.Disconnect the cable from the computer and camcorder, restart the computer, and then connect the cable again properly.To play back an HD video file, you need a computer with better specifications. Use a computer with the recommended specifications. ➔page 88
Intelli-studio does not function properly.	<ul style="list-style-type: none">Exit the Intelli-studio application, and restart the Windows computer.
Intelli-studio does not start.	<ul style="list-style-type: none">Set PC Software to On in the Settings menu or install Intelli-studio on the computer. ➔pages 89, 103

Troubleshooting

Connecting to a computer

Symptom	Explanation/Solution
Your computer is not playing videos, images, or sound located on your camcorder properly.	<ul style="list-style-type: none">• Video playback or sound may stop temporarily depending on your computer. The video or sound copied to your computer is not affected.• If your camcorder is connected to a computer that does not support Hi-speed USB (micro USB 2.0), the image or sound may not play back correctly. Images, video, and sound copied from the camcorder to your computer are not affected.
The playback screen is paused or distorted.	<ul style="list-style-type: none">• Check the system requirements to play a video.• Shut down all other applications currently running on the computer.• If you play back a video on your camcorder when it is connected to a computer, the video may not play back smoothly on the computer, depending on the transfer speed. Please copy the file to your PC, and then play it back.

Overall operations

Symptom	Explanation/Solution
The date and time are incorrect.	<ul style="list-style-type: none">• Has the camcorder been left unused for a long period of time? The backup internal rechargeable battery may be discharged. ➡ page 20

Maintenance

Cautions when storing

- To protect the camcorder:
 - Turn it off
 - Remove the battery.
 - Remove the memory card.

Cleaning the camcorder

Before cleaning, turn off the camcorder and remove the battery.

- **To clean the exterior**
 - Wipe gently with a soft, dry cloth. Do not apply excessive force when cleaning. Gently rub the surface.

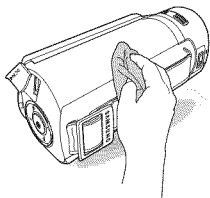

Do not use benzene or thinner to clean the camcorder. The exterior coating could peel off or the case could deteriorate.

- **To clean the LCD screen**

Wipe very gently with a soft, dry cloth. Be careful not to damage the screen.

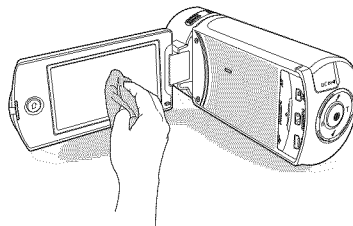

- **To clean the lens**

Use a blower brush to remove dust, and then wipe the lens gently with a soft cloth.

If necessary, wipe gently with lens paper or tissue.

- Mold may form if the lens is left dirty.
- If the lens looks dim, turn off the camcorder and leave it off for about 1 hour.

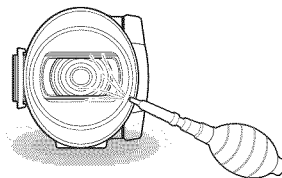

Maintenance

LCD screen

- To prolong its service life, do not rub the LCD screen with a coarse cloth.
- Be aware of the following LCD screen phenomena. They are not malfunctions.
 - When you use the camcorder, the surface around the LCD screen may heat up.
 - If you leave the power on for a long time, the surface around the LCD screen becomes hot.
 - When using the camcorder in cold conditions, an afterimage may appear on the LCD screen.
- An LCD screen is manufactured using advanced technology which creates screens with pixel failure rates of less than 0.01%. However, a black or bright spot (red, blue, white) may appear in the center of the LCD screen and up to two spots may appear outside the center. These spots, which are normally incurred during the manufacturing process, do not affect the recorded images.



When there is dew condensation, put the camcorder aside for a while before using

- What is dew condensation?

Dew condensation happens when a camcorder is moved to a location where there is a significant temperature difference from the previous location. The dew condenses on the external or internal parts of the camcorder, and on the reflection lens. If there is dew on or in your camcorder, it may cause the camcorder to malfunction or damage the camcorder when you turn the power on.

- Exactly when does dew condensation occur?

When you move the camcorder to a location with a higher temperature than the previous location, or when you move it to a hot area suddenly. Examples:

- You record outside in cold weather during the winter and then move the camcorder in indoors.

- You record outside in hot weather after being indoors or inside a car where the A/C was running.

- What can I do?

- Turn the power off, detach the battery, and leave the camcorder in a dry area for 1~2 hours before using it.



- Use the camcorder only after dew condensation has completely disappeared.

- Be sure to use the recommended accessories supplied with the camcorder. For service, contact your nearest Samsung authorized service center.

Using your camcorder abroad

Each country or region has its own electric and color systems. Before using your camcorder abroad, check the following items.

Power sources

The AC adaptor provided lets you power, recharge, and use your camcorder in any country/region that has AC power in the 100 V to 240 V, 50/60 Hz range. You may need a commercially available AC plug adaptor depending on the design of local wall outlets.

On TV color systems

Your camcorder is an NTSC based camcorder. If you want to view your recordings on a TV or copy them to an external device, it must be an NTSC based TV or external device and have the appropriate Audio/Video jacks. Otherwise, you may need to use a separate video format transcoder (For example, an NTSC to PAL format converter).



The format transcoder is not provided by Samsung.

NTSC-compatible countries/regions

Bahamas, Canada, Central America, Japan, Korea, Mexico, Philippines, Taiwan, United States of America, etc.

PAL-compatible countries/regions

Australia, Austria, Belgium, Bulgaria, China, CIS, Czech Republic, Denmark, Egypt, Finland, France, Germany, Greece, Great Britain, Holland, Hong Kong, Hungary, India, Iran, Iraq, Kuwait, Libya, Malaysia, Mauritius, Norway, Romania, Saudi Arabia, Singapore, Slovak Republic, Spain, Sweden, Switzerland, Syria, Thailand, Tunisia, etc.



You can make recordings with your camcorder and view pictures on the LCD screen anywhere in the world.

Glossary

AF (Auto Focus)

A system that automatically focuses the camcorder lens on the subject. Your camcorder uses the contrast to focus automatically.

Aperture

The aperture controls the amount of light that reaches the camcorder's sensor.

Camcorder shake (Blur)

If the camcorder is moved while the shutter is open, the entire image may appear blurred. This occurs more often when the shutter speed is slow. Prevent camcorder shake by raising the sensitivity, using a faster shutter speed. Alternately, use a tripod, the DIS or OIS function to stabilize the camcorder.

Composition

Composition in photography means arranging objects in a photo. Usually, abiding by the rule of thirds leads to a good composition.

Complementary Metal-Oxide-Semiconductor (CMOS)

CMOS is an image sensor producing images approaching the quality of CCD (charge coupled device) sensors. It consumes less power, meaning a longer battery life on your camcorder.

Digital zoom

A feature that artificially increases the amount of zoom available with zoom lens (Optical zoom). When using the Digital zoom, the image quality will deteriorate as the magnification increases.

Effective Pixel Count

Unlike the total pixel count, this is the actual number of pixels used to capture an image.

EV (Exposure Value)

All the combinations of the camcorder's shutter speed and lens aperture that result in the same exposure.

Exposure

The amount of light allowed to reach the camcorder's sensor. Exposure is controlled by a combination of the shutter speed, the aperture value, and ISO sensitivity.

Focal length

The distance from the middle of the lens to its focal point (in millimeters). Longer focal lengths result in narrower angles of view and the subject is magnified. Shorter focal lengths result in wider angles of view.

F. No (F-Number)

The f-number defines the brightness of lens. Smaller number lens has generally brighter image. The f-number is directly proportional to the focal length and inversely proportional to the lens diameter.

*F.No=focal length/diameter of lens aperture

MPEG-4 AVC/H.264

MPEG-4 AVC/H.264 defines the latest video coding format standardized by the ISO-IEC and the ITU-T, in 2003. Compared with the conventional MPEG-2 format, MPEG-4 AVC/H.264 has more than twice the efficiency. Your camcorder employs MPEG-4 AVC/H.264 to encode high definition videos.

Optical zoom

This is a general zoom which can enlarge images with a lens and does not deteriorate quality of images.

Quality

An expression of the rate of compression used in a digital image. Higher quality images have a lower rate of compression, which usually results in a larger file size.

Resolution

The number of pixels present in a digital image. High resolution images contain more pixels and typically show more detail than low resolution images.

Shutter speed

Shutter speed refers to the amount of time it takes to open and close the shutter, and it is an important factor in the brightness of a photo, as it controls the amount of light which pass through the aperture before it reaches the image sensor. A fast shutter speed allows less time to let light in and the photo becomes darker and more easily freezes subjects in motion.

Tele Macro

This feature allows you to capture close-up images of very small objects. When using the Tele Macro feature, the camcorder can maintain a sharp focus on small objects at a near life-size ratio (1:1).

White balance (color balance)

An adjustment of the intensities of colors (typically the primary colors red, green, and blue), in an image. The goal of adjusting the white balance, or color balance, is to correctly render the colors in an image.

Specifications

Model name	HMX-Q20BN/HMX-Q20TN/HMX-Q20RN HMX-Q200BN/HMX-Q200TN/HMX-Q200RN HMX-QF20BN	
System	Video signal	NTSC
	Picture compression format	H.264 (MPEG-4.AVC)
	Audio compression format	AAC (Advanced Audio Coding)
	Image device	1/4" CMOS
	Effective pixels	1.75 mega pixels
	Total pixels	5.1 mega pixels
	Lens	F1.8 ~ F3.9, X20 Optical Zoom, X40 Digital Zoom
	Focal length	2.6mm ~ 52mm
LCD screen	Wireless networking protocol	WiFi (802.11b/g/n)
	Size/dot number	2.7" Wide Touch LCD / 230k
Connectors	LCD screen method	TFT LCD
	Composite output	1Vp-p (75 Ω terminated)
	HDMI output	D type connector
General	USB output	micro USB 2.0
	Power source	DC 5 V, Lithium Ion battery 3.7 V
	Power source type	Lithium Ion battery, Power supply (100 V ~ 240 V) 50/60 Hz
	Power consumption	HMX-Q20/HMX-Q200: 2.5W, HMX-QF20: 3.0W (LCD on)
	Operating temperature	32 °F ~ 104 °F (0 °C ~ 40 °C)
	Operating humidity	40% ~ 60%
	Storage temperature	-4 °F ~ 140 °F (-20 °C ~ 60 °C)
	Storage media	Memory card (SD/SDHC/SDXC) (not supplied)
	External dimensions (W x H x D)	Approx. 42.8mm (1.69 inches) x 52.45mm (2.06 inches) x119mm (4.69 inches)
	Weight	Approx. 180g (0.37 lb, 6 oz) (Except for Lithium Ion battery)
Internal MIC	Omni-directional stereo microphone	

* The technical specifications and design may be changed without notice.



FCC ID : A3LHMXQF20BN

This device complies with part 15 of the FCC Rules. Operation is subject to the following two conditions: (1) This device may not cause harmful interference, and (2) this device must accept any interference received, including interference that may cause undesired operation.

Caution:

Any changes or modifications in construction of this device which are not expressly approved by the party responsible for compliance could void the user's authority to operate the equipment.

Note:

This equipment has been tested and found to comply with the limits for a Class B digital device, pursuant to part 15 of the FCC Rules. These limits are designed to provide reasonable protection against harmful interference in a residential installation. This equipment generates, uses and can radiate radio frequency energy and, if not installed and used in accordance with the instructions, may cause harmful interference to radio communications. However, there is no guarantee that interference will not occur in a particular installation. If this equipment does cause harmful interference to radio or television reception, which can be determined by turning the equipment off and on, the user is encouraged to try to correct the interference by one or more of the following measures:

- Reorient or relocate the receiving antenna.
- Increase the separation between the equipment and receiver.
- Connect the equipment into an outlet on a circuit different from that to which the receiver is connected.
- Consult the dealer or an experienced radio/TV technician for help.

RF exposure statements:

This device is for handheld operation only. The antenna(s) used for this transmitter must be installed to provide a separation distance of at least 20 cm from all persons and must not be co-located or operating in conjunction with any other antenna or transmitter.

Warranty

SAMSUNG LIMITED WARRANTY

SAMSUNG Electronics America Inc. (SEA), warrants that this product is free from defective material and workmanship.

SEA further warrants that if product fails to operate properly within the specified warranty period and the failure is due to improper workmanship or defective material, SEA will repair or replace the product at it's option.

All warranty repairs must be performed by a SEA authorized service center. The name and address of the location nearest you can be obtained by calling toll free: 1-800 SAMSUNG (1-800-726-7864).

Labor

1 year carry-in

Parts

1 year

On carry-in models, transportation to and from the service center is the customer's responsibility.

The original dated sales receipt must be retained by the customer and is the only acceptable proof of purchase.

It must be presented to the authorized service center.

EXCLUSIONS (WHAT IS NOT COVERED)

This warranty does not cover damage due to accident, fire, flood and/or other acts of God; misuse, incorrect line voltage, improper installation, improper or unauthorized repairs, commercial use, or damage that occurs in shipping.

Exterior and interior finish, lamps, and glass are not covered under this warranty.

Customer adjustments which are explained in the instruction manual are not covered under the terms of this warranty.

This warranty will automatically be voided for any unit found with a missing or altered serial number. This warranty is valid only on products purchased in the United States and Puerto Rico.

Some States do not allow the exclusions or limitations of incidental or consequential damages, or allow limitations on how long an implied warranty lasts, so the above limitations or exclusions may not apply to you.

This warranty gives you specific legal rights, and you may also have other rights which vary from State to State.



Correct disposal of batteries in this product

(Applicable in the European Union and other European countries with separate battery return systems)

This marking on the battery, manual or packaging indicates that the batteries in this product should

not be disposed of with other household waste at the end of their working life. Where marked, the chemical symbols Hg, Cd or Pb indicate that the battery contains mercury, cadmium or lead above the reference levels in EC Directive 2006/66. If batteries are not properly disposed of, these substances can cause harm to human health or the environment.

To protect natural resources and to promote material reuse, please separate batteries from other types of waste and recycle them through your local, free battery return system.

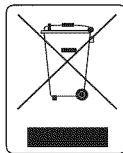

Correct Disposal of This Product (Waste Electrical & Electronic Equipment)

(Applicable in the European Union and other European countries with separate collection systems)

This marking shown on the product or its literature, indicates that it should not be disposed with other household wastes at the end of its working life.

To prevent possible harm to the environment or human health from uncontrolled waste disposal, please separate this from other types of wastes and recycle it responsibly to promote the sustainable reuse of material resources. Household users should contact either the retailer where they purchased this product, or their local government office, for details of where and how they can take this item for environmentally safe recycling. Business users should contact their supplier and check the terms and conditions of the purchase contract. This product should not be mixed with other commercial wastes for disposal.



QUESTIONS OR COMMENTS?

COUNTRY	CALL	OR VISIT US ONLINE AT	WRITE
IN THE US	1-800-SAMSUNG (726-7864)	www.samsung.com	Samsung Electronics America, Inc. 85 Challenger Road Ridgefield Park, NJ 07660-2112



RoHS compliant

Our product complies with "The Restriction Of the use of certain Hazardous Substances in electrical and electronic equipment", and we do not use the 6 hazardous materials- Cadmium (Cd), Lead (Pb), Mercury (Hg), Hexavalent Chromium (Cr +6), Poly Brominated Biphenyls (PBBs), Poly Brominated Diphenyl Ethers (PBDEs)- in our products.