

Use & Care Guide

Manual de Uso y Cuidado

English / Español

Models/Modelos: 790.9750*

Kenmore Elite[®]

Double Oven Range

Estufa con un doble horno

* = Color number, número de color

P/N 318205220A (1201)

Sears Brands Management Corporation

Hoffman Estates, IL 60179 U.S.A.

www.kenmore.com

www.sears.com



Table of Contents

Appliance Warranty	2
Product Record.....	2
Serial Plate Location	2
IMPORTANT SAFETY INSTRUCTIONS	3-5
Range Features	6
Before Setting Surface Controls	7-8
Setting Surface Controls	9-12
Surface Cooking	13
Before Setting the Oven Controls.....	14

Control Pad Features.....	15
Setting the Clock	16-17
Consumer Defined Control	18-19
Setting Oven Controls.....	20-32
Self-Cleaning.....	33-35
Adjusting the Oven Temperature.....	35
General Care & Cleaning	36-38
Before You Call	39-41
Notes	42
Protection Agreements.....	43
Sears Service.....	44

Kenmore Elite Limited Warranty

When installed, operated and maintained according to all instructions supplied with the product, if this appliance fails due to a defect in material and workmanship within one year from the date of purchase, call 1-800-4-MY-HOME® to arrange for free repair.

This warranty applies for only 90 days from the date of purchase if this appliance is ever used for other than private family purposes.

This warranty covers only defects in material and workmanship. Sears will NOT pay for:

1. Cracks in a ceramic glass cooktop that are not a result of thermal shock.
2. Stains and scratches on a ceramic glass cooktop resulting from accident or improper operation or maintenance.
3. Expendable items that can wear out from normal use, including but not limited to filters, belts, light bulbs, and bags.
4. A service technician to instruct the user in correct product installation, operation or maintenance.
5. A service technician to clean or maintain this product.
6. Damage to or failure of this product if it is not installed, operated or maintained according to the all instructions supplied with the product.
7. Damage to or failure of this product resulting from accident, abuse, misuse or use for other than its intended purpose.
8. Damage to or failure of this product caused by the use of detergents, cleaners, chemicals or utensils other than those recommended in all instructions supplied with the product.
9. Damage to or failure of parts or systems resulting from unauthorized modifications made to this product.

Disclaimer of implied warranties; limitation of remedies

Customer's sole and exclusive remedy under this limited warranty shall be product repair as provided herein. Implied warranties, including warranties of merchantability or fitness for a particular purpose, are limited to one year or the shortest period allowed by law. Sears shall not be liable for incidental or consequential damages. Some states and provinces do not allow the exclusion or limitation of incidental or consequential damages, or limitation on the duration of implied warranties of merchantability or fitness, so these exclusions or limitations may not apply to you.

This warranty applies only while this appliance is used in the United States or Canada.

This warranty gives you specific legal rights, and you may also have other rights which vary from state to state.

Sears Brands Management Corporation, Hoffman Estates, IL 60179 - Sears Canada Inc., Toronto, Ontario, Canada M5B 2B8

Product Record

In this space below, record the date of purchase, model and serial number of your product. You will find the model and serial number printed on the serial plate.

Model No. **790.** _____

Serial No. _____

Date of purchase _____

Save these instructions and your sales receipt for future reference.

Please carefully read and save these instructions

This Use & Care Guide contains general operating instructions for your appliance and feature information for several models. Your product **may not** have all the described features. The graphics shown are representative. The graphics on your appliance may not look exactly like those shown. Common sense and caution must be practiced when installing, operating and maintaining any appliance.

Serial Plate Location

You will find the model and serial number printed on the serial plate. The serial plate is located as shown.

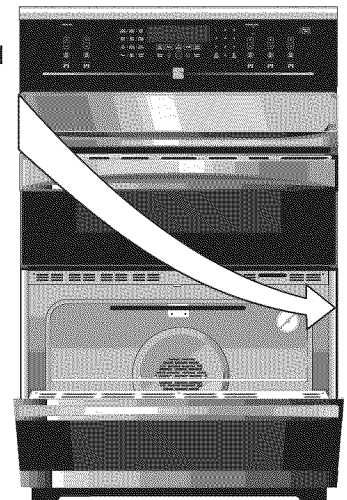

IMPORTANT SAFETY INSTRUCTIONS

Read all instructions before using this appliance.

This manual contains important safety symbols and instructions. Please pay attention to these symbols and follow all instructions given.

⚠ WARNING This symbol will help alert you to situations that may cause serious bodily harm, death or property damage.

⚠ CAUTION This symbol will help alert you to situations that may cause bodily injury or property damage.

- Remove all tape and packaging before using the appliance. Destroy the carton and plastic bags after unpacking the appliance. Never allow children to play with packaging material.
- Proper Installation. Be sure your appliance is properly installed and grounded by a qualified technician in accordance with National Electrical Code ANSI/NFPA No.70 (USA) or CSA C22.1, PART 1 (Canada)-latest edition and local code requirements. Install only per installation instructions provided in the literature package for this appliance.
- In case of an emergency, know how to disconnect the electrical power to the appliance at the circuit breaker or fuse box.
- User Servicing. Do not repair or replace any part of the appliance unless specifically recommended in the manuals. All other servicing should be done only by a qualified technician to reduce the risk of personal injury and damage to the appliance. Sears Parts & Repair is the recommended repair service for this appliance.
- Never modify or alter the construction of an appliance by removing panels, wire covers or any other part of the product.
- Remove the oven door from any unused appliance if it is to be stored or discarded.

⚠ WARNING Tip Over Hazard

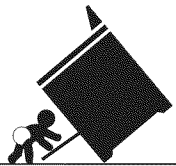

- A child or adult can tip the range and be killed.
- Verify the anti-tip device has been installed to floor or wall.
- Ensure the anti-tip device is re-engaged to floor or wall when the range is moved.
- Do not operate the range without the anti-tip device in place and engaged.
- Failure to follow these instructions can result in death or serious burns to children and adults.



Range
Leveling
Leg

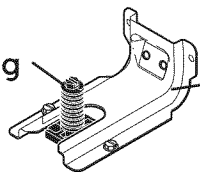

Anti-Tip
Bracket

To check if the anti-tip bracket is installed properly, use both arms and grasp the rear edge of range back. Carefully attempt to tilt range forward. When properly installed, the range should not tilt forward.

Refer to the anti-tip bracket installation instructions supplied with your range for proper installation.

⚠ WARNING Stepping, leaning, sitting or pulling down on the door of this appliance can result in serious injuries and may also cause damage to the appliance. Do not allow children to climb or play around the appliance.

• Storage on Appliance. Flammable materials should not be stored near surface units. This includes paper, plastic and cloth items, such as cookbooks, plasticware and towels, as well as flammable liquids. Do not store explosives, such as aerosol cans, on or near the appliance. Flammable materials may explode and result in fire or property damage.

⚠ WARNING Do not use the ovens for storage.

⚠ CAUTION Do not store items of interest to children in the cabinets above an appliance. Children climbing on the appliance to reach items could be seriously injured.

• Do not leave children alone. Children should not be left alone or unattended in the area where an appliance is in use. They should never be allowed to sit or stand on any part of the appliance.

IMPORTANT SAFETY INSTRUCTIONS

- **DO NOT TOUCH SURFACE UNITS, AREAS NEAR THESE SURFACES, OVEN HEATING ELEMENTS OR INTERIOR SURFACES.** Surface units may be hot even though they are dark in color. Areas near surface units may become hot enough to cause burns. During and after use, do not touch, or let clothing or other flammable materials touch these areas until they have had sufficient time to cool. Among these areas are the cooktop, surfaces facing the cooktop, the oven vent openings and surfaces near these openings, oven door and window.
 - **Wear Proper Apparel. Loose-fitting or hanging garments should never be worn while using the appliance.** Do not let clothing or other flammable materials contact hot surfaces.
- ⚠ WARNING** Never use your appliance for warming or heating the room.
- **Do Not Use Water or Flour on Grease Fires.** Smother the fire with a pan lid, or use baking soda, a dry chemical or foam-type extinguisher.
 - **When heating fat or grease, watch it closely.** Fat or grease may catch fire if allowed to become too hot.
 - **Use Only Dry Potholders.** Moist or damp potholders on hot surfaces may result in burns from steam. Do not let the potholders touch hot heating surface units. Do not use a towel or other bulky cloth instead of a potholder.
 - **Do Not Heat Unopened Food Containers.** Buildup of pressure may cause the container to burst and result in injury.

IMPORTANT—Do not attempt to operate the appliance during a power failure. If power fails, always turn off the appliance. If the appliance is not turned off and the power resumes, it will begin to operate again. Once the power resumes, reset the clock and oven function.

IMPORTANT INSTRUCTIONS FOR USING YOUR COOKTOP

- **Know which knob controls each surface heating unit.** Place a pan of food on the unit before turning it on, and then turn the unit off before removing the pan.
- **Use proper pan size.** This appliance is equipped with one or more surface units of different sizes.

Select utensils having flat bottoms large enough to cover the surface unit. The use of undersized utensils will expose a portion of the surface heating unit to direct contact and may result in ignition of clothing. Proper relationship of utensil to the surface unit will also improve efficiency.

- **Utensil handles should be turned inward and not extend over adjacent surface units.** To reduce the risk of burns, ignition of flammable materials, and spillage due to unintentional contact with the utensil.
- **Never leave surface units unattended—** Boilovers cause smoking and greasy accumulations that may ignite, or a pan that has boiled dry may melt.
- **Glazed cooking utensils—**Only certain types of glass, glass/ceramic, ceramic, earthenware, or other glazed utensils are suitable for rangetop service without breaking due to the sudden change in temperature. Check the manufacturer's recommendations for cooktop use.

IMPORTANT INSTRUCTIONS FOR USING YOUR OVEN

- **Use Care When Opening an Oven Door—**Stand to the side of the appliance when opening the door of a hot oven. Let hot air or steam escape before you remove or replace food in the oven.
- **Keep Oven Vent Ducts Unobstructed.** The upper oven is vented at the back of the cooktop and the lower oven at the center trim. Touching the surfaces in this area when the oven is operating may cause severe burns. Also, do not place plastic or heat-sensitive items near the oven vent. These items could melt or ignite.

⚠ WARNING NEVER cover any slots, holes or passages in the oven bottom or cover an entire rack with materials such as aluminum foil. Doing so blocks air flow through the oven and may cause carbon monoxide poisoning. Aluminum foil linings may trap heat, causing a fire hazard.

- **Placement of Oven Racks.** Always place oven racks in desired location while oven is cool. Remove all utensils from the rack before removing rack. If rack must be moved while oven is hot, use extreme caution. Use pot holders and grasp the rack with both hands to reposition. Do not let pot holders contact the hot oven element or interior of

IMPORTANT SAFETY INSTRUCTIONS

the oven.

- **Do not use the broiler pan without its insert.** The broiler pan and grid allow dripping fat to drain and be kept away from the high heat of the broiler.
- **Do not cover the broiler grid or oven bottom with aluminum foil.** Exposed fat and grease could ignite.
- **Do not touch a hot oven light bulb with a damp cloth.** Doing so could cause the bulb to break. Disconnect the appliance or shut off the power to the appliance before removing and replacing the bulb.
- **Protective liners—DO NOT USE ALUMINUM FOIL TO LINE THE OVEN BOTTOM.** Only use aluminum foil as recommended in this manual. Improper installation of these liners may result in risk of electric shock, or fire.

SELF-CLEANING OVEN MODELS

- **Clean in the self-cleaning cycle only the parts of the appliance listed in this Use & Care Guide.** Before using the self-cleaning cycle of the appliance, remove the broiler pan and any utensils stored in the appliance.
- **Do not clean the oven door gasket.** The door gasket is essential for a good seal. Care should be taken not to rub, damage or move the gasket.
- **Do not use oven cleaners.** No commercial oven cleaner or oven liner protective coating of any kind should be used in or around any part of the appliance

⚠ CAUTION The health of some birds is extremely sensitive to the fumes given off during the self-clean cycle of any oven. Move birds to another well ventilated room.

IMPORTANT INSTRUCTIONS FOR CLEANING YOUR OVEN

- **Clean the appliance regularly to keep all parts free of grease that could catch fire.** Exhaust fan ventilation hoods and grease filters should be kept clean. Do not allow grease to accumulate. Greasy deposits in the fan could catch fire. Refer to the hood manufacturer's instructions for cleaning.
- **Clean Ventilating Hoods Frequently—**Grease should not be allowed to accumulate on the hood or filter. Follow manufacturer's instructions for cleaning.

FOR CERAMIC GLASS COOKTOPS

- **Do not clean or operate a broken cooktop—**If cooktop should break, cleaning solutions and spillovers may penetrate the broken cooktop and create a risk of electric shock. Contact a qualified technician immediately.
- **Clean cooktop glass with caution—**If a wet sponge or cloth is used to wipe spills on a hot cooking area, be careful to avoid a steam burn. Some cleaners can produce harmful fumes if applied to a hot surface.
- Avoid scratching the cooktop glass with sharp objects.

IMPORTANT SAFETY NOTICE

The California Safe Drinking Water and Toxic Enforcement Act requires the Governor of California to publish a list of substances known to the state to cause cancer, birth defects or other productive harm, and requires businesses to warn customers of potential exposure to such substances.

SAVE THESE INSTRUCTIONS FOR FUTURE REFERENCE.

Range Features

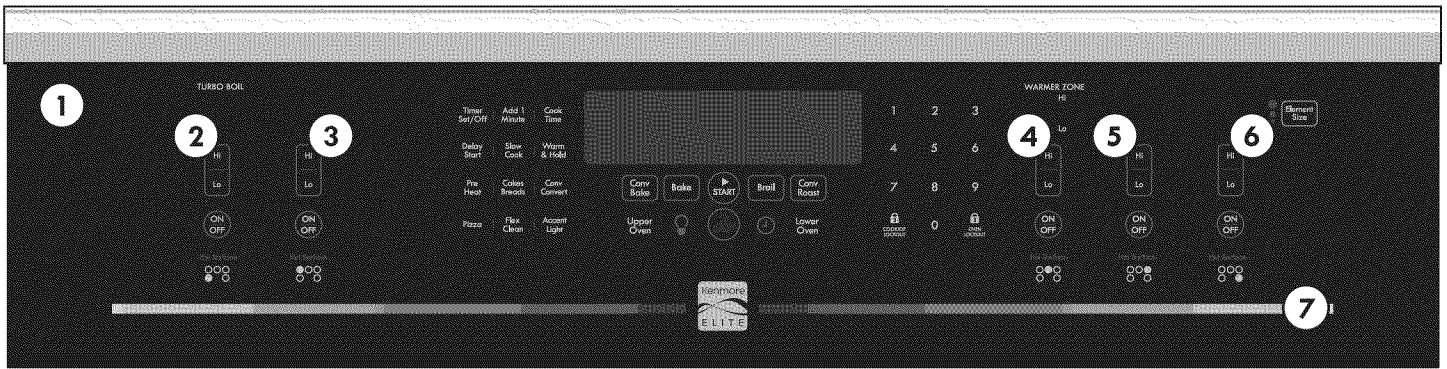

Your Range includes:

1. Electronic oven control with kitchen timer.
2. Left front element control and electronic display.
3. Left rear element control and electronic display.
4. Keep warm zone control.
5. Right rear element control and electronic display.
6. Right front element control and electronic display.
7. Decorative accent light.

8. Lower oven self-clean door latch.
9. Lower oven vent.
10. Broil element.
11. Self-cleaning convection oven interior.
12. Lower oven convection bake cooking system.
13. Oven interior light with removable cover.
14. Adjustable interior porcelain oven rack(s).
15. Large 1-piece oven door handle.
16. Full width lower oven door with window.
17. Full width upper oven door with window.

18. 6" single radiant element.
19. Warm and Ready element.
20. 6" single radiant element.
21. 9" turbo radiant element.
22. 6" / 9" / 12" triple radiant element.
23. Ceramic glass cooktop.

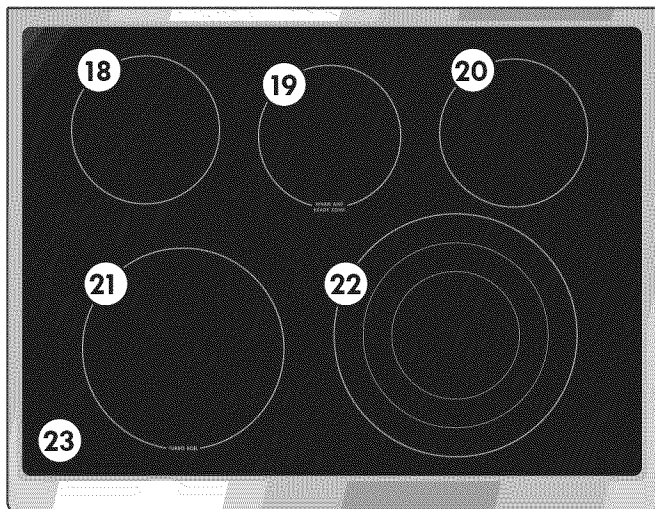
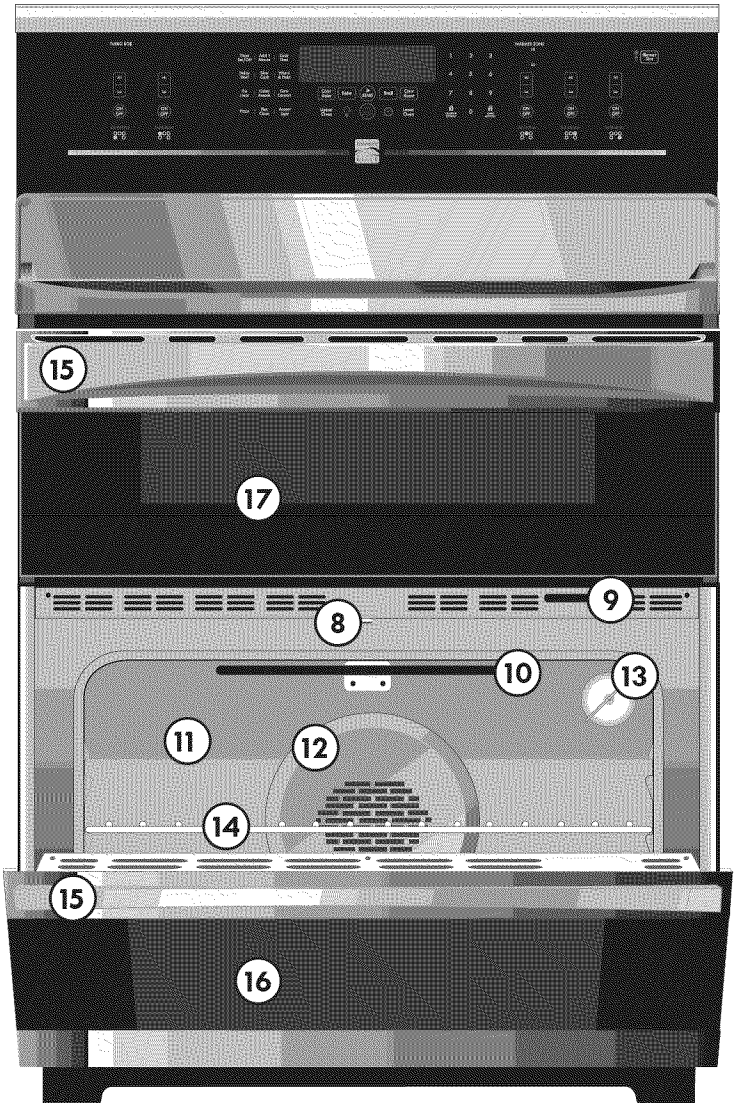

NOTE: The features of your range may vary according to model type & color.

Before Setting Surface Controls

About the Ceramic Glass Cooktop

The ceramic cooktop has radiant surface elements located below the surface of the glass. The design of the ceramic cooktop outlines the area of the surface element underneath. **Make sure** the diameter of the pan matches the diameter of the element outline on the cooktop (See Figure 1).

Heat is transferred up through the surface of the cooktop to the cookware. Only flat-bottom cookware should be used. The type and size of cookware, the number of surface elements in use and their settings, are all factors that will affect the amount of heat that will spread to areas beyond the surface elements.

CAUTION The areas surrounding the elements may become hot enough to cause burns.

About the Radiant Surface Elements

The element temperature rises gradually and evenly. As the temperature rises, the element will glow red. To maintain the selected setting, the element will cycle on and off. The heating element retains enough heat to provide a uniform and consistent heat during the off cycle. **For efficient cooking, turn off the element several minutes before cooking is complete.** This will allow residual heat to complete the cooking process.

Locations of the Radiant Surface Elements and Controls

Your range is equipped with radiant surface burners with different wattage ratings. The ability to heat food quicker and in larger volumes increases as the element wattage increases. The radiant surface elements are located on the cooktop as follows:

- two **6 inch** radiant elements located at the right and left rear positions;
- a **6 / 9 / 12 inch** triple element located at the right front position;
- a **9 inch** turbo boil radiant element located at the left front position.
- a **Warm & Ready Zone** located at the center rear position;

Note: (White glass cooktops only) Due to the high intensity of heat generated by the surface elements, the glass surface will turn green when the element is first turned off. This phenomenon is normal and the glass will come back to its original white color after it has completely cooled down.

CAUTION Radiant surface elements may appear to have cooled after they have been turned off. **The glass surface may still be hot** and burns may occur if the glass surface is touched before it has cooled sufficiently.

CAUTION Do not place plastic items such as salt and pepper shakers, spoon holders or plastic wrappings on top of the range when it is in use. These items could melt or ignite. Pot holders, towels or wooden spoons could catch fire if placed too close to the surface elements.

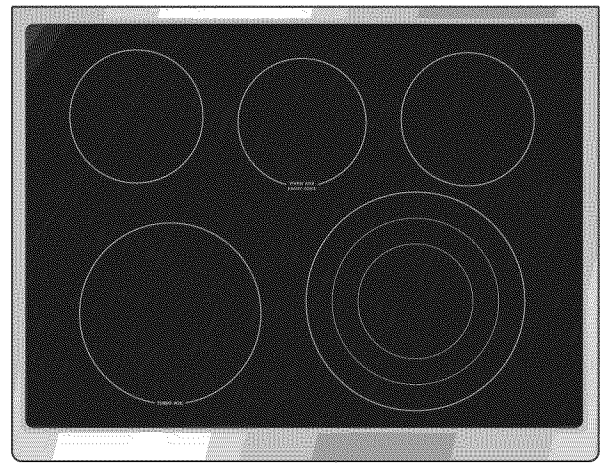

Figure 1

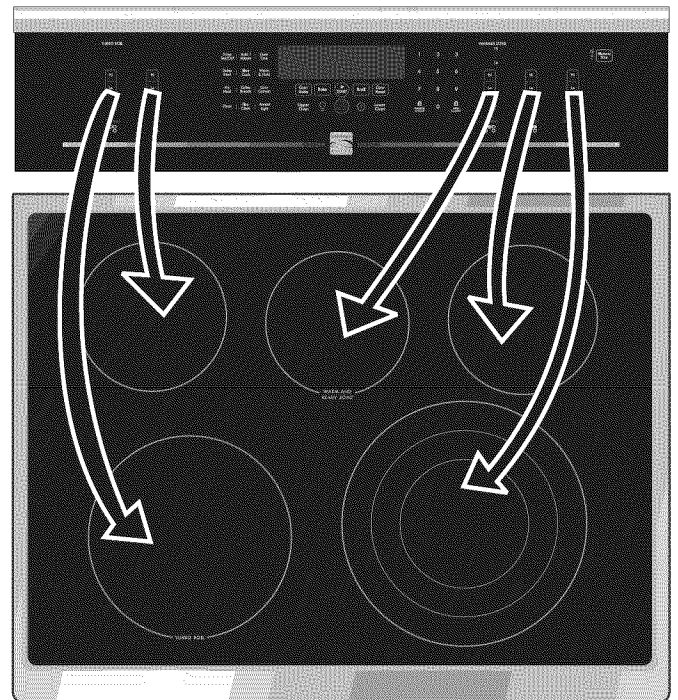

Figure 2

Note: Please read detailed instructions for ceramic glass cooktop cleaning in the **General Care & Cleaning** section and **Before You Call** checklist section of this Use and Care Guide.

Note: Radiant elements have a limiter that allows the element to cycle on and off, even at the HI setting. This helps to prevent damage to the ceramic glass cooktop. Cycling at the HI setting is normal and can also occur if the cookware is too small for the radiant element or if the cookware bottom is not flat.

Before Setting Surface Controls (cont'd)

To Set the Cooktop Lockout Feature



The **COOKTOP LOCKOUT** pad is used to activate the Cooktop Lockout feature which will lock all surface elements from being accidentally turned ON. This feature will only lock the cooktop.

INSTRUCTIONS

To turn the Cooktop Lockout Feature ON:

1. BE SURE ALL surface element controls are set to the OFF position.
2. Press and hold for 3 seconds **COOKTOP LOCKOUT** until two appears in the display (Figure 1). If a triple beep sounds instead, check all surface elements and turn them to the OFF position and repeat this step. The two will appear in the display indicating the cooktop controls and functions are locked out until the cooktop is unlocked. Whenever the Cooktop Lockout feature is active, " - " will appear in all of the surface element display windows.

PRESS



DISPLAY



Figure 1

To turn the Cooktop Lockout Feature OFF:

1. Press and hold for 3 seconds **COOKTOP LOCKOUT** until the two disappears from the display (Figure 2). This will indicate the cooktop may be used normally.



Figure 2

Note: Starting a Self-Clean cycle will automatically turn ON the Cooktop Lockout feature. The cooktop will remain locked until the Self-Clean cycle has completed and the oven door has unlocked.

Note: If a power failure occurs after the Cooktop Lockout has been activated, you must turn OFF the Cooktop Lockout feature before being able to use the cooktop features again.

Setting Surface Controls

The Electronic Surface Element Control (ESEC)

The Electronic Surface Element Control (ESEC) feature provides a digital display of the radiant surface elements on the cooktop. The ESEC display in combination with the touch pads is designed to replace conventional control knobs.

The available ESEC Window Display Settings

The ESEC control will display heat levels ranging from **Hi** (Figure 1) to **Lo** (Figure 6) and **OFF** (Figure 7). The settings between **9.0** (Figure 2) and **3.0** (Figure 3) decrease or increase in increments of .5 (1/2). The settings between **3.0** (Figures 3 & 4) and **1.2** (Figure 5) are Simmer settings which decrease or increase in increments of .2 (1/5) to **Lo** (Figure 6; lowest Simmer setting) for more precise settings at lower heat levels. Use the Recommended Surface Setting Chart to determine the correct setting for the kind of food you are preparing.

ESEC Lockout Feature (- -)

The ESEC feature will not operate during a Self-Clean cycle or when the Cooktop Lockout feature is active. Whenever the Cooktop Lockout feature is active, “ - - ” will appear in any display window (See Figure 8).

ESEC Power Failure (PF) message

The ESEC will display the PF message (Figure 9) whenever there has been a power interruption to the appliance. The PF message will disappear by itself after a few seconds.

Hot Surface Indicator Light

When using any of the radiant element positions the cooktop will become very hot. The hot surface indicator light will turn ON when the element is hot enough to cause burns, and will remain ON until the cooktop has cooled enough to be safe to touch.

Note: The hot surface message can turn ON when the upper oven is in self-clean mode.

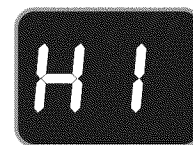

Figure 1



Figure 2



Figure 3



Figure 4



Figure 5



Figure 6

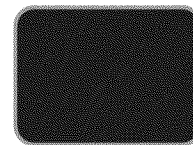

Figure 7

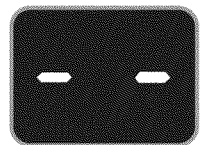

Figure 8



Figure 9



Figure 10

Recommended Settings for Single & Triple Surface Elements

Setting	Type of Cooking
HIGH (8.0 - Hi)	Start most foods, bring water to a boil or pan broiling
MEDIUM HIGH (5.0 - 8.0)	Continue a rapid boil, fry, deep fat fry
MEDIUM (3.0 - 5.0)	Maintain a slow boil, thicken sauces and gravies, steam vegetables
MEDIUM LOW (2.0 - 4.0)	Keep foods cooking, poach, stew (2.8 or lower is a simmer setting).
LOW/SIMMER (Lo - 2.0)	Keep warm, melt, simmer (2.8 or lower is a simmer setting).

Note: The size and type of cookware used will influence the setting needed for best cooking results. The Simmer settings are used to simmer and keep larger quantities of foods warm such as stews and soups. The lower Simmer settings are ideal for delicate foods and melting chocolate or butter.

How the Electronic Surface Element Controls work when the Sabbath feature is ON.

When your Oven Sabbath feature is ON, the Electronic Surface Elements are also in Sabbath mode. This means that all electronic surface element control displays show “Sb” (Figure 10). The surface elements can be used even if the Sabbath Feature is on.

To turn ON a Surface Element when the Oven Sabbath Feature is active:

With the Sabbath feature active, a surface element will not start heating until 15-30 seconds after you turn it on. The heat setting you have turned to will not appear in the display because “Sb” (Figure 10) is showing there. Any adjustment to the heat setting will also take 15 -30 seconds to go into effect.

To turn OFF the Surface Element when the Oven Sabbath Mode is active:

To shut off the surface element while the Sabbath feature is ON, press the ON/OFF button for that element. The element will immediately turn off without delay.

Note: Refer to the Sabbath Feature section.

Setting Surface Controls (cont'd)

Operating Single Radiant Surface Elements

The cooktop has 3 SINGLE radiant surface elements (figure 1): the **RIGHT REAR** position, the **LEFT REAR** position and the **LEFT FRONT** position.

To Operate the Single Radiant Surface Elements:

1. Place correctly sized cookware on the radiant surface element.
2. Touch and hold the  pad for the desired element position until a beep is heard. The display will show "--".

Note: If no further pads are touched within 10 seconds the request to power the element ON will clear.

3. Touch **Hi** pad once to turn ON the power level to HI. Touch **Lo** pad once for Lo power level (See Figure 2).
4. Each touch of the **Hi** or **Lo** pad will decrease or increase the power level from **9.0** through **3.0** by .5 increments. Simmer power levels between **3.0** and **1.2** will decrease or increase by .2 increments. **Lo** is the lowest power level available.

Note: The power level may be adjusted at any time while the element is ON.

5. When cooking has been completed touch the  pad once to turn the element OFF.

Each surface element provides a constant amount of heat at each setting. A glowing red surface heating area extending beyond the bottom edge of the cookware indicates the cookware is **too small** for the surface heating area.

Note: The **Hot Surface** message will be displayed on the control panel as soon as the element is hot and will remain ON until the heating surface area has cooled sufficiently.

CAUTION Radiant surface elements may appear to have cooled after they have been turned off. **The glass surface may still be hot** and burns may occur if the glass surface is touched before it has cooled sufficiently.

CAUTION Do not place plastic items such as salt and pepper shakers, spoon holders or plastic wrappings on top of the range when it is in use. These items could melt or ignite. Potholders, towels or wooden spoons could catch fire if placed too close to the surface elements.

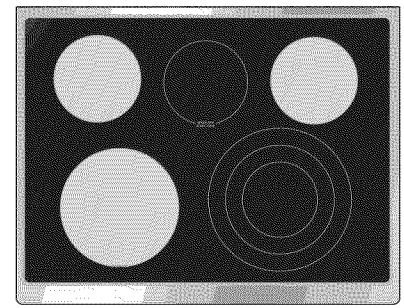

Figure 1
Single Elements

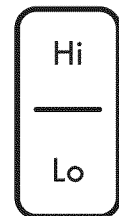
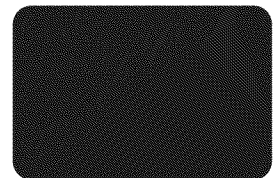





Figure 2

Setting Surface Controls (cont'd)

Operating the Triple Surface Element

The cooktop is equipped with a Triple radiant surface element located at the right front cooktop position (Figure 1). Indicator lights on the control panel at that position are used to indicate what portions of the Triple radiant element will heat. The  light indicates that only the inner element will heat. The  light indicates that both inner and middle elements will heat together. The  light indicates that all 3 portions of the element will heat. You may switch between all of these different settings at any time during cooking.

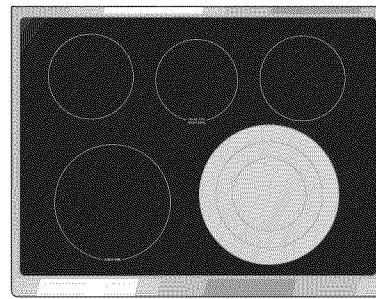

Figure 1

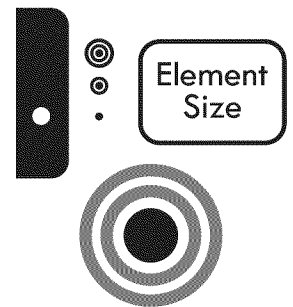

Figure 2

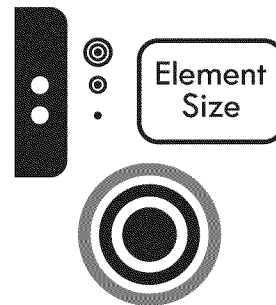

Figure 3

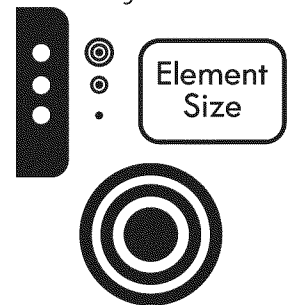





Figure 4

To Operate the Triple Surface Element:

1. Place correctly sized cookware on the radiant surface element.

2. Touch and hold the  pad for the Triple element position until a beep is heard. The display will show “ - - ”.

Note: If no further pads are touched within 10 seconds the request to power the element ON will clear.

3. Select the  (See Figure 2),  (See Figure 3) or  elements (See Figure 4) to heat by pressing the  pad once, twice or three times (Figures 4 show indicator lights with **ALL 3** elements selected).

4. Touch **Hi** pad once to turn ON the power level to HI (See Figure 5). Touch **Lo** pad once for Lo.

5. Each touch of the **Hi** or **Lo** pad will decrease or increase the power level from **9.0** through **3.0** by .5 increments. Simmer power levels between **3.0** and **1.2** will decrease or increase by .2 increments. **Lo** is the lowest power level available.

Note: The power level may be adjusted at any time while the element is ON.

Each surface element provides a constant amount of heat at each setting. Irregular glowing effect is depending of the element design and doesn't affect performance of the element. A glowing red surface heating area extending beyond the bottom edge of the cookware indicates the cookware is **too small** for the surface heating area.

6. When cooking has been completed touch the  pad once to turn the element OFF.

Note: If no element size is chosen when the Triple element is turned ON, the control will default to the inner coil only. See recommended surface cooking settings.

Note: The **Hot Surface** message will be displayed on the control panel as soon as the element is hot and will remain ON until the heating surface area has cooled sufficiently.

CAUTION Radiant surface elements may appear to have cooled after they have been turned off. **The glass surface may still be hot** and burns may occur if the glass surface is touched before it has cooled sufficiently.

CAUTION Do not place aluminum foil or plastic items such as salt and pepper shakers, spoon holders or plastic wrappings on top of the range when it is in use. These items could melt or ignite. Potholders, towels or wooden spoons could catch fire if placed too close to the surface elements.

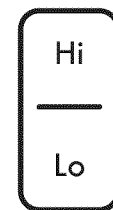
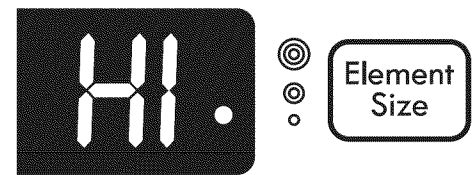

Hot Surface



Figure 5

Setting Surface Controls (cont'd)

Operating the Warmer (Warm & Ready™) Zone

The **Warm & Ready™** zone radiant element is located at the center rear position (Figure 1). The purpose of the Warmer Zone is to keep hot cooked foods at serving temperature. Use the Warmer Zone to keep cooked foods hot such as: vegetables, gravies, casseroles, soups, stews, breads, pastries and oven-safe dinner plates. Always start with hot food. It is not recommended to heat cold food on the Warmer Zone.

All food placed on the warmer zone should be covered with a lid to maintain quality. For best results, when warming pastries or breads, the cover should have an opening to allow moisture to escape. **Do not use plastic wrap or aluminum foil to cover food. Plastic or aluminum may melt onto the surface.**

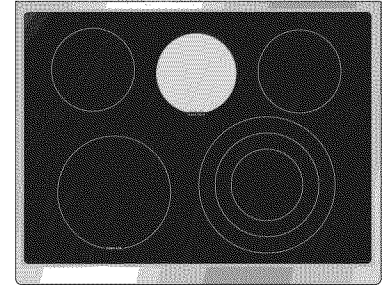

Figure 1

CAUTION The Warmer Zone will not glow red when it is hot, but becomes hot enough to cause burns. Always use potholders or oven mitts when removing food from the warmer zone as cookware and plates will be hot.

Use only plates, utensils and cookware recommended for oven and cooktop use on the Warmer Zone.



Warmer Zone Settings Table	
Food Item	Heating Level
Hot Beverages	HI
Fried Foods	HI
Vegetables	MED
Soups (Cream)	MED
Stews	MED
Sauces	MED
Meats	MED
Gravies	LO
Eggs	LO
Dinner Plates with Food	LO
Casseroles	LO
Breads/Pastries	LO

Warmer Zone Temperature Selection

Refer to the Warmer Zone table for recommended heating levels. If a particular food is not listed, start with the medium level, and adjust as needed. Most foods can be kept at serving temperatures by using the medium level.

To Set the Warmer Zone Control:

The control and indicator lights are located on the control panel.

1. Touch the  pad at the Warmer Zone control position. The Warmer Zone indicator light will flash. Note: If no further pads are touched within 25 seconds the request to power the Warmer Zone ON will clear.
2. At the Warmer Zone controls position touch **Hi** once to turn ON the power level for HI or **Lo** to turn ON the power level for LO. The Warmer Zone Indicator light located beside the  pad will turn on steady and the **Hot Surface** indicator light located on the glass cooktop will turn ON when the Warmer Zone becomes hot.

3. Each touch **Hi** or **Lo** will increase or decrease the power levels. The Warmer Zone has 5 power levels from Hi to Lo (see Figure 2). The power level may be adjusted at any time while the Warmer Zone is ON.
4. When it is time to serve food, touch the  pad once to turn the Warmer Zone OFF. The Warmer Zone indicator light will turn OFF.

Note: The **Hot Surface** message will be displayed on the control panel as soon as the warmer zone is hot and will remain ON until the warmer zone area has cooled sufficiently.

CAUTION Radiant surface elements may appear to have cooled after they have been turned off. **The glass surface may still be hot** and burns may occur if the glass surface is touched before it has cooled sufficiently.

CAUTION Do not place aluminum foil or plastic items such as salt and pepper shakers, spoon holders or plastic wrappings on top of the range when it is in use. These items could melt or ignite. Potholders, towels or wooden spoons could catch fire if placed too close to the surface elements or burners.

WARMER ZONE

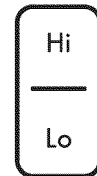

Hot Surface



Figure 2

Surface Cooking

Selecting Surface Cooking Cookware

Cookware should have flat bottoms that make good contact with the entire surface heating element. Check for flatness by rotating a ruler across the bottom of the cookware (See Figure 1). Be sure to follow the recommendations for using cookware as shown in Figure 2.

Note: The size and type of cookware used will influence the setting needed for best cooking results.

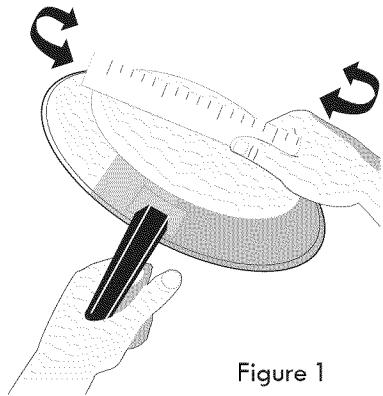

Figure 1

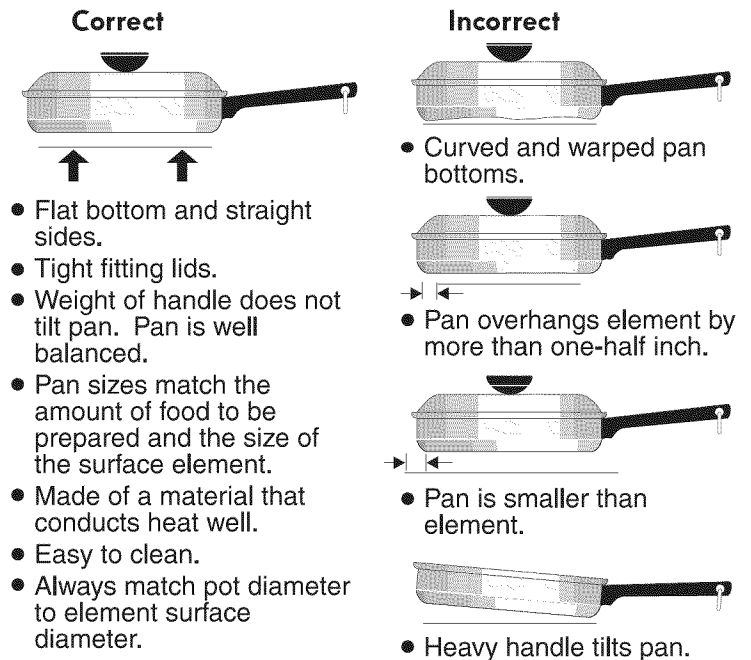

Figure 2

Cookware Material types

The cookware material determines how evenly and quickly heat is transferred from the surface element to the pan bottom. The most popular materials available are:

ALUMINUM - Excellent heat conductor. Some types of food will cause it to darken (Anodized aluminum cookware resists staining & pitting). If aluminum pans slide across the ceramic glass cooktop, they may leave metal marks which will resemble scratches. Remove these marks immediately.

COPPER - Excellent heat conductor but discolors easily. May leave metal marks on ceramic glass (see Aluminum above).

STAINLESS STEEL - Slow heat conductor with uneven cooking results. Is durable, easy to clean and resists staining.

CAST IRON - A poor heat conductor however will retain heat very well. Cooks evenly once cooking temperature is reached. Not recommended for use on ceramic cooktops.

PORCELAIN-ENAMEL on METAL - Heating characteristics will vary depending on base material. Porcelain-enamel coating must be smooth to avoid scratching ceramic cooktops.

GLASS - Slow heat conductor. Not recommended for ceramic cooktop surfaces because it may scratch the glass.

Before Setting the Oven Controls

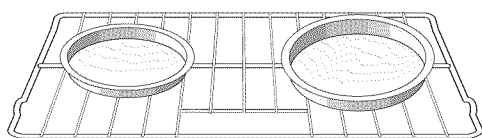

1 Oven Rack

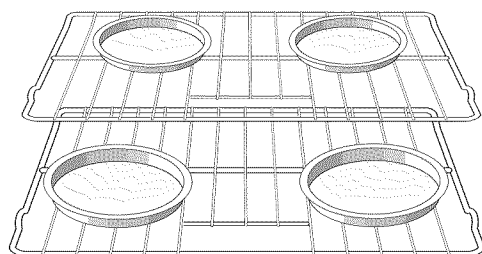

Multiple Oven Racks

Air Circulation in the Oven

If using 1 rack, place in center of oven. If using multiple racks, stagger cookware as shown.

For best air circulation and baking results allow 2-4" (5-10 cm) around the cookware for proper air circulation and be sure pans and cookware do not touch each other, the oven door, sides or back of the oven cavity. The hot air must circulate around the pans and cookware in the oven for even heat to reach around the food.

Before Setting the Oven Controls

CAUTION The lower oven is equipped with a blower which runs in baking and self-cleaning mode to keep all internal components at a cool temperature. The blower may keep running even if the oven has been turned off, until the components have cooled down.

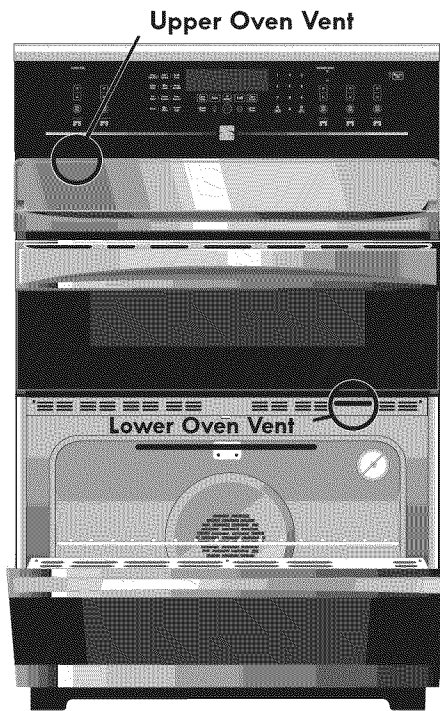

Oven Vent Location

See illustration on left side for venting location of each oven. When the oven is on, warm air is released through the vent. This venting is necessary for proper air circulation in the oven and good baking results.

Removing & Replacing Lower Oven Racks

To remove an oven rack from the lower oven, pull the rack forward until it stops. Lift up front of rack and slide out.

To replace an oven rack in the lower oven, fit the rack onto the guides on the oven walls. Tilt the front of the rack upward and slide the rack back into place.

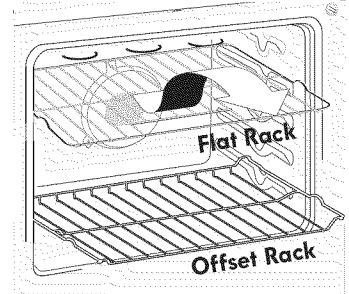

The **Offset Oven Rack** is used to maximize cooking space. The offset rack can be used in the lowest rack position to roast large cuts of meat and poultry or for specific type of cooking as per the table below.

Installing Oven Rack Supports in Upper Oven

To install oven rack support, insert it into the two brackets on the oven wall interior and push down as shown in the illustration to the right.

To remove the oven rack support, pull up the support to disengage it from the brackets.

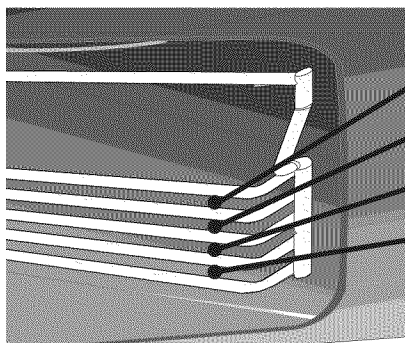
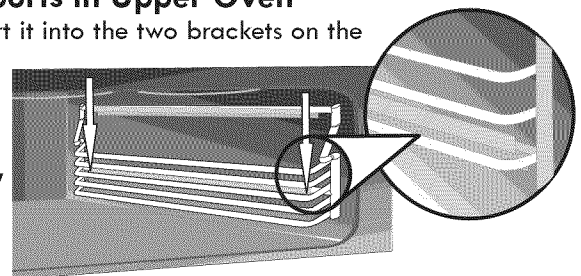

Arranging Oven Racks & Supports

ALWAYS ARRANGE OVEN RACKS WHEN THE OVEN IS COOL (PRIOR TO OPERATING THE OVEN).

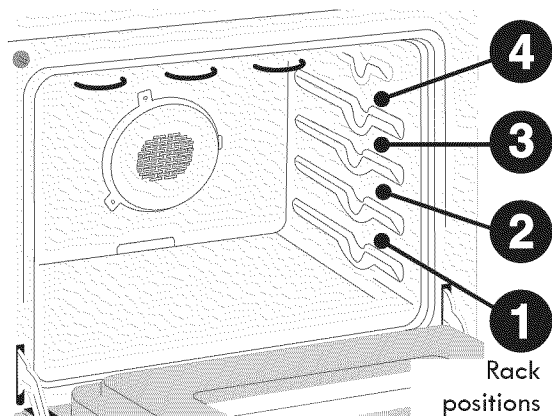

RECOMMENDED RACK POSITIONS FOR BAKING

Food	Rack Positions	
	Lower	Upper
Broiling meats, chicken or fish	4*	1 or 2
Cookies, muffins, cakes, pies & frozen pizzas		
To bake on:		
1 rack	2	3
2 racks	2 & 4	N/A
3 racks	1, 3** & 4	N/A
Frozen pies, angel food cake, yeast, bread, casseroles, small cuts of meat or poultry	1 or 2	1 or 2
Turkey, roast or ham	1*	N/A
Pizza	3**	3

* Offset Rack can be used. ** Offset Rack must be used for best performance. Note: Always use oven mitts when removing food.

Note: It is recommended not to introduce food into the oven until the preheat cycle time is complete. During the preheat cycle, both the bake and the broil elements are cycling which may cause unsatisfactory cooking performance or premature scorching of food if placed in oven prior to completion of the preheat cycle.

Control Pad Features

READ THE INSTRUCTIONS CAREFULLY BEFORE USING THE OVEN. For satisfactory use of your oven, become familiar with the various features and functions of the oven as described below. **Detailed instructions for each feature and function follow later in this Use & Care Guide.**

NOTICE : The illustrations and instructions contained in this document only refer to the lower oven operations. These instructions can also be applied to the upper oven by selecting the upper oven key pad instead for the lower oven pad (except for the Convection Features).

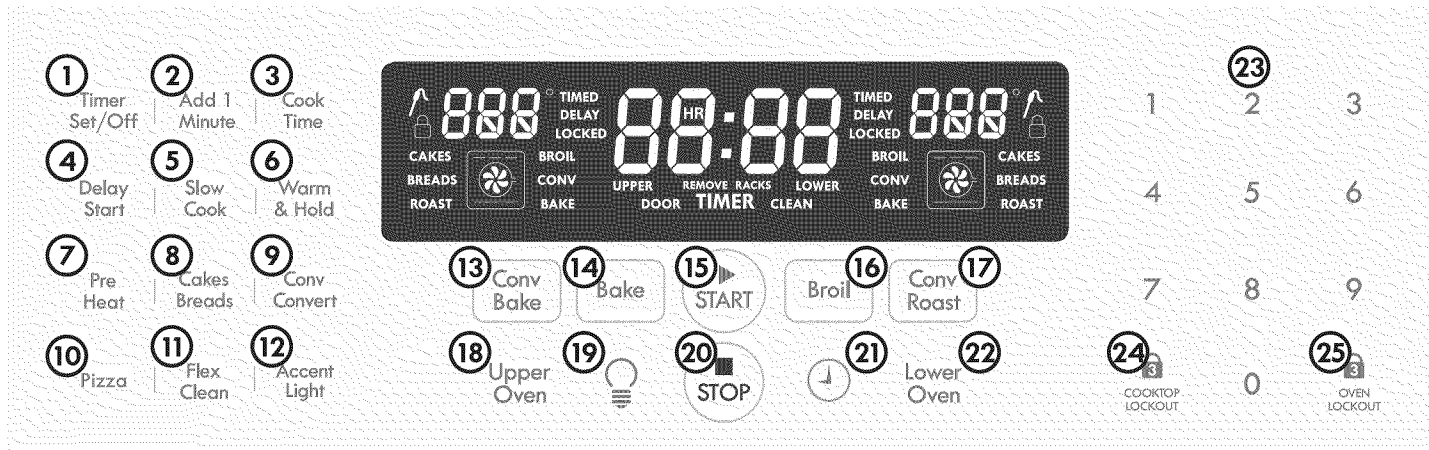

Oven Control Keypads

1. **Timer Set/Off** - Used to set or cancel Timer. The minute timer does not start or stop cooking.
2. **Add 1 Minute** - Used to add additional minutes to Timer.
3. **Cook Time**- Used to enter the length of the cook time desired.
4. **Delay Start** - Used to set the desired start time for baking. May be used with COOK TIME to program a delayed timed bake or clean cycle.
5. **Slow Cook** - Used to select the Slow Cook Feature cycle.
6. **Warm & Hold**- Used to set the Warm & Hold function.
7. **Preheat** - Used to preheat the oven.
8. **Cakes or Breads** - Used to select the cakes or breads.
9. **Conv Convert** - Used to select the Convection Convert feature.
10. **Pizza** - Used to set Pizza function.
11. **Flex Clean** - Used to set a 2 to 4 hours Self-Clean cycle.
12. **Accent Light** - Used to turn accent light ON and OFF.
13. **Conv Bake** - Used to select the Convection Bake feature.
14. **Bake** - Used to enter the normal bake feature.
15. **START** Used to start all oven features (not used with Oven Light).
16. **Broil** - Used to select variable broil feature.
17. **Conv Roast** - Used to select the convection roast mode.
18. **Upper Oven** - Used to select the upper oven.
19. **Oven Light** - Used to turn oven light ON and OFF.
20. **STOP** - Used to cancel any oven function previously entered except Clock and Timer. Also used to lockout oven functions and door.
21. **Clock Set** - Used to set the time of day.
22. **Lower Oven** - Used to select the lower oven.
23. **0 thru 9 number** - Used to enter temperature and times.
24. **Cooktop Lockout** - Used to lock the cooktop key pads and surface elements.
25. **Oven Lockout** - Used to lock the oven key pads and oven door.

Minimum & maximum control settings

All of the features listed below have minimum and maximum time or temperature settings that may be entered into the control. An ENTRY acceptance beep will sound each time a control pad is touched (the Oven Lockout pad is delayed 3 seconds). An ENTRY ERROR tone (3 short beeps) will sound if the entry of the temperature or time is below the minimum or above the maximum settings for the feature.















Feature	Min. Temp. or time	Max. temp. or time
PreHeat	170°F/77°C	550°F/288°C
Bake	170°F/77°C	550°F/288°C
Broil	400°F/205°C	550°F/288°C
Timer	0:01 Min.	11:50 Hr./Min.
Flex Clean	2 hours	4 hours
Conv Bake	170°F/77°C	550°F/288°C
Conv Convert	170°F/77°C	550°F/288°C
Conv Roast	170°F/77°C	550°F/288°C
Slow Cook	Lo (225°F/180°C)	Hi (225°F/180°C)
Cook Time	0:01 Min.	11:50 Hr./Min.
Delay Time 12 Hr.	1:00 Hr./Min.	12:59 Hr./Min.
Delay Time 24 Hr.	0:00 Hr./Min.	23:59 Hr./Min.

Setting the Clock

Setting the Clock

The  pad is used to set the clock. The clock may be set for 12 or 24 hour time of day operation. The clock has been preset at the factory for the 12 hour operation. When the range is first plugged in, or when the power supply to the range has been interrupted, the timer in the display will flash.







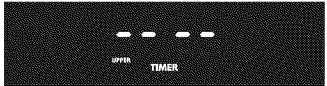

Press . The display will stop flashing.

INSTRUCTIONS	PRESS	DISPLAY
To set the clock (example below for 1:30)		
1. Press  . "CLO" will appear in the display (Fig. 1).		
2. Press 1 3 0 pads to set the time of day to 1:30 (Fig. 2). Press  . The time of day will appear in the display (Fig. 3).	 1 3 0 	 Fig. 2
Changing between 12 or 24 hour time of day display		
1. Press and hold  for 7 seconds until "12Hr" or "24Hr" appears in the display.	 for 7 seconds	
2. Press ^{Flex} _{Clean} to switch between the 12 and 24 hour time of day display. The display will show either "12Hr" (Fig. 4) or "24Hr" (Fig. 5).	Flex Clean	 Fig. 4
3. Press  to accept the change or press  to reject the change.	 or press 	 Fig. 5
4. Reset the correct time as described in To set the Clock above. Please note that if the 24 hour time of day mode was chosen, the clock will now display time from 0:00 through 23:59 hours.		

Setting the Clock







Setting Continuous Bake or 12 Hour Energy Saving

The ^{Timer} Set/Off and ^{Flex} Clean pads control the Continuous Bake or 12 Hour Energy Saving features. The oven control has a factory preset built-in 12 Hour Energy Saving feature that will shut off the oven if the oven control is left on for more than 11 hours and 59 minutes. The oven can be programmed to override this feature for Continuous Baking.

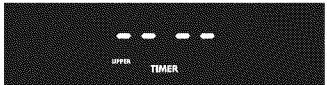
INSTRUCTIONS	PRESS	DISPLAY
To set the control for Continuous Bake or 12 Hour Energy Saving features		
1. Press and hold ^{Timer} Set/Off for 7 seconds (Fig. 1). After 10 seconds "12Hr OFF" or "STAY On" will appear in the display and the control will beep once (Fig 2 or 3).	^{Timer} Set/Off for 7 seconds	 Fig. 1
2. Press ^{Flex} Clean to switch between the 12 Hour Energy Saving and continuous bake features. Note: "12Hr OFF" (Fig. 2) in the display indicates the control is set for the 12 Hour Energy Saving mode and "STAY On" indicates the control is set for the Continuous Bake feature (Fig. 3).	^{Flex} Clean	 Fig. 2
3. Press  to accept the change (Fig. 4; display will return to time of day) or press  to reject the change.	 or 	 Fig. 3  Fig. 4

Setting Kitchen Timer

The ^{Timer} Set/Off pad controls the Kitchen Timer feature. The Kitchen Timer serves as an extra timer in the kitchen that will beep when the set time has run out. It does not start or stop cooking. The Kitchen Timer feature can be used during any of the other oven control functions, except during a self-clean operation. Refer to "Minimum and Maximum Control Pad Settings" for time amount settings.

INSTRUCTIONS	PRESS	DISPLAY
To set the Kitchen Timer (example: 5 minutes)		
1. Press ^{Timer} Set/Off (Fig. 5).	^{Timer} Set/Off	 Fig. 5
2. Press the number pads to set the desired time in the display (example 5). Press  . The time will begin to count down in the display (Fig. 6). Note: If  is not pressed the timer will return to the time of day after 30 seconds.	5 	 Fig. 6
3. When the set time has run out, "End" and "TIMER" will show in the display (Fig. 7). The clock will sound with 3 beeps every 7 seconds until ^{Timer} Set/Off is pressed.	^{Timer} Set/Off	 Fig. 7

To cancel the Kitchen Timer before the set time has run out

Press ^{Timer} Set/Off. The display will return to the time of day.

To Set Add 1 Minute Feature





The ^{Add 1} Minute pad is used to set the Add 1 Minute feature. When the ^{Add 1} Minute pad is pressed, 1 minute is added to the Minute Timer feature if this feature is already active. If the Minute Timer feature is not active and the ^{Add 1} Minute pad is pressed, the Minute Timer feature will become active and will begin counting down from 1 minute. For further information on how to set the Minute Timer feature see To Set the Minute Timer instructions above.

Consumer Defined Control



Note: The Consumer Defined Control features are adjustments to the control that will not affect cooking results. These include the Oven Lockout, Temperature Display and Silent Control Operation features.

Setting Oven Lockout Feature

The  pad controls the Oven Lockout feature. The Oven Lockout feature automatically locks the oven door and prevents the oven from being turned on. It does not disable the clock, Kitchen Timer or the interior oven lights. The ovens can be locked individually.



INSTRUCTIONS	PRESS	DISPLAY
<p>To activate the Oven Lockout feature</p> <ol style="list-style-type: none"> 1. Press . 2. Press and hold  for 3 seconds. 3. After 3 seconds, "DOOR", "LOCKED" will flash and "Loc" will appear in the display (Fig. 1). Once the oven door is locked the "DOOR" and "LOCKED" indicator will stop flashing and remain in the display. Allow 15 seconds for the oven door to lock. 	<p> Lower Oven  for 3 seconds</p>	 Fig. 1









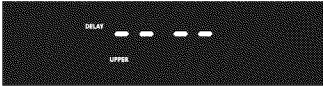

To reactivate normal oven operation:

1. Press .
2. Press and hold  for 3 seconds. "LOC" will disappear from the display. "DOOR" and "LOCKED" will flash in the display until the oven door has completely unlocked.
2. The wall oven is again fully operational.

Note: Because you can set the oven lockout individually, the lower oven can be used when the upper oven lockout feature is on.



Setting Silent Control Operation









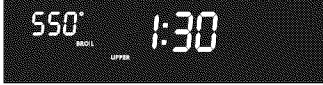

The  and  pads control the Silent Control operation feature. The Silent Control operation feature allows the oven control to be operated without sounds or beeps whenever necessary. If desired the control can be programmed for silent operation and later returned to operating with all the normal sounds and beeps.

INSTRUCTIONS	PRESS	DISPLAY
<p>To change control from normal sound operation to silent control operation</p>	<p> for 7 seconds</p>	 Fig. 2
<ol style="list-style-type: none"> 1. Press and hold  for 7 seconds (Fig. 2). After 6 seconds, "bEEP" (On) will appear in the display (Fig. 3). 	<p></p>	 Fig. 3
<ol style="list-style-type: none"> 2. Press  to switch between normal sound operation (Fig. 3) and silent operation mode (Fig. 4). 	<p> or </p>	 Fig. 4
<ol style="list-style-type: none"> 3. Press  to accept the change or press  to reject the change. <p>Note: The control will always beep at the end of a kitchen timer and will beep when a set temperature has been reached, even if the control is set to silent operation.</p>		

Consumer Defined Control

Setting Temperature Display — Fahrenheit or Celsius



The  and  pads control the Fahrenheit or Celsius temperature display modes. The oven control can be programmed to display temperatures in Fahrenheit or Celsius. The oven has been preset at the factory to display in Fahrenheit. Note: both ovens will be changed at the same time.







INSTRUCTIONS	PRESS	DISPLAY
<p>To change display from Fahrenheit to Celsius or Celsius to Fahrenheit</p> <p>1. Press  and hold for 7 seconds. A beep will sound, "550" will appear "BROIL" will flash in the display (Fig. 1). After 6 seconds a beep will be heard and "F" (Fig. 2) or "C" (Fig. 3) will appear in the display.</p> <p>If "F" appears, the display is set to show temperatures in Fahrenheit (Fig. 2). If "C" appears, the display is set to show temperatures in Celsius (Fig. 3).</p>	<p> for 7seconds</p>	 <p>Fig. 1</p>  <p>Fig. 2</p>  <p>Fig. 3</p>
<p>2. Press  to switch between Fahrenheit or Celsius display modes. The display will show either "F" (Fig. 2) or "C" (Fig. 3).</p>	<p></p>	
<p>3. Press  to accept the change or press  to reject the change.</p>	<p> or </p>	

Setting Accent Light

Your range includes a decorative Accent Light centered horizontally across touch-sensitive control panel. The Accent light comes with a theatre style intensity feature that slowly increases brightness at turn on and slowly fades when turning off.

When the Accent light is off, the light is in automatic mode. This means the Accent light will turn on automatically when an oven or Timer has been activated. The Accent light will turn off automatically when these functions are no longer active.

When the Accent light is OFF, it may be turned ON by pressing  once. When the Accent light has been manually turned on, it will remain on until manually turned off by pressing  again. The brightness may also be adjusted.

INSTRUCTIONS	PRESS	DISPLAY
<p>Example - To adjust the Accent light brightness:</p> <p>1. Press and hold  until an acceptance tone sounds (about 6 seconds)</p>	<p></p>	 <p>Fig. 4</p>
<p>2. The default setting of 100 will appear in the display (See Fig. 4).</p>	<p>Value between</p>	
<p>3. Using the numeric keypad, enter any digit from 0 to 100 to change the brightness level. Entering 0 (Fig. 5) will effectively turn the Accent light OFF until the brightness level is adjusted to a higher level.</p>	<p>0 to 100</p>	 <p>Fig. 5</p>
<p>4. Press  to save the desired brightness setting.</p>	<p></p>	

Operating Oven Lights

The interior oven lights will turn ON when the oven door is opened.

Press  to turn oven light ON an OFF whenever the oven door is closed.











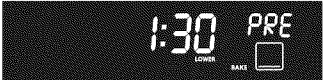
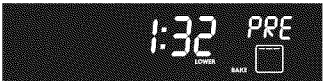

The interior oven lights are located on the rear wall of the oven interior and are covered with a glass shield. The glass shield protects the bulb from high temperatures and should always be in place whenever the oven is in use.

To replace the interior oven lights, see **Replacing oven lights** in the Care and Cleaning section.

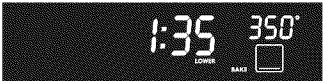
Setting Oven Controls

Setting Preheat

The ^{Pre}Heat pad controls the Preheat feature. The Preheat feature will bring the oven up to temperature and then indicate when to place the food in the oven. Use this feature when recipes call for preheating. Preheating is not necessary when roasting or cooking casseroles. The oven can be programmed to preheat at any temperature between 170°F to 550°F (77°C to 288°C).

INSTRUCTIONS	PRESS	DISPLAY
To set the Preheat temperature for 350°F		
<ol style="list-style-type: none"> 1. Arrange the interior oven racks. 2. Press ^{Lower}Oven. 3. Press ^{Pre}Heat. "350", the default oven temperature set, will appear in the display (Fig. 1). 4. Press . "BAKE" will appear in the display. "PRE" and the actual oven temperature shown in the display will alternate as the oven heats and reaches 350°F. The oven icon appears in the display showing the bake, broil and convection elements cycling. Also the convection fan will turn on to help the oven reaching the desired temperature faster (Figs 2 & 3). 	<p>Lower Oven Pre Heat</p> 	 <p>Fig. 1</p>
		 <p>Fig. 2</p>
		 <p>Fig. 3</p>
<p>Note: After the oven has reached the desired temperature (this example, 350°F) a beep will be heard indicating this is time to PLACE FOOD IN THE OVEN, the convection element will turn off and the display will show "350°" (Fig. 4). The oven will continue to operate in a Bake mode.</p>		 <p>Fig. 4</p>
<p>Press  when baking is complete or to cancel the preheat feature.</p>		 <p>Fig. 5</p>
To change Preheat temperature while oven is preheating (example: changing from 350° to 425°F)		
<p>If it is necessary to change the preheat temperature while the oven is preheating to the original temperature:</p>		 <p>Fig. 6</p>
<ol style="list-style-type: none"> 1. While preheating, press ^{Pre}Heat (Fig. 5). 2. Enter the new preheat temperature. Press 4 2 5 (Fig. 6). 3. Press . "PRE" will appear in the display until the desired temperature (here, 425°F) is reached (Fig 7). At that time the display will show "425°". A long beep will sound once the oven temperature reaches 425°F. 4. When baking is complete press . 	<p>Pre Heat</p> <p>4 2 5</p>  	 <p>Fig. 7</p>

Note: While in preheat mode, the convection fan will be activated during the first rise of temperature to allow the oven to reach its target temperature faster.

Setting Oven Controls

Important Things to Know Before Setting any Basic Oven Cooking Function

















This appliance has been factory pre-set to start any **BAKE, CONV BAKE, CONV ROAST, PREHEAT, CAKES** or **BREADS** function with the oven set temperature automatically set for 350°F. However if desired, the oven set temperature may be adjusted at any time during the cooking process. You may also choose to add a **COOK TIME** or **DELAY START** with any of the functions listed above.

Temperature Visual Display

Your oven is equipped with a temperature visual display. When a cooking mode is set, the actual temperature will be shown in the display and will rise as the unit preheat. When the unit has reached its target temperature, a chime will sound to remind you to place the food in the oven. This feature will be active with some cooking modes; bake, convection bake, convection roast, cakes and breads. NOTE: The lowest temperature that can be displayed is 100°F.

Setting Bake

The  pad controls normal baking. If preheating is necessary, refer to the ^{Pre Heat} Preheat Feature for instructions. The oven can be programmed to bake at any temperature from 170° F to 550° F (77° C to 288° C).

INSTRUCTIONS	PRESS	DISPLAY
<p>To set the Bake Temperature to 350°F</p> <ol style="list-style-type: none"> 1. Arrange interior oven racks and place food in oven. 2. Press . 3. Press , "350" will automatically appear in the display (Fig. 1). 4. Press . The actual oven temperature will be displayed (Fig. 2). A beep will sound once the oven temperature reaches 350° F. <p>Pressing  will cancel the Bake feature at any time.</p>	   	 <p>Fig. 1</p>  <p>Fig. 2</p>
<p>To change the Bake Temperature (example: changing from 350° to 425°F)</p> <ol style="list-style-type: none"> 1. After the oven has already been set to bake at 350°F and the oven temperature needs to be changed to 425°F, press . 2. Press 4 2 5. "425°" will appear in the display (Fig. 3). 3. Press . The actual oven temperature will be displayed (Fig. 2). A beep will sound once the oven temperature reaches "425°". <p>Pressing  will cancel the Bake feature at any time.</p>	 4 2 5  	 <p>Fig. 3</p>

Note: If the oven was recently heated from prior cooking and has remained heated, the bake element symbol may not show in the display immediately.



Note: During the first rise of temperature, the convection fan will be activated to allow the oven to reach its target temperature faster. The bake, broil and convection elements will cycle to allow a better heat distribution.

Setting Oven Controls

Oven Baking

For best cooking results, heat the oven before baking cookies, breads, cakes, pies or pastries, etc. There is no need to preheat the oven for roasting meat or baking casseroles.

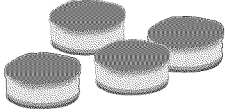
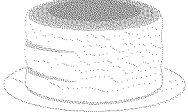
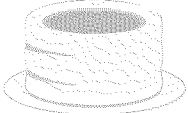
The cooking times and temperatures needed to bake a product may vary slightly from your previously owned appliance.

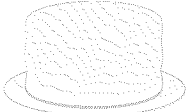
Baking Problems and Solutions Chart		
Baking Problems	Causes	Corrections
Cookies and biscuits burn on the bottom. 	<ul style="list-style-type: none"> • Cookies and biscuits put into the oven before the preheating time is completed. • Oven rack overcrowded. • Dark pan absorbs heat too fast. 	<ul style="list-style-type: none"> • Allow oven to preheat to the selected temperature before placing food in oven. • Choose pan sizes that will permit 5.1 cm to 10.2 cm (2" to 4") of air space on all sides when placed in the oven. • Use a medium-weight aluminum baking sheet.
Cakes too dark on top or bottom. 	<ul style="list-style-type: none"> • Cakes put into the oven before preheating time is completed. • Rack position too high or low. • Oven too hot. 	<ul style="list-style-type: none"> • Allow oven to preheat to the selected temperature before placing food in the oven. • Use proper rack position for baking needs. • Set oven temperature 25°F/12°C lower than recommended.
Cakes not done in the center. 	<ul style="list-style-type: none"> • Oven too hot. • Incorrect pan size. • Pan not centered in oven. 	<ul style="list-style-type: none"> • Set oven temperature 25°F/12°C lower than recommended. • Use pan size suggested in recipe. • Use proper rack position and place pan so there is 5.1 cm to 10.2 cm (2" to 4") of space on all sides of pan.
Cakes not level. 	<ul style="list-style-type: none"> • Range not level. • Pan too close to oven wall or rack overcrowded. • Pan warped. 	<ul style="list-style-type: none"> • Place a marked glass measuring cup filled with water on the center of the oven rack. If the water level is uneven, refer to the installation instructions for leveling the range. • Be sure to allow 5.1 cm to 10.2 cm (2" to 4") of clearance on all sides of each pan in the oven. • Do not use pans that are dented or warped.
Foods not done when cooking time is up. 	<ul style="list-style-type: none"> • Oven too cool. • Oven overcrowded. • Oven door opened too frequently. 	<ul style="list-style-type: none"> • Set oven temperature 25°F/12°C higher than suggested and bake for the recommended time. • Be sure to remove all pans from the oven except the ones to be used for baking. • Open oven door only after shortest recommended baking time.

Setting Oven Controls

Setting Cook Time

The **Bake** and **Cook Time** pads control the Cook Time feature. The automatic timer of the Cook Time feature will turn the oven OFF after cooking for the desired amount of time you selected.

INSTRUCTIONS	PRESS	DISPLAY
<p>To program the oven to begin baking immediately and to shut off automatically (example : Bake at 350°F for 30 minutes)</p>		
<p>1. Be sure the clock is set for the correct time of day.</p> <p>2. Arrange interior oven rack(s) and place the food in the oven.</p>		
<p>3. Press Lower Oven.</p>	<p>Lower Oven</p>	
<p>4. Press Bake (Fig. 1).</p>		
<p>5. Press START. The actual temperature oven will be displayed (Fig. 2).</p>		
<p>6. Press Cook Time (Fig. 3).</p>	<p>Cook Time</p>	
<p>7. Enter the desired baking time by pressing 3 0 (Fig. 4).</p>	<p>3 0</p>	
<p>Note: Baking time can be set for any amount of time between 1 minute to 11 hours and 59 minutes. .</p>		<p>Fig. 4</p>
<p>8. Press START. The display returns to the time of day (Fig. 5).</p>		
<p>Note: After the Timed Bake feature has been activated, press Cook Time to display the bake time remaining in the Timed Bake mode. Once Timed Bake has started baking, a beep will sound when the oven temperature reaches the set temperature.</p>	<p>Cook Time</p>	<p>Fig. 5</p>
<p>Press STOP when baking has finished or at any time to cancel the Timed Bake feature.</p>		
<p>When the timed bake finishes:</p>		<p>Fig. 6</p>
<p>1. "End", and the time of day will show in display. The oven will shut off automatically (Figure 6).</p>		
<p>2. The control will beep 3 times. The control will continue to beep 3 times every 30 seconds until STOP is pressed.</p>		

Setting Oven Controls

Setting Delay Start

The **Bake**, **Cook Time** and **Delay Start** pads control the **Delay Start** feature. The automatic timer of the Delay Start feature will turn the oven **on and off** at the time you select in advance.

Note: If your clock is set for normal 12 hour display mode the Delayed Timed Bake or Delayed Timed Convection Bake cycle can never be set to start more than 12 hours in advance.

INSTRUCTIONS	PRESS	DISPLAY
<p>To program the oven for a delayed BAKE start time and to shut off automatically (example: baking at 350°F for 30 minutes and starting at 5:30)</p>		
<p>1. Be sure that the clock is set with the correct time of day.</p> <p>2. Arrange interior oven rack(s) and place the food in the oven.</p>		
<p>3. Press Lower Oven.</p>	<p>Lower Oven</p>	
<p>4. Press Bake (Fig. 1).</p>	<p>Bake</p>	
<p>5. Press START. The actual oven temperature will be displayed (Fig. 2).</p>	<p>START</p>	
<p>6. Press Cook Time (Fig. 3).</p>	<p>Cook Time</p>	
<p>7. Enter the desired baking time using the number pads by pressing 3 0 (Fig. 4). Note: Baking time can be set for any amount of time from 1 minute to 11 hours and 59 minutes.</p>	<p>3 0</p>	
<p>8. Press START (Fig. 5).</p>	<p>START</p>	
<p>9. Press Delay Start (Fig. 6).</p>	<p>Delay Start</p>	
<p>10. Enter the desired start time using the number pads 5 3 0 (Fig. 7).</p>	<p>5 3 0</p>	
<p>11. Press START. The current time of day will appear in the display (Fig. 8).</p>	<p>START</p>	
<p>12. When the desired start time is reached, the oven icon will appear in the display and the oven will start to bake at the previously selected temperature.</p>		
<p>Press STOP when baking has completed or at any time to cancel the Delayed Time Bake feature.</p>	<p>STOP</p>	
<p>When the set bake time runs out:</p>		
<p>1. "End" will appear in the display and the oven will shut off automatically (Fig. 9).</p>		
<p>2. The control will beep 3 times. The control will continue to beep 3 times every 30 seconds until STOP is pressed.</p>		

CAUTION Use caution with the **DELAYED TIME BAKE** feature. Use the automatic timer when cooking cured or frozen meats and most fruits and vegetables. Foods that can easily spoil such as milk, eggs, fish, meat or poultry, should be chilled in the refrigerator first. Even when chilled, they should not stand in the oven for more than 1 hour before cooking begins, and should be removed promptly when cooking is completed. Eating spoiled food can result in sickness from food poisoning.

Setting Oven Controls

Setting Broil

The  pad controls the Broil feature. When broiling, heat radiates downward from the oven broiler for even coverage. The Broil temperature may be set between 400°F and 550°F.

The broil pan and broil pan insert used together allow dripping grease to drain and be kept away from the high heat of the oven broiler. **DO NOT** use the broil pan without the insert (See Fig. 4). **DO NOT cover the broil pan insert with foil.** The exposed grease could catch fire.

⚠ WARNING Should an oven fire occur, leave the oven door closed and turn off the oven. If the fire continues, throw baking soda on the fire or use a fire extinguisher. **DO NOT** put water or flour on the fire. Flour may be explosive and water can cause a grease fire to spread and cause personal injury.

INSTRUCTIONS

PRESS

DISPLAY

To set the oven to broil at 550°F





- Place the broiler pan insert on the broiler pan. Then place the food on the broiler pan insert. **DO NOT** use the broiler pan without the insert. **DO NOT** cover the broiler insert with foil. The exposed grease could ignite.
- Arrange the interior oven rack and place the broiler pan on the rack. Be sure to center the broiler pan directly under the broiler element. **Make sure the oven door is closed.** Preheat the oven for 5 minutes.
- Press .
- Press  (Fig. 1).
- If a lower broil temperature is desired (minimum broil temperature setting is 400°F), press the desired temperature before continuing to step 6.
- Press  (Fig. 2). The oven will begin to broil.
- Broil on one side until food is browned; turn and cook on the second side. Season and serve. **Note:** Always pull the rack out to the stop position before turning or removing food.
- To cancel broiling or if finished broiling press  (Fig. 3).



Fig. 1



Fig. 2



Fig. 3

Broiling Times and Searing Grill (if equipped)

Use the following table for approximate broiling times. Increase or decrease broiling times, or move the broiling pan to a different rack position to suit for doneness. If the food you are broiling is not listed in the table, follow the instructions provided in your cookbook and watch the item closely. Use the Searing Grill for meats and steaks if desired. Before placing the meat, be sure to heat the Searing Grill using Broil for 10 minutes. Cook times should be reduced 1-2 minutes per side when cooking with the Searing Grill. Place Searing Grill on top of Broiler Pan and insert for meats and steaks (See Fig. 5).

Broiling Table Recommendations

Food Item	Lower Oven Rack Position	Upper Oven Rack Position	Temp Setting	Cook Time		Doneness
				1st side	2nd side	
Steak 1" thick	4th	1st	550° F	6:00	4:00	Rare
	4th	1st	550° F	7:00	5:00	Medium
Pork Chops 3/4" thick	4th	1st	550° F	8:00	6:00	Well
Chicken - Bone In	3rd	2nd	450° F	20:00	10:00	Well
Chicken - Boneless	3rd	1st	450° F	8:00	6:00	Well
Fish	3rd	1st	500° F	13:00	n/a	Well
Shrimp	4th	2nd	550° F	5:00	n/a	Well
Hamburger 1" thick	3rd	1st	550° F	9:00	7:00	Medium
	4th	2nd	550° F	10:00	8:00	Well

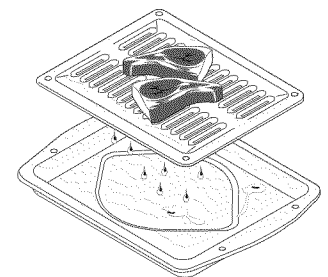

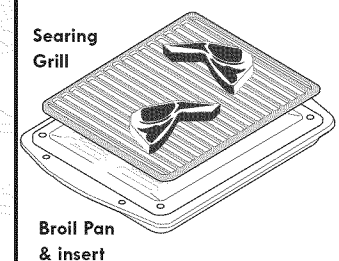

Supplied with some models - Fig. 4





Supplied with some models - Fig. 5

Setting Oven Controls



Setting the Food Categories Features

The  (lower oven only) and  pads may be used when cooking certain food items. These pads have been designed to give optimum cook performance for the foods selected in each category.

The  pad (lower oven only) combines a cook cycle with the convection fan and element to roast meats and poultry. Preheating is not necessary for meats and poultry. Heated air circulates around the food from all sides, sealing in juices and flavors. Foods are crisp brown on the outside while staying moist on the inside. **DO NOT** cover food during convection roast.

The  pad provides a preheat with a gentle cycling of heat giving cakes more volume and allowing delicate foods to cook more evenly.

The  pad adds a preheat feature to the bake cycle to thoroughly heat the oven from top to bottom to give more evenly browned foods.





The  pad let you choose a preset between a frozen (*Fro*) pizza (450°F) and a fresh (*Frh*) pizza (425°F). Always follow the instructions on the box for preheating and baking times. The  pad can be pressed to alternate between the presets. If needed, a different target temperature than the preset can be entered. Some fresh pizza request using a Broil for a few minutes but it is not part of the Pizza feature. When used in the lower oven, this feature will activate and display the convection fan to help cooking on multiple racks at once. **Note:** The upper oven will preheat faster than the lower oven.

Benefits of Convection Bake:

- Multiple rack baking.
- Some foods cook faster, saving time and energy.
- No special pans or bakeware needed.

INSTRUCTIONS

Example - To Set the Convection Roast feature at 375°F

1. Arrange oven racks.
 2. Press .
 2. Press  (Fig. 1).
 3. Enter the desired roasting temperature using the number pads **3 7 5**.
 4. Press  (Fig. 2). The actual oven temperature and the fan icon will be displayed.
- Press  to stop Convection Roast at any time.

PRESS



DISPLAY



Fig. 1



Fig. 2







Fig. 3

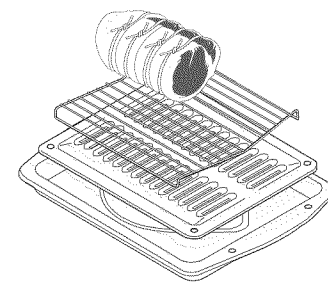

Fig. 4

Example - To Set the Cakes or Breads features

1. Arrange oven racks.
 2. Press .
 3. For Cakes, press  until **CAKES** appears in the display (Fig. 3).
For Breads, press  until **BREADS** appears in the display. (Fig. 4)
 4. Press .
- Press  to cancel **Cakes** or **Breads** at any time.

Recommended foods to be cooked in each category	Conv Roast	Cakes	Breads	Pizza
	Meat Poultry	Cakes Brownies Pies (fresh & Frozen) Baked Custards Cheesecake	Breads Rolls Biscuits Muffins Corn bread	Fresh Pizza Frozen Pizza



Supplied with some models
- Fig. 5

Roasting Rack Instructions (if equipped)

When preparing meats for convection roasting, use broiler pan and insert along with the roasting rack. The broiler pan will catch grease spills and the insert will prevent grease splatters. The roasting rack will allow the heat to circulate around the meat.

WARNING To prevent food from contacting the broil element and to prevent grease splattering, **DO NOT** use the roasting rack when broiling.

1. Place oven rack on bottom or next to the bottom rack position. Heated air to circulate under the food for even cooking and helps to increase browning on the underside. Make sure the roasting rack is securely seated on the insert in the broiler pan. **DO NOT** use the broiler pan without the insert. **DO NOT** cover the insert with aluminum foil.
2. Position food (fat side up) on the roasting rack (Fig. 5).
3. Place the broiler pan on the oven rack.

Setting Oven Controls

Setting Convection Bake - Lower Oven Only

The **CONVECTION BAKE**  pad controls the Convection Bake feature. Use the Convection Bake feature when cooking speed is desired. The oven can be programmed for Convection baking at any temperature between 170° F (77° C) to 550° F (288° C).

Convection baking uses a fan to circulate the oven's heat evenly and continuously within the oven (See Figure 1). This improved heat distribution allows for fast, even cooking and browning results. It also gives better baking results when using 2 or 3 racks at the same time. Breads and pastries brown more evenly. Convection bake cooks most foods faster and more evenly than conventional baking.

General Convection Bake Instructions

1. When using Convection Bake, decrease your normal cooking times. Adjust the cook time for desired doneness as needed. Time reductions will vary depending on the amount and type of food to be cooked. Cookies and biscuits should be baked on pans with no sides or very low sides to allow heated air to circulate around the food. Food baked on pans with a dark finish will cook faster.
2. Preheating is not necessary when cooking casseroles with Convection Bake.
3. When using Convection Bake with a single rack, place oven rack in position 2 or 3. If cooking on multiple racks, place the oven racks in positions 2 and 4.

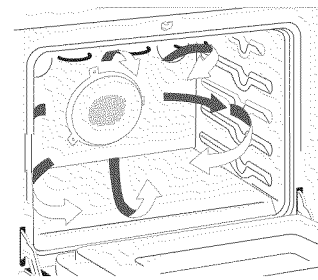

Air circulation during Convection Bake

Fig. 1

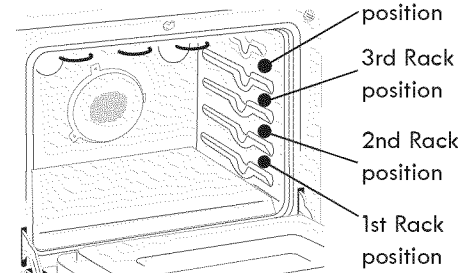

4th Rack position
3rd Rack position
2nd Rack position
1st Rack position

Fig. 2

Benefits of Convection Bake:

- Multiple rack baking.
- Some foods cook faster, saving time and energy.
- No special pans or bakeware needed.

INSTRUCTIONS

To set the oven for Convection Bake and temperature to 350°F

1. Arrange interior oven racks and place food in oven.
2. Press **Lower Oven**.
3. Press **Conv Bake** (Fig. 3).
4. Press **START**. The actual oven temperature will be displayed.
Note: The oven icon will appear and the rotating fan will start running in the display. The bake (Fig. 4), broil (Fig. 5) and convection (Fig. 6) elements icon will show intermittently in the display indicating which element is on to help the oven reaching the desired temperature. A beep will sound once the oven temperature reaches 350°F.

Note: The convection fan will start AS SOON AS the oven is set for Convection Bake.

Press **STOP** to cancel Convection Bake at any time.

PRESS

DISPLAY

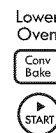

Fig. 3



Fig. 4



Fig. 5





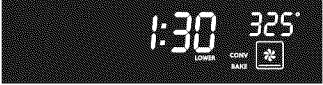





Fig. 6

Setting Oven Controls

Setting Convection Convert feature - Lower Oven Only

The **CONV CONVERT** ^{Conv}_{Convert} pad is used to automatically convert a standard **Baking** recipe for convection baking. When set properly, this feature is designed to display the oven set converted (reduced) temperature in the display.

Convection Convert **MUST** be used with the **Convection Bake** keypad. Cook Time or Delay Start function may be added.

INSTRUCTIONS	PRESS	DISPLAY
<p>Using Convection Convert (Bake) feature to automatically adjust oven temperature (example: setting oven for 350°F):</p>		
<p>1. Arrange interior oven racks and place food in oven.</p> <p>2. Press ^{Lower}_{Oven}.</p> <p>3. Press ^{Conv}_{Bake} (Fig. 1). If a Cook Time or a Delayed Start (Delayed Timed Bake) is desired, enter the times now.</p>	<p>Lower Oven</p> 	
<p>4. Press ^{Conv}_{Convert} "CONV BAKE" and the oven temperature adjustment will appear briefly in the display (for this example it is 325°F). A beep will sound once the adjusted oven temperature is reached (Fig. 2).</p>	<p>Conv Convert</p>	
<p>Note: When used with a Cook Time or a Delay Start setting, the Convection Convert feature will display a "CF" for check food when the bake time is 75% complete (Fig. 3). At this time the oven control will sound 3 long beeps at regular intervals until baking has finished. When the bake time has completely finished the control will display "End" (Fig. 4) and will sound 3 long beeps every 30 seconds until the  pad is pressed.</p>		
<p>The oven icon will show a rotating fan within the square. This rotating fan icon indicates when the Convection Fan is operating.</p>		
<p>Press  to cancel Convection feature at any time.</p>		
<p>Note: The minimum amount of cook time using the Convection Convert feature with a Cook Time or Delay Start function is 20 minutes.</p>		

Setting Oven Controls

Setting the Slow Cook Feature

The ^{Slow}_{Cook} pad is used to activate this feature. The **Slow Cook** feature may be used to cook foods more slowly, at lower oven temperatures and provides cooking results much the same way as a Slow Cooker or Crock-Pot. The **Slow Cook** feature is ideal for roasting beef, pork & poultry. Slow Cooking meats may result in the exterior of meats becoming dark but not burnt. This is normal.

There are 2 settings available, high (**Hi**) or low (**Lo**). The low setting is best for cooking foods from 8 to 9 hour time period. The high setting is best for cooking foods from 4 to 5 hour time period. The maximum cook time for the **Slow Cook** feature is 12 hours unless the oven control has been changed to the **Continuous Bake** mode. This feature may be used with the additional settings of a **Cook Time** or a **Delayed Start**.

Below is a list of preparation and cooking tips you should review for best possible results using Slow Cook:



- Completely thaw all frozen foods before cooking with the **Slow Cook** feature.
- When using a single rack, place in position 2 or 3.
- Position multiple racks to accommodate size of cooking utensils when cooking multiple food items.
- Do not open the oven door often or leave the door open when checking foods. If the oven heat escapes often, the Slow Cook time may need to be extended.
- Cover the foods to keep them moist or use a loose or vented type cover to allow foods to turn crisp or brown.
- Cook times will vary; depending on the weight, fat content, bone & the shape of the food.
- Use the recipe's recommended food temperature and a food thermometer to determine when the food is done.
- Preheating the oven will not be necessary when using the Slow Cook feature.
- Add any cream or cheese sauces during the last hour of cooking.

INSTRUCTIONS

PRESS

DISPLAY

To Program the Oven to begin baking with the Slow Cook feature

1. Place the food in the oven.
2. Press ^{Lower}_{Oven}.
3. Press ^{Slow}_{Cook} "SLO" and "Hi" will appear in the display (Fig 1).
4. If lo setting is desired, press ^{Slow}_{Cook} again, "Lo" will appear in the display (Fig. 2).
5. Press . The slow cook feature will activate (Fig. 3).
6. If desired, add any **Cook Time** or **Delayed Start** settings at this time.
7. To cancel the **Slow Cook** feature press  at anytime.

Lower
Oven
Slow
Cook
Slow
Cook



Fig. 1



Fig. 2









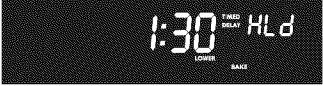



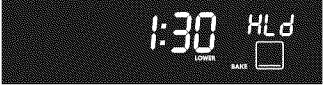

Fig. 3

Setting Oven Controls

Setting the Warm & Hold™ Feature

The ^{Warm} & Hold pad turns ON the Warm & Hold feature and will maintain an oven temperature of 170°F (77°C). The Warm & Hold feature will keep oven baked foods warm for serving up to 3 hours after cooking has finished. After 3 hours the Warm & Hold feature will shut the oven OFF. The Warm & Hold feature may be used without any other cooking operations or can be used after cooking has finished using BAKE, CONVECTION BAKE.

The Warm & Hold feature may be used with TIMED BAKE if you wish to have the Warm & Hold feature turn ON automatically when cooking has finished. The Timed Bake features require you to set start time and the amount of cooking time. With this information the control can calculate the time when cooking will complete and can then start the Warm & Hold feature automatically.

INSTRUCTIONS	PRESS	DISPLAY
To set Warm & Hold		
1. Arrange interior oven racks and place food in oven.		
2. Press ^{Lower} Oven .	Lower Oven Warm & Hold	
3. Press ^{Warm} & Hold. "HLd" will appear in the display (Fig. 1).		Fig. 1
Note: If no pad is touched within 25 seconds the request to turn ON Keep Warm feature will be cancelled.		
4. Press  . "HLd" will remain on and the oven icon will appear in the display (Fig. 2).		
5. To turn the Warm & Hold OFF at any time press  .		
Note: The Warm & Hold feature will automatically turn OFF after 3 hours.		Fig. 3
To set Warm & Hold to turn ON automatically		
1. Arrange interior oven racks and place food in oven. Set the oven properly for Timed Bake or Delayed Timed Bake .		
2. Press ^{Warm} & Hold. "HLd" will appear in the display (Fig. 3).	Warm & Hold	
Note: If no pad is touched within 25 seconds the request to turn ON the Keep Warm feature and all functions previously programmed will be cleared.		
3. Press  . "WARM" will stop flashing and remain in the display. Also temperature programmed will appear in the display (Fig. 4).		
4. When the Time Bake has finished, the keep warm mode will turn ON automatically (Fig. 5).		Fig. 5
Note: The Keep Warm feature will automatically turn OFF after 3 hours.		
Pressing  at any time will stop all oven baking operations.		

Setting Oven Controls

To Set the Sabbath Feature (for use on the Jewish Sabbath & Holidays)

The **Cook Time** and **Delay Start** pads are used to set the Sabbath feature. The Sabbath feature may only be used with the **Bake** pad. The oven temperature may be set higher or lower after setting the Sabbath feature (the oven temperature adjustment feature should be used only during Jewish Holidays), however the display will not visibly show or provide any audible tones indicating whether the change occurred correctly. Once the oven is properly set using Bake with the Sabbath feature active, the oven will remain continuously ON until cancelled. This will override the factory preset 12-Hour Energy Saving feature. If the oven light will be needed during the Sabbath, press **Light** before activating the Sabbath feature. Once the oven light is turned ON and the Sabbath feature is active, the oven light will remain ON until the Sabbath feature is turned OFF. If the oven light needs to be OFF, be sure to turn the oven light OFF before activating the Sabbath feature. **IMPORTANT NOTES:** It is not advised to attempt to activate any other program feature other than **BAKE** while the Sabbath feature is active. ONLY the following key pads will function after setting the Sabbath feature; **0 to 9**, **Bake**, **START** & **STOP**. **ALL OTHER KEYPADS** will not function once the Sabbath feature is properly activated.

INSTRUCTIONS	PRESS	DISPLAY
--------------	-------	---------

To Program the Oven for 350°F Begin Baking Immediately & activate the Sabbath feature

1. Be sure that the clock is set with the correct time of day.
2. Place the food in the oven.
3. Press **Lower Oven**. Press **Bake** (Fig. 1).
4. Press **START**. The actual oven temperature will appear in the display (Fig. 2).
5. If you desire to set the oven control for a **Cook Time** or **Delay Start** do so at this time. If not, skip this step and continue to step 6.
6. Refer to the **Cook Time** or **Delay Start** section for complete instructions. Remember the oven will shut down after using **Cook Time** or **Delay Start** and therefore may only be used once during the Sabbath/Jewish Holidays. The maximum **Delay Start** time is 11 hours & 59 minutes.
7. The oven will turn ON and begin heating. If you desire to set both oven ON for the Sabbath, you should set both at this time. If you just want one oven ON so continue to step 7.
8. Press and hold both the **Cook Time** and **Delay Start** pads for at least 3 seconds. "SAb" will appear in the display (Fig. 3). Once SAb appears in the display the oven control will no longer beep or display any further changes. The oven is properly set for the Sabbath feature.

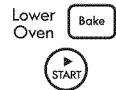

Fig. 1



Fig. 2

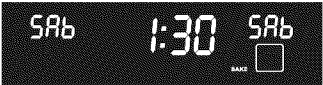
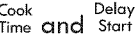

Fig. 3



Note: You may change the oven temperature once baking has started. Press **Bake**, enter the oven temperature change (170 to 550°F) and then press **START** TWICE (for Jewish Holidays only). Remember that **the oven control will no longer beep or display any further changes** once the oven is set for the Sabbath feature.

9. The oven may be turned OFF at any time by first pressing **STOP** pad (this will turn the oven OFF only). To turn OFF the Sabbath feature press and hold both the **Cook Time** and **Delay Start** pads for at least 3 seconds. This also turns off the oven. SAb will disappear from the display.



Should you experience a power failure or interruption, the oven will shut off. When power is returned the oven will not turn back on automatically. If your food was nearly fully cooked, you may allow the trapped heat in the oven to finish the cooking process. Otherwise, you should remove the food when the power failure occurs, because you may only start the oven once during the Sabbath/Jewish Holidays. After the Sabbath observance turn OFF the Sabbath feature and the oven may be used with all normal functions.

After the Sabbath observance turn OFF the Sabbath feature. Press and hold both the **Cook Time** and **Delay Start** pads for at least 3 seconds. SAb will disappear from the display and the oven may be used with all normal functions. For further assistance, guidelines for proper usage, and a complete list of models with the Sabbath feature, please visit the web at <http://www.star-k.org>.

Setting Oven Controls

To Set the Recipe Recall Feature

This feature will ONLY recall a **Bake, Convection Bake, Cakes, Breads, Convection roast, Slow Cook, Cook Time** or a **Cook Time** with a **Warm & Hold** added setting. This feature will not work with any other function including a **Delay Start, a Clean Cycle** or a **Broil** setting.

INSTRUCTIONS	PRESS	DISPLAY
<p>To Program the Oven to Begin Baking Immediately and record a Recipe (example: for a Bake mode at 425°C)</p> <ol style="list-style-type: none"> Place the food in the oven. Press ^{Lower Oven}. Press Bake (Fig. 1). Press 4 2 5 (Fig. 2). Press and hold START pad for at least 3 seconds or until a beep sounds. The beep indicates that this recipe has been recorded for future recall. 	<p>Lower Oven Bake</p> <p>4 2 5</p> <p>START for 3 seconds.</p>	 <p>Fig. 1</p>  <p>Fig. 2</p>

To Program the Oven to Begin Baking with a stored Recipe

- Place the food in the oven.
- Press **Bake** and then **START** (Fig. 2).
- The Temperature (and the cook time, if programmed) is recalled, the oven will begin immediately to cook with the previously recorded recipe.

Bake and then **START**

Restoring factory default settings

When new, your appliance left the factory with predetermined oven control setting. Over time, the user may make changes to these settings. The following options have user preferences that could be modified and may have been changed since the appliance was new:

- 12 or 24 hour display mode;
- Continuous bake or 12-Hour Energy Savings mode;
- Silent or audible control;
- Oven temperature display (Fahrenheit or Celsius);
- Oven temperature adjustment;
- Any stored recipes;
- Accent Light brightness setting.

Please remember the if you choose to restore, ALL of the above preferences will be restored to factory default settings, the oven temperature offset will reset and any stored information will be cleared.

- Press and hold **7** keypad until first beep sounds (about 6 seconds).
- Press **START**.

Self-Cleaning

CAUTION During the self-cleaning cycle, the outside of the range can become very hot to the touch. **DO NOT** leave small children unattended near the appliance.

CAUTION The health of some birds is extremely sensitive to the fumes given off during the self-clean cycle of any range. Move birds to another well ventilated room.

CAUTION **DO NOT** line the oven walls, racks, bottom or any other part of the appliance with aluminum foil. Doing so will destroy heat distribution, produce poor baking results and cause permanent damage to the interior (aluminum foil will melt to the interior surface of the oven).

CAUTION **DO NOT** force the oven door open. This can damage the automatic door locking system. Use caution when opening the door after the Self-Cleaning cycle is completed. The oven may still be VERY HOT.



Note: See additional cleaning information for the oven door in the **General Care & Cleaning** section.

CAUTION The broil burner may appear to have cooled after they have been turned OFF. **The burners may still be hot** and burns may occur if these burners are touched before they have cooled sufficiently.

Self-Cleaning Oven

A Self-Cleaning oven cleans itself with high temperatures (well above cooking temperatures) which eliminate soils completely or reduces them to a fine powdered ash you can wipe away with a damp cloth.

Adhere to the following cleaning precautions:

- Allow the oven to cool before cleaning.
- Wear rubber gloves when cleaning any exterior parts of the oven manually.
- **DO NOT** use oven cleaners or oven protective coatings in or around any part of the oven interior.
- **DO NOT** clean the oven door gasket. The woven material of the oven door gasket is essential for a good seal. Care should be taken not to rub, damage or remove the gasket.
- **DO NOT** use any cleaning materials on the oven door gasket. Doing so could cause damage.
- **Remove all utensils and any aluminum foil. These items cannot withstand high cleaning temperatures.**
- **Porcelain Coated Racks:** Some ovens come with lubricated porcelain oven racks, which can remain in the oven during the self-clean cycle. Do not clean this oil lubrication off the racks. It is important that the sides of the oven racks always have a light coating of oil. To maintain optimal rack sliding performance, periodically apply a thin layer of food safe oil (mineral or vegetable oil) to the sides of the rack.
- **Chrome Oven Racks:** Some models come with chrome oven racks, which have to be removed from the oven during the self-clean cycle or else their finish will turn dull and their color slightly blue. If left in, after the cycle is complete and the oven has cooled, rub the sides of the oven racks with wax paper or a cloth containing a small amount of mineral oil (this will make the racks glide easier into the rack position). Clean chrome oven racks by using a mild cleaner following manufacturer's instructions. Rinse with clean water and dry.
- Before starting the Self-Cleaning cycle, hand clean any soil from the oven frame, the door liner outside the oven door gasket, and the small area at the front center of the oven. These surfaces are not in the self-cleaning area. Clean with soap and water. Burned-on residue can be cleaned off with a stiff nylon brush and water or nylon scrubber. **DO NOT** hand clean the oven door gasket or it will be permanently damaged.

Self-Cleaning

To Start the Self-Clean Cycle

The **FLEX CLEAN** ^{Flex}_{Clean} pad controls the Self-Cleaning feature. If you are planning to use the oven directly after a self-clean cycle remember to allow time for the oven to cool down and the oven door to unlock. This normally takes about one hour. So a 3 hour self-clean cycle will actually take about 4 hours to complete.

*It is recommend to use a 2 hour self-clean cycle for **light soils**, a 3 hour cycle for **average soils**, and a 4 hour cycle for **heavy soils** (to assure satisfactory results)

! CAUTION To avoid possible burns use care when opening the oven door after the Self-Cleaning cycle. Stand to the side of the oven when opening the door to allow hot air or steam to escape.

! CAUTION **DO NOT** force the oven door open. This can damage the automatic door locking system. Use caution and avoid possible burns when opening the door after the Self-Cleaning cycle has completed. The oven may still be **VERY HOT**.

INSTRUCTIONS

PRESS

DISPLAY

To start an immediate Self-Cleaning cycle or to set a Delay Start time of 4:30 and shut-off automatically (example provided is a default 3 hour Self-Clean Cycle)

1. Be sure the clock is set with the correct time of day and the oven door is closed.
2. Press ^{Lower}_{Oven}.
3. Press ^{Flex}_{Clean}. "CLEAN" will flash and "3:00 HR" will show in the display (Fig. 1). The control will automatically clean for a 3 hour period (default self-cleaning cycle time). Note: If a 2 or 4 hour clean time is desired, press **2 0 0** for 2 hour or press **4 0 0** for a 4 hour clean time. Set the cleaning time based on the amount of soil: light, medium or heavy (* See above).
4. Press . The "DOOR LOCKED" icon will flash; "CLEAN" icon and the letters "CLn" will remain on in the display (Fig. 2).
5. As soon as the control is set, the motor driven oven door lock will begin to close automatically. Once the door has been locked the "DOOR LOCKED" indicator light will stop flashing and remain on. Also, the oven icon will appear in the display (Fig. 3).

Note: Allow about 15 seconds for the oven door to lock.

Note: If the optional delay Self-Clean feature is desired, finish step 6-9. If Self-Clean is started immediately skip the remaining steps and continue with "When the Self-Clean cycle is done" on the following page.

6. Press ^{Delay}_{Start} (Fig. 4). Enter the desired start time using the number pads **4 3 0** (Fig. 5).
7. Press . "CLEAN", "DELAY", "LOCK" and "DOOR" will be displayed (Fig. 6).
9. The control will start the self-cleaning at the set start time, for the period of time previously selected. At that time, the icon "DELAY" will go out.

When the Self-Clean Cycle is Completed

1. "HOT" will appear in the display. The time of day, the "DOOR LOCKED" and "CLEAN" icon will remain in the display.
2. Once the oven has cooled down for approximately 1 HOUR, and the "DOOR LOCKED" icon is no longer displayed, the oven door can then be opened.

^{Lower}_{Oven}
^{Flex}_{Clean}

2 0 0 or
4 0 0



^{Delay}_{Start}
4 3 0



Fig. 1



Fig. 2



Fig. 3

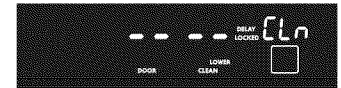

Fig. 4



Fig. 5



Fig. 6

Self Cleaning

Stopping or Interrupting a Self-Cleaning Cycle

If it becomes necessary to stop or interrupt a self-cleaning cycle due to excessive smoke or fire in the oven:

1. Press .
2. The oven door can only be opened after the oven has cooled down for approximately 1 HOUR and the «DOOR LOCKED» icon is no longer displayed.











Note: If your clock is set for normal 12 hour display mode the Delayed Self-Clean cycle can never be set to start more than 12 hours in advance. To set for Delayed Self-Clean Cycle 12-24 hours in advance set the control for the 24 hour time of day display mode.

Adjusting Oven Temperature

The temperature in the oven has been pre-set at the factory. When first using the oven, be sure to follow recipe times and temperatures. If you think the oven temperature is cooking too hot or too cool for the temperature you select, you can adjust the actual oven temperature to be more or less than what is displayed. Before adjusting, test a recipe by using a temperature setting that is higher or lower than the recommended temperature. The baking results should help you to decide how much of an adjustment is needed.

Note: The oven temperature adjustments made with this feature will not change the Self-Clean cycle or Broil temperature.

INSTRUCTIONS	PRESS	DISPLAY
To adjust the oven temperature		
1. Press <small>Lower Oven</small> .	<small>Lower Oven</small>	
2. Press and hold  for 6 seconds. The preset adjustment number will appear and "UPPER" will flash in the display (Fig. 1).		Fig. 1
3. To increase the temperature use the number pads to enter the desired change. (Example 30°F) 3 0 (Fig. 2). The temperature may be increased as much as 35°F (19°C). To decrease the temperature use the number pads to enter the desired change. (Example -30°F) 3 0 and then press <small>Flex Clean</small> (Fig. 3). The temperature may be decreased as much as 35°F (19°C).	3 0	
4. Press  to accept the temperature change and the display will return to the time of day. Press  to reject the change if necessary.	3 0 <small>Flex Clean</small>	
	 	Fig. 2 Fig. 3

NOTE: Each oven may be adjusted individually.

General Care & Cleaning

Before cleaning any part of the oven, be sure all controls are turned OFF and the oven is COOL. REMOVE SPILLOVERS AND HEAVY SOILING AS SOON AS POSSIBLE. REGULAR CLEANINGS NOW WILL REDUCE THE EXTENT AND DIFFICULTY OF MAJOR CLEANING LATER.

Surfaces	How to Clean
Aluminum (Trim Pieces) & Vinyl	Use hot, soapy water and a cloth. Dry with a clean cloth. Do not scour or use all-purpose cleaners, ammonia, powdered cleaners or commercial oven cleaner. They can scratch and discolor aluminum.
Painted and Plastic Control Panel, Body Parts, and Decorative Trim	For general cleaning, use hot, soapy water and a cloth. For more difficult soils and built-up grease, apply a liquid detergent directly onto the soil. Leave on soil for 30 to 60 minutes. Rinse with a damp cloth and dry. DO NOT use abrasive cleaners on any of these materials; they can scratch. To remove control knobs, turn to the OFF position; grasp firmly and pull straight off the shaft. To replace knobs after cleaning, line up the flat sides of both the knob and the shaft; then push the knob into place.
Stainless Steel, Chrome Control Panel, Decorative Trim	Before cleaning the control panel, turn all controls to OFF and remove the control knobs. To remove, pull each knob straight off the shaft. Clean using hot, soapy water and a dishcloth. Rinse with clean water using a dishcloth. Be sure to squeeze excess water from the cloth before wiping the panel; especially when wiping around the controls. Excess water in or around the controls may cause damage to the appliance. To replace knobs after cleaning, line up the flat sides of both the knob and the shaft; then push the knob into place. Clean stainless steel with hot, soapy water and a dishcloth. Rinse with clean water and a cloth. Do not use cleaners with high concentrations of chlorides or chlorines. Do not use harsh scrubbing cleaners. Only use kitchen cleaners that are especially made for cleaning stainless steel. Always be sure to rinse the cleaners from the surface as bluish stains may occur during heating that cannot be removed.
Porcelain Enamel Broiler Pan and Insert (some models), Door Liner, Body Parts	Gentle scouring with a soapy scouring pad will remove most spots. Rinse with a 1:1 solution of clear water and ammonia. If necessary, cover difficult spots with an ammonia-soaked paper towel for 30 to 40 minutes. Rinse with clean water and a damp cloth, and then scrub with a soap-filled scouring pad. Rinse and wipe dry with a clean cloth. Remove all cleaners or the porcelain may become damaged during future heating. DO NOT use spray oven cleaners on the cooktop.
Oven Racks	Porcelain Coated Racks: Some ovens come with lubricated porcelain oven racks, which can remain in the oven during the self-clean cycle. Do not clean this oil lubrication off the racks. It is important that the sides of the oven racks always have a light coating of oil. To maintain optimal rack sliding performance, periodically apply a thin layer of food safe oil (mineral or vegetable oil) to the sides of the rack.
Oven Door	Use soap & water to thoroughly clean the top, sides and front of the oven door. Rinse well. You may use a glass cleaner on the outside glass of the oven door. DO NOT immerse the door in water. DO NOT spray or allow water or the glass cleaner to enter the door vents. DO NOT clean the oven door gasket. The oven door gasket is made of a woven material, on Self-Cleaning models, which is essential for a good seal. Care should be taken not to rub, damage or remove this gasket.



General Care & Cleaning (cont'd)

Ceramic Glass Cooktop Cleaning & Maintenance

Consistent and proper cleaning is essential to maintaining your Ceramic glass cooktop

Prior to using your cooktop for the first time, apply the recommended CookTop® Cleaning Creme to the ceramic surface (on the web visit www.sears.com for replacement cooktop cleaner, item number 40079). Buff with a **non-abrasive** cloth or **no-scratch** cleaning pad. This will make cleaning easier when soiled from cooking. The special cooktop cleaning cream leaves a protective finish on the glass to help prevent scratches and abrasions.

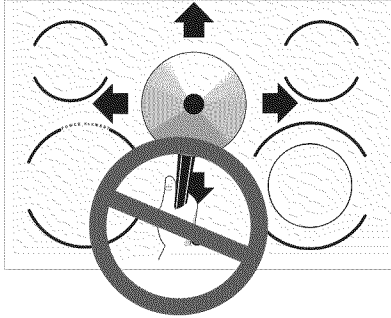

Sliding aluminum or copper clad bottom pans on the cooktop can cause metal markings on the cooktop surface. These marks should be removed **immediately** after the cooktop has cooled using the cooktop cleaning cream. Metal marks can become permanent if not removed prior to future use.

Cookware (cast iron, metal, ceramic or glass) with rough bottoms can mark or scratch the cooktop surface. **Do not slide anything metal or glass** across the cooktop. **Do not** use your cooktop as a cutting board or work surface in the kitchen. **Do not** cook foods directly on the cooktop surface without a pan. **Do not** drop heavy or hard objects on the glass cooktop, because they may cause it to crack.

Cleaning Recommendations for the Ceramic Glass Cooktop

CAUTION Before cleaning the cooktop, be sure the controls are turned to **OFF** and the cooktop is **COOL**.

WARNING **DO NOT** use a cooktop cleaner on a hot cooktop. The fumes can be hazardous to your health, and can chemically damage the ceramic glass surface.

For light to moderate soil:

Apply a few drops of CookTop® Cleaning Creme directly to the cooktop. Use a paper towel or use a **non-abrasive** plastic type **no-scratch** cleaning pad to clean the entire cooktop surface. Make sure the cooktop is cleaned thoroughly, leaving no residue.

For heavy, burned on soil:

Apply a few drops of CookTop® Cleaning Creme directly to the soiled area. Rub the soiled area using a **non-abrasive** plastic type **no-scratch** cleaning pad, applying pressure as needed. Do not use the pad you use to clean the cooktop for any other purpose.

If soils remain, carefully scrape soils with a metal razor blade scraper, holding scraper at a 30 degree angle to the surface. Remove loosened soils, then apply a few drops of cleaning cream and buff surface clean.

IMPORTANT NOTE: Damage to the ceramic glass cooktop may occur if you use an abrasive type scratch pad. Only use cleaning products that have been specifically designed for ceramic glass cooktop.

Plastic or foods with a high sugar content:

These types of soils need be removed immediately if spilled or melted onto the ceramic cooktop surface. Permanent damage (such as pitting of the cooktop surface) may occur if not removed **immediately**. After turning the surface elements **OFF**, use a razor blade scraper or a metal spatula with a mitt and scrape the soil from the hot surface (as illustrated). Allow the cooktop to cool, and use the same method for heavy or burned on soils.

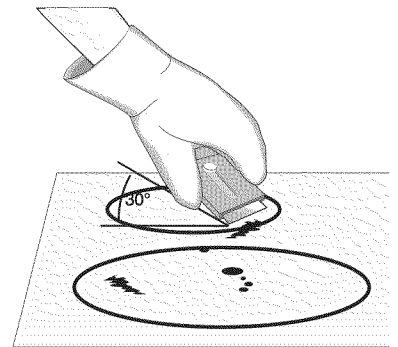

Do not use the following on the ceramic glass cooktop:

- Do not use abrasive cleaners and scouring pads, such as metal and some nylon pads. They may scratch the cooktop, making it more difficult to clean.
- Do not use harsh cleaners, such as chlorine bleach, ammonia or oven cleaners, as they may etch or discolor the cooktop.
- Do not use dirty sponges, cloths or paper towels, as they can leave soil or lint on the cooktop which can burn and cause discoloration.

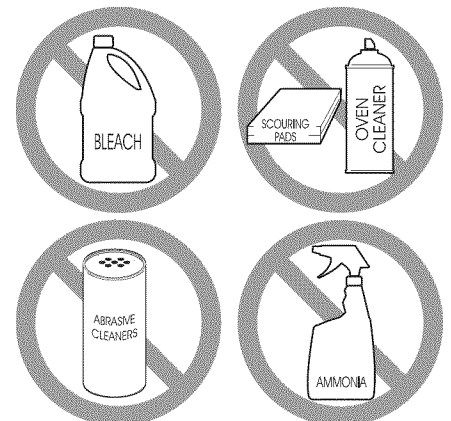

Special Caution for Aluminum Foil and Aluminum Cooking Utensils

- **Aluminum foil:** Use of aluminum foil will damage the cooktop. Do not use under any circumstances.
- **Aluminum utensils:** Since the melting point of aluminum is much lower than that of other metals, care must be taken when aluminum pots or pans are used. Pans that boil dry may permanently damage cooktop by breaking, fusing to, or marking it.

General Care & Cleaning

Removing and Replacing the Lift-Off Oven Door

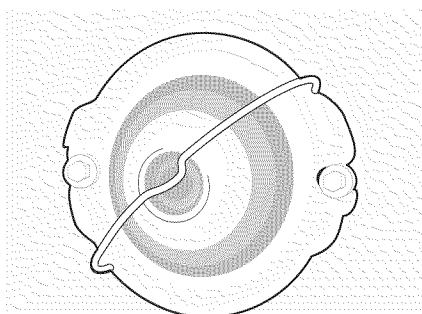
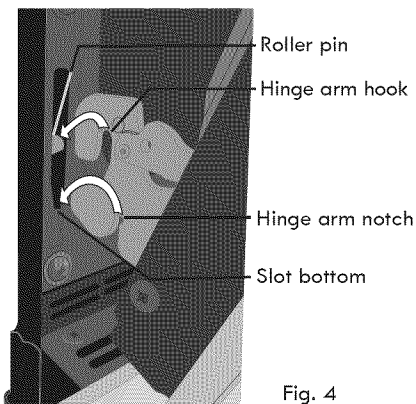
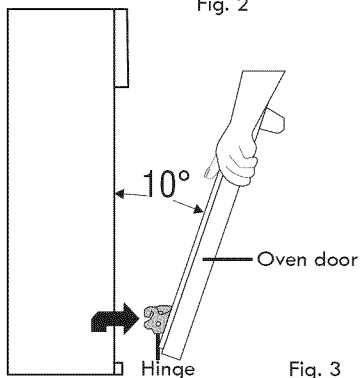
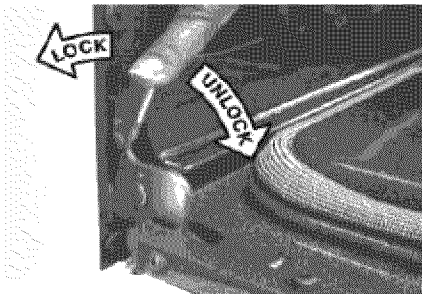
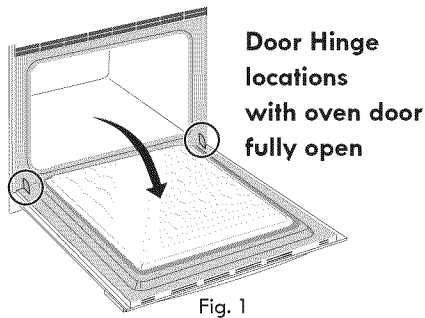

CAUTION The door is heavy. For safe, temporary storage, lay the door flat with the inside of the door facing down.

To Remove Oven Door:

1. Open oven door completely (horizontal with floor - See Fig. 1).
2. Pull the door hinge locks on both left and right door hinges down from the oven frame completely towards the oven door (See Fig. 2). A tool such as a small flat-blade screwdriver may be required.
3. Firmly grasp both sides of oven door along the door sides (Do not use the oven door handle - See Fig. 3).
4. Close the door to about a 10 degree angle as shown in Fig. 3.
5. With the oven door in this position, lift the oven door hinge arms away from the roller pins located on each side of the oven frame (See Fig. 4).

To Replace Oven Door:

1. Firmly grasp both sides of oven door along the door sides (Do not use the oven door handle - See Fig. 3).
2. Holding the oven door at the same angle as the removal position, seat the hook of the hinge arm onto the roller pins located on each side of the oven door frame (See Fig. 4). Also, seat the notch of the hinge arm onto the bottom of the slot at the same time you seat the hook. The hook and notch of the hinge arms must be fully seated onto the roller pins.
3. Fully open the oven door (horizontal with floor - See Fig. 1).
4. Push the door hinge locks up towards and into the oven frame on both left and right oven door hinges (See Fig. 2) to the locked position.
5. Close the oven door.

Special Door Care Instructions - Most oven doors contain glass that can break. Read the following recommendations:

1. Do not close the oven door until all the oven racks are fully in place.
2. Do not hit the glass with pots, pans, or any other object.
3. Scratching, hitting, jarring or stressing the glass may weaken its structure causing an increased risk of breakage at a later time.

Changing the Oven Light

On some models an interior oven light will turn automatically when the oven door is opened. The oven light may be turned on when the door is closed by pushing  located on the control panel. On some models, the lamp is covered with a glass shield held in place by a wire holder. **THE GLASS SHIELD MUST BE IN PLACE WHENEVER THE OVEN IS IN USE.**

To replace the light bulb:

CAUTION: BE SURE THE OVEN IS COOL.

1. Turn the power off at the main source.
2. Wear a leather-faced glove for protection against possible broken glass.
3. Replace bulb with 40-watt appliance bulb only.
4. For models with glass shield, press holder on one side to release glass shield, change bulb and be sure to replace the glass shield.

Before You Call

Solutions to Common Problems

Before you call for service, review this list. It may save you time and expense. The list includes common occurrences that are not the result of defective workmanship or materials in this appliance.

OCCURRENCE	POSSIBLE CAUSE/SOLUTION
Oven Control Beeps and Displays any F code error (example F11).	Electronic control has detected a fault condition. Press STOP to clear the display and stop the beeping. Reprogram the oven. If a fault reoccurs, record the fault number. Press STOP and call Sears or another qualified servicer.
"d-O" is displayed.	The door was left open and controls set for self-cleaning cycle. Close the door and push STOP pad.
Faulty installation. Range not leveled. Bad cooking results.	Place oven rack in center of oven. Place a level or a marked glass measuring cup filled with water on the center of the oven rack. If the water level is uneven, adjust the leveling legs of the unit (refer to the installation instructions for leveling the range). If the level is still uneven, contact an installing agent to adjust the cabinet cutout flooring. Kitchen cabinet misalignment may make oven appear to be not level. Be sure cabinets are square and level. Contact cabinet maker to correct problem.
Surface element does not heat.	No power to the appliance. Check steps under "Entire range or oven does not operate" in this Before You Call checklist. Too low heat setting. Turn control to a slightly higher setting until element comes on. Incorrect control is on. Be sure to use correct control for the element to be used.
Surface element too hot or not hot enough.	Incorrect control setting. Raise or lower setting until proper amount of heat is obtained. Dial markings are an indicator of relative heat settings and will vary slightly. Voltage is incorrect. Be sure appliance is properly connected to the power source specified in the installation instructions. If you are not sure about this requirement call 1-800-4-MY-HOME® for service (See back cover). Lightweight or warped pans were used. Be sure to use proper cookware. Use only flat bottom, evenly balanced medium or heavyweight cookware. Heavy and medium weight pans heat evenly. Because lightweight pans heat unevenly, foods may burn easily.
Surface element turns off by itself.	This is normal. The element temperature rises gradually and evenly. As the temperature rises, the element will glow red. To maintain the selected setting, the element will cycle ON and OFF. The heating element retains enough heat to provide a uniform and consistent heat during the OFF cycle.
Warmer zone element does not turn on.	The warmer element will not glow when turned on. The indicator light will turn on when the warmer element is on.

Before You Call

Solutions to Common Problems

OCCURRENCE	POSSIBLE CAUSE/SOLUTION
Scratches or abrasions on cooktop surface.	Coarse particles such as salt or sand between cooktop and utensils can cause scratches. Be sure cooktop surface and bottoms of utensils are clean before usage. Small scratches do not affect cooking and will become less visible with time. Cleaning materials not recommended for ceramic-glass cooktop have been used. See “ Ceramic Glass Cooktop Cleaning & Maintenance ” section under General Care & Cleaning. Cookware with rough bottom has been used. Use smooth, flat-bottomed cookware.
Metalmarks.	Sliding or scraping of metal utensils on cooktop surface. Do not slide metal utensils on cooktop surface. Use a ceramic-glass cooktop cleaning cream to remove the marks. See “ Ceramic Glass Cooktop Cleaning & Maintenance ” section under General Care & Cleaning.
Brown streaks or specks.	Boilovers are cooked onto surface. Use razor blade scraper to remove soil. See “ Ceramic Glass Cooktop Cleaning & Maintenance ” section under General Care & Cleaning.
Areas of discoloration with metallic sheen.	Mineral deposits from water and food. Remove using a ceramic glass cooktop cleaning cream. Use cookware with clean, dry bottoms.
Oven light does not work.	Burned-out or loose bulb. Follow the instructions under Changing Oven Light to replace or tighten the bulb.
Fan noise during cooking operation.	A cooling fan may automatically turn on and off to cool internal parts. This is normal, and the fan may continue to run even after oven is turned off.
Entire oven does not operate.	When the oven is first plugged in, or when the power supply to the oven has been interrupted, the display will flash. The oven cannot be programmed until the clock is set. Be sure electrical cord is securely connected into the electrical junction box. Cord/plug is not installed and/or connected. Cord is not supplied with oven. Contact Sears or another qualified servicer. Service wiring not complete. Contact Sears or another qualified servicer. Power outage. Check house lights to be sure. Call your local electric company. Short in cord/plug. Replace cord/plug. Controls are not set properly. See instructions under Setting Oven Controls to set the controls. House fuse has blown or circuit breaker has tripped immediately following installation. House fuse may not be fully engaged. Check fuse and screw or engage circuit breaker securely. House fuse has blown or circuit breaker has tripped after the oven has been installed and previously operating. Call Sears or another qualified servicer.

Before You Call

Solutions to Common Problems

OCCURRENCE	POSSIBLE CAUSE/SOLUTION
Oven smokes excessively during broiling.	Make sure the oven door is closed. Door should be closed during broiling.
	Meat too close to the broiler unit. Reposition the rack to provide more clearance between the meat and the broiler. Preheat broil burner for quick searing operation.
	Meat not properly prepared. Remove excess fat from meat. Slash remaining fatty edges to prevent curling, but do not cut into the lean.
	Grid on broiler pan wrong side-up. Grease does not drain into broiler pan. Always place the grid on the broiler pan with the ribs up and the slots down to allow grease to drip into the pan.
	Broiler pan used without grid or grid cover with foil. DO NOT use the broiler pan without the grid or cover the grid with foil.
Oven needs to be cleaned. Grease has built up on oven surfaces. Regular cleaning is necessary when broiling frequently. Old grease or food spatters cause excessive smoking.	
Poor baking results.	Many factors affect baking results. See Baking for hints, causes and corrections. See Adjusting Oven Temperature .
Self-cleaning cycle does not work.	Make sure the oven door is closed.
	Controls not set properly. Follow Self-Cleaning instructions in this Use & Care Guide. Self-cleaning cycle was interrupted. Stop time must be set 2-4 hours past the start time. Follow steps under "Stopping or Interrupting a Self-Cleaning Cycle" in this Use & Care Guide.
Soil not completely removed after self-cleaning cycle is completed.	Before starting the Self-Cleaning cycle, hand clean any soil from the oven frame, the door liner outside the oven door gasket, and the small area at the front center of the oven. These surfaces are not in the self-cleaning area. Clean with soap and water. Burned-on residue can be cleaned off with a stiff nylon brush and water or nylon scrubber. DO NOT hand clean the oven door gasket or it will be permanently damaged.
	Excessive spillovers in oven. Set the self-clean cycle for longer cleaning time.
Flames inside oven or smoke from vent.	Excessive spillovers in oven. This is normal, especially for high oven temperatures, pie spillovers or for large amounts of grease on bottom of oven. Wipe up excessive pie filling spillovers.

Notes

PROTECTION AGREEMENTS

Master Protection Agreements

Congratulations on making a smart purchase. Your new Kenmore® product is designed and manufactured for years of dependable operation. But like all products, it may require preventive maintenance or repair from time to time. That's when having a Master Protection Agreement can save you money and aggravation.

The Master Protection Agreement also helps extend the life of your new product. Here's what the Agreement* includes:

- ☑ **Parts and labor** needed to help keep products operating properly **under normal use**, not just defects. Our coverage goes **well beyond the product warranty**. No deductibles, no functional failure excluded from coverage – **real protection**.
- ☑ **Expert service** by a force of more than **10,000 authorized Sears service technicians**, which means someone you can trust will be working on your product.
- ☑ **Unlimited service calls and nationwide service**, as often as you want us, whenever you want us.
- ☑ **«No-lemon» guarantee** – replacement of your covered product if four or more product failures occur within twelve months.
- ☑ **Product replacement** if your covered product can't be fixed.
- ☑ **Annual Preventive Maintenance Check** at your request – no extra charge.
- ☑ **Fast help by phone** – we call it **Rapid Resolution** – phone support from a Sears representative on all products. Think of us as a «talking owner's manual».
- ☑ **Power surge protection** against electrical damage due to power fluctuations.
- ☑ **\$250 Food Loss Protection** annually for any food spoilage that is the result of mechanical failure of any covered refrigerator or freezer.
- ☑ **Rental reimbursement** if repair of your covered product takes longer than promised.
- ☑ **10% discount** off the regular price of any non-covered repair service and related installed parts.

Once you purchase the Agreement, a simple phone call is all that it takes for you to schedule service. You can call anytime day or night, or schedule a service appointment online.

The Master Protection Agreement is a risk free purchase. If you cancel for any reason during the product warranty period, we will provide a full refund. Or, a prorated refund anytime after the product warranty period expires. Purchase your Master Protection Agreement today!

Some limitations and exclusions apply. For prices and additional information in the U.S.A. call 1-800-827-6655.

*** Coverage in Canada varies on some items. For full details call Sears Canada at 1-800-361-6665.**

Sears Installation Service

*For Sears professional installation of home appliances, garage door openers, water heaters, and other major home items, in the U.S.A. or Canada call **1-800-4-MY-HOME**®.*

Acuerdos maestros de protección

Enhorabuena por haber hecho una compra inteligente. Su nuevo producto Kenmore® está diseñado y fabricado para brindarle años de funcionamiento fiable. Pero, como cualquier producto, puede necesitar mantenimiento preventivo o reparaciones periódicas. Es por eso que tener un Acuerdo maestro de protección podría ahorrarle dinero y molestias.

El Acuerdo maestro de protección también sirve para prolongar la durabilidad de su nuevo producto. El acuerdo* incluye lo siguiente:

- ☑ **Piezas y mano de obra** necesarias para contribuir a mantener el funcionamiento adecuado de los productos **utilizados en condiciones normales de uso**, no sólo en caso de defectos de los productos. Nuestra cobertura va **mucho más allá que la garantía del producto**. No se aplican deducibles ni exclusiones por fallas del funcionamiento: es decir, **verdadera protección**.
- ☑ **Servicio técnico por expertos** (más de **10000 técnicos autorizados de Sears**), lo cual significa que quien repare o realice el mantenimiento de su producto será un profesional de confianza.
- ☑ **Servicio técnico a escala nacional y número ilimitado de llamadas de solicitud de servicio técnico**: se puede poner en contacto con nosotros cuantas veces lo desee y cuando lo desee.
- ☑ **Garantía «sin sorpresas»**: se reemplaza el producto cubierto por el acuerdo si ocurren cuatro o más fallas del producto en un periodo de 12 meses.
- ☑ **Reemplazo del producto**: en caso de que no se pueda reparar el producto cubierto por el acuerdo.
- ☑ **Revisión anual preventiva de mantenimiento del producto**: puede solicitarla en cualquier momento, sin costo alguno.
- ☑ **Rápida asistencia telefónica**, la cual denominamos **Solución rápida**: es decir, asistencia telefónica a través de cualquiera de nuestros representantes de Sears, sobre cualquiera de nuestros productos. Piense en nosotros como en un «manual parlante del usuario».
- ☑ **Protección contra fallas eléctricas**, contra daños debidos a fluctuaciones de la corriente eléctrica.
- ☑ **\$250 al año para cubrir cualquier posible deterioro de alimentos** que haya tenido que desechar debido a una falla mecánica de cualquiera de nuestros refrigeradores o congeladores cubiertos por este acuerdo.
- ☑ **Devolución de gastos de alquiler de electrodomésticos** si la reparación de su producto asegurado toma más que el tiempo prometido.
- ☑ **10% de descuento** aplicable tanto a los costos del servicio de reparación, como de las piezas instaladas relacionadas que no hayan quedado cubiertos por este acuerdo.

Una vez que haya realizado el pago de este acuerdo, bastará una simple llamada telefónica para concertar una visita de servicio. Puede llamar a cualquier hora del día o de la noche, o bien concertar una visita de servicio por Internet.

La adquisición del Acuerdo maestro de protección es una inversión exenta de riesgos. Si por cualquier motivo decide cancelar dicho acuerdo durante el periodo de garantía del producto, le haremos un reintegro total del valor. O bien un importe proporcional si cancela el acuerdo en cualquier otro momento posterior al vencimiento del periodo de garantía del producto. ¡Adquiera hoy mismo su Acuerdo maestro de protección!

Algunas limitaciones y exclusiones podrían aplicarse. Para solicitar precios e información adicional, llame al 1-800-827-6655 (en los EE.UU.).

*** La cobertura en Canadá varía en el caso de algunos artículos. Para obtener detalles completos al respecto, llame al 1-800-361-6665 de Sears de Canadá.**

Servicio de instalación de Sears

*Para solicitar la instalación por profesionales de Sears de electrodomésticos, abridores de puertas de garaje, calentadores de agua y otros artículos de uso prioritario en el hogar, llame al **1-800-4-MY-HOME** en los EE.UU. o Canadá.*

Get it fixed, at your home or ours!

Your Home

For troubleshooting, product manuals and expert advice:



www.managemylife.com

For repair – **in your home** – of **all** major brand appliances, lawn and garden equipment, or heating and cooling systems, **no matter who made it, no matter who sold it!**

For the replacement parts, accessories and owner's manuals that you need to do-it-yourself.

For Sears professional installation of home appliances and items like garage door openers and water heaters.

1-800-4-MY-HOME[®] (1-800-469-4663)

Call anytime, day or night (U.S.A. and Canada)

www.sears.com www.sears.ca

Our Home

For repair of carry-in items like vacuums, lawn equipment, and electronics, call anytime for the location of your nearest

Sears Parts & Repair Service Center

1-800-488-1222 (U.S.A.)

www.sears.com

1-800-469-4663 (Canada)

www.sears.ca

To purchase a protection agreement on a product serviced by Sears:

1-800-827-6655 (U.S.A.)

1-800-361-6665 (Canada)

Para pedir servicio de reparación a domicilio, y para ordenar piezas:

1-888-SU-HOGAR[®]

(1-888-784-6427)

www.sears.com

Au Canada pour service en français:

1-800-LE-FOYER^{MC}

(1-800-533-6937)

www.sears.ca

The Sears logo, featuring the word "sears" in a lowercase, serif font with a textured, dotted background.