

## LCD TV

### Operating Instructions

(Setup Guide)

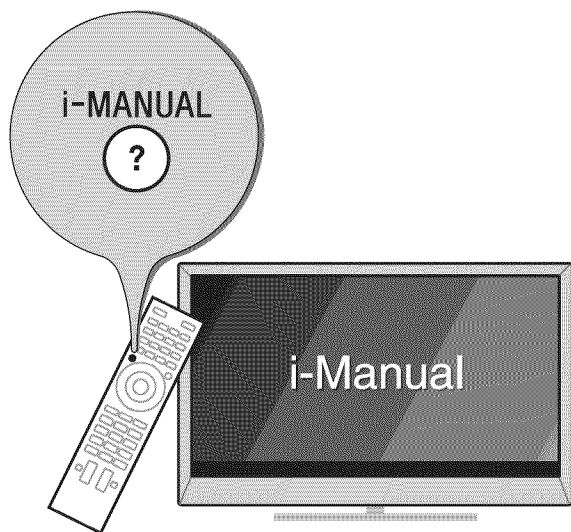

### Sony Customer Support

U.S.A.:

<http://www.sony.com/tvsupport>

Canada:

<http://www.sony.ca/support>

United States

Canada

1.800.222.SONY

1.877.899.SONY

Please Do Not Return  
the Product to the Store

# BRAVIA

## Owner's Record

The model and serial numbers are located at the side and rear of the TV. Record these numbers in the spaces provided below. Refer to them whenever you call upon your Sony dealer regarding this TV.

Model Name

Serial No.

## CAUTION

To prevent electric shock and blade exposure, do not use this polarized AC plug with an extension cord, receptacle or other outlet unless the blades can be fully inserted.

- Operate the TV only on 110-240 V AC (U.S.A./Canada 120 V AC)
- Some people may experience discomfort (such as eye strain, fatigue, or nausea) while watching 3D video images or playing stereoscopic 3D games. Sony recommends that all viewers take regular breaks while watching 3D video images or playing stereoscopic 3D games. The length and frequency of necessary breaks will vary from person to person. You must decide what works best. If you experience any discomfort, you should stop watching the 3D video images or playing stereoscopic 3D games until the discomfort ends; consult a doctor if you believe necessary. You should also review (i) the instruction manual of any other device or media used with this television and (ii) our website (<http://www.sony.com/tvsupport>) for the latest information. The vision of young children (especially those under six years old) is still under development. Consult your doctor (such as a pediatrician or eye doctor) before allowing young children to watch 3D video images or play stereoscopic 3D games. Adults should supervise young children to ensure they follow the recommendations listed above.

- Do not use, store, or leave the 3D Glasses or battery near a fire, or in places with a high temperature, e.g., in direct sunlight, or in sun-heated cars.
- When using the simulated 3D function, please note that the displayed image is modified from the original due to the conversion done by this television.

## Licensing Information

HDMI, the HDMI Logo, and High-Definition Multimedia Interface are trademarks or registered trademarks of HDMI Licensing LLC in the United States and other countries.

Ferguson Patent Properties, LLC:  
U.S. Patent No. 5,717,422  
U.S. Patent No. 6,816,141

Manufactured under license from Dolby Laboratories. Dolby and the double-D symbol are trademarks of Dolby Laboratories.

Rovi and Rovi On Screen Guide are trademarks of Rovi Corporation and/or its subsidiaries.

The Rovi On Screen Guide system is manufactured under license from Rovi Corporation and/or its subsidiaries.

The Rovi On Screen Guide system is protected by one or more United States patents of Rovi Corporation and/or its subsidiaries.

Rovi Corporation and/or its subsidiaries and related affiliates are not in any way liable for the accuracy or availability of the program schedule information or other data in the Rovi On Screen Guide system and cannot guarantee service availability in your area. In no event shall Rovi Corporation and/or its related affiliates be liable for any damages in connection with the accuracy or availability of the program schedule information or other data in the Rovi On Screen Guide system.

"Blu-ray Disc", "Blu-ray" and "Blu-ray Disc" logo are trademarks of Blu-ray Disc Association.

"BRAVIA" and BRAVIA, S-Force, Motionflow, BRAVIA Sync, and  are trademarks or registered marks of Sony Corporation.

DLNA<sup>®</sup>, the DLNA Logo and DLNA CERTIFIED<sup>®</sup> are trademarks, service marks, or certification marks of the Digital Living Network Alliance.

TrackID is a trademark or registered trademark of Sony Ericsson Mobile Communications AB.

Music and video recognition technology and related data are provided by Gracenote<sup>®</sup>. Gracenote is the industry standard in music recognition technology and related content delivery. For more information, please visit [www.gracenote.com](http://www.gracenote.com).

CD, DVD, Blu-ray Disc, and music and video-related data from Gracenote, Inc., copyright © 2000-present Gracenote. Gracenote Software, copyright © 2000-present Gracenote. One or more patents owned by Gracenote apply to this product and service. See the Gracenote website for a nonexhaustive list of applicable Gracenote patents. Gracenote, CDDB, MusicID, MediaVOCS, the Gracenote logo and logotype, and the "Powered by Gracenote" logo are either registered trademarks or trademarks of Gracenote in the United States and/or other countries.

Opera<sup>®</sup> Browser from Opera Software ASA. Copyright 1995-2012 Opera Software ASA. All rights reserved.

Wi-Fi Direct is a mark of the Wi-Fi Alliance.





Your BRAVIA TV is ENERGY STAR® qualified in the "Home" mode. It meets strict energy efficiency guidelines

set by the U.S. Environmental Protection Agency and Department of Energy. ENERGY STAR is a joint program of these government agencies, designed to promote energy efficient products and practices.

Changes to certain features, settings, and functionalities of this TV (i.e. Rovi On Screen Guide, Picture/Sound, Light Sensor, Power Savings) can increase or change the power consumption.

Depending upon such changed settings, the power consumption may exceed the limits required for the ENERGY STAR qualification in the "Home" mode.

The 55 class has a 54.6 inch viewable image size (measured diagonally).



- The illustrations of the remote control used in this manual are of the RM-YD073 unless otherwise stated.
- The illustrations used in this manual may differ depending on your TV model.
- Retain this manual for future reference.

## The BRAVIA® Full HDTV Experience

Thank you for choosing Sony! Your new BRAVIA® TV opens the door to the "Full HDTV Experience." This document will help you get the most out of your TV.

Please take a moment to register your TV at:

**U.S.A.:** <http://productregistration.sony.com>

**Canada:** <http://www.sony.ca/registration>

### Four Steps to a Full HD Experience

Set, Source, Sound, and Setup.

#### 1 Set

Now that you have made the best selection in LCD TV technology, be sure to remove all accessory contents from the packaging before setting up your TV.

#### 2 Source

To experience the stunning detail of your BRAVIA TV, you need access to HD programming.

- Upgrade your signal or content source to high-definition (HD) by contacting your HD service provider.

- Receive over-the-air HD broadcasts with an HD-quality antenna connected directly to the back of your TV.

Visit <http://www.antennaweb.org> for more information on antenna selection and setup.

- Discover the wealth of entertainment now available on super-high resolution Blu-ray Disc™ player and other Sony HD equipment.

#### 3 Sound

Complete the high-definition experience with a BRAVIA Sync™ surround sound system or A/V receiver from Sony.

#### 4 Setup

Install your TV and connect your sources. See page 12 for sample connection diagrams. To help assure the highest quality for your HD experience, use Sony HDMI (High-Definition Multimedia Interface) cables.



**To learn more about HDTV, visit:**

**U.S.A.:** <http://www.sony.com/HDTV>

**Canada:** <http://www.sony.ca/hdtv>

This TV displays all video input signals in a resolution of 1,920 dots × 1,080 lines.

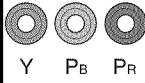
The following chart shows the high-definition (HD) and standard-definition (SD) video formats supported by your BRAVIA TV inputs.

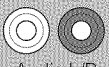
	INPUT	VIDEO	AUDIO	SUPPORTED FORMATS							
				1080i/24p/30p	1080p* <sup>1</sup>	1080i	720i/24p/30p	720p* <sup>1</sup>	480p	480i	PC* <sup>2</sup>
HD	HDMI		When HDMI is connected to DVI with an adapter, a separate Audio L/R is necessary.	✓	✓	✓	✓	✓	✓	✓	✓
	COMPONENT	 Y Pb Pr	 Audio L/R		✓	✓		✓	✓	✓	
SD	VIDEO	 Composite video connection	 Audio L/R								✓

\*<sup>1</sup> For details of supported frame rates, refer to the "Specifications" in this manual.

\*<sup>2</sup> For supported PC formats refer to the i-Manual.



# About this manual (Operating Instructions)

This manual explains how to setup your TV. For more information on how to use BRAVIA TV, refer to the “Electronic manual”.

## Operating Instructions

Explains how to setup your TV such as connections, initial setup, and basic operations.

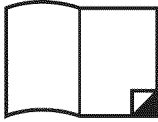

For more information, press the **i-MANUAL** button



## Electronic manual (i-Manual)

Explains how to use all the features. See page 28 on how to use the i-Manual.

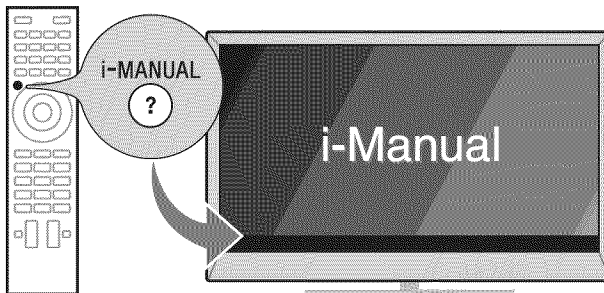

Images and illustrations used in this manual may differ from the actual screen.

# Table of Contents

## Getting Started

Checking the accessories.....	8
Inserting batteries into the remote control.....	8
Before setting up your TV.....	9
1: Attaching the Table-Top Stand .....	10
2: Adjusting the viewing angle of the TV .....	11
3: Connecting the TV.....	12
4: Securing the TV.....	16
5: Bundling the cables .....	17
6: Connecting the TV to the Internet.....	18
7: Running initial setup.....	19
Using a Wall-Mount Bracket.....	20
Installing the TV Against a Wall or Enclosed Area .....	21

## Using Your BRAVIA TV

### Watching TV ▶..... 22

Selecting various functions and settings (Home Menu).....	24
Watching Internet Video.....	27

## Looking for Instructions

### Looking for instructions in the electronic manual (i-Manual) ▶... 28

## Additional Information

Troubleshooting.....	31
How to Care for Your BRAVIA TV .....	32
Specifications .....	33
Safety Information.....	35

# Checking the accessories

---

Remote control (1)<sup>\*1</sup>

Size AAA batteries (2)

Table-Top Stand (1)<sup>\*2</sup>

Fixing screws for Table-Top Stand

(M5 × 16) (3)

Assembling screws for Table-Top Stand

(M5 × 16) (4)

3D Glasses (battery included) (2)

(KDL-55/46HX751 only)

Pouch for 3D Glasses (2)

(KDL-55/46HX751 only)

**Operating Instructions (this manual) and other documents**

<sup>\*1</sup> Please refer to the model name printed on the remote control.

<sup>\*2</sup> Assembling the Table-Top Stand is required. Refer to the supplied Table-Top Stand leaflet to assemble the Table-Top Stand.

# Inserting batteries into the remote control

---

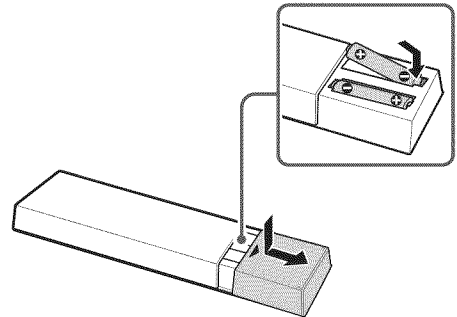

- 1** Remove the protection sheet.
- 2** Push and slide the cover to open.



## ■ Guidelines for Remote Control

- Point your remote control directly at the IR sensor located on your TV.
- Make sure that no objects are blocking the path between the remote control and the IR sensor on your TV.

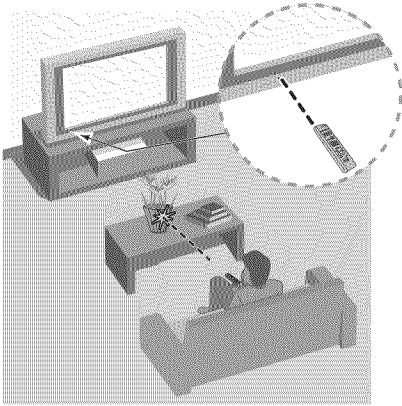

- Fluorescent lamps can interfere with your remote control; try turning off the fluorescent lamps.
- If you are having problems with the remote control, reinsert or replace your batteries and make sure that they are correctly inserted.

## Before setting up your TV

Some TV models are packaged with a detached Table-Top Stand so you can mount your TV to a wall right away. See page 20 (Using a Wall-Mount Bracket) if you want to mount the TV to a wall. If you are not mounting the TV to a wall, you will need to attach the Table-Top Stand. You will need a Phillips screwdriver (not supplied) and the supplied screws to complete the task. Look for the supplied Table-Top Stand instruction leaflet.

Be sure to consider the following while setting up your TV:

- Disconnect all cables when carrying the TV.
- Carry the TV with the adequate number of people; larger size TVs require two or more people.
- Correct hand placement while carrying the TV is very important for safety and to avoid damage.

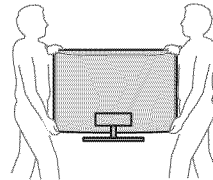

- Ensure your TV has adequate ventilation, see page 21.
- For best picture quality, do not expose the screen to direct illumination or sunlight.
- Avoid installing the TV in a room with reflective wall and floor materials.
- Avoid moving the TV from a cold area to a warm area. Sudden room temperature changes may cause moisture condensation. This may cause the TV to show poor picture and/or poor color. Should this occur, allow moisture to evaporate completely before powering the TV on.

- Ensure that there are no objects in front of the TV.

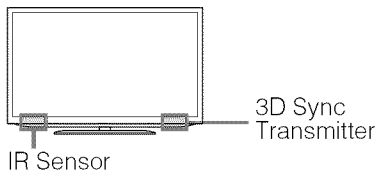

# 1: Attaching the Table-Top Stand

Refer to the supplied Table-Top Stand leaflet for proper attachment.



- Do not put stress on the LCD panel or the frame around the screen.
- Be careful to not pinch your hands or the AC power cord when you install the TV set to the Table-Top Stand.

**1** Place the TV set on the Table-Top Stand.

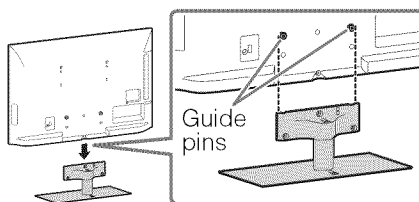

- Align the TV from the top, slide it in until the guide pins cannot be seen.

**2** Fix the TV to the Table-Top Stand using the supplied screws. The arrow marks  indicate the location of the screw holes used for securing the Table-Top Stand.

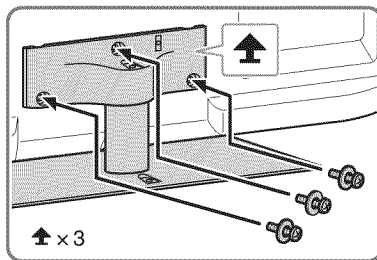

- If using an electric screwdriver, set the torque at approximately 1.5 N·m {15 kgf·cm}.

## Detaching the Table-Top Stand from the TV

To detach the Table-Top Stand from the TV, remove the screws  fixed in step 2.



- Do not remove the Table-Top Stand for any reason other than to install corresponding accessories on the TV.
- When removing the Table-Top Stand from the TV, lay the display face down on a stable work surface that is larger than the TV.
- To prevent damaging the surface of the LCD display, make sure to place a soft cloth on the work surface.
- When installing the TV on a wall, remove the screws from the rear of the TV. Be sure to store the removed screws in a safe place, keeping them away from children.
- When attaching the Table-Top Stand again, be sure to fasten the screws (previously removed) to the original holes on the rear of the TV.

## 2: Adjusting the viewing angle of the TV

This TV can be adjusted within the angles as illustrated.

### ■ Angle adjustment (Swivel)



- When adjusting the angle, hold the stand with one hand to avoid having the stand slip or TV tip over.

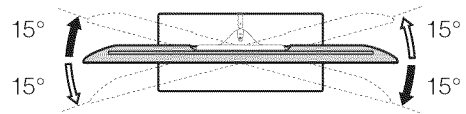

# 3: Connecting the TV



- Use an antenna cable connector no greater than 14 mm thick.
- Use an HDMI cable connector within 12 mm (thickness) × 21 mm (width).

## ■ Shown with a Set Top Box with HDMI connection

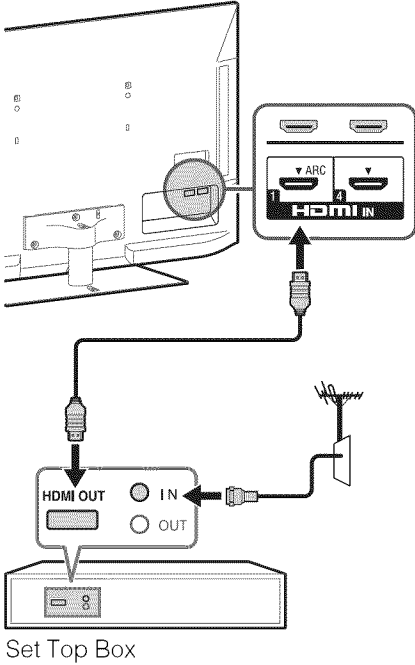

## ■ Shown with a Set Top Box with COMPONENT connection

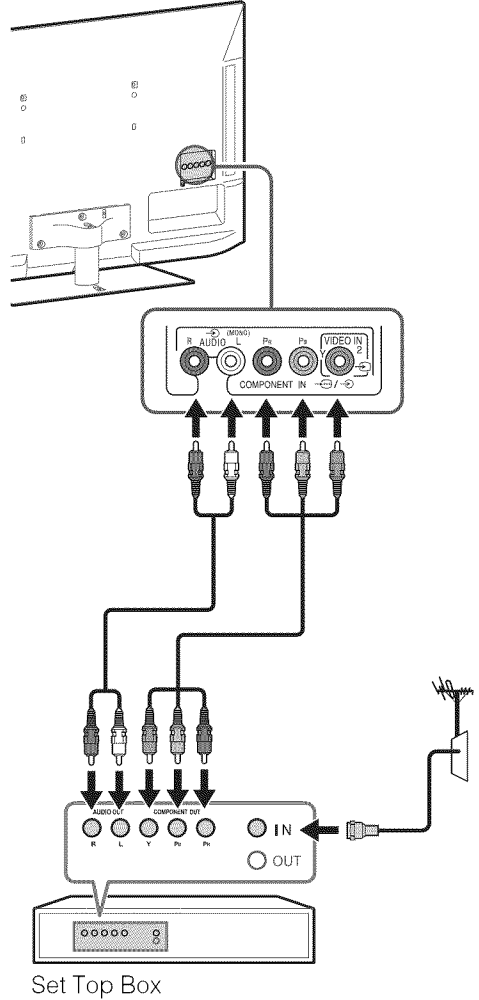

### Recommendation of the F type plug

The one based on the following drawing is recommended about the F type plug. Projection of the inner wire from the connection part must be less than 1.5 mm.

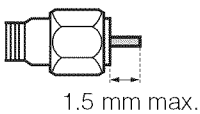

(Reference drawing of the F type plug)

■ Cable System or VHF/UHF Antenna System

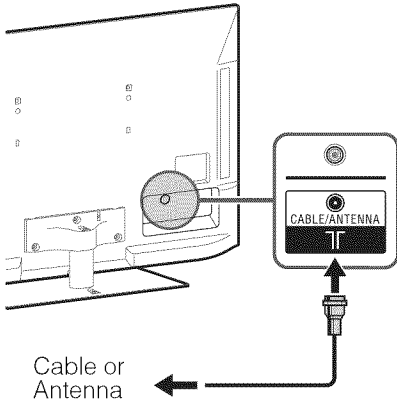

■ Shown with HD BRAVIA® Sync™ Basic Connection

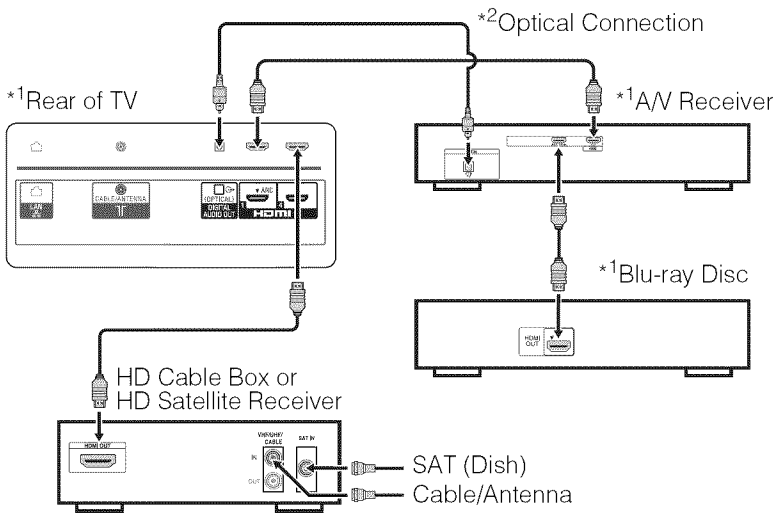

\*1 Signifies a BRAVIA Sync capable device.

\*2 The optical connection is only needed for A/V receivers that do not support ARC (Audio Return Channel).

■ Shown with HD Basic Connection with Home Theater System

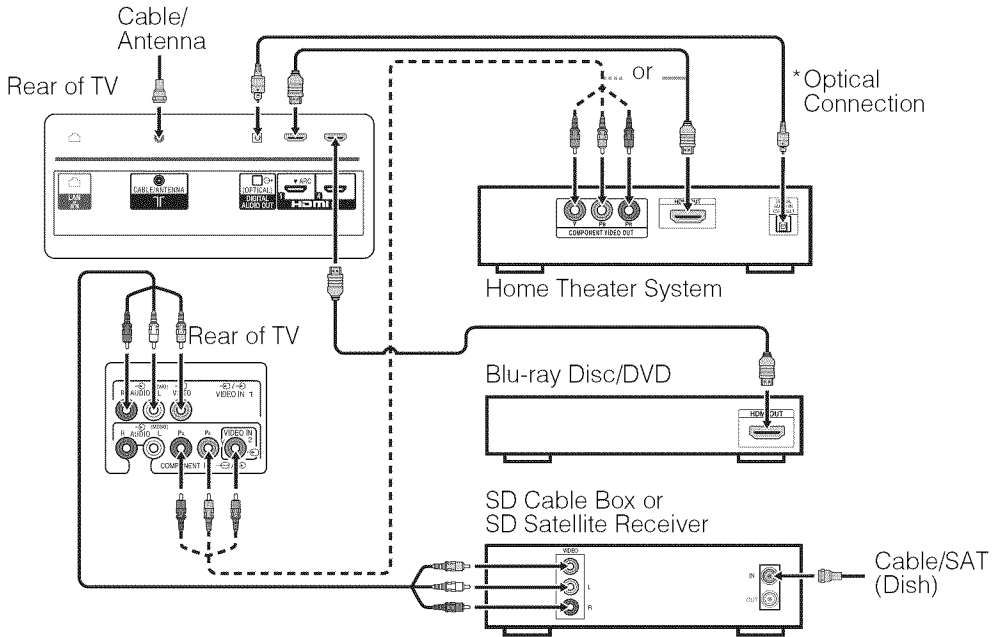

\* The optical connection is only needed for home theater system that do not support ARC (Audio Return Channel) when connecting with HDMI.

# ■ Shown with PC Connection with SD VCR/DVD

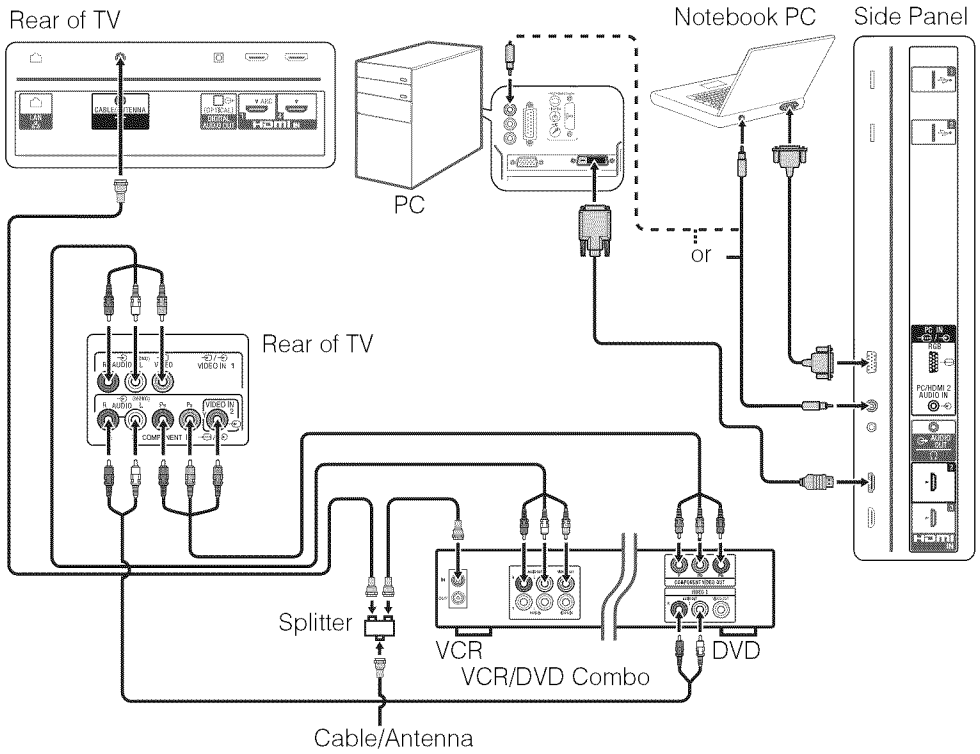

Getting Started

# 4: Securing the TV



Sony strongly recommends taking measures to prevent the TV from toppling over. Unsecured TVs may topple and result in property damage, serious bodily injury or even death.

## Preventing the TV from Toppling

- Secure the TV to a wall and/or stand.
- Do not allow children to play or climb on furniture and TV sets.
- Avoid placing or hanging items on the TV.
- Never install the TV on:
  - slippery, unstable and/or uneven surfaces.
  - furniture that can easily be used as steps, such as a chest of drawers.
- Install the TV where it cannot be pulled, pushed, or knocked over.
- Route all AC power cords and connecting cables so that they are not accessible to curious children.

## Recommended Measures to Secure the TV

Consider the following measures when securing your TV to a Stand (not supplied).

- 1** Secure the Stand for the TV.  
Make sure the Stand can adequately support the weight of the TV. Use two angle braces (not supplied) to secure the stand. For each angle brace use the appropriate hardware to:
  - Attach one side of the angle brace to the wall stud.
  - Attach the other side to the Stand.

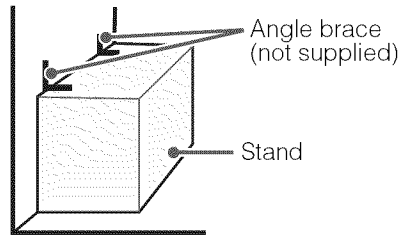

## 2 Secure the TV to the Stand.

Use the optional hardware listed as follows (not supplied):

- M4 machine screw (screwed into the TV's Table-Top Stand)
- A screw or similar (attach it to the Stand)
- Rope or chain (strong enough to support the weight of the TV). Make sure that there is no excess slack in the rope or chain.

An alternative way to secure the TV is with an optional Sony Support Belt Kit. The Sony Support Belt Kit is available as an optional accessory, depending on your TV model.

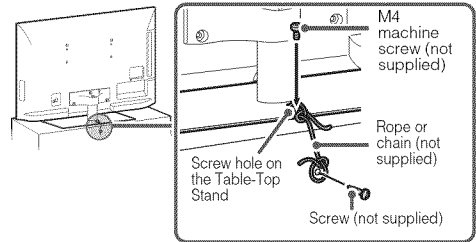

The length of the M4 machine screw differs depending on the rope or chain diameter. Please see below illustration.

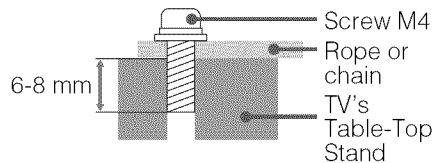





Contact Sony Customer Support to obtain the optional Support Belt Kit by providing your TV model name.

- For United States call: 1-800-488-7669 or visit: <http://www.sony.com/accessories>
- For Canada call: 1-877-899-7669

### 3 Anchor the TV to the Wall.

Anchor the TV to the wall by using bolts, wall anchor and chain (or rope).

Anchor bolts (M6) (not supplied)

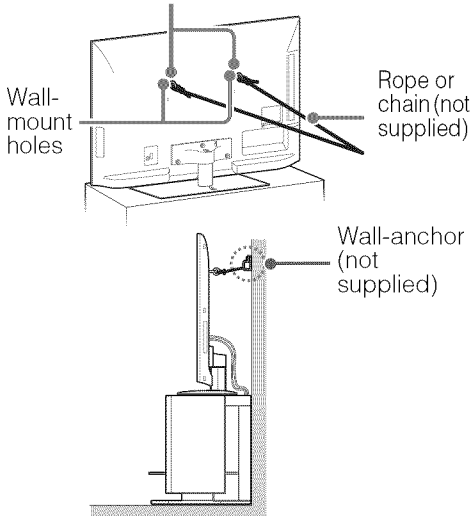

- Securing the TV to the stand without securing the TV and the stand to the wall provides minimum protection against the TV toppling over. For further protection, be sure to follow the three measures recommended.

## 5: Bundling the cables

Before bundling the cables, remove the cable holder from the AC cover. Reuse the cable holder to bundle the other cables.



- Do not bundle the AC power cord together with other cables.

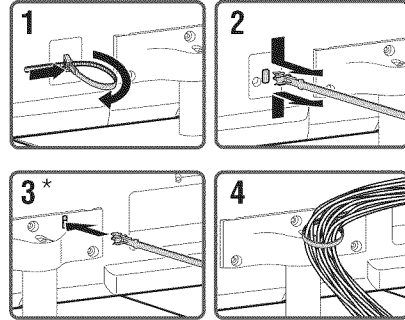

- \* When installing on the wall, attach the cable holder under the terminals.

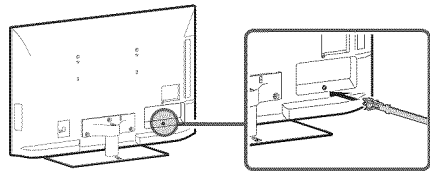

# 6: Connecting the TV to the Internet

When you connect this TV to the Internet, you can enjoy multiple functions: displaying a photograph that shows its location on the map, enjoying Internet video, etc. For details on the functions, refer to the i-Manual.



- You will need to contract with an Internet service provider to connect to the Internet.

## Preparing a wired network

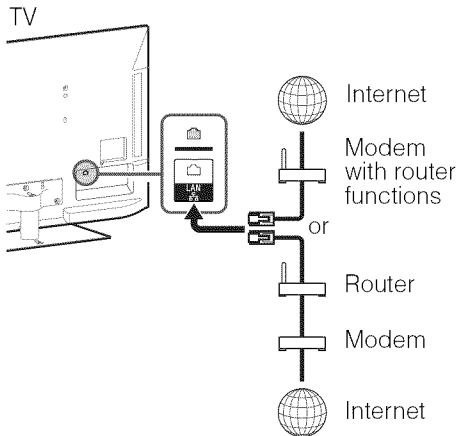

- For LAN connections, use a Category 7 cable (not supplied).

## Preparing a wireless LAN

The built-in wireless LAN device allows you to access the Internet and your home network. With this feature, you can connect to a wireless LAN and enjoy the benefits of networking in a cable-free environment. Before setting up the wireless LAN function of the TV, be sure to set up a wireless LAN router.

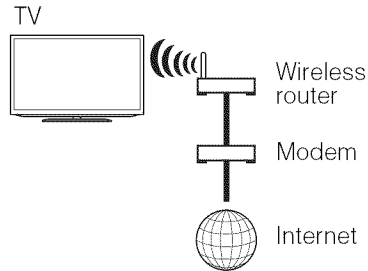

# 7: Running initial setup

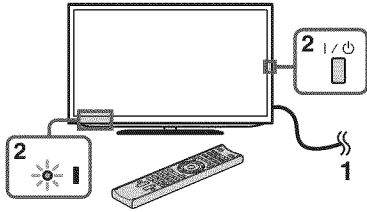

**1** Complete your cable connections before proceeding with the **Initial Setup**. Connect the TV to your nearest power outlet.

**2** Press **I/⏻** on the TV. The **I** (power) indicator will light up in green.

When you switch on the TV for the first time, the Language menu appears on the screen.



- When you turn on the TV for the first time, the TV requires some internal processing for optimization before you can perform the initial setup. There will be no picture and sound, and the timer indicator on the front of the TV blinks orange for about 40 seconds. Do not turn off the TV during this process.

This process has been completed at the factory for some TVs.

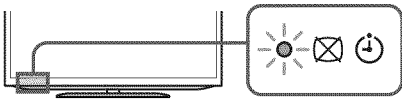

**3** Press **⏪/⏩/⏴/⏵** to select an item, then press **⊕**.

Follow the instructions on the screen.

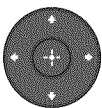

- **Home** mode sets the TV to settings optimized for home viewing (this setting is ENERGY STAR compliant).

**4** Select **Continue** to scan for available channels and enable the **Rovi On Screen Guide™** feature. If you receive channels from a cable box or satellite receiver and do not wish to use the TV's built-in tuner, select **Skip**. Selecting **Skip** will disable the **Rovi On Screen Guide** feature, which is only available when the TV's tuner is used.



- If you skip the channel scan while in the setup menus, Rovi On Screen Guide will be disabled.

**5** Set up the Internet settings. Select **Auto** to connect to the network automatically. Select **Custom** to connect manually. If you do not access the Internet, or to set up later, select **Skip**.



- If you use WEP security, select **Custom** → **Wireless Setup** → **Scan**. Then, select the network name (SSID) you want to connect. If you cannot find the required network name, select **[Manual Entry]** and press **⊕** to enter network name.
- Use the optional USB Wireless LAN Adapter to connect with your wireless router (or access point) at 5GHz. Insert USB Wireless LAN Adapter and set **Standby for Wi-Fi Direct** to **Off**. Press **HOME**, then select **Settings** → **Network** → **Standby for Wi-Fi Direct** → **Off**.
- To set **Network Setup** later, press **HOME**, then select **Settings** → **Network** → **Network Setup**.

# Using a Wall-Mount Bracket

Your TV can be mounted on a wall using a Wall-Mount Bracket (not supplied) out of the box as packaged. If the Table-Top Stand is attached to the TV, the TV may require detaching the Table-Top Stand; see page 11 (Detaching the Table-Top Stand from the TV).

Prepare the TV for the Wall-Mount Bracket before making cable connections.

**For product protection and safety reasons, Sony strongly recommends that you use the Wall-Mount Bracket designed for your TV and the installation should be performed by a Sony dealer or licensed contractor.**

- See page 35 (Compatible Wall-Mount Bracket Information).
- Follow the instruction guide provided with the Wall-Mount Bracket for your model. Sufficient expertise is required in installing this TV, especially to determine the strength of the wall for withstanding the TV's weight.
- Be sure to use the screws supplied with the Wall-mount bracket when attaching the mounting hooks to the TV set. The supplied screws are designed so that they are 8 mm to 12 mm in length when measured from the attaching surface of the mounting hook. The diameter and length of the screws differ depending on the Wall-mount bracket model. Use of screws other than those supplied may result in internal damage to the TV set or cause it to fall, etc.

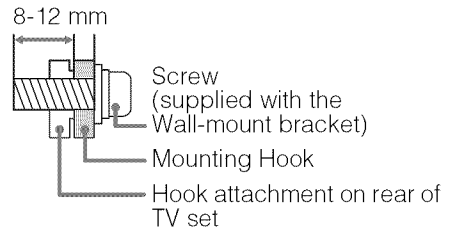

- Be sure to store the unused screws and Table-Top Stand in a safe place until you are ready to attach the Table-Top Stand. Keep the screws away from small children.



- Read the supplied Safety Booklet for additional safety information.

# Installing the TV Against a Wall or Enclosed Area

Make sure that your TV has adequate ventilation. Allow enough space around the TV as shown in the illustration.

## Installed with stand

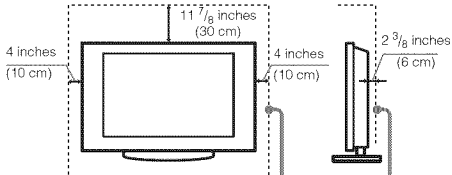

Leave at least this much space around the set.

## Installed on the wall

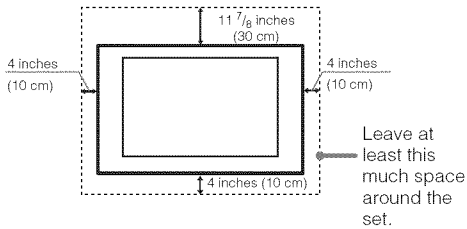

Never install the TV set as follows:

Air circulation is blocked.      Air circulation is blocked.

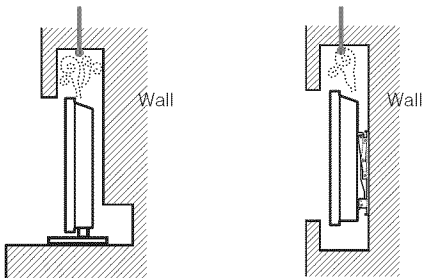

- Inadequate ventilation can lead to overheating of the TV and may cause damage to your TV or cause a fire.

# Watching TV

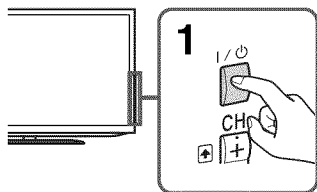

## 1 Turn on the TV.

Press **I/O** on the TV or remote control to turn on the TV.

## 2 Select a TV channel or select an input.

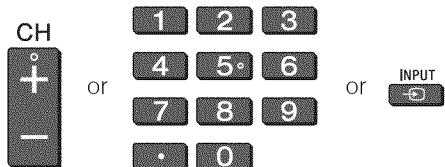
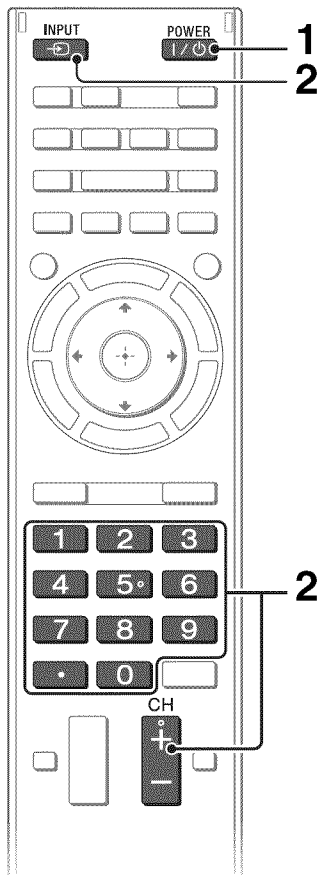

### ■ To select digital channels

Use **0-9** and **.**. For example, to enter channel 2.1:

Press **2**, **.** and **1**, then press **⊕**.

## Watching 3D contents

This feature lets you experience powerful 3D entertainment, such as stereoscopic 3D games and 3D Blu-ray Disc. Refer to the i-Manual as well as the instruction manual supplied with the 3D Glasses on how to set the 3D settings or watch the 3D contents.

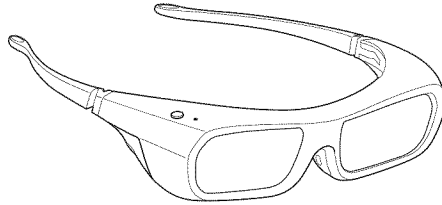

## Frequently used buttons

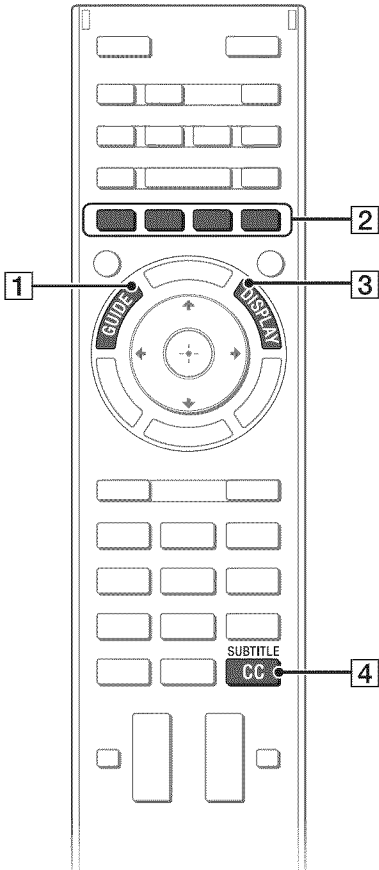

### 1 GUIDE

Displays the Rovi On Screen Guide for program listing information.

### 2 Color buttons

When the color buttons are available, an operation guide appears on the screen.

### 3 DISPLAY

Displays channel number, details of programs, and the clock.

### 4 SUBTITLE/CC

You can turn subtitles on/off and select your preferred language.

# Selecting various functions and settings (Home Menu)

You can select the features of your TV from the Home menu.

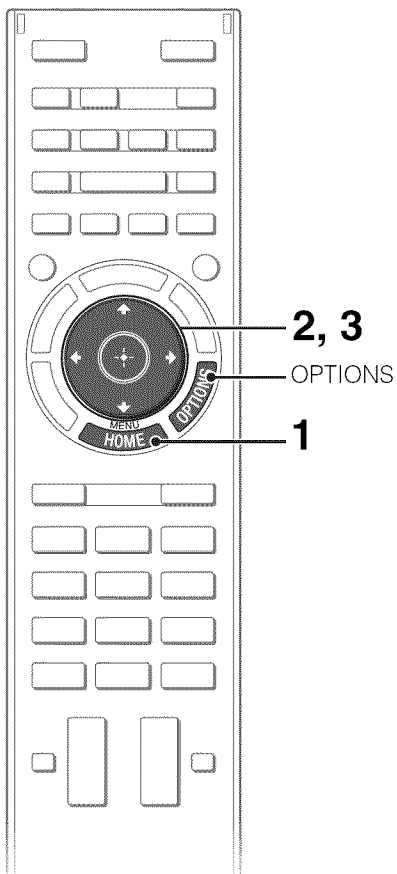

Here is an example on how to select an item and modify the TV settings.

## 1 Press HOME.



## 2 Press $\leftarrow/\rightarrow$ to select (Settings) category.

The contents of **Settings** are displayed on the right.

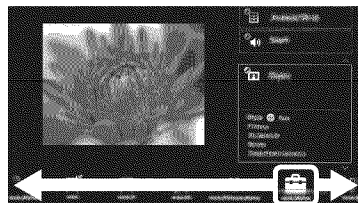
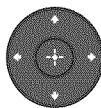

See page 26 (Category list) for all categories.

## 3 Press $\uparrow/\downarrow$ to select **Picture & Display**, then press $\oplus$ .

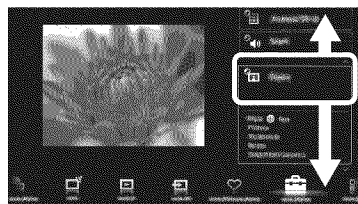
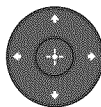

## 4 Modify the settings.



■ **To exit the Home menu**

Press **HOME**.

■ **To select using the OPTIONS button**







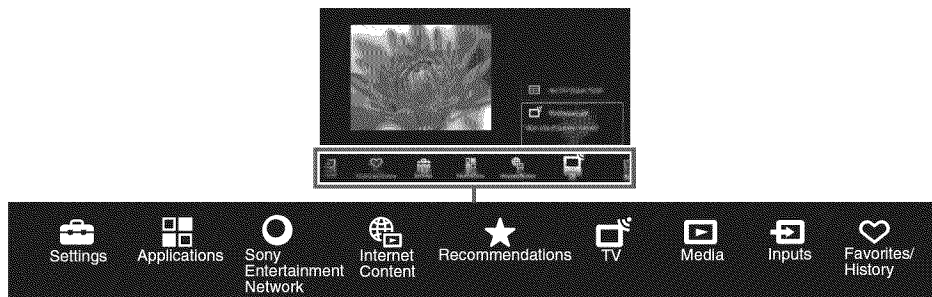

Press **OPTIONS**.

A list of convenient functions and menu shortcuts are displayed. The menu items vary based on the current input and/or content.

## Category list



The categories are available depending on your region and country.

	<b>Settings</b>	Provides settings (e.g. picture settings, sound settings, key tone setting) that allow you to customize your TV.
	<b>Applications</b>	Launches applications that require an Internet connection.
	<b>Sony Entertainment Network</b>	Enables selection of content from the online service <b>SEN</b> (Sony Entertainment Network).
	<b>Internet Content</b>	Enables access to Internet services for TV.
	<b>Recommendations</b>	Provides suggestions for noteworthy content.
	<b>TV</b>	Allows you to select a list of TV channels, or a program guide.
	<b>Media</b>	Enables selection of media files (photo, music, video) to play in a connected USB storage device or your home network.
	<b>Inputs</b>	Enables selection of devices connected to the TV.
	<b>Favorites/History</b>	Displays items in Favorites and recently viewed items.

# Watching Internet Video

This feature serves as a gateway to Internet content, delivering a variety of on-demand entertainment straight to your TV. You can enjoy video content, including movies and cartoons. You will need to make a broadband Internet connection. For details, see page 18 (6: Connecting the TV to the Internet).

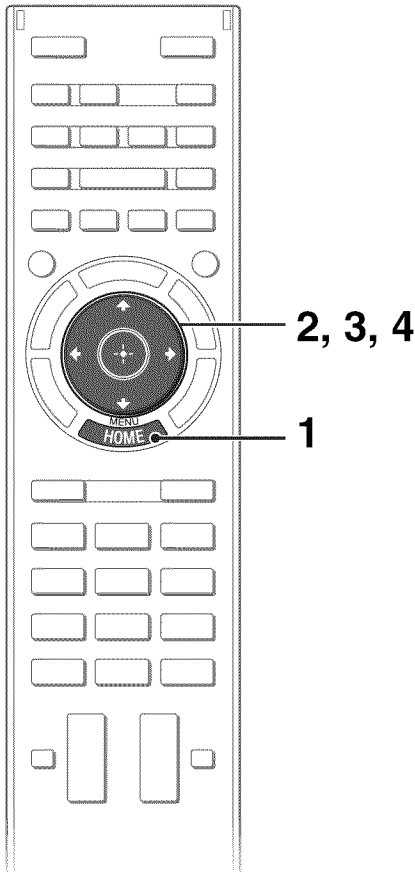

**1 Press HOME.**



**2 Press  $\leftarrow/\rightarrow$  to select  (Internet Content) category.**

**3 Press  $\uparrow/\downarrow$  to select Internet Video, then press  $\oplus$ .**

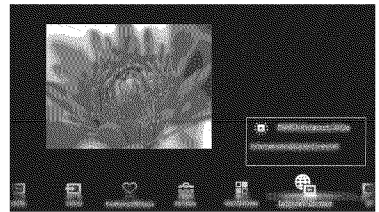
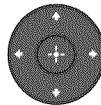

**4 Press  $\uparrow/\downarrow/\leftarrow/\rightarrow$  to highlight the desired content, then press  $\oplus$ .**

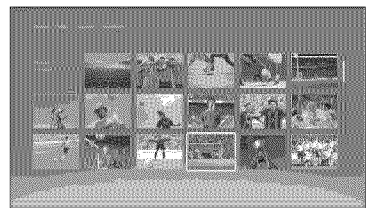
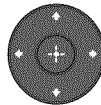

- If you experience difficulties with this feature, check that the Internet connection is set up properly.
- The interface to Internet content depends on the Internet content providers.
- Services block video content based on the **Parental Lock** setting of the TV. Some service providers do not support this function.
- To update Internet Video content services, press **HOME**, then select **Settings** → **Network** → **Refresh Internet Content**.

# Looking for instructions in the electronic manual (i-Manual)

Operating instructions are built into your BRAVIA TV and can be displayed on the screen. To learn more about your TV features, access your i-Manual with the touch of a button.

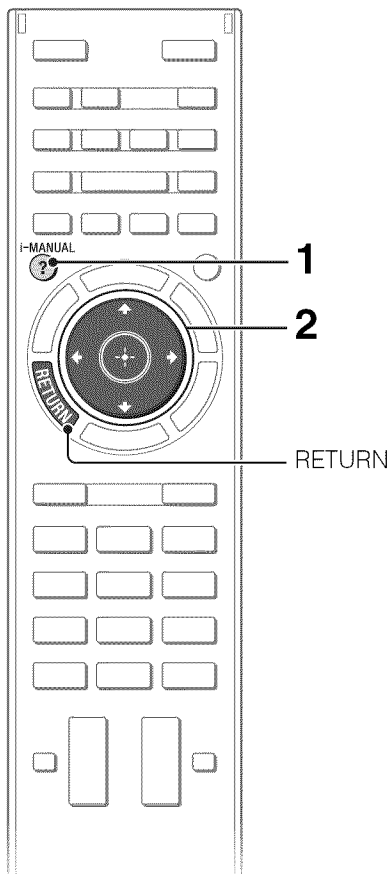

## 1 Press i-MANUAL.



## 2 Select an item.

1 Press  $\leftarrow/\rightarrow$  to select an item.

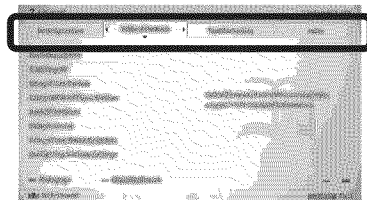
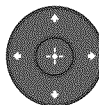

2 Press  $\uparrow/\downarrow$  to select an item, then press  $\oplus$ .

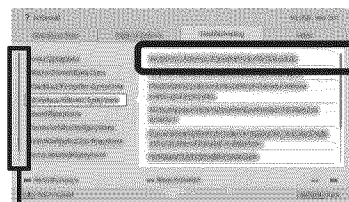
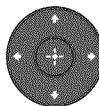

Scroll bar\*

\* If a scroll bar appears, press  $\uparrow$  repeatedly to display more items.

The page of the selected item appears.

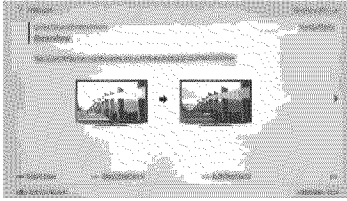

- You can step through pages using  $\leftarrow/\rightarrow$ . Press **RETURN** to return to the previous page.

## Saving frequently viewed pages (Bookmark)

You can save frequently viewed pages for easy access anytime.

### ■ To save a page

In the page to bookmark, press the red button on the remote control.

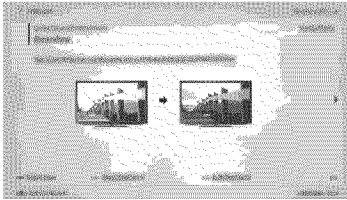

### ■ To access the bookmarked page

When displaying the i-Manual, press the blue button on the remote control to display the bookmark list. Press  $\leftarrow/\rightarrow$  to select the desired item, then press  $\oplus$ .

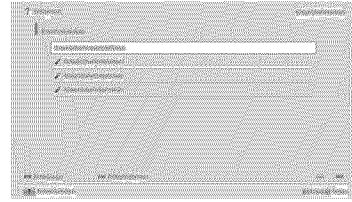

- To return to the previous page, press  $\leftarrow$ .

### ■ To remove a bookmark

When the bookmarked page is displayed, press the red button on the remote control.

## Displaying the page again while operating the TV

You can switch between the i-Manual screen and the TV screen. This feature allows you to refer to the instructions in the i-Manual while using your BRAVIA TV. Press **i-MANUAL** to switch between the i-Manual screen previously displayed and the TV screen.

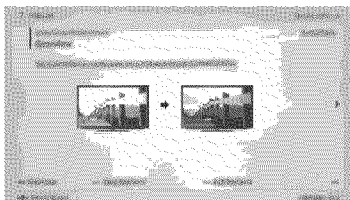

i-Manual screen previously displayed



i-MANUAL



BRAVIA TV screen

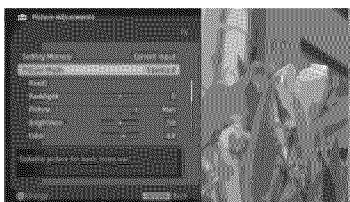

- To jump to the top page of i-Manual, press the yellow button on the remote control. You can also press **HOME**, then select **Settings** → **i-Manual** to jump to the top page of i-Manual.
- Once you turn off the TV or the TV goes to standby mode, the i-Manual will be displayed from the top page when you select **i-Manual**.



# Troubleshooting

## When the (standby) indicator is flashing, count how many times it flashes (interval time is three seconds).

Press  on the TV to turn it off, disconnect the AC power cord, and contact Sony Customer Support (information provided on the front cover) with how many times the indicator flashes.

## When the (standby) indicator is not flashing, check the items in the table as follows.

Also refer to “Troubleshooting” in the i-Manual. If the problem persists, contact Sony Customer Support (information provided on the front cover).

Condition	Explanation/Solution
There is no picture (screen is dark) and no sound.	<ul style="list-style-type: none"><li>• Check the antenna/cable connection.</li><li>• Connect the TV to the AC power, and press  on the TV.</li><li>• If the  (standby) indicator lights up in red, press  on the remote control.</li></ul>
Tiny black dots and/or bright dots appear on the screen.	<ul style="list-style-type: none"><li>• The screen is composed of pixels. Tiny black dots and/or bright dots (pixels) on the screen do not indicate a malfunction.</li></ul>
Some programs cannot be tuned.	<ul style="list-style-type: none"><li>• Check the antenna or dish.</li></ul>
The TV turns off automatically (the TV enters standby mode).	<ul style="list-style-type: none"><li>• Check if the <b>Sleep Timer</b>, <b>Timer</b>, or <b>Idle TV Standby</b> is activated.</li><li>• The <b>Auto Shut-off</b> setting may be set to <b>On</b>. If <b>Auto Shut-off</b> is activated and TV receives no signal, the TV will automatically enter standby mode in 15 minutes. Check <b>Auto Shut-off</b> is activated under <b>Eco</b> feature of this TV. (United States and Canada only)</li></ul>
The remote control does not function.	<ul style="list-style-type: none"><li>• Replace the batteries.</li><li>• Your TV may be in SYNC mode. Press <b>SYNC MENU</b>, select <b>TV Control</b> and then select <b>Home (Menu)</b> or <b>Options</b> to control the TV.</li></ul>
The <b>Parental Lock</b> password has been forgotten.	<ul style="list-style-type: none"><li>• Enter 4357 for the PIN code. (PIN code 4357 is always accepted.)</li></ul>
The TV and its surrounding become warm.	<ul style="list-style-type: none"><li>• When the TV is used for an extended period of time, the TV and its surroundings may become warm to touch. This is not a malfunction of the TV.</li></ul>

# How to Care for Your BRAVIA TV

Safety is very important. Please read and follow the safety documentation (Safety Booklet) separately provided.

Unplug the TV and other connected equipment from the wall outlet before you begin cleaning your TV.

- Wipe the LCD screen gently with a soft cloth.
- Stubborn stains may be removed with a cloth slightly moistened with a solution of mild soap and warm water.
- If using a chemically pretreated cloth, please follow the instruction provided on the package.
- Never spray water or detergent directly on the TV set. It may drip to the bottom of the screen or exterior parts and enter the TV set, and may cause damage to the TV set.
- Never use strong solvents such as a thinner, alcohol or benzine for cleaning.
- Do not plug in the TV into the wall outlet until the moisture from cleaning has evaporated.

The TV should also be placed on a stable surface to prevent it from toppling over (see page 16). If you have young children or pets at home, check regularly to ensure the TV is securely fastened.

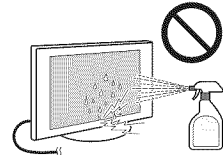
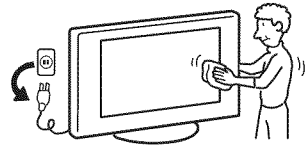



# Specifications

System	
Television system	NTSC: American TV standard ATSC (8VSB terrestrial): ATSC compliant 8VSB QAM on cable: ANSI/SCTE 07 2000 (Does not include CableCARD functionality)
Channel coverage	Analog terrestrial: 2 - 69 / Digital terrestrial: 2 - 69 Analog Cable: 1 - 135 / Digital Cable: 1 - 135
Panel system	LCD (Liquid Crystal Display) Panel
Speaker output	10 W + 10 W
Input/Output jacks	
CABLE/ANTENNA	75-ohm external terminal for RF inputs
VIDEO IN 1	Video / Audio input (phono jacks)
COMPONENT IN	YPbPr (Component Video): 1080p (60 Hz), 1080i (60 Hz), 720p (60 Hz), 480p, 480i Audio input (phono jacks)
VIDEO IN 2	Video input (common phono pin with Y input)
HDMI IN 1/2/3/4	Video (2D): 1080p (30, 60 Hz), 1080/24p, 1080i (60 Hz), 720p (30, 60 Hz), 720/24p, 480p, 480i, PC Formats Video (3D): Frame Packing 1080p (30 Hz), 1080/24p, 1080i (60 Hz), 720p (30, 60 Hz), 720/24p Side-by-Side 1080p (60 Hz), 1080/24p, 1080i (60 Hz), 720p (60 Hz) Over-Under 1080p (30, 60 Hz), 1080/24p, 1080i (60 Hz), 720p (60 Hz) Audio: Two channel linear PCM: 32, 44.1 and 48 kHz, 16, 20 and 24 bits, Dolby Digital Analog audio input (stereo mini jack) (HDMI IN 2 only, common with PC IN) ARC (Audio Return Channel) (HDMI IN 1 only)
AUDIO OUT/Headphones	Stereo mini jack
DIGITAL AUDIO OUT (OPTICAL)	Digital optical jack (Two channel linear PCM, Dolby Digital)
PC IN	Analog RGB (Mini D-sub 15-pin)
PC/HDMI 2 AUDIO IN	Audio input (stereo mini jack) (common with HDMI IN 2)
LAN	10BASE-T/100BASE-TX connector (Connection speed may differ depending on the network environment. 10BASE-T/100BASE-TX communication rate and communication quality are not guaranteed for this TV.)
USB/DLNA	Refer to the i-Manual for supported format.

Model name KDL-		55HX751	46HX751
		55HX750	46HX750
Power and others			
Power requirement		110-240 V AC, 50/60 Hz (U.S.A./Canada 120 V AC, 60 Hz)	
Power consumption	in use	141 W	132 W
	in DAM*	0.02 kWh/Day (You may hear a clicking noise during the download but this is normal.)	
	in standby	Less than 0.15 W with 120 V AC and less than 0.3 W with 240 V AC	
Screen size (inches measured diagonally)		54.6 inches (55 class)	46 inches
Display resolution		1,920 dots (horizontal) × 1,080 lines (vertical)	
Dimensions	with stand (mm)	1,271 × 798 × 312	1,076 × 687 × 252
	(inches)	50 1/8 × 31 1/2 × 12 3/8	42 3/8 × 27 1/8 × 10
	without stand (mm)	1,271 × 761 × 60	1,076 × 650 × 60
	(inches)	50 1/8 × 30 × 2 3/8	42 3/8 × 25 5/8 × 2 3/8
	wall-mount hole pattern (mm)	300 × 300	
	wall-mount screw size (mm)	M6 (length: see diagram on page 20.)	
Mass	with stand (kg)/(lb.)	23.6 / 52.0	17.6 / 38.8
	without stand (kg)/(lb.)	19.2 / 42.3	14.6 / 32.2
Supplied accessories		See page 8 (Checking the accessories).	

Model name KDL-	55HX751 55HX750	46HX751 46HX750
Optional accessories	Connecting cables Support Belt Kit Wall-Mount Bracket: SU-WL500 3D Glasses: TDG-BR750/TDG-BR250/TDG-BR200/TDG-BR100/TDG-BR50 Camera and Microphone Unit: CMU-BR100 USB Wireless LAN Adapter: UWA-BR100	
Operating temperature	32 °F – 104 °F (0 °C – 40 °C)	

\* Download Acquisition Mode (DAM) is used for software updates and/or collecting data for Rovi On Screen Guide.

- Optional accessories availability depends on countries/region/TV model/stock.
- Design and specifications are subject to change without notice.

# Safety Information

Pursuant to FCC regulations, you are cautioned that any changes or modifications not expressly approved in this manual could void your authority to operate this equipment.

## Declaration of Conformity

Trade Name: SONY  
Model: KDL-55HX751/KDL-55HX750/  
KDL-46HX751/KDL-46HX750  
Responsible Party: Sony Electronics Inc.  
Address: 16530 Via Esprillo,  
San Diego, CA 92127 U.S.A.  
Telephone Number: 858-942-2230

This device complies with part 15 of the FCC rules. Operation is subject to the following two conditions:

(1) This device may not cause harmful interference, and (2) this device must accept any interference received, including interference that may cause undesired operation.

## For customers in Canada

This Class B digital apparatus complies with Canadian ICES-003.

## Pour les clients résidant au Canada

Cet appareil numérique de la classe B est conforme à la norme NMB-003 du Canada.

## FCC Related Information

This equipment has been tested and found to comply with the limits for a Class B digital device, pursuant to Part 15 of the FCC Rules. These limits are designed to provide reasonable protection against harmful interference in a residential installation. This equipment generates, uses and can radiate radio frequency energy and, if not installed and used in accordance with the instructions, may cause harmful interference to radio communications. However, there is no guarantee that interference will not occur in a particular installation. If this equipment does cause harmful interference to radio or television reception, which can be determined by turning the equipment off and on, the user is encouraged to try to correct the interference by one or more of the following measures:

- Reorient or relocate the receiving antenna.
- Increase the separation between the equipment and receiver.
- Connect the equipment into an outlet on a circuit different from that to which the receiver is connected.
- Consult the dealer or an experienced radio/TV technician for help.

## Safety and Regulatory

This equipment complies with FCC/IC radiation exposure limits set forth for uncontrolled equipment and meets the FCC radio frequency (RF) Exposure Guidelines in Supplement C to OET65 and RSS-102 of the IC radio frequency (RF) Exposure rules. This equipment has very low levels of RF energy that it deemed to comply without maximum permissive exposure evaluation (MPE). But it is desirable that it should be installed and operated with at least 20 cm and more between the radiator and person's body (excluding extremities: hands, wrists, feet and ankles).

This device and its antenna(s) must not be co-located or operating with any other antenna or transmitter except Grant condition.

## Note

This television includes a QAM demodulator which should allow you to receive unscrambled digital cable television programming via subscription service to a cable service provider. Availability of digital cable television programming in your area depends on the type of programming and signal provided by your cable service provider.

## Compatible Wall-Mount Bracket Information

Use the following Sony Wall-Mount Bracket with your TV model.

	Sony TV Model No.
	KDL-55HX751/KDL-55HX750/ KDL-46HX751/KDL-46HX750
Sony Wall-Mount Bracket Model No.	SU-WL500

Use with other Wall-Mount Brackets\* may cause instability and could result in property damage or injury.

\* For instructions on using the Wall-Mount bracket with your TV please go to <http://esupport.sony.com> for your TV model and download "Additional Information for Using Sony Wall-Mount Bracket".

## To Customers

Sufficient expertise is required for TV installations. Be sure to subcontract the installation to a Sony dealer or licensed contractor and pay adequate attention to safety during the installation.

## For Your Convenience

### Online Registration:

Be sure to register your TV.

**United States**     <http://productregistration.sony.com>

**Canada**             <http://www.sony.ca/registration>

### Software Updates:

Your TV is capable of receiving software updates. For the latest information about software updates for your TV, visit:

**United States**     <http://www.sony.com/tvsupport>

**Canada**             <http://www.sony.ca/support>

**NOTE:** If your TV is connected to the Internet, you can check for software updates by selecting **Settings, Product Support** and then **Software Update**.