

# FRIGIDAIRE

All about the

# Use & Care

of your Washer

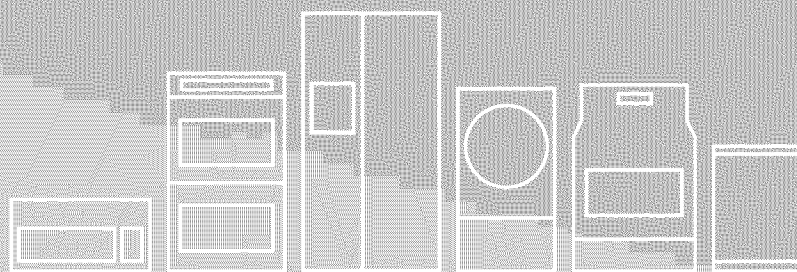

## TABLE OF CONTENTS

Important Safety Instructions.....	2-4	Solutions to Common Problems.....	22-26
Features.....	5	Warranty.....	27
Operating Instructions.....	6-15	Notes.....	28
Stain Removal Guide.....	16-17	Français.....	29
Care and Cleaning.....	18-21	Español.....	57

# IMPORTANT SAFETY INSTRUCTIONS

## WARNING

Please read all instructions before using this washer.

### Recognize safety symbols, words and labels

Safety items throughout this manual are labeled with a WARNING or CAUTION based on the risk type as described below:

#### Definitions

 This is the safety alert symbol. It is used to alert you to potential personal injury hazards. Obey all safety messages that follow this symbol to avoid possible injury or death.

## DANGER

DANGER indicates an imminently hazardous situation which, if not avoided, will result in death or serious injury.

## WARNING

WARNING indicates a potentially hazardous situation which, if not avoided, could result in death or serious injury.

## CAUTION

CAUTION indicates a potentially hazardous situation which, if not avoided, may result in minor or moderate injury.

## IMPORTANT

IMPORTANT indicates installation, operation or maintenance information which is important but not hazard-related.

## Product Record

### Record Your Model and Serial Numbers

The model and serial numbers of your washer are found on the washer serial plate located on the inside of the door. Record and retain these numbers.

**Model Number** \_\_\_\_\_

**Serial Number** \_\_\_\_\_

**Purchase Date** \_\_\_\_\_

Read all instructions before using this appliance. This book contains valuable information about:

- Operation
- Care
- Service

Keep it in a safe place.

This *Use and Care Guide* provides general operating instructions for your washer. It also contains information about features for several other models. Your washer may not have every feature included. Use the washer only as instructed in this *Use & Care Guide*.

## NOTE

The instructions appearing in this *Use and Care Guide* are not meant to cover every possible condition and situation that may occur. Common sense and caution must be practiced when installing, operating and maintaining any appliance.

**Save these instructions for future reference.**

# IMPORTANT SAFETY INSTRUCTIONS



## WARNING

To reduce the risk of fire, electrical shock, or injury to persons when using this washer, comply with the basic warnings listed below. Failure to comply with these warnings could result in serious personal injuries. You can be killed or seriously injured if you don't follow these Important Safety Instructions:

### PREVENT FIRE

- Do not wash items that have been previously cleaned in, soaked in, or spotted with gasoline, cleaning solvents, kerosene, cooking oils, waxes, etc. Do not store these items on or near the washer. These substances give off vapors or chemical reactions that could ignite or explode.
- Do not put oily or greasy rags or clothing on top of the washer. These substances give off vapors that could ignite the materials.
- Do not add gasoline, cleaning solvents, or other flammable or explosive substances to the wash water. These substances give off vapors that could ignite or explode.
- Under certain conditions, hydrogen gas may be produced in a hot water system that has not been used for 2 weeks or more. **HYDROGEN GAS IS EXPLOSIVE.** If the hot water system has not been used for such a period, before using the washer, turn on all hot water faucets and let the water flow from each for several minutes. This will release any accumulated hydrogen gas. Hydrogen gas is flammable; do not smoke or use an open flame during this time.
- Do not store or use gasoline or other flammable vapors or liquids in the vicinity of this or any other appliance.
- Failure to comply with these warnings could result in fire, explosion, serious bodily injury and/or damage to the rubber or plastic parts of the washer.

### PROTECT CHILDREN

- Do not allow children to play on or in the washer. Close supervision of children is necessary when the washer is used near children. As children grow, teach them the proper, safe use of all appliances.
- Destroy the carton, plastic bag and other packing materials after the washer is unpacked. Children might use them for play. Cartons covered with rugs, bedspreads or plastic sheets can become airtight chambers.
- Keep laundry products out of children's reach. To prevent personal injury, observe all warnings on product labels.
- Before the washer is removed from service or discarded, remove the washer door to prevent accidental entrapment.
- Failure to comply with these warnings could result in serious personal injuries.

# IMPORTANT SAFETY INSTRUCTIONS

## PREVENT INJURY

- To prevent shock hazard and assure stability during operation, the washer must be installed and electrically grounded by a qualified service person in accordance with local codes. Installation instructions are packed in the washer for installer's reference. Refer to **INSTALLATION INSTRUCTIONS** for detailed grounding procedures. If the washer is moved to a new location, have it checked and reinstalled by a qualified service person.
- To prevent personal injury or damage to the washer, the electrical power cord of the washer must be plugged into a properly grounded and polarized 3-prong outlet. The third grounding prong must never be removed. Never ground the washer to a gas pipe. Do not use an extension cord or an adaptor plug.
- Follow package directions when using laundry products. Incorrect usage can produce poisonous gas - resulting in serious injury or death.
- Do not combine laundry products for use in 1 load unless specified on the label.
- Do not mix chlorine bleach with ammonia or acids such as vinegar.

## WARNING

### FIRE/ELECTRICAL SHOCK HAZARD

Avoid fire hazard or electrical shock. Do not use an adaptor plug or extension cord or remove grounding prong from electrical power cord. Failure to follow this warning can cause serious injury, fire or death.

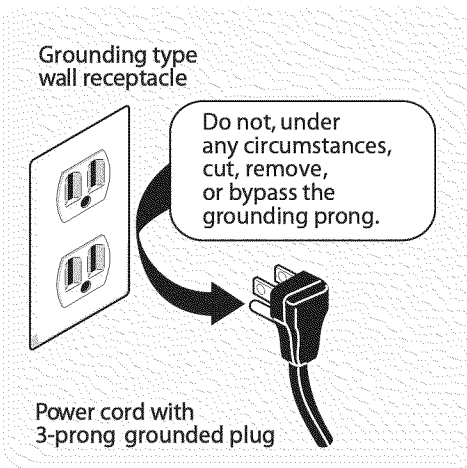

## PREVENT INJURY AND DAMAGE TO THE WASHER

To prevent serious personal injury and damage to the washer:

- All repairs and servicing must be performed by an authorized servicer unless specifically recommended in this Use & Care Guide. Use only authorized factory parts.
- Do not tamper with controls.
- Do not install or store the washer where it will be exposed to the weather.
- Do not install on carpet. Install washer on a solid floor. It may be necessary to reinforce the floor to prevent vibration or movement.
- Do not sit on, step on or stand on the washer. Do not rest heavy loads on top. The washer is not meant to support weight.
- To reduce the risk of electric shock, disconnect this appliance from the power supply before attempting any user maintenance. Turning the controls to the OFF position does not disconnect this appliance from the power supply.
- To prevent injury, do not reach into the washer while parts are moving. Before loading, unloading or adding items, push in the cycle selector knob and allow the drum to coast to a complete stop before reaching inside.
- This washer is equipped with an electrical overload protector. The motor will stop if it becomes overheated.
- Failure to comply with these warnings could result in serious personal injuries.

## WARNING

### HARMFUL VAPOR HAZARD

Do not use or mix liquid chlorine bleach with other household chemicals such as toilet cleaners, rust removers, acid or products containing ammonia. These mixtures can produce dangerous fumes which can cause serious injury or death.





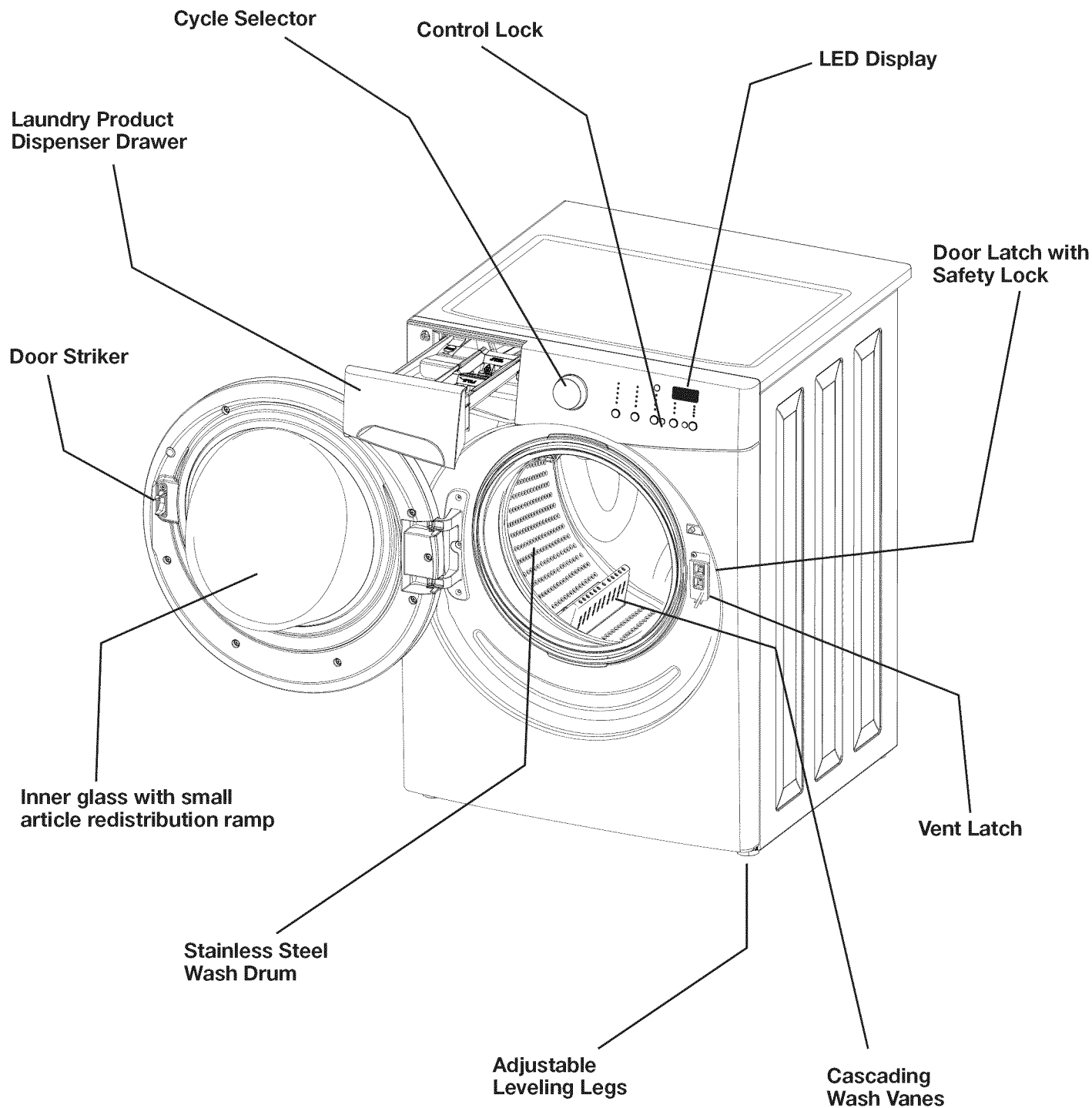

As an ENERGY STAR® Partner, Electrolux Major Appliances has determined that this product meets the ENERGY STAR® guidelines for energy efficiency.

# OPERATING INSTRUCTIONS

## Normal Operating Sounds

You may or may not hear the following sounds from your new washer:

- A. DRAIN HOSE** The washer has a flexible drain hose to carry water from the washer to the stand pipe of your home. You will hear water flowing into your stand pipe. This is a normal part of the operation of the washer.
- B. WATER VALVES/DISPENSER** As water enters the dispenser system, it is common to hear a water flowing sound. This normal sound will vary slightly based on the water pressure in your home.
- C. DRAIN PUMP** Your washer is equipped with a high velocity drain pump. It is normal to hear humming and gurgling sounds as water is pumped from the washer. Both of these sounds are normal and indicate that your pump is functioning correctly.
- D. HIGH SPEED MOTOR** A powerful motor is used to drive the drum to high spin speeds to extract water from your load. You will hear a sound associated with these higher spin speeds. This sound is normal and will vary slightly as the spin speed varies with load size and cycle selected.

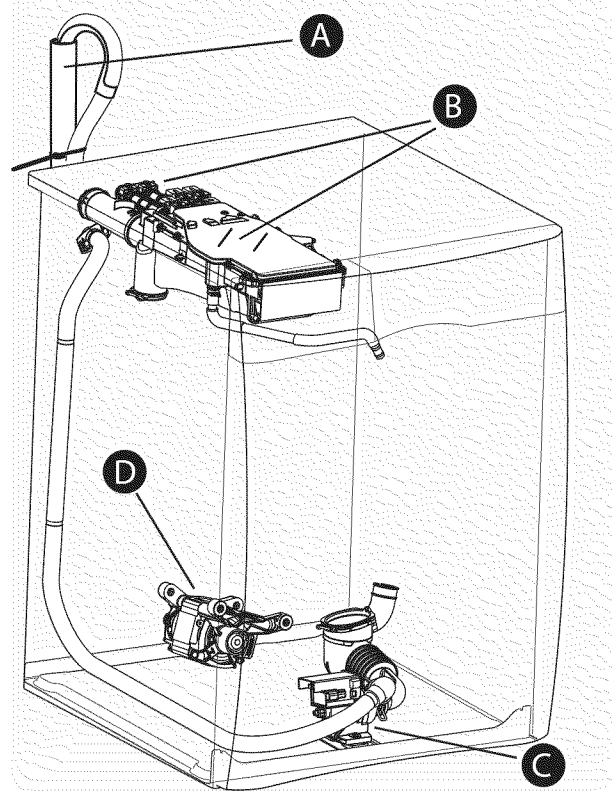

## CAUTION

Abnormal, on-going sounds may be an indication of a pending washer failure and should be investigated by a qualified technician.

## Operating Your Washer

### **WARNING**

To reduce the risk of fire, electric shock or injury to persons, read the IMPORTANT SAFETY INSTRUCTIONS in this **Use and Care Guide** before operating your washer.

#### **1 Sort laundry into loads that can be washed together.**

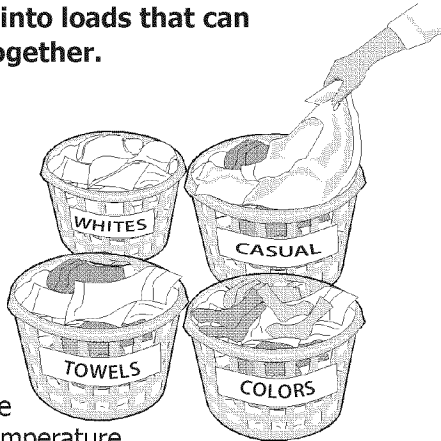

- Sort items by recommended cycle and water temperature.
- Separate white, light and colorfast items from dark and non-colorfast items.
- Separate items that shed lint from items that attract lint. Casual, synthetic, knit, and corduroy items will pick up lint from towels, rugs, and chenille bedspreads.
- Separate heavily soiled items from lightly soiled items.
- Separate lacy, sheer, loosely knit, or delicate items from durable items.
- Do not machine wash items containing fiberglass. Small particles of fiberglass left in the drum may transfer to fabrics in other loads and cause skin irritation.

#### **2 Prepare items for washing.**

- Empty pockets.

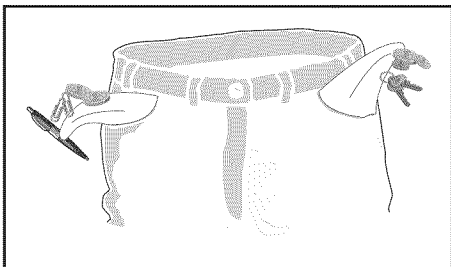

- Brush off lint and dirt. Shake out rugs and beach towels.
- Close zippers, fasten hooks, tie strings and sashes, and remove non-washable trims and ornaments.
- Mend rips and tears to prevent further damage during washing.
- Turn knit items inside out to prevent pilling.

- Place delicate and small items such as bras, hosiery and baby socks in a mesh bag.

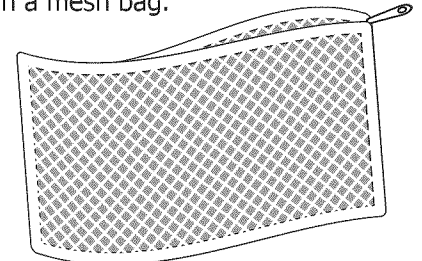

(Mesh bag not included.)

#### **3 Pretreat stains and heavy soil.**

- See **Stain Removal Guide** in this guide for safe, successful stain removal instructions.

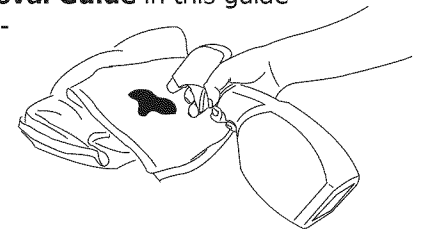

#### **4 Add laundry load to washer.**

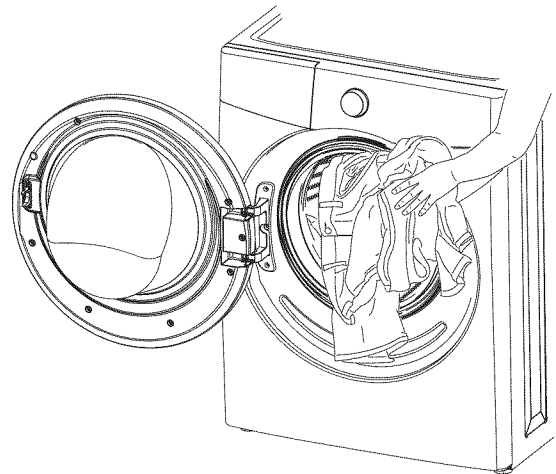

- Combine large and small items in a load.
- Load large items first. Large items should not be more than half the total wash load.
- Washing single items such as a sweater, towel or jeans is inefficient and may cause an out-of-balance load. Add 1 or 2 similar items to help balance the load.
- Wash a single heavy item such as a king-sized comforter, bedspread or sleeping bag separately.
- The washer can be fully loaded, but the items should not be tightly packed. The door should close easily.

# OPERATING INSTRUCTIONS

## Operating Your Washer, continued

### 5 Add laundry products to the dispenser.



#### For best results

Use a low-sudsing, high efficiency detergent to prevent oversudsing in front load washers. Look for this symbol on the detergent label: 

Detergent, liquid chlorine bleach and liquid fabric softener will be dispensed at the proper times in the cycle.

#### → IMPORTANT

Open and close the dispenser drawer slowly. Closing the drawer too quickly could result in early dispensing of the bleach or fabric softener.

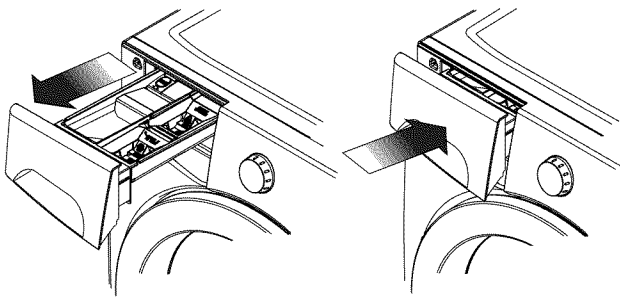

#### Liquid or Powder Detergent

- Use the cap or scoop provided by the detergent manufacturer to measure the amount recommended.
- Detergent dosage may need to be adjusted for water temperature, water hardness, load size and soil level.

#### Other Wash Products

Color-safe bleach, water conditioner, detergent booster and enzyme products may be added with the detergent. Put liquid products with liquid detergent in the "DETERGENT WASH" chamber or powder products with powder detergent in the "DETERGENT WASH" chamber.

#### → IMPORTANT

Do not mix liquids and powders.

#### → IMPORTANT

Use of multi-product (detergent plus softener) sheets or color-absorbing sheets NOT recommended. They could disable your machine and result in unwarranted repair costs.

#### 📌 NOTE

From time to time you may see water in the "LIQUID BLEACH" and "FABRIC SOFTENER" chambers. This is part of the normal operation of the washer.

#### Liquid Chlorine Bleach

- If desired, add liquid chlorine bleach to the chamber labeled "LIQUID BLEACH" and marked with this symbol .
- Fill to the MIN line for small loads or the MAX line for large loads.
- DO NOT fill above the maximum fill line.

#### → IMPORTANT

To prevent fabric damage, do not overfill the "LIQUID BLEACH" chamber or pour liquid chlorine bleach directly onto the load.

- Add color-safe bleach with the detergent.

#### Liquid Fabric Softener

- If desired, pour the recommended amount of liquid fabric softener into the chamber labeled "FABRIC SOFTENER" and marked with this symbol .
- Fill to the MIN line for small loads or the MAX line for large loads.
- DO NOT fill above the maximum fill line.

#### 📌 NOTE

To prevent staining, do not overfill the "FABRIC SOFTENER" chamber or pour liquid fabric softener directly on the wash load.

- Use of a fabric softener-dispensing ball is not recommended in tumble action washers.
- ### 6 Select the appropriate cycle and settings for the load.
- Turn the cycle selector knob in either direction to select the cycle desired.
  - The estimated cycle time, suitable wash and rinse water temperatures, final spin speed, soil level, and options for each cycle will be indicated for the cycle selected. See the "Washer Settings Chart" for more details.
  - To change the settings, press the **auto temp**, **spin speed** and **soil level** buttons to scroll to the desired settings.

## Operating Your Washer, continued

- To select or delete an option, press **options**; then, while the indicator is blinking, press **select**. The indicator will light when the option has been selected. It will no longer be lighted when the option has been deleted.

### NOTE

To provide the best care for your laundry, not every setting or option is available with every cycle. If a setting or option is not available for the cycle selected, the indicator will not light.

- Adjustments to a cycle will be remembered and recalled each time that cycle is selected in the future.

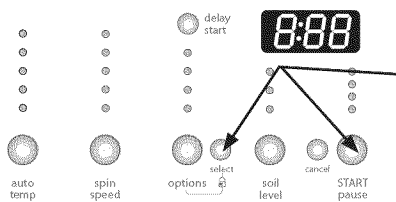

To return to factory settings, press these two buttons at the same time and hold until the signal sounds.

## 7 Start the washer.

- Close the door and press **START**. The washer will not operate with the door open. "PAU" will be displayed as a reminder to close the door.
- Select **delay start** to delay the beginning of the cycle, if desired.
- As a safety measure, the door will automatically lock during the entire wash cycle and the Door Lock indicator will be lighted.
- "Touch Pause to Add a Garment"

To add a forgotten item to the wash drum, press **Pause** and open the door. "PAU" will be displayed alternately with the estimated remaining cycle time. Add the item, close the door and press **START** to resume the cycle.

- If changes to the settings or options are attempted after the cycle starts, you will hear several beeps when the buttons are pressed. To change the settings or options, press **pause**, make the new selections and press **START** again.
- To change the cycle once the cycle has begun, press **cancel**, select a new cycle, and press **Start** again. Just turning the cycle selector knob will not change the cycle.
- To stop the cycle, press **cancel**.

### NOTE

If the cycle is interrupted during spin, it will take approximately 2-3 minutes for the door lock to release. DO NOT force open the door.

- A signal will sound at the end of the cycle if the **chime** option has been selected.
- Remove items from the washer when the cycle ends and place in dryer, line dry or dry flat as directed on the fabric care label.



- Excess wrinkling, color transfer or odors may develop in items left in the washer after the cycle has ended, if not removed promptly.

### CAUTION

#### ENTRAPMENT and TIP-OVER HAZARD

Do not leave the door open if there are small children or pets present. An open door could entice children to hang on the door or crawl inside the washer. If there are no small children present, you may leave the door ajar to prevent odor build up.

# OPERATING INSTRUCTIONS

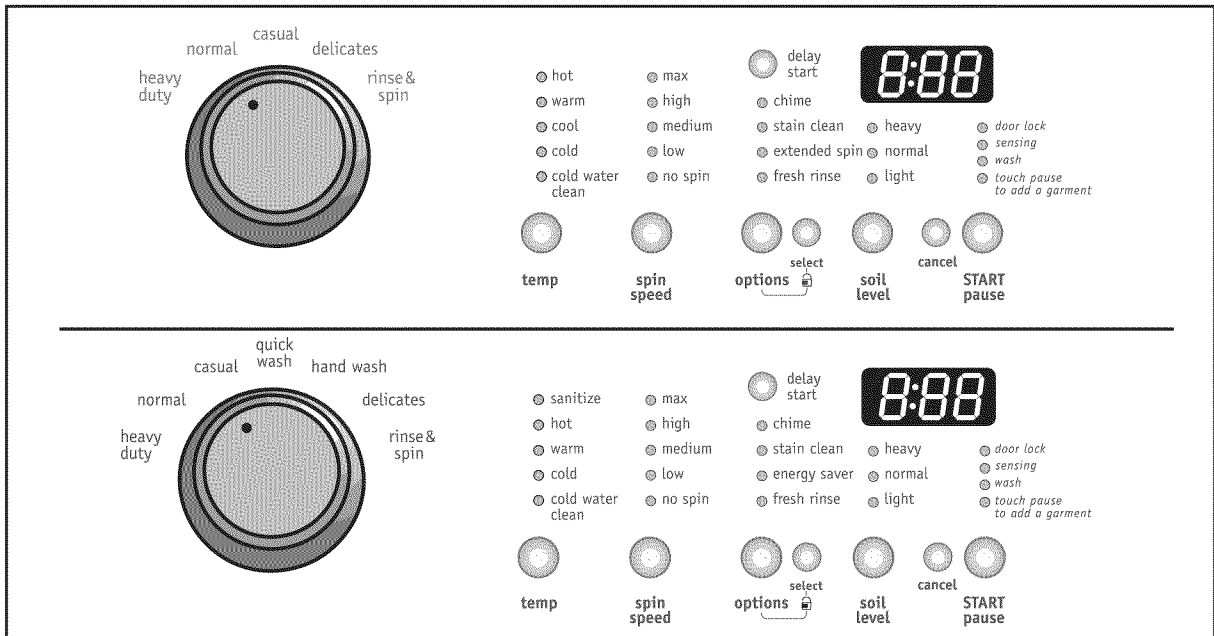

This manual covers many models and not all cycles, options, or features listed are available on every model. Console shown above for reference only. Your model may differ.

## Cycle Selection

Turn the cycle selector in either direction to the cycle desired.

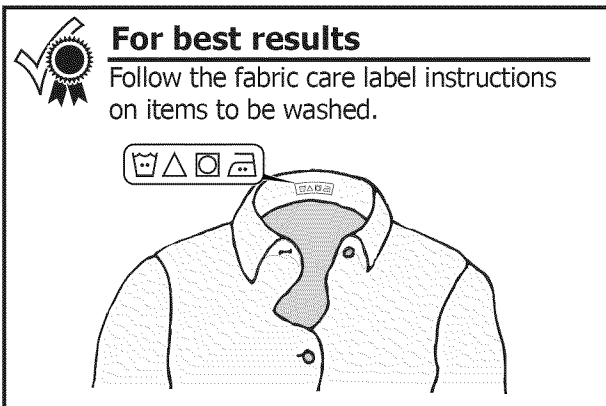

To change the cycle once it has begun, press the cancel button before selecting a new cycle. Just turning the cycle selector knob to another selection will not change the cycle.

### heavy duty

Use this cycle for heavily soiled, durable garments - ex. towels, sports gear, or fabric tote bags. For best soil and stain removal, use the hottest water safe for the fabrics being washed.

### normal

Use this load for cotton, linen, towels, shirts, sheets, denims and mixed loads.

### casual

Use this cycle for cottons and blends with a permanent press or no-iron finish.

### quick wash (on select models)

Quickly wash a small, lightly soiled load.

### hand wash (on select models)

Use this cycle to provide intermittent, gentle tumbling for items labeled "Hand Wash".

### delicates

Use this cycle for lightly soiled knits and delicates which require gentle washing.

### rinse & spin

Select **rinse & spin** for loads that need a cold water rinse or to add fabric softener that may have been omitted in a regular cycle. Add the fabric softener to the dispenser chamber. Select the spin speed appropriate for the load.

## NOTE

You may deselect **fresh rinse** if you wish to perform a **spin only** cycle or select **no spin** if you want to perform a drain only cycle.



# OPERATING INSTRUCTIONS

## Cycle Settings

### WASH WATER TEMPERATURE

To change the temperature, press the **auto temp** button to scroll to the desired setting. Select a wash water temperature according to fiber content, colorfastness and soil level. A cold water rinse saves energy and reduces wrinkling.

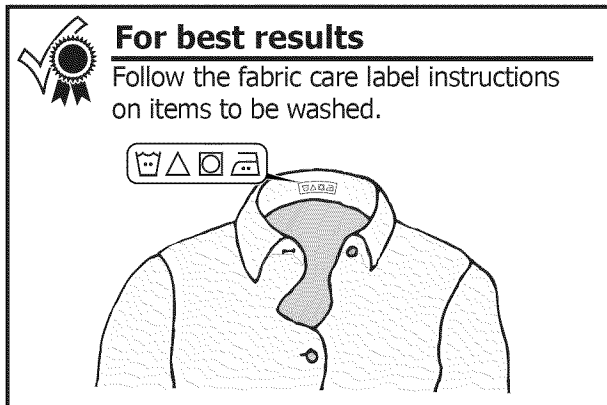

To protect your fabrics, not all temperatures are available with every cycle. The indicator will not light if the setting is not available with that cycle.

The temperature selected for the cycle will be remembered and recalled each time that cycle is selected in the future.

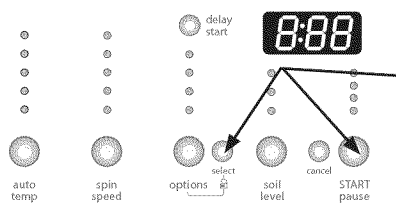

To return to factory settings, press these two buttons at the same time and hold until the signal sounds.

### NOTE

To change the temperature once the cycle has begun, press the **pause** button, make the new selection and press **START** again.

Wash water temperatures are automatically regulated to maximize detergent effectiveness and improve washing performance. The water heater setting and its distance from the washer, water usage in other parts of the home, and seasonally low ground water temperature in some geographic areas can affect water temperature.

#### sanitize (on select models)

This setting sanitizes heavily soiled colorfast fabrics such as towels, bedding, and children's clothing by killing 99.9% of bacteria using wash water heated with a boost heater to 152° F (67° C). Cold water is used to cool and rinse the load.

### NOTE

Only sanitizing cycles have been designed to meet the requirements of NSF P172 protocol for sanitization efficacy.



#### hot

Use this setting for heavily soiled white or colorfast cottons and blends.

#### warm

Use this setting for normally soiled white or colorfast cottons or blends.

#### cool (on select models)

Use this setting for normally soiled sheets, casual items and washable woolens.

#### cold

Some warm water will automatically blend with cold tap supply to achieve a precise **cold**. Use this setting for lightly soiled non-colorfast items, knits, delicates, and hand washables.

#### cold water clean

Wash and rinse temperatures are equivalent to temperature of cold tap supply. Use this selection for fabrics and colors that are prone to dye transfer. For use with cold water  detergents.

### SPIN SPEED

**Max, high, medium** and **low** spin speeds are available for each cycle. The spin speed and/or duration of final spin vary from model to model and cycle to cycle.

Increasing the spin speed will extract more water, decrease drying time and conserve energy. Decreasing the spin speed will reduce wrinkling.

Select **low** spin speed to gently spin items that should be line dried.

Use **no spin** to omit the final spin at the end of the cycle. The load will be very wet. Remove items from the wash drum to drip dry or select a **rinse & spin** cycle to remove excess water at a more convenient time.

### SOIL LEVEL

Adjust the wash time in 3-minute increments based on the soil level of each load. **Heavy, normal,** and **light** soil levels are available.

# OPERATING INSTRUCTIONS

## Cycle Options

To select or delete the **chime**, **stain clean**, **energy saver**, **extended spin** or **fresh rinse**, press **options** until the blinking light indicates the desired option. Then, while it is blinking, press **select**. The indicator will light when the option has been selected. It will no longer be lighted when the option has been removed.

Not all options are available on every model or are compatible with every cycle. The indicator will not light if the option is not available with that cycle.

### NOTE

To change the options once the cycle has begun, press the pause button, make the new selection and press start again.

The options selected for the cycle will be remembered and recalled each time that cycle is selected in the future. To return to factory settings, press the **START/pause** and **select** buttons at the same time and hold until the signal sounds.

#### chime

A signal will sound at the end of the cycle if this option is selected. The signal has an adjustable volume level or can be turned off.

#### stain clean

Use the **stain clean** option to add a 5-minute soak in the middle of the wash portion of the cycle.

#### energy saver (on select models)

The **energy saver** option reduces the warm water temperature a few degrees to save energy and also extracts more water to reduce drying time.

#### extended spin (on select models)

Use this option to add minutes to the final spin at the selected spin speed. This will improve water extraction, decrease drying time and save energy.

#### fresh rinse

Use this option when additional rinsing is desired to remove excess dirt and detergent. It is recommended for heavily soiled loads or if household members have sensitive skin.

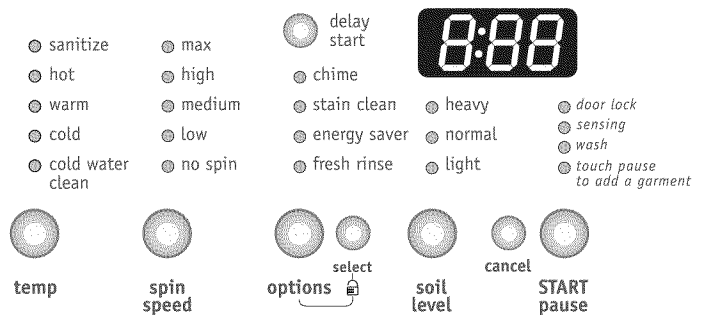
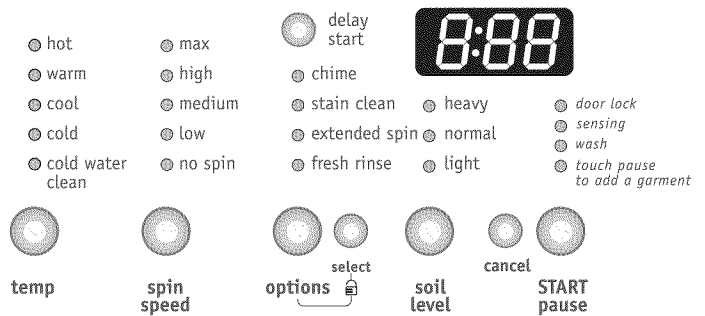

## Other Features

### Delay Start

Press **delay start** to select a wash time convenient to your schedule or during off peak energy hours. The delay time selected will be displayed and begin counting down when you select **START**.

### Control Lock

To avoid having someone accidentally start the washer, press **options** and **select** at the same time and hold for 10 seconds until "LOC" is displayed alternately with the estimated cycle time. To unlock the controls, press Options and Select at the same time and hold 10 seconds until "LOC" is no longer displayed.

### Status Display/Status Lights

The estimated total cycle time will be displayed when the cycle is selected. The time may increase if water pressure is low, oversudsing occurs or the load becomes unbalanced. The estimated remaining cycle time is displayed during the cycle. The following indicators may be lighted during the cycle:

- Door Lock
- Sensing
- Wash
- Touch Pause to Add a Garment

### Vent Latch

Help prevent odor buildup and mildew between washes by utilizing your washer's vent latch feature. To apply the vent latch, (1) open the door slightly, (2) lift the latch arm and then (3) press the arm down onto the plastic door strike, snapping it in place.

The vent latch can be released either of two ways - by pulling door out and manually returning latch arm to lower position or by pushing door shut and allowing latch arm to continue its pivot upward.

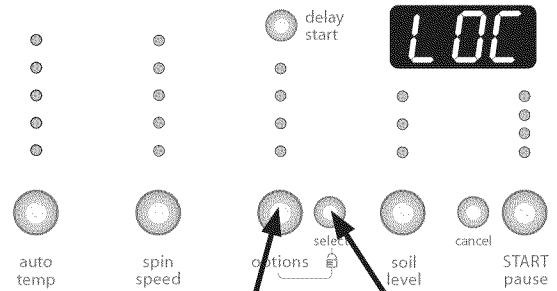

Press and hold both for ten seconds to lock or unlock the controls.

## → IMPORTANT

Do not attempt to close door if vent latch arm is disengaged and arm is in an outward position. Return latch arm to lower position before closing and latching the door.

## ↳ NOTE

The vent latch may become dislodged from hinge point if door closure is attempted while latch arm is not in an acceptable closing position. The latch arm can be snapped back in at the hinge location. Washer will still operate without latch arm installed.

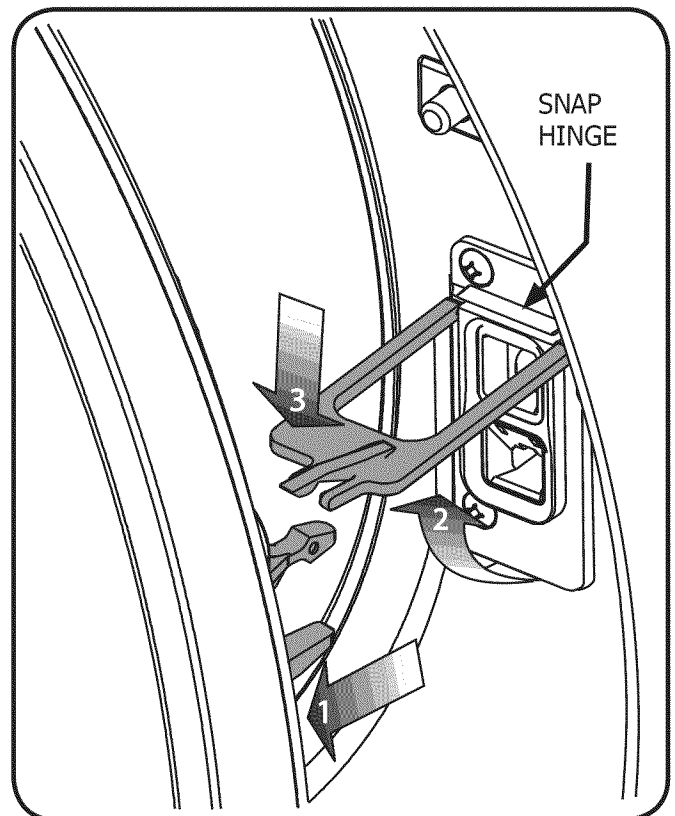

# OPERATING INSTRUCTIONS

## Washer Settings Chart

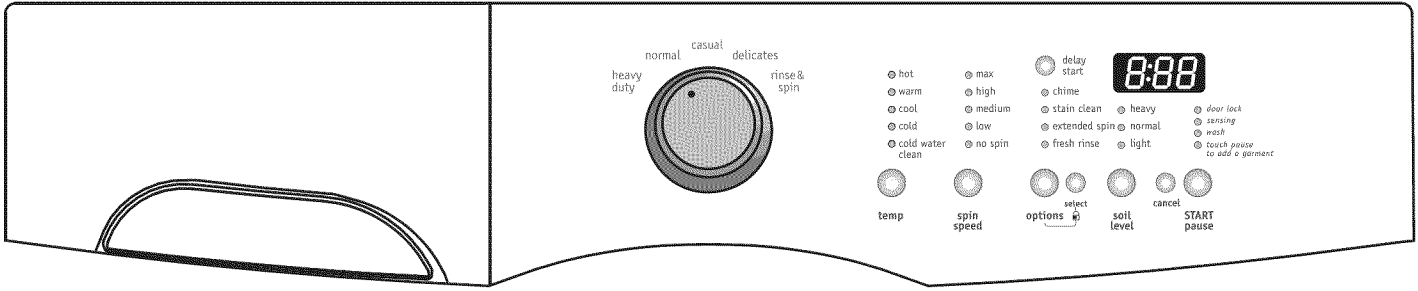

These Temperature, Spin Speeds, Soil Levels and Options are available with the following cycles:

	heavy duty	normal	casual	delicates	rinse & spin
temp					
hot	✓	✓			
warm	✓	✓	✓	✓	
cool	✓	✓	✓	✓	
cold	✓	✓	✓	✓	
cold water clean	✓	✓	✓	✓	✓
spin speed					
max	✓	✓			✓
high	✓	✓	✓		✓
medium	✓	✓	✓	✓	✓
low	✓	✓	✓	✓	✓
no spin		✓	✓	✓	✓
soil level					
heavy	✓	✓			
normal	✓	✓	✓	✓	
light		✓	✓	✓	
options					
chime	✓	✓	✓	✓	✓
stain clean	✓	✓	✓	✓	
extended spin	✓	✓	✓		
fresh rinse	✓	✓	✓	✓	✓
delay start	✓	✓	✓	✓	✓

✓ = Available selections.     = Cycle defaults.     = Non-modifiable presets.

# OPERATING INSTRUCTIONS

## Washer Settings Chart

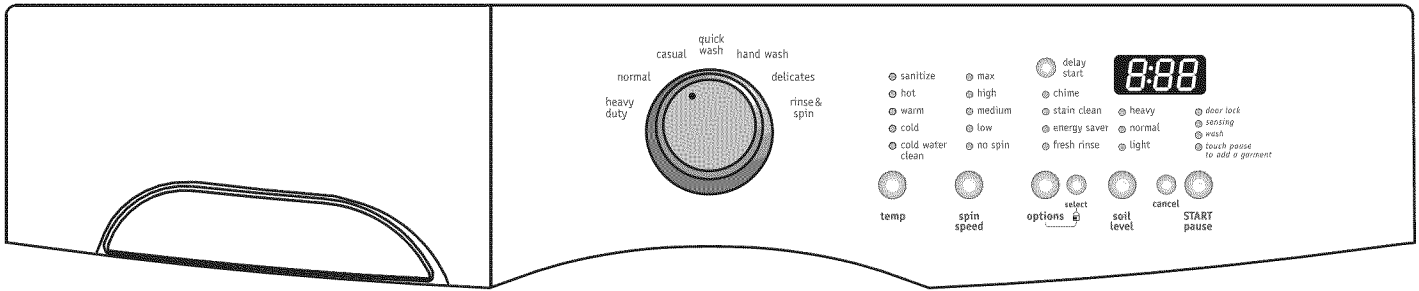

These Temperature, Spin Speeds, Soil Levels and Options are available with the following cycles:

	heavy duty	normal	casual	quick wash	hand wash	delicates	rinse & spin
<b>temp</b>							
sanitize	✓						
hot	✓	✓					
warm	✓	✓	✓	✓	✓	✓	
cold	✓	✓	✓	✓	✓	✓	
cold water clean	✓	✓	✓	✓	✓	✓	✓
<b>spin speed</b>							
max	✓	✓		✓			✓
high	✓	✓	✓	✓			✓
medium	✓	✓	✓			✓	✓
low		✓	✓		✓	✓	✓
no spin		✓	✓		✓	✓	✓
<b>soil level</b>							
heavy	✓	✓					
normal	✓	✓	✓			✓	
light		✓	✓	✓	✓	✓	
<b>options</b>							
chime	✓	✓	✓	✓	✓	✓	✓
stain clean	✓	✓	✓			✓	
energy saver	✓	✓	✓				
fresh rinse	✓	✓	✓	✓	✓	✓	✓
delay start	✓	✓	✓	✓	✓	✓	✓

✓ = Available selections.     = Cycle defaults.     = Non-modifiable presets.

# STAIN REMOVAL GUIDE

## Safe Stain Removal Procedures

To reduce the risk of fire or serious injury to persons or property, comply with the basic warnings listed below:

- Read and comply with all instructions on stain removal products.
- Keep stain removal products in their original labeled containers and out of children's reach.
- Thoroughly wash any utensils used.
- Do not combine stain removal products, especially ammonia and chlorine bleach. Dangerous fumes can result.
- Never wash items which have been previously cleaned in, washed in, soaked in or spotted with gasoline, dry cleaning solvents or other flammable or explosive substances because they give off vapors that could ignite or explode.
- Never use highly flammable solvents, such as gasoline, inside the home. Vapors can explode on contact with flames or sparks.

## For Successful Stain Removal:

- Remove stains promptly.
- Determine the kind of stain, then follow the recommended treatment in the stain removal chart on the next page.
- To pretreat stains, use a prewash product, liquid detergent, or a paste made from powder detergent and water.
- Use cold water on unknown stains because hot water can set stains.
- Consult care label instructions for treatments to avoid on specific fabrics.
- Check for colorfastness by testing stain remover products on an inside seam.
- Rinse and wash items after stain removal.

## WARNING

### HARMFUL VAPOR HAZARD

Do not use or mix liquid chlorine bleach with other household chemicals such as toilet cleaners, rust removers, acid or products containing ammonia. These mixtures can produce dangerous fumes which can cause serious injury or death.



## For best results

Follow the fabric care label instructions on items to be washed.

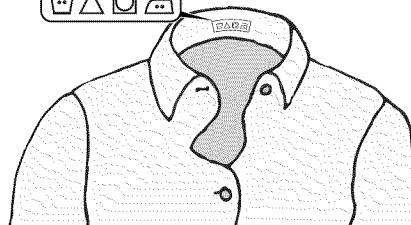



## Stain Removal Suggestions

STAIN	TREATMENT
Adhesive tape, chewing gum, rubber cement	Apply ice. Scrape off excess. Place stain face down on paper towels. Saturate with pre-wash stain remover or nonflammable dry cleaning fluid.
Baby formula, dairy products, egg	Use product containing enzymes to pretreat or soak stains. Soak for 30 minutes or more. Wash.
Beverages (coffee, tea, soda, juice, alcoholic beverages)	Pretreat stain. Wash using cold water and bleach safe for fabric.
Blood	Rinse with cold water. Rub with bar soap. Or, pretreat or soak with product containing enzymes. Wash using bleach safe for fabric.
Candle wax, crayon	Scrape off surface wax. Place stain face down between paper towels. Press with warm iron until wax is absorbed. Replace paper towels frequently. Treat remaining stain with prewash stain remover or nonflammable dry cleaning fluid. Hand wash to remove solvent. Wash using bleach safe for fabric.
Chocolate	Pretreat or soak in warm water using product containing enzymes. Wash using bleach safe for fabric.
Collar or cuff soil, cosmetics	Pretreat with prewash stain remover or rub with bar soap.
Dye transfer on white fabric	Use packaged color remover. Wash using bleach safe for fabric.
Grass	Pretreat or soak in warm water using product containing enzymes. Wash using bleach safe for fabric.
Grease, oil, tar (butter, fats, salad dressing, cooking oils, car grease, motor oils)	Scrape residue from fabric. Pretreat. Wash using hottest water safe for fabric. For heavy stains and tar, apply nonflammable dry cleaning fluid to back of stain. Replace towels under stain frequently. Rinse thoroughly. Wash using hottest water safe for fabric.
Ink	Some inks may be impossible to remove. Washing may set some inks. Use prewash stain remover, denatured alcohol or nonflammable dry cleaning fluid.
Mildew, scorch	Wash with chlorine bleach if safe for fabric. Or, soak in oxygen bleach and hot water before washing. Badly mildewed fabrics may be permanently damaged.
Mud	Brush off dry mud. Pretreat or soak with product containing enzymes.
Mustard, tomato	Pretreat with prewash stain remover. Wash using bleach safe for fabric.
Nail polish	May be impossible to remove. Place stain face down on paper towels. Apply nail polish remover to back of stain. Repeat, replacing paper towels frequently. Do not use on acetate fabrics.
Paint, varnish	WATER BASED: Rinse fabric in cool water while stain is wet. Wash. Once paint is dry, it cannot be removed. OIL BASED AND VARNISH: Use solvent recommended on can label. Rinse thoroughly before washing.
Perspiration	Use prewash stain remover or rub with bar soap. Rinse. Wash using nonchlorine bleach in hottest water safe for fabric.
Rust, brown or yellow discoloration	Use rust remover safe for fabric. Do not use chlorine bleach because it may intensify discoloration.
Shoe polish	LIQUID: Pretreat with a paste of powder detergent and water. PASTE: Scrape residue from fabric. Pretreat with prewash stain remover or nonflammable dry cleaning fluid. Rinse. Rub detergent into dampened area. Wash using bleach safe for fabric.
Tomato	Pretreat with prewash stain remover. Wash using bleach safe for fabric.
Urine, vomit, mucus, feces	Pretreat or soak in product containing enzymes. Wash using bleach safe for fabric.
Wine	Pretreat or soak in cold water. Wash in hottest water and bleach safe for fabric

## CARE AND CLEANING

### Inside Routine Cleaning (Preventive)

To help prevent odors, mold or mildew, leave the door open for a few hours after use or whenever the washer is not in use.

#### CAUTION

##### ENTRAPMENT and TIP-OVER HAZARD

Do not leave the door open if there are small children or pets present. An open door could entice children to hang on the door or crawl inside the washer. If there are no small children present, you may leave the door ajar to prevent odor build up.

#### TO REFRESH OR CLEAN INSIDE OF WASHER

To clean and freshen the washer, perform the **system clean** cycle. For best results use the **system clean** cycle once a month. To begin the cycle, press and hold the **spin speed** and **options** buttons simultaneously for 10 seconds until the display changes to "CLn".

#### IMPORTANT

Items left in washer while performing the **system clean** cycle will cause a severe out-of-balance situation that could damage the washing machine.

REMOVE ALL ITEMS FROM WASH DRUM before filling the detergent chamber with one (1) cup of liquid chlorine bleach OR one (1) pouch of TIDE® WASHING MACHINE CLEANER. **DO NOT** use both. Press **START** to begin.



#### For best results

Immediately follow up with a **rinse & spin** cycle. Select **fresh rinse** on **max spin** speed with no detergent or bleach to help clear any residual bleach left after the **system clean** cycle.

#### NOTE

If the **system clean** cycle is cancelled or paused during the cycle, the washer will go through 2 rinse cycles to clean the drum of any residual bleach before unlocking the door.

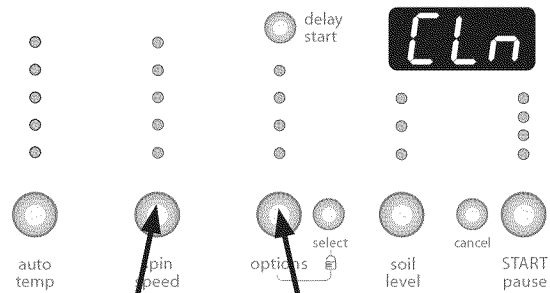

Press and hold both for ten seconds to enter **system clean** cycle.

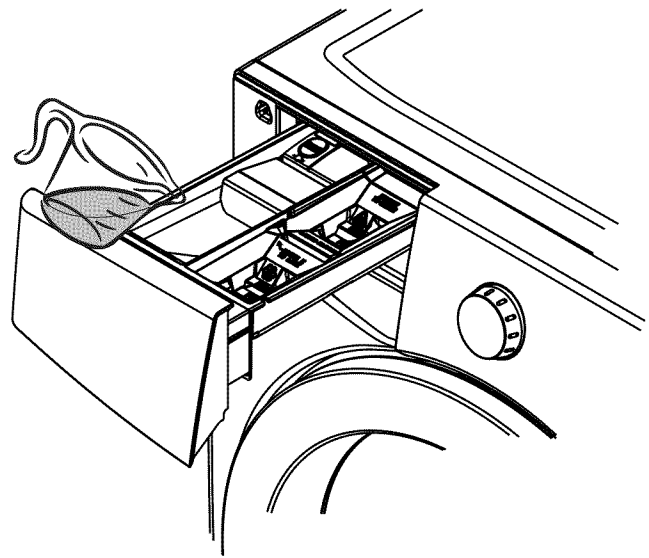

#### WARNING

##### HARMFUL VAPOR HAZARD

Do not use or mix liquid chlorine bleach with other household chemicals such as toilet cleaners, rust removers, acid or products containing ammonia. These mixtures can produce dangerous fumes which can cause serious injury or death.



## Other Inside Routine Cleaning (Preventive)

### Cleaning Dispenser Drawer Area

#### NOTE

Detergent and fabric softener may build up in the dispenser drawer. Residue should be removed once or twice a month.

- Remove the drawer by pulling the drawer out until it stops.
- Reach back into the left rear corner of the drawer cavity and press down firmly on the lock tab. Pull out the drawer.
- Remove the insert from the bleach and fabric softener compartments.
- Rinse the drawer and inserts with a combination of  $\frac{3}{4}$  cup liquid chlorine bleach and 1 gallon hot tap water to remove traces of accumulated powders and liquids. Large amounts of fabric softener residue may indicate improper dilution or more frequent cleaning is required. Rinse well with tap water.
- To clean the drawer opening, use a small brush to clean the recess. Remove all residue from the upper and lower parts of the recess.
- Replace the insert by pressing it in place until you hear a slight click. Return the dispenser drawer.

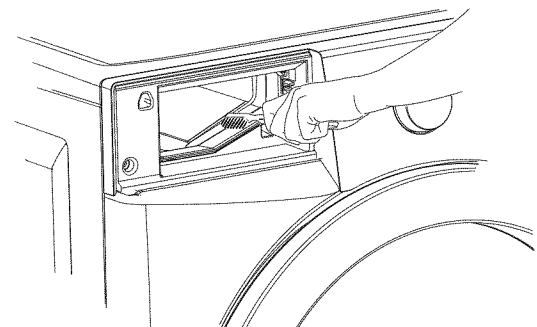
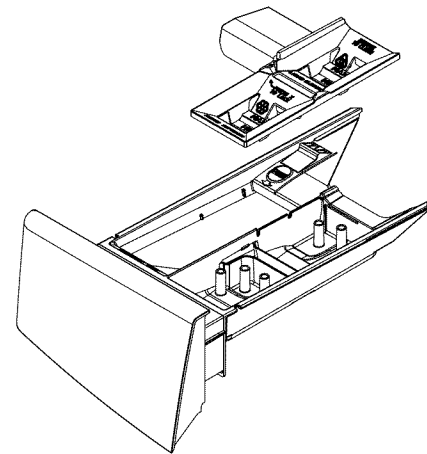
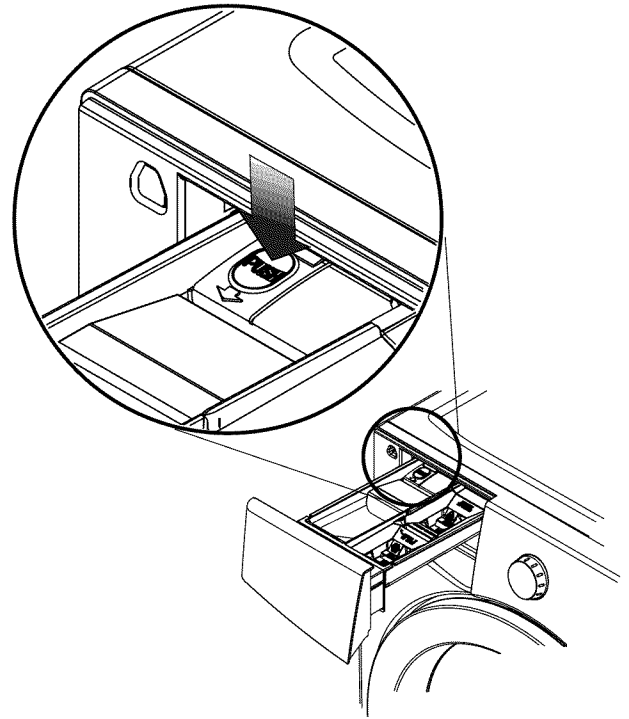

#### Daily Preventive Maintenance

- Remove items from the washer as soon as the cycle ends. Excess wrinkling, color transfer, and odors may develop in items left in the washer.
- If there are no small children or pets present, you may leave the door ajar when the washer is not in use.
- Leave the dispenser drawer open slightly at the end of the wash day.
- Dry around the washer door opening, flexible gasket, and door glass. These areas should always be clean to ensure a water tight seal.
- When extremely soiled items have been washed, a dirty residue may remain on the drum. Remove this by wiping the drum with a nonabrasive household cleanser. Rinse thoroughly with water.
- Periodically, wipe dry the folds in the bottom of the flexible gasket to remove lint and other debris.

## CARE AND CLEANING

### Inside Cleaning (Aggressive)

In cases where System Clean Cycle along with care and cleaning of rubber gasket folds isn't done, and severe odor, mold, mildew, or residue buildup have developed, follow the below cleaning procedure to help alleviate the problem.

#### CLEANING PROCEDURE - Washer Drum

Ensure the wash tub is empty (or no clothes load). Open the detergent drawer and pour eight (8) cups of bleach into the detergent compartment on the left. Select System Clean cycle as described previously in **Inside Routine Cleaning (Preventive)**.

Upon cycle completion inspect the interior of the washer to see if the odor/residue has been eliminated. If any additional cleaning is required, repeat the above procedure. This may take several cycles depending on the severity of the odor/residue. You may observe some remaining discoloration due to the long term effects of this residue.

For especially contaminated areas visible inside the drum (including the front rubber seal), these areas might be more effectively cleaned by spraying a Bleach Cleaner on a scrub brush, soft sponge, or towel and scrubbing.

#### ➔ IMPORTANT

Always wear rubber or latex gloves and protect floor and clothing from damage.

If odor is still left after bleach cycle(s) and bleach cleaner, open the detergent drawer and pour one (1) pouch of TIDE® WASHING MACHINE CLEANER in detergent drawer. Select **system clean** cycle as above and start the washer.



#### For best results

Immediately follow up with a **rinse & spin** cycle. Select **fresh rinse** on **max spin speed** with no detergent or bleach to help clear any residual bleach left after the **system clean** Cycle.

#### ➔ IMPORTANT

See **Inside Routine Cleaning (Preventive)** for future cleaning maintenance which is necessary to avoid repeating issues.

#### 📌 NOTE

If the **system clean** cycle is cancelled or paused during the cycle, the washer will go through 2 rinse cycles to clean the drum of any residual bleach before unlocking the door.

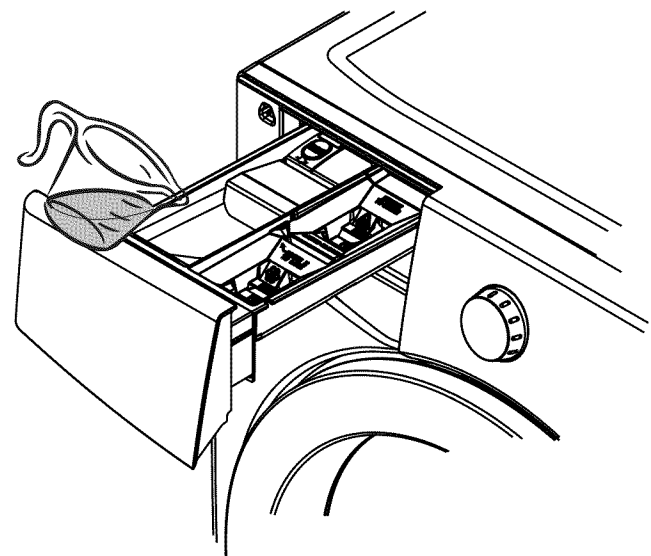
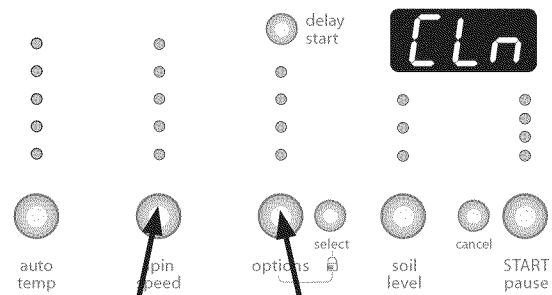

#### ⚠ WARNING

##### HARMFUL VAPOR HAZARD

Do not use or mix liquid chlorine bleach with other household chemicals such as toilet cleaners, rust removers, acid or products containing ammonia. These mixtures can produce dangerous fumes which can cause serious injury or death.



### Outside Routine Cleaning

- When washing is completed, wipe top and sides of washer with a damp cloth. Turn water faucets off to prevent pressure build-up in the hoses.
- Clean the cabinet with mild soap and water. Never use harsh, gritty or abrasive cleansers
- If the cabinet becomes stained, clean with diluted chlorine bleach (1 part bleach to 8 parts water). Rinse several times with clear water.
- Remove glue residue from tape or labels with a mixture of warm water and mild detergent. Or, touch residue with the sticky side of tape.
- When cleaning chrome parts use a window cleaner with ammonia or mild soap and water.
- Before moving the washer, place a strip of cardboard or thin fiberboard under the front leveling legs to prevent damage to the floor.

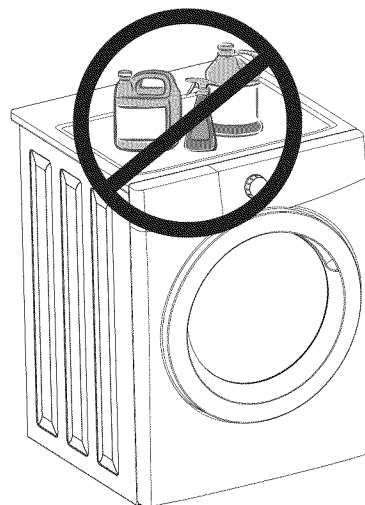

### ➔ IMPORTANT

Do not store or place laundry products on top of washer at any time. They can damage the finish or controls.

### Winterizing Instructions

#### ➔ IMPORTANT

If the washer is stored in an area where freezing can occur or moved in freezing temperatures, follow these winterizing instructions to prevent damage to the washer:

- 1 Turn off water supply faucets.
- 2 Disconnect hoses from water supply and drain water from hoses.
- 3 Plug electrical cord into a properly grounded electrical outlet.
- 4 Add 1 gallon (3.8 L) nontoxic recreational vehicle (RV) antifreeze to empty wash drum. Close door.
- 5 Select the Spin Only cycle. Press Start and let the washer drain for 1 minute to drain out all the water. Not all of the RV antifreeze will be expelled.
- 6 Press Cancel, unplug electrical power cord, dry off drum interior and close door.
- 7 Remove dispenser drawer. Drain any water in compartments and dry compartments. Replace drawer.
- 8 Store washer in an upright position.
- 9 To remove antifreeze from washer after storage, perform Clean System Cycle as described earlier.



## SOLUTIONS TO COMMON PROBLEMS

### Common Washing Problems

Many washing problems involve poor soil and stain removal, residues of lint and scum, and fabric damage. For satisfactory washing results, follow these suggestions provided by The Soap and Detergent Association.

PROBLEM	POSSIBLE CAUSES	SOLUTIONS	PREVENTIVE MEASURES
Blue stains	<ul style="list-style-type: none"> <li>• Undiluted liquid detergent or fabric softener dispensed directly onto fabric.</li> </ul>	<ul style="list-style-type: none"> <li>• If caused by detergent, mix 1 cup (240 ml) white vinegar with 1 quart (.95 L) water in a plastic container. Soak item 1 hour. Rinse.</li> <li>• If caused by fabric softener, rub stains with bar soap. Wash.</li> </ul>	<ul style="list-style-type: none"> <li>• Avoid overfilling detergent and fabric softener compartments of dispenser.</li> </ul>
Discoloration, graying	<ul style="list-style-type: none"> <li>• Not enough detergent.</li> <li>• Wash water temperature too low.</li> <li>• Incorrect sorting.</li> </ul>	<ul style="list-style-type: none"> <li>• Rewash with correct amount of detergent and hottest water safe for fabric.</li> <li>• Add bleach safe for fabric.</li> </ul>	<ul style="list-style-type: none"> <li>• Sort items by soil level and color.</li> <li>• Use correct amount of detergent, hottest water and bleach safe for fabric.</li> </ul>
Greasy, oily stains	<ul style="list-style-type: none"> <li>• Not enough detergent.</li> <li>• Undiluted liquid fabric softener poured directly on fabric.</li> </ul>	<ul style="list-style-type: none"> <li>• Treat with prewash stain remover or liquid detergent.</li> <li>• Increase detergent and water temperature. Rewash.</li> <li>• Rub fabric softener stains with bar soap.</li> </ul>	<ul style="list-style-type: none"> <li>• Use correct amount of detergent and hottest water safe for fabric.</li> <li>• Do not pour liquid fabric softener directly on fabric. See Operating Your, step 5.</li> </ul>
Holes, tears, or snags	<ul style="list-style-type: none"> <li>• Incorrect use of chlorine bleach.</li> <li>• Unfastened zippers, hooks, buckles.</li> <li>• Rips, tears and broken threads.</li> <li>• Overloading the washer.</li> <li>• Degradation of fabric.</li> </ul>	<ul style="list-style-type: none"> <li>• May be irreversible if rips, tears and seams cannot be mended.</li> </ul>	<ul style="list-style-type: none"> <li>• Never pour chlorine bleach directly on fabric.</li> <li>• Check condition of items before washing. See Operating Your, steps 2 and 5.</li> </ul>
Lint	<ul style="list-style-type: none"> <li>• Incorrect sorting.</li> <li>• Tissues left in pocket.</li> <li>• Overloading the washer.</li> <li>• Not enough detergent.</li> <li>• Undissolved detergent has left a residue resembling lint.</li> <li>• Static cling is attracting lint.</li> <li>• Load washed too long.</li> </ul>	<ul style="list-style-type: none"> <li>• Reduce load size. Rewash using correct water temperature, water level, and amount of detergent.</li> <li>• Add nonprecipitating water conditioner to wash water to remove detergent residue.</li> <li>• Add liquid fabric softener to final rinse.</li> <li>• Dry load in dryer.</li> <li>• Remove lint with lint brush or roller.</li> </ul>	<ul style="list-style-type: none"> <li>• See Operating Your, steps 1 and 2.</li> <li>• Do not overload washer.</li> <li>• Use correct temperature and amount of detergent, water and wash time.</li> </ul>



## SOLUTIONS TO COMMON PROBLEMS

### Common Washing Problems, continued

PROBLEM	POSSIBLE CAUSES	SOLUTIONS	PREVENTIVE MEASURES
Pilling (Fibers ball up and cling to fabric.)	<ul style="list-style-type: none"> <li>Pilling is normal with synthetic and permanent press fabrics. This is due to abrasion from normal wear.</li> </ul>	<ul style="list-style-type: none"> <li>Use a lint brush or shaver to remove pills.</li> </ul>	<ul style="list-style-type: none"> <li>Use fabric softener in the washer to lubricate fibers.</li> <li>When ironing, use spray starch or fabric finish on collars and cuffs.</li> <li>Turn items inside out to reduce abrasion.</li> </ul>
Residue or powder on dark items; Stiff, harsh fabrics.	<ul style="list-style-type: none"> <li>Undissolved detergent.</li> <li>Some granular detergents can combine with hard water minerals to form a residue.</li> <li>Overloading the washer.</li> </ul>	<ul style="list-style-type: none"> <li>Rewash load.</li> </ul>	<ul style="list-style-type: none"> <li>Increase water temperature using hottest water safe for fabric.</li> <li>Do not overload washer.</li> <li>Use liquid detergent or use nonprecipitating water conditioner with powder detergent.</li> </ul>
Wrinkling	<ul style="list-style-type: none"> <li>Overloading the washer.</li> <li>Incorrect wash cycle for wash load.</li> </ul>	<ul style="list-style-type: none"> <li>Reduce load size.</li> <li>Rinse in cold water with liquid fabric softener using the casual or delicate cycle.</li> </ul>	<ul style="list-style-type: none"> <li>Do not overload washer.</li> <li>Remove items from washer as soon as cycle is completed.</li> <li>Use liquid fabric softener.</li> </ul>
Yellow buildup of body soil on synthetic fabrics	<ul style="list-style-type: none"> <li>Agitation time too short.</li> <li>Wash water temperature too low.</li> <li>Not enough detergent.</li> </ul>	<ul style="list-style-type: none"> <li>Soak in detergent booster or product containing enzymes.</li> <li>Wash in hottest water safe for fabric using casual cycle.</li> <li>Increase detergent.</li> <li>Add bleach safe for fabric or treat with color remover.</li> </ul>	<ul style="list-style-type: none"> <li>Select correct wash cycle.</li> <li>Use correct amount of detergent.</li> <li>Wash synthetics frequently using hot or warm water.</li> </ul>
Yellow or brown rust stains	<ul style="list-style-type: none"> <li>Iron or manganese in water supply, water pipes, or water heater.</li> </ul>	<ul style="list-style-type: none"> <li>To restore discolored load of whites, use rust remover safe for fabric.</li> <li>Do not use chlorine bleach to remove rust stains. It may intensify discoloration.</li> </ul>	<ul style="list-style-type: none"> <li>Use nonprecipitating water softener.</li> <li>Before washing, run hot water for a few minutes to clear lines.</li> <li>Drain water heater occasionally.</li> <li>For an ongoing problem, install an iron filter in your water supply system.</li> </ul>

## SOLUTIONS TO COMMON PROBLEMS

### Common Washing Problems, continued

PROBLEM	POSSIBLE CAUSES	SOLUTIONS	PREVENTIVE MEASURES
Residue stains / buildup, mold or mildew stains in gasket	<ul style="list-style-type: none"> <li>Moisture in the washer.</li> <li>Use of non-HE detergent.</li> <li>Overdosing detergent.</li> <li>Overloading wash drum.</li> <li>Leaving a wet load set in washer.</li> <li>Cold water washes which may not completely dissolve and remove detergents.</li> </ul>	<ul style="list-style-type: none"> <li>Perform SYSTEM CLEAN cycle</li> <li>Scrub gasket with Comet™ Spray Gel Mildew Stain Remover using brush to remove stains.</li> <li>Use only HE (high efficiency detergent) along with recommended dosage.</li> <li>Remove wash load immediately upon cycle completion.</li> </ul>	<ul style="list-style-type: none"> <li>Run dehumidifier in laundry room.</li> <li>Avoid overfilling detergent and fabric softener compartments of dispenser.</li> <li>Dry the inside of washer and gasket after every run.</li> </ul>
Residue stains / buildup, mold or mildew stains in dispenser drawer	<ul style="list-style-type: none"> <li>Moisture in the washer.</li> <li>Use of non-HE detergent.</li> <li>Overdosing detergent.</li> </ul>	<ul style="list-style-type: none"> <li>Remove dispenser drawer and wipe dispenser and inserts with combination of ¾ cup liquid chlorine bleach and one gallon hot water. Rinse well, and repeat if necessary. Return drawer to location. NOTE: Wear rubber of latex gloves. Protect floor and clothing from bleach damage.</li> <li>Use only HE (high efficiency detergent) along with recommended dosage.</li> </ul>	<ul style="list-style-type: none"> <li>Avoid overfilling detergent and fabric softener compartments of dispenser.</li> </ul>
Water in fold of flexible gasket	<ul style="list-style-type: none"> <li>Result of washing and part of normal operation.</li> </ul>	<ul style="list-style-type: none"> <li>At the end of each wash, dry inside of gasket fold with clean dry towel all around gasket.</li> </ul>	
Odor	<ul style="list-style-type: none"> <li>Moisture in the washer.</li> <li>Use of non-HE detergent.</li> <li>Overdosing detergent.</li> <li>Leaving a wet load remain in washer.</li> <li>Cold water washes which may not completely dissolve and remove detergents.</li> </ul>	<ul style="list-style-type: none"> <li>Perform SYSTEM CLEAN cycle.</li> <li>At the end of each wash, dry inside of gasket fold with clean, dry towel all around gasket.</li> <li>Use only HE (high efficiency detergent) along with recommended dosage.</li> <li>Remove wash load immediately upon cycle completion.</li> <li>Pour one cup liquid chlorine bleach in standpipe; let remain a day and flush with water.</li> </ul>	<ul style="list-style-type: none"> <li>Leave door and dispenser drawer open for a few hours after use or whenever washer is not in use.</li> </ul>

# SOLUTIONS TO COMMON PROBLEMS

## Service Prevention Checklist

Before calling for service, review this list. It may save both time and expense. The list includes common occurrences that are not the result of defective workmanship or materials in this washer.

OCURRENCE	POSSIBLE CAUSE	SOLUTION
<b>NOISE</b>		
High pitch "jet engine" noise.	A certain amount of motor whine is normal during the spin cycle.	
Rattling and clanking noise.	Foreign objects such as coins or safety pins may be in drum or pump.	Stop washer and check drum. If noise continues after washer is restarted, objects may be in pump. Call your authorized servicer.
	Belt buckles and metal fasteners are hitting wash drum.	To prevent unnecessary noise and damage to drum, fasten fasteners and turn items inside out.
Thumping sound.	Heavy wash loads may produce a thumping sound. This is usually normal. If sound continues, washer is probably out of balance.	Stop washer and redistribute wash load.
Vibrating noise.	Washer is not resting firmly on floor.	Move washer so it rests firmly on floor. Adjust leveling legs. See INSTALLATION INSTRUCTIONS for details.
	Shipping bolts and foam block have not been removed during installation.	See INSTALLATION INSTRUCTIONS for removing shipping bolts and foam block.
	Wash load unevenly distributed in drum.	Stop washer and rearrange wash load.
<b>OPERATING</b>		
Washer does not start.	Electrical power cord may not be plugged in or connection may be loose.	Make sure plug fits tightly in wall outlet.
	House fuse blown, circuit breaker tripped, or a power outage has occurred.	Reset circuit breaker or replace fuse. Do not increase fuse capacity. If problem is a circuit overload, have it corrected by a qualified electrician. If problem is a power outage, call local electric company.
	Water supply faucets are not turned on.	Turn on water supply faucets.
	Motor is overheated. Washer motor will stop if it becomes overheated.	It will automatically restart after a cool down period of up to 30 minutes (if washer has not been manually turned off).
	Washer door is not completely closed.	Close door completely.
Washer won't spin.	Load is too small.	Add 1 or 2 similar items to help balance the load.
Residue left in drum.	Heavily soiled items.	Wipe drum with a nonabrasive household cleanser, then rinse. Shake or brush excess dirt and sand from items before washing

## SOLUTIONS TO COMMON PROBLEMS

### Service Prevention Checklist, continued

OCCURRENCE	POSSIBLE CAUSE	SOLUTION
<b>WATER</b>		
Water collects in folds of the bellows at the end of the cycle.	This is a result of the washing action and is part of the normal operation of the washer.	
Water collects in bleach and fabric softener compartments.	This is a result of the siphoning action and is part of the normal operation of the washer.	Water may be removed by removing the dispenser drawer (see Care and Cleaning in this guide) and draining water into the empty drum or sink.
Wash load too wet after spin.	Washer is overloaded.	Do not overload washer. See Operating Your Washer, step 4.
	Load is too small.	Add 1 or 2 similar items to help balance the load.
	Load is out of balance.	Rearrange load to allow proper spinning.
	Drain hose is kinked.	Straighten drain hose.
Water does not enter washer or it enters slowly.	Water supply is not adequate in area.	Check another faucet in the house. Wait until water supply and pressure increase.
	Water supply faucets are not completely open.	Fully open hot and cold faucets.
	Water is being used elsewhere in the house. Water pressure must be at least 30 psi (260 kPa).	Avoid running water elsewhere while washer is filling.
	Water inlet hoses are kinked.	Straighten hoses.
Warm or hot water is not hot enough.	Hot water heater is set too low or is a distance from washer.	Measure hot water temperature at nearby faucet with candy or meat thermometer. Water temperature should be at least 120°F (49°C). Adjust water heater as necessary.
	Hot water is being used elsewhere in the house.	Avoid using hot water elsewhere before or during washer use. There may not be enough hot water available for proper cleaning. If problem persists, your hot water system may be unable to support more than 1 use at a time.
Water in washer does not drain or drains slowly.	Drain hose is kinked or clogged.	Clean and straighten the drain hose.
	Drain hose standpipe is too tall. Maximum standpipe height is 8' (2.4 m).	Reduce standpipe height to less than 8' (2.4 m). See INSTALLATION INSTRUCTIONS.
	House drain pipes are clogged.	Unclog drain pipes. Contact plumber if necessary.
Water leaks.	Fill hose connection is loose at faucet or washer.	Check and tighten hose connections. Install rubber sealing washers provided.
Oversudsing.	Wrong detergent.	Run rinse cycle. Use a low-sudsing, high efficiency detergent.
	Too much detergent.	Run rinse cycle. Use less detergent in future loads.
Incorrect wash and rinse temperatures.	Hot and cold water hoses are connected to wrong supply faucets.	Connect hot water hose to hot water faucet and cold water hose to cold water faucet.
Water is entering washer but tub does not fill.	Drain hose standpipe is too low. Standpipe must be a minimum of 23.6" (60 cm) high to prevent siphoning.	Increase standpipe height to at least 23.6" (60 cm). See INSTALLATION INSTRUCTIONS.

# MAJOR APPLIANCE WARRANTY INFORMATION

For the applicable warranty period as set forth below, as measured from your original date of purchase, Electrolux will repair or replace any parts of this appliance that prove to be defective in materials or workmanship when such appliance is installed, used and maintained in accordance with the provided instructions.

## **Warranty Periods:**

- All parts — One year including labor
- Wash tub — Functional life of the product (excluding labor)
- Wash tub drive motor, non-cosmetic defects — Ten years (excluding labor)

## **Exclusions**

### **This warranty does not cover the following:**

1. Products with original serial numbers that have been removed, altered or cannot be readily determined.
2. Product that has been transferred from its original owner to another party or removed outside the USA or Canada.
3. Rust on the interior or exterior of the unit.
4. Products purchased "as-is" are not covered by this warranty.
5. Food loss due to any refrigerator or freezer failures.
6. Products used in a commercial setting.
7. Service calls which do not involve malfunction or defects in materials or workmanship, or for appliances not in ordinary household use or used other than in accordance with the provided instructions.
8. Service calls to correct the installation of your appliance or to instruct you how to use your appliance.
9. Expenses for making the appliance accessible for servicing, such as removal of trim, cupboards, shelves, etc., which are not a part of the appliance when it is shipped from the factory.
10. Service calls to repair or replace appliance light bulbs, air filters, water filters, other consumables, or knobs, handles, or other cosmetic parts.
11. Surcharges including, but not limited to, any after hour, weekend, or holiday service calls, tolls, ferry trip charges, or mileage expense for service calls to remote areas, including the state of Alaska.
12. Damages to the finish of appliance or home incurred during installation, including but not limited to floors, cabinets, walls, etc.
13. Damages caused by: services performed by unauthorized service companies; use of parts other than genuine Electrolux parts or parts obtained from persons other than authorized service companies; or external causes such as abuse, misuse, inadequate power supply, accidents, fires, or acts of God.

## **DISCLAIMER OF IMPLIED WARRANTIES; LIMITATION OF REMEDIES**

CUSTOMER'S SOLE AND EXCLUSIVE REMEDY UNDER THIS LIMITED WARRANTY SHALL BE PRODUCT REPAIR OR REPLACEMENT AS PROVIDED HEREIN. CLAIMS BASED ON IMPLIED WARRANTIES, INCLUDING WARRANTIES OF MERCHANTABILITY OR FITNESS FOR A PARTICULAR PURPOSE, ARE LIMITED TO ONE YEAR OR THE SHORTEST PERIOD ALLOWED BY LAW, BUT NOT LESS THAN ONE YEAR. ELECTROLUX SHALL NOT BE LIABLE FOR CONSEQUENTIAL OR INCIDENTAL DAMAGES SUCH AS PROPERTY DAMAGE AND INCIDENTAL EXPENSES RESULTING FROM ANY BREACH OF THIS WRITTEN LIMITED WARRANTY OR ANY IMPLIED WARRANTY. SOME STATES AND PROVINCES DO NOT ALLOW THE EXCLUSION OR LIMITATION OF INCIDENTAL OR CONSEQUENTIAL DAMAGES, OR LIMITATIONS ON THE DURATION OF IMPLIED WARRANTIES, SO THESE LIMITATIONS OR EXCLUSIONS MAY NOT APPLY TO YOU. THIS WRITTEN WARRANTY GIVES YOU SPECIFIC LEGAL RIGHTS. YOU MAY ALSO HAVE OTHER RIGHTS THAT VARY FROM STATE TO STATE.

## **IF YOU NEED SERVICE**

Keep your receipt, delivery slip, or some other appropriate payment record to establish the warranty period should service be required. If service is performed, it is in your best interest to obtain and keep all receipts. Service under this warranty must be obtained by contacting Electrolux at the addresses or phone numbers below.

This warranty only applies in the USA and Canada. In the USA, your appliance is warranted by Electrolux Major Appliances North America, a division of Electrolux Home Products, Inc. In Canada, your appliance is warranted by Electrolux Canada Corp. Electrolux authorizes no person to change or add to any obligations under this warranty. Obligations for service and parts under this warranty must be performed by Electrolux or an authorized service company. Product features or specifications as described or illustrated are subject to change without notice.

### **USA**

**1.800.944.9044**

Electrolux Major Appliances  
10200 David Taylor Drive  
Charlotte, NC 28262



**Electrolux**

### **Canada**

**1.800.265.8352**

Electrolux Canada Corp.  
5855 Terry Fox Way  
Mississauga, Ontario, Canada  
L5V 3E4

