

# FRIGIDAIRE

All about the

# Use & Care

of your

## TABLE OF CONTENTS

Welcome & Congratulations .....	2	Setting Oven Controls - Model A .....	15
Important Safety Instructions .....	3	Setting Oven Controls - Models B & C .....	17
Features at a Glance .....	6	Care & Cleaning (Cleaning Chart) .....	23
Surface Cooking .....	9	Care & Cleaning .....	24
Before Setting Surface Controls .....	11	Before You Call .....	29
Setting Surface Controls .....	13	Major Appliance Warranty .....	32
Before Setting Oven Controls .....	14		

# WELCOME & CONGRATULATIONS

## Product Registration Register Your Product

The **PRODUCT REGISTRATION CARD** should be filled in completely, signed and returned to Electrolux Home Products.

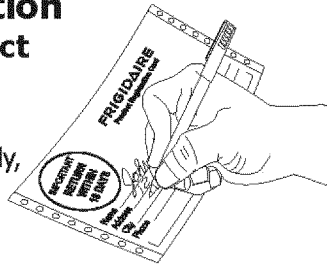

Congratulations on your purchase of a new appliance! At **Electrolux Home Products**, we are very proud of our product and are completely committed to providing you with the best service possible. Your satisfaction is our number one priority.

We know you'll enjoy your new appliance and **Thank You** for choosing our product. We hope you consider us for future purchases.

## PLEASE CAREFULLY READ AND SAVE THESE INSTRUCTIONS

This Use & Care Manual contains general operating instructions for your appliance and feature information for several models. Your product **may not** have all the described features. The graphics shown are representative. The graphics on your appliance may not look exactly like those shown. These instructions are not meant to cover every possible condition and situation that may occur. Common sense and caution must be practiced when installing, operating and maintaining any appliance.

## Serial Plate Location

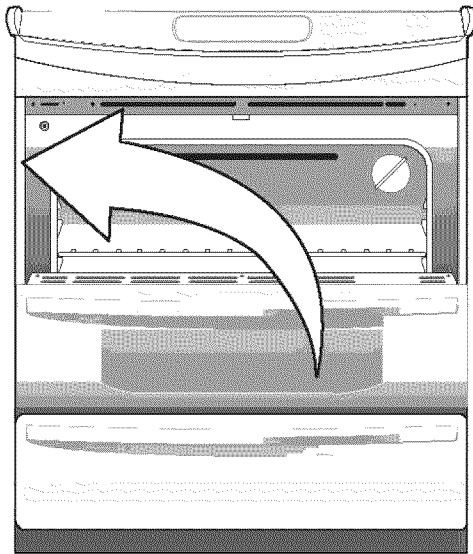

## NOTE

Please attach sales receipt here for future reference.

**Please record your model and serial numbers below for future reference.**

Model Number: \_\_\_\_\_

Serial Number: \_\_\_\_\_

Purchase Date: \_\_\_\_\_

# IMPORTANT SAFETY INSTRUCTIONS

Read all instructions before using this appliance.  
Save these instructions for future reference.

## DEFINITIONS

 This is the safety alert symbol. It is used to alert you to potential personal injury hazards. Obey all safety messages that follow this symbol to avoid possible injury or death.

### WARNING

This symbol will help alert you to situations that may cause serious bodily harm, death or property damage.

### CAUTION

This symbol will help alert you to situations that may cause bodily injury or property damage.

### IMPORTANT

IMPORTANT indicates installation, operation or maintenance information which is important but not hazard-related.

### WARNING



#### Tip Over Hazard

- A child or adult can tip the range and be killed.
- Verify the anti-tip device has been installed to floor or wall.
- Ensure the anti-tip device is re-engaged to floor or wall when the range is moved.
- Do not operate the range without the anti-tip device in place and engaged.
- Failure to follow these instructions can result in death or serious burns to children and adults.



Range  
Leveling  
Leg

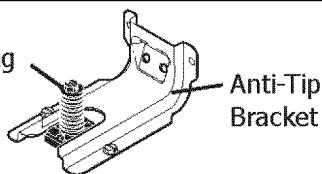

To check if the anti-tip bracket is installed properly, use both arms and grasp the rear edge of range back. Carefully attempt to tilt range forward. When properly installed, the range should not tilt forward.

Refer to the anti-tip bracket **installation instructions** supplied with your range for proper installation.

- **Remove all tape and packaging wrap before using the appliance. Destroy the carton and plastic bags after unpacking the appliance.** Never allow children to play with packaging material. Do not remove the wiring label and other literature attached to the appliance. Do not remove model/serial number plate.
- **Proper Installation. Be sure your appliance is properly installed and grounded by a qualified technician in accordance in the United States with the National Electrical Code ANSI/NFPA No. 70-latest edition, and local code requirements, and in Canada with CSA C22.1 PART 1-latest edition and local code requirements.** Install only per installation instructions provided in the literature package for this range.

Ask your dealer to recommend a qualified technician and an authorized repair service. Know how to disconnect the electrical power to the appliance at the circuit breaker or fuse box in case of an emergency.

- **User Servicing. Do not repair or replace any part of the appliance unless specifically recommended in the manuals.** All other servicing should be done only by a qualified technician to reduce the risk of personal injury and damage to the appliance.
- **Never modify or alter the construction of an appliance by removing leveling legs, panels, wire covers, anti-tip brackets/screws, or any other part of the product.**

### WARNING

**Stepping, leaning, sitting or pulling down on the door or the drawer of this appliance can result in serious injuries and also cause damage to the appliance.** Do not allow children to climb or play around the appliance. The weight of a child on an open door may cause the appliance to tip, resulting in serious burns or other injury. An open drawer when hot may cause burns.

### WARNING

**Do not use the oven or warm & serve drawer (if equipped) for storage.**

- **Storage in or on Appliance. Flammable materials should not be stored in an oven, near surface burners or in the warm & serve drawer (if equipped).** This includes paper, plastic and cloth items, such as cookbooks, plastic ware and towels, as well as flammable liquids. Do not store explosives, such as aerosol cans, on or near the appliance. Flammable materials may explode and result in fire or property damage.

# IMPORTANT SAFETY INSTRUCTIONS

## CAUTION

Do not store items of interest to children in the cabinets above the appliance. Children climbing on the cooktop to reach items could be seriously injured.

- **Do not leave children alone. Children should not be left alone or unattended in the area where an appliance is in use.** They should never be allowed to sit or stand on any part of the appliance.
- **DO NOT TOUCH SURFACE UNITS, AREAS NEAR THESE UNITS, OVEN HEATING ELEMENTS OR INTERIOR SURFACES OF THE OVEN.** Both surface units and oven heating elements may be hot even though they are dark in color. Areas near surface units may become hot enough to cause burns. During and after use, do not touch, or let clothing or other flammable materials touch these areas until they have had sufficient time to cool. Among these areas are the cooktop, surfaces facing the cooktop, the oven vent openings and surfaces near these openings, oven door and window.
- **Wear Proper Apparel. Loose-fitting or hanging garments should never be worn while using the appliance.** Do not let clothing or other flammable materials contact hot surfaces.

## WARNING

**NEVER use your appliance as a space heater to heat or warm the room.**

- **Do Not Use Water or Flour on Grease Fires. Smother the fire with a pan lid, or use baking soda, a dry chemical or foam-type extinguisher.**
- **When heating fat or grease, watch it closely.** Fat or grease may catch fire if allowed to become too hot.
- **Use Only Dry Pot holders. Moist or damp pot holders on hot surfaces may result in burns from steam.** Do not let the pot holders touch hot surface units. Do not use a towel or other bulky cloth instead of a pot holder.
- **Do Not Heat Unopened Food Containers. Buildup of pressure may cause the container to burst and result in injury.**
- **Remove the oven door from any unused appliance if it is to be stored or discarded.**

## IMPORTANT

**Do not attempt to operate the appliance during a power failure. If the power fails, always turn off the unit.** If the unit is not turned off and the power resumes, the appliance will not operate and an error message will be displayed. Once the power resumes, reset the clock and the oven function.

## CAUTION

**Electronic controllers can be damaged by cold temperatures. When you use your appliance for the first time, or if it has not been used for a long period of time, make sure that it has been exposed to a temperature above 0°C/32°F for at least 3 hours before connecting it to the power supply.**

## IMPORTANT INSTRUCTIONS FOR USING YOUR COOKTOP

- **Know which knob controls each surface heating unit.** Place pan of food on the element before turning it on, and turn the element off before removing the pan.
- **Use Proper Pan Size**—This appliance is equipped with one or more surface burners of different sizes. Select utensils having flat bottoms large enough to cover the surface unit. The use of undersized utensils will expose a portion of surface heating unit to direct contact and may result in ignition of clothing. Proper relationship of utensil to the surface will also improve efficiency.
- **Utensil Handles Should Be Turned Inward and Should Not Extend Over Adjacent Surface Units**—To reduce the risk of burns, ignition of flammable materials, and spillage due to unintentional contact with the utensil. The handle of the utensil should be positioned so that it is turned inward, and does not extend over adjacent surface unit.
- **Never Leave Surface Units Unattended**—Boilovers cause smoking and greasy spillovers that may ignite, or a pan that has boiled dry may melt.
- **Protective Liners**—Do not use aluminum foil to line oven bottom or any other part of the appliance. Only use aluminum as recommended for baking if used as a cover placed on the food. Any other use of protective liners or aluminum foil may result in a risk of electric shock or fire or a short circuit.
- **Glazed Cooking Utensils**—Only certain types of glass, glass/ceramic, ceramic, earthenware, or other glazed utensils are suitable for cooktop service without breaking due to the sudden change in temperature. Check the manufacturer's recommendations for cooktop use.

# IMPORTANT SAFETY INSTRUCTIONS

- **Do Not Use Decorative Surface Burner Covers.** If an element is accidentally turned on, the decorative cover will become hot and possibly melt. Burns will occur if the hot covers are touched. Damage may also be done to the cooktop.

## FOR COOKTOPS WITH COIL ELEMENTS ONLY

- Do Not Immerse or Soak Removable Surface Heating Elements. Surface heating elements should never be immerse in water. Heating elements clean themselves during normal operation.
- Make Sure Drip Pans or Drip Bowls Are in Place. Absence of these pans or bowls during cooking may subject wiring or components underneath to damage.

## FOR GLASS COOKTOP ONLY

- **Do Not Clean or Operate a Broken Cooktop**— If cooktop should break, cleaning solutions and spillovers may penetrate the broken cooktop and create a risk of electric shock. Contact a qualified technician immediately.
- **Clean Cooktop Glass with Caution**— If a wet sponge or cloth is used to wipe spills on a hot cooking area, be careful to avoid a steam burn. Some cleaners can produce harmful fumes if applied to a hot surface.
- **Avoid Scratching the Cooktop Glass with Sharp Objects.**

## IMPORTANT SAFETY INSTRUCTIONS FOR USING YOUR OVEN

- **Use Care When Opening Oven Door**—Stand to the side of the appliance when opening the door/drawer of a hot appliance. Let hot air or steam escape before you remove or replace food in the oven/drawer.
- **Keep Oven Vent Ducts Unobstructed.** The oven is vented at the front above the oven door. Touching the surfaces in this area when the oven is operating may cause severe burns. Also, do not place plastic or heat-sensitive items on or near the oven vent. These items could melt or ignite.

### **WARNING**

**NEVER cover any slots, holes or passages in the oven bottom or cover an entire rack with materials such as aluminum foil.** Doing so blocks air flow through the oven and may cause carbon monoxide poisoning. Aluminum foil linings may trap heat, causing a fire hazard.

- **Placement of Oven Racks.** Always place oven racks in desired location while appliance is cool. Remove all utensils from the rack before removing rack. If rack must be moved while oven is hot, use extreme caution.

Use pot holders and grasp the rack with both hands to reposition. Do not let pot holders contact the hot oven element or interior of the oven.

- **Do not use a broiler pan without its insert.** Broiler pan and grid allow dripping fat to drain and be kept away from the high heat of the broiler.
- **Do not cover the broiler grid or oven bottom with aluminum foil.** Exposed fat and grease could ignite.
- **Do not touch a hot oven light bulb with a damp cloth.** Doing so could cause the bulb to break. Disconnect the appliance or shut off the power to the appliance before removing and replacing the bulb.

## IMPORTANT SAFETY INSTRUCTIONS FOR CLEANING YOUR OVEN

- **Clean the appliance regularly to keep all parts free of grease that could catch fire.** Exhaust fan ventilation hoods and grease filters should be kept clean. Do not allow grease to accumulate. Greasy deposits in the fan could catch fire. Refer to the hood manufacturer's instructions for cleaning.
- **Cleaners/Aerosols**—Always follow the manufacturer's recommended directions for use. Be aware that excess residue from cleaners and aerosols may ignite causing damage and/or injury.

## FOR SELF-CLEANING OVEN

- **Clean in the self-cleaning cycle only the parts of the appliance listed in this Owner's Guide.** Before using the self-cleaning cycle of the appliance, remove all utensils stored in the appliance.
- **Do not clean the oven door gasket.** The door gasket is essential for a good seal. Care should be taken not to rub, damage or move the gasket.
- **Do not use oven cleaners.** No oven cleaner or oven liner protective coating of any kind should be used in or around any part of the appliance.
- **Remove oven racks.** Oven racks color will change if left in the oven during a self-cleaning cycle.

### **CAUTION**

The health of some birds is extremely sensitive to the fumes given off during the self-clean cycle of any wall oven. Move birds to another well ventilated room.

### **IMPORTANT SAFETY NOTICE**

The California Safe Drinking Water and Toxic Enforcement Act requires the Governor of California to publish a list of substances known to the state to cause cancer, birth defects or other reproductive harm, and requires businesses to warn customers of potential exposure to such substances.

# FEATURES AT A GLANCE - MODEL A

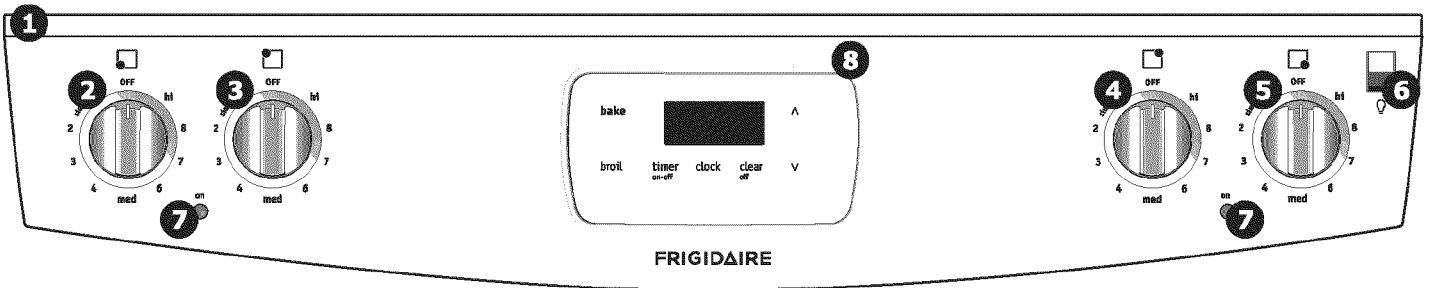

## Your built-in range Features:

1. Control Panel.
2. Left front element control.
3. Left rear element control.
4. Right rear element control.
5. Right front element control.
6. Oven light switch.
7. Element on indicator lights.
8. Electronic oven control with kitchen timer.
9. Automatic oven door light switch.
10. Broil element.
11. Manual clean oven interior.
12. Oven interior light with removable cover.
13. Adjustable interior oven rack(s).
14. Large 1-piece oven door handle.
15. Oven door with window.
16. Storage drawer with integrated handle (available with some models only).
17. 8" Coil element.
18. 6" Coil element.
19. 6" Coil element.
20. 8" Coil element.

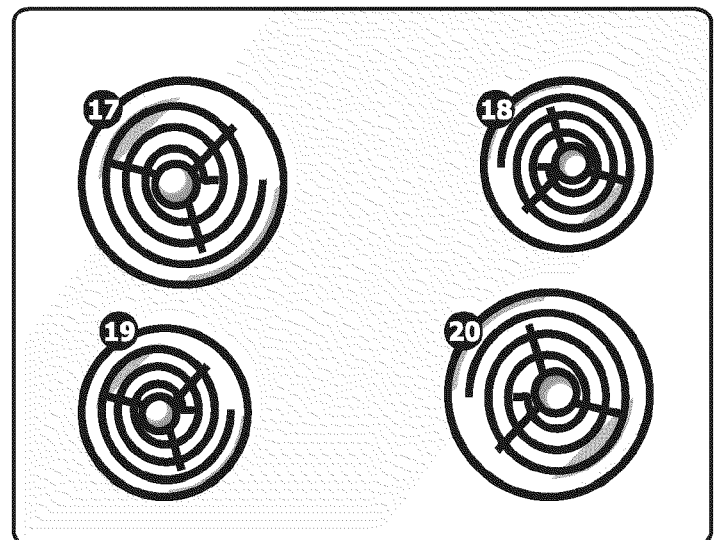
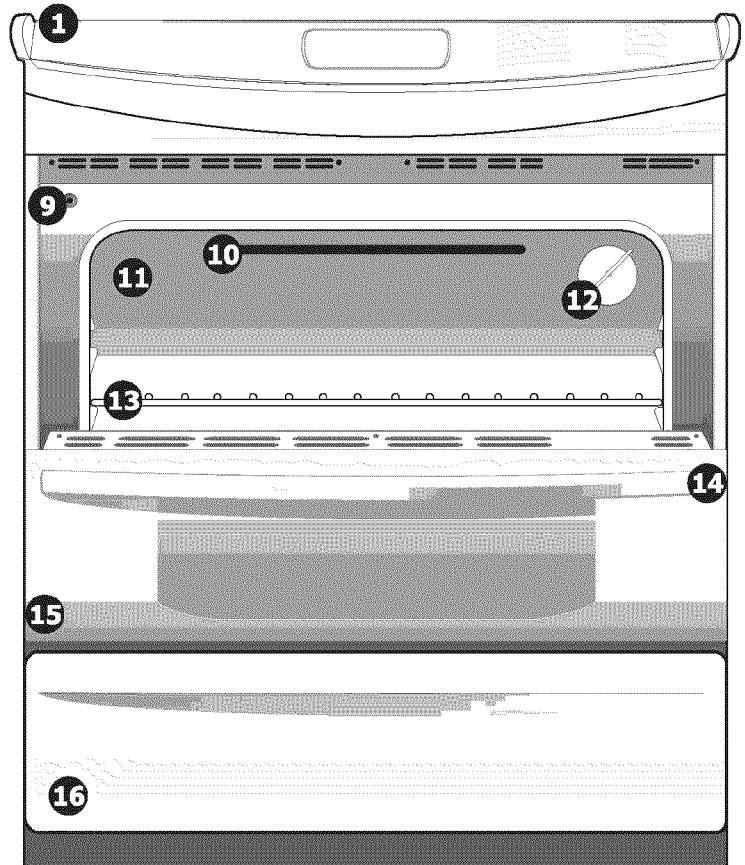

## NOTE

The features shown for your appliance may vary according to model type & color.

## FEATURES AT A GLANCE - MODEL B

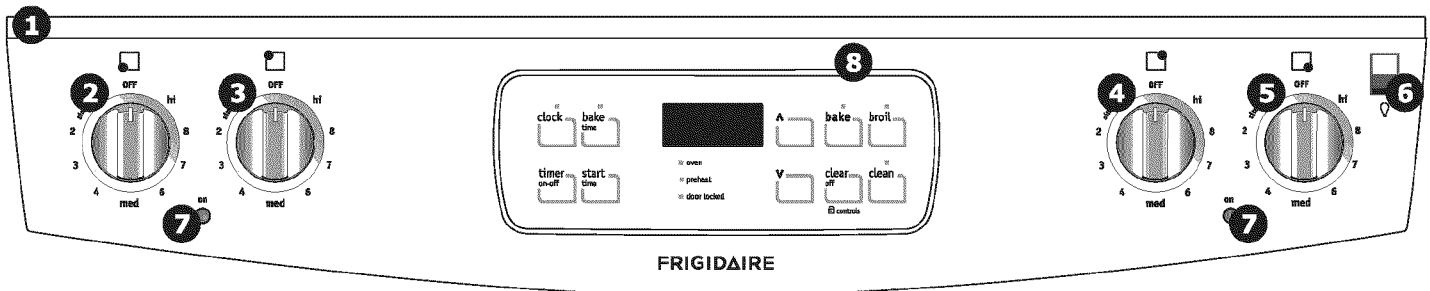

### Your built-in range Features:

1. Control Panel.
2. Left front element control.
3. Left rear element control.
4. Right rear element control.
5. Right front element control.
6. Oven light switch.
7. Element on indicator lights.
8. Electronic oven control with kitchen timer.
  
9. Automatic oven door light switch.
10. Self-clean door latch.
11. Broil element.
12. Self-cleaning oven interior.
13. Oven interior light with removable cover.
14. Adjustable interior oven rack(s).
15. Large 1-piece oven door handle.
16. Full width oven door with window.
17. Large 1-piece drawer handle (Stainless steel models with drawer only).
18. Storage drawer with integrated handle (Available with some models only).
  
19. 8" Coil element.
20. 6" Coil element.
21. 6" Coil element.
22. 8" Coil element.

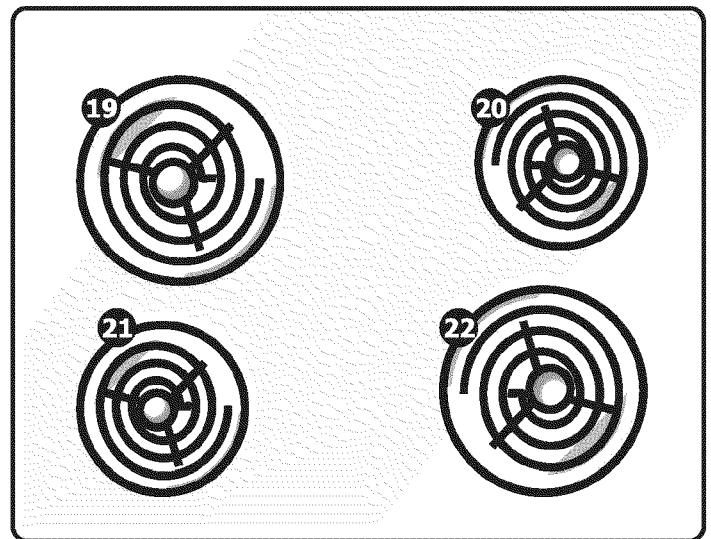
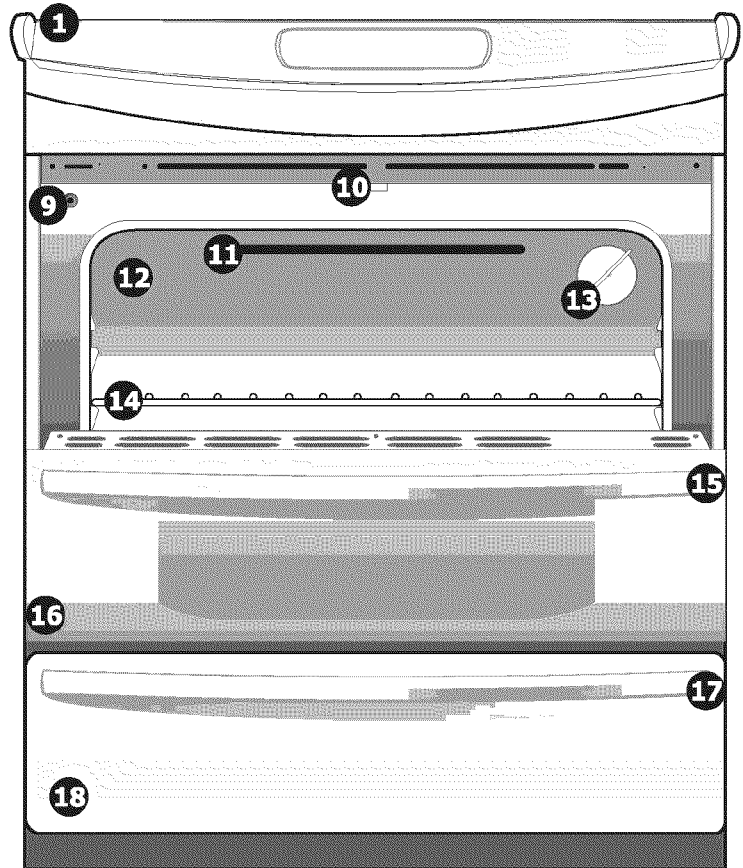

### NOTE

The features shown for your appliance may vary according to model type & color.

# FEATURES AT A GLANCE - MODEL C

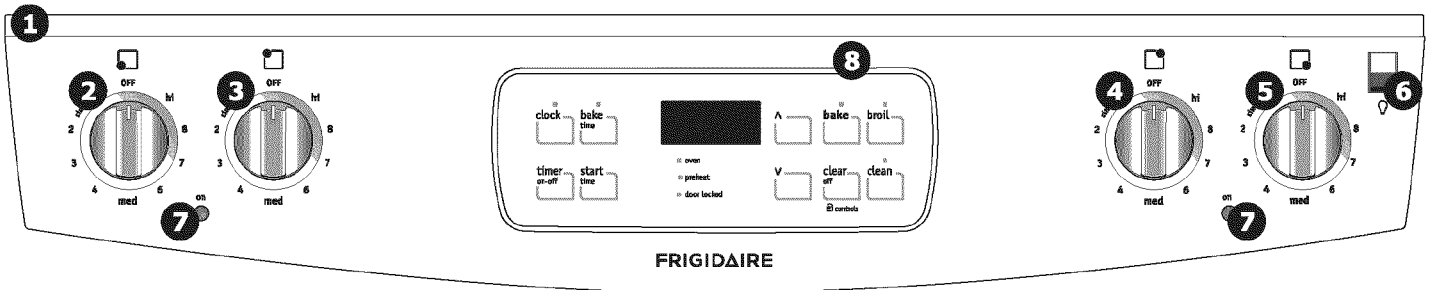

## Your built-in range Features:

1. Control Panel.
2. Left front element control.
3. Left rear element control.
4. Right rear element control.
5. Right front element control.
6. Oven light switch.
7. Element on indicator lights.
8. Electronic oven control with kitchen timer.
9. Automatic oven door light switch.
10. Self-clean door latch.
11. Broil element.
12. Self-cleaning oven interior.
13. Oven interior light with removable cover.
14. Adjustable interior oven rack(s).
15. Large 1-piece oven door handle.
16. Full width oven door with window.
17. Large 1-piece drawer handle (Stainless steel models with drawer only).
18. Storage drawer with integrated handle (Available with some models only).
19. Ceramic glass cooktop.
20. 7" single radiant element.
21. 6" single radiant element.
22. 9" single radiant element.
23. 12" single radiant element.
24. Hot surface indicator light

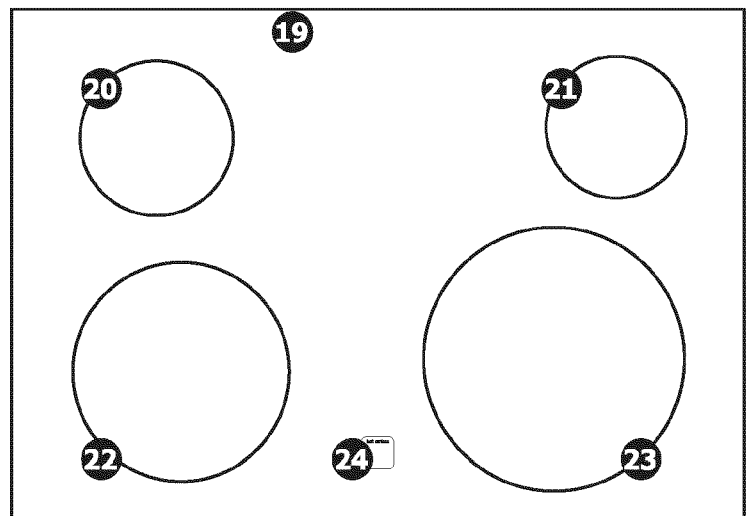
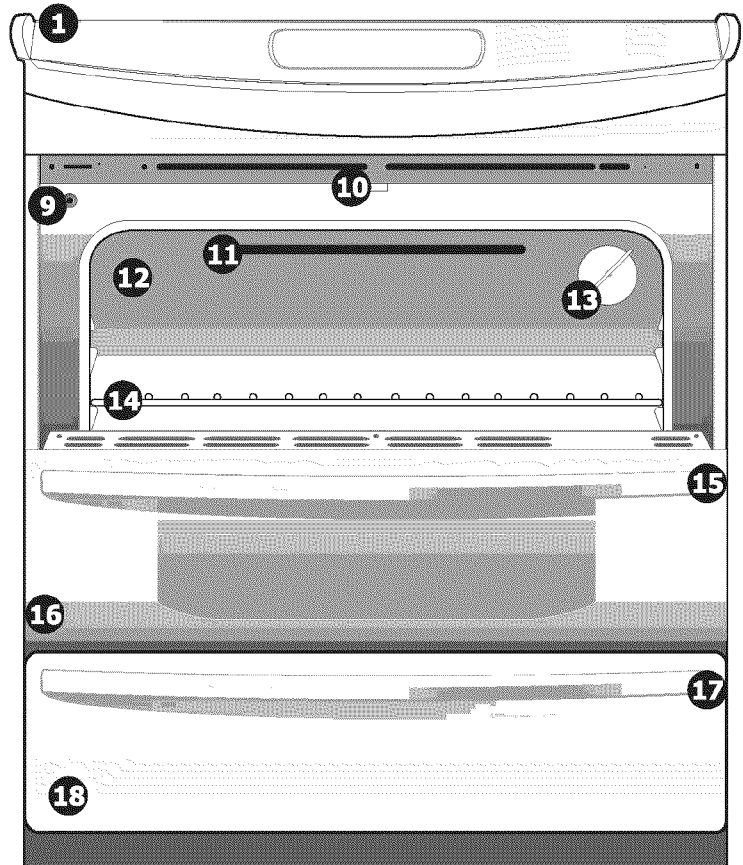

## NOTE

The features shown for your appliance may vary according to model type & color.



# SURFACE COOKING

## Selecting Surface Cooking Cookware

Cookware should have flat bottoms that make good contact with the entire surface heating element. Check for flatness by rotating a ruler across the bottom of the cookware (See Figure 1).

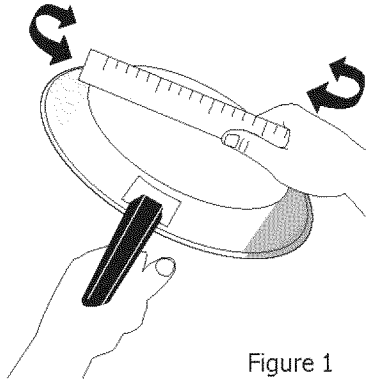
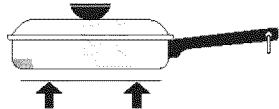

Figure 1

Be sure to follow the recommendations for using cookware as shown in Figure 2.

### CORRECT



- Flat bottom and straight sides.
- Tight fitting lids.
- Weight of handle does not tilt pan. Pan is well balanced.
- Pan sizes match the amount of food to be prepared and the size of the surface element.
- Made of material that conducts heat well.
- Easy to clean.
- Always match pot diameter to element surface diameter.

### INCORRECT

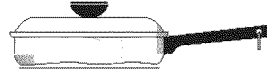

- Curved and warped pan bottoms.

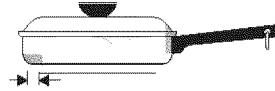

- Pan overhangs unit by more than one-half inch.

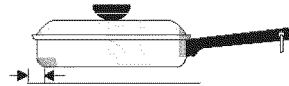

- Pan is smaller than the element.



- Heavy handle tilts the pan.

Figure 2

## NOTE

The size and type of cookware used will influence the setting needed for best cooking results.

## Cookware Material types

The cookware material determines how evenly and quickly heat is transferred from the surface element to the pan bottom. The most popular materials available are:

**ALUMINUM**- Excellent heat conductor. Some types of food will cause it to darken (Anodized aluminum cookware resists staining & pitting). If aluminum pans slide across the ceramic glass cooktop, they may leave metal marks which will resemble scratches. Remove these marks immediately.

**COPPER**- Excellent heat conductor but discolors easily. May leave metal marks on ceramic glass (see Aluminum above).

**STAINLESS STEEL**- Slow heat conductor with uneven cooking results. Is durable, easy to clean and resists staining.

**CAST IRON**- A poor heat conductor however will retain heat very well. Cooks evenly once cooking temperature is reached. Not recommended for use on ceramic cooktops.

**PORCELAIN-ENAMEL on METAL**- Heating characteristics will vary depending on base material. Porcelain-enamel coating must be smooth to avoid scratching ceramic cooktops.

**GLASS**- Slow heat conductor. Not recommended for ceramic cooktop surfaces because it may scratch the glass.

# SURFACE COOKING

## Specialty Pans & Trivets

**Woks** with flat bottoms suitable for use on your cooktop are available in most cookshop or hardware stores. Round-bottomed woks (with a support ring that does not extend beyond the heating element) may also be used. The metal ring was designed to support the wok safely when it is filled with large amounts of liquids (soup making) or fat (frying).

### CAUTION

**DO NOT** use two elements (if the cooktop is not equipped with bridge element) to heat one large pan such as a roaster or griddle, or allow cooking utensils to boil dry. The bottom surface of the pan in either of these situations could cause discoloring or crazing of the porcelain enamel range surface, and damage to the surface elements and/or damage to the drip pans (if equipped).

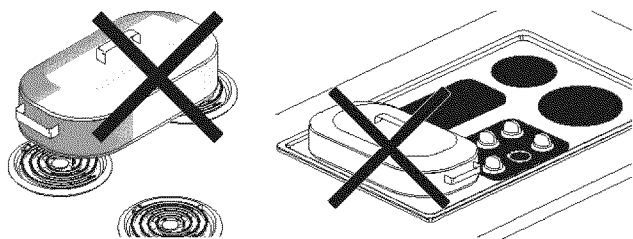

**Wire trivets:** Do not use wire trivets. Cookware bottoms must be in direct contact with the surface elements.

**DO NOT** use a wok if it is equipped with a metal ring that extends beyond the surface element. Because this ring traps heat, the surface element and cooktop surface could be damaged.

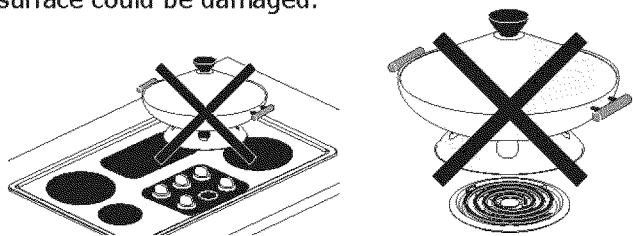

For glass smoothtop models, only flat bottomed woks (without support rings) may be used.

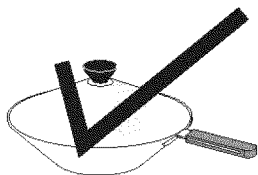

## Canning Tips & Information

1. Use tested recipes and follow instructions carefully. Check with your local Cooperative Agricultural Extension Service or a manufacturer of glass jars for the latest canning information.
2. Use flat-bottomed canners only. Heat is spread more evenly when the bottom surface is flat.
3. Center canner on the burner grate.
4. Start with hot water and a high heat setting to reduce the time it takes to bring the water to a boil; then reduce the heat setting as low as possible to maintain a constant boil.
5. It is best to can small amounts and light loads.

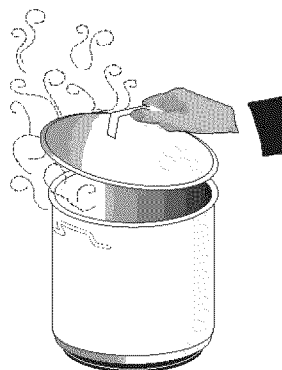

### CAUTION

Canning can generate large amounts of steam. Use extreme caution to prevent burns. Always raise the lid to vent steam away from you.

Prevent damage to cooktop and burner grates:

1. Do not use water bath or pressure canners that extend more than one inch beyond the edge of the burner grate.
2. Do not leave water bath or pressure canners on high heat for an extended amount of time.
3. Alternate surface units between each batch to allow the units and surrounding surfaces to cool down. Try to avoid canning on the same burner unit all day.

Safe canning requires that harmful micro-organisms are destroyed and the jars are sealed completely. When canning in a water bath canner, a gentle but steady boil must be maintained continuously for the required time.

# BEFORE SETTING SURFACE CONTROLS

## Ceramic Glass Cooktop (some models)

The ceramic cooktop has radiant surface elements located below the surface of the glass. The design of the ceramic cooktop outlines the area of the surface element underneath. **Make sure** the diameter of the pan matches the diameter of the element outline on the cooktop.

Heat is transferred up through the surface of the cooktop to the cookware. Only flat-bottom cookware should be used. The type and size of cookware, the number of surface elements in use and their settings are all factors that will affect the amount of heat that will spread to areas beyond the surface elements. The areas surrounding the elements may become **hot enough to cause burns**.

### CAUTION

The cooktop should not be used as a cutting board or work surface.

Dropping heavy or hard objects on the cooktop may crack it.

Pans with rough bottoms may scratch the cooktop surface.

Placing foods directly on the smoothtop surface (without cooking utensil) is not recommended as difficult cleaning will result and foods may smoke and cause a potential fire hazard.

Never use the griddle or similar cooking sheet on the ceramic glass cooktop.

### NOTE

Please read detailed instructions for ceramic glass cooktop cleaning in the **General Care & Cleaning** section and **Before You Call** checklist section of this Use and Care Guide.

### CAUTION

**Do not allow aluminum foil, or ANY material that can melt to make contact with the ceramic glass cooktop.** If these items melt on the cooktop they will damage the ceramic cooktop.

## About the Radiant Surface Elements

The element temperature rises gradually and evenly. As the temperature rises, the element will glow red. To maintain the selected setting, the element will cycle ON and OFF. The heating element retains enough heat to provide a uniform and consistent heat during the OFF cycle. For efficient cooking, turn OFF the element several minutes before cooking is complete. This will allow residual heat to complete the cooking process.

## Types of the heating elements used

Your cooktop is equipped with radiant surface radiant elements with different wattage ratings. The ability to heat food quicker and in larger volumes increases as the element wattage increases.

### NOTE

Due to the high intensity of heat generated by the surface elements, the glass surface will turn green when the element will be turned off. This phenomenon is normal and the glass will come back to its original white color after it has completely cooled down. (White glass cooktops only).

### NOTE

Radiant elements have a limiter that allows the element to cycle ON and OFF, even at the HI setting. This helps to prevent damage to the ceramic smooth top. Cycling at the HI setting is normal and can occur if the cookware is too small for the radiant element or if the cookware bottom is not flat.

Be sure to read detailed instructions for ceramic glass cooktop cleaning in the **General Care & Cleaning** section and **Before You Call** checklist section of this Use and Care Guide.

# BEFORE SETTING SURFACE CONTROLS

## Element ON (all models)

Your appliance is equipped with two different types of radiant surface control indicator lights that will glow on the backguard- the Element On indicator light and the hot surface indicator lights.

The **element ON** indicator lights are located on the control panel (Figure 1) between the two radiant element control knob and will glow when a surface element is turned ON.

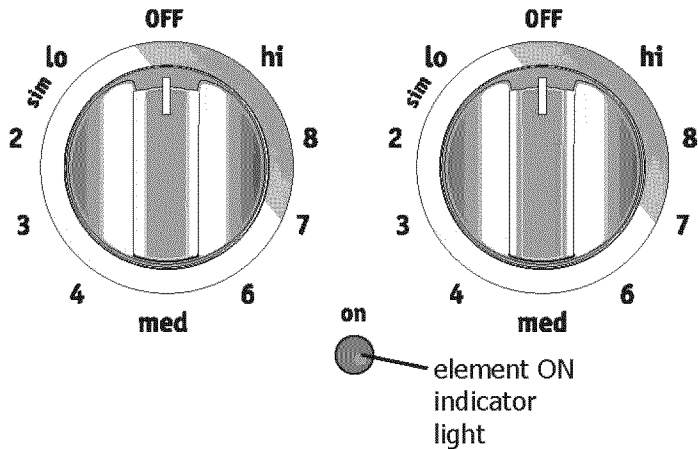

**Figure 1**  
Element ON indicator light location.

## Hot surface indicator light (Model C only)

The **hot surface** indicator light located on the cooktop (Figure 2) will glow when any surface cooking area heats up and will remain on until the glass cooktop has cooled to a MODERATE level.

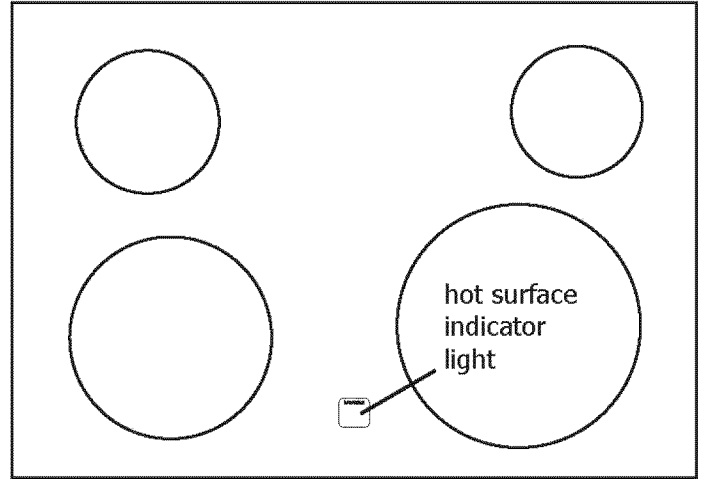

**Figure 2 - Model C only**  
Hot surface indicator light location.

## NOTE

The "Hot Surface" indicator lights will glow when the element is turned on and will continue to glow after the control knob is turned to the "OFF" position. It will glow until the heating surface area has cooled sufficiently.

**The glass surface may still be hot** and burns may occur if the glass surface is touched before the indicator light has turned OFF. The message may remain on even though the controls are turned OFF.

# SETTING SURFACE CONTROLS

## Surface cooking settings (All models)

Use the chart to determine the correct setting for the type of food you are preparing.

**Note:** The size and type of cookware used will influence the setting needed for best cooking results.

### Recommended Setting for Surface Element

Setting	Type of Cooking
HIGH (HI)	Start most foods; bring water to a boil and pan broiling.
MEDIUM HIGH (7-8)	Continue a rapid boil; frying, deep fat frying.
MEDIUM (4-6)	Maintain a slow boil; thicken sauces and gravies; steaming vegetables.
MEDIUM LOW (2 - 3)	Keep foods cooking; poaching and stewing.
LOW (LO)	Keep warm, melting and simmering.

## CAUTION

Do not place plastic items such as salt and pepper shakers, spoon holders or plastic wrappings on cooktop when it is in use. These items could melt or ignite. Potholders, towels or wooden spoons could catch fire if placed too close to the surface elements.

## Operating the Surface Elements

(All models)

### To Operate the Surface Elements

1. Place correctly sized cookware on the surface element.
2. Push in and turn the surface control knob in either direction to the desired setting (Figure 1).
3. Turn the knob to adjust the setting if desired. Start most cooking operations on a higher setting and then turn to a lower setting to finish cooking. Each surface element provides a constant amount of heat at each setting. **Ceramic Glass Cooktop Only:** A glowing red surface heating area extending beyond the bottom edge of the cookware indicates the cookware is **too small** for the surface heating area.
4. **When cooking has completed, turn the surface control knob to OFF before removing the cookware.**

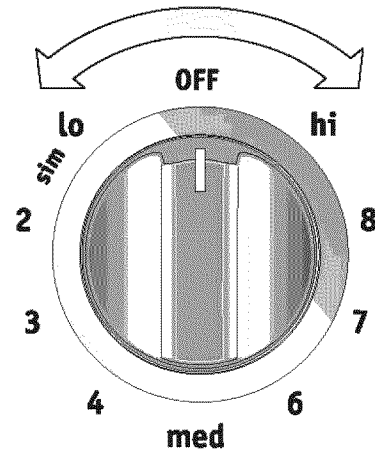

Figure 1 -Control knob shown is typical only.

## NOTE

See Recommended Setting for Surface Element table.

# BEFORE SETTING OVEN CONTROLS

## Oven Vent Location

On model A, the oven is vented **through the right rear coil element** (Figure 1) and on models B & C, the oven vent is located **through the upper front trim** and visible when the oven door is open (Figure 2). When the oven is on, warm air is released through the vent. This venting is necessary for proper air circulation in the oven and good baking results. **DO NOT** block the vent. Doing so may cause cooking failures, fire or damage to the appliance.

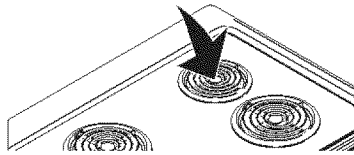

(Figure 1)

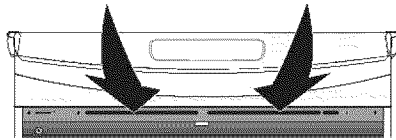

(Figure 2)

## CAUTION

Some models are equipped with a blower which runs in baking and self-cleaning mode to keep all internal components at a cool temperature. The blower may keep running even if the oven has been turned off, until the components have cooled down.

## Air circulation in the oven

If using 1 rack, place in center of oven. If using multiple racks, stagger cookware as shown.

For best air circulation and baking results allow 2-4" (5-10cm) around the cookware for proper air circulation and be sure pans and cookware do not touch each other, the oven door, sides or back of the oven cavity. The hot air must circulate around the pans and cookware in the oven for even heat to reach around the food.

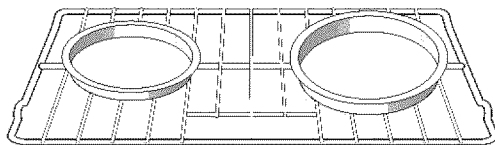

Single Oven Rack

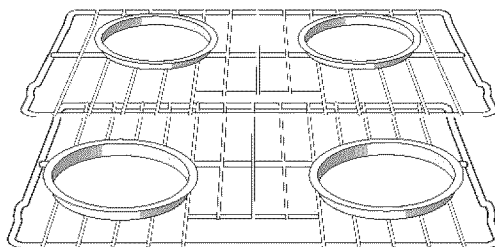

Multiple Oven Racks

## Arranging oven racks

**ALWAYS ARRANGE OVEN RACKS WHEN THE OVEN IS COOL (PRIOR TO OPERATING THE OVEN).** Always use oven mitts when using the oven.

**To remove an oven rack,** pull the rack forward until it stops. Lift up front of rack and slide out.

**To replace an oven rack,** fit the rack onto the guides on the oven walls. Tilt the front of the rack upward and slide the rack back into place.

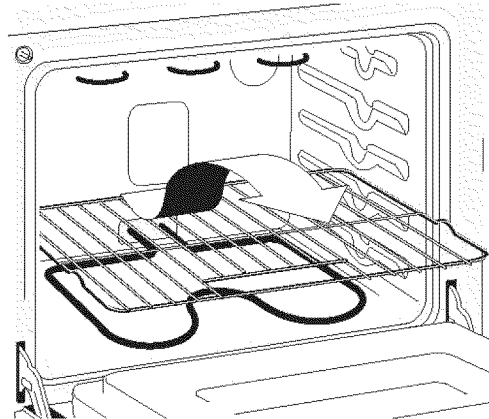

## Recommended rack positions

Food	Position
Broiling meats, chicken or fish	4
Cookies, cakes, pies, biscuits & muffins	
Using a single rack	2 or 3
Using two racks	2 and 4
Frozen pies, angel food cake, yeast, bread, 1 or 2 casseroles, small cuts of meat or poultry	1 or 2
Turkey, roast or ham	1

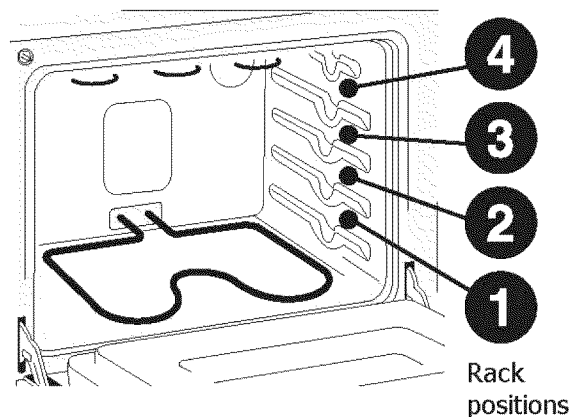

Rack positions

## NOTE

Always use caution when removing food from the oven.

# SETTING OVEN CONTROLS - MODEL A

## Control pad features

**READ THE INSTRUCTIONS CAREFULLY BEFORE USING THE OVEN.** For satisfactory use of your oven, become familiar with the various features and functions of the oven as described below. **Detailed instructions for each feature and function follow later in this Use & Care Guide.**

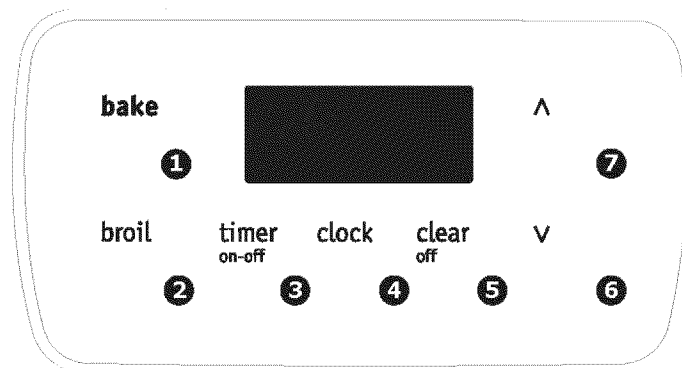

1. **Bake pad**—Use to select the bake cooking feature.
2. **Broil pad**—Use to select the broil cooking feature.
3. **Timer on-off pad**—Use to set or cancel the Timer. The Timer does not start or stop cooking.
4. **Clock pad**—Use to set the time of day.
5. **Clear off pad**—Use to cancel any oven feature previously entered except the time of day and minute timer.
6. **Down arrow pad**—Used along with the function pads to select oven temperature, time of day and minute timer.
7. **Up arrow pad**—Used along with the function pads to select oven temperature, time of day and minute timer.

## To Set the Clock

When the appliance is first plugged in, or when the power supply to the range has been interrupted, the display will flash "12:00".

1. Press **CLOCK** pad.
2. Within 4 seconds, press and hold the **UP** or **DOWN ARROW** pad until the correct time of day appears in the display.

## To Change the Temperature Display Mode

The electronic oven control temperature display mode was factory preset to display (Fahrenheit) °F oven temperatures. **Note:** Oven cooking temperatures may be set from 170°F to 500°F (76°C to 260°C).

### To change the Temperature Display Mode to °C (Celsius) or from °C to °F (do not use Bake or Broil while changing the Temperature Display Mode):

1. Press & hold the **BROIL** pad for 7 seconds until F or C appears in the display. **Note:** At this time the display will show the current Temperature Display Mode whether set for F or C.
2. Within 4 seconds, press the **UP** or **DOWN ARROW** pad once to toggle between the °F (Fahrenheit) and °C (Celsius).
3. To accept the change, wait 5 more seconds until the oven control beeps once. To complete the change skip step 4 below, OR;
4. If at any time during the process of changing the Temperature Display Mode (F or C) you decide the change is not desired, press the **CLEAR OFF** pad before the oven control beeps once to cancel the process.
5. The display will then return to the time of day with any temperature display mode change you may have requested.

## To Set the Minute Timer

1. Press **TIMER ON/OFF** pad.
2. Press the **UP ARROW** pad to increase the time in one minute increments. Press and hold the **UP ARROW** pad to increase the time faster. The timer can be set for any amount of time from 1 minute to 11 hours and 59 minutes. **Note:** If you press the **DOWN ARROW** pad first, the timer will advance to 11 hours and 59 minutes.
3. The display shows the timer count down in minutes until one minute remains. Then the display will count down in seconds.
4. When the set time has run out, the timer will sound a 3 seconds beep. 0:00 will appear in the display until **TIMER ON/OFF** pad is pressed.

**Note:** While the minute timer is counting down, the ":" will flash. The minute timer does not start or stop cooking. It serves as an extra timer in the kitchen that will beep when the set time has run out. The minute timer can be used alone or during any of the other oven functions. When the minute timer is in use with any other function, the minute timer will be shown in the display. To view other functions, press the pad for that function.

### To Change the Minute Timer while it is in use:

While the timer is active and shows in the display, press and hold the **UP** or **DOWN ARROW** pad to increase or decrease the time.

**To Cancel the Minute Timer before the set time has run out:** Press **TIMER ON/OFF**.

# SETTING OVEN CONTROLS - MODEL A

## To Set or Change the Temperature for Baking

The oven can be programmed to bake at any temperature from 170°F to 500°F (76°C to 260°C).

### To Set the Controls for Baking:

1. Press **BAKE** pad. "— — °" appears in the display.
2. Within 5 seconds, press the **UP** or **DOWN ARROW** pad. The display will show "350°F." By pressing and holding the **UP** or **DOWN ARROW** pad, the temperature can then be adjusted in 5°F increments.
3. When the **UP** or **DOWN ARROW** pad is released, the oven will begin heating to the selected temperature. When the displayed temperature reaches the desired baking temperature, the control will beep once (1 time).
4. To cancel the baking function, press **CLEAR OFF** pad.

### To Change the Oven Temperature after Baking has Started:

1. Press **BAKE** pad and make sure the bake temperature is displayed.
2. Press the **UP** or **DOWN ARROW** pad to increase or decrease the set temperature.

## To Broil

1. Arrange oven rack while oven is still cool.
2. Press **BROIL** pad.
3. Press and hold the **UP** or **DOWN ARROW** pad until the desired broil setting level appears in the display. Press the **UP ARROW** pad for HI broil or the **DOWN ARROW** pad for LO broil. Most foods can be broiled at the HI broil setting. Select the LO broil setting to avoid excess browning or drying of foods that should be broiled to the well-done stage.
4. Place the insert on the broiler pan, then place the food on the insert. DO NOT use the broiler pan without the insert or cover the insert with aluminum foil. The exposed grease could ignite.
5. Place the pan on the oven rack. Open the oven door to the broil stop position when broiling.
6. Broil on one side until food is browned; turn and cook on the second side. Note: Always pull the rack out to the stop position before turning or removing food.
7. When broiling is finished, press **CLEAR OFF** pad.



## CAUTION

**Should an oven fire occur, close the oven door and turn off the oven. If the fire continues, use a fire extinguisher. DO NOT put water or flour on the fire. Flour may be explosive.**

## Adjusting Your Oven Temperature

Your new oven has been factory calibrated and tested to ensure an accurate baking temperature. For the first few uses, follow your recipe times and temperature recommendations carefully. If you feel your oven is too hot or too cool from your baking experience, the oven temperature may be adjusted to your liking.

### NOTE

DO NOT adjust your oven temperature based on oven thermometers, such as those found in grocery stores, they may not be accurate.

### To Adjust the Oven Temperature (do not use Bake or Broil while adjusting the oven temperature):

**Note:** Your oven control was factory set in the (Fahrenheit) °F Temperature Display Mode. To change for (Celsius) °C, see page 15.

1. Press & hold the **BAKE** key pad and release after the display shows the factory temperature setting of 00.  
**Note:** If the oven temperature has been previously adjusted from the factory setting, the current temperature adjusted value will appear in the display instead.
2. You may increase the oven temperature in 5°F (1°C) increments with each press of the **UP ARROW** pad to a maximum oven adjustment of +35°F (+18°C). You may also adjust the oven temperature downward in 5°F (1°C) increments with each press of the **DOWN ARROW** pad (total range of -35°F to +35°F (-18°C to +18°C)).
3. If you do not want to keep the display adjustment, press the **CLEAR OFF** pad before the oven control beeps. This will cancel the temperature adjustment procedure. To start this procedure over again begin with step 1 above OR;
4. If you want to keep the adjustment, wait until the oven control beeps once.
5. The oven temperature adjustment has been accepted by the oven control and the display will return to the time of day.

## Failure Modes

All failure modes give a visual and audible alarm. When display shows F10 (temperature runaway), F30-F31 (oven sensor circuit fault) or any other F error codes, the electronic oven control has detected a fault condition. Note that code and push the **CLEAR OFF** pad to clean the display and stop the beeping. Reprogram the oven. If fault recurs, push **CLEAR OFF** pad, disconnect the appliance to prevent damage and contact an authorized servicer.



# SETTING OVEN CONTROLS - MODELS B & C

## Control pad features

**READ THE INSTRUCTIONS CAREFULLY BEFORE USING THE OVEN.** For satisfactory use of your oven, become familiar with the various features and functions of the oven as described below. **Detailed instructions for each feature and function follow later in this Use & Care Guide.**

### NOTE

The oven function will not work if the time of day clock is not set.

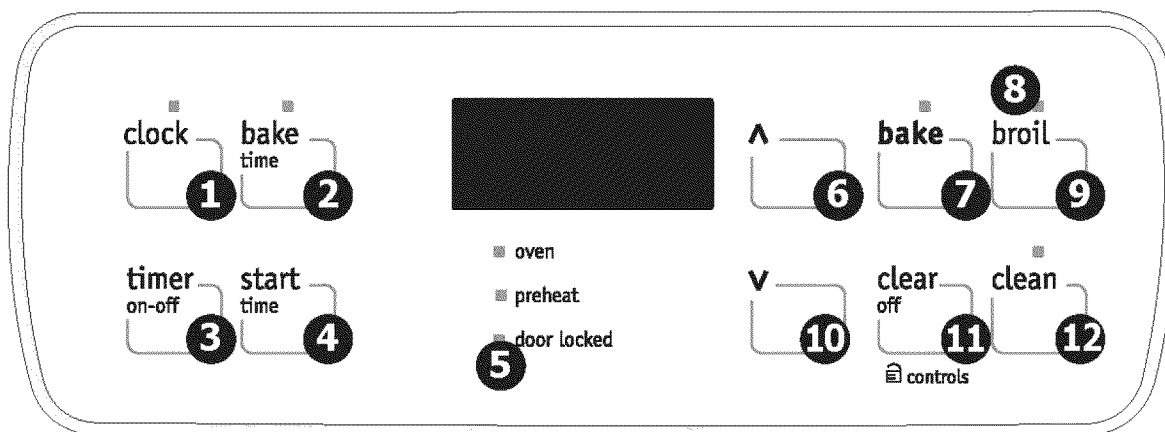

- 1. Clock pad**—Use to set the time of day.
- 2. Bake time pad**—Use to enter the length of the baking time.
- 3. Timer on-off pad**—Use to set or cancel the Timer. The Timer does not start or stop cooking.
- 4. Start time pad**—Used to set the desired start time for baking. Can be used with BAKE TIME to program a delayed bake cycle.
- 5. Oven, preheat & door locked lights**— The "oven" light will glow each time the oven unit turns on maintain the set oven temperature. The "Preheat" light will glow when the oven is first set to operate, or if the desired temperature is reset higher than the actual oven temperature. The "Door Locked" light will

flash until the door locks when the self-clean cycle is in use. It glows constantly after the door locks.

- 6. Up arrow pad**—Used along with the function pads to select oven temperature, time of day and minute timer.
- 7. Bake pad**—Use to select the bake cooking feature.
- 8. Feature indicator lights**—These light to show which feature is in use.
- 9. Broil pad**—Use to select the broil cooking feature.
- 10. Down arrow pad**—Used along with the function pads to select oven temperature, time of day and minute timer.
- 11. Clear off pad**—Use to cancel any oven feature previously entered except the time of day and minute timer.
- 12. Clean Pad**—Used to select the self-cleaning cycle.

## The oven can be programmed to

Bake normally, Time Bake, Delayed Bake, Broil, Self-Clean

**Note:** Push buttons or pads may be shaped differently.

## For a silent control panel

When choosing a function, a beep will be heard each time a pad is pushed. If desired, the controls can be programmed for silent operation. Push and hold **START TIME** pad. After 7 seconds, the control will beep once. This will block the controls from sounding when a pad is pushed. To return the sound, push and hold **START TIME** pad again for 7 seconds until 1 beep is heard.

## Temperature Conversion (Fahrenheit/Celsius)

The electronic oven control is set to operate in °F (Fahrenheit) when shipped from the factory. The oven can be programmed for any temperature from 170°F to 550°F (77°C to 287°C).

**To change the temperature to °C (Celsius) or from °C to °F (control should not be in a Bake or Clean mode):**

1. Push **BROIL** pad. "- - -" appears in the display.
2. Push and hold the **UP ARROW** pad until "HI" appears in the display.
3. Push and hold **BROIL** pad until °F or °C appears in the display.
4. Push **UP** or **DOWN ARROW** pad to change °F to °C or °C to °F.
5. To accept the change, wait 6 seconds.

## SETTING OVEN CONTROLS - MODELS B & C

### NOTE

The oven function will not work if the time of day clock is not set.

#### To Set the Clock

When the range is first plugged in, or when the power supply to the appliance has been interrupted, the display will flash "12:00".

1. Push **CLOCK** pad.
2. Within 5 seconds, push and hold the **UP** or **DOWN ARROW** pad until the correct time of day appears in the display.  
**Note:** The clock cannot be changed during any timed bake or self-clean cycle.

#### To Set the Minute Timer

1. Push **TIMER ON/OFF** pad.
2. Push the **UP ARROW** pad to increase the time in one minute increments. Push and hold the **UP ARROW** pad to increase the time in 10 minute increments. The timer can be set for any amount of time from 1 minute to 11 hours and 59 minutes.  
**Note:** If you push the **DOWN ARROW** pad first, the timer will advance to 11 hours and 59 minutes.
3. The display shows the timer count down in minutes until one minute remains. The display will count down in seconds.
4. When the set time has run out, the timer will beep 3 times. It will continue to beep 3 times every 60 seconds until the **TIMER ON/OFF** pad is pushed.

### NOTE

The minute timer does not start or stop cooking. It serves as an extra timer in the kitchen that will beep when the set time has run out. The minute timer can be used alone or during any of the other oven functions. When the minute timer is in use with any other mode, the minute timer will be shown in the display. To view other functions, push the function pad for that mode.

#### To Change the Minute Timer while it is in use:

While the timer is active and shows in the display, push and hold the **UP** or **DOWN ARROW** pad to increase or decrease the time.

**To Cancel the Minute Timer before the set time has run out:** Push **TIMER ON/OFF** pad.

### NOTE

To turn the time of day display OFF or ON in the display press and hold the **CLOCK** pad for 8 seconds (the control will beep once) and then release. This feature does not remove the set time of day from the memory of the control. When the display is turned OFF the time of day will reappear for a few seconds any time the **CLOCK** pad is touched.

#### To Set Control for Continuous Bake or 12 Hour Energy Saving

The oven control has a built-in 12 Hour Energy Saving feature that will shut off the oven if the control is left on for more than 11 hours and 59 minutes. The oven can be programmed to override this feature for continuous baking.

##### To set control for continuous baking:

1. Push and hold **TIMER ON/OFF** pad down for 5 seconds until tone is heard, "— — hr" will appear in display for continuous cooking. The current time of day will return to the display.
2. To cancel the Continuous Bake Function, push **TIMER ON/OFF** pad and hold for 5 seconds until tone is heard. "12hr" will appear in display indicating that the control has returned to the 12 Hour Energy Saving feature.

#### To Set Control for Oven Lockout

The control can be programmed to lock the oven door and inactivate the oven controls.

##### To Set Control for Oven Lockout feature:

1. Push the **CLEAR OFF** pad and hold for 3 seconds. "Loc" will appear in display, the "Door Locked" indicator light will flash and the motor driven door lock will begin to close automatically. DO NOT open oven door while the indicator light is flashing. Allow about 15 seconds for the oven door to lock. Once the oven door is locked, the current time of day will appear in the display.
2. To cancel the lockout feature, push **CLEAR OFF** pad and hold for 3 seconds. The control will unlock the oven door and resume normal operation.

### NOTE

If a control pad is pressed while the Oven Door/Control Lockout mode, "Loc" will appear in the display until the control pad is released. But it does not disable the clock, kitchen timer and the interior oven lights.

# SETTING OVEN CONTROLS - MODELS B & C

## To Set or Change the Temperature for Normal Baking

The oven can be programmed to bake at any temperature from 170°F to 550°F (77°C to 287°C).

### NOTE

The oven control has a built-in energy saving feature that will shut off the oven if the control is left on for more than 11 hours 59 minutes.

### To Set the Controls for Normal Baking:

1. Push **BAKE** pad. "— — —" appears in the display.
2. Within 5 seconds, push the **UP** or **DOWN ARROW** pad. The display will show "350°F (177°C)." By holding the **UP** or **DOWN ARROW** pad, the temperature can then be adjusted in 5°F (1°C) increments.
3. As soon as the **UP** or **DOWN ARROW** pad is released, the oven will begin heating to the selected temperature. When the oven temperature reaches the desired baking temperature, the control will beep 3 times and the Preheat light will turn off.
4. To cancel the baking function, push the **CLEAR OFF** pad.

### To Change the Oven Temperature after Baking has started:

1. If you are using the minute timer, push the **BAKE** pad and make sure the bake temperature is displayed.
2. Push the **UP** or **DOWN ARROW** pad to increase or decrease the set temperature.

## Setting Broil

This mode is best for meats, fish and poultry up to 1" thick. Broiling is a method of cooking tender cuts of meat by direct heat under the broil element of the oven. The high heat cooks quickly and gives a rich, brown outer appearance. The **BROIL** pad controls the Broil feature. An optional Searing Grill, Broiler Pan and Insert are available via the enclosed accessories brochure (Figure 1 & 2). The optional broil pan and broil pan insert used together allow dripping grease to drain and be kept away from the high heat of the oven broiler.

### Broiling Tips:

- For optimum browning, preheat the broil element for 5 minutes.
- Broil one side until the food is browned; turn and cook on the second side. Season and serve.
- Always pull the rack out to the "stop" position before turning or removing food.
- Always use the broiler pan and its cover when broiling. It allows the dripping grease to be kept away from the high heat of the broil element (see Figure 1).
- For best broiling results, broil with the oven door in the broil stop position (see Figure 3).
- If using a Searing Grill (available by mail order), preheat the grill for 5 to 10 minutes before placing your meat.

- **DO NOT** use the broil pan without the insert. **DO NOT cover the broil pan insert with foil.** The exposed grease could catch fire.

Accessories available via the enclosed brochure:

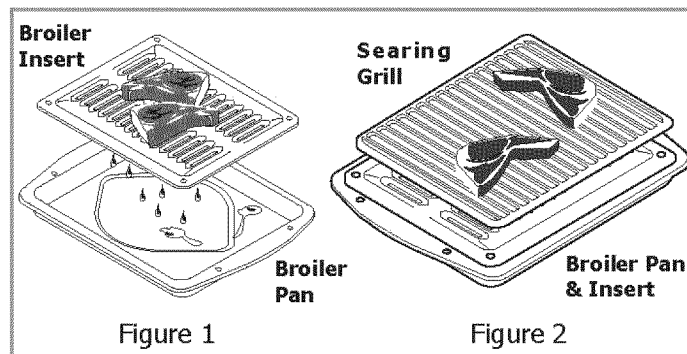

### To set the Broil:

1. Arrange oven rack while oven is still cool.
2. Push the **BROIL** pad.
3. Push and hold the **UP** or **DOWN ARROW** pad until the desired broil setting level appears in the display. Push **UP ARROW** pad for HI broil or the **DOWN ARROW** pad for LO broil. Most foods can be broiled at the HI broil setting. Select the LO broil setting to avoid excess browning or drying of foods that should be cooked to the well-done stage.
4. Place grid on the broiler pan, then place the food on the grid. **DO NOT** use the broiler pan without the grid or cover the grid with aluminum foil. The exposed fat could ignite.
5. Place the pan on the oven rack. Open the oven door to the broil stop position when broiling (Figure 3).
6. Broil on one side until food is browned; turn and cook on the second side. **Note:** Always pull the rack out to stop position before turning or removing food.
7. When broiling is finished, push the **CLEAR OFF** pad.

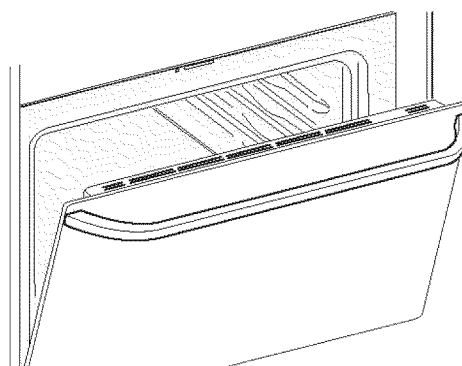

Broil Stop Position  
Figure 3

### CAUTION

Should an oven fire occur, close the oven door and turn off the oven. If the fire continues, use a fire extinguisher. **DO NOT** put water or flour on the fire. Flour may be explosive.

## SETTING OVEN CONTROLS - MODELS B & C

### To Set the Bake Time Feature

The **BAKE TIME** and **START TIME** controls operate the Timed Bake Feature. The automatic timer will turn the oven on and off at the times you select in advance. The oven can be programmed to start immediately and shut off automatically or to begin baking at a later time with an automatic shut off.

#### To Program the Oven to Begin Baking Immediately and To Shut Off Automatically:

1. Be sure that the clock shows the correct time of day.
2. Place the food in the oven and push the **BAKE** pad.
3. Within 5 seconds, push the **UP** or **DOWN ARROW** pad. The display will show "350°F (177°C)." By holding the **UP** or **DOWN ARROW** pad, the temperature can then be adjusted in 5°F (1°C) increments.
4. Push the **BAKE TIME** pad. "0:00" will flash in the display.
5. Push the **UP** or **DOWN ARROW** pad until the desired amount of baking time appears in the display.

#### To Program Oven for a Delayed Start Time and to Shut-Off Automatically:

1. Be sure that the clock shows the correct time of day.
2. Place the food in the oven and push the **BAKE** pad.
3. Within 5 seconds, push the **UP** or **DOWN ARROW** pad. The display will show "350°F (177°C)." By holding the **UP** or **DOWN ARROW** pad, the temperature can then be adjusted in 5°F (1°C) increments.
4. Push the **BAKE TIME** pad. "0:00" will flash in the display.
5. Push the **UP** or **DOWN ARROW** pad until the desired amount of baking time appears.
6. Push the **START TIME** pad.
7. Push the **UP** or **DOWN ARROW** pad until the desired start time appears in the display.
8. Once the controls are set, the control calculates when baking will stop.

#### Once the Controls are Set:

1. The oven will come on and begin heating to the selected baking temperature.
2. The oven temperature (or time of day) will show in the display.

#### When the Set Bake Time Runs Out:

1. "END" will appear in the display window and the oven will shut off automatically.
2. The control will beep 3 times every 60 seconds until the **CLEAR OFF** pad is pushed.

#### To Change the Oven Temperature or Bake Time after Baking has started:

1. Push the function pad you want to change.
2. Push the **UP** or **DOWN ARROW** pad to adjust the setting.

### CAUTION

Use caution when using the automatic timer. Use the automatic timer when cooking cured or frozen meats and most fruits and vegetables. Foods that can easily spoil such as milk, eggs, fish, meat or poultry, should be chilled in the refrigerator first. Even when chilled, they should not stand in the oven for more than 1 hour before cooking begins, and should be removed promptly when cooking is completed.

### Recalibrating Your Oven Temperature

#### Recalibrating Your Oven Temperature

The temperature in the oven has been set at the factory. When first using the oven, be sure to follow recipe times and temperatures. If you think the oven is too hot or too cool, the temperature in the oven can be adjusted. Before adjusting, test a recipe by using a temperature setting that is higher or lower than recommended temperature. The baking results should help you to decide how much of an adjustment is needed.

#### To Adjust Oven Temperature:

1. Push the **BAKE** pad.
2. Set the temperature to 550°F (287°C) by pushing and holding the **UP ARROW** pad.
3. Within 2 seconds, push and hold the **BAKE** pad until the special 2 digit display appears. Release the **BAKE** pad. The display now indicates the amount of degrees offset between the original factory temperature setting and the current temperature setting. If the oven control has the original factory calibration, the display will read "00."
4. The temperature can now be adjusted up or down 35°F (17°C), in 5°F (1°C) steps by pushing and holding the **UP** or **DOWN ARROW** pad. Adjust until the desired amount of degrees offset appears in the display. When lowering the oven temperature, a minus sign (-) will appear before the number to indicate that the oven will be cooler by the displayed amount of degrees.
5. When you have made the desired adjustment, push the **CLEAR OFF** pad to go back to the time of day display.

### NOTE

The adjustment made will not change the self-cleaning temperature.

# SETTING OVEN CONTROLS - MODELS B & C

## Self-cleaning

A self-cleaning oven cleans itself with high temperatures (well above normal cooking temperatures) which eliminate soils completely or reduces them to a fine powdered ash you can wipe away with a damp cloth.

### IMPORTANT

Adhere to the following cleaning precautions:

- **DO NOT** use oven cleaners or oven protective coatings in or around any part of the oven interior.
- **DO NOT** clean the oven door gasket. The woven material of the oven door gasket is essential for a good seal. Care should be taken not to rub, damage or remove the gasket.
- **DO NOT** use any cleaning materials on the oven door gasket. Doing so could cause damage.
- **Remove the broiler pan and insert, all utensils and ANY ALUMINUM FOIL.** These items cannot withstand high cleaning temperatures and will melt.
- **Completely remove ALL OVEN RACKS and ANY ACCESSORIES.** If the oven racks are not removed, they will lose their special coating properties and will no longer slide in and out of the oven cavity effortlessly.
- **Remove any excessive spillovers** in the oven cavity **before** starting the Self-Cleaning cycle. To clean, use hot, soapy water and a cloth. Large spillovers can cause heavy smoke or fire when subjected to high temperatures. **DO NOT** allow food spills with a high sugar or acid content (such as milk, tomatoes, sauerkraut, fruit juices or pie filling) to remain on the surface as they may leave a dull spot even after cleaning.
- Clean any soil from the oven frame, the door liner outside the oven door gasket and the small area at the front center of the oven bottom. These areas heat sufficiently to burn soil on. Clean with soap and water.

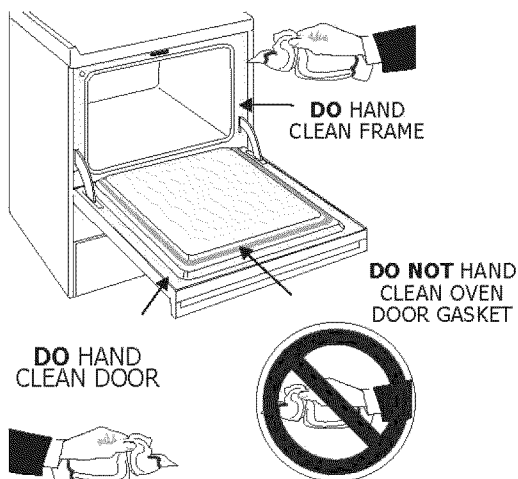

## What to Expect during Cleaning

While the oven is in operation, the oven heats to temperatures much higher than those used in normal cooking. Sounds of metal expansion and contraction are normal. Odor is also normal as the food soil is being removed. Smoke may appear through the oven vent.

If heavy spillovers are not wiped up before cleaning, they may flame and cause more smoke and odor than usual. This is normal and safe and should not cause alarm. If available, use an exhaust fan during the self-cleaning cycle.

### CAUTION

To avoid possible burns use care when opening the oven door after the Self-Cleaning cycle. Stand to the side of the oven when opening the door to allow hot air or steam to escape.

During the Self-Cleaning cycle, the outside of the range can become very hot to the touch. **DO NOT** leave small children unattended near the appliance.

The health of some birds is extremely sensitive to the fumes given off during the Self-Cleaning cycle of any range. Move birds to another well-ventilated room.

**DO NOT** line the oven walls, racks, bottom or any other part of the range with **aluminum foil**. Doing so will destroy heat distribution, produce poor baking results and cause permanent damage to the oven interior (aluminum foil will melt to the interior surface of the oven).

**DO NOT** force the oven door open. This can damage the automatic door locking system. Use caution when opening the door after the Self-Cleaning cycle is completed. The oven may still be VERY HOT.

### NOTE

See additional cleaning information for the oven door in the **General Care & Cleaning** section.

# SETTING OVEN CONTROLS - MODELS B & C

## Self-cleaning

### To Start the Self-Clean Cycle

\*We recommend a 2 hour self-clean cycle for light soils, and a 3 hour cycle for average to heavy soils (to assure satisfactory results).

### To Set the Controls for a Self-Clean Cycle:

1. Be sure the clock shows the correct time of day.
2. Push the **CLEAN** pad. "--" appears in the display.
3. Push the **UP ARROW** pad until "3:00" appears in the display for a 3 hour cycle, or push the **DOWN ARROW** pad until "2:00" appears in the display for a 2 hour cycle.
4. As soon as the **UP** or **DOWN ARROW** pad is released, "CLn" appears in the display.
5. As soon as the controls are set, the motor driven lock will begin to close automatically and the "Door Locked" indicator light will flash. DO NOT open the door while the light is flashing (it takes about 15 seconds for the lock to close).
6. The "Door Locked" light will glow until the cleaning cycle is completed or cancelled, and the oven temperature has cooled.

### When the Self-Clean Cycle is Completed:

1. The time of day will appear in the display window and the "Door Locked" light will continue to glow.
2. Once the oven has cooled down for about 1 hour and the "Door Locked" light has gone out, the oven door can be opened.

### Stopping or Interrupting a Self-Cleaning Cycle

**If it becomes necessary to stop or interrupt a self-cleaning cycle due to excessive smoke or fire:**

1. Push the **CLEAR OFF** pad.
2. Once the oven has cooled down for about 1 hour and the "Door Locked" light has gone out, the oven door can be opened.
3. Correct the condition which caused the smoking.
4. Restart the self-clean cycle once all conditions have been corrected.

## CAUTION

Use care when opening the oven door after self-cleaning cycle. Stand to the side of the oven when opening the door to allow hot air or steam to escape.

DO NOT force the oven door open. This can damage the automatic door locking system. Use caution when opening the door after the self-cleaning cycle is completed. The oven may still be VERY HOT.

## FAILURE MODES

All failure modes give a visual and audible alarm. When display shows F10 (temperature runaway), F30 (oven sensor circuit fault) or F90 (motor door lock fault), the electronic oven control has detected a fault condition. Note that code and push the **CLEAR OFF** pad to clean the display and stop the beeping. Reprogram the oven. If fault recurs, push **CLEAR OFF** pad, disconnect the appliance to prevent damage and contact an authorized servicer.

# CARE & CLEANING (Cleaning Chart)

## Cleaning various parts of your appliance

Before cleaning any part of the appliance, be sure all controls are turned off and the appliance is COOL. REMOVE SPILLOVERS AND HEAVY SOILING AS SOON AS POSSIBLE. REGULAR CLEANING WILL REDUCE THE NUMBER OF MAJOR CLEANING LATER.

### Surfaces

Aluminum (trim pieces) & Vinyl

### How to Clean

Use hot, soapy water and a cloth. Dry with a clean cloth.

Glass, Painted and Plastic Body Parts, Control Knobs & Decorative Trim Pieces

Using a soft cloth, clean with mild dish detergent and water or a 50/50 solution of vinegar and water. Follow by rinsing the area with clean water; dry and polish with a soft cloth. Glass cleaners may be used if sprayed on a soft cloth first. DO NOT spray liquids directly on the control pad and display area. Do not use large amounts of water on the control panel - excess water on the control area may cause damage to the appliance. Do not use other liquid cleaners, abrasive cleaners, scouring pads, or paper towels - they will damage the finish. To remove control knobs, turn to the OFF position; grasp firmly and pull straight off the shaft. To replace knobs after cleaning, line up the flat sides of both the knob and the shaft; then push the knob into place.

### Control Panels

Before cleaning the control panel, turn all controls to OFF and remove the control knobs. To remove, pull each knob straight off the shaft. Clean as instructed above. Squeeze excess water from the cloth before wiping the panel; especially when wiping around the controls. Excess water in or around the controls may cause damage to the appliance. To replace knobs after cleaning, line up the flat sides of both the knob and the shaft; then push the knob into place.

### Porcelain Enamel

Burner Grates, Cooktop Surface, Below Cooktop, Broiler Pan & Insert (some models), Door Liner, Oven Bottom & Burner Drip Pans

Clean burner grates, broiler pan and insert (some models) in the dishwasher and dry upon removal. If soils are not removed, follow the cooktop cleaning instructions below. Gentle scouring with a soapy scouring pad will remove most spots. Rinse with a 1:1 solution of clear water and ammonia. If necessary, cover difficult spots with an ammonia-soaked paper towel for 30 to 40 minutes. Rinse with clean water and a damp cloth, then scrub with a soap-filled scouring pad. Rinse and wipe dry with a clean cloth. Remove all cleaners or the porcelain may become damaged during future heating. DO NOT use spray oven cleaners on the cooktop.

Stainless Steel (some models) Oven Door & Drawer Front Panel and Decorative Trim

Clean stainless steel with hot, soapy water and a dishcloth. Rinse with clean water and a cloth. Do not use cleaners with high concentrations of chlorides or chlorines. Do not use harsh scrubbing cleaners. Only use kitchen cleaners that are especially made for cleaning stainless steel. Always be sure to rinse the cleaners from the surface as bluish stains may occur during heating that cannot be removed.

### Oven Racks

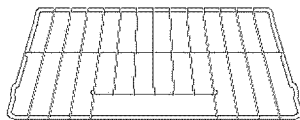

Remove racks. See "To remove and to replace an oven rack" under Oven vent(s) and racks. Use a mild, abrasive cleaner, following manufacturer's instructions. Rinse with clean water and dry. After cleaning the racks, rub the sides of the racks with wax paper or a cloth containing a small amount of baby oil or salad oil (this will make the racks glide easier into the rack positions).

### Oven Door

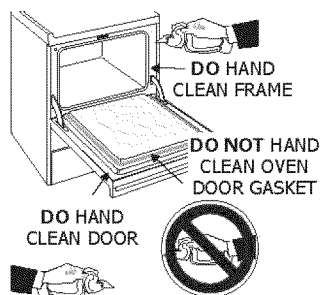

Use soap & water to thoroughly clean the top, sides and front of the oven door. Rinse well. You may use a glass cleaner on the outside glass of the oven door. DO NOT immerse the door in water. DO NOT spray or allow water or the glass cleaner to enter the door vents. DO NOT use oven cleaners, cleaning powders or any harsh abrasive cleaning materials on the outside of the oven door.

DO NOT clean the oven door gasket. The oven door gasket is made of a woven material, on Self-Cleaning models, which is essential for a good seal. Care should be taken not to rub, damage or remove this gasket.

## CARE & CLEANING

### Coil Elements Cooktop Cleaning & Maintenance

Prior to cleaning the coil elements make sure they are cold and that control knobs are set at OFF.

Never immerse the coil elements in water.

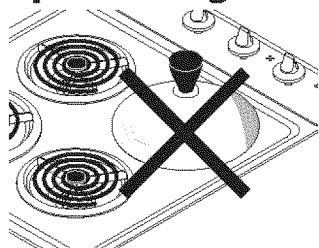

#### **! WARNING**

Never leave covers on the coil elements as they could be permanently damaged if turned on by accident.

### To Remove and Replace Surface Elements and Drip Bowls (some models)

#### **! CAUTION**

Be careful not to bend terminal ends when replacing elements after cleaning.

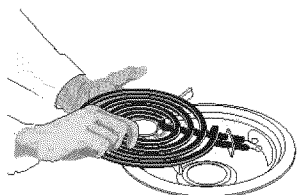

#### **! CAUTION**

Before cleaning the cooktop, be sure the controls are turned to **OFF** and the cooktop is **COOL**.

#### **To Remove**

1. Lift up edge of surface element across from terminal end just enough to clear the edge of the drip bowl.
2. Gently slide the surface element out of the terminal plug.
3. Lift the drip bowl up and out.

#### **To Replace**

1. Line up the opening of the drip bowl with the terminal plug.
2. Hold the surface element as level as possible and slide the terminal end through the opening and into the terminal plug.
3. Be sure the surface element is level to reduce the hazard of pans sliding off the element.

### To Raise the Top for Cleaning

1. Grasp the sides and lift from the front. Some models may have a lift-up rod to support the top in its raised position. Lift the top only high enough to allow the support rod to fit into place, then gently lower the cooktop onto the raised rod.
2. Clean underneath using a clean cloth and hot, soapy water.
3. Gently lower the cooktop into the frame. If your model has a support rod, lower the support rod, then gently lower the cooktop into the frame.

#### **! CAUTION**

When lowering the lift-up cooktop, grasp the sides with fingertips only. Be careful not to pinch fingers. **DO NOT** drop or bend the cooktop when raising or lowering. This could damage the surface.

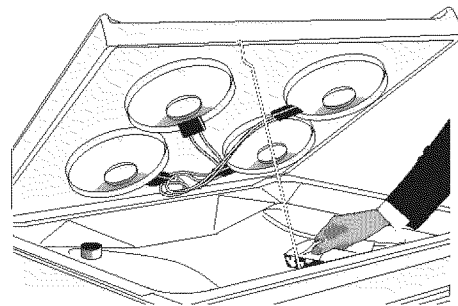

A rod swings up to support the top for cleaning underneath.

### Porcelain enamel cooktop cleaning instructions (some models)

#### **! WARNING**

**Do not** use a cooktop cleaner on a hot cooktop. The fumes can be hazardous to your health, and can chemically damage the cooking surface.

#### **! CAUTION**

Before cleaning the surface cooktop, be sure the controls are turned to OFF and the cooktop is cool.

**DO NOT use commercial oven cleaners** on the **exterior** surfaces including cooktop and door frame.

Correct and consistent cleaning is essential to maintaining your porcelain enamel cooktop. If food spills and grease spatters are not removed, they may burn onto the surface of the cooktop and cause permanent discoloration.

#### **Daily Cleaning**

##### **For normal soil:**

1. Allow cooktop surface to cool.
2. Wipe off spills and spatters using a clean paper towel or a clean cloth with warm, soapy water.
3. If needed, use a soapy steel wool pad or other mild household cleaners.
4. Be sure to rinse off the cleaners or the porcelain may become damaged during future heating.



## CARE & CLEANING

### Ceramic glass cooktop cleaning & maintenance (Models B & C only)

**Consistent and proper cleaning is essential to maintaining your Ceramic glass cooktop.**

#### For heavy, burned-on soil:

1. Allow cooktop surface to cool.
2. Use a soap filled scouring pad with warm water or cover heavily soiled spots with a solution of clear water and ammonia. Scour gently. Rinse and wipe dry with a clean cloth.
3. If any soil remains, apply a few drops of a recommended cooktop cleaning cream on the spots and rub gently using a clean damp cloth or scouring pad. Buff with a dry cloth until all soil and cream are removed. Frequent cleaning with the cooktop cleaning cream leaves a protective coating which helps in preventing scratches and abrasions.

#### For sugary spillovers:

Sugary spills can chemically damage your cooktop surface. Therefore, you must begin cleaning the spills while the cooktop is still hot. Use caution when following the steps below.

1. Turn off all surface units and remove all pans immediately.
2. Wearing an oven mitt, wipe up carefully or move hot spills away from the element area with a clean damp cloth.
3. Allow the cooktop to cool. Follow the instructions above for heavy, burned-on soil.

COOKTOP CLEANING / POLISHING CREAM can be purchased through authorized service centers or major department stores.

Prior to using your cooktop for the first time, apply the recommended CERAMA BRYTE® Cleaning Creme to the ceramic surface. Clean and buff with a non abrasive cloth or pad. This will make cleaning easier when soiled from cooking. The special cooktop cleaning cream leaves a protective finish on the glass to help prevent scratches and abrasions.

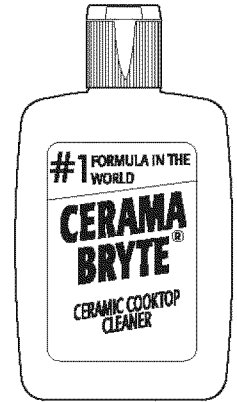

Sliding aluminum or copper clad bottom pans on the cooktop can cause metal markings on the cooktop surface. These marks should be removed **immediately** after the cooktop has cooled using the cooktop cleaning cream. Metal marks can become permanent if not removed prior to future use.

Cookware (cast iron, metal, ceramic or glass) with rough bottoms can mark or scratch the cooktop surface. **Do not slide anything metal or glass** across the cooktop. **Do not** use your cooktop as a cutting board or work surface in the kitchen. **Do not** cook foods directly on the cooktop surface without a pan. **Do not** drop heavy or hard objects on the glass cooktop, or they may crack it.

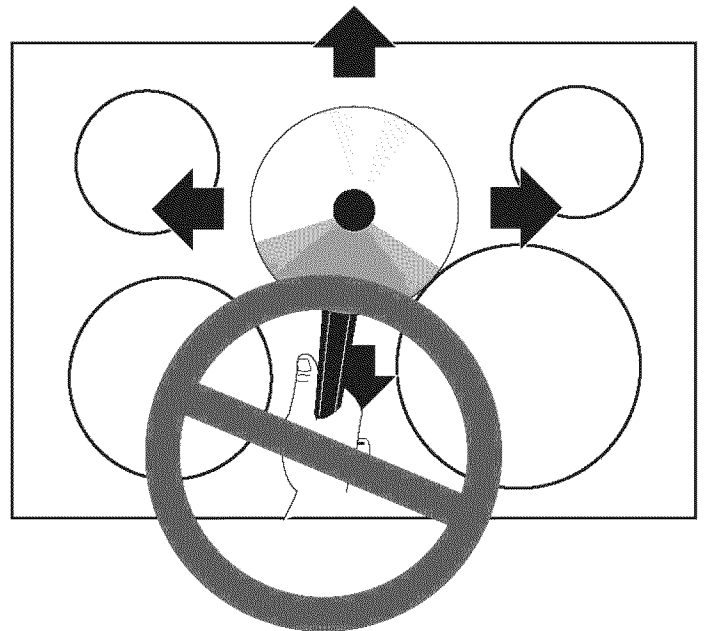

# CARE & CLEANING

## Cleaning recommendations for the ceramic glass cooktop (Models B & C only)

### CAUTION

Before cleaning the cooktop, be sure the controls are turned to **OFF** and the cooktop is **COOL**.

### WARNING

**DO NOT** use a cooktop cleaner on a hot cooktop. The fumes can be hazardous to your health, and can chemically damage the ceramic glass surface.

#### For light to moderate soil:

Apply a few drops of CookTop® Cleaning Creme directly to the cooktop. Use a paper towel or use a **non-abrasive** plastic type **no-scratch** pad to clean the entire cooktop surface. Make sure the cooktop is cleaned thoroughly, leaving no residue.

#### For heavy, burned on soil:

Apply a few drops of CookTop® Cleaning Creme directly to the soiled area. Rub the soiled area using a **non-abrasive** plastic type **no-scratch** pad, applying pressure as needed. Do not use the pad you use to clean the cooktop for any other purpose.

### IMPORTANT

Damage to the ceramic glass cooktop may occur if you use an abrasive type scratch pad. Only use cleaning products that have been specifically designed for ceramic glass cooktop.

If soils remain, carefully scrape soils with a metal razor blade scraper, holding scraper at a 30 degree angle to the surface. Remove loosened soils, then apply a few drops of cleaning cream and buff surface clean.

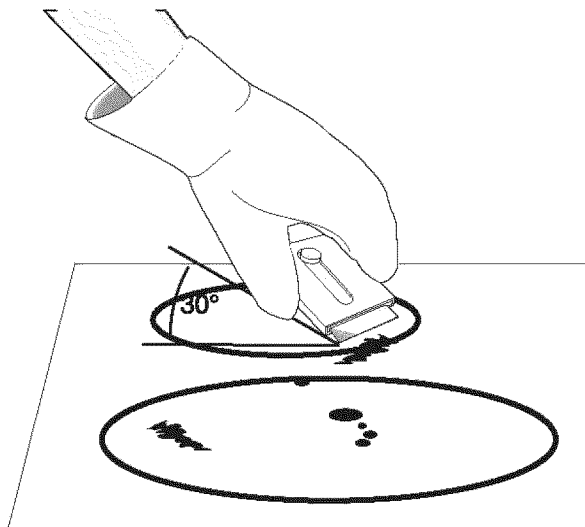

#### Plastic or foods with a high sugar content:

These types of soils need be removed immediately if spilled or melted onto the ceramic cooktop surface. Permanent damage (such as pitting of the cooktop surface) may occur if not removed **immediately**. After turning the surface elements **OFF**, use a razor blade scraper or a metal spatula with a mitt and scrape the soil from the hot surface (as illustrated). Allow the cooktop to cool, and use the same method for heavy or burned on soils.

#### Do not use the following on the ceramic glass cooktop:

- Do not use abrasive cleaners and scouring pads, such as metal and some nylon pads. They may scratch the cooktop, making it more difficult to clean.
- Do not use harsh cleaners, such as chlorine bleach, ammonia or oven cleaners, as they may etch or discolor the cooktop.
- Do not use dirty sponges, cloths or paper towels, as they can leave soil or lint on the cooktop which can burn and cause **Special Caution for Aluminum Foil and Aluminum Cooking Utensils**



- **Aluminum foil**  
Use of aluminum foil will damage the cooktop. Do not use under any circumstances.
- **Aluminum utensils**  
Since the melting point of aluminum is much lower than that of other metals, care must be taken when aluminum pots or pans are used. Pans that boil dry may permanently damage cooktop by breaking, fusing to, or marking it.

## Care and cleaning of stainless steel

Some models are equipped with stainless steel exterior parts. Special care and cleaning are **required** for maintaining the appearance of stainless parts. Refer to the **General Care & Cleaning** table for detailed cleaning instructions.

## Removing and replacing the lift-off oven door

### CAUTION

The door is heavy. For safe, temporary storage, lay the door flat with the inside of the door facing down.

#### To Remove Oven Door:

1. Open oven door completely (horizontal with floor - See Figure 1).
2. Pull the door hinge locks on both left and right door hinges down from the oven frame completely towards the oven door (See Figure 2). A tool such as a small flat-blade screwdriver may be required.
3. Firmly grasp both sides of oven door along the door sides (Do not use the oven door handle - See Figure 3).
4. Close the door to the broil stop position (the oven door will stop into this position just before fully closing).
5. With the oven door in the broil stop position, lift the oven door hinge arms over the roller pins located on each side of the oven frame (See Figure 4).

#### To Replace Oven Door:

1. Firmly grasp both sides of oven door along the door sides (Do not use the oven door handle - See Figure 3).
2. Holding the oven door at the same angle as the removal position, seat the hook of the hinge arm over the roller pins located on each side of the oven door frame (See Figure 4). The hook of the hinge arms must be fully seated onto the roller pins.
3. Fully open the oven door (horizontal with floor - See Figure 1).
4. Push the door hinge locks up towards and into the oven frame on both left and right oven door hinges (See Figure 2) to the locked position.
5. Close the oven door.

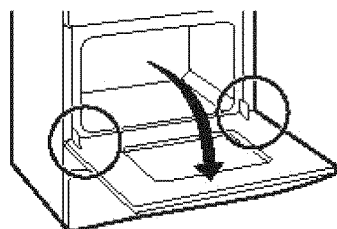

Door Hinge locations with oven door fully open  
Figure 1

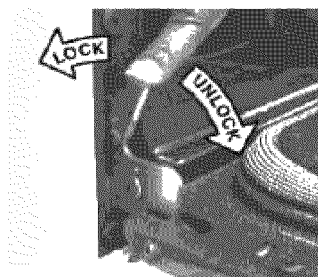

Figure 2

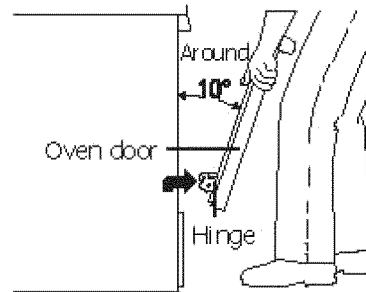

Figure 3

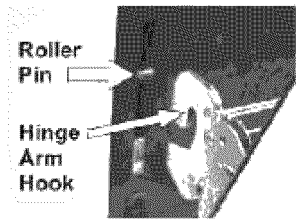

Figure 4

## Special door care instructions - Most

oven doors contain glass that can break.

Read the following recommendations:

1. Do not close the oven door until all the oven racks are fully in place.
2. Do not hit the glass with pots, pans, or any other object.
3. Scratching, hitting, jarring or stressing the glass may weaken its structure causing an increased risk of breakage at a later time.

## Changing oven light

### CAUTION

Be sure the oven is unplugged and all parts are COOL before replacing the oven light bulb. Do not turn the oven light on during a self-cleaning cycle. High temperature will reduce lamp life.

On some models an interior oven light will turn on automatically when the oven is opened. The oven light may be turned on when the door is closed by using the oven light switch located on the Electronic Oven control. The oven light bulb is covered with a glass shield held in place by a wire holder. **THIS GLASS SHIELD MUST ALWAYS BE IN PLACE WHEN THE OVEN IS IN USE.**

### CAUTION

**BE SURE OVEN IS COOL**

#### To Replace the Light Bulb:

1. Turn the power off at the main source.
2. Wear a leather-faced glove for protection against possible broken glass.
3. Replace bulb with a 40 Watt appliance bulb only.
4. For self-cleaning oven, press wire holder to one side to release glass shield, change bulb and be sure to replace glass shield.

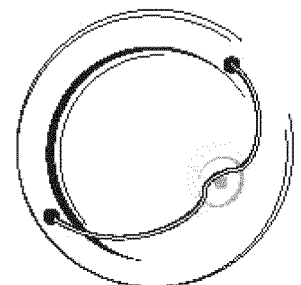

# CARE & CLEANING

## Cleaning the Regular Oven (non self-clean oven, some models)

Make sure the oven is cool and that all control knobs are at OFF position. Cleaning the oven is a lot easier when the door is removed.

1. Remove the oven door; see under To Remove and Replace the Oven Door in this Owner's Guide.
2. Empty the oven including the racks.
3. You can wash your broiler pan, grid and racks in the kitchen sink.
4. Clean oven lining thoroughly with soap and a wet cloth and wipe with a dry cloth.

To remove burned-on fat on oven walls, moisten soiled parts with household ammonia, using a wet cloth. Follow suggested manufacturer's cleaning method. (Do not remove the oven door when using ammonia.)

Complete cleaning with a damp cloth and use a fine steel wool scouring agent if necessary.

The lower element can be moved up for cleaning purposes.

5. Replace racks in the oven.  
Reinstall oven door.

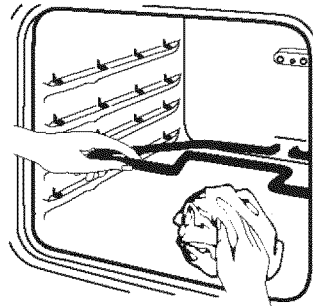

## To remove and replace storage drawer (some models)

Use the storage drawer for storing cooking utensils. The drawer can be removed to facilitate cleaning under the range. Use care when handling the drawer.

### Removing and Replacing Storage Drawer

#### To remove the drawer:

1. Pull empty drawer out to the roller guide stop.
2. Tilt the drawer up and pull it out over the rollers.

#### To replace the drawer:

1. Insert the rear end of the drawer into the opening.
2. Fit the drawer end rollers onto the guide rails.
3. Push the drawer in until it stops, then lift to allow the rollers to clear the roller guide stop, and push in.

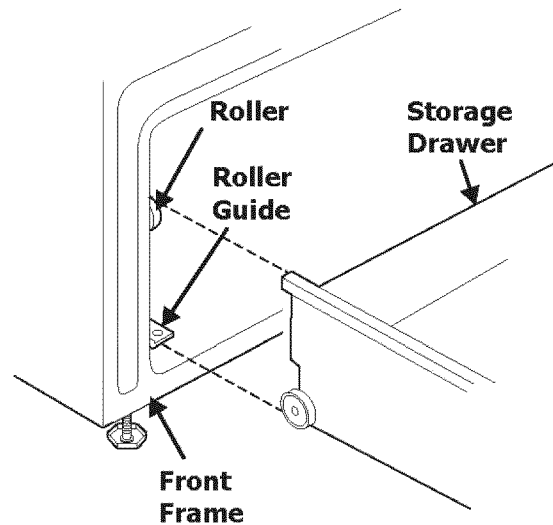

## BEFORE YOU CALL (Solutions to Common Problems)

### Oven baking

For best cooking results, heat the oven before baking cookies, breads, cakes, pies or pastries, etc. There is no need to preheat the oven for roasting meat or baking casseroles.

The cooking times and temperatures needed to bake a product may vary slightly from your previously owned appliance.

#### Baking Problems and Solutions Chart

##### Baking Problems

##### Causes

##### Corrections

##### Cookies and biscuits burn on the bottom.

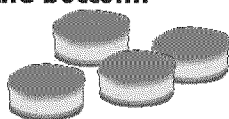

##### Cakes too dark on top or bottom.

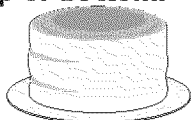

##### Cakes not done in the center.

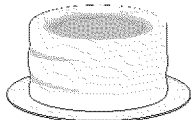

##### Cakes not level.



##### Foods not done when cooking time is up.

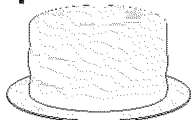

- Cookies and biscuits put into the oven before the preheating time is completed.
- Oven rack overcrowded.
- Dark pan absorbs heat too fast.
- Cakes put into the oven before preheating time is completed.
- Rack position too high or low.
- Oven too hot.
- Oven too hot.
- Incorrect pan size.
- Pan not centered in oven.
- Range not level.
- Pan too close to oven wall or rack overcrowded.
- Pan warped.
- Oven too cool.
- Oven overcrowded.
- Oven door opened too frequently.
- Allow oven to preheat to the selected temperature before placing food in oven.
- Choose pan sizes that will permit 5.1cm to 10.2cm (2" to 4") of air space on all sides when placed in the oven.
- Use a medium-weight aluminum baking sheet.
- Allow oven to preheat to the selected temperature before placing food in the oven.
- Use proper rack position for baking needs.
- Set oven temperature 25°F/12°C lower than recommended.
- Set oven temperature 25°F/12°C lower than recommended.
- Use pan size suggested in recipe.
- Use proper rack position and place pan so there is 5.1cm to 10.2cm (2" to 4") of space on all sides of pan.
- Place a marked glass measuring cup filled with water on the center of the oven rack. If the water level is uneven, refer to the installation instructions for leveling the range.
- Be sure to allow 5.1cm to 10.2cm (2" to 4") of clearance on all sides of each pan in the oven.
- Do not use pans that are dented or warped.
- Set oven temperature 25°F/12°C higher than suggested and bake for the recommended time.
- Be sure to remove all pans from the oven except the ones to be used for baking.
- Open oven door only after shortest recommended baking time.

## BEFORE YOU CALL (Solutions to Common Problems)

### IMPORTANT

Before you call for service, review this list. It may save you time and expense. The list includes common occurrences that are not the result of defective workmanship or materials in this appliance.

<b>OCCURRENCE</b>	<b>POSSIBLE CAUSE/SOLUTION</b>
<b>Range is not level.</b>	<p>Poor installation. Place oven rack in center of oven. Place a level on the oven rack. Adjust leveling legs at base of range until the rack is level. When range is level, cooktop may appear out of alignment if countertop is not level.</p> <p>Weak, unstable floor. Be sure floor is level and can adequately support range. If floor is sagging or slopping, contact a carpenter to correct the situation.</p> <p>Kitchen cabinet misalignment may make range appear to be unlevel. Be sure cabinets are square and have sufficient room for range clearance.</p>
<b>Cannot move appliance easily. Appliance must be accessible for service.</b>	<p>Cabinets not square or are built in too tight. Contact a cabinet maker to correct the problem.</p> <p>Contact builder or installer to make appliance accessible.</p> <p>Carpet interferes with range. Provide sufficient space so range can be lifted over carpet.</p> <p>Gas line is hard-plumbed. Have a flexible C.S.A. international approved metal appliance connector installed.</p>
<b>Entire range or oven does not operate.</b>	<p>Make sure cord/plug is plugged tightly into outlet.</p> <p>Service wiring is not complete. Call an authorized servicer.</p> <p>Electrical power outage. Check house lights to be sure. Call your local electric company for service.</p>
<b>Oven control beeps and displays any F code error (ex.: F11)</b>	<p>Electronic control has detected a fault condition. Press <b>Clear</b> to clear the display and stop beeping. Reprogram oven. If fault recurs, record fault number. Press <b>Clear</b> and call an authorized servicer for assistance.</p>
<b>Oven light does not work.</b>	<p>Replace or tighten bulb. See Changing Oven Light section in this Use &amp; Care Guide.</p> <p>Electrical power outage. Check house lights to be sure. Call your local electric company for service.</p>
<b>Surface unit does not heat.</b>	<p>No power to the appliance. Check steps under "Entire Range or Oven Does Not Operate" in this Before you Call checklist.</p> <p>Incorrect control setting. Make sure the correct control is on for the surface unit to be used.</p>
<b>Surface units too hot or not hot enough.</b>	<p>Incorrect control setting. Make sure the correct control is on for the surface unit to be used.</p> <p>Lightweight or warped pans used. Use only flat, evenly balanced, medium or heavyweight cookware. Flat pans heat better than warped pans. Cookware materials and weight of the material affect heating. Heavy-and medium- weight pans heat evenly. Because lightweight pans heat unevenly, foods may burn easily.</p>
<b>Drip bowls are pitting or rusting.</b>	<p>Foods with acids, such as tomatoes, if allowed to stand in/on bowls will cause corrosion. Remove and wash drip bowls as soon as possible after spillover.</p> <p>Normal environment. Houses along sea coast are exposed to salt air. Protect bowls as much as possible from direct exposure to salt air.</p>
<b>Drip bowls turning color or distorted out of shape.</b>	<p>Bottom surface of cookware extends beyond surface elements and touches cooktop surface. This can cause high enough temperatures to discolor the drip bowls. DO NOT use cookware of this type. Pan sizes should be matched to the size of the element. Replacement drip bowls may be purchased from your dealer.</p>
<b>Metalmarks.</b>	<p>Sliding or scraping of metal utensils on cooktop surface. Do not slide metal utensils on cooktop surface. Use a ceramic-glass cooktop cleaning cream to remove the marks. "Cooktop Cleaning - Ceramic Glass Cooktop Models" section under General Cleaning.</p>

## BEFORE YOU CALL (Solutions to Common Problems)

OCCURRENCE	POSSIBLE CAUSE/SOLUTION
<b>Scratches or abrasions on cooktop surface.</b>	<p>Coarse particles such as salt or sand between cooktop and utensils can cause scratches. Be sure cooktop surface and bottoms of utensils are clean before usage. Small scratches do not affect cooking and will become less visible with time.</p> <p>Cleaning materials not recommended for ceramic-glass cooktop have been used. See "Cooktop Cleaning - Ceramic Glass Cooktop Models" section under General Cleaning.</p> <p>Cookware with rough bottom has been used. Use smooth, flat-bottomed cookware.</p>
<b>Brown streaks or specks.</b>	<p>Boilovers are cooked onto surface. Use razor blade scraper to remove soil. "Cooktop Cleaning - Ceramic Glass Cooktop Models" section under General Cleaning.</p>
<b>Areas of discoloration with metallic sheen.</b>	<p>Mineral deposits from water and food. Remove using a ceramic-glass cooktop cleaning cream. Use cookware with clean, dry bottoms.</p>
<b>Poor baking results.</b>	<p>Many factors affect baking results. Make sure the proper rack position is used. Center food in the oven and space pans to allow air to circulate. Allow the oven to preheat to the set temperature before placing food in the oven. Try adjusting the recipes' recommended temperature or baking time. If you feel the oven is too hot or cool, see "Adjusting Your Oven Temperature" section in the Electronic Oven Control Guide.</p>
<b>Fan noise during cooking operation.</b>	<p>A cooling fan may automatically turn on and off to cool internal parts. It is normal, and the fan may continue to run even after oven is turned off.</p>
<b>Flames inside oven or smoking from vent.</b>	<p>Excessive spillovers in oven. Set self-clean cycle for a longer cleaning time.</p> <p>Excessive spillovers in oven. This is normal, especially for pie spillovers or large amounts of grease on the oven bottom. Wipe up excessive spillovers before starting the self-clean cycle. If flames or excessive smoke are present, stop the self-clean cycle and follow the steps under "Stopping or Interrupting the Self-Cleaning Cycle" in the Electronic Oven Control Guide.</p>
<b>Oven smokes excessively during broiling.</b>	<p>Control(s) not set properly. Follow instructions under "Setting Oven Controls".</p> <p>Make sure oven is opened to Broil Stop Position.</p> <p>Meat too close to the element. Reposition the rack to provide proper clearance between the meat and the element. Preheat broil element. Preheat broil element for searing.</p> <p>Grid on broiler pan wrong side up and grease not draining. Always place grid on the broiler pan with ribs up and slots down to allow grease to drip into pan.</p> <p>Grease has built up on oven surfaces. Regular cleaning is necessary when broiling frequently. Old grease or food spatters cause excessive smoking.</p> <p>Control(s) not set properly. Follow instructions under "Oven Cleaning" in the Electronic Oven Control Guide.</p>
<b>Self-cleaning cycle does not work.</b>	<p>Control(s) not set properly. Follow instructions under "Oven Cleaning" in the Electronic Oven Control Guide.</p> <p>Self-cleaning cycle was interrupted. Stop time must be 2 to 4 hours past the start time. Follow steps under "Stopping or Interrupting the Self-Cleaning Cycle" in the Electronic Oven Control Guide.</p>
<b>Soil not completely removed after self-cleaning cycle.</b>	<p>Set Self-Clean cycle for a longer cleaning time.</p> <p>Failure to clean bottom front, top of oven or door areas outside oven seal. These areas are not in the Self-Cleaning area, but get hot enough to burn on food residue. Clean these areas before starting the Self-Clean cycle. Burned-on residue may be cleaned with a stiff nylon brush and water or nylon scrubber. Be careful not to damage the oven gasket.</p>
<b>Excessive smoking from oven vent.</b>	<p>Excessive spillovers in oven, especially for pie spillovers or large amounts of grease on the oven bottom. Wipe up excessive spillovers before starting the Self-Clean cycle. If flames or excessive smoke are present, stop the Self-Clean cycle and follow the steps under "Stopping or Interrupting the Self-Cleaning Cycle" in the Electronic Oven Control Guide.</p>

# MAJOR APPLIANCE WARRANTY

Your appliance is covered by a one year limited warranty. For one year from your original date of purchase, Electrolux will pay all costs for repairing or replacing any parts of this appliance that prove to be defective in materials or workmanship when such appliance is installed, used and maintained in accordance with the provided instructions.

**Exclusions This warranty does not cover the following:**

1. Products with original serial numbers that have been removed, altered or cannot be readily determined.
2. Product that has been transferred from its original owner to another party or removed outside the USA or Canada.
3. Rust on the interior or exterior of the unit.
4. Products purchased "as-is" are not covered by this warranty.
5. Food loss due to any refrigerator or freezer failures.
6. Products used in a commercial setting.
7. Service calls which do not involve malfunction or defects in materials or workmanship, or for appliances not in ordinary household use or used other than in accordance with the provided instructions.
8. Service calls to correct the installation of your appliance or to instruct you how to use your appliance.
9. Expenses for making the appliance accessible for servicing, such as removal of trim, cupboards, shelves, etc., which are not a part of the appliance when it is shipped from the factory.
10. Service calls to repair or replace appliance light bulbs, air filters, water filters, other consumable, or knobs, handles, or other cosmetic parts.
11. Surcharges including, but not limited to, any after hour, weekend, or holiday service calls, tolls, ferry trip charges, or mileage expense for service calls to remote areas, including the state of Alaska.
12. Damages to the finish of appliance or home incurred during installation, including but not limited to floors, cabinets, walls, etc.
13. Damages caused by: services performed by unauthorized service companies; use of parts other than genuine Electrolux parts or parts obtained from persons other than authorized service companies; or external causes such as abuse, misuse, inadequate power supply, accidents, fires, or acts of God.

**DISCLAIMER OF IMPLIED WARRANTIES; LIMITATION OF REMEDIES**

Customer's sole and exclusive remedy under this limited warranty shall be product repair or replacement as provided herein. Claims based on implied warranties, including warranties of merchantability or fitness for particular purpose, are limited to one year or the shortest period allowed by law, but not less than one year. Electrolux shall not be liable for consequential or incidental damages such as property damage and incidental expenses resulting from any breach of this written limited warranty or any implied warranty. Some states and provinces do not allow the exclusion or limitation of incidental or consequential damages, or limitations on the duration of implied warranties, so these limitations or exclusions may not imply to you. This written warranty gives you specific legal rights. You may also have other rights that vary from state to state.

**If You  
Need  
Service**

Keep your receipt, delivery slip, or some other appropriate payment record to establish the warranty period should service be required. If service is performed, it is in your best interest to obtain and keep all receipts. Service under this warranty must be obtained contacting Electrolux at the addresses or phone numbers below.

This warranty only applies in the USA and Canada. In the USA, your appliance is warranted by Electrolux Major Appliances North America, a division of Electrolux Home Products, Inc. In Canada, your appliance is warranted by Electrolux Canada Corp. Electrolux authorizes no person to change or add to any obligations under this warranty. Obligations for service and parts under this warranty must be performed by Electrolux or an authorized service company. Product features or specifications as described or illustrated are subject to change without notice.

USA  
1.800.944.9044  
Electrolux Home Products, Inc.,  
10200 David Taylor Drive  
Charlotte, NC 28262



Canada  
1.800.265.8352  
Electrolux Canada Corp.  
5855 Terry Fox Way  
Mississauga, Ontario, Canada  
L5V 3E4