

FRIGIDAIRE

All about the

Use & Care

of your Cooktop

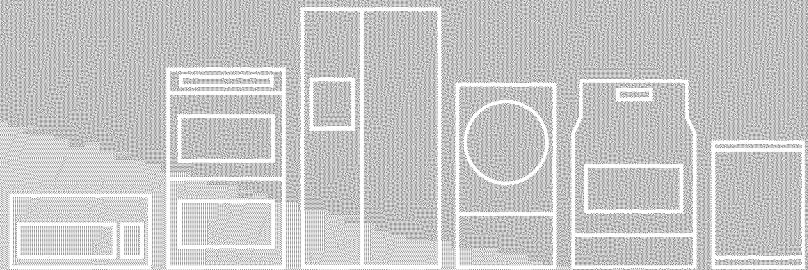

TABLE OF CONTENTS

Welcome & Congratulations	2	Care & Cleaning (Cleaning Chart)	11
Important Safety Instructions.....	3	Care & Cleaning	12
Surface Cooking	5	Before You Call	14
Before Setting Surface Controls	7	Major Appliance Warranty	16
Setting Surface Controls	8		

WELCOME & CONGRATULATIONS

Product Registration

Register Your Product

The **PRODUCT REGISTRATION CARD** should be filled in completely, signed and returned to Electrolux Home Products.

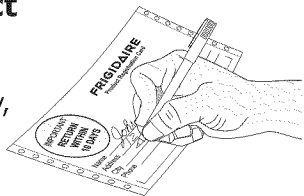

Congratulations on your purchase of a new appliance! At **Electrolux Home Products**, we are very proud of our product and are completely committed to providing you with the best service possible. Your satisfaction is our number one priority.

We know you'll enjoy your new appliance and **Thank You** for choosing our product. We hope you consider us for future purchases.

PLEASE CAREFULLY READ AND SAVE THESE INSTRUCTIONS

This Use & Care Manual contains general operating instructions for your appliance and feature information for several models. Your product **may not** have all the described features. The graphics shown are representative. The graphics on your appliance may not look exactly like those shown. These instructions are not meant to cover every possible condition and situation that may occur. Common sense and caution must be practiced when installing, operating and maintaining any appliance.

Serial Plate Location

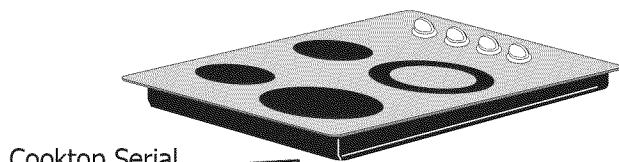

or

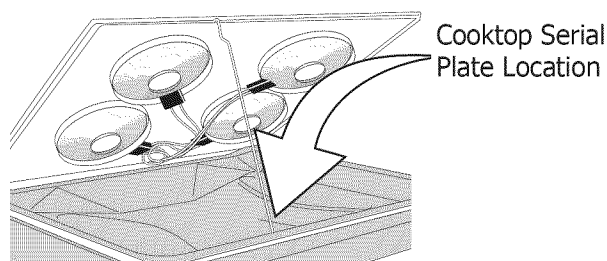

Please record your model and serial numbers below for future reference.

Model Number: _____

Serial Number: _____

Purchase Date: _____

NOTE

Please attach sales receipt here for future reference.

IMPORTANT SAFETY INSTRUCTIONS

Read all instructions before using this appliance.
Save these instructions for future reference.

DEFINITIONS

⚠ This is the safety alert symbol. It is used to alert you to potential personal injury hazards. Obey all safety messages that follow this symbol to avoid possible injury or death.

⚠ WARNING

This symbol will help alert you to situations that may cause serious bodily harm, death or property damage.

⚠ CAUTION

This symbol will help alert you to situations that may cause bodily injury or property damage.

➡ IMPORTANT

IMPORTANT indicates installation, operation or maintenance information which is important but not hazard-related.

- **Remove all tape and packaging wrap before using the appliance. Destroy the carton and plastic bags after unpacking the appliance.** Never allow children to play with packaging material.
- **Proper Installation. Be sure your appliance is properly installed and grounded by a qualified technician in accordance with the National Electrical Code No. 70 - latest edition in the United States, or CSA C22.1, Part 1 in Canada, and local code requirements.** Install only per installation instructions provided in the literature package for this appliance.

Ask your dealer to recommend a qualified technician and an authorized repair service. Know how to disconnect the electrical power to the appliance at the circuit breaker or fuse box in case of an emergency.

- **User Servicing. Do not repair or replace any part of the appliance unless specifically recommended in the manuals.** All other servicing should be done only by a qualified technician to reduce the risk of personal injury and damage to the appliance.
- **Never modify or alter the construction of an appliance such as removal of panels, wire covers or any other permanent part of the appliance.**

- **Storage on Appliance. Flammable materials should not be stored near surface units.** This includes paper, plastic and cloth items, such as cookbooks, plasticware and towels, as well as flammable liquids. Do not store explosives, such as aerosol cans, on or near the appliance. Flammable materials may explode and result in fire or property damage.

⚠ CAUTION

Do not store items of interest to children in the cabinets above the appliance. Children climbing on the cooktop to reach items could be seriously injured.

- **Do not leave children alone. Children should not be left alone or unattended in the area where an appliance is in use.** They should never be allowed to sit or stand on any part of the appliance.
- **DO NOT TOUCH SURFACE UNITS OR AREAS NEAR THESE UNITS.** Surface units may be hot even though they are dark in color. Areas near surface units may become hot enough to cause burns. During and after use, do not touch, or let clothing or other flammable materials touch these areas until they have had sufficient time to cool. Among these areas are the cooktop and areas facing the cooktop.
- **Wear Proper Apparel. Loose-fitting or hanging garments should never be worn while using the appliance.** Do not let clothing or other flammable materials contact hot surfaces.

⚠ WARNING

Never use your appliance for warming or heating the room.

- **Do Not Use Water or Flour on Grease Fires. Smother the fire with a pan lid, or use baking soda, a dry chemical or foam-type extinguisher.**
- **When heating fat or grease, watch it closely.** Fat or grease may catch fire if allowed to become too hot.
- **Use Only Dry Pot holders. Moist or damp pot holders on hot surfaces may result in burns from steam.** Do not let the pot holders touch hot surface units. Do not use a towel or other bulky cloth instead of a pot holder.
- **Do Not Heat Unopened Food Containers. Buildup of pressure may cause the container to burst and result in injury.**

IMPORTANT SAFETY INSTRUCTIONS

IMPORTANT SAFETY INSTRUCTIONS FOR USING YOUR COOKTOP

- **Know which knob controls each surface unit.**
- **Clean the appliance regularly to keep all parts free of grease that could catch fire.** Exhaust fan ventilation hoods and grease filters should be kept clean. Do not allow grease to accumulate on hood or filter. Greasy deposits in the fan could catch fire. When flaming food under the hood, turn fan on. Refer to hood manufacturer's instructions for cleaning.
- **Use Proper Pan Size.** This appliance is equipped with one or more surface units of different sizes. Select utensils having flat bottoms large enough to cover the surface unit. The use of undersized utensils will expose a portion of the surface heating unit to direct contact and may result in ignition of clothing. Proper relationship of utensil to element will also improve efficiency.
- **Utensil Handles Should Be Turned Inward and Not Extend Over Adjacent Surface Units.** To reduce the risk of burns, ignition of flammable materials, and spillage due to unintentional contact with the utensil.
- **Never Leave Surface Units Unattended.** Boilovers cause smoking and greasy spillovers that may ignite, or a pan that has boiled dry may melt.
- **Protective Liners.** Do not use aluminum foil to line any part of the appliance. Only use aluminum foil as recommended for baking if used as a cover placed on the food. Any other use of protective liners or aluminum foil may result in a risk of electric shock or fire or short circuit.
- **Glazed Cooking Utensils.** Only certain types of glass, glass/ceramic, ceramic, earthenware, or other glazed utensils are suitable for range top service without breaking due to the sudden change in temperature. Check the manufacturer's recommendations for cooktop use.
- **Do Not Use Decorative Surface Element Covers.** If an element is accidentally turned on, the decorative cover will become hot and possibly melt. Burns will occur if the hot covers are touched. Damage may also be done to the appliance.

FOR COOKTOP WITH COIL ELEMENTS ONLY

- **Do Not immerse or Soak Removable Surface Heating Elements.** Surface heating elements should never be immersed in water. Heating elements clean themselves during normal operation.
- **Make Sure Drip Pans or Drip Bowls are in Place.** Absence of these pans or bowls during cooking may subject wiring or components underneath to damage.

FOR CERAMIC-GLASS COOKTOP ONLY

- **Do Not Clean or Operate a Broken Cooktop.** If cooktop should break, cleaning solutions and spillovers may penetrate the broken cooktop and create a risk of electric shock. Contact a qualified technician immediately.
- **Clean Cooktop with Caution.** If a wet sponge or cloth is used to wipe spills on a hot cooking area, be careful to avoid a steam burn. Some cleaners can produce harmful fumes if applied to a hot surface.
- **Do Not Place Hot Cookware on Cold Cooktop Glass.** This could cause glass to break.
- **Do not slide pan across the cooktop surface.** They may scratch the cooktop surface.
- **Do Not Let Pans Boil Dry.** This may cause permanent damage in the form of breakage, fusion, or marking that can affect the ceramic-glass cooktop (This type of damage is not covered by your warranty).

▶ IMPORTANT SAFETY NOTICE

The California Safe Drinking Water and Toxic Enforcement Act requires the Governor of California to publish a list of substances known to the state to cause cancer, birth defects or other reproductive harm, and requires businesses to warn customers of potential exposure to such substances.

SAVE THESE INSTRUCTIONS

Selecting Surface Cooking Cookware

Cookware should have flat bottoms that make good contact with the entire surface heating element. Check for flatness by rotating a ruler across the bottom of the cookware (See Figure 1).

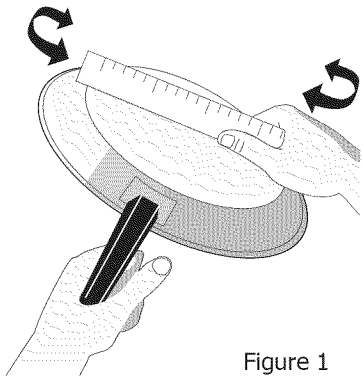
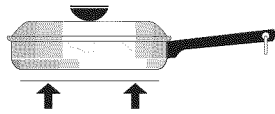

Figure 1

Be sure to follow the recommendations for using cookware as shown in Figure 2.

CORRECT



- Flat bottom and straight sides.
- Tight fitting lids.
- Weight of handle does not tilt pan. Pan is well balanced.
- Pan sizes match the amount of food to be prepared and the size of the surface element.
- Made of material that conducts heat well.
- Easy to clean.
- Always match pot diameter to element surface diameter.

INCORRECT

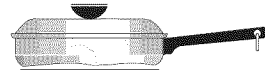

- Curved and warped pan bottoms.

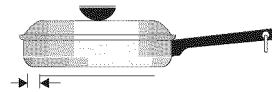

- Pan overhangs unit by more than one-half inch.

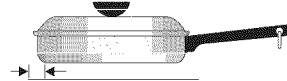

- Pan is smaller than the element.



- Heavy handle tilts the pan.

Figure 2

Cookware Material types

The cookware material determines how evenly and quickly heat is transferred from the surface element to the pan bottom. The most popular materials available are:

ALUMINUM - Excellent heat conductor. Some types of food will cause it to darken (Anodized aluminum cookware resists staining & pitting). If aluminum pans slide across the ceramic glass cooktop, they may leave metal marks which will resemble scratches. Remove these marks immediately.

COPPER - Excellent heat conductor but discolors easily. May leave metal marks on ceramic glass (see Aluminum above).

STAINLESS STEEL - Slow heat conductor with uneven cooking results. Is durable, easy to clean and resists staining.

CAST IRON - A poor heat conductor however will retain heat very well. Cooks evenly once cooking temperature is reached. Not recommended for use on ceramic cooktops.

PORCELAIN-ENAMEL on METAL - Heating characteristics will vary depending on base material. Porcelain-enamel coating must be smooth to avoid scratching ceramic cooktops.

GLASS - Slow heat conductor. Not recommended for ceramic cooktop surfaces because it may scratch the glass.

NOTE

The size and type of cookware used will influence the setting needed for best cooking results.

SURFACE COOKING

Specialty Pans & Trivets

Woks with flat bottoms suitable for use on your cooktop are available in most cook shop or hardware stores. Round-bottomed woks (with a support ring that does not extend beyond the heating element) may also be used. The metal ring was designed to support the wok safely when it is filled with large amounts of liquids (soup making) or fat (frying).

! CAUTION

DO NOT use two elements (if the cooktop is not equipped with bridge element) to heat one large pan such as a roaster or griddle, or allow cooking utensils to boil dry. The bottom surface of the pan in either of these situations could cause discoloring or crazing of the porcelain enamel range surface, and damage to the surface elements and/or damage to the drip pans (if equipped).

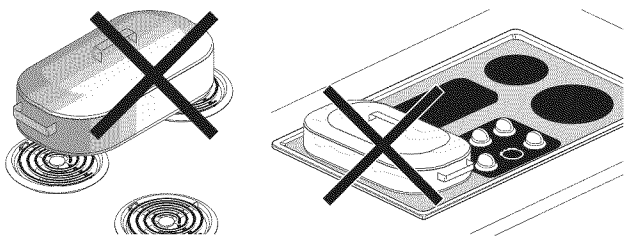

Wire trivets: Do not use wire trivets. Cookware bottoms must be in direct contact with the surface elements.

DO NOT use a wok if it is equipped with a metal ring that extends beyond the surface element. Because this ring traps heat, the surface element and cooktop surface could be damaged.

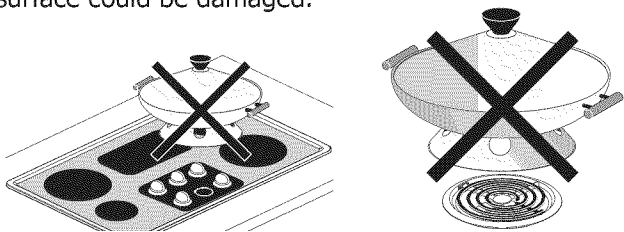

For glass smoothtop models, only flat bottomed woks (without support rings) may be used.

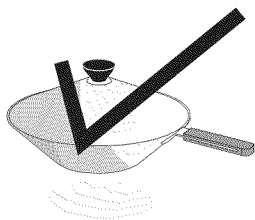

Canning Tips & Information

1. Use tested recipes and follow instructions carefully. Check with your local Cooperative Agricultural Extension Service or a manufacturer of glass jars for the latest canning information.
2. Use flat-bottomed canners only. Heat is spread more evenly when the bottom surface is flat.
3. Center canner on the burner grate.
4. Start with hot water and a high heat setting to reduce the time it takes to bring the water to a boil; then reduce the heat setting as low as possible to maintain a constant boil.
5. It is best to can small amounts and light loads.

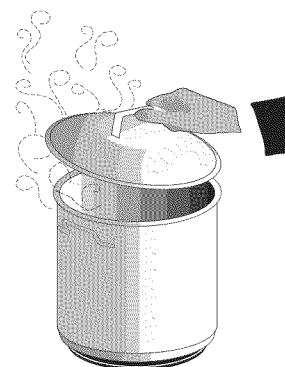

! CAUTION

Canning can generate large amounts of steam. Use extreme caution to prevent burns. Always raise the lid to vent steam away from you.

Prevent damage to cooktop and burner grates:

1. Do not use water bath or pressure canners that extend more than one inch beyond the edge of the burner grate.
2. Do not leave water bath or pressure canners on high heat for an extended amount of time.
3. Alternate surface units between each batch to allow the units and surrounding surfaces to cool down. Try to avoid canning on the same burner unit all day.

Safe canning requires that harmful micro-organisms are destroyed and the jars are sealed completely. When canning in a water bath canner, a gentle but steady boil must be maintained continuously for the required time.

BEFORE SETTING SURFACE CONTROLS

Ceramic Glass Cooktop (some models)

The ceramic cooktop has radiant surface elements located below the surface of the glass. The design of the ceramic cooktop outlines the area of the surface element underneath. **Make sure** the diameter of the pan matches the diameter of the element outline on the cooktop.

Heat is transferred up through the surface of the cooktop to the cookware. Only flat-bottom cookware should be used. The type and size of cookware, the number of surface elements in use and their settings are all factors that will affect the amount of heat that will spread to areas beyond the surface elements. The areas surrounding the elements may become **hot enough to cause burns**.



CAUTION

The cooktop should not be used as a cutting board or work surface.

Dropping heavy or hard objects on the cooktop may crack it.

Pans with rough bottoms may scratch the cooktop surface.

Placing foods directly on the smoothtop surface (without cooking utensil) is not recommended as difficult cleaning will result and foods may smoke and cause a potential fire hazard.

Never use the griddle or similar cooking sheet on the ceramic glass cooktop.



NOTE

Please read detailed instructions for ceramic glass cooktop cleaning in the **General Care & Cleaning** section and **Before You Call** checklist section of this Use and Care Guide.

About the Radiant Surface Elements

The element temperature rises gradually and evenly. As the temperature rises, the element will glow red. To maintain the selected setting, the element will cycle ON and OFF. The heating element retains enough heat to provide a uniform and consistent heat during the OFF cycle. For efficient cooking, turn OFF the element several minutes before cooking is complete. This will allow residual heat to complete the cooking process.

Types of the heating elements used

Your cooktop is equipped with radiant surface radiant elements with different wattage ratings. The ability to heat food quicker and in larger volumes increases as the element wattage increases. Depending on model, three types of heating units may be found under the ceramic glass cooktop:

- Regular (single coil) radiant elements of various diameters or shapes.
- Expandable type (double circuits) radiant elements of various diameters or shapes.
- Bridge Expandable type (triple circuits) radiant elements of various diameters or shapes.

SETTING SURFACE CONTROLS

Surface cooking settings

Use the chart to determine the correct setting for the type of food you are preparing.

Note: The size and type of cookware used will influence the setting needed for best cooking results.

Recommended Setting for Surface Element	
Setting	Type of Cooking
HIGH (HI)	Start most foods; bring water to a boil and pan broiling.
MEDIUM HIGH (7-8)	Continue a rapid boil; frying, deep fat frying.
MEDIUM (4-6)	Maintain a slow boil; thicken sauces and gravies; steaming vegetables.
MEDIUM LOW (2 - 3)	Keep foods cooking; poaching and stewing.
LOW (LO)	Keep warm, melting and simmering.

CAUTION

Do not place plastic items such as salt and pepper shakers, spoon holders or plastic wrappings on cooktop when it is in use. These items could melt or ignite. Potholders, towels or wooden spoons could catch fire if placed too close to the surface elements.

CAUTION

Do not allow aluminum foil, or ANY material that can melt to make contact with the ceramic glass cooktop. If these items melt on the cooktop they will damage the ceramic cooktop.

NOTE

Ceramic Glass Cooktop only: Radiant elements have a limiter that allows the element to cycle on and off, even at the HI setting. This helps to prevent damage to the ceramic smooth top. Cycling at the HI setting is normal and can occur if the cookware is too small for the radiant element or if the cookware bottom is not flat.

Operating the Single Surface Elements (All models)

To Operate the Single Surface Elements

1. Place correctly sized cookware on the surface element.
2. Push in and turn the surface control knob in either direction to the desired setting (Figure 1).
3. Turn the knob to adjust the setting if desired. Start most cooking operations on a higher setting and then turn to a lower setting to finish cooking. Each surface element provides a constant amount of heat at each setting. **Ceramic Glass Cooktop Only:** A glowing red surface heating area extending beyond the bottom edge of the cookware indicates the cookware is **too small** for the surface heating area.
4. **When cooking has completed, turn the surface control knob to OFF before removing the cookware.**

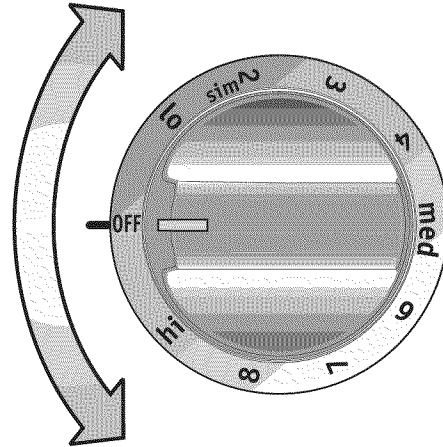

Figure 1 -Control knob shown is typical only.

NOTE

The "Hot Surface" indicator lights will glow when the element is turned on and will continue to glow after the control knob is turned to the "OFF" position. It will glow until the heating surface area has cooled sufficiently. **The glass surface may still be hot** and burns may occur if the glass surface is touched before the indicator light has turned OFF. The message may remain on even though the controls are turned OFF.

NOTE

See Recommended Setting for Surface Element table on page 6.

SETTING SURFACE CONTROLS

Indicator lights (Some models)

Some models have an indicator light for each heating unit, other models have an indicator light for each pair of heating units, also some other models have an indicator light for all heating units.

The indicator light glows as soon as a heating unit is turned on. Check if the indicator light glows when the control knob of the individual heating unit is turned on. If the knob is set to a very low temperature setting, the indicator may glow and yet, the heating unit may not be heating at all. If this happens, turn the knob to a higher setting until the heating unit comes on.

When cooking is finished, a quick glance at the indicator lights in an easy check to be sure all the control knobs have been turned OFF.

Hot Surface Indicator Light (Ceramic Glass Cooktop models only)

Some models have an indicator light located on the ceramic glass cooktop that glows as soon as the glass begins to warm up. When the heating unit is turned off, it will continue to glow as long as the glass remains warm enough to cause burns. Other models have a hot surface indicators per element arranged in a cluster. Their location is as shown in the illustration.

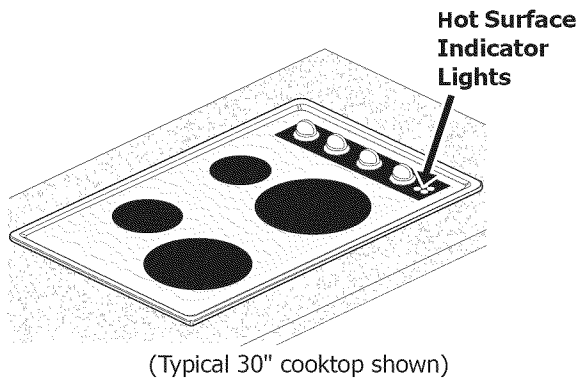

Operating the Dual Surface Radiant Element (Specific Ceramic Glass Cooktop models only)

The cooktop is equipped with one or two dual radiant surface element. Symbols around the knob are used to indicate which coil of the dual radiant element will heat. The small digits on the control knob indicate that only the inner coil will heat (Fig. 1). The large digits on the control knobs indicate that both inner and outer coils will heat (Fig. 2). You may switch from either coil setting at any time during cooking.

To Operate the Dual Surface Element

1. Place correctly sized cookware on the dual surface element.
2. Push in and turn the control knob as shown in Figure 1 for smaller cookware or in Figure 2 for larger cookware.
3. Turn the knob to adjust the setting if needed. Start most cooking operations on a higher setting and then turn to a lower setting to finish cooking. Each surface element provides a constant amount of heat at each setting. A glowing red surface heating area extending beyond the bottom edge of the cookware indicates the cookware is **too small** for the surface heating area.
4. **When cooking has completed, turn the surface control knob to OFF before removing the cookware.**

Control knobs shown are typical only.

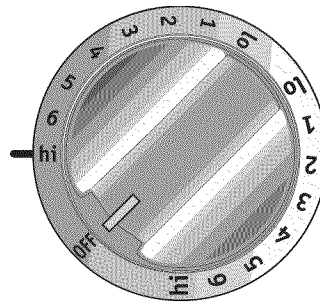

Figure 1

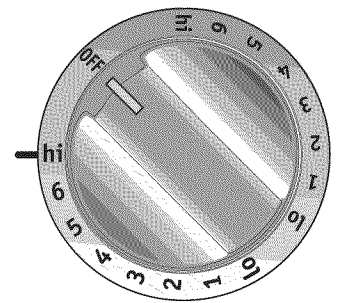
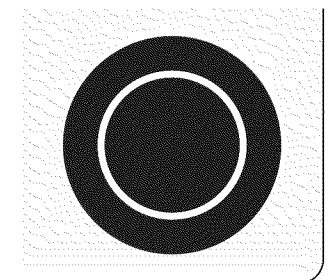
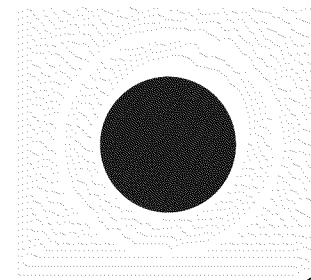

Figure 2



SETTING SURFACE CONTROLS

Operating the Warm Zone Feature (Some Ceramic Glass Cooktop models only)

To operate the warm zone

Your appliance is equipped with a warm zone. The purpose of the warm zone is to keep hot cooked foods at serving temperature. Always start with hot food. It is not recommended to heat cold food on the warm zone.

Use the warm zone to keep cooked foods hot such as: vegetables, gravies, casseroles, soups, stews, breads, pastries and oven-safe dinner plate.

All food placed on the warm zone should be covered with lid or aluminum foil to maintain quality. For best results, when warming pastries or breads, the cover should have an opening to allow moisture to escape. Do not use plastic wrap to cover food. Plastic may melt onto the surface and be very difficult to clean.

Use only dishware, utensils and cookware recommended for oven and cooktop use on the warm zone.

CAUTION

Unlike the surface elements, the warm zone will not glow red when it is hot. Always use potholders or oven mitts when removing food from the warm zone as cookware and plates will not be hot.

Indicator lights

The hot surface indicator light, located under the cooktop, will come on when the control is set and will continue to glow until the glass cooktop has cooled down to moderate level.

To Set the Warm Zone Control

1. To set the control, turn the knob to the ON position.
2. When done, turn the control to OFF. The warm zone will remain warm until the hot surface indicator light goes off.

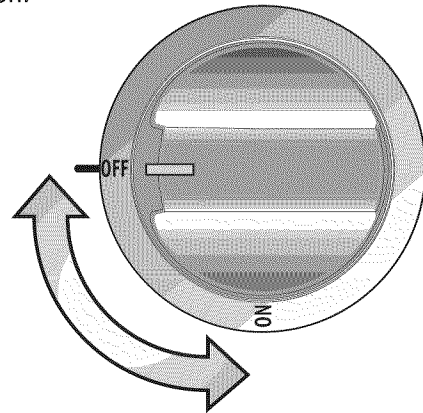
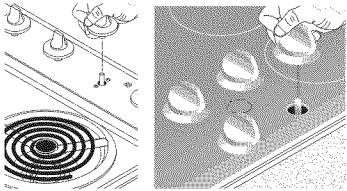
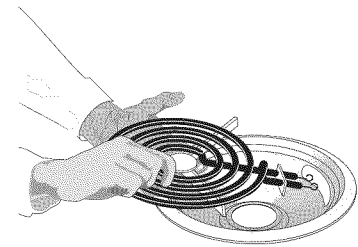

Figure 1 -Control knob shown is typical only.

Cleaning Various Parts of Your Cooktop

Before cleaning any part of the cooktop, be sure all controls are turned OFF and the cooktop is COOL. REMOVE SPILLOVERS AND HEAVY SOILING AS SOON AS POSSIBLE. REGULAR CLEANINGS NOW WILL REDUCE THE DIFFICULTY AND EXTENT OF A MAJOR CLEANING LATER.

Surfaces	How to Clean
Aluminum (Trim Pieces)	Use hot, soapy water and a cloth or paper towel. Dry with a clean cloth.
Glass, Painted and Plastic Control Knobs, Body Parts, and Decorative Trim	For general cleaning, use hot soapy water and a cloth. For more difficult soils and built-up grease, apply a liquid detergent directly onto the soil. Leave on soil for 30 to 60 minutes. Rinse with a damp cloth and dry. DO NOT use abrasive cleaners on any of these materials; they can scratch or dull the finish. Commercial glass cleaners recommended for glass cooktops may also be used.
Control Panel 	Wipe the control panel clean after each use. Before cleaning the control panel, turn all controls to OFF and remove the control knobs. To remove, pull each knob straight off the shaft. Clean using hot, soapy water and a cloth. Be sure to squeeze excess water from the cloth before wiping the panel; especially when wiping around the controls. Excess water in or around the controls may cause damage to the appliance. To replace knobs after cleaning, line up the flat sides of both the knob and the shaft; then push the knob into place.
Surface Elements and Drip Bowls 	Surface elements can be unplugged and removed to make cleaning the drip bowls easier. The surface elements clean themselves when they are turned on. Food spilled on a hot element will burn off. Food spilled on a cool element can be cleaned with a damp cloth—any remaining soil will burn off the next time the element is used. NEVER IMMERSER A SURFACE ELEMENT IN WATER. To remove surface elements and drip bowls, follow the instructions under General Cleaning . To clean drip bowls, wash in hot, soapy water or in the dishwasher. Rinse and dry while still warm. Hard-to-remove, burned-on soils can be removed by soaking the drip bowls for about 20 minutes in a slightly diluted liquid cleanser or a solution made of equal parts ammonia and water. A nylon scrubber may be used after soaking. DO NOT use abrasive cleansers or steel wool, as they will scratch the surface. Always rinse with clean water and polish, and dry with a soft cloth or paper towel. To replace drip bowls and surface elements, follow the instructions under General Cleaning .
Porcelain Enamel Cooktop	Gentle scouring with a soapy scouring pad will remove most spots. Rinse with a 1:1 solution of clear water and ammonia. If necessary, cover difficult spots with an ammonia-soaked paper towel for 30 to 40 minutes. Rinse with clean water and a damp cloth, and then scrub with a soap-filled scouring pad. Rinse and wipe dry with a clean cloth or paper towel. Remove all cleaners or the porcelain may become damaged during future heating. DO NOT use spray oven cleaners on the cooktop.
Stainless Steel, Chrome (brushed) Decorative Trim Cooktop	Cover stubborn spots with an ammonia-soaked paper towel for 30 to 40 minutes. Rinse with clean water and a cloth. A soapy, nylon mesh scouring pad may be used carefully on stainless steel; not on chrome. Cleaners made especially for stainless steel, chrome or copper are also recommended. Do not use metal-type scouring pads on brushed chrome. This could cause the brushed chrome to change to a yellowish tint. Rinse all cleaners before operating cooktop. Bluish stains may result due to heat combining with the cleaning material and they cannot be removed.
Ceramic -Glass Cooktop	See Ceramic-Glass Cooktop in this Owner's Guide.

CARE & CLEANING

Ceramic Glass Cooktop Cleaning & Maintenance

Consistent and proper cleaning is essential to maintaining your Ceramic glass cooktop.

Prior to using your cooktop for the first time, apply the recommended CERAMA BRYTE® Cleaning Creme to the ceramic surface. Clean and buff with a non abrasive cloth or pad. This will make cleaning easier when soiled from cooking. The special cooktop cleaning cream leaves a protective finish on the glass to help prevent scratches and abrasions.

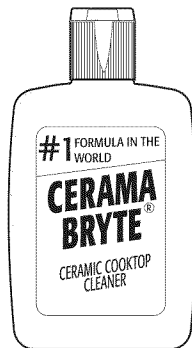

Sliding aluminum or copper clad bottom pans on the cooktop can cause metal markings on the cooktop surface. These marks should be removed **immediately** after the cooktop has cooled using the cooktop cleaning cream. Metal marks can become permanent if not removed prior to future use.

Cookware (cast iron, metal, ceramic or glass) with rough bottoms can mark or scratch the cooktop surface. **Do not slide anything metal or glass** across the cooktop. **Do not** use your cooktop as a cutting board or work surface in the kitchen. **Do not** cook foods directly on the cooktop surface without a pan. **Do not** drop heavy or hard objects on the glass cooktop, or they may crack it.

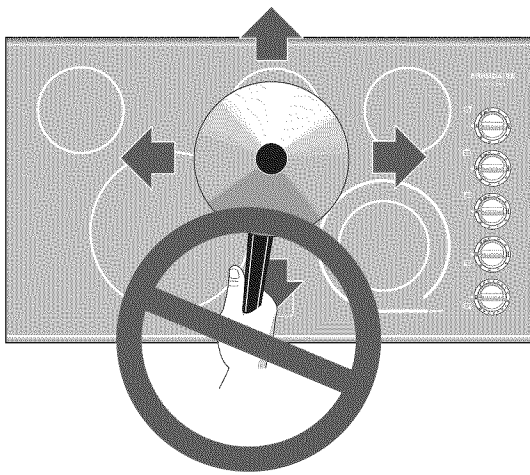

Cleaning Recommendations for the Ceramic Glass Cooktop

CAUTION

Before cleaning the cooktop, be sure the controls are turned to **OFF** and the cooktop is **COOL**.

WARNING

DO NOT use a cooktop cleaner on a hot cooktop. The fumes can be hazardous to your health, and can chemically damage the ceramic glass surface.

For light to moderate soil:

Apply a few drops of CookTop® Cleaning Creme directly to the cooktop. Use a paper towel or use a **non-abrasive** plastic type **no-scratch** pad to clean the entire cooktop surface. Make sure the cooktop is cleaned thoroughly, leaving no residue.

For heavy, burned on soil:

Apply a few drops of CookTop® Cleaning Creme directly to the soiled area. Rub the soiled area using a **non-abrasive** plastic type **no-scratch** pad, applying pressure as needed. Do not use the pad you use to clean the cooktop for any other purpose.

IMPORTANT

Damage to the ceramic glass cooktop may occur if you use an abrasive type scratch pad. Only use cleaning products that have been specifically designed for ceramic glass cooktop.

If soils remain, carefully scrape soils with a metal razor blade scraper, holding scraper at a 30 degree angle to the surface. Remove loosened soils, then apply a few drops of cleaning cream and buff surface clean.

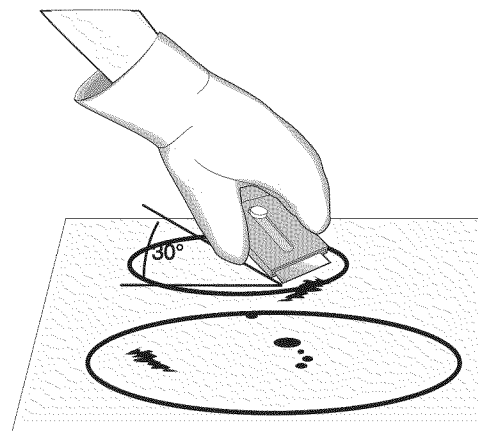

Plastic or foods with a high sugar content:

These types of soils need be removed immediately if spilled or melted onto the ceramic cooktop surface. Permanent damage (such as pitting of the cooktop surface) may occur if not removed **immediately**. After turning the surface elements OFF, use a razor blade scraper or a metal spatula with a mitt and scrape the soil from the hot surface (as illustrated). Allow the cooktop to cool, and use the same method for heavy or burned on soils.

Do not use the following on the ceramic glass cooktop:

- Do not use abrasive cleaners and scouring pads, such as metal and some nylon pads. They may scratch the cooktop, making it more difficult to clean.
- Do not use harsh cleaners, such as chlorine bleach, ammonia or oven cleaners, as they may etch or discolor the cooktop.

- Do not use dirty sponges, cloths or paper towels, as they can leave soil or lint on the cooktop which can burn and cause **Special Caution for Aluminum Foil and Aluminum Cooking Utensils**



- **Aluminum foil**

Use of aluminum foil will damage the cooktop. Do not use under any circumstances.

- **Aluminum utensils**

Since the melting point of aluminum is much lower than that of other metals, care must be taken when aluminum pots or pans are used. Pans that boil dry may permanently damage cooktop by breaking, fusing to, or marking it.

Coil Elements Cooktop Cleaning & Maintenance

Prior to cleaning the coil elements make sure they are cold and that control knobs are set at OFF.

Never immerse the coil elements in water.

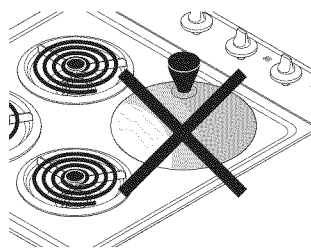

! WARNING

Never leave covers on the coil elements as they could be permanently damaged if turned on by accident.

To Remove and Replace Surface Elements and Drip Bowls (some models)

! CAUTION

Be careful not to bend terminal ends when replacing elements after cleaning.

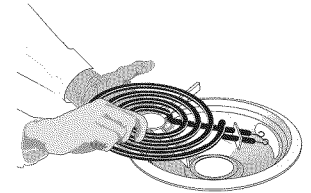

! CAUTION

Before cleaning the cooktop, be sure the controls are turned to **OFF** and the cooktop is **COOL**.

To Remove

1. Lift up edge of surface element across from terminal end just enough to clear the edge of the drip bowl.
2. Gently slide the surface element out of the terminal plug.
3. Lift the drip bowl up and out.

To Replace

1. Line up the opening of the drip bowl with the terminal plug.
2. Hold the surface element as level as possible and slide the terminal end through the opening and into the terminal plug.
3. Be sure the surface element is level to reduce the hazard of pans sliding off the element.

To Raise the Top for Cleaning

1. Grasp the sides and lift from the front. Some models may have a lift-up rod to support the top in its raised position. Lift the top only high enough to allow the support rod to fit into place, then gently lower the cooktop onto the raised rod.
2. Clean underneath using a clean cloth and hot, soapy water.
3. Gently lower the cooktop into the frame. If your model has a support rod, lower the support rod, then gently lower the cooktop into the frame.

! CAUTION

When lowering the lift-up cooktop, grasp the sides with fingertips only. Be careful not to pinch fingers. **DO NOT** drop or bend the cooktop when raising or lowering. This could damage the surface.

Care and Cleaning of Stainless Steel

Some models are equipped with stainless steel exterior parts. Special care and cleaning are **required** for maintaining the appearance of stainless parts. Refer to the **General Care & Cleaning** table for detailed cleaning instructions.

BEFORE YOU CALL (Solutions to Common Problems)

IMPORTANT

Before you call for service, review this list. It may save you time and expense. The list includes common occurrences that are not the result of defective workmanship or materials in this appliance.

OCCURRENCE	POSSIBLE CAUSE/SOLUTION
Entire cooktop does not operate.	House fuse has blown or circuit breaker has tripped. Check/reset breaker or replace fuse. If the problem is a circuit overload, have this situation corrected by a qualified electrician. Service wiring not complete. Contact installation agent or dealer. Power outage. Check house lights to be sure. Call local electric company.
Surface element does not heat.	No power to appliance. Check/reset breaker or replace fuse. If the problem is a circuit overload, or improper connection of the armored cable supplied with the appliance, have this situation corrected by a qualified electrician. Too low heat setting. Turn control to a slightly higher setting until element comes on. Incorrect control is on. Be sure to use correct control for the element to be used.
Surface element too hot or not hot enough.	Incorrect control setting. Raise or lower setting until proper amount of heat is obtained. Dial markings are an indicator of relative heat settings and will vary slightly. Lightweight or warped pans being used. Use only flat, evenly balanced, medium or heavyweight cookware. Voltage is incorrect. Be sure appliance is properly connected to the specified power source. Use only flat bottom, evenly balanced, medium or heavyweight cookware. Pans having a flat bottom heat better than warped pans. Cookware material affects heating. Heavy and medium weight pans heat evenly. Because lightweight pans heat unevenly, foods may burn easily.
Food not heating evenly.	Improper cookware. Select flat-bottomed cookware of a proper size to fit element. Incorrect control setting. Raise or lower setting until proper amount of heat is obtained.
Scratches or abrasions on ceramic glass cooktop surface.	Coarse particles (such as salt or sand) are between cooktop and utensil. Be sure cooktop surface and bottom of utensils are clean before use. Small scratches do not affect cooking and will become less visible with use. Cleaning materials not recommended for glass ceramic cooktop have been used. See Ceramic-Glass Cooktop section in this Owner's Guide. Cookware with rough bottom has been used. Use flat-bottomed, smooth utensils. See Selecting Surface Cooking Utensils in this Owner's Guide.
Metal marks on ceramic glass cooktop surface.	Sliding or scraping of metal utensils on cooktop surface. Do not slide metal utensils on cooktop surface. Use a mildly abrasive cleanser to remove marks.

BEFORE YOU CALL (Solutions to Common Problems)

OCCURRENCE	POSSIBLE CAUSE/SOLUTION
Brown streaks and specks on ceramic glass cooktop surface.	<p>Boilovers have cooked onto surface. Use razor blade scraper to remove soil. See Ceramic-Glass Cooktop section in this Owner's Guide.</p> <p>Cleaning materials not recommended for ceramic-glass cooktop have been used. Use recommended cleaners and cleaning method. See Ceramic-Glass Cooktop section in this Owner's Guide.</p>
Areas of discoloration on ceramic glass cooktop surface.	<p>Mineral deposits from water and food. Wet surface with water and sprinkle on a cooktop cleaning creme. Scrub with a clean damp paper towel until the stain disappears. Wipe remaining paste away, then apply a small amount of cooktop cleaning creme and polish with a clean paper towel. Use cookware with clean, dry bottoms. See Ceramic-Glass Cooktop section in this Owner's Guide.</p>
Drip bowls are pitting or rusting.	<p>Foods with acids, such as tomatoes, if allowed to stand in/on bowls will cause corrosion. Remove and wash drip bowls as soon as possible after a spillover.</p> <p>Normal environment. Houses along sea coast are exposed to salt air. Protect bowls as much as possible from direct exposure to salt air.</p>
Drip bowls turning color or distorted out of shape.	<p>Bottom surface of cookware extends beyond surface elements and touches cooktop surface. This can cause high enough temperatures to discolor the drip bowls. DO NOT use cookware of this type. Pan sizes should be matched to the size of the element. Replacement drip bowls may be purchased from your dealer.</p> <p>Surface elements not seated properly in terminal. Turn control to OFF. Be sure surface element is COOL. Lift out surface element properly, following instructions under General Cleaning.</p> <p>Incorrect control is on. Be sure the correct control for the element to be used.</p>

MAJOR APPLIANCE WARRANTY

Your appliance is covered by a one year limited warranty. For one year from your original date of purchase, Electrolux will pay all costs for repairing or replacing any parts of this appliance that prove to be defective in materials or workmanship when such appliance is installed, used and maintained in accordance with the provided instructions.

Exclusions **This warranty does not cover the following:**

- 1 Products with original serial numbers that have been removed, altered or cannot be readily determined.
- 2 Product that has been transferred from its original owner to another party or removed outside the USA or Canada.
- 3 Rust on the interior or exterior of the unit.
- 4 Products purchased "as-is" are not covered by this warranty.
- 5 Food loss due to any refrigerator or freezer failures.
- 6 Products used in a commercial setting.
- 7 Service calls which do not involve malfunction or defects in materials or workmanship, or for appliances not in ordinary household use or used other than in accordance with the provided instructions.
- 8 Service calls to correct the installation of your appliance or to instruct you how to use your appliance.
- 9 Expenses for making the appliance accessible for servicing, such as removal of trim, cupboards, shelves, etc., which are not a part of the appliance when it is shipped from the factory.
- 10 Service calls to repair or replace appliance light bulbs, air filters, water filters, other consumable, or knobs, handles, or other cosmetic parts.
- 11 Surcharges including, but not limited to, any after hour, weekend, or holiday service calls, tolls, ferry trip charges, or mileage expense for service calls to remote areas, including the state of Alaska.
- 12 Damages to the finish of appliance or home incurred during installation, including but not limited to floors, cabinets, walls, etc.
- 13 Damages caused by: services performed by unauthorized service companies; use of parts other than genuine Electrolux parts or parts obtained from persons other than authorized service companies; or external causes such as abuse, misuse, inadequate power supply, accidents, fires, or acts of God.

DISCLAIMER OF IMPLIED WARRANTIES; LIMITATION OF REMEDIES

Customer's sole and exclusive remedy under this limited warranty shall be product repair or replacement as provided herein. Claims based on implied warranties, including warranties of merchantability or fitness for particular purpose, are limited to one year or the shortest period allowed by law, but not less than one year. Electrolux shall not be liable for consequential or incidental damages such as property damage and incidental expenses resulting from any breach of this written limited warranty or any implied warranty. Some states and provinces do not allow the exclusion or limitation of incidental or consequential damages, or limitations on the duration of implied warranties, so these limitations or exclusions may not imply to you. This written warranty gives you specific legal rights. You may also have other rights that vary from state to state.

**If You
Need
Service**

Keep your receipt, delivery slip, or some other appropriate payment record to establish the warranty period should service be required. If service is performed, it is in your best interest to obtain and keep all receipts. Service under this warranty must be obtained contacting Electrolux at the addresses or phone numbers below.

This warranty only applies in the USA and Canada. In the USA, your appliance is warranted by Electrolux Major Appliances North America, a division of Electrolux Home Products, Inc. In Canada, your appliance is warranted by Electrolux Canada Corp. Electrolux authorizes no person to change or add to any obligations under this warranty. Obligations for service and parts under this warranty must be performed by Electrolux or an authorized service company. Product features or specifications as described or illustrated are subject to change without notice.

USA
1.800.944.9044
Electrolux Major Appliances
North America
P.O. Box 212378
Augusta, GA 30907



Canada
1.800.265.8352
Electrolux Canada Corp.
5855 Terry Fox Way
Mississauga, Ontario, Canada
L5V 3E4