

# INSTALLATION INSTRUCTIONS

## DOOR LOCK/SWITCH KIT - 131763202

This kit replaces the Bitron door lock/switch with a USCC door lock/switch.

This kit contains the following parts:

- (1) Door Lock/Switch
- (1) Door Strike
- (1) Adapter Harness
- (1) Tube Adhesive
- (6) Plastic Harness Ties
- (1) Installation Instructions

1. Disconnect the washer from the electrical power source.
2. Remove the front service panel.
3. Open the door, remove the two screws securing the door strike to the door and remove the strike.
4. Install the new door strike using the screws removed in step 3.
5. Using a razor blade or a sharp putty knife, separate the bellows from the front panel at the 2, 3, & 4 o'clock positions.
6. Remove the screws securing the old door lock/switch to the front panel.
7. Remove the wires from the old door lock/switch and remove the switch.
8. Remove the nine pin plug from the speed control unit (SCU).
9. **NOTE:** If the washer serial number prefix is **XC703** and above, go to step 13. If the washer serial number is below **XC703**, proceed with instructions 10 through 12.

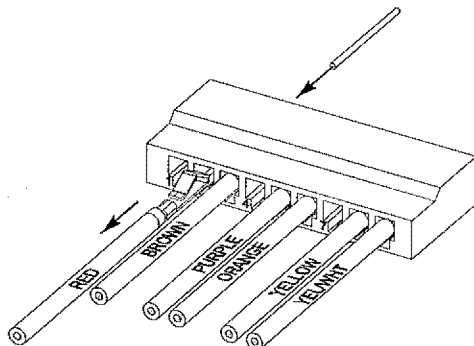

Figure 1

10. In slot number 2, insert a small wire (paper clip) between the locking tab of the red wire terminal and the housing. Note: The locking tab is located in the small rectangular slot below the terminal. **DO NOT** push down on the contact prongs on the wire terminal.

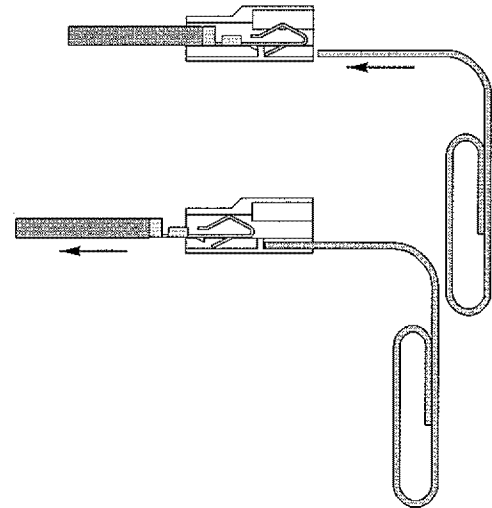

Figure 2

11. Pull the red wire out of the slot.
12. Insert the red wire into slot number 4 until the terminal clicks into the housing. Gently pull on the wire to ensure it is fully seated in the housing..

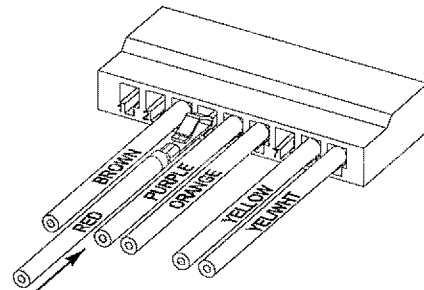
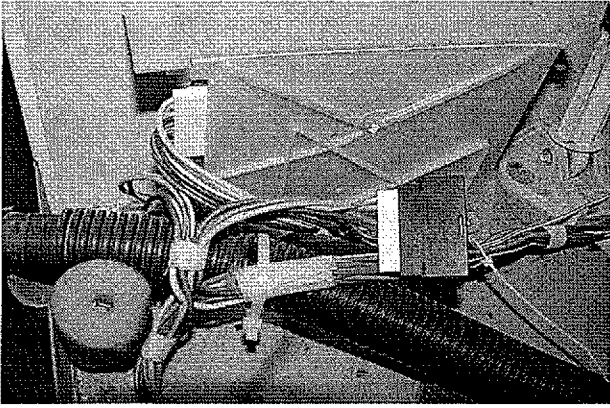
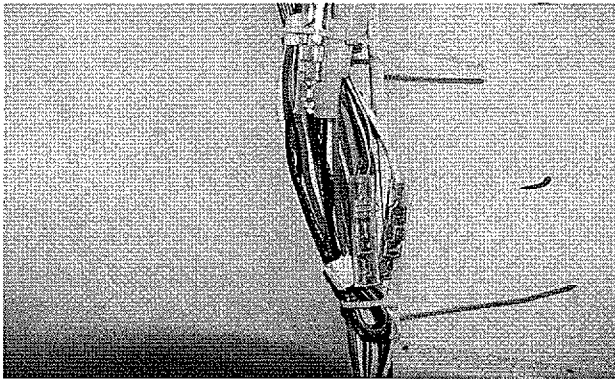

Figure 3

13. Remove the connector plug from the pump. **NOTE:** Removing the pump cover on pumps with an external cooling fan will make it easier to access the connector plug.
14. Connect the nine pin plug from the adapter harness to the to the SCU.



15. Connect the nine pin plug removed in step 8 to the connector board on the adapter harness.
16. Dress the adapter harness along side of the present washer harness as shown.



17. Connect the green connector plug from the adapter harness to the pump.
18. Connect the green connector plug from the washer harness to the connector on the adapter harness.
19. Matching color per color, connect the door switch wires from the washer harness to the connectors in the adapter harness.
20. Connect the adapter harness to the new door lock/switch and install the switch in the washer cabinet using the screws removed in step 6.

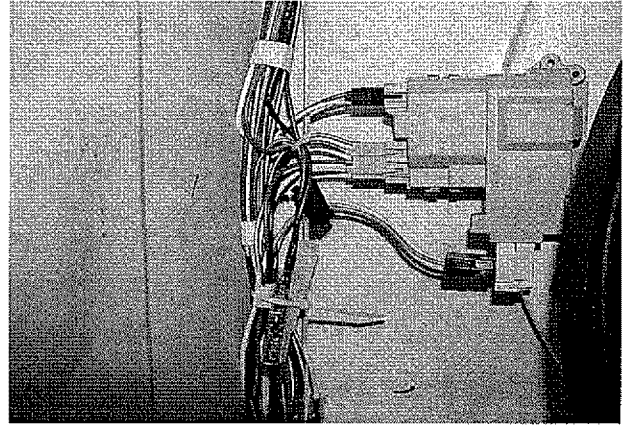

21. Using the plastic harness ties, attach the adapter harness to the washer harness. Dress the harness in such a manner that it will not interfere with any moving parts or cause any noise when the washer is in operation.

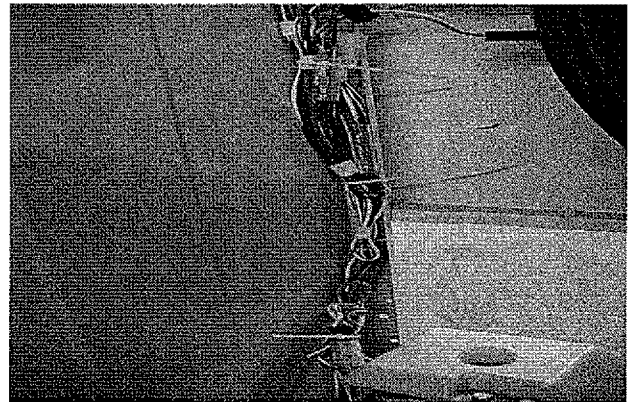

22. Connect the washer to the electrical power source and test for proper operation. Close the door, place the timer to the final spin position, and start the timer. When the machine starts its fast ramp up to the higher spin speed, turn the timer off, then quickly pull on the door end verify the door is locked. If the door opens, recheck the connections in steps 9 through 12.
23. Using the tube of adhesive, glue the bellows to the front panel at the 2, 3, & 4 o'clock positions.
24. Install the front service panel.