

# Owner's Manual

Bottom-Freezer  
Built-In Refrigerators

49-60423-2

06-09 JR

[monogram.com](http://monogram.com)

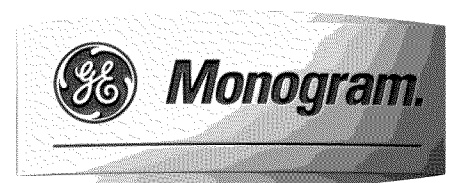

*Introduction*

Your new Monogram refrigerator makes an eloquent statement of style, convenience and kitchen planning flexibility. Whether you chose it for its purity of design, practical storage arrangements or assiduous attention to detail—or for all of these reasons—you'll find that your Monogram refrigerator's superior blend of form and function will delight you for years to come.

The Monogram refrigerator was designed to provide the flexibility to blend in with your kitchen cabinetry. Decorative door insert panels allow it to match your kitchen cabinets or blend with your kitchen decor.

Since the Monogram refrigerator is a built-in product, custom panels are required on the front of the Monogram refrigerator. Consult your kitchen designer or cabinetmaker for your customized look.

The information on the following pages will help you operate and maintain your refrigerator properly.

If you have any other questions, visit our Website at: [monogram.com](http://monogram.com)

*Contents*

**Consumer Services**

Important Phone Numbers .....19  
 Model and Serial Numbers .....3  
 Performance Data Sheet .....17  
 Problem Solver .....15, 16  
 Product Registration .....3  
 Safety Instructions .....4-7  
 State of California  
 Water Treatment Device Certificate .....18  
 Warranty .....Back Cover

**Care and Cleaning**

Cleaning—Outside and Inside .....13  
 Light Bulb Replacement .....14  
 Master Light Switch .....14  
 Vacation .....14

**Operating Instructions**

Automatic Icemaker .....10  
 Sabbath Mode Product Kit, ZSAB1 .....10  
 Shelves .....12  
 Storage Pans .....11  
 Temperature Controls .....8  
 Water Filter Cartridge .....9

*Before using your refrigerator*

Read this manual carefully. It is intended to help you operate and maintain your new refrigerator properly.

Keep it handy for answers to your questions.

If you don't understand something or need more help, there is a list of toll-free consumer service numbers included in the back section of this manual.

**OR**

Visit our Website at: [monogram.com](http://monogram.com)

*Write down the model & serial numbers*

You'll see them on a label inside the fresh food compartment under the storage drawers on the right side.

**Before sending in this card, please write these numbers here:**

Model Number

Serial Number

Use these numbers in any correspondence or service calls concerning your refrigerator.

*If you received a damaged refrigerator*

Immediately contact the dealer (or builder) that sold you the refrigerator.

*Save time & money*

**Before you request service, check the Problem Solver in the back of this manual.**

It lists causes of minor operating problems that you can correct yourself.

*If you need service*

**To obtain service, see the Consumer Services page in the back of this manual.**

We're proud of our service and want you to be pleased. If for some reason you are not happy with the service you receive, here are steps to follow for further help.

**For customers in the USA:**

FIRST, contact the people who serviced your appliance. Explain why you are not pleased. In most cases, this will solve the problem.

NEXT, if you are still not pleased, write all the details—including your phone number—to:

Manager, Customer Relations  
GE Appliances  
Appliance Park  
Louisville, KY 40225

**For customers in Canada:**

FIRST, contact the people who serviced your appliance. Explain why you are not pleased. In most cases, this will solve the problem.

NEXT, if you are still not pleased, write all the details—including your phone number to:

Manager, Consumer Relations  
Mabe Canada Inc.  
1 Factory Lane, Suite 310  
Moncton, N.B. E1C 9M3

# IMPORTANT SAFETY INSTRUCTIONS

---

## READ AND SAVE THESE INSTRUCTIONS

**⚠️ WARNING:** When using this appliance, always exercise basic safety precautions, including the following:

- **Use this appliance only for its intended purpose** as described in this Owner's Manual.
- **This refrigerator must be properly installed in accordance with the Installation Instructions before it is used.**
- **Do not allow children to climb, stand or hang on the shelves in the refrigerator.** They could damage the refrigerator and seriously injure themselves.
- **Do not touch the cold surfaces in the freezer compartment when hands are damp or wet.** Skin may adhere to these extremely cold surfaces.
- **Do not store or use gasoline or other flammable vapors and liquids in the vicinity of this or any other appliance.**
- **In refrigerators with automatic icemakers,** avoid contact with moving parts of the ejector mechanism, or with the heating element located on the bottom of the icemaker. Do not place fingers or hands on the automatic

icemaking mechanism while the refrigerator is plugged in.

- **Keep fingers out of the "pinch point" areas:** clearances between the doors and between the doors and cabinet are necessarily small. Be careful closing doors when children are in the area.
- **Unplug your refrigerator before cleaning and making repairs.**

**NOTE:** We strongly recommend that any servicing be performed by a qualified individual.

- **Before replacing a burned-out light bulb,** set the Master Light switch in the OFF position to turn off the lights in order to avoid contact with a live wire filament. (A burned-out light bulb may break when being replaced.)

**NOTE:** Setting the refrigerator temperature controls to OFF does not remove power to the light circuit.

- **Do not refreeze frozen foods which have thawed completely.**

---

## ⚠️ DANGER: RISK OF CHILD ENTRAPMENT

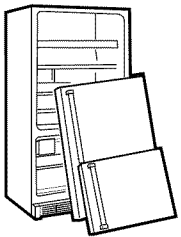

Child entrapment and suffocation are not problems of the past. Junked or abandoned refrigerators are still dangerous...even if they will sit for "just a few days." If you are getting rid of your old refrigerator, please follow the instructions below to help prevent accidents.

### **Before You Throw Away Your Old Refrigerator or Freezer:**

- Take off the doors.
- Leave the shelves in place so that children may not easily climb inside.

---

## REFRIGERANTS

All refrigeration products contain refrigerants, which under federal law must be removed prior to product disposal. If you are getting rid of an old refrigeration product, check with the company handling the disposal about what to do.

# INSTRUCTIONS IMPORTANTES DE SÉCURITÉ

---

## LIRE ET CONSERVER CES INSTRUCTIONS

**⚠ AVERTISSEMENT :** Lorsque vous utilisez le réfrigérateur, observez toujours certaines précautions de base, notamment :

- **N'utilisez le réfrigérateur que pour son usage prévu**, comme décrit dans le présent manuel.
- **Installez le réfrigérateur conformément aux directives d'installation avant de l'utiliser.**
- **Ne laissez pas les enfants grimper, s'asseoir, se tenir debout ni se pendre aux clayettes du réfrigérateur.** Ils pourraient endommager le réfrigérateur et se blesser gravement.
- **Une fois le réfrigérateur en marche, ne touchez pas les surfaces froides du congélateur, surtout si vous avez les mains humides ou mouillées :** la peau risque d'adhérer à ces surfaces très froides.
- **N'entreposez et n'utilisez pas d'essence ou autres vapeurs et liquides inflammables à proximité de cet appareil ou de tout autre appareil électroménager.**
- **Pour les réfrigérateurs dotés d'une machine à glaçons automatique, évitez le contact avec les pièces mobiles du mécanisme éjecteur, ou avec l'élément chauffant situé à la partie inférieure de la machine à glaçons.** Ne posez pas les doigts ou les mains sur le mécanisme

de la machine à glaçons pendant que le réfrigérateur est branché.

- **Éloignez les doigts des parties du réfrigérateur où l'on peut facilement se pincer :** les espaces entre les portes et entre les portes et les placards sont toujours étroits. Soyez prudent lorsque vous fermez les portes de l'appareil en présence des enfants.
- **Débranchez votre réfrigérateur avant de le nettoyer et de le réparer.**

**REMARQUE :** Nous vous recommandons vivement de confier toute réparation à un technicien qualifié.

- **Avant de remplacer une ampoule grillée,** mettez le commutateur de lumière principale en position OFF (arrêt) pour éteindre la lumière afin d'éviter tout contact avec un fil sous tension. (Une ampoule grillée peut se briser pendant l'opération).

**REMARQUE :** Lorsque vous placez les commandes de température du réfrigérateur sur OFF (arrêt), l'alimentation électrique de l'ampoule n'est pas coupée.

- **Ne faites PAS recongeler des aliments surgelés qui ont complètement dégelé.**

---

## ⚠ DANGER: RISQUES POUR LES ENFANTS

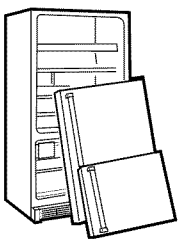

Les enfants pris au piège ou morts d'asphyxie sont toujours d'actualité. Les appareils de réfrigération abandonnés sont toujours aussi dangereux, même si on n'attend que "quelque jours" pour s'en débarrasser. Si vous ne gardez pas votre ancien appareil, veuillez suivre les directives ci-dessous afin de prévenir les accidents.

**Avant de vous débarrasser de votre vieux appareil de réfrigération :**

- Démontez les portes.
- Laissez les clayettes en place afin d'empêcher les enfants de grimper à l'intérieur.

---

## RÉFRIGÉRANTS

Tous les appareils de réfrigération contiennent des réfrigérants qui, conformément aux lois fédérales, doivent être enlevés avant toute élimination de l'appareil. Si vous vous débarrassez de vieux appareils de réfrigération, vérifiez, auprès de la société qui s'occupe de leur élimination, ce que vous devez faire.

# IMPORTANT SAFETY INSTRUCTIONS

---

## HOW TO CONNECT ELECTRICITY

**Do not, under any circumstances, cut or remove the third (ground) prong from the power cord. For personal safety, this appliance must be properly grounded.**

The power cord of this appliance is equipped with a 3-prong (grounding) plug which mates with a standard 3-prong (grounding) wall outlet to minimize the possibility of electric shock hazard from this appliance.

Have the wall outlet and circuit checked by a qualified electrician to make sure the outlet is properly grounded.

Where a standard 2-prong wall outlet is encountered, it is your personal responsibility and obligation to have it replaced with a properly grounded 3-prong wall outlet.

Use of a GFI (Ground Fault Interruptor) is not recommended for the refrigerator outlet.

The refrigerator should always be plugged into its own individual electrical outlet which has a voltage rating that matches the rating plate.

This provides the best performance and also prevents overloading house wiring circuits which could cause a fire hazard from overheated wires.

**DO NOT USE AN ADAPTER PLUG TO CONNECT THE REFRIGERATOR TO A 2-PRONG OUTLET.**

**DO NOT USE AN EXTENSION CORD WITH THIS APPLIANCE.**

Never unplug your refrigerator by pulling on the power cord. Always grip plug firmly and pull straight out from the outlet.

Repair or replace immediately all power cords that have become frayed or otherwise damaged. Do not use a cord that shows cracks or abrasion damage along its length or at either end.

When moving the refrigerator away from the wall, be careful not to roll over or damage the power cord.

Refer to the Installation Instructions for particular electrical system specifications for this refrigerator.

## SAVE THESE INSTRUCTIONS

# INSTRUCTIONS IMPORTANTES DE SÉCURITÉ

---

## RACCORDEMENT ÉLECTRIQUE

**Ne coupez ni retirez en aucun cas la troisième broche (mise à la terre) de la fiche du cordon d'alimentation. Pour votre sécurité, cet appareil doit être correctement mis à la terre.**

Le cordon d'alimentation de cet appareil est muni d'une fiche à 3 broches (mise à la terre) qui se branche dans une prise murale ordinaire à 3 alvéoles (mise à la terre) pour réduire au minimum les risques de chocs électriques.

Faites examiner la prise de courant et le circuit par un électricien qualifié pour vous assurer que la prise est correctement mise à la terre.

Si la prise murale est du type standard à 2 alvéoles, il vous incombe de la faire remplacer par une prise à 3 alvéoles correctement mise à la terre.

L'utilisation d'un interrupteur de défaut à la terre (GFI—Ground Fault Interruptor) n'est pas recommandé pour la prise de courant du réfrigérateur.

Le réfrigérateur doit toujours être branché dans sa propre prise de courant, dont la tension nominale est identique à celle indiquée sur la plaque signalétique.

Cette précaution est recommandée pour garantir un rendement optimum et éviter une surcharge des circuits électriques de la résidence, ce qui pourrait créer un risque d'incendie par surschauffe des fils.

**N'UTILISEZ PAS UNE FICHE D'ADAPTATION POUR RACCORDER LE RÉFRIGÉRATEUR DANS UNE PRISE MURALE À 2 ALVÉOLES.**

**N'UTILISEZ PAS DE CORDONS PROLONGATEURS AVEC CET APPAREIL.**

Ne débranchez jamais l'appareil en tirant le cordon d'alimentation. Saisissez fermement la fiche du cordon et tirez droit pour la retirer de la prise.

Réparez ou remplacez immédiatement tout cordon effiloché ou endommagé. N'utilisez pas un cordon fendillé ou présentant des signes d'usure.

Lorsque vous déplacez l'appareil du mur, faites attention de ne pas la faire rouler sur le cordon d'alimentation afin de ne pas l'endommager.

Voyez les Instructions d'Installation pour les spécifications particuliers du système d'électrique de cet appareil.

## CONSERVEZ CES DIRECTIVES

### Temperature controls



Preset Settings

Allow 24 hours to reach these preset temperatures.

The temperature display shows the actual temperature of the freezer and fresh food compartments. The actual temperature will vary from the set temperature based on factors such as frequency of door opening, amount of food, defrost cycling and room temperature.

**NOTE:** Frequent door openings or door left open for periods of time may increase the internal temperature of the freezer and fresh food compartments temporarily.

To turn off the cooling system in both the freezer and fresh food compartments, press either + pad until both displays show **OFF**.

To turn the cooling system on, press either - pad. The preset temperatures of 0°F and 37°F will appear in the display.

To check the current temperature setting for the fresh food or freezer compartment, press the + or - pad once. After 5 seconds, the display will return to the actual temperature.

To change the temperature settings, press the + or - pads to desired temperature set point for fresh food and freezer separately. Allow 24 hours for the refrigerator to reach the temperature you have set.

#### Temperature Ranges

	Low	High
Fresh Food	34°F 1°C	45°F 7°C
Freezer	-6°F -21°C	+6°F -14°C

**NOTE:** Setting the controls to **OFF** stops cooling, but **does not** shut off electrical power to the refrigerator.

### Changing display temperatures from °F to °C

To change the temperature display between Fahrenheit and Celsius, press the **Temp Display °C/°F**.

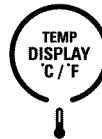

### Door alarm

To turn the Door Alarm feature on, press the pad once. The **ACTIVE** light will come on. To turn it off, press the pad again.

When the **DOOR ALARM** is active, the alarm will flash and beep if you keep the door open for more than 2 minutes.

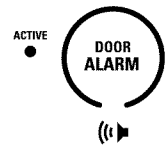



## Water filter cartridge

The water filter cartridge is located behind the grille panel at the top of the refrigerator. Lift up the panel to access the cartridge.

### When to Replace the Filter:

The filter cartridge is designed to filter 300 gallons of water (lasting approximately 12 months). It should be replaced when the status light turns red or if you notice the ice cubes getting hollow or small.



### Installing the Filter Cartridge:

- 1 Raise the grille panel at the top of the refrigerator.
- 2 Remove the old cartridge by slowly turning it to the left. A small amount of water may drip down. **Do not** pull down on the cartridge.
- 3 Fill the new cartridge with water from the tap to allow for better flow immediately after installation.
- 4 Line up the arrow on the cartridge with the center of the holder. **Do not** push it up into the holder.
- 5 Slowly turn it to the right until the cartridge stops. It will rotate about 1/4 turn. **DO NOT OVERTIGHTEN.**

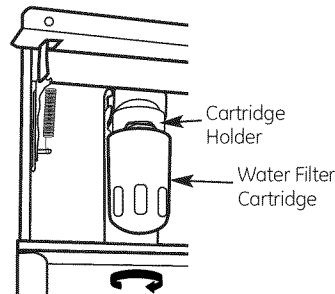

Slowly turn it to the right. Do not overtighten.

**IMPORTANT NOTE:** Remove the water filter to immediately stop any water leak from the icemaker/Dispenser system. The water filter cartridge holder (bracket) acts as a cut-off valve when the filter is removed and will prevent further leaking.

### To Reset the Filter Status Light:

Press and hold the **RESET** pad for 3 seconds.

### Filter Bypass Plug:

You **must** use the filter bypass plug:

- a) if you have a household reverse osmosis water system and/or another form of home water filtration system
- b) if a replacement filter is not available.

The bypass plug and the mini-manual are located in the top machine compartment.

The icemaker will not operate without the filter or filter bypass plug installed.

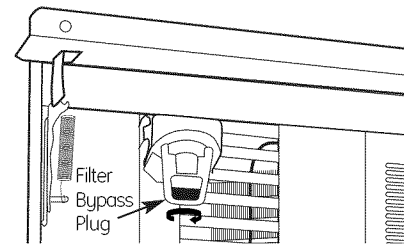

### Replacement filters:

To order additional filter cartridges in the United States, visit our Website at [GEAppliances.com](http://GEAppliances.com), or call GE Parts and Accessories, 800.626.2002.

MWF

Suggested Retail \$38.95–47.95

Customers in Canada should consult the yellow pages for the nearest Mabe Service Center.

Call 1-800-444-1845 to schedule a service call to repair the leak.

### Automatic icemaker

#### A newly-installed refrigerator may take 12–24 hours to begin making ice.

The icemaker will produce seven cubes per cycle—approximately 15 cycles in a 24-hour period.

If the refrigerator is operated before the water connection is made to the icemaker, set the power switch to **O (off)**.

When the refrigerator has been connected to the water supply, set the power switch to **I (on)**.

Throw away the first full bucket of ice to allow the water line to clear.

Be sure nothing interferes with the sweep of the feeler arm.

When the bin fills to the level of the feeler arm, the icemaker will stop producing ice.

It is normal for several cubes to be joined together.

If ice is not used frequently, old ice cubes will become cloudy, taste stale and shrink.

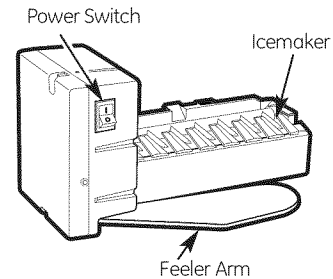

If ice cubes get stuck in the icemaker, set the power switch to **O (off)** and remove the cubes. Set the power switch to **I (on)** to restart the icemaker.

After the icemaker has been turned on again, there will be a delay of about 45 minutes before the icemaker resumes operations.

The ice bucket is conveniently located in the upper freezer basket. Occasionally ice cubes may spill out of the bucket. Should the ice cubes fall to the bottom of the freezer, they are of no concern; they will sublimate away harmlessly.

**NOTE:** In homes with low water pressure, you may hear the icemaker water valve cycle on several times when making one batch of ice.

### Sabbath Mode Product Kit (available at extra cost)

The Sabbath Mode Product Kit was designed for use on the Jewish Sabbath and Holidays. The Sabbath Mode feature makes it possible for observant Jews to refrigerate and freezer food during the duration of the holiday.

The Sabbath Mode feature can be set to override typical reactions to actions in your refrigerator. While in the Sabbath Mode, your refrigerator will still operate normally. However, the refrigerator will not respond to your actions.

While in the Sabbath Mode, you may notice the fan running when the door is opened; however, this is not a result of your actions. The fan will operate at random times. The defrost heater will continue to defrost the refrigerator and freezer and will be activated on a timer. The defrost heater will not defrost as a result of door openings or any consumer actions.

**ON/OFF**—To activate, raise the top grille panel, set the Sabbath Mode switch to the **ON** position. A green LED light will be visible below the Sabbath Mode Kit switch. The green light may not be visible with the top grille panel closed. If you are not sure if the unit is in Sabbath Mode, raise the grille panel and see if the green light is on.

**DISPLAYS, ALARMS and LIGHTS**—The main temperature control, door alarms and lights will be disabled.

**ICEMAKER**—The icemaker will be disabled.

This Sabbath Mode Product Kit can be purchased from your local appliance dealer. The ZSAB1 Kit is designed for use with Monogram Built-In Refrigerators: 36", 42" and 48" Side-by-Side models manufactured after February 2004 and 36" Bottom-Freezer models manufactured after April 2004. To locate your nearest dealer, visit our web site [monogram.com](http://monogram.com) or call 1.800.626.2000. In Canada, call 1.800.561.3344. Order Kit # ZSAB1.

**NOTE:** The Sabbath Mode Product Kit must be installed by a qualified service technician.

## Storage Pans

### Bottom Freezer Refrigerator

#### Sealed snack pans

The sealed snack pans retain high humidity for the convenient storage of lunch meats and cheese, hors d'oeuvres, spreads and snacks.

Make sure the pans are closed completely to maintain the correct humidity level.

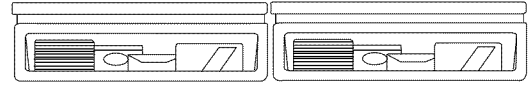

These pans must be fully closed before closing the fresh food compartment door.

#### Adjustable humidity pans

These drawers have individual, adjustable humidity controls that let you control the amount of cold air entering the drawers.

Make sure the drawers are closed completely to maintain the correct humidity level.

**Slide the control all the way to the High** setting and the drawer provides **higher humidity levels** recommended for most leafy vegetables.

**Slide the control all the way to the Low** setting and the drawer provides **lower humidity levels** recommended for most fruits.

Excess water that may accumulate on the bottom of the drawers should be emptied and the drawers wiped dry.

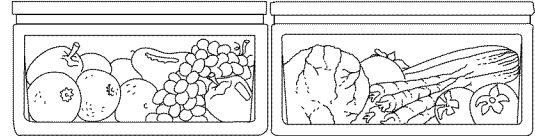

These pans must be fully closed before closing the fresh food compartment door.

#### Pan removal

**To remove a pan**, pull it out and lift the front up and out of the wire holder. Lift the back up and out.

**To replace a pan**, place the back of the pan in the wire holder, making sure the indentations at the back of the pan fit into the back of the wire holder. Then lower the front of the pan into the wire holder. Press firmly on the top of the pan until it snaps into place.

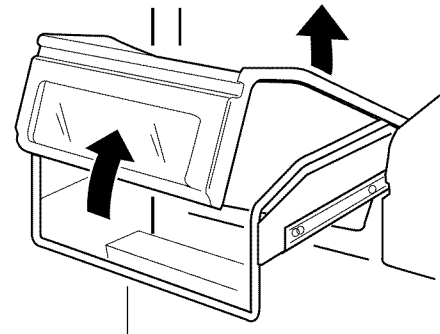

#### High humidity storage

Storing unwrapped foods in a high humidity environment keeps foods fresh by retaining the natural moisture content of foods such as:

- Artichokes
- Asparagus
- Beets, topped
- Blueberries
- Carrots
- Celery
- Cherries
- Corn
- Cucumbers
- Currants
- Greens, leafy
- Lettuce
- Parsley
- Peas, green
- Radishes
- Rhubarb
- Spinach
- Tomatoes, ripe

As in any refrigerated storage area, it is recommended that foods with strong odors be stored wrapped—foods such as:

- Broccoli
- Brussels sprouts
- Cabbage
- Cauliflower
- Green onions
- Parsnips
- Turnips

#### Low humidity storage

Lower humidity storage should be used for items such as:

- Apples
- Apricots
- Grapes
- Mushrooms
- Nectarines
- Oranges
- Papayas
- Peaches
- Pears
- Pomegranates
- Mangoes
- Raspberries
- Squash, summer
- Strawberries
- Tangerines

### Adjustable shelves in the fresh food compartment

Tempered glass shelves in the fresh food compartment enable you to make efficient shelf arrangements to fit your family's food storage needs.

**To remove shelves:** Tilt shelf up at front, then lift it up and out of tracks on rear wall of refrigerator.

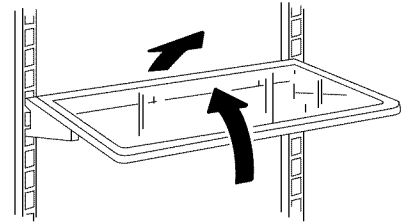

**To replace shelves:** Select desired shelf height. With shelf front raised slightly, engage top lugs in tracks at rear of cabinet. Then lower front of shelf until it locks into position.

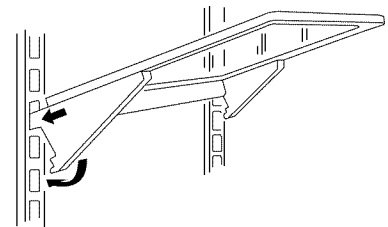

### Door bins

Some door bins are adjustable and can be moved up and down to meet your storage needs.

**NOTE:** The deeper door bins must be placed at the bottom of the door only.

**To remove:** Lift the bin up and slide it toward you.

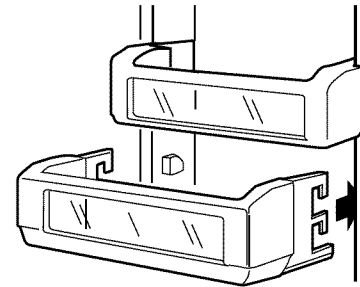

### Freezer drawer with basket

Inside the freezer drawer is a wire slide-out freezer basket.

This basket can be pushed back so items on the bottom of the freezer drawer can be reached.

**To remove the basket:**

- 1 Open the freezer drawer.
- 2 Lift up the back of the basket, then slide the basket back until it clears the front hooks.

**Ensure that the freezer drawer is fully closed after each opening to maintain normal operating performance.**

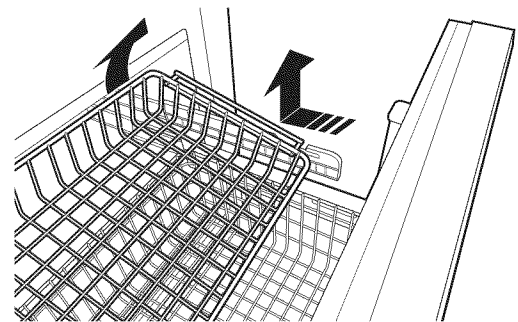

To remove basket

#### Cleaning outside

**The door handles and trim.** Clean with a cloth dampened with soapy water. Dry with a soft cloth.

**Keep the outside clean.** Wipe with a clean cloth lightly dampened with mild liquid dish detergent. Dry with a clean, soft cloth.

Do not wipe the refrigerator with a soiled dish cloth or wet towel. These may leave a residue that can erode the paint. Do not use scouring pads, powdered cleaners, bleach or cleaners containing bleach because these products can scratch and weaken the paint finish.

**The stainless steel panels and door handles** (on some models) should be regularly cleaned with a commercially available stainless steel cleaner such as *Stainless Steel Magic*™

*Stainless Steel Magic* and the Monogram polishing cloth are available to preserve and protect the fine finish, through GE Parts and Accessories, 800.626.2002, or [GEAppliances.com](http://GEAppliances.com).

For *Stainless Steel Magic*, order part number WX10X15. For Monogram polishing cloth, order part number WX72X10001.

Do not use appliance wax or polish on the stainless steel.

#### Cleaning inside

**To help prevent odors**, leave an open box of baking soda in the refrigerator and freezer compartments.

**Turn off power at the circuit breaker or fuse box before cleaning.** If this is not practical, wring excess moisture out of sponge or cloth when cleaning around switches, lights or controls.

Use warm water and baking soda solution—about a tablespoon (15 ml) of baking soda to a quart (1 liter) of water. This both cleans and neutralizes odors. Thoroughly rinse and wipe dry.

**Other parts of the refrigerator**—including door gaskets, meat and vegetable drawers, ice storage bin and all plastic parts—can be cleaned the same way. After cleaning the door gaskets, apply a thin layer of petroleum jelly to the door gaskets at the hinge side. This helps keep the gaskets from sticking and bending out of shape.

**Avoid cleaning cold glass shelves with hot water because the extreme temperature difference may cause them to break. Handle glass shelves carefully. Rough handling of tempered glass can cause it to shatter.**

**Do not wash any plastic refrigerator parts in the dishwasher.**

### Preparing for vacation

For long vacations or absences, remove food and shut off power to the refrigerator at the fuse box or circuit breaker. Clean the interior with a baking soda solution of one tablespoon (15 ml) of baking soda to one quart (1 liter) of water. Leave the doors open.

**For shorter vacations**, remove perishable foods and leave controls at regular settings. However, if the room temperature is expected to drop below 60°F (16°C), follow the same instructions as for long vacations.

Set the icemaker power switch to the **O (off)** position and shut off the water supply to the refrigerator.

### Using the Master Light switch

This feature turns off the lights in the fresh food and freezer compartments.

The switch is located behind the grille panel at the top of the refrigerator. Lift up the panel to access the switch.

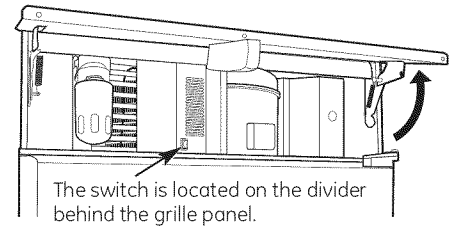

### Light bulb replacement in the fresh food compartment

**Important: Turning the temperature control to OFF does not remove power to the light circuit.**

There are four light bulbs in the top of the fresh food compartment.

#### To replace the bulbs:

- 1 Set the Master Light switch in the OFF position to turn off the lights. See *Using the Master Light switch*.
- 2 Remove the light shield by placing your fingers in the openings at the back of the shield. Then, pull the shield toward you and swing the back of the shield down.
- 3 Replace with the same size bulb (40 watt max.).
- 4 Reinstall the shield and reset the Master Light switch to the ON position.

Replacement 40-watt bulbs can be purchased at your local general retail store, through GE Parts and Accessories, 800.626.2002, or at [monogram.com](http://monogram.com). Order part # 40A15.

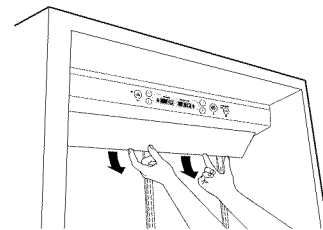
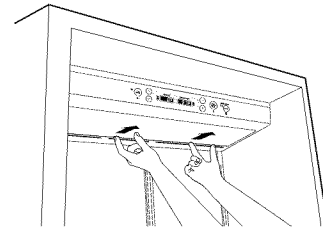

### Light bulb replacement in the freezer compartment

#### To replace a bulb:

- 1 Set the Master Light switch in the OFF position to turn off the lights. See *Using the Master Light switch*.
- 2 Remove the freezer light shield by removing the two screws with a Phillips screwdriver.
- 3 Replace with the same size bulb (40 watt max.).
- 4 Reinstall the shield and reset the Master Light switch to the ON position.

Replacement 40-watt bulbs can be purchased at your local general retail store, through GE Parts and Accessories, 800.626.2002, or at [monogram.com](http://monogram.com). Order part # 40A15.

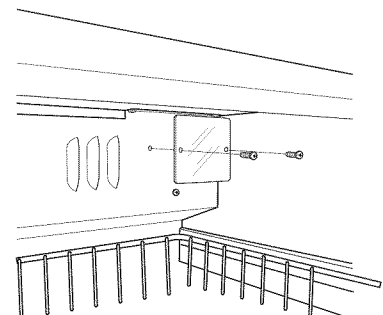

Questions?  
Use this  
problem  
solver!

PROBLEM	POSSIBLE CAUSE
<b>REFRIGERATOR DOES NOT OPERATE</b>	<ul style="list-style-type: none"> <li>• May be in defrost cycle when compressor does not operate for about 30 minutes.</li> <li>• Temperature control in the OFF position.</li> <li>• If interior light is not on, refrigerator may not be plugged in at wall outlet.</li> <li>• The fuse is blown/circuit breaker is tripped. Replace fuse or reset the breaker.</li> </ul>
<b>MOTOR OPERATES FOR LONG PERIODS OR CYCLES ON AND OFF FREQUENTLY</b>  (Modern refrigerators with more storage space and a larger freezer require more operating time. They start and stop often to maintain even temperatures.)	<ul style="list-style-type: none"> <li>• Normal when refrigerator is first plugged in. Wait 24 hours for the refrigerator to completely cool down.</li> <li>• The new variable speed compressor is designed to run for longer periods of time to optimize efficiency and noise. You may notice the compressor and/or fan speeds accelerate based upon door openings and/or increased food loads.</li> <li>• You may hear the fans spinning at high speeds. This happens when the refrigerator is first plugged in, when the doors are opened frequently or when a large amount of food is added to the refrigerator or freezer compartments. The fans are helping to maintain the correct temperatures.</li> <li>• Door left open or package holding door open.</li> <li>• If either door is open for over 3 minutes, you may hear the fans come on in order to cool the light.</li> <li>• Hot weather or frequent door openings. This is normal.</li> <li>• Temperature controls set at the coldest setting. See <i>Temperature Controls</i>.</li> </ul>
<b>THUMPING SOUND WHEN DOOR IS CLOSED</b>	<ul style="list-style-type: none"> <li>• This is a normal operating sound.</li> <li>• The mechanism that closes the door makes a slight thumping sound as it passes over its lever point, at approximately 80 degrees.</li> <li>• Closing the door slowly will minimize the sound.</li> </ul>
<b>OPERATING SOUNDS</b>	<ul style="list-style-type: none"> <li>• Refrigerator is so quiet, that most of the time you will hear low or no operating noise.</li> <li>• Normal fan air flow—one fan blows cold air through the fresh food and freezer compartments—another fan cools the compressor motor.</li> <li>• The fans change speeds in order to provide optimal cooling and energy savings.</li> <li>• These NORMAL sounds will also be heard from time to time:               <ul style="list-style-type: none"> <li>– You may hear a whooshing or gurgling sound when the doors close. This is due to pressure equalizing within the refrigerator.</li> <li>– A water dripping noise may occur during the defrost cycle as ice melts from the evaporator and flows into the drain pan.</li> <li>– The flow of refrigerant through the freezer cooling coils may make a gurgling noise like boiling water.</li> <li>– Water dropping on the defrost heater can cause a sizzling, popping or buzzing sound during the defrost cycle.</li> <li>– You may hear cracking or popping sounds when the refrigerator is first plugged in or during/after the defrost cycle. This happens as the refrigerator cools to the correct temperature.</li> <li>– Electronic dampers click open and closed to provide optimal cooling and energy savings.</li> <li>– The compressor may cause a clicking or chirping sound when attempting to restart (this could take up to 5 minutes).</li> <li>– The electronic control board may cause a clicking sound when relays activate to control refrigerator components.</li> <li>– Ice cubes dropping into the bin and water running in pipes as icemaker refills.</li> <li>– The icemaker water valve will buzz when the icemaker fills with water.</li> </ul> </li> </ul>

Questions?  
Use this  
problem  
solver!

PROBLEM	POSSIBLE CAUSE
DOOR NOT CLOSING PROPERLY	<ul style="list-style-type: none"> <li>• <b>Package holding door open.</b></li> <li>• Check the door gasket; it may be out of position.</li> <li>• Refrigerator not level. See <i>Installation Instructions</i>.</li> </ul>
VIBRATION OR RATTLING (Slight vibration is normal.)	<ul style="list-style-type: none"> <li>• Refrigerator may not be properly installed.</li> </ul>
FRESH FOOD FREEZER OR COMPARTMENT TOO WARM	<ul style="list-style-type: none"> <li>• Temperature controls not set cold enough. See <i>Temperature Controls</i>.</li> <li>• Warm weather or frequent door openings.</li> <li>• Door left open for long time or freezer door left ajar.</li> <li>• Package may be holding door open.</li> </ul>
FROST OR ICE CRYSTALS ON FROZEN FOOD (Frost within package is normal.)	<ul style="list-style-type: none"> <li>• Door left open or package holding door open.</li> <li>• Frequent or long door openings.</li> <li>• Freezer door left ajar.</li> </ul>
SLOW ICE CUBE FREEZING	<ul style="list-style-type: none"> <li>• Door may have been left open or freezer door left ajar.</li> <li>• Temperature of freezer compartment too warm.</li> </ul>
ICE CUBES HAVE ODOR/TASTE	<ul style="list-style-type: none"> <li>• Old cubes need to be discarded.</li> <li>• Ice storage bin needs to be emptied and washed.</li> <li>• Unsealed packages in freezer compartment may be transmitting odor/taste to ice cubes.</li> <li>• Keep open box of baking soda in refrigerator; replace every 3 months.</li> <li>• Interior of refrigerator needs cleaning. See <i>Care and Cleaning</i>.</li> <li>• Poor-tasting incoming water. Replace water filter.</li> </ul>
AUTOMATIC ICEMAKER DOES NOT WORK	<ul style="list-style-type: none"> <li>• Icemaker power switch is in the <b>O (off)</b> position.</li> <li>• Water supply turned off, restricted or not connected. Call your installer for proper water supply line connection.</li> <li>• Water filter clogged. Replace the filter or use the filter bypass plug.</li> <li>• Freezer compartment too warm.</li> <li>• Piled up cubes in storage bin may cause icemaker to shut off too soon. Level cubes in bin.</li> <li>• Ice cubes stuck in icemaker. Turn off the icemaker, remove cubes and turn the icemaker back on.</li> </ul>
MOISTURE FORMS ON OUTSIDE OF REFRIGERATOR	<ul style="list-style-type: none"> <li>• Not unusual during periods of high humidity. Wipe surface dry.</li> <li>• Door left open or package holding door open.</li> <li>• Controlling humidity and temperature in the kitchen with air conditioning will eliminate this condition.</li> </ul>
MOISTURE COLLECTS INSIDE	<ul style="list-style-type: none"> <li>• In humid weather, air carries moisture into refrigerator when doors are opened.</li> <li>• Controlling humidity and temperature in the kitchen with air conditioning will eliminate this condition.</li> </ul>
REFRIGERATOR HAS ODOR	<ul style="list-style-type: none"> <li>• Foods with strong odors should be tightly covered.</li> <li>• Check for spoiled food.</li> <li>• Interior needs cleaning. See <i>Care and Cleaning</i>.</li> <li>• Keep open box of baking soda in refrigerator; replace every 3 months.</li> </ul>
INTERIOR LIGHT DOES NOT WORK	<ul style="list-style-type: none"> <li>• No power at outlet.</li> <li>• Light bulb needs replacing. See <i>Care and Cleaning</i>.</li> <li>• Master Light switch is in the OFF position.</li> </ul>
SMALL OR HOLLOW CUBES	<ul style="list-style-type: none"> <li>• Water filter clogged. Replace the filter or use the filter bypass plug.</li> <li>• Check for a connection to a Reverse Osmosis water system. If an RO is connected, remove the water filter and install the original bypass plug that came with the unit.</li> </ul>



**Performance Data Sheet  
SmartWater Filtration System  
MWF Cartridge**

*This system has been tested according to NSF/ANSI 42/53 for reduction of the substances listed below. The concentration of the indicated substances in water entering the system was reduced to a concentration less than or equal to the permissible limit for water leaving the system, as specified in NSF/ANSI 42/53.\**

*(100% safety factors built in for unmetrated usage)*

Standard No. 42: Aesthetic Effects								
Parameter	USEPA MCL	Influent Challenge Concentration	Influent Average	Effluent		% Reduction		Min. Required Reduction
				Average	Maximum	Average	Minimum	
Chlorine	—	2.0 mg/L ± 10%	1.96 mg/L	0.06 mg/L	0.11 mg/L	96.77%	94.74%	> 50%
T & O	—	—	—	—	—	—	—	—
Particulate**	—	≥ 10,000 particles/mL	6,400,000 #/mL	58,833 #/mL	150,000 #/mL	99.14%	97.97%	≥ 85%

Standard No. 53: Health Effects								
Parameter	USEPA MCL	Influent Challenge Concentration	Influent Average	Effluent		% Reduction		Min. Required Reduction
				Average	Maximum	Average	Minimum	
Turbidity	0.5 NTU	11 ± 1 NTU***	10.5 NTU	0.14 NTU	0.28 NTU	98.54%	97.20%	0.5 NTU
Cysts	≥ 99.95% Reduction	Minimum 50,000 L	118,750 #/L	< 1 #/L	4 #/L	> 99.99%	> 99.99%	≥ 99.95%
Asbestos	≥ 99% Reduction	10 <sup>7</sup> to 10 <sup>8</sup> fibers/L; > 10µm	57 MF/L	0.996 MF/L	< 1 MF/L	99.60%	99.39%	≥ 99%
Lead at pH 6.5	0.015 mg/L	0.15 mg/L ± 10%	0.1567 mg/L	< 0.001 mg/L	< 0.001 mg/L	99.36%	99.29%	0.010 mg/L
Lead at pH 8.5	0.015 mg/L	0.15 mg/L ± 10%	0.1433 mg/L	< 0.001 mg/L	< 0.001 mg/L	99.30%	99.29%	0.010 mg/L
Mercury at pH 6.5	0.002 mg/L	0.006 mg/L ± 10%	0.0059 mg/L	0.000350 mg/L	0.0007 mg/L	94.70%	87.50%	0.002 mg/L
Mercury at pH 8.5	0.002 mg/L	0.006 mg/L ± 10%	0.0057 mg/L	0.000325 mg/L	0.0006 mg/L	93.20%	89.29%	0.002 mg/L
Alachlor	0.002 mg/L	0.04 mg/L ± 10%	0.0367 mg/L	0.00023 mg/L	0.0004 mg/L	99.34%	98.67%	0.002 mg/L
Lindane	0.0002 mg/L	0.002 mg/L ± 10%	0.0020 mg/L	< 0.00002 mg/L	< 0.00002 mg/L	99.00%	98.95%	0.0002 mg/L
2,4-D	0.070 mg/L	0.210 mg/L ± 10%	0.2033 mg/L	0.00337 mg/L	0.011000 mg/L	98.32%	94.50%	0.070 mg/L
Toxaphene	0.003 mg/L	0.015 mg/L ± 10%	0.0160 mg/L	0.00100 mg/L	0.001000 mg/L	93.44%	91.67%	0.003 mg/L
Benzene	0.005 mg/L	0.015 mg/L ± 10%	0.0145 mg/L	0.000500 mg/L	0.000500 mg/L	96.51%	95.83%	0.005 mg/L
Carbofuran	0.040 mg/L	0.080 mg/L ± 10%	0.0830 mg/L	0.001000 mg/L	0.001000 mg/L	98.78%	98.65%	0.04 mg/L
1,4 dichlorobenzene	0.075 mg/L	0.225 mg/L ± 10%	0.2283 mg/L	0.000500 mg/L	0.000500 mg/L	99.78%	99.77%	0.075 mg/L
Atrazine	0.003 mg/L	0.009 mg/L ± 10%	0.0087 mg/L	< 0.0005 mg/L	< 0.0005 mg/L	94.22%	93.33%	0.003 mg/L

\* Tested using a flow rate of 0.50 gpm; pressure of 60 psig; pH of 7.5 ± 0.5; temp. of 68° ± 5°F (20° ± 3°C)

\*\* Measurement in Particles/ml. Particles used were 0.5-1 microns

\*\*\* NTU=Nephelometric Turbidity units

### Operating Specifications

- Capacity: certified for up to 300 gallons (1135 l); up to six months for models without a replacement filter indicator light; up to one year for models with a replacement filter indicator light
- Pressure requirement: 40–120 psi (2.8–8.2 bar), non-shock
- Temperature: 33–100°F (0.6–38°C)
- Flow rate: 0.5 gpm (1.9 lpm)

### General Installation/Operation/Maintenance Requirements

- Flush new cartridge at full flow for 3 minutes to purge out trapped air.
- Replace cartridge when the indicator light flashes or water flow rate is reduced on non-indicator units.

### Special Notices

- Installation instructions, parts and service availability, and standard warranty are included with the product when shipped.
- This drinking water system must be maintained according to manufacturer’s instructions, including replacement of filter cartridges.
- Do not use with water that is microbiologically unsafe or of unknown quality without adequate disinfection before or after the system. Systems certified for cyst reduction may be used on disinfected water that may contain filterable cysts.
- The contaminants or other substances removed or reduced by this water treatment system are not necessarily in your water.
- Check for compliance with the state and local laws and regulations.
- Note that while the testing was performed under standard laboratory conditions, actual performance may vary. Systems must be installed and operated in accordance with manufacturer’s recommended procedures and guidelines.

System Tested and Certified by NSF International against ANSI/NSF Standard 42 & 53 for the reduction of:	
<b>Standard No. 42: Aesthetic Effects</b>	<b>Standard No. 53: Health Effects</b>
Chemical Unit Chlorine Taste and Odor	Chemical Reduction Unit Alachlor and Atrazine Reduction Benzene and Carbofuran Reduction 1,4 dichlorobenzene and 2,4-D Reduction Lead and Lindane Reduction Mercury and Toxaphene Reduction
Mechanical Filtration Unit Particulate Reduction, Class I	Mechanical Filtration Unit Turbidity Reduction Cyst and Asbestos Reduction



**Water Treatment Device  
Certificate Number**

**05 - 1698**

Date Issued: February 2, 2005

---

---

**Trademark/Model Designation**

MWF

**Replacement Elements**

MWF

---

---

**Manufacturer:** General Electric Company

---

---

The water treatment device(s) listed on this certificate have met the testing requirements pursuant to Section 116830 of the Health and Safety Code for the following health related contaminants:

**Microbiological Contaminants and Turbidity**

Cysts  
Turbidity

**Inorganic/Radiological Contaminants**

Asbestos  
Lead  
Mercury

**Organic Contaminants**

Alachlor  
Atrazine  
Benzene  
Carbofuran  
Lindane  
Mercury  
Toxaphene  
1,4-dichlorobenzene  
2,4-D

---

**Rated Service Capacity:** 300 gal

**Rated Service Flow:** 0.5 gpm

---

**Conditions of Certification:**

Do not use where water is microbiologically unsafe or with water of unknown quality, except that systems certified for cyst reduction may be used on disinfected waters that may contain filterable cysts.

***With the purchase of your new Monogram appliance, receive the assurance that if you ever need information or assistance from GE, we'll be there. All you have to do is call—toll-free!***

## **GE Answer Center®**

***In the USA:  
800.626.2000***

Whatever your question about any Monogram major appliance, GE Answer Center® information service is available to help. Your call—and your question—will be answered promptly and courteously. Call the GE Answer Center® Monday to Friday, 8 a.m. to 10 p.m. EST, and Saturday, 8 a.m. to 7 p.m. EST.

**OR**

Visit our Website at: [monogram.com](http://monogram.com)

***In Canada, call 1.800.561.3344.***

## **In-Home Repair Service**

***In the USA:  
800.444.1845***

***In Canada:  
1.800.561.3344***

A GE consumer service professional will provide expert repair service, scheduled at a time that's convenient for you. To schedule service, call Monday to Friday, 7 a.m. to 10 p.m. EST, or Saturday and Sunday, 8 a.m. to 6 p.m. EST. Many GE Consumer Service company-operated locations offer you service today or tomorrow, or at your convenience. Our factory-trained technicians know your appliance inside and out—so most repairs can be handled in just one visit.

***In Canada: Monday through Friday, 7 a.m. to 8 p.m., and Saturday, 8 a.m. to 5 p.m. EDT***

## **For Customers With Special Needs...**

***In the USA:  
800.626.2000***

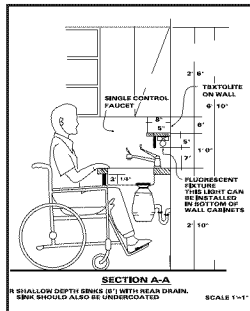

GE offers Braille controls for a variety of GE appliances, and a brochure to assist in planning a barrier-free kitchen for persons with limited mobility.

Consumers with impaired hearing or speech who have access to a TDD or a conventional teletypewriter may call 800.TDD.GEAC (800.833.4322) to request information or service.

## **Service Contracts**

***In the USA:  
800.626.2224***

***In Canada:  
1.800.561.3344***

You can have the secure feeling that GE Consumer Service will still be there after your warranty expires. Purchase a GE contract while your warranty is still in effect and you'll receive a substantial discount. With a multiple-year contract, you're assured of future service at today's prices.

## **Parts and Accessories**

***In the USA:  
800.626.2002***

***In Canada:  
1.800.561.3344***

**Individuals qualified to service their own appliances** can have parts or accessories sent directly to their home. The GE parts system provides access to over 47,000 parts...and all GE Genuine Renewal Parts are fully warranted. VISA, MasterCard and Discover cards are accepted.

**User maintenance instructions contained in this manual cover procedures intended to be performed by any user. Other servicing generally should be referred to qualified service personnel. Caution must be exercised, since improper servicing may cause unsafe operation.**

**YOUR MONOGRAM REFRIGERATOR WARRANTY**

**Staple sales slip or cancelled check here. Proof of original purchase date is needed to obtain service under warranty.**

**WHAT IS COVERED**

*From the Date of the Original Purchase*

**LIMITED TWO-YEAR WARRANTY**

For two years from date of original purchase, we will provide, free of charge, parts and service labor in your home to repair or replace *any part of the refrigerator* that fails because of a manufacturing defect.

**LIMITED FIVE-YEAR WARRANTY**

For five years from date of original purchase, we will provide, free of charge, parts and service labor in your home to repair or replace *any part of the sealed refrigerating system* (the compressor, condenser, evaporator and all connecting tubing) that fails because of a manufacturing defect.

**LIMITED ADDITIONAL SIXTH- THROUGH TWELFTH-YEAR WARRANTY ON THE SEALED SYSTEM**

For the sixth through twelfth year from the date of the original purchase, we will provide, free of charge, replacement parts for *any part of the sealed refrigerating system* (the compressor, condenser, evaporator and all connecting tubing) that fails because of a manufacturing defect. You pay for the service trip to your home and for service labor charges.

**LIMITED THIRTY-DAY WARRANTY ON WATER FILTER CARTRIDGE (Water filter, if included)**

From the date of the original purchase we will provide, free of charge, replacement parts for *any part of the water filter cartridge* that fails because of a manufacturing defect. During this limited thirty-day warranty, we will also provide, free of charge, a replacement water filter cartridge.

.....  
This warranty is extended to the original purchaser and any succeeding owner for products purchased for ordinary home use in the 48 mainland states, Hawaii, Washington, D.C. or Canada. If the product is located in an area where service by a GE Authorized Servicer is not available, you may be responsible for a trip charge or you may be required to bring the product to an Authorized GE Service location for service. In Alaska the warranty is the same except that it is LIMITED because you must pay to ship the product to the service shop or for the service technician's travel costs to your home.

All warranty service will be provided by our Factory Service Centers or by our authorized Customer Care® servicers during normal working hours.

Should your appliance need service, during warranty period or beyond, in the USA call 800.444.1845. In Canada: 800.561.3344. Please have your serial number and model number available when calling for service.

**WHAT IS NOT COVERED**

- Service trips to your home to teach you how to use the product.
- Replacement of house fuses or resetting of circuit breakers.
- Damage to the product caused by accident, fire, floods or acts of God.
- Failure of the product if it is used for other than its intended purpose or used commercially.
- Damage caused after delivery.
- Improper installation, delivery or maintenance. If you have an installation problem, contact your dealer or installer. You are responsible for providing adequate electrical, plumbing and other connecting facilities.
- Replacement of the light bulbs, if included, or water filter cartridge, if included, other than as noted above.
- Replacement of the water filter cartridge, if included, due to water pressure that is outside the specified operating range or due to excessive sediment in the water supply.
- Loss of food due to spoilage (in the USA only).
- Incidental or consequential damage caused by possible defects with this appliance.
- Product not accessible to provide required service.

**EXCLUSION OF IMPLIED WARRANTIES—Your sole and exclusive remedy is product repair as provided in this Limited Warranty. Any implied warranties, including the implied warranties of merchantability or fitness for a particular purpose, are limited to one year or the shortest period allowed by law.**

Some states/provinces do not allow the exclusion or limitation of incidental or consequential damages, so the above limitation or exclusion may not apply to you. This warranty gives you specific legal rights, and you may also have other rights which vary from state to state/province to province. To know what your legal rights are in your state/province, consult your local or state/provincial consumer affairs office or your state's Attorney General.

162D9632P007  
49-60423-2

06-09 JR

Printed in the United States

Warrantor in USA: General Electric Company,  
Louisville, KY 40225

Warrantor in Canada: Mabe Canada Inc.



**GE Consumer & Industrial**  
Appliances  
General Electric Company  
Louisville, KY 40225  
GEAppliances.com