

FRIGIDAIRE

All about the

Use & Care

of your Gas Range

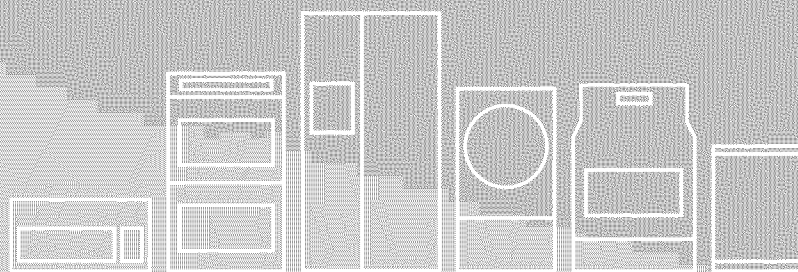

TABLE OF CONTENTS

Welcome & Congratulations	2	Setting Oven Controls.....	13
Important Safety Instructions.....	3	Care & Cleaning (Cleaning Chart)	21
Features at a Glance.....	7	Care & Cleaning	22
Surface Cooking	8	Before You Call	25
Setting Surface Controls	10	Major Appliance Warranty	28
Before Setting Oven Controls	12		

WELCOME & CONGRATULATIONS

Product Registration Register Your Product

The **PRODUCT REGISTRATION CARD** should be filled in completely, signed and returned to Electrolux Home Products.

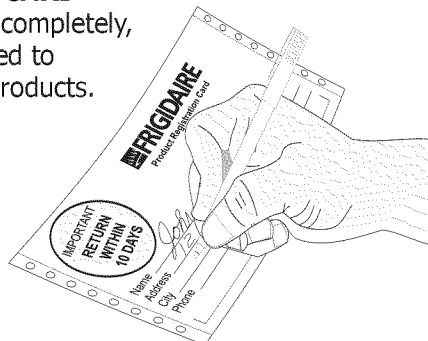

Congratulations on your purchase of a new appliance! At **Electrolux Home Products**, we are very proud of our product and are completely committed to providing you with the best service possible. Your satisfaction is our number one priority.

We know you'll enjoy your new appliance and **Thank You** for choosing our product. We hope you consider us for future purchases.

PLEASE CAREFULLY READ AND SAVE THESE INSTRUCTIONS

This Use & Care Manual contains general operating instructions for your appliance and feature information for several models. Your product **may not** have all the described features. The graphics shown are representative. The graphics on your appliance may not look exactly like those shown. These instructions are not meant to cover every possible condition and situation that may occur. Common sense and caution must be practiced when installing, operating and maintaining any appliance.

Serial Plate Location

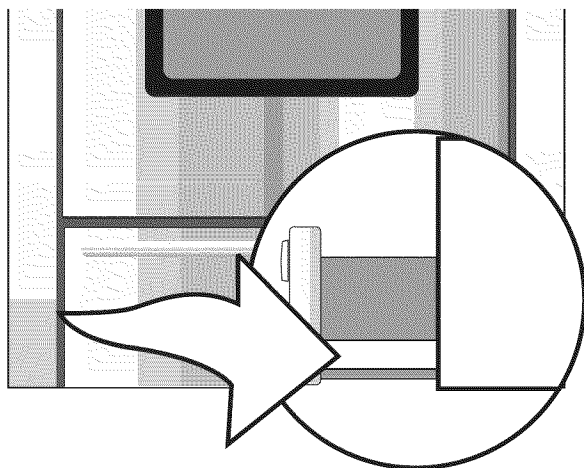

Please record your model and serial numbers below for future reference.

Model Number: _____

Serial Number: _____

Purchase Date: _____

NOTE

Please attach sales receipt here for future reference.



IMPORTANT SAFETY INSTRUCTIONS

Read all instructions before using this appliance.
Save these instructions for future reference.

WARNING

If the information in this manual is not followed exactly, a fire or explosion may result causing property damage, personal injury or death.

FOR YOUR SAFETY:

- Do not store or use gasoline or other flammable vapors and liquids in the vicinity of this or any other appliance.
- **WHAT TO DO IF YOU SMELL GAS:**
 - Do not try to light any appliance.
 - Do not touch any electrical switch; do not use any phone in your building.
 - Immediately call your gas supplier from a neighbor's phone. Follow the gas supplier's instructions.
 - If you cannot reach your gas supplier, call the fire department.
- Installation and service must be performed by a qualified installer, servicer or the gas supplier.

DEFINITIONS

 This is the safety alert symbol. It is used to alert you to potential personal injury hazards. Obey all safety messages that follow this symbol to avoid possible injury or death.

WARNING

This symbol will help alert you to situations that may cause serious bodily harm, death or property damage.

CAUTION

This symbol will help alert you to situations that may cause bodily injury or property damage.

IMPORTANT

IMPORTANT indicates installation, operation or maintenance information which is important but not hazard-related.

WARNING



- All appliance can tip.
- Injury to persons could result.
- Install anti-tip bracket packed with your appliance.
- See Installation Instructions.



To reduce the risk of tipping, the appliance must be secured by properly installed anti-tip bracket provided with the unit. Refer to the Installation Instructions for proper anti-tip bracket installation.

- Remove all tape and packaging wrap before using the appliance. Discard the carton and plastic bags after unpacking the appliance. Use recycling facility where available. Never allow children to play with packaging material. Do not remove the wiring label and other literature attached to the appliance. Do not remove model/serial number plate.
- **Proper Installation. Be sure your appliance is properly installed and grounded by a qualified technician in accordance in the National Fuel Gas Code ANSI Z223.1 latest edition, and National Electrical Code ANSI/NFPA No. 70-latest edition and local code requirements.** Install only per installation instructions provided in the literature package for this range.

Ask your dealer to recommend a qualified technician and an authorized repair service. Know how to disconnect the electrical power to the appliance at the circuit breaker or fuse box and gas supply at the main shutoff valve in case of an emergency. Remove the drawer to access the valve.
- **User Servicing. Do not repair or replace any part of the appliance unless specifically recommended in the manuals.** All other servicing should be done only by a qualified technician, this may reduce the risk of personal injury and damage to the appliance.
- **Never modify or alter the construction of an appliance by removing leveling legs, panels, wire covers, anti-tip brackets/screws, or any other part of the product.**

IMPORTANT SAFETY INSTRUCTIONS

WARNING

Stepping, leaning, sitting or pulling down on the door or the drawer of this appliance can result in serious injuries and also cause damage to the appliance. Do not allow children to climb or play around the appliance. The weight of a child on an open door may cause the appliance to tip, resulting in serious burns or other injury.

Do not use the oven for storage.

- **Storage in or on Appliance. Flammable materials should not be stored in an oven, near surface burners.** This includes paper, plastic and cloth items, such as cookbooks, plastic ware and towels, as well as flammable liquids. Do not store explosives, such as aerosol cans, on or near the appliance. Flammable materials may explode and result in fire or property damage.

CAUTION

Do not store items of interest to children in the cabinets above the appliance. Children climbing on the cooktop to reach items could be seriously injured.

- **Do not leave children alone. Children should not be left alone or unattended in the area where an appliance is in use.** They should never be allowed to sit or stand on any part of the appliance.
- **DO NOT TOUCH SURFACE UNITS, AREAS NEAR THESE UNITS, OVEN HEATING ELEMENTS OR INTERIOR SURFACES OF THE OVEN.** Both surface burners and oven heating elements may be hot even though they are dark in color. Areas near surface units may become hot enough to cause burns. During and after use, do not touch, or let clothing or other flammable materials touch these areas until they have had sufficient time to cool. Among these areas are the cooktop, surfaces facing the cooktop, the oven vent openings and surfaces near these openings, oven door and window.
- **Wear Proper Apparel. Loose-fitting or hanging garments should never be worn while using the appliance.** Do not let clothing or other flammable materials contact hot surfaces.

WARNING

NEVER use your appliance as a space heater to heat or warm the room. Doing so may result in carbon monoxide poisoning and overheating of the oven.

In case of fire or gas leak, be sure to turn off the main gas shutoff valve.

- **Do Not Use Water or Flour on Grease Fires.** Smother the fire with a pan lid, or use baking soda, a dry chemical or foam-type extinguisher.
- **When heating fat or grease, watch it closely.** Fat or grease may catch fire if allowed to become too hot.
- **Use Only Dry Pot holders. Moist or damp pot holders on hot surfaces may result in burns from steam.** Do not let the pot holders touch hot surface units. Do not use a towel or other bulky cloth instead of a pot holder.
- **Do Not Heat Unopened Food Containers. Buildup of pressure may cause the container to burst and result in injury.**
- **Remove the oven door from any unused appliance if it is to be stored or discarded.**

IMPORTANT

Do not attempt to operate the appliance during a power failure. If the power fails, always turn off the unit. If the unit is not turned off and the power resumes, the oven may begin to operate again. Food left unattended could catch fire or spoil.

WARNING

Use proper flame size. Adjust flame size so it does not extend beyond the edge of the utensil. The use of undersize utensils will expose a portion of the burner flame to direct contact and may result in ignition of clothing. Proper relationship of utensil to flame will also improve efficiency.

Do not use stove top grills on the burner grates of sealed gas burners. If you use a stove top grill on a sealed gas burner, it will cause incomplete combustion and can result in exposure to carbon monoxide levels allowable current standards. This can be hazardous to your health.

CAUTION

Electronic controllers can be damaged by cold temperatures. When you use your appliance for the first time, or if it has not been used for a long period of time, make sure that it has been exposed to a temperature above 0°C/32°F for at least 3 hours before connecting it to the power supply.

IMPORTANT SAFETY INSTRUCTIONS

IMPORTANT INSTRUCTIONS FOR USING YOUR COOKTOP

- **Know which knob controls each surface heating unit.** Always turn the knob to the LITE position when igniting the burner. Visually check that burner has lit. Then adjust the flame so it does not extend beyond the edge of the utensil.
- **Use Proper Pan Size**—This appliance is equipped with one or more surface units of different sizes. Select utensils having flat bottoms large enough to cover the surface unit. The use of undersized utensils will expose a portion of surface heating to direct contact and may result in ignition of clothing. Proper relationship of utensil to the surface will also improve efficiency.
- **Utensil Handles Should Be Turned Inward and Should Not Extend Over Adjacent Surface Burners**—To reduce the risk of burns, ignition of flammable materials, and spillage due to unintentional contact with the utensil. The handle of the utensil should be positioned so that it is turned inward, and does not extend over adjacent surface burner.
- **Never Leave Surface Burners Unattended at High Heat Settings**—Boilovers cause smoking and greasy spillovers that may ignite, or a pan that has boiled dry may melt.
- **Protective Liners**—Do not use aluminum foil to line oven bottom or any other part of the appliance. Only use aluminum as recommended for baking if used as a cover placed on the food. Any other use of protective liners or aluminum foil may result in a risk of electric shock or fire or a short circuit.
- **Glazed Cooking Utensils**—Only certain types of glass, glass/ceramic, ceramic, earthenware, or other glazed utensils are suitable for cooktop service without breaking due to the sudden change in temperature. Check the manufacturer's recommendations for cooktop use.
- **Do Not Use Decorative Surface Burner Covers.** If a burner is accidentally turned on, the decorative cover will become hot and possibly melt. Burns will occur if the hot covers are touched. Damage may also be done to the cooktop or burners because the covers may cause overheating. Air will be blocked from the burner and cause combustion problems.

FOR GLASS COOKTOPS ONLY

- **Do not clean or operate a broken cooktop**—If cooktop should break, cleaning solutions and spillovers may penetrate the broken cooktop and create a risk of electric shock. Contact a qualified technician immediately
- **Clean cooktop glass with caution**—If a wet sponge or cloth is used to wipe spills on a hot cooking area, be careful to avoid a steam burn. Some cleaners can produce harmful fumes if applied to a hot surface.
- **Avoid scratching the cooktop glass with sharp objects.**

IMPORTANT SAFETY INSTRUCTIONS FOR USING YOUR OVEN

- **Use Care When Opening Oven Door**—Stand to the side of the appliance when opening the door of a hot oven. Let hot air or steam escape before you remove or replace food in the oven.
- **Keep Oven Vent Ducts Unobstructed.** Each oven has its own vent located on the top, near each side and towards the back of the cooktop. Touching the surfaces in this area when the oven is operating may cause severe burns. Also, do not place plastic or heat-sensitive items on or near the oven vent. These items could melt or ignite.



WARNING

NEVER cover any slots, holes or passages in the oven bottom or cover an entire rack with materials such as aluminum foil. Doing so blocks air flow through the oven and may cause carbon monoxide poisoning. Aluminum foil linings may trap heat, causing a fire hazard.

- **Placement of Oven Racks.** Always place oven racks in desired location while appliance is cool. Remove all utensils from the rack before removing rack. If rack must be moved while oven is hot, use extreme caution. Use pot holders and grasp the rack with both hands to reposition. Do not let pot holders contact the hot oven element or interior of the oven.
- **Do not use a broiler pan without its insert.** Broiler pan and its grid allow dripping fat to drain and be kept away from the high heat of the broiler.
- **Do not cover the broiler grid or oven bottom with aluminum foil.** Exposed fat and grease could ignite.
- **Do not touch a hot oven light bulb with a damp cloth.** Doing so could cause the bulb to break. Disconnect the appliance or shut off the power to the appliance before removing and replacing the bulb.

IMPORTANT SAFETY INSTRUCTIONS FOR CLEANING YOUR OVEN

- **Clean the appliance regularly to keep all parts free of grease that could catch fire.** Exhaust fan ventilation hoods and grease filters should be kept clean. Do not allow grease to accumulate. Greasy deposits in the fan could catch fire. When you are flaming food under the hood, turn the fan ON. Refer to the hood manufacturer's instructions for cleaning.
- **Cleaners/Aerosols**—Always follow the manufacturer's recommended directions for use. Be aware that excess residue from cleaners and aerosols may ignite causing damage and/or injury.

IMPORTANT SAFETY INSTRUCTIONS

- **Clean in the self-cleaning cycle only the parts of the appliance listed in this Owner's Guide.** Before using the self-cleaning cycle of the appliance, remove all utensils or foods from the appliance.
- **Do not clean the oven door gasket.** The door gasket is essential for a good seal. Care should be taken not to rub, damage or move the gasket.
- **Do not use oven cleaners.** No commercial oven cleaner or oven liner protective coating of any kind should be used in or around any part of the appliance.
- **Remove oven racks.** Oven racks color will change if left in the oven during a self-cleaning cycle.

CAUTION

The health of some birds is extremely sensitive to the fumes given off during the self-clean cycle of any wall oven. Move birds to another well ventilated room.

IMPORTANT SAFETY NOTICE

The California Safe Drinking Water and Toxic Enforcement Act requires the Governor of California to publish a list of substances known to the state to cause cancer, birth defects or other reproductive harm, and requires businesses to warn customers of potential exposure to such substances.

CONVERSION TO LIQUEFIED PETROLEUM GAS (L.P. GAS)

This natural gas range is designed to allow for conversion to Liquefied Petroleum (L.P.) Gas.

If L.P. conversion is needed, contact the service center for assistance. The L.P. Conversion Kit is provided with this cooktop and is located in the literature envelope. Before installing the kit be sure to follow the L.P. Installation Instructions carefully.

WARNING

Personal injury or death from electrical shock may occur if the range is not installed by a qualified installer or electrician.

CAUTION

Any additions, changes or conversions required in order for this appliance to satisfactorily meet the application needs must be made by an authorized Service Center.

GROUNDING INSTRUCTIONS

For personal safety, the cooktop must be properly grounded. For maximum safety, the power cord must be plugged into an electrical outlet that is correctly polarized and properly grounded.

DO NOT operate the cooktop using a 2-prong adapter or an extension cord. If a 2-prong wall receptacle is the only available outlet, it is the personal responsibility of the consumer to have it replaced with a properly grounded 3-prong wall receptacle installed by a qualified electrician.

See the **INSTALLATION INSTRUCTIONS** packaged with this cooktop for complete installation and grounding instructions.

WARNING

This appliance is equipped with a 3-prong grounding plug for your protection against shock hazard and should be plugged directly into a properly grounded receptacle. **DO NOT** cut or remove the grounding prong from this plug.

Do not under any circumstances cut or remove the third round grounding prong from the power cord plug. See the installation instructions packaged with this cooktop for complete installation and grounding instructions. Do not operate the cooktop using a two-prong adapter or an extension cord.

Grounding type wall receptacle

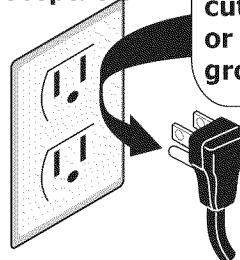

Do not, under any circumstances, cut, remove, or bypass the grounding prong.

Power supply cord with 3-prong grounding plug

WARNING

Avoid fire hazard or electrical shock. **DO NOT** use an adapter plug, an extension cord, or remove grounding prong from electrical power cord. Failure to follow this warning can cause serious injury, fire or death.

FEATURES AT A GLANCE

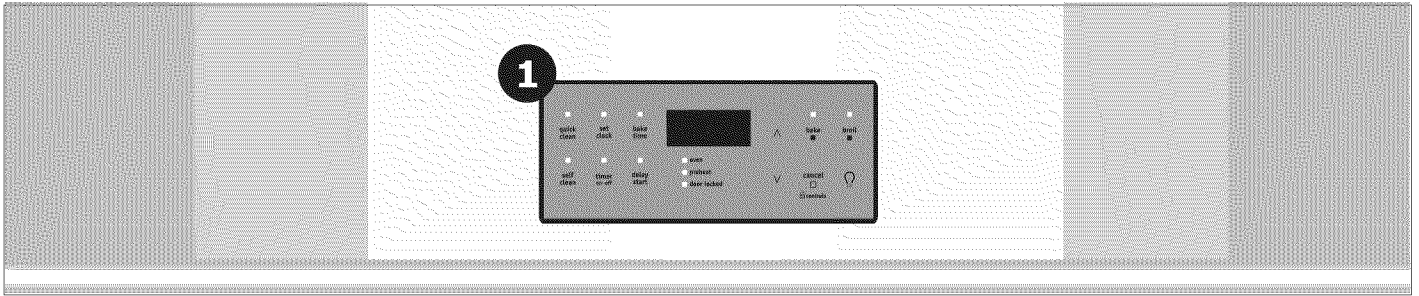

Your built-in range Features:

1. Electronic oven control with kitchen timer.
2. Burner valve & knob.
3. Oven vent
4. Interior oven light.
5. Self-clean interior oven.
6. Adjustable interior oven rack(s).
7. 3-piece handle.
8. Storage drawer.
9. 14 000 BTU Surface burner.
10. 9 500 BTU Surface burner.
11. 16 000 BTU Surface burner.
12. 5 000 BTU Surface burner.
13. 12 000 BTU Surface burner.

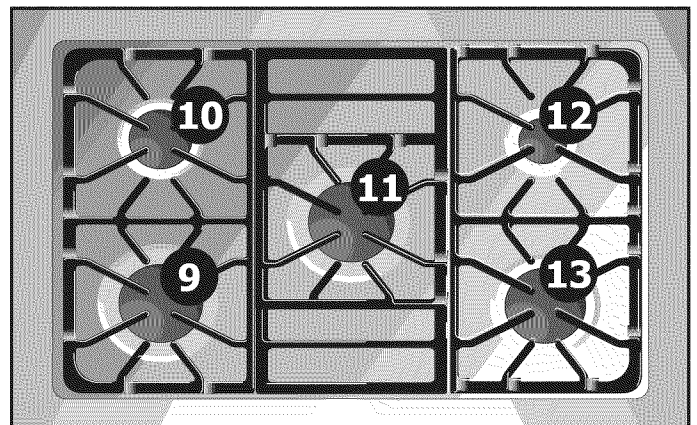
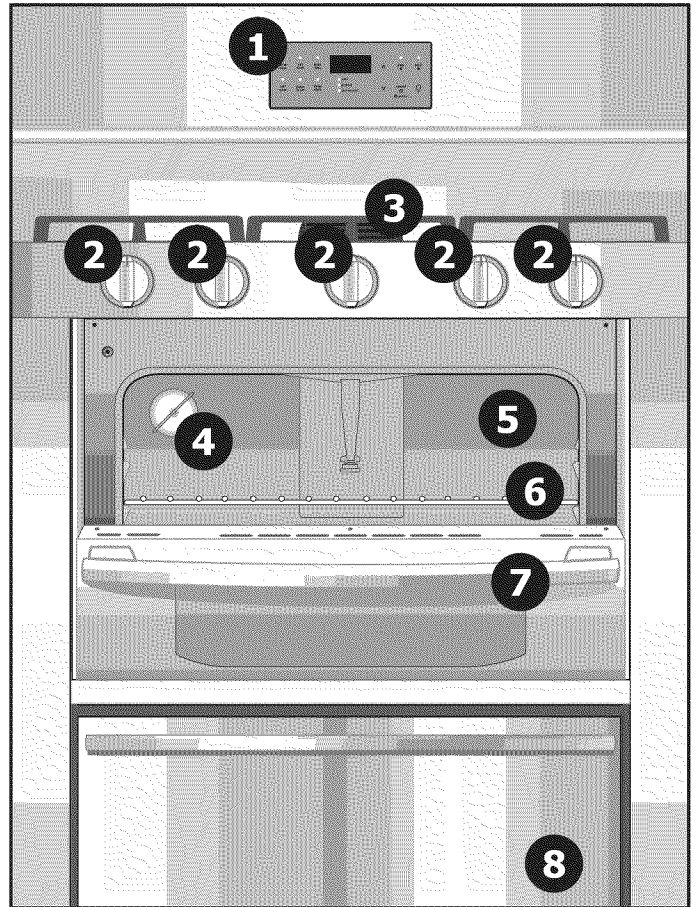

SURFACE COOKING

Use Proper Cookware

Cookware should have flat bottoms that make good contact with the entire surface heating element. Check for flatness by rotating a ruler across the bottom of the cookware (See Figure 2). Be sure to follow the recommendations for using cookware as shown in Figure 1.

Note: The size and type of cookware used will influence the setting needed for best cooking results.

Note: Always use a utensil for its intended purpose. Follow manufacturer's instructions. Some utensils were not made to be used in the oven or on the cooktop.

CORRECT

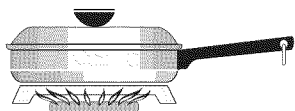

- Flat bottom and straight sides.
- Tight fitting lids.
- Weight of handle does not tilt pan. Pan is well balanced.
- Pan sizes match the amount of food to be prepared.
- Made of material that conducts heat well.
- Easy to clean.

INCORRECT

- Curved and warped pan bottoms.
- Pan overhangs burner grate by more than 2.5 cm (1").
- Heavy handle tilts pan.
- Flame extends beyond pan.

Figure 1

* Specialty pans such as lobster pots, griddles and pressure cookers may be used but must conform to the above recommended cookware requirements.

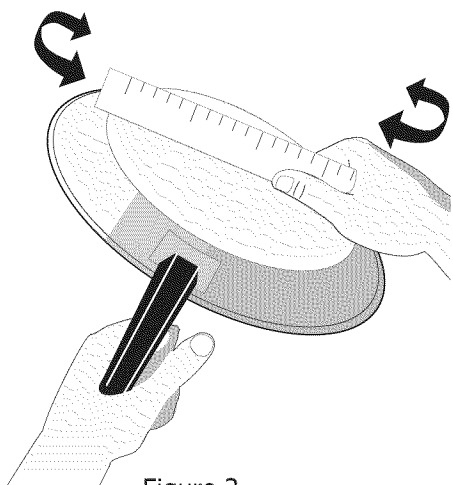

Figure 2

Using a wok

Woks with flat bottoms suitable for use on your cooktop are available in most cookshop or hardware stores (Figure 3). Round-bottomed woks (with a support ring that does not extend beyond the burner circumference) may also be used. The metal ring was designed to support the wok safely when it is filled with large amounts of liquids (soup making) or fat (frying).

Wire trivets: Do not use wire trivets. Cookware bottoms must be in direct contact with the grates.

CAUTION

DO NOT use two burner units to heat one large pan such as a roaster or griddle, or allow cooking utensils to boil dry (Figure 4). The bottom surface of the pan in either of these situations could cause discoloring or crazing of the appliance cooking surface, and damage to the grates and burner units.

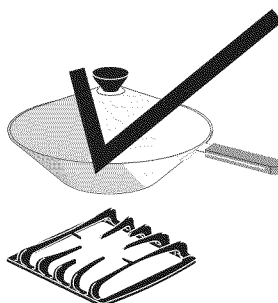

Figure 3

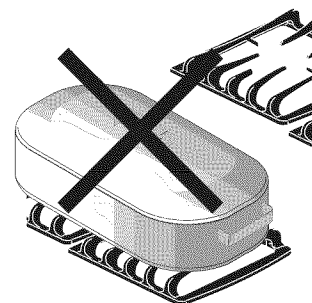

Figure 4

DO NOT use a wok if it is equipped with a metal ring that extends beyond the burner circumference. Because this ring traps heat, the surface unit and cooktop surface could be damaged (Figure 5).

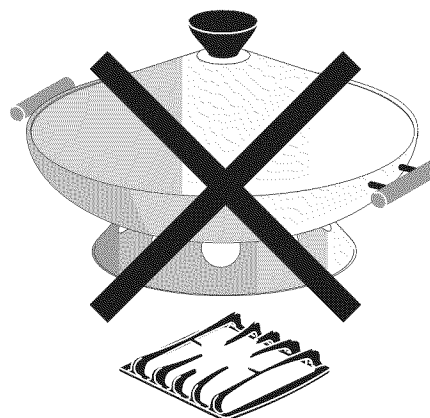

Figure 5

Canning Tips & Information

CAUTION

Canning can generate large amounts of steam. Use extreme caution to prevent burns. Always raise the lid to vent steam away from you.

Prevent damage to cooktop and burner grates:

1. Do not use water bath or pressure canners that extend more than one inch beyond the edge of the burner grate.
2. Do not leave water bath or pressure canners on high heat for an extended amount of time.
3. Alternate surface units between each batch to allow the units and surrounding surfaces to cool down. Try to avoid canning on the same burner unit all day.

Safe canning requires that harmful micro-organisms are destroyed and the jars are sealed completely. When canning in a water bath canner, a gentle but steady boil must be maintained continuously for the required time.

1. Use tested recipes and follow instructions carefully. Check with your local Cooperative Agricultural Extension Service or a manufacturer of glass jars for the latest canning information.
2. Use flat-bottomed canners only. Heat is spread more evenly when the bottom surface is flat.
3. Center canner on the burner grate.
4. Start with hot water and a high heat setting to reduce the time it takes to bring the water to a boil; then reduce the heat setting as low as possible to maintain a constant boil.
5. It is best to can small amounts and light loads.

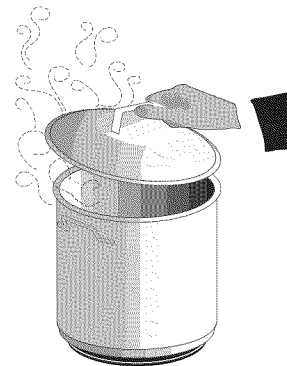

SETTING SURFACE CONTROLS

Placement of Burner Bases and Caps

Your Cooktop is equipped with three different sizes of burners: Power Burner, Standard Burner and Simmer Burner.

Place the burner base over each gas opening, matching the burner base size with the gas opening size. Place the burner cap on each burner base, again matching the cap size to the burner base size. The cap for each burner has an inner locating ring which locates the burner cap in the center of the burner.

Make sure each burner cap is properly aligned and level.

Turn the burner on to determine if it will light. If the burner does not light, contact a Service Center. Do not service the sealed burner yourself.

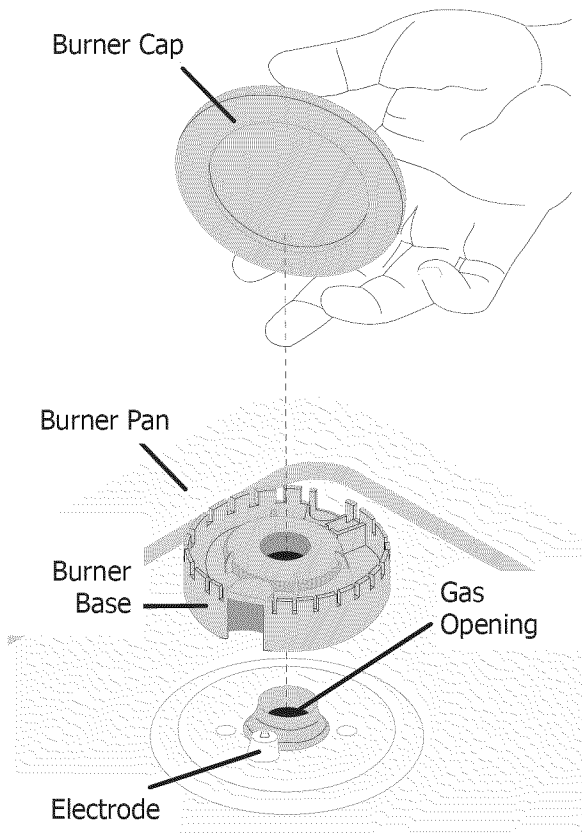

Placement of Burner Grates

Place grate over burner pans. Make sure that the groove under grate fits over the raised lip of the burner pan. The rounded corners of the grates should be placed toward the front of the cooktop for the front burners and the rear of the cooktop for the back burners.

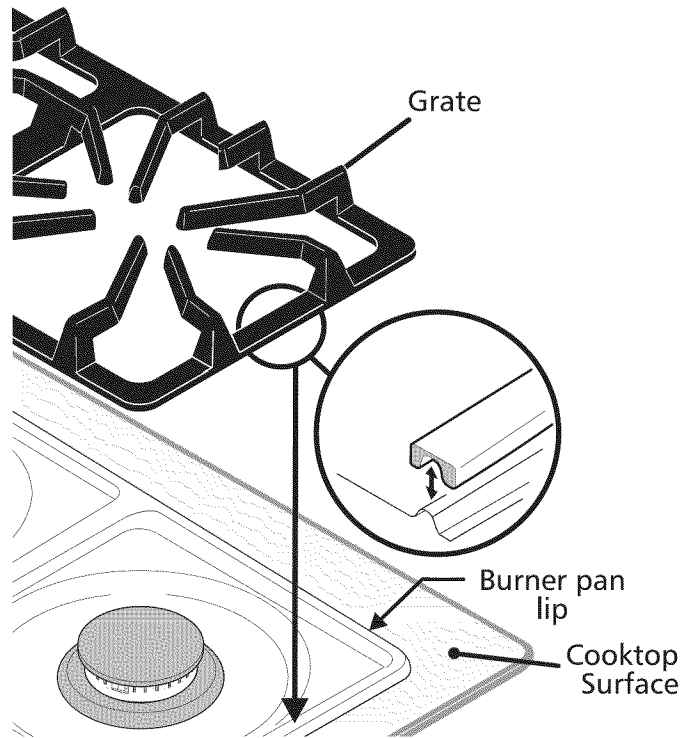

SETTING SURFACE CONTROLS

Operating the Gas Surface Controls:

1. Place cooking utensil on surface burner.
2. Push the surface control knob down and turn counterclockwise out of the OFF position (See Figure 1).
3. Release the knob and rotate to the LITE position.
Note: All four electronic surface ignitors will spark at the same time. However, only the burner you are turning ON will ignite.
4. Visually check that the burner has a flame.
5. Turn the control knob counterclockwise to the desired flame size. The control knobs do not have to be set at a particular setting. Use the knob indicator settings to adjust the flame as needed. DO NOT cook with the surface control knob in the LITE position. (The electronic ignitor will continue to spark if the knob is left in the LITE position.)

In the event of an electrical power outage, the surface burners can be lit manually. To light a surface burner, hold a lit match to the burner head, then slowly turn the surface control knob to LITE. After burner lights push in and turn knob to desired setting. Use caution when lighting surface burners manually.

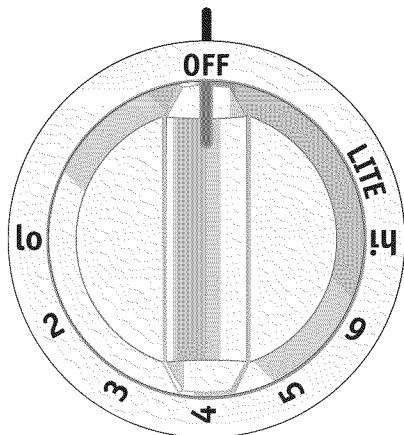

Figure 1

CAUTION

Do not place plastic items such as salt and pepper shakers, spoon holders or plastic wrappings on top of the range when it is in use. These items could melt or ignite. Potholders, towels or wood spoons could catch fire if placed too close to a flame.

Setting Proper Surface Burner Flame Size

For most cooking, start on the highest control setting and then turn to a lower one to complete the process. Use the recommendations below as a guide for determining proper flame size for various types of cooking. The size and type of utensil used and the amount of food being cooked will influence the setting needed for cooking.

*Flame Size	Type of Cooking
High Flame	Start most foods; bring water to a boil; pan broiling.
Medium Flame	Maintain a slow boil; thicken sauces, gravies; steaming.
Low Flame	Keep foods cooking; poach; stewing.

*These settings are based on using medium-weight metal or aluminum pans with lids. Settings may vary when using other types of pans. The color of the flame is the key to proper burner adjustment. A good flame is clear, blue and hardly visible in a well-lighted room. Each cone of flame should be steady and sharp. Clean burner if flame is yellow-orange.

Regardless of size, always select cookware that is suitable for the amount and type of food being prepared. Select a burner and flame size appropriate to the pan. Never allow flames to extend beyond the outer edge of the pan.

Never extend the flame beyond the outer edge of the utensil. A higher flame wastes heat and energy and increases your risk of being burned by the flame (Figure 2).

For deep fat frying, use a thermometer and adjust the surface control knob accordingly. If the fat is too cool, the food will absorb the fat and be greasy. If the fat is too hot, the food will brown so quickly that the center will be undercooked. Do not attempt to deep fat fry too much food at once as the food will neither brown nor cook properly.

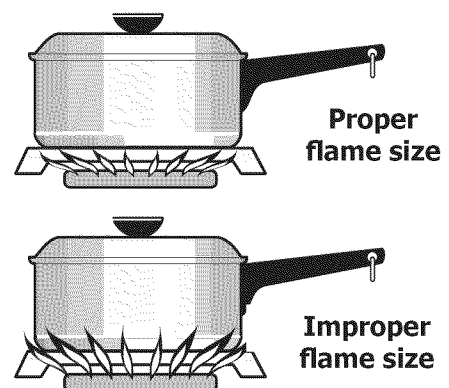

Figure 2

BEFORE SETTING OVEN CONTROLS

Oven vent location

Each oven has its own vent **as shown below** (Figure 1). When the oven is ON, warm air is released through the vent. This venting is necessary for proper air circulation in the oven and good baking results. **DO NOT BLOCK OVEN VENT.** Never close off the openings with aluminium foil or any other material.

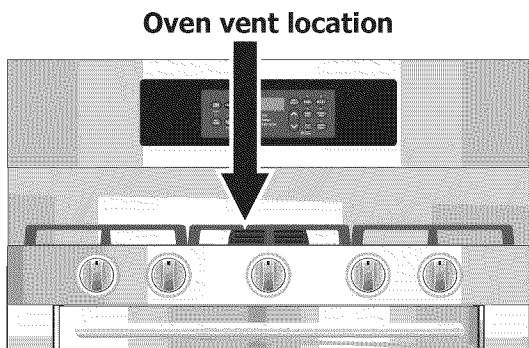

Figure 1

Air circulation in the oven

If using 1 rack (Figure 2), place in center of oven. If using multiple racks (Figure 3), stagger cookware as shown.

For best air circulation and baking results allow 2-4" (5-10 cm) around the cookware for proper air circulation and be sure pans and cookware do not touch each other, the oven door, sides or back of the oven cavity. The hot air must circulate around the pans and cookware in the oven for even heat to reach around the food.

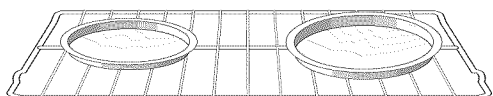

Figure 2 - Single Oven Rack

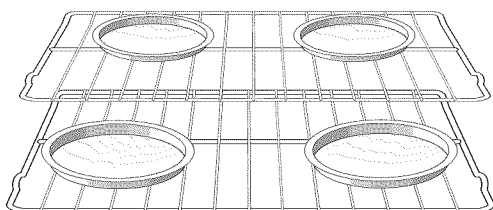

Figure 3 - Multiple Oven Racks

Arranging oven racks

ALWAYS ARRANGE OVEN RACKS WHEN THE OVEN IS COOL (PRIOR TO OPERATING THE OVEN). Always use oven mitts when using the oven.

To remove an oven rack, pull the rack forward until it stops. Lift up front of rack and slide out (Figure 4).

To replace an oven rack, fit the rack onto the guides on the oven walls. Tilt the front of the rack upward and slide the rack back into place.

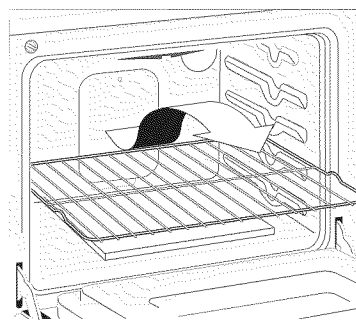

Figure 4

Recommended rack positions

Food	Rack Position
Broiling meats, chicken or fish	4
Cookies, cakes, pies, biscuits & muffins	
Using a single rack	2 or 3
Using two racks	2 and 4
Using multiple racks (If equipped with an offset rack)	2, 3 and 4 1, 3 (offset) 4
Frozen pies, angel food cake, yeast, bread, 1 or 2 casseroles, small cuts of meat or poultry	1 or 2
Turkey, roast or ham	1

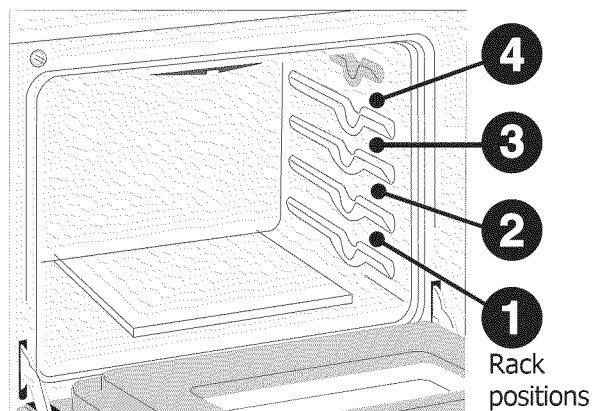

Figure 5

NOTE

Always use caution when removing food from the oven.

SETTING OVEN CONTROLS

Control pad features

READ THE INSTRUCTIONS CAREFULLY BEFORE USING THE OVEN. For satisfactory use of your oven, become familiar with the various features and functions of the oven as described below. **Detailed instructions for each feature and function follow later in this Use & Care Guide.**

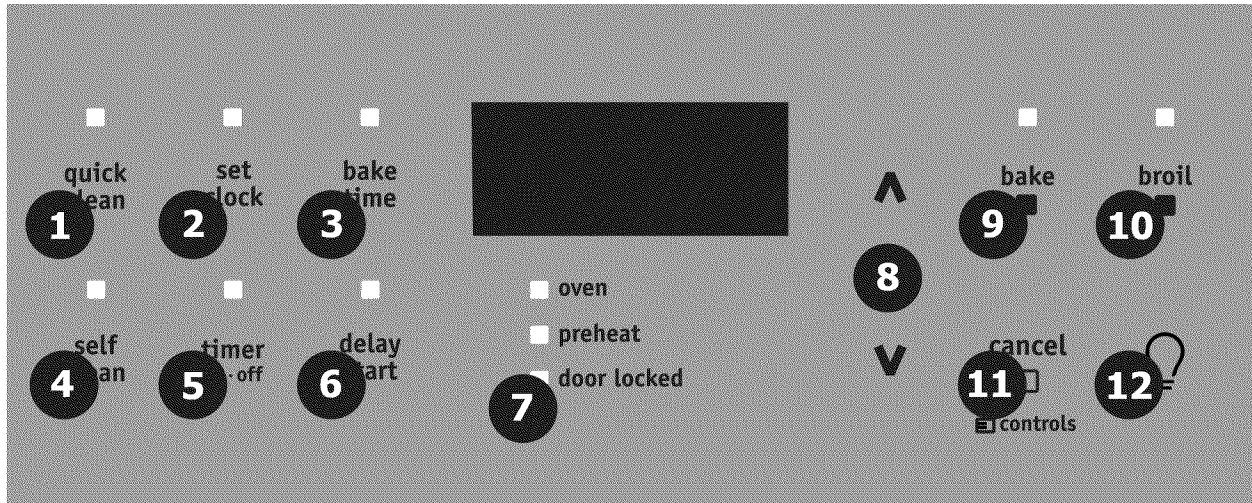

- 1. Quick Clean pad**—Use to select the 2 hours self cleaning cycle.
- 2. Set clock pad**—Use to set the time of day.
- 3. Bake time pad**—Use to enter the length of the baking time.
- 4. Self Clean pad**—Use to select a 3 hours self cleaning cycle.
- 5. Timer on-off pad**—Use to set or cancel the Timer. The Timer does not start or stop cooking.
- 6. Delay start pad**—Use to program a Delayed Timed Bake or Delay Self-Cleaning cycle start time.
- 7. Oven, preheat & door locked lights**— The oven light indicates that the oven is functioning. The Preheat light will glow when the oven is first set to operate, or if the desired temperature is reset higher than the actual oven temperature. The Door locked light will flash until the door locks when the self-clean cycle is in use. It glows constantly after the door locks.
- 8. Up and Down arrow pads**—Use along with the function pads to select oven temperature, cooking time, start time (when programming an automatic start time), time of day, clean time and minute timer.
- 9. Bake pad**—Use to enter the normal baking mode temperature.
- 10. Broil pad**—Use to select the variable broil feature.
- 11. Cancel pad**—Use to cancel any oven feature previously entered except the time of day and minute timer.
- 12. Oven light pad**—Use to turn the oven light ON and OFF.

SETTING OVEN CONTROLS

SETTING THE CLOCK

NOTE

Note: The time of day **must** first be set in order to operate the oven.

The **SET CLOCK** pad is used to set the clock. The clock may be set for 12 or 24 hour time of day operation. The clock has been preset at the factory for the 12 hour operation. When the range is first plugged in, or when the power supply to the range has been interrupted, the timer in the display will flash.

To set the clock

1. Press **Set Clock** pad once (do not hold pad down).
2. Within 5 seconds, push and hold the **Up** or **Down arrow** pad until the correct time of day appears in the display.
3. Press **Set Clock** pad to accept the new time of day. If **Set Clock** pad is not pressed, the timer will return automatically to the new time of day after 7 seconds.

NOTE

The clock cannot be changed during any bake, timed bake, delayed time bake, clean cycle, speed clean or delayed clean cycle.

CHANGING BETWEEN 12 OR 24 HOUR TIME OF DAY DISPLAY

1. Press and hold **SET CLOCK** for 7 seconds.
2. After 7 seconds, "**12h**" or "**24h**" will appear in the display and the control beep once.
3. Press **Up** or **Down arrow** pad to switch between the 12 and 24 hour time of day display. The display will show either "**12h**" or "**24h**".
4. Wait 5 seconds or press **CANCEL** pad to return to the time of day display.
5. Reset the correct time as described in **To set the Clock** above. Please note that if the 24 hour time of day mode was chosen, the clock will now display time from 0:00 through 23:59 hours.

SETTING SILENT CONTROL OPERATION

The **DELAY START** pad control the Silent Control operation feature. When choosing a function, a beep will be heard each time a pad is pushed. If desired, the control can be programmed for silent operation.

To tell if your oven is set for normal or silent operation push and hold Start Time pad for 7 seconds. "-- --" or "**SP**" appears in the display. Within 5 seconds, press the **Up** or **Down arrow** pad to switch between normal sound operation and silent operation mode. The display will show either "-- --" or "**SP**". Wait 5 seconds to return to normal operating mode

NOTE

If "**SP**" appears, the control will operate with the normal sounds and beeps. If "--" appears, the control is in silent operation mode.

SETTING TEMPERATURE DISPLAY — FAHRENHEIT OR CELSIUS:

The **BROIL** pad controls the Fahrenheit or Celsius temperature display modes. The oven control can be programmed to display temperatures in Fahrenheit or Celsius. The oven has been preset at the factory to display in Fahrenheit. The oven can be programmed to bake for any temperature from 170°F to 550° (77°C to 288°C).

To change display from Fahrenheit to Celsius or Celsius to Fahrenheit

1. Press and hold **BROIL** pad for 7 seconds until "**F**" or "**C**" appears in the display.
2. Press **Up** or **Down arrow** pad to change between Fahrenheit or Celsius display modes.
3. Wait 5 seconds or press **CANCEL** pad to accept the changes.

SETTING LOCKOUT FEATURE

The control can be programmed to lock the oven door and oven control pads. The oven lockout feature prevents the oven from being accidentally turned ON. It does not disable the clock, Minute Timer or the interior oven lights.

To set control for oven lockout feature

1. Press and hold **CANCEL** for 3 seconds. The door locked indicator light will flash and the motor driven door lock will begin to close automatically. **DO NOT** open the oven door while the indicator light is flashing. Allow about 15 seconds for the oven door to lock. Once the oven door is locked, "**Loc**" will appear in the display.
2. To cancel the oven lockout feature, press **CANCEL** pad and hold for 3 seconds. The control will unlock the oven door and resume normal operation.

SETTING MINUTE TIMER

1. Press the **Timer On-Off** pad.
2. Press the **Up arrow** pad to increase or **Down arrow** pad to decrease the time in one minute increments. The timer can be set for any amount of time from 1 minute to 11 hours and 59 minutes.
3. The display shows the timer count down in minutes if more than 1 hour remains. When less than 1 hour remains, the display will count down in seconds.
4. When the set time has run out, the timer will beep 3 times. It will continue to beep 3 times every 8 seconds until the **Timer On-Off** is pressed.

To cancel the Minute Timer before the set time has run out: Press **Timer On-Off**. The display will return to the time of day.

NOTE

The indicator light located above the **Timer On-Off** pad will glow while the minute timer is active.

The minute timer does not start or stop cooking. It serves as an extra timer in the kitchen that will beep when the set time has run out. The minute timer can be used alone or during any of the other oven functions. When the minute timer is in use with any other mode, the minute timer will be shown in the display. To view other functions, press the function pad for that mode.

SETTING CONTINUOUS BAKE OR 12 HOUR ENERGY SAVING

The oven control has a factory preset built-in 12 Hour Energy Saving feature that will shut off the oven if the oven control is left ON for more than 11 hours and 59 minutes. The oven can be programmed to override this feature for Continuous Baking.

To set the control for Continuous Baking

1. Press and hold **Timer On-Off** for 7 seconds until a tone is heard.
2. Within 5 seconds, press **Up** or **Down arrow** pad to switch between continuous bake and 12 Hour Energy Saving mode. The display will show either “- -hr” or “12hr”. If “- -hr” appears, the oven will be set to continuous baking. If “12hr” appears, the oven is set to 12 hour energy saving mode.
3. Wait 5 seconds or press **CANCEL** pad to accept the changes.

SETTING BAKE

The oven can be programmed to bake at any temperature from 170°F to 550°F.

To set the control for baking

1. Arrange interior oven racks and place food in oven.
2. Press **BAKE** pad. “- - °” appears in the display.
3. Within 5 seconds, press **Up** or **Down arrow** pad. The display will show “350°F (177°C)”. By holding the **Up** or **Down arrow** pad, the temperature can be adjusted in “5°F (1°C, if control is set to display Celsius)” increments.
4. 8 seconds after the **Up** or **Down arrow** pad is released, the oven will begin heating to the selected temperature. When the temperature reaches the desired baking temperature, the preheat indicator light will turn off and a beep will sound.
5. To cancel the baking function, press **CANCEL** pad.

To change the Bake Temperature after baking has started: Press the **Up** or **Down arrow** pad to increase or decrease the set temperature.

OVEN LIGHT

The interior oven light will automatically turn ON when the oven door is opened.

Press  pad to turn the interior light ON and OFF whenever the door is closed.

The interior oven light is located at the upper left (and right, some models) rear wall of the oven interior and is covered with a glass shield held by a wire holder. The glass shield must be in place whenever the oven is in use.

To change the interior oven lights, see “Changing the oven light” in the **Care & Cleaning** section.

SETTING OVEN CONTROLS

SETTING BROIL

Broiling is a method of cooking tender cuts of meat by direct heat under the broil element of the oven. Be sure you center broiler pan directly under the broil element for best results.

Arrange oven rack while oven is still cool. Position the rack as needed. The broiler pan and its insert allow dripping grease to drain and kept away from the high heat of the broiler. **DO NOT** use the broiler pan without its insert. **DO NOT Cover the insert with foil.** The exposed grease could ignite.



WARNING

Should an oven fire occur, leave the oven door closed and turn off the oven. If the fire continues, throw baking soda on the fire or use a fire extinguisher. **DO NOT** put water or flour on the fire. Flour may be explosive and water can cause a grease fire to spread and cause personal injury.

Accessories available by mail order via the enclosed brochure:

Broiler Insert

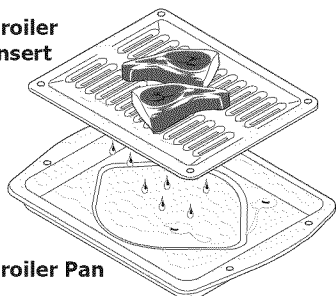

Broiler Pan

Figure 1

Searing Grill



Figure 2

To set a Broil of 550°F:

1. Place the food on a broiler pan insert. **DO NOT** use the broiler pan without the insert. **DO NOT** cover the broiler insert with foil. The exposed grease could ignite.
2. Arrange the interior oven rack while oven is still cool. Be sure to center the broiler pan directly under the broiler element. **Make sure the oven door is closed.**
3. Press the **Broil** pad. "- -" will appear in the display.
4. Press **Up** or **Down arrow** pad until the desired broil setting level appears in the display. Press the **Up arrow** pad for Hi broil or **Down arrow** pad for Lo broil. Most foods may be broiled at the Hi broil setting. Select the Lo broil setting to avoid excess browning or drying of foods that should be cooked to the well-done stage.
5. Broil one side until food is browned. Turn and broil food on second side. Season and serve. **Note:** Always pull the rack out to the stop position before turning or removing food.
9. When broiling is finished, press the **CANCEL** pad.

Electric Oven Broiling Table Recommendations

Food Item	Rack Position	Temperature Setting	Cook Time		Doneness
			1st side	2nd side	
Steak 1" thick	3rd or 4th	550° F	8:00	6:00	Rare
	3rd or 4th	550° F	10:00	8:00	Medium
Pork Chops 3/4" thick	3rd	550° F	12:00	8:00	Well
Chicken - Bone In	2nd	450° F	25:00	15:00	Well
Chicken - Boneless	3rd	450° F	10:00	8:00	Well
Fish	3rd	500° F	as directed	as directed	Well
Shrimp	2nd	550° F	as directed	as directed	Well
Hamburger 1" thick	4th	550° F	12:00	10:00	Medium
	3rd	550° F	14:00	12:00	Well

SETTING OVEN CONTROLS

SETTING BAKE TIME AND DELAY START

The Bake Time and Start Time pads operate the features that will turn the oven ON and OFF at the times you select in advance. The oven can be programmed to start immediately and shut off automatically (timed bake) or to begin baking at a later time with a delayed start (Delay start).

NOTE

During Timed bake the preheat indicator light will function during the preheat operation.

To program the oven to begin baking immediately and to shut off automatically (Timed bake):

1. Be sure the clock is set for the correct time of day.
2. Arrange interior oven rack(s) and place the food in the oven.
3. Press **BAKE**, "-- °" appears in the display.
4. Within 5 seconds, press **Up** or **Down arrow** pad. The display will show "350°". By holding the **Up** or **Down arrow** pad, the temperature can then be adjusted in **5°F** increments (1°C if the control is set to display Celsius).
5. Wait 8 seconds to accept the temperature.
6. Press **Bake time** pad. "0:00" will flash in the display (min:sec) if programmed for more than 60 minutes.
7. Press **Up** or **Down arrow** pad until the desired baking time appears in the display.
8. The oven will turn ON and begin heating.

To program the oven for a delayed start time and to shut-off automatically:

1. Be sure that the clock is set with the correct time of day.
2. Arrange interior oven racks and place the food in the oven.
3. Press **BAKE**, "-- °" appears in the display.

4. Within 5 seconds, press **Up** or **Down arrow** pad. The display will show "350°". By holding the **Up** or **Down arrow** pad, the temperature can then be adjusted in **5°F** increments (1°C if the control is set to display Celsius).
5. Wait 8 seconds to accept the temperature.
6. Press **Bake time** pad. "0:00" will flash in the display (min:sec) if programmed for more than 60 minutes.
7. Press **Up** or **Down arrow** pad until the desired baking time appears in the display.
8. Wait 5 seconds for the control to accept the time.
9. Press **Start time** pad. The earlier possible start time will appear in the display.
10. Press **Up** or **Down arrow** pad until the desired start time appears in the display and wait 7 seconds to accept.
11. Once the controls are set, the control calculates the time when baking will start and stop.
12. The oven will turn ON at the delay delayed start time and begin heating.

To change the oven temperature or bake time after baking has started:

1. Press the function pad you want to change.
2. Press **Up** or **Down arrow** pad to adjust the setting.

When the timed bake finishes:

1. "End" will show in display. The oven will shut off automatically.
2. The control will beep 3 times. The control will continue to beep 3 times every 30 seconds until **CANCEL** is pressed.

NOTE

After the Timed Bake feature has activated, press **BAKE TIME** to display the bake time remaining in the Bake Time mode. Once Bake Time has started baking, a beep will sound when the oven temperature reaches the set temperature.

Baking time can be set for any amount of time between 1 minute to 11 hours 59 minutes.

CAUTION

Use caution with the **DELAY START** features. Use the automatic timer when cooking cured or frozen meats and most fruits and vegetables. Foods that can easily spoil such as milk, eggs, fish, meat or poultry, should be chilled in the refrigerator first. Even when chilled, they should not stand in the oven for more than 1 hour before cooking begins, and should be removed promptly when cooking is completed. Eating spoiled food can result in sickness from food poisoning.

SETTING OVEN CONTROLS

SETTING THE SABBATH FEATURE

(for use on the Jewish Sabbath & Holidays)

The **BAKE TIME** and **DELAY START** pads are used to set the Sabbath feature. The Sabbath feature may only be used with the **BAKE** pad. The oven temperature may be set higher or lower after setting the Sabbath feature (the oven temperature adjustment feature should be used only during Jewish Holidays), however the display will not visibly show or provide any audible tones indicating whether the change occurred correctly. Once the oven is properly set using Bake with the Sabbath feature active, the oven will remain continuously ON until cancelled. This will override the factory preset 12-Hour Energy Saving feature.

If the oven lights are needed during the Sabbath, press  before activating the Sabbath feature. Once the oven light is turned ON and the Sabbath feature is active, the oven light will remain ON until the Sabbath feature is turned OFF. If the oven lights need to be OFF, be sure to turn the oven lights OFF before activating the Sabbath feature.

IMPORTANT

It is not advised to attempt to activate any other program feature other than **BAKE** while the Sabbath feature is active. ONLY the following key pads will function after setting the Sabbath feature; **Up** or **Down Arrow**, **Bake**, & **Cancel**. All other keypads should not be used once the Sabbath feature is properly activated.

To Program the Oven to Begin Baking Immediately & activate the Sabbath feature

1. Be sure that the clock is set with the correct time of day.
2. Arrange the oven racks and place the food in the oven.
3. Press **BAKE**. "-- °" appears in the display.
4. Within 5 seconds, press the **Up** or **Down arrow** pad. The display will show "350°". By holding the **Up** or **Down arrow** pad, the temperature can then be adjusted in 5°F increments (1°C if the control is set to display Celsius).
5. If you desire to set the oven control for a **Timed Bake** or **Delayed Timed Bake** do so at this time. If not, skip this step and continue to step 6. Refer to the **Timed Bake/ Delay Timed Bake** section for complete instructions. Remember the oven will shut down after completing a **Timed Bake/ Delay Timed Bake** and therefore may only be used once during the Sabbath/Jewish Holidays. The maximum start time is 11 hours & 59 minutes.
6. The oven will turn ON and begin heating.

7. Press and hold both the **BAKE TIME** and **DELAY START** pads for at least **3 seconds**. "Sab" will appear in the display. Once "Sab" appears in the display the oven control will no longer beep or display any further changes and the oven is properly set for the Sabbath feature.

NOTE

You may change the oven temperature once baking has started by pressing **Up** or **Down arrow** (for Jewish Holidays only). The oven temperature will be adjusted in 5°F increments with each press of these pads (1°C the control is set to display Celsius). Remember that **the oven control will no longer beep or display any further changes** once the oven is set for the Sabbath feature.

8. The oven may be turned OFF at any time by pressing **CANCEL** pad (this will turn the oven OFF only). To turn OFF the Sabbath feature press and hold both the **Bake Time** and **Delay Start** pads for at least **3 seconds**. "Sab" will disappear from the display.

It is recommended that at any oven temperature change with the Sabbath feature activated be followed with 2 presses of the **START** pad. This will insure the oven remains ON even if the attempt to set the oven temperature was lower or higher than what the oven control can accept. If the oven temperature is set incorrectly, the oven temperature will default to 170°F or 550°F. Try to set the desired oven temperature again.

Should you experience a power failure or interruption, the oven will shut off. When power is returned the oven will NOT turn back ON automatically. The oven will remember that it is set for the Sabbath and the food may be safely removed from the oven while still in the Sabbath feature, however the oven cannot be turned back ON until the Sabbath feature is cancelled.

After the Sabbath observance turn OFF the Sabbath feature, press and hold both the **BAKE TIME** and **DELAY START** pads for at least **3 seconds**. "Sab" will disappear from the display and the oven may be used with all normal functions.

For further assistance, guidelines for proper usage, and a complete list of models with the Sabbath feature, please visit the web at <http://www.star-k.org>.

SETTING OVEN CONTROLS

SELF-CLEANING

A self-cleaning oven cleans itself with high temperatures (well above normal cooking temperatures) which eliminate soils completely or reduces them to a fine powdered ash you can wipe away with a damp cloth.

➔ IMPORTANT

Adhere to the following cleaning precautions:

- Allow the oven to cool before cleaning.
- Wear rubber gloves when cleaning any exterior parts of the oven manually.
- **DO NOT** use oven cleaners or oven protective coatings in or around any part of the oven interior.
- **DO NOT** clean the oven door gasket. The woven material of the oven door gasket is essential for a good seal. Care should be taken not to rub, damage or remove the gasket.
- **DO NOT** use any cleaning materials on the oven door gasket. Doing so could cause damage.
- **Remove the broiler pan and insert, all utensils and ANY ALUMINUM FOIL. These items cannot withstand high cleaning temperatures and will melt.**
- **Completely remove ALL OVEN RACKS and ANY ACCESSORIES. If the oven racks are not removed, they will lose their special coating properties and will no longer slide in and out of the oven cavity effortlessly.**
- **Remove any excessive spillovers** in the oven cavity **before** starting the Self-Cleaning cycle. To clean, use hot, soapy water and a cloth. Large spillovers can cause heavy smoke or fire when subjected to high temperatures. **DO NOT** allow food spills with a high sugar or acid content (such as milk, tomatoes, sauerkraut, fruit juices or pie filling) to remain on the surface as they may leave a dull spot even after cleaning.
- Clean any soil from the oven frame, the door liner outside the oven door gasket and the small area at the front center of the oven bottom. These areas heat sufficiently to burn soil on. Clean with soap and water.

📌 NOTE

See additional cleaning information for the oven door in the **General Care & Cleaning** section.

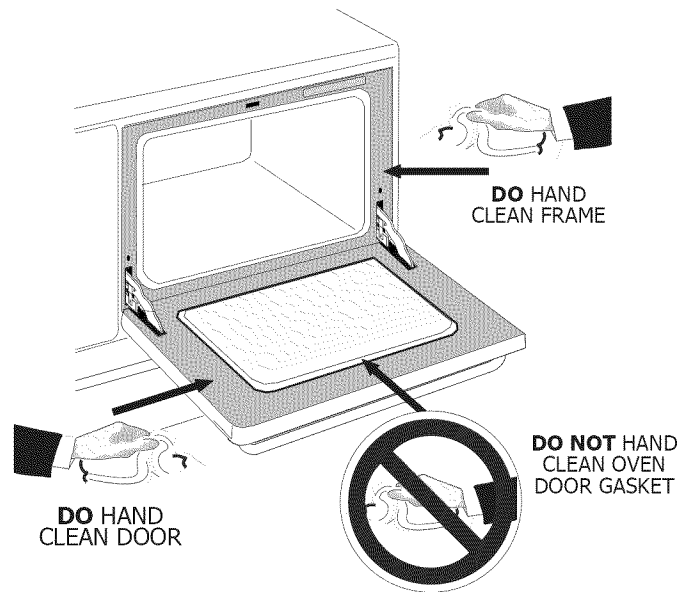

What to Expect during Cleaning

While the oven is in operation, the oven heats to temperatures much higher than those used in normal cooking. Sounds of metal expansion and contraction are normal. Odor is also normal as the food soil is being removed. Smoke may appear through the oven vent.

If heavy spillovers are not wiped up before cleaning, they may flame and cause more smoke and odor than usual. This is normal and safe and should not cause alarm. If available, use an exhaust fan during the self-cleaning cycle.

⚠ CAUTION

To avoid possible burns use care when opening the oven door after the Self-Cleaning cycle. Stand to the side of the oven when opening the door to allow hot air or steam to escape.

During the Self-Cleaning cycle, the outside of the range can become very hot to the touch. **DO NOT** leave small children unattended near the appliance.

The health of some birds is extremely sensitive to the fumes given off during the Self-Cleaning cycle of any range. Move birds to another well-ventilated room.

DO NOT line the oven walls, racks, bottom or any other part of the range with **aluminum foil**. Doing so will destroy heat distribution, produce poor baking results and cause permanent damage to the oven interior (aluminum foil will melt to the interior surface of the oven).

DO NOT force the oven door open. This can damage the automatic door locking system. Use caution when opening the door after the Self-Cleaning cycle is completed. The oven may still be **VERY HOT**.

SETTING OVEN CONTROLS

SETTING QUICK CLEAN OR SELF-CLEAN CYCLE TIME LENGTH

The **Quick Clean** and **Self Clean** pads control the Self-Cleaning feature. If you are planning to use the oven directly after a self-clean cycle remember to allow time for the oven to cool down and the oven door to unlock. This normally takes about one hour. So a 3 hour self-clean cycle will actually take about 4 hours to complete.

*It is recommend to use a 2 hour **Quick clean** cycle for **light soils**, a 3 hour **Self clean** cycle for **average or heavy soils** (to assure satisfactory results).

To set the controls for a Quick Clean or a Self Clean cycle or a Delay Start Quick Clean or a Delay Start Self Clean cycle

1. Be sure the clock is set with the correct time of day and the oven door is closed.
2. Press **Start time** pad.
3. Press and hold the **Up Arrow** pad to scroll to the time to start the delayed Self Clean cycle. Release the pad when the desired time is displayed.
4. Press Quick Clean (for a 2 hour cycle) or Self Clean pad (for a 3 hour cycle). "- -" appears in the display.
5. Press the **Up Arrow** pad once. As soon the controls are set, the motor driven lock will begin to close automatically and the door locked indicator light will flash. **DO NOT** open the oven door while the light is flashing (It takes about 15 seconds for the oven door to lock).
6. "**CLn**" will appear in the display during the Self Clean cycle and the Door Locked light will glow until the Self Clean cycle is completed or cancelled and the oven temperature has cooled.

When the Self-Clean Cycle is Completed

1. The time of day or "**End**" will appear in the display window and "**CLEAN**" and "**DOOR LOCK**" light will continue to glow.
2. Once the oven has cooled down for about 1 HOUR, and the "**DOOR LOCK**" light has gone out, the oven door can be opened.
3. If "**End**" is in the display and clean indicator light remains ON, press the **CANCEL** pad. The time of day will appear in the display.

NOTE

When the oven is cool, wipe away any residue or powdered ash with damp cloth or paper towel.

Stopping or Interrupting a Quick Clean or Self Clean Cycle

If it becomes necessary to stop or interrupt a self clean cycle:

1. Press **CANCEL**.
2. Once the oven has cooled down for about 1 hour and the "**DOOR LOCK**" light has gone out, the oven door can be opened.
3. Restart the Self Clean cycle once all conditions have been corrected.

ADJUSTING OVEN TEMPERATURE

Your oven thermostat has been precisely set at the factory. This setting may be differ from your previous oven, however, so your recipe times may not give you the results you expect. If you think the oven is cooking too hot or cool for your recipe times, you can adjust the thermostat so that the oven cooks hotter or cooler then the temperature displayed.

NOTE

The oven temperature adjustments made with this feature will not change the Self-Clean cycle temperature.

To adjust the oven temperature:

1. Press and hold the **BAKE** pad for 8 seconds. The display now indicates the amount of degrees offset between the original factory temperature setting and the current temperature setting. If the oven controls has the factory calibration, the display will read "**0°**".
2. The temperature can now be adjusted up or down 35°F or 19°C, in 1°F or 1°C steps by pushing and holding the **Up** or **Down arrow** pad. Adjust until he desired amount of degrees offset appears in the display. When lowering the oven temperature, a minus sign (-) will appear before the number to indicate that the oven will be cooler by the displayed amount of degrees.
3. When you have made the desired adjustment, wait 5 seconds and the display will go back to the time of day.

CARE & CLEANING (Cleaning Chart)

Cleaning various parts of your appliance

Before cleaning any part of the appliance, be sure all controls are turned off and the appliance is COOL. REMOVE SPILLOVERS AND HEAVY SOILING AS SOON AS POSSIBLE. REGULAR CLEANING WILL REDUCE THE NUMBER OF MAJOR CLEANING LATER.

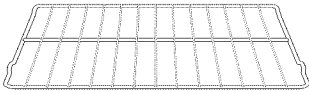
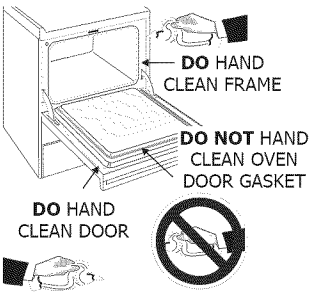
Surfaces	How to Clean
Aluminum (trim pieces) & Vinyl	Use hot, soapy water and a cloth. Dry with a clean cloth.
Glass, Painted and Plastic Body Parts, Control Knobs & Decorative Trim Pieces	Using a soft cloth, clean with mild dish detergent and water or a 50/50 solution of vinegar and water. Follow by rinsing the area with clean water; dry and polish with a soft cloth. Glass cleaners may be used if sprayed on a soft cloth first. DO NOT spray liquids directly on the control pad and display area. Do not use large amounts of water on the control panel - excess water on the control area may cause damage to the appliance. Do not use other liquid cleaners, abrasive cleaners, scouring pads, or paper towels - they will damage the finish. To remove control knobs, turn to the OFF position; grasp firmly and pull straight off the shaft. To replace knobs after cleaning, line up the flat sides of both the knob and the shaft; then push the knob into place.
Porcelain Enamel Burner Grates, Cooktop Surface, Below Cooktop, Broiler Pan & Insert (some models), Door Liner, Oven Bottom & Burner Drip Pans	Clean burner grates, broiler pan and insert (some models) in the dishwasher and dry upon removal. If soils are not removed, follow the cooktop cleaning instructions below. Gentle scouring with a soapy scouring pad will remove most spots. Rinse with a 1:1 solution of clear water and ammonia. If necessary, cover difficult spots with an ammonia-soaked paper towel for 30 to 40 minutes. Rinse with clean water and a damp cloth, then scrub with a soap-filled scouring pad. Rinse and wipe dry with a clean cloth. Remove all cleaners or the porcelain may become damaged during future heating. DO NOT use spray oven cleaners on the cooktop.
Stainless Steel Oven Door & Drawer Front Panel and Decorative Trim	Clean with hot, soapy water and dishcloth. Rinse with clean water and cloth. Do not use cleaners with high concentrations of chlorides or chlorines. Do not use harsh scrubbing cleaners. Only use kitchen cleaners that are especially made for cleaning stainless steel. Always be sure to rinse the cleaners off from the surface as bluish stains may occur during heating that cannot be removed.
Oven Racks 	Remove racks. See "To remove and to replace an oven rack" under Oven vent(s) and racks. Use a mild, abrasive cleaner, following manufacturer's instructions. Rinse with clean water and dry. After cleaning the racks, rub the sides of the racks with wax paper or a cloth containing a small amount of baby oil or salad oil (this will make the racks glide easier into the rack positions).
Oven Door 	Use soap & water to thoroughly clean the top, sides and front of the oven door. Rinse well. You may use a glass cleaner on the outside glass of the oven door. DO NOT immerse the door in water. DO NOT spray or allow water or the glass cleaner to enter the door vents. DO NOT use oven cleaners, cleaning powders or any harsh abrasive cleaning materials on the outside of the oven door. DO NOT clean the oven door gasket. The oven door gasket is made of a woven material, on Self-Cleaning models, which is essential for a good seal. Care should be taken not to rub, damage or remove this gasket.

CARE & CLEANING

Ceramic glass cooktop cleaning & maintenance

Consistent and proper cleaning is essential to maintaining your Ceramic glass cooktop.

Prior to using your cooktop for the first time, apply some of cooktop cleaning creme to the ceramic surface. Clean and buff with a non abrasive cloth or pad. This will make cleaning easier when soiled from cooking. The special cooktop cleaning cream leaves a protective finish on the glass to help prevent scratches and abrasions.

Sliding aluminum or copper clad bottom pans on the cooktop can cause metal markings on the cooktop surface. These marks should be removed **immediately** after the cooktop has cooled using the cooktop cleaning cream. Metal marks can become permanent if not removed prior to future use.

Cookware (cast iron, metal, ceramic or glass) with rough bottoms can mark or scratch the cooktop surface. **Do not slide anything metal or glass** across the cooktop. **Do not** use your cooktop as a cutting board or work surface in the kitchen. **Do not** cook foods directly on the cooktop surface without a pan. **Do not** drop heavy or hard objects on the glass cooktop, or they may crack it.

Cleaning recommendations for the ceramic glass cooktop

CAUTION

Before cleaning the cooktop, be sure the controls are turned to **OFF** and the cooktop is **COOL**.

WARNING

DO NOT use a cooktop cleaner on a hot cooktop. The fumes can be hazardous to your health, and can chemically damage the ceramic glass surface.

For light to moderate soil:

Apply a few drops of CookTop® Cleaning Creme directly to the cooktop. Use a paper towel or use a **non-abrasive** plastic type **no-scratch** pad to clean the entire cooktop surface. Make sure the cooktop is cleaned thoroughly, leaving no residue.

For heavy, burned on soil:

Apply a few drops of CookTop® Cleaning Creme directly to the soiled area. Rub the soiled area using a **non-abrasive** plastic type **no-scratch** pad, applying pressure as needed. Do not use the pad you use to clean the cooktop for any other purpose.

IMPORTANT

Damage to the ceramic glass cooktop may occur if you use an abrasive type scratch pad. Only use cleaning products that have been specifically designed for ceramic glass cooktop.

If soils remain, carefully scrape soils with a metal razor blade scraper, holding scraper at a 30 degree angle to the surface. Remove loosened soils, then apply a few drops of cleaning cream and buff surface clean.

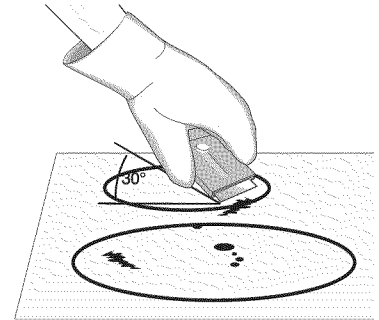

Plastic or foods with a high sugar content:

These types of soils need be removed immediately if spilled or melted onto the ceramic cooktop surface. Permanent damage (such as pitting of the cooktop surface) may occur if not removed **immediately**. After turning the surface elements **OFF**, use a razor blade scraper or a metal spatula with a mitt and scrape the soil from the hot surface (as illustrated). Allow the cooktop to cool, and use the same method for heavy or burned on soils.

Do not use the following on the ceramic glass cooktop:

- **Do not use abrasive cleaners and scouring pads, such as metal and some nylon pads. They may scratch the cooktop, making it more difficult to clean.**
- **Do not use harsh cleaners, such as chlorine bleach, ammonia or oven cleaners, as they may etch or discolor the cooktop.**
- **Do not use dirty sponges, cloths or paper towels, as they can leave soil or lint on the cooktop which can burn and cause Special Caution for Aluminum Foil and Aluminum Cooking Utensils**

• Aluminum foil

Use of aluminum foil will damage the cooktop. Do not use under any circumstances.

• Aluminum utensils

Since the melting point of aluminum is much lower than that of other metals, care must be taken when aluminum pots or pans are used. Pans that boil dry may permanently damage cooktop by breaking, fusing to, or marking it.

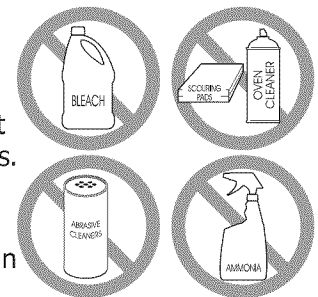

Cleaning Burner Heads, Caps & Grates

The cooktop is designed to make cleaning easier. Because the gas Burners are sealed, cleanups are easy when spills are cleaned up immediately.

The cooktop, Burner Heads and Caps should be routinely cleaned. Keeping the Burner Head Ports clean will prevent improper ignition and an uneven flame. Refer to the following instructions:

THE COOKTOP IS NOT REMOVABLE. Do not attempt to remove or lift the cooktop.

THE FIXED OVEN VENT IS NOT REMOVABLE. Do not attempt to remove the fixed oven vent cover.

CAUTION

Use caution when replacing the Burner Caps so the Electrodes are not damaged. This may cause a delayed ignition or prevent the burner from igniting.

To Remove and Replace the Surface Burner Caps and Burner Heads - Remove in the following order: (1st) surface Burner Grates, (2nd) Burner Caps and (3rd) Burner Heads. Replace in the following order: Burner Heads, Burner Caps and Burner Grates.

Do not remove any parts from the cooktop until they have completely cooled and are safe to handle. Do not operate the surface Burners without the Burner Caps and Burner Heads properly in place.

To Clean the surface Burner Caps and Burner Heads- Use a soap-filled scouring pad or a mild abrasive cleanser to clean the surface Burner Caps and Burner Heads. The ports (or slots) around the Burner Heads must be routinely cleaned. If residue still remains in these ports, use a small-gauge wire or needle to clean the slots or holes. For proper flow of gas and ignition of the burner—**DO NOT ALLOW SPILLS, FOOD, CLEANING AGENTS OR ANY OTHER MATERIAL TO ENTER THE GAS ORIFICE HOLDER OPENING. ALWAYS** keep the surface Burner Caps and Burner Heads in place whenever the gas Burners are in use.

To Clean the Burner Grates- The Burner Grates are dishwasher safe and may be cleaned in the dishwasher. Remove any excessive soils before placing in the dishwasher.

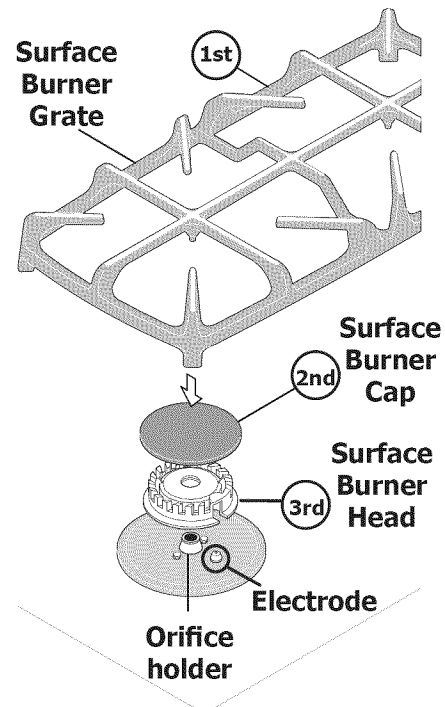

Care and cleaning of stainless steel

Some models are equipped with stainless steel exterior parts. Special care and cleaning are **required** for maintaining the appearance of stainless parts. Refer to the **General Care & Cleaning** table for detailed cleaning instructions.

Removing and Replacing Oven Bottom

To Remove the Oven Bottom:

Grasp the oven bottom by the front corner on each side, slide toward you and lift up the oven bottom.

To Replace the Oven Bottom:

1. Grasp the oven bottom and position the back tabs in place in the slots at the rear of the oven.
2. Lower the front of the oven bottom and slide into place.

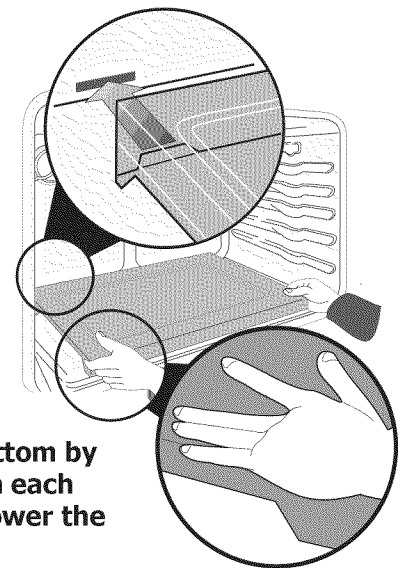

Grasp the oven bottom by the front corner on each side to raise and lower the oven bottom.

CARE & CLEANING

Removing and replacing the main oven door

CAUTION

The door is heavy. For safe, temporary storage, lay the door flat with the inside of the door facing down. The oven door can be removed to make oven cleaning easier.

To Remove Oven Door:

1. Open door approximately 4 inches to the stop position.
2. Grasp door at side edges.
3. Lift door up and off hinges.
4. To clean oven door, see the cleaning chart at beginning of this section.

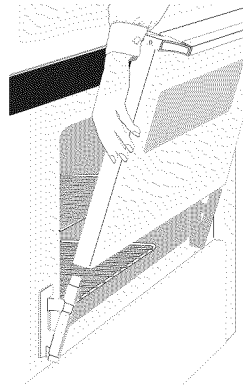

To Replace Oven Door:

1. Be sure the hinge arms are in the stop position. Be careful if pulling the hinges open by hand. The hinges may snap back against the oven frame and could pinch fingers.
2. Hold the door at the sides near the top.
3. Slide the door down onto the hinges as far as it will go and close the door.
4. If the door is not in line with the oven frame, remove door and repeat the above steps.

Storage Drawer

Use the storage drawer for storing cooking utensils. The drawer can be removed to facilitate cleaning under the range. Use care when handling the drawer.

To open the storage drawer, push the drawer in gently and it will spring open. To close, push the drawer until you hear a click, which indicates that the spring is compressed, and the drawer is closed.

To Remove the Storage Drawer:

1. Open and empty the drawer of all utensils.
2. Pull drawer out to the drawer stop.
3. Lift the front high enough to allow the drawer to be pulled out.

To Replace the Storage Drawer:

1. Insert the rear end of the drawer into the opening.
2. Fit the end rollers onto the guide rails.
3. Hold the drawer in a horizontal position, then push in until a click is heard.

WARNING

Flammable materials should not be stored in an oven, near surface elements or in the storage drawer. This includes paper, plastic and cloth items, such as cookbooks, plasticware and towels, as well as flammable liquids. Do not store explosives, such as aerosol cans, on or near the range. Flammable materials may explode and result in fire or property damage.

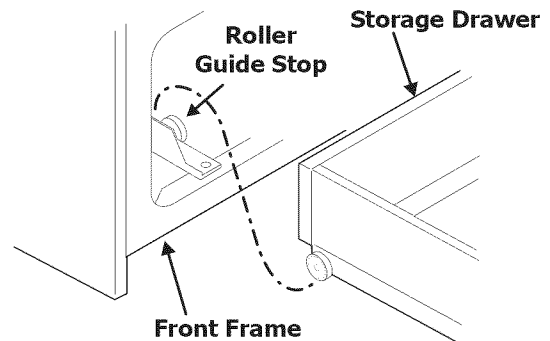

Changing oven light

CAUTION

Be sure the oven is unplugged and all parts are COOL before replacing the oven light bulb. Do not turn the oven light on during a self-cleaning cycle. High temperature will reduce lamp life.

The interior oven light will turn ON automatically when the oven is opened. The oven light may be turned on when the door is closed by using the oven light switch located on the Electronic Oven control. The oven light bulb is covered with a glass shield held in place by a wire holder. THIS GLASS SHIELD MUST ALWAYS BE IN PLACE WHEN THE OVEN IS IN USE.

CAUTION

BE SURE OVEN IS COOL

To Replace the Light Bulb:

1. Turn the power OFF at the main source.
2. Wear a leather-faced glove for protection against possible broken glass.
3. Replace bulb with a 40 Watts appliance bulb only.
4. Press wire holder to one side to release glass shield, change bulb and be sure to replace glass shield.

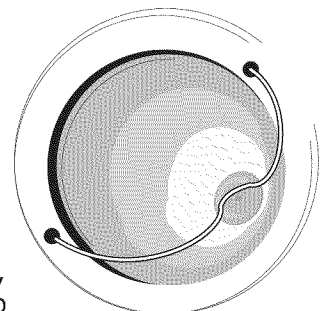

BEFORE YOU CALL (Solutions to Common Problems)

Oven baking

For best cooking results, heat the oven before baking cookies, breads, cakes, pies or pastries, etc. There is no need to preheat the oven for roasting meat or baking casseroles.

The cooking times and temperatures needed to bake a product may vary slightly from your previously owned appliance.

Baking Problems and Solutions Chart

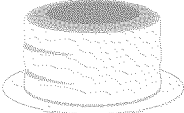
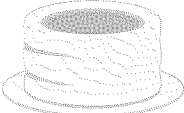
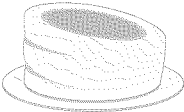
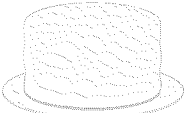
Baking Problems	Causes	Corrections
<p>Cookies and biscuits burn on the bottom.</p> 	<ul style="list-style-type: none"> • Cookies and biscuits put into the oven before the preheating time is completed. • Oven rack overcrowded. • Dark pan absorbs heat too fast. 	<ul style="list-style-type: none"> • Allow oven to preheat to the selected temperature before placing food in oven. • Choose pan sizes that will permit 5.1cm to 10.2cm (2" to 4") of air space on all sides when placed in the oven. • Use a medium-weight aluminum baking sheet.
<p>Cakes too dark on top or bottom.</p> 	<ul style="list-style-type: none"> • Cakes put into the oven before preheating time is completed. • Rack position too high or low. • Oven too hot. 	<ul style="list-style-type: none"> • Allow oven to preheat to the selected temperature before placing food in the oven. • Use proper rack position for baking needs. • Set oven temperature 25°F/12°C lower than recommended.
<p>Cakes not done in the center.</p> 	<ul style="list-style-type: none"> • Oven too hot. • Incorrect pan size. • Pan not centered in oven. 	<ul style="list-style-type: none"> • Set oven temperature 25°F/12°C lower than recommended. • Use pan size suggested in recipe. • Use proper rack position and place pan so there is 5.1cm to 10.2cm (2" to 4") of space on all sides of pan.
<p>Cakes not level.</p> 	<ul style="list-style-type: none"> • Range not level. • Pan too close to oven wall or rack overcrowded. • Pan warped. 	<ul style="list-style-type: none"> • Place a marked glass measuring cup filled with water on the center of the oven rack. If the water level is uneven, refer to the installation instructions for leveling the range. • Be sure to allow 5.1cm to 10.2cm (2" to 4") of clearance on all sides of each pan in the oven. • Do not use pans that are dented or warped.
<p>Foods not done when cooking time is up.</p> 	<ul style="list-style-type: none"> • Oven too cool. • Oven overcrowded. • Oven door opened too frequently. 	<ul style="list-style-type: none"> • Set oven temperature 25°F/12°C higher than suggested and bake for the recommended time. • Be sure to remove all pans from the oven except the ones to be used for baking. • Open oven door only after shortest recommended baking time.

BEFORE YOU CALL (Solutions to Common Problems)

➔ IMPORTANT

Before you call for service, review this list. It may save you time and expense. The list includes common occurrences that are not the result of defective workmanship or materials in this appliance.

OCCURRENCE	POSSIBLE CAUSE/SOLUTION
Range is not level.	<p>Poor installation. Place oven rack in center of oven. Place a level on the oven rack. Adjust leveling legs at base of range until the rack is level. When range is level, cooktop may appear out of alignment if countertop is not level.</p> <p>Weak, unstable floor. Be sure floor is level and can adequately support range. If floor is sagging or slopping, contact a carpenter to correct the situation.</p> <p>Kitchen cabinet misalignment may make range appear to be un level. Be sure cabinets are square and have sufficient room for range clearance.</p>
Cannot move appliance easily. Appliance must be accessible for service.	<p>Cabinets not square or are built in too tight. Contact a cabinet maker to correct the problem.</p> <p>Contact builder or installer to make appliance accessible.</p> <p>Carpet interferes with range. Provide sufficient space so range can be lifted over carpet.</p> <p>Gas line is hard-plumbed. Have a flexible C.S.A. international approved metal appliance connector installed.</p>
Entire range or oven does not operate.	<p>Make sure cord/plug is plugged tightly into outlet.</p> <p>Service wiring is not complete. Call an authorized servicer.</p> <p>Electrical power outage. Check house lights to be sure. Call your local electric company for service. Surface burners can be lit manually.</p>
Oven control beeps and displays any F code error (ex.: F10)	<p>Electronic control has detected a fault condition. Press CANCEL to clear the display and stop beeping. Reprogram oven. If fault recurs, record fault number. Press CANCEL and call an authorized servicer for assistance.</p>
Oven light does not work.	<p>Replace or tighten bulb. See Changing Oven Light section in this Use & Care Guide.</p> <p>Electrical power outage. Check house lights to be sure. Call your local electric company for service.</p>
Surface unit does not heat.	<p>No power to the appliance. Check steps under "Entire Range or Oven Does Not Operate" in this Before you Call checklist.</p> <p>Incorrect control setting. Make sure the correct control is on for the surface unit to be used.</p>
Surface burners do not light.	<p>Surface control knob has not been completely turned to LITE. Push in and turn the surface control knob to LITE (until burner ignites) and then turn the surface control knob to the desired flame size.</p> <p>Burner ports are clogged. Clean burners. See "To Clean Burner Grates, Burner Cap and Burner Base" under General Cleaning. With the burner off, use small-gauge wire or needle to clean ports or slots.</p> <p>Range power is disconnected from outlet. Be sure cord is securely plugged into the outlet.</p> <p>Electric power outage.</p> <p>Gas supply is turned off. Turn gas supply on.</p>
Surface burner flame burns half way around.	<p>Burner ports or slots are clogged. With the burner off, clean by using a small-gauge wire or needle to lean ports or slots.</p> <p>Moisture is present after cleaning. Lightly fan the flame and allow the burner to operate until flame is full. Dry the burners thoroughly following instructions under General Cleaning.</p>
Surface burner flame is orange.	<p>Dust particles in main line. Allow the burner to operate a few minutes until flame turns blue.</p> <p>Salt air in coastal areas. A slightly orange flame is unavoidable.</p>

BEFORE YOU CALL (Solutions to Common Problems)

OCCURRENCE	POSSIBLE CAUSE/SOLUTION
Metalmarks.	Sliding or scraping of metal utensils on cooktop surface. Do not slide metal utensils on cooktop surface. Use a ceramic-glass cooktop cleaning cream to remove the marks. "Cooktop Cleaning - Ceramic Glass Cooktop Models" section under General Cleaning.
Scratches or abrasions on cooktop surface.	Coarse particles such as salt or sand between cooktop and utensils can cause scratches. Be sure cooktop surface and bottoms of utensils are clean before usage. Small scratches do not affect cooking and will become less visible with time. Cleaning materials not recommended for ceramic-glass cooktop have been used. See "Cooktop Cleaning - Ceramic Glass Cooktop Models" section under General Cleaning. Cookware with rough bottom has been used. Use smooth, flat-bottomed cookware.
Brown streaks or specks.	Boilovers are cooked onto surface. Use razor blade scraper to remove soil. "Cooktop Cleaning - Ceramic Glass Cooktop Models" section under General Cleaning.
Areas of discoloration with metallic sheen.	Mineral deposits from water and food. Remove using a ceramic-glass cooktop cleaning cream. Use cookware with clean, dry bottoms.
Poor baking results.	Many factors affect baking results. Make sure the proper rack position is used. Center food in the oven and space pans to allow air to circulate. Allow the oven to preheat to the set temperature before placing food in the oven. Try adjusting the recipes' recommended temperature or baking time. If you feel the oven is too hot or cool, see "Adjusting Your Oven Temperature" section in the Electronic Oven Control Guide.
Flames inside oven or smoking from vent.	Excessive spillovers in oven. Set self-clean cycle for a longer cleaning time. Excessive spillovers in oven. This is normal, especially for pie spillovers or large amounts of grease on the oven bottom. Wipe up excessive spillovers before starting the self-clean cycle. If flames or excessive smoke are present, stop the self-clean cycle and follow the steps under "Stopping or Interrupting the Self-Cleaning Cycle" in the Electronic Oven Control Guide.
Oven smokes excessively during broiling.	Control(s) not set properly. Follow instructions under "Setting Oven Controls". Make sure oven door is closed. Meat too close to the element. Reposition the rack to provide proper clearance between the meat and the element. Preheat broil element. Preheat broil element for searing. Grid on broiler pan wrong side up and grease not draining. Always place grid on the broiler pan with ribs up and slots down to allow grease to drip into pan. Grease has built up on oven surfaces. Regular cleaning is necessary when broiling frequently. Old grease or food spatters cause excessive smoking.
Self-cleaning cycle does not work.	Control(s) not set properly. Follow instructions under "Oven Cleaning". Self-cleaning cycle was interrupted. Stop time must be 2 to 4 hours past the start time. Follow steps under "Stopping or Interrupting the Self-Cleaning Cycle".
Soil not completely removed after self-cleaning cycle.	Set Self-Clean cycle for a longer cleaning time. Failure to clean bottom front, top of oven or door areas outside oven seal. These areas are not in the Self-Cleaning area, but get hot enough to burn on food residue. Clean these areas before starting the Self-Clean cycle. Burned-on residue may be cleaned with a stiff nylon brush and water or nylon scrubber. Be careful not to damage the oven gasket.
Excessive smoking from oven vent.	Excessive spillovers in oven, especially for pie spillovers or large amounts of grease on the oven bottom. Wipe up excessive spillovers before starting the Self-Clean cycle. If flames or excessive smoke are present, stop the Self-Clean cycle and follow the steps under "Stopping or interrupting the Self-Cleaning Cycle".

MAJOR APPLIANCE WARRANTY

Your appliance is covered by a one year limited warranty. For one year from your original date of purchase, Electrolux will pay all costs for repairing or replacing any parts of this appliance that prove to be defective in materials or workmanship when such appliance is installed, used and maintained in accordance with the provided instructions.

Exclusions This warranty does not cover the following:

1. Products with original serial numbers that have been removed, altered or cannot be readily determined.
2. Product that has been transferred from its original owner to another party or removed outside the USA or Canada.
3. Rust on the interior or exterior of the unit.
4. Products purchased "as-is" are not covered by this warranty.
5. Food loss due to any refrigerator or freezer failures.
6. Products used in a commercial setting.
7. Service calls which do not involve malfunction or defects in materials or workmanship, or for appliances not in ordinary household use or used other than in accordance with the provided instructions.
8. Service calls to correct the installation of your appliance or to instruct you how to use your appliance.
9. Expenses for making the appliance accessible for servicing, such as removal of trim, cupboards, shelves, etc., which are not a part of the appliance when it is shipped from the factory.
10. Service calls to repair or replace appliance light bulbs, air filters, water filters, other consumable, or knobs, handles, or other cosmetic parts.
11. Surcharges including, but not limited to, any after hour, weekend, or holiday service calls, tolls, ferry trip charges, or mileage expense for service calls to remote areas, including the state of Alaska.
12. Damages to the finish of appliance or home incurred during installation, including but not limited to floors, cabinets, walls, etc.
13. Damages caused by: services performed by unauthorized service companies; use of parts other than genuine Electrolux parts or parts obtained from persons other than authorized service companies; or external causes such as abuse, misuse, inadequate power supply, accidents, fires, or acts of God.

DISCLAIMER OF IMPLIED WARRANTIES; LIMITATION OF REMEDIES

Customer's sole and exclusive remedy under this limited warranty shall be product repair or replacement as provided herein. Claims based on implied warranties, including warranties of merchantability or fitness for particular purpose, are limited to one year or the shortest period allowed by law, but not less than one year. Electrolux shall not be liable for consequential or incidental damages such as property damage and incidental expenses resulting from any breach of this written limited warranty or any implied warranty. Some states and provinces do not allow the exclusion or limitation of incidental or consequential damages, or limitations on the duration of implied warranties, so these limitations or exclusions may not apply to you. This written warranty gives you specific legal rights. You may also have other rights that vary from state to state.

If You Need Service

Keep your receipt, delivery slip, or some other appropriate payment record to establish the warranty period should service be required. If service is performed, it is in your best interest to obtain and keep all receipts. Service under this warranty must be obtained contacting Electrolux at the addresses or phone numbers below.

This warranty only applies in the USA and Canada. In the USA, your appliance is warranted by Electrolux Major Appliances North America, a division of Electrolux Home Products, Inc. In Canada, your appliance is warranted by Electrolux Canada Corp. Electrolux authorizes no person to change or add to any obligations under this warranty. Obligations for service and parts under this warranty must be performed by Electrolux or an authorized service company. Product features or specifications as described or illustrated are subject to change without notice.

U.S.A.
1.800.944.9044
Electrolux Home Products, Inc.,
10200 David Taylor Drive
Charlotte, NC 28262



Canada
1.800.265.8352
Electrolux Canada Corp.
5855 Terry Fox Way
Mississauga, Ontario, Canada
L5V 3E4