

**32" CLASS WIDE LCD TV WITH DVD PLAYER
TÉLÉVISEUR ACL GRAND ÉCRAN CATÉGORIE
32 PO ET LECTEUR DVD**

HDLCDVD328

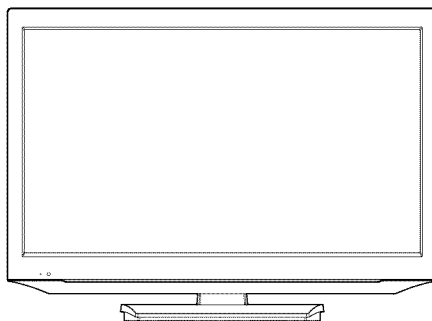

**ATTENTION
ATTENTION**

If you purchase a universal remote control from your local retailer, please contact the remote manufacturer for the required programming code.

Si vous utilisez avec cet appareil une télécommande universelle (autre que celle vendue avec ce téléviseur), consultez la documentation accompagnant la télécommande universelle afin de connaître le code numérique correspondant au téléviseur.

**AIR/CABLE MODE SELECTION
SÉLECTION DU MODE AIR/CABLE**

When shipped from the factory, the Signal Type option is set to the "Cable" (Cable Television) mode.

If not using Cable TV, set this menu option to the "Air" position.

Lorsque l'appareil sort de l'usine, l'option « Signal Type » est en mode « Cable » (câblodistribution). Si vous n'utilisez pas la câblodistribution, sélectionnez l'option « Air ».

**IF CONTACT WITH CUSTOMER SERVICE IS REQUIRED
PLEASE HAVE THE MODEL NUMBER READY PRIOR TO THE CALL
S'IL FAUT CONTACTER LE SERVICE CLIENTÈLE, PRENEZ SOIN D'ÊTRE MUNI
DU NUMÉRO DE MODÈLE AVANT D'APPELER.**

**CUSTOMER SERVICE - 1-800-289-0980
SERVICE/SERVICE CLIENTÈLE: 1-800-289-0980**



**ORION WEBSITE
SITE WEB ORION**

FOR INFORMATION ON OUR OTHER PRODUCTS AND RECYCLING INFORMATION, PLEASE VISIT OUR WEBSITE AT
POUR OBTENIR DES INFORMATIONS SUR NOS AUTRES PRODUITS ET LE RECYCLAGE, VEUILLEZ VISITER NOTRE SITE WEB:

www.orionsalesinc.com

Before operating the unit, please read this manual thoroughly.
Avant de faire fonctionner l'appareil, veuillez lire le présent guide attentivement.

ENGLISH

	CAUTION RISK OF ELECTRIC SHOCK DO NOT OPEN	
CAUTION: TO REDUCE THE RISK OF ELECTRIC SHOCK, DO NOT REMOVE COVER (OR BACK). NO USER-SERVICEABLE PARTS INSIDE. REFER SERVICING TO QUALIFIED SERVICE PERSONNEL.		



The lightning flash with arrowhead symbol, within an equilateral triangle is intended to alert the user to the presence of uninsulated dangerous voltage within the product's enclosure that may be of sufficient magnitude to constitute a risk of electric shock.



The exclamation point within an equilateral triangle is intended to alert the user to the presence of important operating and maintenance (servicing) instructions in the literature accompanying the appliance.

WARNING: TO PREVENT FIRE OR SHOCK HAZARD, DO NOT EXPOSE THIS APPLIANCE TO RAIN OR MOISTURE. TO PREVENT THE SPREAD OF FIRE, KEEP CANDLES OR OPEN FLAMES AWAY FROM THIS PRODUCT AT TIMES.
CAUTION: TO PREVENT ELECTRIC SHOCK, DO NOT USE THIS POLARIZED PLUG WITH AN EXTENSION CORD, RECEPTACLE OR OTHER OUTLET UNLESS THE BLADES CAN BE FULLY INSERTED TO PREVENT BLADE EXPOSURE.

WARNING: This equipment has been tested and found to comply with the limits for a Class B digital device, pursuant to Part 15 of the FCC Rules. These limits are designed to provide reasonable protection against harmful interference in a residential installation. This equipment generates, uses and can radiate radio frequency energy and, if not installed and used in accordance with the instructions, may cause harmful interference to radio communications.
However, there is no guarantee that interference will not occur in a particular installation. If this equipment does cause harmful interference to radio or television reception, which can be determined by turning the equipment off and on, the user is encouraged to try to correct the interference by one or more of the following measures:

- Reorient or relocate the receiving antenna.
- Increase the separation between the equipment and receiver.
- Connect the equipment into an outlet on a circuit different from that to which the receiver is connected.
- Consult the dealer or an experienced radio/TV technician for help.

CAUTION: Changes or modifications not expressly approved by the party responsible for compliance with the FCC Rules could void the user's authority to operate this equipment.

CAUTION: THIS DIGITAL VIDEO PLAYER EMPLOYS A LASER SYSTEM. TO ENSURE PROPER USE OF THIS PRODUCT, PLEASE READ THIS OWNER'S MANUAL CAREFULLY AND RETAIN FOR FUTURE REFERENCE. SHOULD THE UNIT REQUIRE MAINTENANCE, CONTACT AN AUTHORIZED SERVICE LOCATION-SEE SERVICE PROCEDURE. USE OF CONTROLS, ADJUSTMENTS OR THE PERFORMANCE OF PROCEDURES OTHER THAN THOSE SPECIFIED HEREIN MAY RESULT IN HAZARDOUS RADIATION EXPOSURE. TO PREVENT DIRECT EXPOSURE TO THE LASER BEAM, DO NOT TRY TO OPEN THE ENCLOSURE. RADIATION MAY BE PRESENT WHEN THE ENCLOSURE IS OPENED. DO NOT STARE INTO THE BEAM.
--



Location of the required Marking
The rating sheet and the safety caution are on the rear of the unit.

CERTIFICATION: COMPLIES WITH FDA RADIATION PERFORMANCE STANDARDS, 21 CFR SUBCHAPTER J.

Complies with FDA performance standards for laser products except for deviations pursuant to Laser Notice No. 50, dated June 24, 2007.

Record the model number and serial number.

Model number _____ Serial number _____

IMPORTANT SAFETY INSTRUCTIONS

- 1) Read these instructions.
- 2) Keep these instructions.
- 3) Heed all warnings.
- 4) Follow all instructions.
- 5) Do not use this apparatus near water.
- 6) Clean only with dry cloth.
- 7) Do not block any ventilation openings. Install in accordance with the manufacturer's instructions.
- 8) Do not install near any heat sources such as radiators, heat registers, stoves, or other apparatus (including amplifiers) that produce heat.
- 9) Do not defeat the safety purpose of the polarized or grounding-type plug. A polarized plug has two blades with one wider than the other. A grounding type plug has two blades and a third grounding prong. The wide blade or the third prong are provided for your safety. If the provided plug does not fit into your outlet, consult an electrician for replacement of the obsolete outlet.
- 10) Protect the power cord from being walked on or pinched particularly at plugs, convenience receptacles, and the point where they exit from the apparatus.
- 11) Only use attachments/accessories specified by the manufacturer.
- 12) Use only with cart, stand, tripod, bracket, or table specified by the manufacturer, or sold with the apparatus. When a cart is used, use caution when moving the cart/apparatus combination to avoid injury from tip-over.
- 13) Unplug this apparatus during lightning storms or when unused for long periods of time.
- 14) Refer all servicing to qualified service personnel. Servicing is required when the apparatus has been damaged in any way, such as power-supply cord or plug is damaged, liquid has been spilled or objects have fallen into the apparatus, the apparatus has been exposed to rain or moisture, does not operate normally, or has been dropped.
- 15) Apparatus should not be exposed to dripping or splashing, and objects filled with liquids, such as vases, should not be placed on the apparatus.
- 16) An outside antenna system should not be located in the vicinity of overhead power lines or other electric light or power circuits, or where it can fall into such power lines or circuits. When installing an outside antenna system, extreme care should be taken to keep from touching such power lines or circuits, as contact with them might be fatal.
- 17) Do not overload wall outlets and extension cords, as this can result in a risk of fire or electric shock.
- 18) Do not push objects through any openings in this unit, as they may touch dangerous voltage points or short out parts that could result in fire or electric shock. Never spill or spray any type of liquid into the unit.
- 19) If an outside antenna or cable system is connected to the unit, be sure the antenna or cable system is grounded to provide some protection against voltage surges and built-up static charges. Section 810 of the National Electrical Code, ANSI/NFPA 70, provides information with respect to proper grounding of the mast and supporting structure, grounding of the lead-in wire to an antenna discharge unit, size of grounding conductors, location of antenna discharge unit, connection to grounding electrodes, and requirements for the grounding electrode.
- 20) When replacement parts are required, be sure the service technician uses replacement parts specified by the manufacturer or those that have the same characteristics as the original part. Unauthorized substitutions may result in fire, electric shock or other hazards.
- 21) Upon completion of any service or repairs to this unit, ask the service technician to perform safety checks to determine that the unit is in proper operating condition.
- 22) Keep your fingers clear of the disc slot as it is closing. It may cause injury.



EXAMPLE OF ANTENNA GROUNDING AS PER THE NATIONAL ELECTRICAL CODE

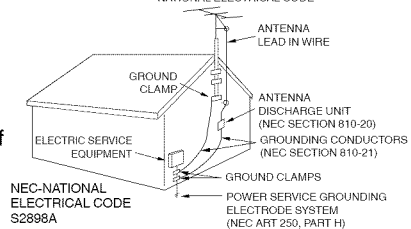

IMPORTANT SAFETY INSTRUCTIONS (continued)

- 23) When you connect the product to other equipment, turn off the power and unplug all of the equipment from the wall outlet. Failure to do so may cause an electric shock and serious personal injury. Read the owner's manual of the other equipment carefully and follow the instructions when making any connections.
- 24) Reduce the volume to the minimum level before you turn on the product. Otherwise, sudden high volume sound may cause hearing or speaker damage.
- 25) Do not allow the product to output distorted sound for an extended period of time. It may cause speaker overheating and fire.
- 26) When you use the headphones, keep the volume at a moderate level. If you use the headphones continuously with high volume sound, it may cause hearing damage.
- 27) Do not look into the opening of the disc slot or ventilation opening of the product to see the source of the laser beam. It may cause eye damage.
- 28) Do not use a cracked, deformed, or repaired disc. These discs are easily broken and may cause serious personal injury and product malfunction.
- 29) This reminder is provided to call the cable TV system installer's attention to Article 820-40 of the NEC that provides guidelines for proper grounding and, in particular, specifies that the cable ground shall be connected to the grounding system of the building, as close to the point of cable entry as practical.
- 30) The socket-outlet must be installed near the unit and easily accessible.

CONDENSATION

Moisture will form in the operating section of the player if the player is brought from cool surroundings into a warm room or if the temperature of the room rises suddenly. When this happens, player's performance will be impaired. To prevent this, let the player stand in its new surroundings for about an hour before switching it on, or make sure that the room temperature rises gradually. Condensation may also form during the summer if the player is exposed to the breeze from an air conditioner. In such cases, change the location of the player.

HOW TO HANDLE THE LCD PANEL

- Do not press hard or jolt the LCD panel. It may cause the LCD panel glass to break and injury may occur.
- If the LCD panel is broken, make absolutely sure that you do not touch the liquid in the panel. This may cause skin inflammation.
If the liquid gets in your mouth, immediately gargle and consult with your doctor. Also, if the liquid gets in your eyes or touches your skin, consult with your doctor after rinsing for at least 15 minutes or longer in clean water.

CHILD SAFETY:

It Makes A Difference How and Where You Use Your Flat Panel Display

Congratulations on your purchase! As you enjoy your new product, please keep these safety tips in mind:

THE ISSUE

The home theater entertainment experience is a growing trend and larger flat panel displays are popular purchases. However, flat panel displays are not always supported on the proper stands or installed according to the manufacturer's recommendations.

Flat panel displays that are inappropriately situated on dressers, bookcases, shelves, desks, speakers, chests or carts may fall over and cause injury.

THIS MANUFACTURER CARES!

The consumer electronics industry is committed to making home entertainment enjoyable and safe.

TUNE INTO SAFETY

One size does NOT fit all. Follow the manufacturer's recommendations for the safe installation and use of your flat panel display.

Carefully read and understand all enclosed instructions for proper use of this product.

Don't allow children to climb on or play with furniture and television sets.

Don't place flat panel displays on furniture that can easily be used as steps, such as a chest of drawers.

Remember that children can become excited while watching a program, especially on a "larger than life" flat panel display. Care should be taken to place or install the display where it cannot be pushed, pulled over, or knocked down.

Care should be taken to route all cords and cables connected to the flat panel display so that they cannot be pulled or grabbed by curious children.

WALL MOUNTING: IF YOU DECIDE TO WALL MOUNT YOUR FLAT PANEL DISPLAY, ALWAYS:

Use a mount that has been recommended by the display manufacturer and/or listed by an independent laboratory (such as UL, CSA, ETL).

Follow all instructions supplied by the display and wall mount manufacturers.

If you have any doubts about your ability to safely install your flat panel display, contact your retailer about professional installation.

Make sure that the wall where you are mounting the display is appropriate to support the weight of the unit/product and wall mount. If you are unsure, contact a professional installer.

A minimum of two people are required for installation. Flat panel displays can be heavy.

SAFETY PRECAUTIONS

The unit emits heat when in operation. Do not place any covers or blankets on the unit, this may cause overheating. Do not block ventilation holes, or set up near radiators. Do not place in direct sunshine. When placing on a shelf leave 10 cm (4 inches) free space around the entire unit.

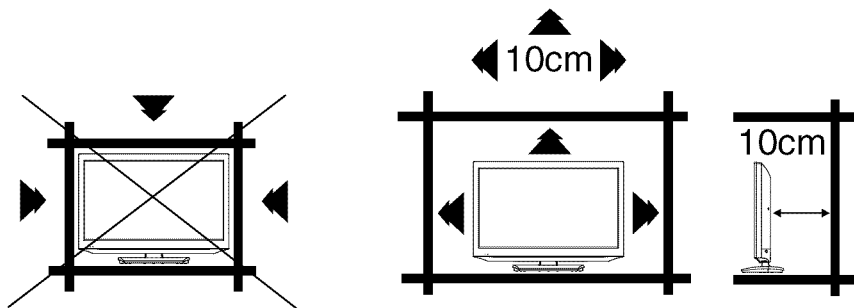

Notes when mounting the LCD TV/DVD on a wall

If the unit is to be mounted on the wall, contact the retailer where you purchased the LCD TV/DVD for advice, and have the equipment professionally installed. Incomplete or improper installation may cause injury to you, and/or damage to the LCD TV/DVD.

To hang the television on a wall, remove these screws and then remove a stand. Before performing work spread cushioning over the base area to lay the TV on.

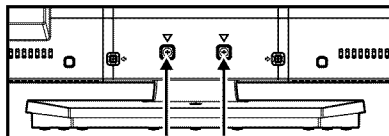

IMPORTANT NOTICE

Possible Adverse Effects on LCD Panel: If a fixed (non-moving) pattern remains on the LCD Panel for long periods of time, the image can become permanently engrained in the LCD Panel and cause subtle but permanent ghost images. This type of damage is NOT COVERED BY YOUR WARRANTY. Never leave your LCD Panel on for long periods of time while it is displaying the following formats or images:

- Fixed Images, such as stock tickers, video game patterns, TV station logos, and websites.
- Special Formats that do not use the entire screen. For example, viewing letterbox style (16:9) media on a normal (4:3) display (black bars at top and bottom of screen); or viewing normal style (4:3) media on a widescreen (16:9) display (black bars on left and right sides of screen).

The following symptoms are not signs of malfunction but technical limitation. Therefore we disclaim any responsibility for these symptoms.

- LCD Panels are manufactured using an extremely high level of precision technology, however sometimes parts of the screen may be missing picture elements or have luminous spots. This is not a sign of a malfunction.
- Do not install the LCD Panel near electronic equipment that produces electromagnetic waves. Some equipment placed too near this unit may cause interference.
- Effect on infrared devices – There may be interference while using infrared devices such as infrared cordless headphones.

How to attach the stand

NOTE:

- Unplug the AC cord from the AC INPUT terminal.
- Before beginning this process, assure that the TV is laid on a clean, safe, and cushioned surface to avoid any damage to the unit.
- Do not touch or press the TV-screen, glass might break under pressure.

Place the TV on its front onto a table.

Align the stand's bottom-plate (supplied) as seen here.

It will fit in only one direction.

Hold the unit and attach the stand frame (a) slowly and secure the stand frame (a) with the 2 screws (supplied). (M4x35mm), as shown in Figure 1.

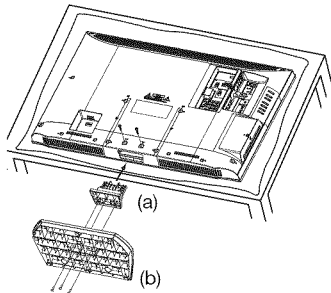

Figure 1

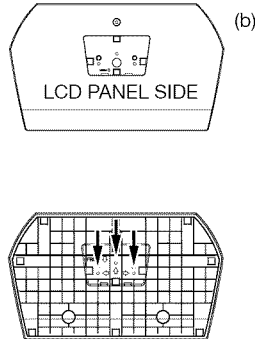

Figure 2

Finally secure the bottom-plate (b) with 3 screws (supplied) (M4x16mm) as indicated by the arrows in Figure 2.

- Be sure to follow the instructions. Insufficient tightening or incorrect installation of the stand will not support your unit correctly, and could result in damage or injury from tip-over.

How to remove the stand

When you transport this product, remove the stand and pack flat against the back of the unit in the carton. To remove the stand, perform these steps in reverse order.

For wall mounting, the base must be removed. To disconnect the base/stand remove the 2 screws from the back (see page 5).

LCD color TV With DVD/CD player

Unique space saving design combines a 32" LCD color TV and a DVD/CD player.

A DVD disc has much more capacity, but is the same size as an audio CD disc. The Picture/Audio quality of a DVD exceeds other software. The picture quality is higher than Super VHS video cassettes. The audio quality is higher than an audio CD. The DVD also has special options; audio language selection, subtitle language selection, or multi-angle, etc.

The DVD PLAYER can playback both audio CDs and MP3/WMA/JPEG CDs.

Compatible with a wide range of DVD audio outputs

Digital Audio Jack (Coaxial)

- When a component with a built-in Dolby Digital decoder is connected, Dolby Digital sound can produce the effect of being in a movie theater or a concert hall.
- Surround standard is different from Dolby Digital. This format is already in use in many theaters. By connecting this unit to a DTS decoder or an AV amplifier with a built-in DTS decoder, the DTS audio of DVD discs recorded in this format can be enjoyed. However, audio will not be output from the analog audio output jacks.
- By connecting this unit to an AV amplifier with a built-in MPEG decoder, the MPEG audio of DVD discs recorded in this format can be enjoyed.
- The Linear PCM sound of a 48 kHz/24 bit through 96 kHz/24 bit exceeds audio CD sound.

Convenience Features

Direct selection of your desired scenes using Title/Chapter/Time/Track - You can playback from the desired scene.

Recalling Up to 12 Scenes - You can program up to 12 scenes in memory and recall the marked scenes.

Frame Advance - The **PAUSE** moves one frame at a time.

Slow Motion - The **SLOW** moves you back and forth through the program by 4 steps of 1/16-1/2 times.

Repeat Playback - You can repeat chapter, track, title, sides or material between two selected points.

Program Playback (Audio CD/MP3/WMA CD) - You can playback tracks in programmed sequences.

Zoom - You can zoom in the selected subject on the screen during playback.

Note: Make sure that discs are suitable for the following functions.

Multi-Language - Maximum 32 language subtitles and maximum 8 language soundtracks can be played back for movies or programs.

Multi-Angle - Pictures of Sports or a Live Concert are recorded with many cameras. When you play such a disc, you can change the angles during playback.

Parental Control - You can limit the playback of scenes or sounds of DVD discs that have a rating level encoded on the disc.

Video Aspect Ratio - You can change the aspect ratio of the screen for your monitor.

TV Features

Integrated Digital Tuner - You can view digital broadcasts without using a Digital TV Set-Top Box.

Closed Caption Decoder With Full Text Mode - Displays text captions or full screen text on the screen for hearing impaired viewers.

Picture Adjustments Using The Remote Control - The On-Screen display allows precise remote control adjustment of BRIGHTNESS, CONTRAST, COLOR, TINT and SHARPNESS.

Programmable TV Sleep Timer - Operable from the remote control, the TV can be programmed for up to 120 minutes to turn off automatically.

On-Screen 3 Language Display - You can select one of 3 languages, English, French or Spanish for on-screen programming.

V-Chip - The V-Chip function can read the rating of a TV program or movie content if the program is encoded with this information. V-chip will allow you to set a restriction level.

* This item incorporates copy protection technology that is protected by U.S. patents and other intellectual property rights of Rovi Corporation. Reverse engineering and disassembly is prohibited.

* **DVD** is a trademark of DVD Format/Logo Licensing Corporation.

* Manufactured under license from Dolby Laboratories. Dolby and the double-D symbol are trademarks of Dolby Laboratories.

* HDMI, the HDMI Logo, and High-Definition Multimedia Interface are trademarks or registered trademarks of HDMI Licensing LLC in the United States and other countries.

Contents

Before using your unit

IMPORTANT SAFETY INSTRUCTIONS	3
SAFETY PRECAUTIONS	5
IMPORTANT NOTICE.....	5
How to attach the stand	6
How to remove the stand	6
Features.....	7
Contents	8
Disc.....	9
Parts and functions	11
Remote control	12
Power source	13
Antenna connections	14
Cable TV connections.....	14

TV operation

Starting setup	15
TV operation	15
Quick guide for menu operation	16
Convenience functions	17
Memorizing channels.....	18
Checking the digital signal strength	19
Labeling channels.....	19
Labeling video inputs	19
Setting the V-Chip	20
Closed Caption	21
CC advanced.....	21
Setting the picture size	22



DVD operation

Preparation	23
Status display of disc	23
Playback procedure	23
Special playback.....	24
Zooming.....	24
Locating desired scene.....	24
A-B Repeat playback	24
Marking desired scenes	25
Changing angles.....	25
Changing soundtrack language	25
Subtitles.....	25
Using HOME MENU	26
Play mode	26
Audio Settings menu.....	27
Video Adjust menu.....	28
Quick guide for DVD menu operation.....	28
Function Setup.....	29
Parental Control	30

Additional information

Language Code List.....	31
Country/Area Code List	31
Connections to other equipment.....	32
Reception disturbances	35
Problems and troubleshooting	36
Specifications	38
limited WARRANTY	39

Playable discs

Disc type and logo mark		content
DVD Video		Audio + Video (moving pictures)
CD-DA		Audio

The following discs are also available.

- DVD-R/RW discs of DVD video format.
- CD-R/RW discs of MP3/WMA/JPEG.

CAUTION:

- Only the left types of discs can be played on this unit. DVD-ROM, CD-ROM, SVCD, CVD, VCD, etc. cannot be played.
- This unit cannot play an 8 cm disc. It cannot also be played even using a disc adapter.
- If you insert an irregular shaped disc, it may get stuck and cause a malfunction.
- The use of a ring protector or other disc accessories will cause errors.
- This unit is to be used exclusively with the NTSC color system. PAL and SECAM system discs cannot be used with this unit.
- Some CD-R/RWs and DVD-R/RW cannot be played back depending on the recording conditions.

Region Number

Region number (Regional restriction code) is built-in to the unit and DVD video discs.

Region number "1" or "ALL" of DVD video discs can be used on this unit.



Title

When two or more movies are recorded on a disc, the disc is divided into two or more sections. Each section is called a "TITLE".

Chapter

The titles can be subdivided into many sections. Each section is called a "CHAPTER".



Track

An Audio CD can contain several items. These are assigned to the tracks.

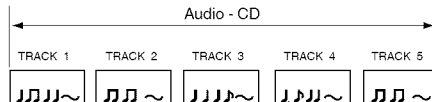

Removing Disc from Case

Be sure to hold the edge of disc. Do not touch the surface of the disc. Pick up the disc gently from the case.

- Do not scratch the disc.
- Do not get dirt on the surface of the disc.
- Do not stick a label or adhesive tape on the disc.
- Do not drop or bend the disc.

Storing Disc

- Store the disc in the case to avoid risk of scratches, dirt or damage.
- Do not leave disc exposed to direct sunlight or in hot or humid places.

Cleaning Disc

Wipe the disc with a clean, dry cloth from center to edge.

- Do not wipe the disc in a circular motion.
- Do not use liquid or aerosol cleaners.

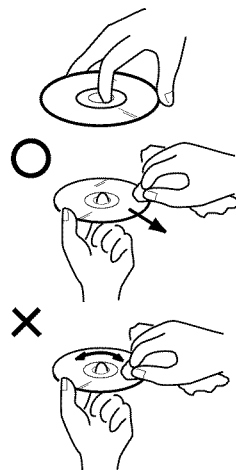

■ Title/Chapter/Track PC-created disc

- You may not be able to play discs recorded using a personal computer or recorder for disc compatibilities, scratches or marks on the disc, dirty lenses of the unit or condensation and so on.
- Discs recorded using a personal computer may not be playable in this unit due to the setting of the application software used to create the disc. In these particular instances, check with the software publisher for more detailed information.

■ Playable files

- ISO 9660 Level 1 or 2 compliant.
Romeo and Joliet file systems are both compatible with this player.
- DRM (Digital Rights Management) protected files will not play in this player.
For detailed information, please see the instruction manuals or help files that came with your PC and/or software.
- File structure (may differ): Up to 299 folders on a disc; up to 648 files within each folder
- Folder and file names can be displayed as long as they are typed in alphabets and numbers. If folder and file names are other than alphabets and numbers, they may be replaced and displayed like as “_”. Garbled characters may also be displayed in this case.

■ Playing image files

JPEG files recorded in DVD-R/-RW and CD-R/-RW can be played.

■ JPEG file compatibility

- Image files should be saved in JPEG format.
- Files recorded in Fuji Color CD, Kodak Picture CD or CD-R/-RW can be played.
- Compatible formats: Baseline JPEG and EXIF 2.2* still image files up to a resolution of 3072 x 2048.
*File format used by digital still cameras.
- Files with extensions .jpg or .JPG can be played.
- Progressive JPEG formatted files do not work.
- It may take some more time to start to play larger files than usual.
- JPEG files with different aspect ratio may be displayed with black bands (either vertical or horizontal).

■ Playing Audio files

WMA and MP3 files recorded in DVD-R/-RW, CD-R/-RW can be played.

■ Windows Media Audio (WMA) compatibility

- WMA is an acronym for Windows Media Audio and refers to an audio compression technology developed by Microsoft Corporation.
- You can encode your files by using Windows Media Player Ver.7, 7.1, Windows Media Player for Windows XP or Windows Media Player 9 Series.
- When encoding your files, use only applications approved by Microsoft Corporation. If you use a non-approved application, it may not work properly.
- This unit is compatible with audio files recorded with the following sampling frequency: 32 kHz, 44.1 kHz and 48 kHz.
- It is not compatible with loss-less encoding.
- Files with extensions .wma or .WMA can be played.

■ Playing MP3 (MPEG-1 Audio Layer-3) files

- This unit is compatible with audio files recorded with the following sampling frequency: 32 kHz, 44.1 kHz and 48 kHz.
- Files with extensions .mp3 or .MP3 can be played.
- For the best quality of sound, 128 kbps or higher bit rate is recommended.

■ Copy Control CD (CCCD)

This product is designed to conform to CD-DA (Compact Disc Digital Audio). Any other discs than CD-DA are not guaranteed with their operation and performance in this product.

Note on copyright

- Unauthorized recording of copyrighted television programs, films, video cassettes and other materials may infringe the rights of copyright owners and be contrary to copyright laws.

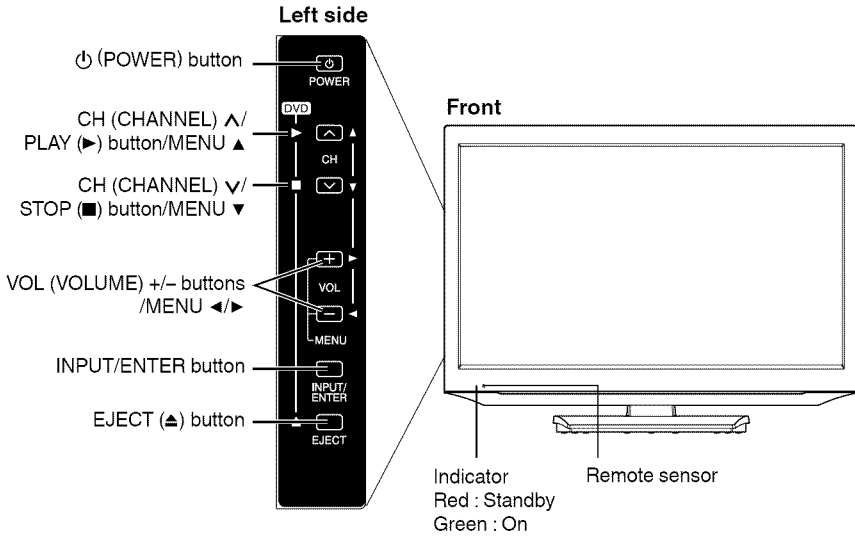

To display the menu screen.
Press **MENU** button to display the menu screen.
CH (CHANNEL) ▼/▲ buttons, **VOL (VOLUME) -/+** buttons and **INPUT/ENTER** button can be used to select the desired setting during the menu screen operations.

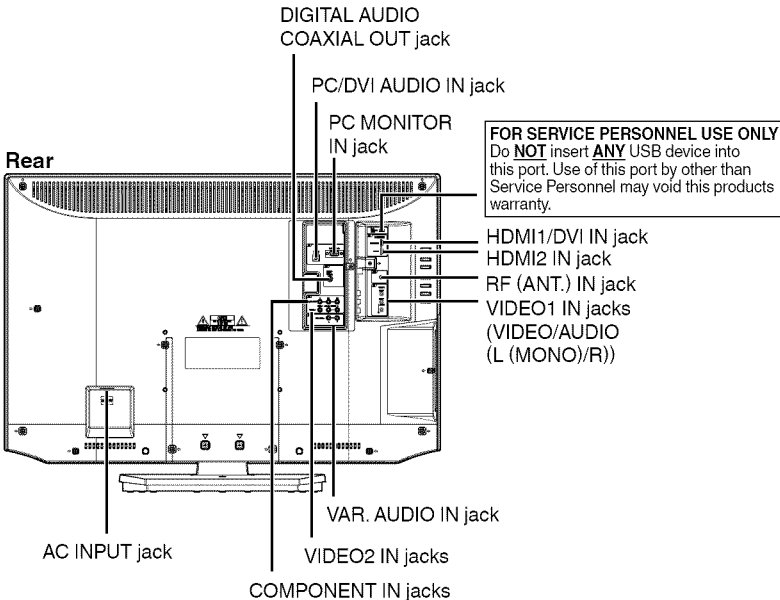

Remote control

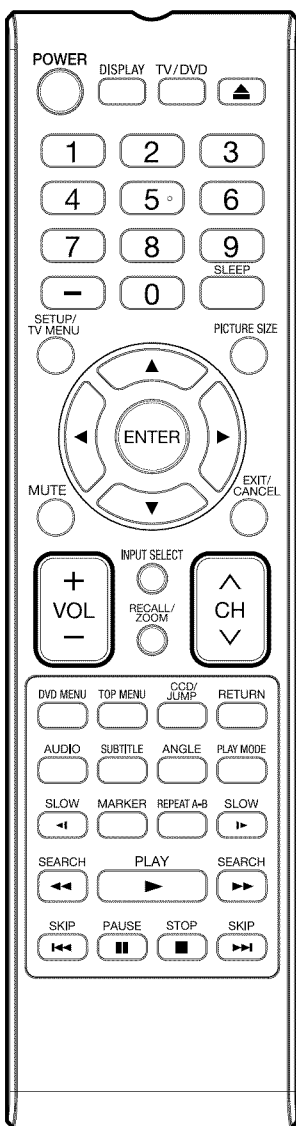

POWER	Power On/Off
DISPLAY	Call TV information Call DVD information
TV/DVD	Switch between TV and DVD
▲ (EJECT)	Eject a disc
0-9/-	Direct channel selection of TV Input setting Enter a password Input “-” for digital channels
SLEEP	Sleep timer
SETUP/ TV MENU	DVD mode - Call up initial setup mode TV mode - Display menu of TV
PICTURE SIZE	Display Picture size menu
▲▼◀▶	Cursor buttons
ENTER	Enter information in the menu
MUTE	Switch off the sound
EXIT/ CANCEL	Exit from On-Screen menu Reset information in the menu
VOL +/-	Adjust volume of TV
INPUT SELECT	Display source selection menu
RECALL/ ZOOM	Switch between present/last channel Zoom
CH ^/▼	Select channel of TV
DVD MENU	Display DVD menu
TOP MENU	Select title
CCD/ JUMP	Closed Caption Locating desired scene
RETURN	Remove DVD setup menu
AUDIO	Change sound track language
SUBTITLE	Set subtitle
ANGLE	Change playback angle
PLAY MODE	Select playback mode
SLOW	Forward/Reverse- slow motion
MARKER	Index
REPEAT A-B	Repeat playback between A and B
SEARCH	Fast Forward/Review playback
PLAY	Playback
SKIP	Skip chapter to forward or reverse direction
PAUSE	Pause CD sound Still picture of DVD
STOP	Stop

Inserting Batteries

- 1 Open the battery compartment cover in the direction of the arrow.
- 2 Install two "AA" batteries (supplied), paying attention to the polarity diagram in the battery compartment.
- 3 Replace the compartment cover.

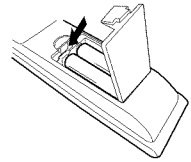
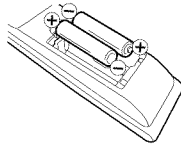
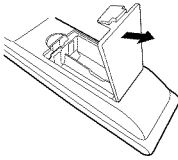

Operation

- Aim the remote control at the remote sensor and press control buttons to operate.
- Operate the remote control within a 30° angle on either side of the remote sensor, up to a distance of approximately 15 feet.

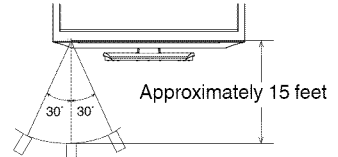

NOTE:

- Do not leave the remote control unit exposed to direct sunlight or in hot or humid places.
- The remote control unit uses infrared beams to transmit signals, so sunlight or fluorescent light on the remote sensor may shorten operating distance.
- Incorrect use of batteries may cause them to leak or burst. Read the battery warnings and use the batteries properly.
- Do not mix old and new batteries.
- Do not mix alkaline, standard (carbon-zinc), or rechargeable, (ni-cad, ni-mh, etc) batteries.
- Remove batteries if the remote control will not be operated for an extended period of time.

Power source

TO USE AC POWER

1. Connect the AC cord plug into this unit's AC INPUT jack.
2. Connect the AC cord into an AC outlet.

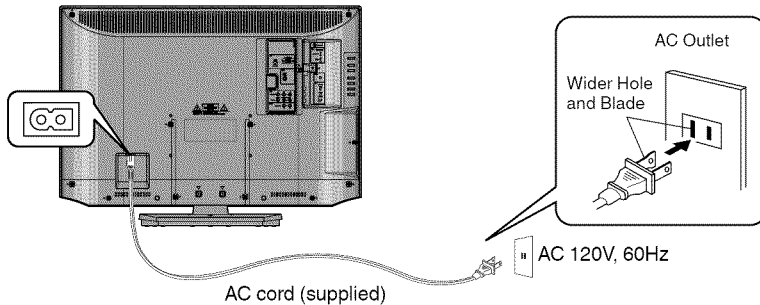

NOTE:

- Please make sure to insert the cord securely at both the LCD TV/DVD and the wall outlet.
- The AC Cord has a polarized type AC line plug. If the supplied AC cord does not match your AC outlet, contact a qualified electrician.

WARNING:

- DO NOT CONNECT THIS UNIT TO THE POWER USING ANY DEVICE OTHER THAN THE SUPPLIED AC CORD. THIS COULD CAUSE FIRE, ELECTRICAL SHOCK, OR DAMAGE.
- DO NOT USE WITH A VOLTAGE OTHER THAN THE POWER VOLTAGE SPECIFIED. THIS COULD CAUSE FIRE, ELECTRICAL SHOCK, OR DAMAGE.

CAUTION:

- WHEN THIS UNIT IS NOT USED FOR A LONG TIME, (E.G., AWAY ON A TRIP) IN THE INTEREST OF SAFETY, BE SURE TO UNPLUG IT FROM THE AC OUTLET.
- DO NOT PLUG/UNPLUG THE AC CORD WHEN YOUR HANDS ARE WET. THIS MAY CAUSE ELECTRICAL SHOCK.
- IF YOU NEED TO REPLACE THE SUPPLIED AC ADAPTER OR AC CORD, THE SPECIFIED ONE IS RECOMMENDED. CONTACT CUSTOMER SERVICE AT 1-800-289-0980.

Antenna connections

If you are using an indoor or outdoor antenna, follow the instructions below that correspond to your antenna system. If you are using a Cable TV service, see "Cable TV connections".

Combination VHF/UHF Antenna (Single 75 ohm cable)

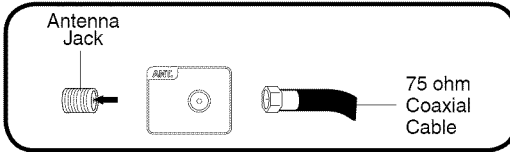

Connect the 75 ohm cable from the combination VHF/UHF antenna to the Antenna Jack.

Cable TV connections

This TV has an extended tuning range and can tune most cable channels without using a Cable TV Converter box. Some cable companies offer "premium pay channels" where the signal is scrambled. Descrambling these signals for normal viewing requires the use of a descrambler device which is generally provided by the Cable TV company.

For subscribers to basic Cable TV service

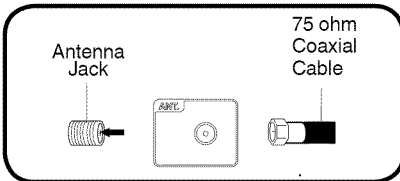

For basic Cable TV service not requiring a Converter/Descrambler box, connect the 75 ohm Coaxial Cable directly to the Antenna Jack on the back of the TV.

For subscribers to scrambled Cable TV service

If you subscribe to a Cable TV service which requires the use of a Converter/Descrambler box, connect the incoming 75 ohm Coaxial Cable to the Converter/Descrambler box. Using another 75 ohm Coaxial Cable, connect the output jack of the Converter/Descrambler box to the Antenna Jack on the TV. Follow the connections shown below. Set the TV to the output channel of the Converter/Descrambler box (usually channel 3 or 4) and use the Converter/Descrambler box to select channels.

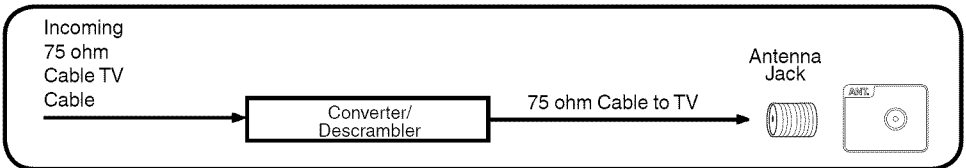

For subscribers to unscrambled Cable TV service with scrambled premium channels

If you subscribe to a Cable TV service in which basic channels are unscrambled and premium channels require the use of a Converter/Descrambler box, you may wish to use a signal Splitter and an A/B Switch box (available from the Cable TV company or an electronics supply store). Follow the connections shown below. With the switch in the "B" position, you can directly tune any unscrambled channels on your TV. With the switch in the "A" position, tune your TV to the output of the Converter/Descrambler box (usually channel 3 or 4) and use the Converter/Descrambler box to tune scrambled channels.

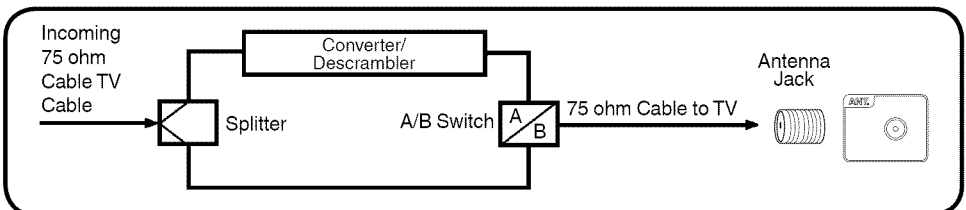

Starting setup

The Auto Setup menu appears the first time you turn on the TV, and assists you to specify the Air/Cable setting, and program your channels automatically.

IMPORTANT: Make sure that the antenna or cable TV system connection is made!

1 To turn on the TV, press **⏻** (POWER) (POWER indicator on the front of the unit changes green. It may take approx. 10 seconds for a picture to appear on screen.). The Auto Setup function begins.

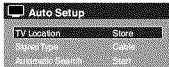

2 Press **▲** or **▼** to select "TV Location", then press **◀** or **▶** to select "Home" or "Store". This product qualifies for ENERGY STAR In Home mode default setting.

NOTE:

- This unit has been preset to STORE brightness. This setting does not qualify under ENERGY STAR. To reduce brightness and energy consumption, change setting to 'HOME'. This setting does qualify under ENERGY STAR.
- The device may not conform to the ENERGY STAR standard after Reset is performed or the Backlight is adjusted.

3 Press **▲** or **▼** to select "Signal Type", then press **◀** or **▶** to select "Cable" or "Air".

4 Press **▲** or **▼** to select "Automatic Search", then press **▶** or **ENTER**.

5 "Auto Setup" will begin. After the Auto Setup is completed, the TV channel appears on the screen.

- Depending on the reception condition, it may take up to 30 minutes to complete memorizing digital cable channels. Please allow the process to complete without interruption.

NOTE:

- If you press **EXIT** in the process of "Auto Setup", the Auto Setup stops and changes to the normal screen.
- When you make a menu selection, your changes occur immediately. You do not have to press **EXIT** to see your changes.

TV operation

1 To turn on the TV, press **⏻** (POWER). (POWER indicator on the front of the unit changes green. It may take approx. 10 seconds for a picture to appear on screen.)

2 Adjust the volume level by pressing **VOL +** or **-**. The volume level will be indicated on the screen by green bars. As the volume level increases, so do the number of bars. If the volume decreases, the number of green bars also decreases.

3 Set the Signal Type option to the appropriate position (see "Air/Cable selection" on page 18).

4 Press the **Direct Channel Selection (0-9, -)** buttons to select the channel. (If you press only channel number, channel selection will be delayed for a few seconds.)

TO SELECT ANALOG CHANNELS

- 1-9: Press 1-9 as needed. Example, to select channel 2, press **2**, then press **ENTER**.
- 10-99: Press the 2 digits in order. Example, to select channel 12, press **1, 2**, then press **ENTER**.
- 100-135: Press the 3 digits in order. Example, to select channel 120, press **1, 2, 0**, then press **ENTER**.

TO SELECT DIGITAL CHANNELS

- Press the first 1-3 digits, then press the **-** button, followed by the remaining number. Example, to select channel 15-1, press **1, 5, -, 1**, then press **ENTER**.
- If a channel is selected with only audio content, "Audio only" will be displayed on the screen.
 - If a channel is selected with a weak digital signal, "Digital channel signal strength is low" will be displayed on the screen. The same program may be available on either an analog channel or a digital channel. You may choose to watch either format.
 - If a channel is selected to which you have not subscribed, "Digital channel is encrypted" will be displayed on the screen.

VHF/UHF/CABLE CHANNELS

Air	Cable
VHF 2-13	VHF 2-13
UHF 14-69	STD/HRC/IRC 14-36 (A) (W) 37-59 (AA) (WWW) 60-85 (AAA) (ZZZ) 86-94 (86) (94) 95-99 (A-5) (A-1) 100-135 (100) (135) 01 (4A)

NOTE:

- If a channel with no broadcast is selected, the sound will automatically be muted.
- It may take a few seconds for a digital channel picture to appear on screen after being selected.

To select the video input source

To view a signal from another device connected to your LCD TV, such as a VCR player, press **INPUT SELECT**, then press **▲** or **▼** or corresponding **Number buttons (0-7)**, then press **ENTER**. You can select TV, Video1, Video2, Component, HDMI1, HDMI2, PC or DVD depending on which input jacks you used to connect your devices.

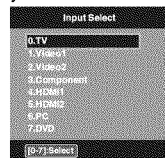

CH ^ / v

Press and release **CH ^ / v**. The channel automatically stops at the next channel set into memory. For proper operation, before selecting channels, they should be set into the memory. See "Memorizing channels" on page 18.

DISPLAY

Press **DISPLAY** to display the current information on the screen.

When the TV receives a digital signal, the digital information will appear.

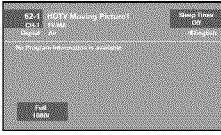

- Channel number
- Channel label (if preset)
- V-Chip rating
- Sleep timer
- Program guide
- Resolution
- Station name
- Broadcast program name
- Signal type
- Audio language
- Picture size

When the TV receives an analog signal, the analog information will appear.

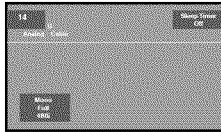

- Channel number
- Channel label (if preset)
- V-Chip rating
- Sleep timer
- Audio information (Stereo, SAP or Mono)
- Signal type
- Picture size
- Resolution

Press **DISPLAY** again to clear the call display.

NOTE:

- After a few seconds, DISPLAY screen will return to normal TV operation automatically.

RECALL

This button allows you to go back to the last channel selected by pressing **RECALL**. Press **RECALL** again to return to the last channel you were watching.

MUTE

Press **MUTE** to switch off the sound. The TV's sound will be silenced and "Mute" will appear on the screen. The sound can be switched back on by pressing this button again or the **VOL +** or **-**.

SLEEP

To set the TV to turn off after a preset amount of time, press **SLEEP** on the remote control. The clock will count up 10 minutes for each press of the **SLEEP** button (Off, 0h 10m, 0h 20m, ..., 2h 0m). After the sleep time is programmed, the display will appear briefly every ten minutes to remind you that the sleep timer is operating. To confirm the sleep timer setting, press **SLEEP** and the remaining time will be displayed for a few seconds. To cancel the sleep timer, press **SLEEP** repeatedly until the display turns to Off.

Quick guide for menu operation

Call menu and for example: Select Language.

- 1 Press **INPUT SELECT** to select TV mode.
- 2 Press **TV MENU**. The TV menu screen will appear.



- 3 Press **▲** or **▼** to select "Setup", then press **▶** or **ENTER**.
- 4 Press **▲** or **▼** to select "Language", then press **◀** or **▶** to select the desired language.
...on the following pages the menu can be called in the same way as here.
- 5 Press **EXIT** to return to the normal screen.

NOTE:

- If no buttons are pressed for more than about 60 seconds, the menu screen will return to normal operation automatically.

Convenience functions

You can change the default settings by pressing the **TV MENU** button on your remote, then select the one of the icons at the left of the menu - follow the On-Screen prompts to set your preferences.

Icon	Selected Items		Setup hint	
Picture	Picture Preference	Sports	Bright and dynamic picture (factory-set)	
		Standard	Standard picture quality (factory-set)	
		Movie	Movie-like picture setting (factory-set)	
		Memory	Your personal preferences (set by you; see "Picture Setting")	
	Picture Setting	Brightness / Contrast / Sharpness / Color / Tint		You can adjust the picture quality to your preference.
		Color Temperature		Bluish (Cool) / Neutral (Standard) / Reddish (Warm)
		Backlight*2		The Backlight feature adjusts the screen brightness for improved picture clarity.
	Dynamic Gamma	On/Off	The Dynamic Gamma feature produces greater picture detail in dark or bright scene areas.	
	Picture Size			See page 22.
	Film Mode	On/Off	A smoother motion may be obtained by setting the Film Mode to "On" when you view a DVD from the DVD player connected with the component or HDMI input (480i only).	
PC Setting	Hor Position / Ver Position		To adjust the horizontal / vertical position of the image on the PC monitor screen. Each video standard will require a different value for this setting.	
	Clock		To minimize any vertical bars or stripes visible on the screen background.	
	Phase		This must be adjusted after the frequency has been set optimize picture quality.	
	Auto Adjust		To adjust the all PC settings automatically.	
DNR	On/Off	DNR (Digital Noise Reduction) can reduce the roughness of the picture.		
Audio	Equalizer Mode	Standard/Music/Movie/News/Memory/Flat		
	Audio Setting	Bass/Treble/Balance		
		Equalizer Setting		100Hz/250Hz/500Hz/1kHz/2kHz/4kHz/10kHz
	MTS	Stereo / SAP / Mono		
	Surround	On/Off	The dynamic presence and sound created offers a thoroughly enjoyable listening experience.	
	Auto Volume	On/Off	Volume level can be adjusted automatically by the motion of picture.	
	Audio Language			When two or more audio languages are included in a digital signal, you can select one of the audio languages. (This function is available only for digital broadcast.)
	HDMI1 Audio	HDMI		When you connect the HDMI device to the TV, select this setting.
		DVI		When you connect the DVI device to the TV with analog audio cords, select this setting.
	Speakers	On/Off	Use this feature to turn the TV speakers off when you connect an audio system.	
Channel	Add / Delete			
	DTV Signal			
	Auto Ch Memory			
	Ch Label			
Lock	See page 20.			
Setup	Closed Caption			
	Language			
	Video Label			
	On Timer	Off / 0h30m / 1h00m / 1h30m / 2h00m / 3h00m · · · 12h00m		
	Auto Shut Off*1	On/Off	If the Auto Shut Off feature is On, a station being viewed stops broadcasting and the TV is not operated, the TV will automatically shut itself off after 15 minutes.	
	Auto Setup			
	PC Standby	On/Off	If the PC Standby feature is On, In PC mode, if no signal is received or no operation performed for 1 minute, the TV will turn to standby mode automatically (LED light will flash red). When an input signal is received or an operation performed on the PC, the TV will return to the On mode.	
	Reset*2			
	The Reset function returns your Picture/Audio settings to the factory settings. "Picture Size", "MTS", "Audio Language", "HDMI1 Audio" and "Speakers" cannot be reset by this function.			

NOTE:

*1 If there is no input signal in the PC mode, after 1 minute Auto Shut Off will be activated. In PC mode the "PC Standby" setting takes precedence.

*2 The device may not conform to the Energy Star standard after Reset is performed or the Backlight is adjusted.

Memorizing channels

This TV is equipped with a channel memory feature which allows channels to skip up or down to the next channel set into memory, skipping over unwanted channels. Before selecting channels, they must be programmed into the TV's memory. To use this TV with an antenna, set the Signal Type option to the Air mode. When shipped from the factory, this menu option is in the Cable mode.

Air/Cable selection

- 1 Select "Channel", then press **▶** or **ENTER**.
- 2 Press **▲** or **▼** to select "Auto Ch Memory", then press **▶** or **ENTER**.
- 3 Press **▲** or **▼** to select "Signal Type".
- 4 Press **◀** or **▶** to select "Air" or "Cable".

Air - VHF/UHF channels
Cable - CABLE TV channels



CABLE CHART

The chart below is typical of many cable system channel allocations.

Number on this TV	Corresponding CABLE channel	14	15	16	17	18	19	20	21	22							
J	K	L	M	N	O	P	Q	R	S	T							
23	24	25	26	27	28	29	30	31	32	33	34	35	36	37	38	39	40
41	42	43	44	45	46	47	48	49	50	51	52	53	54	55	56	57	58
59	60	61	62	63	64	65	66	67	68	69	70	71	72	73	74	75	76
77	78	79	80	81	82	83	84	85	86	87	88	89	90	91	92	93	94
95	96	97	98	99	100	101	102	103	104	105	106	107	108	109	110	111	112
113	114	115	116	117	118	119	120	121	122	123	124	125	126	127	128	129	130
131	132	133	134	135	136	137	138	139	140	141	142	143	144	145	146	147	148

NOTE:

- It may take a few seconds for a digital channel picture to appear on screen after being selected.

Automatic Search

- 1 Select "Channel", then press **▶** or **ENTER**.
- 2 Press **▲** or **▼** to select "Auto Ch Memory", then press **▶** or **ENTER**.
- 3 Press **▲** or **▼** to select "Automatic Search", then press **▶** or **ENTER**.

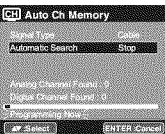

- 4 The TV will begin memorizing all the channels available in your area.
 - It may take from 15 minutes to 30 minutes to complete memorizing digital cable channels. Depending on the reception condition, a bar display may not advance for several minutes, please be patient.

NOTE:

- Memorizing channels is best accomplished during evening "PRIMETIME" hours, as more stations are broadcasting digital signals. Memorizing channels can only be accomplished while a station is broadcasting a digital signal to set that channel into memory.
- If you are unsure of the digital channels available in your area, you may visit www.antennaweb.org to receive a list based on your address or zip code. Should you require further assistance you may call our toll-free customer service line at 1-800-289-0980.
- New digital channels may be added to your area periodically, it is recommended to perform the "Automatic Search" procedure regularly.

Adding Channel

If you find a new digital channel unregistered, you can add the new channel into the channel memory.

- 1 Tune in the new channel.
- 2 Select "Channel", then press **▶** or **ENTER**.
- 3 Press **▲** or **▼** to select "Add/Delete", then press **▶** or **ENTER**.



- 4 Press **▲** or **▼** to select "Adding Channel", then press **▶** or **ENTER**. The new channel will be added into the channel memory.

Add/Delete channel

You can select the channel that you want to skip.

- 1 Select "Channel", then press **▶** or **ENTER**.
- 2 Press **▲** or **▼** to select "Add/Delete", then press **▶** or **ENTER**.
- 3 Press **▲** or **▼** to select "Add/Delete", then press **▶** or **ENTER**.
- 4 Press **▲** or **▼** to select the channel that you want to skip.



- 5 Press **◀** or **▶** to select "Add" or "Delete", whichever function you want to perform.
- 6 Repeat steps 4 - 5 for other channels you want to add or delete.

Clear All

All channels are deleted from the channel memory.

- 1 Select "Channel", then press **▶** or **ENTER**.
- 2 Press **▲** or **▼** to select "Add/Delete", then press **▶** or **ENTER**.
- 3 Press **▲** or **▼** to select "Clear All", then press **▶** or **ENTER**.



Checking the digital signal strength

This TV will allow you to view the digital signal meter for digital channels.

- 1 Select "Channel", then press **▶** or **ENTER**.
- 2 Press **▲** or **▼** to select "DTV Signal".
- 3 Press **▶** or **ENTER** to check the digital signal strength. The digital signal strength screen will appear. If necessary, adjust the direction of the antenna to obtain the maximum signal strength.

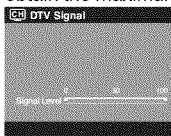

NOTE:

- Signal meter feature is not available for analog channels.
- After 240 seconds, DTV Signal screen will return to normal TV operation automatically.

Labeling channels

Channel label appear with the channel number display each time you turn on the TV, select a channel, or press **DISPLAY**. You can choose any four characters to identify a channel.

To create channel labels

- 1 Select "Channel", then press **▶** or **ENTER**.
- 2 Press **▲** or **▼** to select "Ch Label", then press **▶** or **ENTER**. The Ch Label menu will appear.
- 3 Press **◀** or **▶** to select a channel you want to label, then press **▼**.

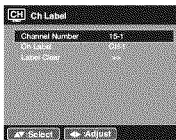

- 4 Press **◀** or **▶** repeatedly until the character you want appears in the first space.



The characters rotation as follows:

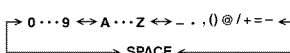

If the character which you desire appears, press **ENTER**.

Repeat this step to enter the rest of the characters. If you would like a blank space in the label name, you must choose the empty space from the list of characters.

- 5 Repeat steps 3-4 for other channel. You can assign a label to each channel.
- 6 When you finish inputting the label name, press **EXIT** to return to the normal screen.

To clear a Ch Label

After step 3 above, press **▲** or **▼** to select "Label Clear", then press **▶** or **ENTER**.

NOTE:

- The channel labels will be reset after "Automatic Search" on page 18.

Labeling video inputs

The Video Label feature allows you to label each input source for your TV.

- 1 Select "Setup", then press **▶** or **ENTER**.
- 2 Press **▲** or **▼** to select "Video Label", then press **▶** or **ENTER**.
- 3 Press **▲** or **▼** to select an input which you want to label.
- 4 Press **◀** or **▶** to select the desired label for that input source.



– / VCR / DVD / STB / Cable / Satellite / Receiver / Game / Camcorder / PC / DVI PC / Blu-ray

Setting the V-Chip

An age limitation can be set to restrict children from viewing or hearing violent scenes or pictures that you may choose to exclude. The restriction applies to "TV Rating" and "Movie Rating" if this data is transmitted. You may set this restriction separately. To use the V-Chip function, you must register a password.

To register a password

- 1 Select "Lock", then press **►** or **ENTER**.
- 2 Select and enter your password (4 digits) using **Number buttons (0-9)**, then press **ENTER**.



"*" appears instead of the number.

- 3 Enter the same password again to confirm, then press **ENTER**.
The password is now registered.

NOTE:

- If you forget the password, contact Customer Service at 1-800-289-0980 for assistance. Your original remote control will be required.
- To avoid forgetting the password, write it down and keep in a safe place.

To set the V-Chip

- 1 Select "Lock" menu, then press **►** or **ENTER**.
- 2 Use **Number buttons (0-9)** to enter your password, then press **ENTER**. The Lock menu will appear.
- 3 Press **◀** or **▶** to set "V-Chip" to "On".
- 4 Press **▲** or **▼** to select "V-Chip Set", then press **►** or **ENTER**.
The V-Chip Set menu appears.
- 5 Press **▲** or **▼** to select which rating will be used, then press **►** or **ENTER**. Each rating below will appear.

TV Rating

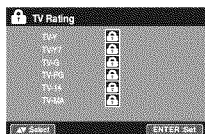

You can set the rating using age level and genre.

Age:

- TV-Y** : All children
- TV-Y7** : 7 years old and above
- TV-G** : General audience
- TV-PG** : Parental guidance
- TV-14** : 14 years old and above
- TV-MA** : 17 years old and above

When you select TV-Y7, TV-PG, TV-14 or TV-MA, press **DISPLAY** to explain the rating.

Genre:

- D** : Dialogue
- L** : Language
- S** : Sex
- V** : Violence
- FV** : Fantasy Violence

Movie Rating

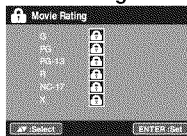

- G** : All ages
- PG** : Parental guidance
- PG-13** : Parental guidance less than 13 years old
- R** : Under 17 years old parental guidance suggested
- NC-17** : 17 years old and above
- X** : Adult only

- 6 Press **▲** or **▼** to select the desired rating, then press **ENTER**.
- 7 Press **EXIT** to return to the normal screen.
V-Chip function is activated now.

To use the TV after the TV is protected.

When a program is received that is blocked by the V-Chip, press **MUTE**, then enter your password. The protection will be temporarily overridden. If the TV is turned off or the channel is changed, the V-Chip restriction will be reactivated.

NOTE:

- The V-Chip function is activated only on programs and input sources that include a rating signal.

To change the password

- 1 Select "Lock", then press **►** or **ENTER**.
- 2 Use **Number buttons (0-9)** to enter your password, then press **ENTER**. The Lock menu will appear.
- 3 Press **▲** or **▼** to select "Change Password", then press **►** or **ENTER**.
The Change Password screen will appear.
- 4 Enter a new password using **Number buttons (0-9)**, then press **ENTER**.
- 5 Enter the same password again to confirm, then press **ENTER**.
The password is now registered.

Downloading the additional V-Chip rating system

As a supplement to the standard V-Chip rating system, your television will be able to download an additional rating system, if such a system becomes available in the future.

To download the additional V-Chip rating system (when available)

- 1 Select "Lock", then press **►** or **ENTER**.
- 2 Use **Number buttons (0-9)** to enter your password, then press **ENTER**. The Lock menu will appear.

- 3 Press ◀ or ▶ to set "V-Chip" to "On".
- 4 Press ▲ or ▼ to select "V-Chip Set (DTV)", then press ▶ or **ENTER**.
- 5 If the TV is not storing the additional rating system, the TV will begin downloading it, which may take some time to be completed.
- 6 Set your preferred content rating limits for the additional rating system.
- 7 You also need "Update" procedure to update rating information.

NOTE:

- You can only download the additional V-Chip rating system when your TV is receiving a digital signal.
- When you download the additional rating system, it may take some time for the download to occur.
- The V-Chip rating information and system are not determined or controlled by the TV.
- The standard V-Chip rating system is available whether your TV is receiving a digital signal or not, and will block both analog and digital programs. To set the restriction level using the standard V-Chip rating system, select V-Chip Set in step 4.
- The downloadable V-Chip rating system is an evolving technology, and availability, content, and format may vary.
- You cannot select this feature if the TV is not receiving a digital signal for the current station.

To clear the all V-Chip settings

- 1 Select "Lock", then press ▶ or **ENTER**.
- 2 Use **Number buttons (0-9)** to enter your password, then press **ENTER**. The Lock menu will appear.
- 3 Press ▲ or ▼ to select "V-Chip Clear", then press ▶ or **ENTER**. The V-Chip Clear screen will appear.
- 4 Use **Number buttons (0-9)** to enter your password, then press **ENTER**. All of your settings return to the factory settings.

Closed Caption

WHAT IS CLOSED CAPTIONING?

This television has the capability to decode and display Closed Captioned television programs. Closed Captioning will display text on the screen for hearing impaired viewers or it will translate and display text in another language.

Captions: This Closed Caption Mode will display text on the screen in English or another language. Generally, Closed Captions in English are transmitted on C1 and Closed Captions in other languages are transmitted on C2.

Text: The Text Closed Caption Mode will usually fill 1/2 of the screen with a programming schedule or other information.

- 1 Select "Setup", then press ▶ or **ENTER**.
- 2 Press ▲ or ▼ to select "Closed Caption", then press ▶ or **ENTER**. The Closed Caption menu will appear.

- 3 Press ◀ or ▶ to set "CC Setting" to "On".
On: Captions will be displayed on the screen.
Off: Captions will not be displayed on the screen.
- 4 Press ▲ or ▼ to select "Analog Caption" or "Digital Caption".
When you select "Analog Caption", you can choose from C1, C2, C3, C4, T1, T2, T3 and T4.
When you select "Digital Caption", you can choose from CS1, CS2, CS3, CS4, CS5 and CS6.
- 5 Press ◀ or ▶ to select the desired Closed Caption mode for both Digital and Analog Caption.
- 6 Press ▲ or ▼ to select "CC Priority", then press ◀ or ▶ to select "Digital CC" or "Analog CC".

NOTE:

- Depending on the broadcast signal, some Analog Captions will function with a Digital broadcast signal. This step prevent that two kind of captions are overlapping.

NOTE:

- If the program or video you selected is not closed-captioned, no captions will display on-screen.
- If text is not available in your viewing area, a black rectangle may appear on-screen. If this happens, set the CC Setting to "Off".
- When selecting Closed Captions, the captioning will be delayed approx. 10 seconds.
- If no caption signal is received, no captions will appear, but the television will remain in the Caption Mode.
- Misspellings or unusual characters may occasionally appear during Closed Captioning. This is normal with Closed Captioning, especially with live programs. This is because during live programs, captions are also entered live. These transmissions do not allow time for editing.
- When Captions are being displayed, on-screen displays, such as volume and mute may be seen but may interfere with Closed Captions.
- Some cable systems and copy protection systems may interfere with the Closed Captioned signal.
- If using an indoor antenna or if TV reception is very poor, the Closed Caption Decoder may not appear or may appear with strange characters or misspelled words. In this case, adjust the antenna for better reception or use an outdoor antenna.
- Closed Caption menu also can be displayed by pressing **CCD** on the remote control.

CC advanced

When you have selected Custom as the display method, you can adjust the various setting listed below as follows:

This feature is designed to customize Digital Captions only.

- 1 Select "Setup", then press ▶ or **ENTER**.
- 2 Press ▲ or ▼ to select "Closed Caption", then press ▶ or **ENTER**. The Closed Caption menu will appear.
- 3 Press ◀ or ▶ to set "CC Setting" to "On".
- 4 Press ▲ or ▼ to select "Digital CC Preset", then press ◀ or ▶ to select "Custom".

- 5 Press ▲ or ▼ to select “CC Advanced”, then press ► or ENTER. The CC Advanced menu will appear.

- 6 Press ▲ or ▼ to select the desired item, then press ◀ or ▶ to change the setting.

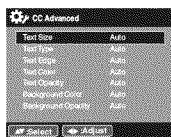

You can select from among the following items and parameters.

- Text Size:** Auto, Small, Standard, Large
- Text Type:** Auto, Style1, Style2, Style3, Style4, Style5, Style6, Style7
- Text Edge:** Auto, None, Raised, Depressed, Uniform, Left Shadow, Right Shadow
- Text Color:** Auto, Black, White, Red, Green, Blue, Yellow, Magenta, Cyan
- Text Opacity:** Auto, Solid, Transparent, Translucent, Flashing
- Background Color:** Auto, Black, White, Red, Green, Blue, Yellow, Magenta, Cyan
- Background Opacity:** Auto, Solid, Transparent, Translucent, Flashing

NOTE:

- You cannot set both “Text Color” and “Background Color” as a same color.
- You cannot set both “Text Opacity” and “Background Opacity” to “Transparent”.

Setting the picture size

You can view 480i and 480p format programs in a variety of picture sizes— Natural, Cinema Wide1, Cinema Wide2, Cinema Wide3, Full and Native.

Selecting the picture size

- 1 Select “Picture”, then press ► or ENTER.
- 2 Press ▲ or ▼ to select “Picture Size”, then press ► or ENTER to display Picture Size menu. Press ▲ or ▼ or corresponding **Number buttons (0-4)** to select the desired picture size, as described below.



NOTE:

- Selectable picture sizes may vary depending on the input source or broadcast signal.
- Picture Size menu also can be displayed by pressing **PICTURE SIZE** on the remote control.

Natural

In some cases, this image will display the size of standard 4:3 with a black side bar.

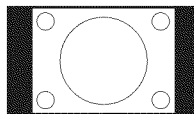

Cinema Wide1 (for 4:3 format programs)

To fill the screen, the right and left edges are extended, however; the center of the picture remains near its former ratio.

The top and bottom edges of the picture may be hidden.

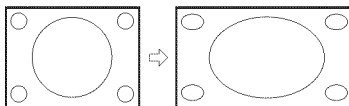

Cinema Wide2 (for letter box programs)

The entire picture is uniformly enlarged—it is stretched the same amount both wider and taller (retains its original proportion).

The top and bottom edges of the picture may be hidden.

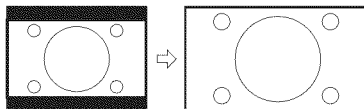

Cinema Wide3 (for letter box programs with subtitles)

To fill the width of the screen, it is extended horizontally. However; it is only slightly extended at the top and the bottom.

The top and bottom edges of the picture may be hidden.

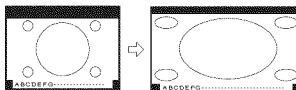

Full (for 16:9 source programs)

Full will display the picture at the maximum size.

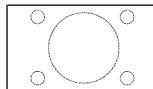

Native (for PC mode only)

Detects the resolution of the signal of the image and it will be shown on the screen with same amount of pixels.

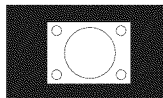

NOTE:

- Some High Definition and/or Digital broadcasts may not allow you to change the picture size.
- In HDMI or COMPONENT mode with a scanning rate of 720p, 1080i or 1080p (HDMI only) only the Cinema Wide2 and Full picture size feature are available.
- In PC mode, only the Natural, Full and Native picture size features are available. In PC mode (WXGA), only the Full and Native picture size features are available.

Preparation

The following pages describe the setup/operation in DVD mode.

Preparation

Before DVD/CD operation, please make the following preparations.

- 1 Insert the AC cord plug into a standard 120V 60Hz polarized AC outlet.
 - If the AC cord plug is plugged in for the first time, wait for about 5 seconds before pressing **POWER**.
- NOTE:**
 - When connecting to other equipment, unplug the unit from the AC outlet.
- 2 Press **POWER** on the unit or on the remote control to turn on the unit. The **POWER** indicator will change to green.
 - Each time you turn the unit ON, the TV/DVD starts from the TV mode.
 - When using an amplifier, switch on the amplifier.
- 3 Press **TV/DVD** to select DVD mode. The DVD startup screen will appear on the screen.



NOTE:

- **If the unit does not operate properly:** Static electricity, etc., may affect the player's operation. Disconnect the AC power cord once, then connect it again.
- **About inserting disc:** If the unit is slanted or moved while inserting disc, the disc may get damage.

Status display of disc

Press **DISPLAY**. The status display of the disc will appear on the screen.

- Display messages may change at every time when you press **DISPLAY** for some discs or files.
- To make the status display screen disappear, press **DISPLAY** again.

Playback procedure

- 1 Press **TV/DVD** to select DVD mode.
- 2 Place the disc in the disc slot with the label side facing forward. (If the disc has a label.) Hold the disc without touching either of its surfaces, align it with the guides, and place it in position.

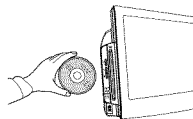

- 3 On the screen, "**▲**" changes to "Loading" and then playback will commence.
 - A menu screen may appear on the TV screen, if the disc has a menu feature. In this case, press **▲**, **▼**, **◀**, **▶** or **ENTER** to operate a menu feature.
- 4 Press **STOP (■)** to end playback.
 - The unit can record where you stop a video, but it depends on a disc you are using. Press **PLAY (▶)** to resume a playback point. The unit can store a memory of stopped point of last five discs that you have played. When one of these discs is next loaded, you can resume playback from where you stopped playing last time.
 - If you press **STOP (■)** again ("Resume off" appears on the screen) the unit will clear the stopped point.
 - You cannot save a stopped point for some discs. If a number of discs played and stored in the unit exceeds five, a new memory will overwrite the old stored memory.
- 5 Press **▲ (EJECT)**. Remove the disc and then press **POWER**. The unit turns off.
 - When you eject the disc, you may hear mechanism noise, but it is not malfunction.

NOTE:

- If a non-compatible disc is loaded, "Can't play disc" or "Incompatible disc region number Can't play disc" will appear on the TV screen according to the type of loaded disc. In this case, check your disc again (see page 9).
- Some discs may take a minute or so to start playback.
- A prohibition message "Depending on the disc, this operation may be prohibited" or "This operation can't be performed" may appear at the screen. This message means either the feature you tried is not available on the disc, or the unit cannot access the feature at this time. This does not indicate a problem with the unit.
- When you set a single-faced disc label downwards (i.e. the wrong way up) "Loading" will appear on the display and then "Can't play disc" will be displayed.
- Some playback operations of DVDs may be intentionally fixed by software producers. Since this unit plays DVDs according to the disc content recorded, some playback features may not be available. Also refer to the instructions supplied with the DVDs.

Special playback

Fast Forward Playback

Press **SEARCH (▶▶)** during normal playback. Each press of **SEARCH (▶▶)** will increase the speed of the search.

- To resume normal playback, press **PLAY (▶)**.

Review Playback

Press **SEARCH (◀◀)** during normal playback. Each press of **SEARCH (◀◀)** will increase the speed of the search.

- To resume normal playback, press **PLAY (▶)**.

Still Playback

Press **PAUSE (||)** during normal playback to pause playback.

- To resume normal playback, press **PLAY (▶)** or **PAUSE (||)**.

Frame Advance

Press **PAUSE (||)** during normal playback. One frame is advanced each time you press **SEARCH (◀◀)** or **SEARCH (▶▶)**.

- To resume normal playback, press **PLAY (▶)**.

Slow-motion Playback

Press **SLOW (⏪)** or **SLOW (⏩)** during normal playback or still playback. Each press of **SLOW** will change the speed of the slow.

- To resume normal playback, press **PLAY (▶)**.
- To resume the still playback, press **PAUSE (||)**.

Locating a chapter or track

Press **SKIP(▶▶⏪)** Forward or **SKIP(⏩◀◀)** Reverse during playback to locate a chapter/track that you want to watch.

Each time you press the button, a chapter or track is skipped.

NOTE:

- The TV/DVD is capable of holding a still video image or On screen display image on your television screen indefinitely. If you leave the still video image or On screen display image displayed on your TV for an extended period of time, you risk permanent damage to your television screen.

Zooming

This TV/DVD will allow you to zoom in on the frame image. You can then make selections by switching the position of the frame.

- 1 Press **ZOOM** during playback. The center part of the image will be zoomed in. Each press of **ZOOM** will change the ZOOM magnification Zoom 2x and Zoom 4x.

- 2 Press **▲/▼/◀/▶** to view a different part of the frame. You may move the frame from the center position UP, DOWN, LEFT or RIGHT.

- 3 In the zoom mode press **ZOOM** repeatedly to return to a 1:1 view.

NOTE:

- You can select the Still Playback or Fast Forward (Review) Playback in the zoom mode.
- Some discs may not respond to the zoom feature.

Locating desired scene

Use the title, chapter and time recorded on the disc to locate the desired point to playback.

- 1 Press **JUMP** during playback.
- 2 Press **▲** or **▼** to select the "Title Search", "Chapter Search", "Time Search" or "Track Search". Then press **▶** or **ENTER**.
- 3 Press **Number buttons (0-9)** to input the number.
 - If you input a wrong number, press **CANCEL**.
 - Refer to the package supplied with the disc to check the numbers.
- 4 Press **ENTER**.
 - Playback starts.
 - When you change the title, playback starts from Chapter 1 of the selected title.
 - Some discs may not work in the above operation.

A-B Repeat playback

A-B repeat playback allows you to repeat material between two selected points.

- 1 Press **REPEAT A-B** during playback. The start point is selected.
- 2 Press **REPEAT A-B** again. The end point is selected. Playback starts at the point that you selected. Playback stops at the end point, returns to Point A automatically, then starts again.
 - To resume normal playback press **REPEAT A-B** again.

NOTE:

- In A-B Repeat mode, subtitles near the A or B locations may not be displayed.
- You may not be able to set A-B Repeat during certain scenes of the DVD.
- A-B Repeat does not work with an interactive DVD, MP3/WMA/JPEG-CD.

Marking desired scenes

The TV/DVD stores the points that you want to watch again up to 12 points.

You can resume playback from each scene.

Marking the scenes

- 1 Press **MARKER** during playback.
- 2 Select the blank Marker using **▲/▼/◀/▶**, then press **ENTER** at the desired scene.
 - Up to 12 scenes can be selected.
 - Repeat this procedure to set the other 11 scenes.
- 3 Press **MARKER** to return to the normal screen.

Returning to the scenes

- 1 Press **MARKER** during playback or stop mode.
- 2 Press **▲/▼/◀/▶** to select the Marker 1-12.
- 3 Press **ENTER**.
Playback starts from the marked scene.

To cancel the Marker

Follow the above steps 1~2, then press **CANCEL**.

NOTE:

- Some discs may not work with the marking operation.
- The marking is cancelled when you eject the disc or turn the power off.
- Some subtitles recorded around the marker may fail to appear.

Changing angles

When playing back a disc recorded with multi-angle facility, you can change the view angle.

- 1 Press **ANGLE** during playback.
The current angle will appear.



- 2 Press **ANGLE** repeatedly until the desired angle is selected.

NOTE:

- In case of JPEG-playback, the JPEG-image is rotated 90 degrees to the right.
- Depending on the DVD, you may not be able to change the angles even if multi-angles are recorded on the DVD.

Changing soundtrack language

You can select the language when you play a multilingual disc.

- 1 Press **AUDIO** during playback.
The current soundtrack language will appear.

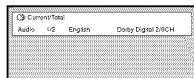

- 2 Press **AUDIO** repeatedly until the desired language is selected.
The on-screen display will disappear after a few seconds.



NOTE:

- If the desired language is not heard after pressing **AUDIO** several times, the language is not recorded on the disc.
- Changing soundtrack language is cancelled after "Resume off" has been selected.
- The initial default language or available language will be heard if the disc is played back again.

Subtitles

Changing the subtitle language

You can select the language when playing back a disc recorded with multilingual subtitles.

- 1 Press **SUBTITLE** repeatedly during playback until your desired language appears.
The on-screen display will disappear after a few seconds.

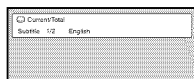

Turning the subtitles off



Press **SUBTITLE** during playback until "Off" appears.

NOTE:

- Changing subtitle language is cancelled after "Resume off" has been selected.
- Some functions may not work on some DVDs. You may not be able to turn subtitles on or off or change subtitles.
While playing the DVD, the subtitle may change when:
 - you eject or insert the disc.
 - you change the title.
- In some cases, the subtitle language is not changed to the selected one immediately.

Using HOME MENU

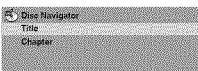
Playing a disc

- 1 Press **SETUP** during stop mode. HOME MENU will appear.
- 2 Press **▲/▼/◀/▶** to select "Disc Navigator", then press **ENTER**.
- 3 Press **▲/▼** to select desired option, then press **ENTER**.
 - Some discs may not work Disc Navigator.
 - Depending on a disc, you can select Title, Chapter, or both.
- 4 Press **▲/▼/◀/▶** or **Number Buttons (0-9)** to select Title, Chapter, Track or Time then press **ENTER**.
 - Press **SKIP (◀◀)** or **SKIP (▶▶)** to move next/previous page.
 - Press **RETURN** to return to previous screen.

Playing a file

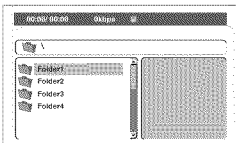
- 1 Press **SETUP** during stop mode. HOME MENU will appear.
- 2 Press **▲/▼/◀/▶** to select "Disc Navigator", then press **ENTER**.
- 3 Press **▲/▼** to select folder, then press **ENTER**.
- 4 Press **▲/▼** to select file, then press **ENTER**.
 - If you select JPEG file, unit shows the pictures one after another automatically.
 - Press **RETURN** to go to previous step.

NOTE:

- When music files and JPEG files are recorded in one disc, you can play simultaneously. Please select the music file then select the JPEG file.

Play mode

A-B repeat playback

A-B repeat playback allows you to repeat selection between two selected points.

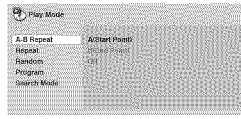
- 1 Press **PLAY MODE** during playback. Play Mode screen will appear.
- 2 Press **▲/▼** to select "A-B Repeat", then press **▶** or **ENTER**.
- 3 Press **▲/▼** to select "A(Start Point)", then press **ENTER**. The start point is selected.
- 4 Press **▲/▼** to select "B(End Point)", then press **ENTER**. The end point is selected. Playback starts at the point that you selected. Playback stops at the end point and returns to Point A automatically, then starts again.

To resume normal playback

Select "Off" in step 3.

NOTE:

- Some discs may not work Play mode function.
- A-B Repeat playback does not work with MP3/WMA CD.

Repeat playback

- 1 Press **PLAY MODE** during playback. Play Mode screen will appear.
- 2 Press **▲/▼** to select "Repeat", then press **▶** or **ENTER**.
- 3 Press **▲/▼** to select desired repeat option, then press **ENTER**. The unit automatically starts repeat playback after finishing the current title or chapter.

To resume normal playback

Select "Repeat Off" in step 3.

Random playback

- 1 Press **PLAY MODE** during playback. Play Mode screen will appear.
- 2 Press **▲/▼** to select "Random", then press **▶** or **ENTER**.
- 3 Press **▲/▼** to select desired random playback option, then press **ENTER**. The unit automatically starts random playback.

To resume normal playback

Select "Random Off" in step 3.

NOTE:

- You cannot play Random for programmed contents (Random play is not permitted during Program playback).
- During Random playback, it may repeat the same title, chapter or track.
- Random playback does not work with MP3/WMA CD.

Program playback

- 1 Press **PLAY MODE** during playback or stop mode. Play Mode screen will appear.
- 2 Press **▲/▼** to select "Program", then press **▶** or **ENTER**.
- 3 Press **▲/▼** to select "Create/Edit", then press **ENTER**. "Create/Edit" display differs, depending on discs or files.

Program Step	Current	Title 02	Chapter001
01_01	Title 01	Chapter 001	
02	Title 02	Chapter 001	
03	Title 03	Chapter 002	
04	Title 04	Chapter 002	
05	Title 05		
06	Title 06		
07	Title 07		
08	Title 08		
- 4 Press **▲/▼/◀/▶** to select Title, Chapter, Track or File, then press **ENTER**.
 - When you add a program, find where you want to add it (Program Step) and select Title, Chapter or Track then press **ENTER**. (It will be added to the left if File is added.)
 - To go to previous step, press **RETURN**.
 - If **RETURN** is pressed while programming, the content will be deleted.
 - To delete a program, select Program Step that you want to delete and press **CANCEL**.
- 5 Press **PLAY (▶)**.
 - To play existing programmed contents, select "Playback Start" from Play Mode screen and press **ENTER**.
 - To resume normal playback, select "Playback Stop" in Play Mode screen and press **ENTER**. Your programmed contents are saved.
 - To delete all programmed contents, select "Program Delete" in Play Mode screen and press **ENTER**.

NOTE:

- You can repeat the programmed contents. Select "Program Repeat" from "Repeat" in the Play Mode screen during Program playback.
- You cannot play Random for programmed contents (Random play is not permitted during Program playback).
- In stop mode, you can also enter Play Mode screen by selecting "Play Mode" in HOME MENU.

Locating desired scene

- 1 Press **PLAY MODE** during playback or stop mode. Play Mode screen will appear.
- 2 Press **▲/▼** to select "Search Mode", then press **▶** or **ENTER**.
- 3 Press **▲/▼** to select desired search mode option, then press **▶** or **ENTER**.
 - Search Mode options differs, depending on discs or files.
- 4 Input Title, Chapter, Track or Folder number or Time by using **Number buttons (0-9)** and press **ENTER**.

Play Mode	Title Search	Input Chapter
A-B Repeat	Chapter Search	[0][1][2]
Repeat	Time Search	
Search		
Program		
Search Mode		

- For instance, if you want to enter 1hr 4min (64:00), input 6, 4, 0, 0.

NOTE:

- You can locate desired scene in Menu screen for some DVD video.
- In stop mode, you can also enter Play Mode screen by selecting "Play Mode" in HOME MENU.

Audio Settings menu

The Audio Settings menu offers features for adjusting the way discs sound.

- 1 Press **SETUP** during stop mode. HOME MENU will appear.
- 2 Press **▲/▼/◀/▶** to select "Audio Settings", then press **ENTER**.

HOME MENU	DVD
Audio Settings	Video Adjust
Play Mode	Disk Navigator
Initial Settings	
- 3 Press **▲/▼/◀/▶** to setting the option, then press **ENTER**.

Audio Settings	Off
Equalizer	Pop
Audio DRC	Music
Dialog	Normal
	Technic
	Center
	Soft

- 4 Press **SETUP** to save the setting.

Equalizer

Select the most suitable setting to match a category of music that you are listening to.

Audio DRC

- Adjusts loud sound levels down and quiet sound levels up while playing. This is useful, for instance, when you watch a film in the late night.
- Audio DRC only works with Dolby Digital Sound.
- The effect depends on your AV amplifier and speaker volume. Adjust the sound as you wish and find the most effective setting.

Dialog

Adjust setting when you cannot hear dialogs very well.

NOTE:

- It may not be very effective for some discs or files.

Video Adjust menu

From the Video Adjust menu you can adjust various settings that affect how the picture is presented.

1 Press **SETUP** during stop mode.
HOME MENU will appear.

2 Press **▲/▼/◀/▶** to select "Video Adjust", then press **ENTER**.



3 Press **▲/▼/◀/▶** to setting the option, then press **ENTER**.

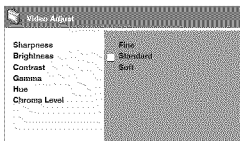

4 Press **SETUP** to save the setting.

Sharpness

Adjust sharpness of images.

Brightness

Adjust brightness of images.

Contrast

Adjust a ratio of brightness between the brightest part and the darkest part.

Gamma

Emphasize dark part of images.

Hue

Adjust a balance between green and red.

Chroma Level

Adjust color density. It is effective with animation or something with high color density.

NOTE:

- It may not be very effective for some discs or files.

Quick guide for DVD menu operation

You can change the default settings to customize performance to your preference.

Setting procedure

1 Press **SETUP** in stop mode.
HOME MENU will appear.

2 Press **▲/▼/◀/▶** to select "Initial Settings", then press **ENTER**.

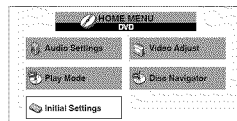

3 Press **▲/▼/◀/▶** to select the desired option, then press **ENTER**.

4 Change the selection using **▲/▼/◀/▶** or **ENTER**, by referring to the corresponding page 29.

- Repeat steps 3 and 4 to change other option.

5 To clear HOME MENU screen, press **SETUP**.

Function Setup

Setting	Option	
Digital Audio Out settings		
Digital Out	On	Digital audio is output when playing a disc.
	Off	Digital audio is not output when playing a disc.
Dolby Digital Out	Dolby Digital	Dolby Digital encoded digital audio is output when playing a Dolby Digital DVD disc.
	Dolby Digital > PCM	Dolby Digital audio is converted to PCM audio before being output.
DTS Out	DTS	DTS encoded digital audio is output when playing a DTS disc. (Noise will be output if your amplifier/receiver is not compatible with DTS audio.)
	Off	DTS encoded digital audio is not output when playing a DTS disc.
96kHz PCM Out	96kHz > 48kHz	96 kHz digital audio is converted to 48 kHz for digital output.
	96kHz	96 kHz digital audio is output as is at 96 kHz.
MPEG Out	MPEG	MPEG encoded digital audio is output as is.
	MPEG > PCM	MPEG encoded digital audio is converted to PCM audio for digital output.
Video Output settings		
TV Screen	4:3 (Letter Box)	Set Picture Size to Natural. Widescreen movies are shown with black bars top and bottom.
	4:3 (Pan & Scan)	Set Picture Size to Natural. Widescreen movies are shown with the sides cropped so that the image fills the screen.
	16:9 (Wide)	Set if you have a widescreen TV.
Language settings		
Audio Language	English/French/Spanish	If there is an English, French or Spanish soundtrack on the disc, then it will be played.
	Other Language	Select to choose a language other than the ones displayed. (See Language Code List on page 31.)
Subtitle Language	English/French/Spanish	If there is an English, French or Spanish subtitle on the disc, then it will be displayed.
	Other Language	Select to choose a language other than the ones displayed. (see Language Code List on page 31.)
DVD Menu Lang.	w/Subtitle Lang.	DVD disc menus will be displayed in the same language as your selected subtitle language, if possible.
	English/French/Spanish	If there is an English, French or Spanish DVD menu language on the disc, then it will be displayed.
	Other Language	Select to choose a language other than the ones displayed. (see Language Code List on page 31.)
Subtitle Display	On	Subtitles are displayed according to your selected subtitle language (see above).
	Off	Subtitles are always off by default when you play a DVD disc (note that some discs override this setting).
Display settings		
Angle Indicator	On	A camera icon is displayed on-screen during multi-angle scenes on a DVD disc.
	Off	No multi-angle indication is shown.
Options settings		
Parental Lock		See page 30.

Parental Control

Some discs are specified as not suitable for children. Such discs can be limited not to playback with the unit.

How to into the Parental Lock menu

- 1 Press **SETUP** in stop mode. HOME MENU will appear.
- 2 Press **▲/▼/◀/▶** to select "Initial Settings", then press **ENTER**.
- 3 Press **▲/▼** to select "Options", then press **▶** or **ENTER**. Then press **▶** or **ENTER** to enter the Parental Lock menu.

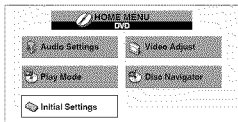

Set Password

- 1 Press **▲** or **▼** to select "Password", then press **ENTER**.
- 2 Press **Number buttons (0-9)** to input the password, then press **ENTER**.

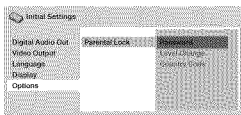

Change Password

- 1 Press **▲** or **▼** to select "Password Change", then press **ENTER**.
- 2 Press **Number buttons (0-9)** to input the current password, then press **ENTER**.
- 3 Press **Number buttons (0-9)** to input the new password. Press **ENTER**. Now your new password has been set. Be sure to remember this number!

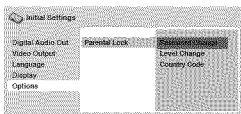

Level Change

- 1 Press **▲** or **▼** to select "Level Change", then press **ENTER**.
- 2 Press **Number buttons (0-9)** to input the current password, then press **ENTER**.
- 3 Press **◀** or **▶** to select from the level 1 to level 8. The limitation will be more severe as the level number is lower. Then press **ENTER**.

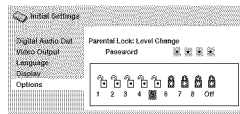
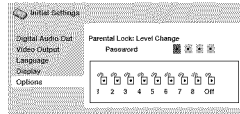
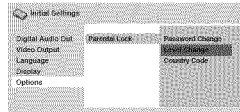

- Level 1:** DVD software for adults cannot be played back.
- Level 8:** Virtually all DVD software can be played back.
- Level Off:** The parental control setting does not function.

Country Code

- 1 Press **▲** or **▼** to select "Country Code", then press **ENTER**.
- 2 Press **Number buttons (0-9)** to input the current password, then press **ENTER**.
- 3 Press **▲** or **▼** to select the input mode from "Country Code List" or "Code".

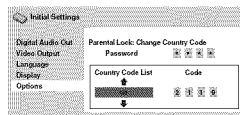
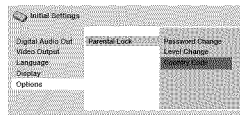

- When you selected "Country Code List": Press **▲** or **▼** to select Country Code, then press **ENTER**.
- When you selected "Code": Press **▶** then use the **Number buttons (0-9)** to enter the 4-digit Country Code, then press **ENTER**. (see Country/Area Code List on page 31)

NOTE:

- Depending on the discs, the unit cannot limit playback.
- Some discs may not be encoded with specific rating level information though its disc jacket says "adult." For those discs, the age restriction will not work.
- If you input a wrong number, press **◀**, then input correct number.

Language Code List

Language (Language code letter), Language code

Japanese (ja), 1001	Bhutani (dz), 0426	Kirghiz (ky), 1125	Sinhalese (si), 1909
English (en), 0514	Esperanto (eo), 0515	Latin (la), 1201	Slovak (sk), 1911
French (fr), 0618	Estonian (et), 0520	Lingala (ln), 1214	Slovenian (sl), 1912
German (de), 0405	Basque (eu), 0521	Laothian (lo), 1215	Samoan (sm), 1913
Italian (it), 0920	Persian (fa), 0601	Lithuanian (lt), 1220	Shona (sn), 1914
Spanish (es), 0519	Finnish (fi), 0609	Latvian (lv), 1222	Somali (so), 1915
Chinese (zh), 2608	Fiji (fj), 0610	Malagasy (mg), 1307	Albanian (sq), 1917
Dutch (nl), 1412	Faroese (fo), 0615	Maori (mi), 1309	Serbian (sr), 1918
Portuguese (pt), 1620	Frisian (fy), 0625	Macedonian (mk), 1311	Siswati (ss), 1919
Swedish (sv), 1922	Irish (ga), 0701	Malayalam (ml), 1312	Sesotho (st), 1920
Russian (ru), 1821	Scots-Gaelic (gd), 0704	Mongolian (mn), 1314	Sundanese (su), 1921
Korean (ko), 1115	Galician (gl), 0712	Moldavian (mo), 1315	Swahili (sw), 1923
Greek (el), 0512	Guarani (gn), 0714	Marathi (mr), 1318	Tamil (ta), 2001
Afar (aa), 0101	Gujarati (gu), 0721	Malay (ms), 1319	Telugu (te), 2005
Abkhazian (ab), 0102	Hausa (ha), 0801	Maltese (mt), 1320	Tajik (tg), 2007
Afrikaans (af), 0106	Hindi (hi), 0809	Burmese (my), 1325	Thai (th), 2008
Amharic (am), 0113	Croatian (hr), 0818	Nauru (na), 1401	Tigrinya (ti), 2009
Arabic (ar), 0118	Hungarian (hu), 0821	Nepali (ne), 1405	Turkmen (tk), 2011
Assamese (as), 0119	Armenian (hy), 0825	Norwegian (no), 1415	Tagalog (tl), 2012
Aymara (ay), 0125	Interlingua (ia), 0901	Occitan (oc), 1503	Setswana (tn), 2014
Azerbaijani (az), 0126	Interlingue (ie), 0905	Oromo (om), 1513	Tonga (to), 2015
Bashkir (ba), 0201	Inupiak (ik), 0911	Oriya (or), 1518	Turkish (tr), 2018
Byelorussian (be), 0205	Indonesian (in), 0914	Panjabi (pa), 1601	Tsonga (ts), 2019
Bulgarian (bg), 0207	Icelandic (is), 0919	Polish (pl), 1612	Tatar (tt), 2020
Bihari (bh), 0208	Hebrew (iw), 0923	Pashto, Pushto (ps), 1619	Twi (tw), 2023
Bislama (bi), 0209	Yiddish (ji), 1009	Quechua (qu), 1721	Ukrainian (uk), 2111
Bengali (bn), 0214	Javanese (jw), 1023	Rhaeto-Romance (rm), 1813	Urdu (ur), 2118
Tibetan (bo), 0215	Georgian (ka), 1101	Kirundi (rn), 1814	Uzbek (uz), 2126
Breton (br), 0218	Kazakh (kk), 1111	Romanian (ro), 1815	Vietnamese (vi), 2209
Catalan (ca), 0301	Greenlandic (kl), 1112	Kinyarwanda (rw), 1823	Volapük (vo), 2215
Corsican (co), 0315	Cambodian (km), 1113	Sanskrit (sa), 1901	Wolof (wo), 2315
Czech (cs), 0319	Kannada (kn), 1114	Sindhi (sd), 1904	Xhosa (xh), 2408
Welsh (cy), 0325	Kashmiri (ks), 1119	Sangho (sg), 1907	Yoruba (yo), 2515
Danish (da), 0401	Kurdish (ku), 1121	Serbo-Croatian (sh), 1908	Zulu (zu), 2621

Country/Area Code List

Country/Area, Country/Area code, Country/Area code letter

Argentina, 0118, ar	Finland, 0609, fi	Malaysia, 1325, my	Singapore, 1907, sg
Australia, 0121, au	France, 0618, fr	Mexico, 1324, mx	Spain, 0519, es
Austria, 0120, at	Germany, 0405, de	Netherlands, 1412, nl	Sweden, 1905, se
Belgium, 0205, be	Hong Kong, 0811, hk	New Zealand, 1426, nz	Switzerland, 0308, ch
Brazil, 0218, br	India, 0914, in	Norway, 1415, no	Taiwan, 2023, tw
Canada, 0301, ca	Indonesia, 0904, id	Pakistan, 1611, pk	Thailand, 2008, th
Chile, 0312, cl	Italy, 0920, it	Philippines, 1608, ph	United Kingdom, 0702, gb
China, 0314, cn	Japan, 1016, jp	Portugal, 1620, pt	USA, 2119, us
Denmark, 0411, dk	Republic of Korea, 1118, kr	Russian Federation, 1821, ru	

Connections to other equipment

The exact arrangement you use to interconnect various video and audio components to this unit is dependent on the model and features of each component. Check the Owner's Manual provided with each component for the location of video and audio inputs and outputs.

To connect the LCD TV/DVD to a VCR

Rear of the unit

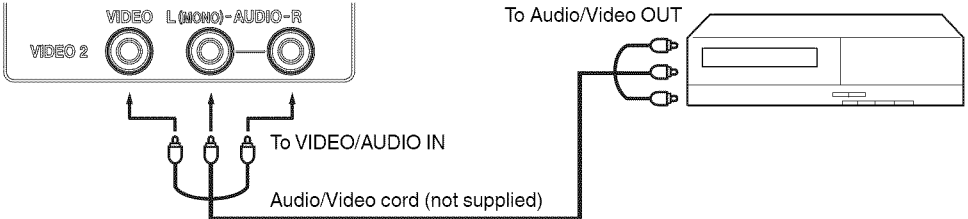

To connect the LCD TV/DVD to a DVD player with Component Video Input

You can enjoy a high quality picture by connecting the unit's COMPONENT VIDEO OUT jacks of your DVD player with the COMPONENT video cables (not supplied).

Rear of the unit

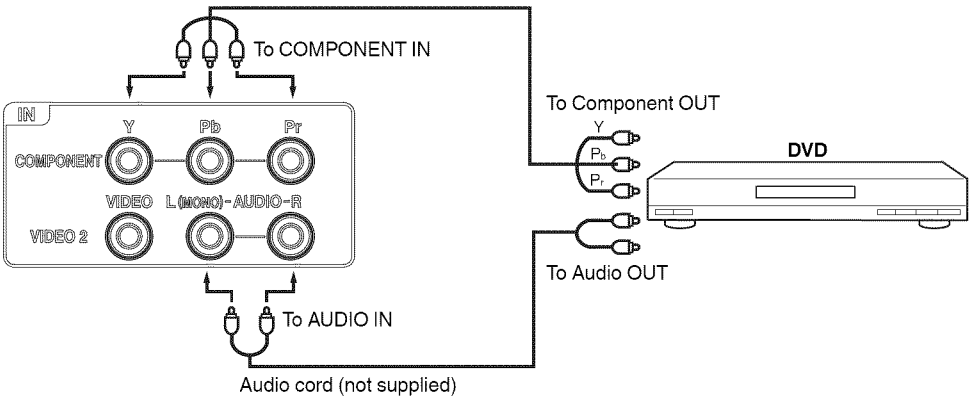

NOTE:

- Component Video input of the unit are for use with a device which output 480i/1080i interlaced signals and 480p/720p progressive signals.

To connect the LCD TV/DVD to a camcorder, or a TV Game

To playback from a camcorder, connect the camcorder to the unit as shown.

This unit can also be used as a display device for many video games. However, due to the wide variety of signals generated by these devices and subsequent hook-up variations required, they have not all been included in the suggested connection diagrams. You'll need to consult each component's Owner's Manual for additional information.

Left of the unit

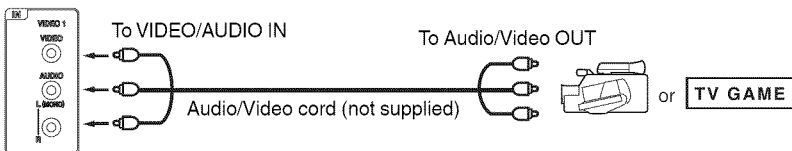

To connect an audio system

This connection allows you to use an audio amplifier and external speakers, and adjust the audio level using the TV's remote control. To control the audio, turn on the TV and the stereo amplifier, and turn off the TV's built-in speakers (see "Speakers" on page 17).

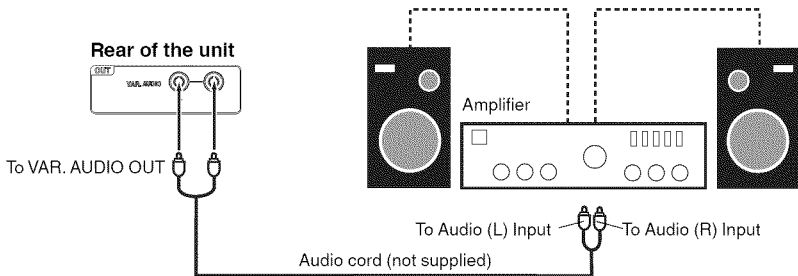

NOTE:

To hear sound when using an external audio amplifier, the volume of both the TV and the amplifier must be set above 0 (zero). For example, if the volume of the TV is set to 0, you will not be able to hear any sound, even if the volume of the amplifier is at its highest level.

To connect a HDMI or a DVI device to the unit

The HDMI1/DVI input receives digital audio and uncompressed video from a HDMI device or uncompressed digital video from a DVI device. When you connect to a DVI device with a HDMI-to-DVI adapter cable, it transfers only video signal. Separate analog audio cords required.

Rear and left of the unit

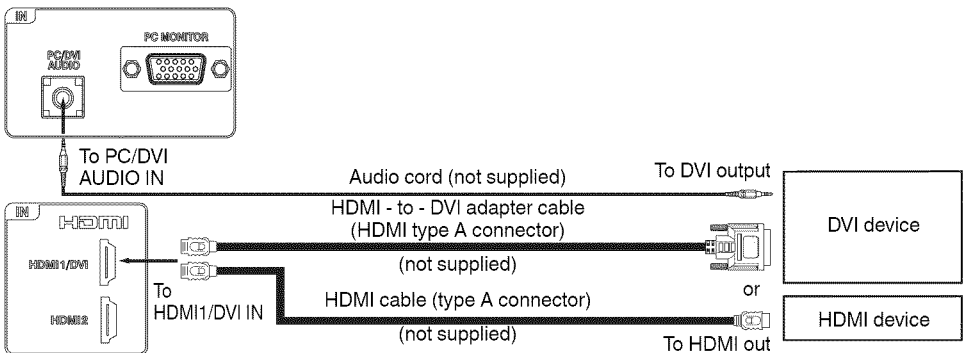

NOTE:

- When using HDMI 1/DVI IN to connect your HDMI or DVI devices, you must select the corresponding audio input source (HDMI or DVI) on the menu screen (see page 17). Otherwise you will only see the image with no sound.
- If you connect an external component (cable box, satellite receiver, etc.) to this LCD TV using an HDMI cable or a DVI to HDMI cable, the image will not display if the output resolution of the component is set to 480i. To receive the picture you must change the output resolution on the external component.
- Should you require further instruction, please contact the manufacturer of the external component.

Using an AV Amplifier with built-in digital surround

If you are using an Amplifier with built-in digital surround sound, you can enjoy various audio systems including Dolby Digital Surround audio that sounds just like the movie.

Connect an AV amplifier with built-in Dolby Digital decoder, DTS decoder, or MPEG decoder etc. as shown below.

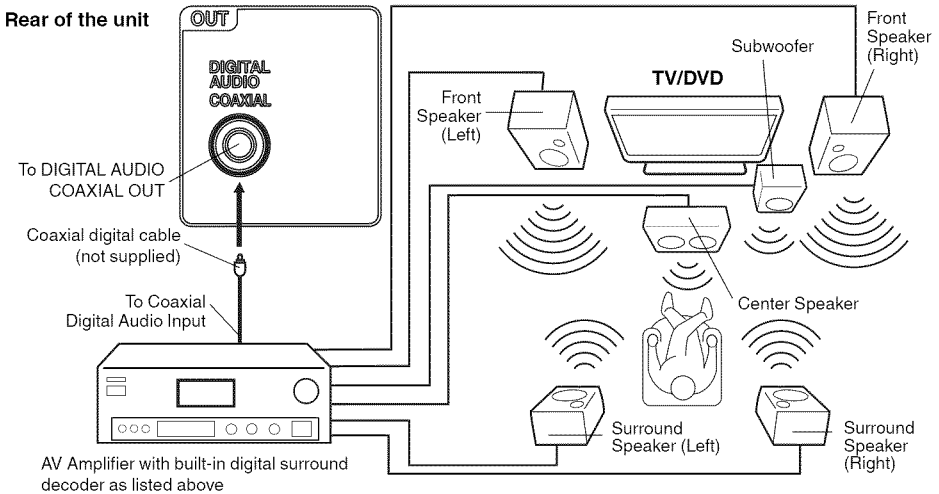

NOTE:

- When you are viewing digital broadcast, this unit will not work in conjunction with DTS audio or MPEG audio. There will be no sound output if connected to an AV amplifier with a built-in DTS decoder or MPEG decoder.
- Digital Audio Output terminal does not output the sounds from devices connected by HDMI.

To connect the LCD TV/DVD to a PC (Personal Computer)

BEFORE YOU CONNECT THIS TV TO YOUR PC, CHANGE THE ADJUSTMENT OF YOUR PC'S RESOLUTION AND REFRESH RATE (60 HZ).

Connect one end of a (male to male) VGA cable to the video cord of the computer and the other end to the VGA connector PC MONITOR IN on the rear of the TV. Attach the connectors firmly with the screws on the plug. In case of a Multimedia computer, connect the audio cord to the audio output of your Multimedia computer and to the AUDIO IN connector of the PC/DVI AUDIO IN jack of the TV. You can also connect the PC with HDMI cable. If you use DVI-to-HDMI cable, please connect audio cord as same way as VGA cable.

Press **INPUT SELECT** on the remote control to select PC mode.

Switch on the computer. The TV can operate as the computer monitor.

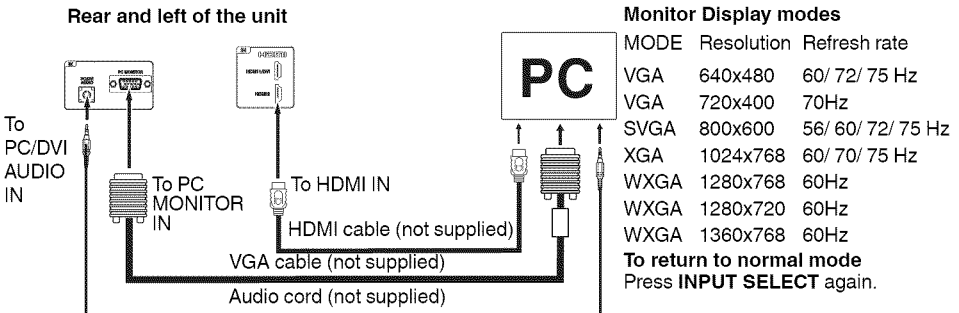

NOTE:

- The on-screen displays will have a different appearance in PC mode than in TV mode.
- If there is no video signal from the PC when the unit is in PC mode, "No signal" will appear on the TV-screen.

Reception disturbances

Most types of television interference can be remedied by adjusting the height and position of the VHF/ UHF antenna. Outdoor antennas are recommended for best results. The most common types of television interference are shown below. If one of these symptoms appear when the TV is connected to a Cable TV system, the disturbance may be caused by the local Cable TV company broadcast.

IGNITION

Black spots or horizontal streaks may appear, the picture may flutter or drift. Usually caused by interference from automobile ignition systems, neon lamps or AC powered tools and appliances such as drills or hair dryers.



GHOSTS

Ghosts are caused by the television signal following two paths. One is the direct path and the other is reflected by tall buildings, hills or other large objects. Changing the direction or position of the antenna may improve the reception.

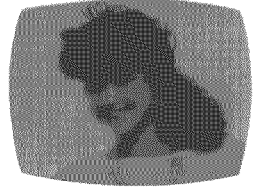

SNOW

If the TV is located far from the TV station, in a fringe reception area where the signal is weak, small dots may appear in the picture. If the signal is extremely weak, the installation of a larger external antenna may be necessary.

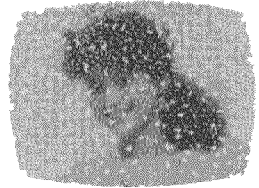

RADIO FREQUENCY INTERFERENCE (RFI)

Caused by two-way radios, this type of interference produces moving ripples or diagonal streaks in the picture. Some cases may cause a loss of contrast in the picture. Changing the direction and position of the antenna or installing an RFI filter may improve the picture.

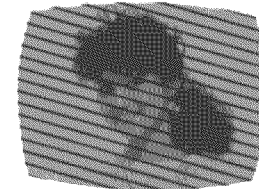

PICTURE SIZE VARIATION

A slight picture size variation is normal when you adjust the CONTRAST or BRIGHTNESS settings.



CARE AND MAINTENANCE

To prevent fire or shock hazard, disconnect the TV from the power source before cleaning. The finish on the cabinet may be cleaned with mild soap and a soft, damp cloth and cared for as other furniture. Use caution when cleaning or wiping the plastic parts.

Problems and troubleshooting

Use the following check list for troubleshooting when you have problems with your TV/DVD. Consult your local dealer or service outlet if problems persist.

Be sure all connections are properly made when using with other units.

SYMPTOMS	POSSIBLE SOLUTIONS	PAGE
POWER		
TV/DVD does not operate.	<ul style="list-style-type: none"> • Make sure the power cord is plugged in. • Power is off, check fuse or circuit breaker. • Unplug unit, then plug it back in. 	13
TV BROADCAST RECEPTION		
Poor sound or no sound.	<ul style="list-style-type: none"> • Station or Cable TV experiencing problems, tune to another station. • Check Volume adjustments or muting. • Check for sources of possible interference. 	15 15, 16 35
Poor picture or no picture.	<ul style="list-style-type: none"> • Station or Cable TV experiencing problems, tune to another station. • Check antenna or Cable TV connections, reorient antenna. • Check for sources of possible interference. • Check picture control adjustments. 	15 14 35 17
Poor reception on some channels.	<ul style="list-style-type: none"> • Station or Cable TV experiencing problems, tune to another station. • Station signal is weak, reorient antenna to receive stronger station. • Check for sources of possible interference. 	15 14 35
Poor color or no color.	<ul style="list-style-type: none"> • Station or Cable TV experiencing problems, tune to another station. • Make sure channels are set into memory. • Check picture control adjustments. • Check antenna or Cable TV connections, reorient antenna. • Check for sources of possible interference. 	15 18 17 14 35
Picture wobbles or drifts.	<ul style="list-style-type: none"> • Station or Cable TV experiencing problems, tune to another station. • Make sure channels are set into memory. • Cable TV company is scrambling signal. • Check antenna orientation. 	15 18 – 14
No Cable TV reception.	<ul style="list-style-type: none"> • Check all Cable TV connections. • Set Signal Type option to the "Cable" mode. • Station or Cable TV system problems, try another station. 	14 18 15
Horizontal or diagonal bars on screen.	<ul style="list-style-type: none"> • Check antenna connections, reorient antenna. • Check for sources of possible interference. 	14 35
No reception above channel 13.	<ul style="list-style-type: none"> • Make sure Signal Type option is in the appropriate mode. • If using antenna, check UHF antenna connections. 	18 14
TV shuts off.	<ul style="list-style-type: none"> • No broadcast on station tuned. • Sleep Timer is set. • Power interrupted. 	15 16 –
Closed Caption is not activated.	<ul style="list-style-type: none"> • TV station experiencing problems or program tuned is not closed captioned. Try another channel. • Check Cable TV connection or VHF/UHF antenna, reposition or rotate antenna. • Set Closed Caption in the menu. 	15 14 21
Display is not shown in your language.	<ul style="list-style-type: none"> • Select proper language in the menu options. 	17
REMOTE CONTROL		
The remote control does not function.	<ul style="list-style-type: none"> • Aim at the remote control at the remote sensor. • Operate within Approx. 15 feet or reduce the light in the room. • Clear the path of the beam. • The batteries are weak. Replace the batteries. • Check the batteries are inserted correctly. 	13

- The LCD panel is a very high technology product, giving you fine picture details. Occasionally, a few non-active pixels may appear on the screen as a fixed point of blue, green or red. Please note that this does not affect the performance of your product.

SYMPTOMS	POSSIBLE SOLUTIONS	PAGE
DVD		
Playback doesn't start or disc ejects automatically.	<ul style="list-style-type: none"> • No disc is inserted. • The disc may be dirty. Clean up the disc. • The disc is scratched or warped. • The unit cannot play CD-ROMs, etc. 	<p>23 9 9 9</p>
No picture.	<ul style="list-style-type: none"> • TV/DVD selector is not set correctly. 	23
No sound.	<ul style="list-style-type: none"> • Check the input selector of the amplifier is set properly. • The unit is in the Special playback mode. • Select the correct Audio Output position on AV amplifier. 	<p>– 24 33</p>
Picture is distorted during CUE or REVIEW.	<ul style="list-style-type: none"> • The picture will be distorted occasionally. 	–
Stopping playback, search, slow-motion play, repeat play, or program play, etc. cannot be performed.	<ul style="list-style-type: none"> • Some discs may not allow some functions. 	–
No surround sound.	<ul style="list-style-type: none"> • The setup does not match your stereo system. 	33
The unit or remote operation key is not functioning.	<ul style="list-style-type: none"> • Turn off the unit and unplug the AC power cord for several minutes, then replug it. 	13
Playback does not start when the title is selected.	<ul style="list-style-type: none"> • Check the Parental setup. 	30
Audio soundtrack and/or subtitle language is not changed when you play back a DVD.	<ul style="list-style-type: none"> • Multilingual language is not recorded on the DVD disc. 	25
No subtitle.	<ul style="list-style-type: none"> • Some discs have no subtitles. • Subtitles are cleared. Press SUBTITLE. 	25
Angle cannot be changed.	<ul style="list-style-type: none"> • Multi-angles are not recorded on the DVD disc. 	25
"This operation can't be performed" appears on the screen.	<ul style="list-style-type: none"> • The function is prohibited with the unit or the disc. 	23

Specifications

GENERAL

Power supply: AC 120V 60Hz
Power consumption: Operation: 108W
Stand by: 0.3W
Weight: 8.9 kg (19.6 lbs)
Dimensions: Width: 760 mm (29-15/16 inches)
Height: 554.5 mm (21-13/16 inches)
Depth: 213.3 mm (8-3/8 inches)
Operating temperature: 5°C - 40°C
Operating humidity: Less than 80%

TELEVISION

Type: 80.04 cm (32" class/31.51" diagonal)
Display method: Transmission TFT color LCD panel
Number of Pixels: 1366 (H) x 768 (V)
Tuner type: US system M
ATSC standard (8VSB), QAM
Receiving channels: VHF 2-13
UHF 14-69
CATV 14-36 (A)-(W)
37-59 (AA)-(WW)
60-85 (AAA)-(ZZZ)
86-94 (86)-(94)
95-99 (A-5)-(A-1)
100-135 (100)-(135)
01 (4A)
Inputs: Video: (RCA) 1 V (p-p), 75 ohms
Audio: (RCA) -8 dBm/50k ohms
Component video: (Y) 1 V (p-p), 75 ohms
(Pb)/(Pr) 0.7 V (p-p), 75 ohms
HDMI: HDMI compliant (type A connector)
HDCP compliant
E-EDID compliant
Suggested scan rates: 480p, 480i, 720p, 1080i, 1080p
HDMI Audio: 2-channel PCM
32/44.1/48 kHz sampling frequency
16/20/24 bits per sample
PC Monitor: Mini-Dsub 15pin x 1
Antenna: VHF/UHF In 75 ohms coaxial
Outputs: Digital audio out: 0.5 V (p-p), 75 ohms terminated
Audio: 0-600 mV/1k ohm
Speakers: 40.6 mm x 121.9 mm (1-5/8 inches x 4-13/16 inches), 8 ohms x 2
Audio output power: 5.0W + 5.0W

DVD/CD player

Signal system: NTSC
Applicable disc: 1.DVD (12 cm)
2.CD (12 cm)
Pickup: CD: Wavelength: 790 nm
Maximum output power: 7 mW
DVD: Wavelength: 655 nm
Maximum output power: 5 mW

ACCESSORIES

Remote control
Batteries (AA) x 2
AC Cord
Stand
Screws x 5
Frame Stand

Designs and specifications are subject to change without notice.



FOR CUSTOMER SERVICE, ADDITIONAL SET-UP AND OPERATING ASSISTANCE, OR TO ORDER ACCESSORIES PLEASE CALL:

1-800-289-0980

WHEN CALLING CUSTOMER SERVICE – PLEASE HAVE YOUR MODEL NUMBER READY

OR WRITE TO:
ORION SALES, INC.
3471 N. UNION DR.
OLNEY, ILLINOIS 62450

FOR INFORMATION ON OUR OTHER PRODUCTS, OR TO ORDER ACCESSORIES ONLINE, PLEASE VISIT OUR WEBSITE AT
www.orionsalesinc.com

SANSUI® *limited* **WARRANTY**

32" CLASS WIDE LCD TV WITH DVD PLAYER

ORION warrants this product to be free from manufacturing defects in material and workmanship under normal use and conditions for a period of 1 year from date of original purchase in the United States.

Should service be necessary under this warranty for any reason due to a manufacturing defect or malfunction during the first 12 months from date of original purchase, ORION will provide carry-in service only by an ORION authorized Independent Service Center at no charge. Also, if an original part fails due to manufacturing defect in material and workmanship within one year from date of original purchase we will replace the defective part, provided the defect or malfunction is verified along with dated proof of purchase.

There are ORION authorized Independent Service Centers located throughout the country. For the one nearest you, DIAL TOLL FREE: 1-800-289-0980 or visit our website at www.orionsalesinc.com. ORION will not be liable for damages incurred in shipment of the unit. If there are no ORION authorized Independent Service Centers in your area please call - 1-888-296-7466 for assistance.

Note: This warranty is void if the product is:

- (a) Damaged through negligence, misuse, abuse, or accident.
- (b) Used in a commercial application or rentals.
- (c) Modified or repaired by anyone other than an Independent Service Center authorized by ORION to effect warranty repairs to the class of product or by the ORION Factory Service Center.
- (d) Damaged because it is improperly connected to the equipment of other manufacturers.

This warranty does not cover:

- (a) Damage to video disc.
- (b) Damage to equipment not properly connected to the product.
- (c) Costs incurred in the shipping of the product to an ORION authorized Independent Service Center or ORION Factory Service Center.
- (d) Damage or improper operation of unit caused by customer abuse, misuse, negligence, or failure to follow operating instructions provided with the product.
- (e) Ordinary adjustments to the product which can be performed by customer as outlined in the owner's manual.
- (f) Signal reception problems caused by external antenna or cable systems.

THIS WARRANTY IS NON TRANSFERABLE AND APPLIES ONLY TO THE ORIGINAL PURCHASER AND DOES NOT EXTEND TO SUBSEQUENT OWNERS OF THE PRODUCT. ANY APPLICABLE IMPLIED WARRANTIES, INCLUDING THE WARRANTY OF MERCHANTABILITY, ARE LIMITED IN DURATION TO A PERIOD OF THE EXPRESS WARRANTY AS PROVIDED HEREIN BEGINNING WITH THE DATE OF ORIGINAL PURCHASE AT RETAIL AND NO WARRANTIES, WHETHER EXPRESS OR IMPLIED SHALL APPLY TO THIS PRODUCT THEREAFTER. ORION MAKES NO WARRANTY AS TO THE FITNESS OF THE PRODUCT FOR ANY PARTICULAR PURPOSE AND USE.

UNDER NO CIRCUMSTANCES SHALL ORION BE LIABLE FOR ANY LOSS, DIRECT, INDIRECT, INCIDENTAL, SPECIAL, OR CONSEQUENTIAL DAMAGE ARISING OUT OF OR IN CONNECTION WITH THE USE OF THIS PRODUCT.

THIS WARRANTY IS VALID ONLY IN THE UNITED STATES OF AMERICA. THIS WARRANTY GIVES YOU SPECIFIC LEGAL RIGHTS, HOWEVER, YOU MAY HAVE OTHER RIGHTS WHICH MAY VARY FROM STATE TO STATE. SOME STATES DO NOT ALLOW LIMITATION ON IMPLIED WARRANTIES OR EXCLUSION OF CONSEQUENTIAL DAMAGE, THEREFORE THESE RESTRICTIONS MAY NOT APPLY TO YOU.

ORION SALES, INC.
3471 N. UNION DR.
OLNEY, ILLINOIS 62450