



Contact SAMSUNG WORLDWIDE

If you have any questions or comments relating to Samsung products, please contact the SAMSUNG customer care center.

Country	Customer Care Center ☎	Web Site	Address
CANADA	1-800-SAMSUNG (726-7864)	www.samsung.com	Samsung Electronics Canada Inc., Customer Service 55 Standish Court Mississauga, Ontario L5R 4B2 Canada
U.S.A	1-800-SAMSUNG (726-7864)	www.samsung.com	Samsung Electronics America, Inc. 85 Challenger Road Ridgefield Park, NJ 07660

SERIES **5+**
530

Plasma TV user manual

imagine the possibilities

Thank you for purchasing this Samsung product.
To receive more complete service, please register
your product at

www.samsung.com/register

Model _____ Serial No. _____

 If you have any questions, please call us at 1-800-SAMSUNG (1-800-726-7864) for assistance.



Figures and illustrations in this User Manual are provided for reference only and may differ from actual product appearance. Product design and specifications may be changed without notice.

Important Warranty Information Regarding Television Format Viewing

See the warranty card for more information on warranty terms.

Wide screen format PDP Displays (16:9, the aspect ratio of the screen width to height) are primarily designed to view wide screen format full-motion video. The images displayed on them should primarily be in the wide screen 16:9 ratio format, or expanded to fill the screen if your model offers this feature and the images are constantly moving. Displaying stationary graphics and images on screen, such as the dark sidebars on no expanded standard format television video and programming, should be limited to no more than 5% of the total television viewing per week.

Additionally, viewing other stationary images and text such as stock market reports, video game displays, station logos, web sites or computer graphics and patterns, should be limited as described above for all televisions. Displaying stationary images that exceed the above guidelines can cause uneven aging of PDP Displays that leave subtle, but permanent burned-in ghost images in the PDP picture. To avoid this, vary the programming and images, and primarily display full screen moving images, not stationary patterns or dark bars.

On PDP models that offer picture sizing features, use these controls to view different formats as a full screen picture.

Be careful in the selection and duration of television formats used for viewing. Uneven PDP aging as a result of format selection and use, as well as burned-in images, are not covered by your Samsung limited warranty.

- **SAMSUNG ELECTRONICS NORTH AMERICAN LIMITED WARRANTY STATEMENT**

Subject to the requirements, conditions, exclusions and limitations of the original Limited Warranty supplied with Samsung Electronics (SAMSUNG) products, and the requirements, conditions, exclusions and limitations contained herein, SAMSUNG will additionally provide Warranty Repair Service in the United States on SAMSUNG products purchased in Canada, and in Canada on SAMSUNG products purchased in the United States, for the warranty period originally specified, and to the Original Purchaser only.

The above described warranty repairs must be performed by a SAMSUNG Authorized Service Center. Along with this Statement, the Original Limited Warranty Statement and a dated Bill of Sale as Proof of Purchase must be presented to the Service Center. Transportation to and from the Service Center is the responsibility of the purchaser. Conditions covered are limited only to manufacturing defects in material or workmanship, and only those encountered in normal use of the product.

Excluded, but not limited to, are any originally specified provisions for, in-home or on-site services, minimum or maximum repair times, exchanges or replacements, accessories, options, upgrades, or consumables.

For the location of a SAMSUNG Authorized Service Center, please call toll-free:

- In the United States : 1-800-SAMSUNG (1-800-726-7864)

- In Canada : 1-800-SAMSUNG

User Instructions

- **Screen Image retention**

Do not display a still image (such as on a video game) on the plasma display panel for more than several minutes as it can cause screen image retention. This image retention is also known as 'screen burn'. To avoid such image retention, refer to page 14 of this manual to reduce the degree of brightness and contrast of the screen when displaying a still image.

- **Heat on the top of the Plasma TV**

The top side of the product may be hot after long periods of use as heat dissipates from the panel through the vent hole in the upper part of the product.

This is normal and does not indicate any defect or operation failure of the product.

However, children should be prevented from touching the upper part of the product.

- **The product is making a 'cracking' noise.**

A 'cracking' noise may occur when the product contracts or expands due to a change in the surrounding environment such as temperature or humidity. This is normal and not a defect of the unit.

- **Cell Defects**

The PDP uses a panel consisting of 2,360,000(HD-level) to 6,221,000(FHD-level) pixels which require sophisticated technology to produce. However, there may be a few bright or dark pixels on the screen. These pixels will have no impact on the performance of the product.

- **Avoid operating the TV at temperatures below 41°F (5°C)**

- **A still image displayed too long may cause permanent damage to the PDP Panel.**

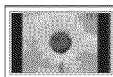

Watching the Plasma TV in 4:3 format for a long period of time may leave traces of borders displayed on the left, right and center of the screen caused by the difference of light emission on the screen. Playing a DVD or a game console may cause similar effects to the screen.

Damages caused by the above effect are not covered by the Warranty.

- **After-images on the Screen.**

Displaying still images from Video games and PC for longer than a certain period of time may produce partial after-images.

To prevent this effect, reduce the 'brightness' and 'contrast' when displaying still images for a long time.

- **Warranty**

Warranty does not cover any damage caused by image retention.

Burn-in is not covered by the warranty.

- **Caution**



The glass screen of your PDP TV can break if you accidentally drop the TV. Handle the TV with care.

When moving the TV, always have two or more people pick it up and carry it as a safety precaution. Do not lay the TV flat on its face or back.

(Your) Samsung Plasma TV is a high quality television that has been carefully packaged to protect the integrity of its glass panel and component parts during shipment. It is, nonetheless, a fragile piece of electronics that requires careful handling. Refrain from putting undue stress on any part of the packaging when shipping or unpacking the TV. Use care when installing the TV. Avoid placing the TV in a location where it may be struck, exposed to sharp impacts, or fall. Panel breakage caused by a fall or impact strike is not covered under the manufacturer's warranty.

Contents

Getting Started

- List of Features 4
- Accessories 4
- Install the Stand 5
- Viewing the Control Panel 7
- Viewing the Remote Control 8
- Connecting to an Antenna 9
- Plug & Play (Initial Setup)..... 9

Connections

- Connecting to an AV Device..... 10
- Connecting to an Audio Device 11
- Connecting to a PC 11
- Changing the Input Source 12

Basic Features

- How to Navigate Menus..... 13
- Channel Menu 13
 - Seeing Channels 13
 - Using Favorite Channels 14
 - Memorizing Channels 14
 - Editing Channels 14
 - Other Features 14
- Picture Menu 15
 - Changing the Preset Picture Mode 15
 - Adjusting Picture Settings 15
 - Changing the Picture Options 16
- Sound Menu 17
 - Changing the Preset Sound Mode 17
 - Adjusting Sound Settings 18
 - Sound Settings 18
- Setup Menu 18
 - Setting the Time 18
 - Using the Sleep Timer 19
 - Setting the On/Off Timer 19
 - Locking Programs 19
 - Other Features 21
 - Economical Solutions 22
- Support Menu..... 22

Advanced Features

- Media Play 23
 - Connecting a USB Device 23
 - Using the Media Play Menu 23

Other Information

- Installing the Wall Mount 27
- Anti-Theft Kensington Lock..... 27
- Securing the Installation Space 28
- Securing the TV to the Wall 29
- Troubleshooting 30
 - Storage and Maintenance 32
- License 33
- Specifications 33
- Dimensions 34
- Index 35

Check the Symbol!



This function can be used by pressing the TOOLS button on the remote control.



Note

Indicates additional information.



Step by Step Guide

Check here for instructions on how to open the relevant submenu within the OSD (on screen display).

Getting Started

List of Features

- Excellent Digital Interface & Networking: With a built-in HD digital tuner, nonsubscription HD broadcasts can be viewed without a cable box / STB (Set-Top-Box) satellite receiver.
- **Media Play:** Allows you to play music files, pictures saved on a USB device (p. 23).
- **Self Diagnosis:** You can check to make sure picture and sound operate normally (p. 22).

Accessories

- ✎ Please make sure the following items are included with your PDP TV. If any items are missing, contact your dealer.
- ✎ The items' colors and shapes may vary depending on the models.
- ✎ Check that there are no accessories hidden behind or under packing materials when you open the box.

- Remote Control (BN59-01006A) & Batteries (AAA x 2)
- Owner's Instructions
- Warranty Card / Safety Guide / Quick Setup Guide
- Cleaning Cloth (BN63-01798B)
- Power Cord



Ferrite Core (1EA) (3301-002049)

- ✎ Ferrite Core for Power Cord: The ferrite cores are used to shield the cables from interference. When connecting the ferrite core to a cable, open the ferrite core and clip it around the cable near the plug as shown in the figure.

- **A** Maximum distance between the ferrite core and the end of the cord inserted in the TV: 6~8 inches

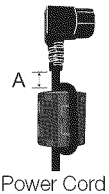

Power Cord

Input Cables (Sold Separately)

To purchase the below cable, contact www.SamsungParts.com



HDMI



HDMI-DVI



Component



Composite (AV)

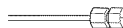

Coaxial (RF)

- ✎ Check the cable before plug-in

	Cable	Ports
HDMI		
USB		
Optical		



Warning

Do not plug cable upside down.
Be sure to check before plug-in.

Install the Stand

See the separate stand installation guide for more detailed instructions.

51 inches model only (PN51D530)

A 1 EA

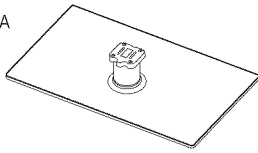

B 1 EA

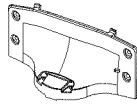

C  x4 (M4 X L12)

D  x4 (M4 X L8)

Stand

Guide Stand

Screws

1

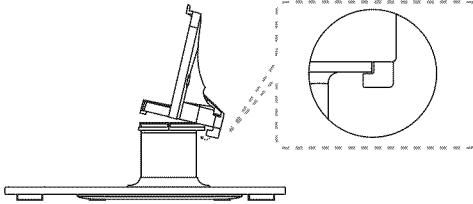

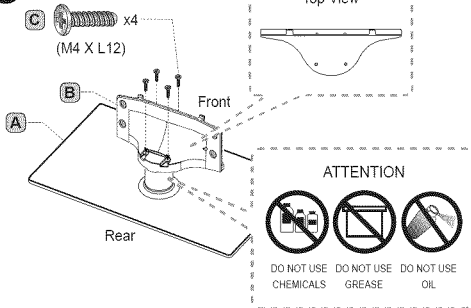

2

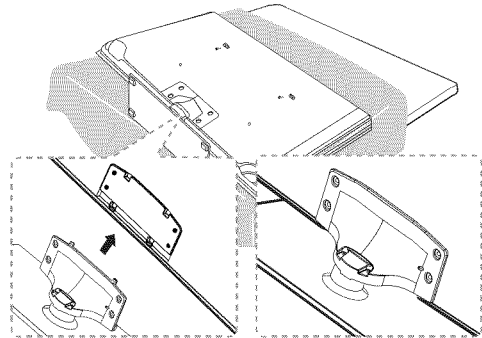

3



 Place a soft cloth over the table to protect the TV, and then place the TV on the cloth screen side down.

 Insert the Stand Guide into the slot of TV bottom side.

4 Side View

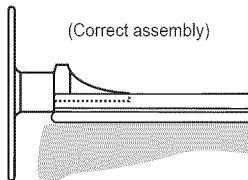

(Incorrect assembly)

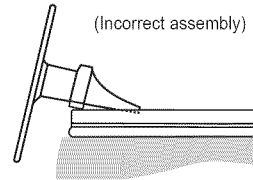

5

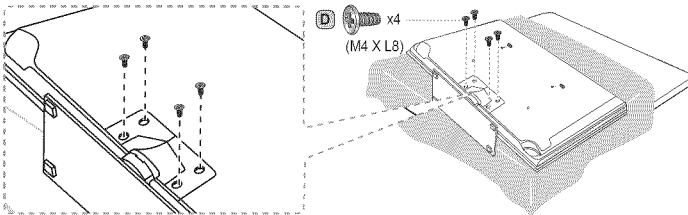

Getting Started

59 inches model only (PN59D530)

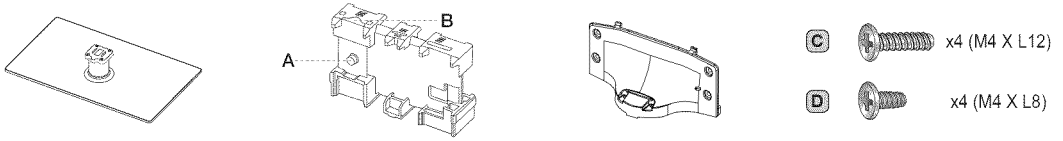

Stand (depending on the model)

Guide Stand

Screws

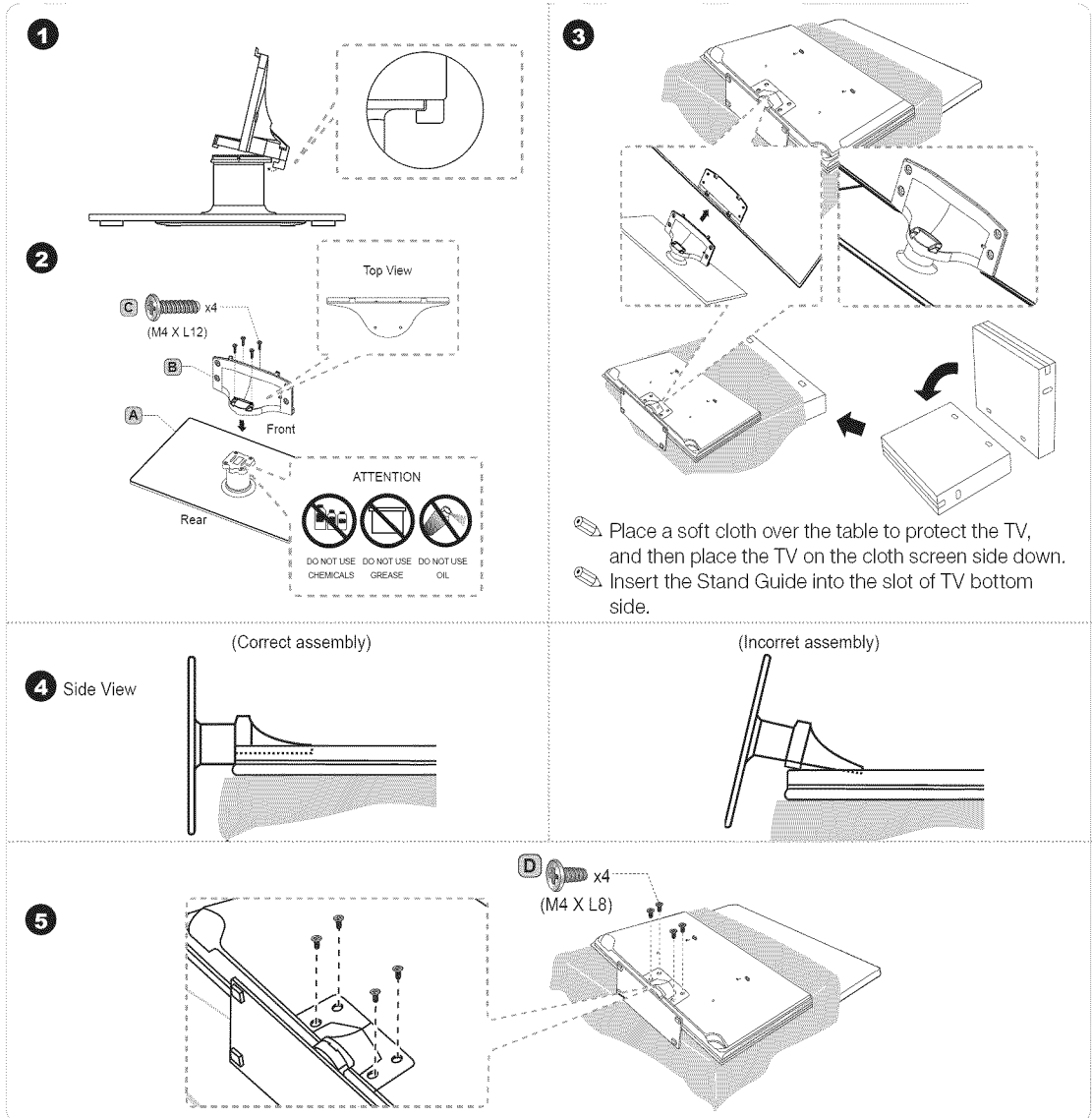

- 🔧 Place a soft cloth over the table to protect the TV, and then place the TV on the cloth screen side down.
- 🔧 Insert the Stand Guide into the slot of TV bottom side.

(Correct assembly)

(Incorrect assembly)

NOTE







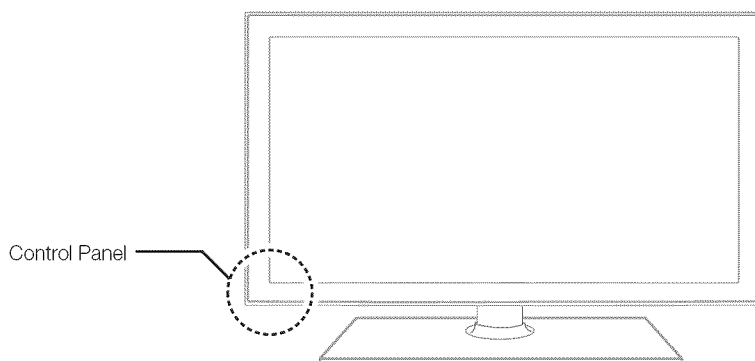

- Make sure to distinguish between the front and back of the Stand and Guide Stand when assembling them.
- Make sure that at least two people lift and move the TV.
- Stand the product up when you fasten the screws. If you fasten the screws with the TV lying down, it may lean to one side when you stand it up.

⚠️ Do not insert your fingers into the stand base slot of the TV when installing the stand base.

Viewing the Control Panel

 The product color and shape may vary depending on the model.



	Power Indicator	Blinks and turns off when the power is on and lights up in standby mode.
	⏻ (Power)	Turns the TV on or off.
	SOURCE 	Toggles between all the available input sources. In the on-screen menu, use this button as you would use the ENTER  button on the remote control.
	MENU	Displays an on-screen menu, the OSD (on screen display) of your TV's features.
	– VOL +	Adjusts the volume. In the OSD, use the – VOL + buttons as you would use the ◀ and ▶ buttons on the remote control.
	▼ CH ▲	Changes the channels. In the OSD, use the ▼ CH ▲ buttons as you would use the ▼ and ▲ buttons on the remote control.

Standby mode

Do not leave your TV in standby mode for long periods of time (when you are away on a holiday, for example). A small amount of electric power is still consumed even when the power button is turned off. It is best to unplug the power cord.

Getting Started

Viewing the Remote Control

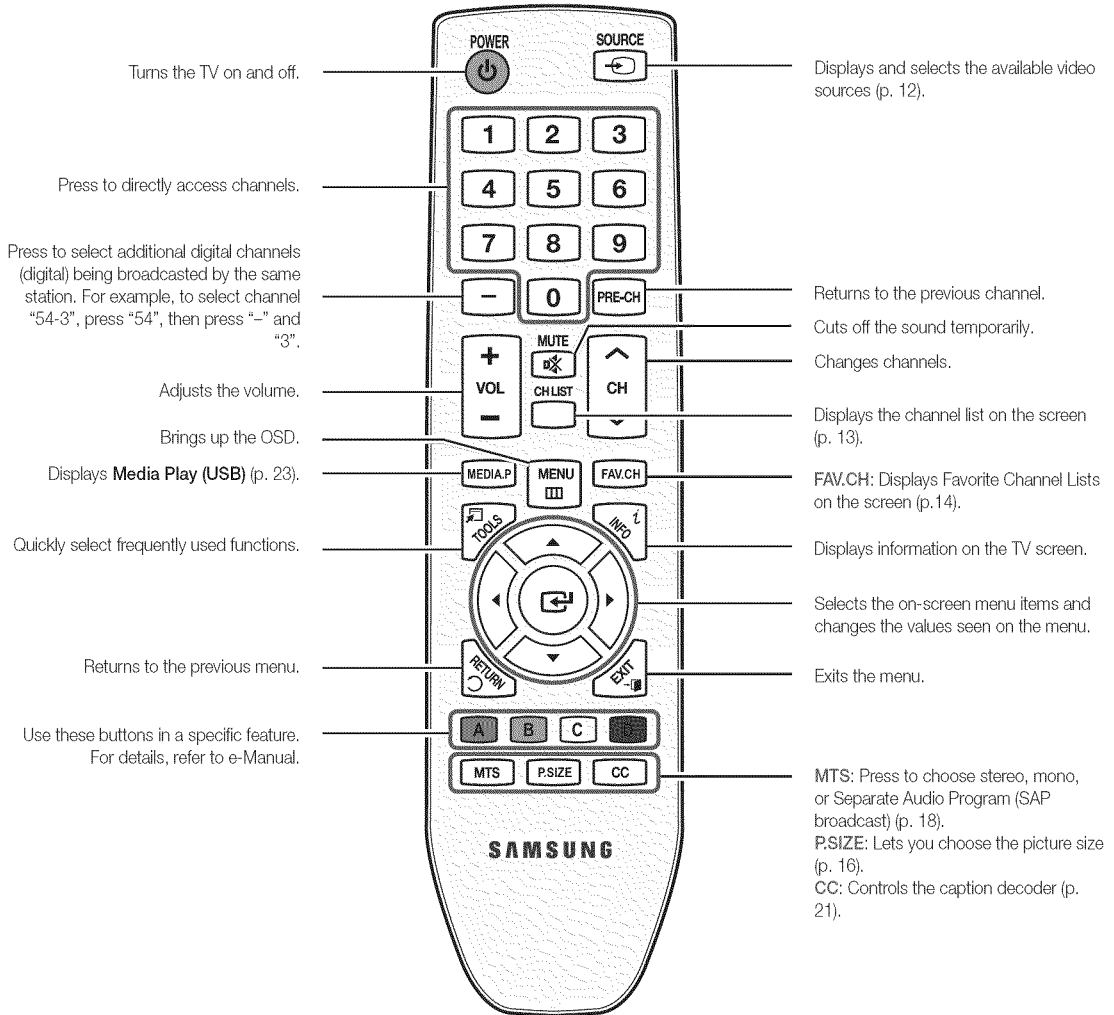

Installing batteries (Battery size: AAA)

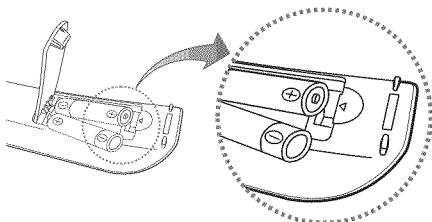

NOTE

- Use the remote control within 23 feet from the TV.
- Bright light may affect the performance of the remote control. Avoid use when nearby fluorescent lights or neon signs.
- The color and shape may vary depending on the model.

Connecting to an Antenna

Connecting the Power cord and an antenna or cable connection

- The PDP device may interfere with an amateur radio or AM radio.
- Using two-way radio mobile and portable units or amateur radio or AM radio near your TV may cause the TV to malfunction.
- When you move or swivel the TV with Antenna cable tightly connected, there is high risk antenna jack on TV will be broken off.

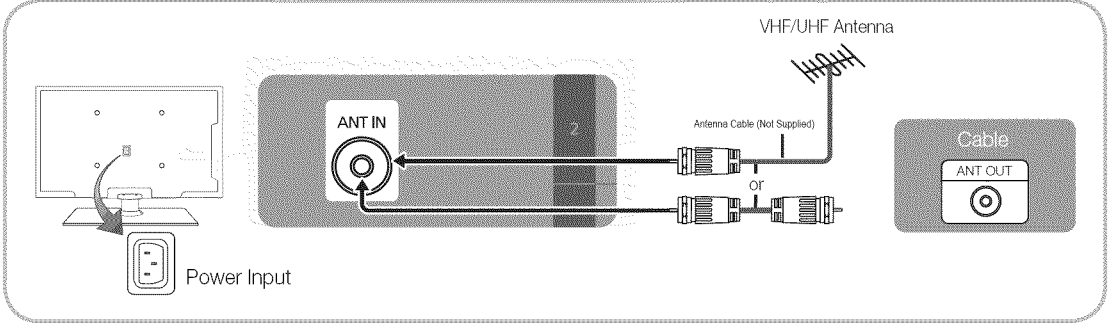

Plug & Play (Initial Setup)

When the TV is initially powered on, a sequence of on-screen prompts will assist in configuring basic settings. Press the **POWER** button. **Plug & Play** is available only when the **Input** source is set to TV.

To return to the previous step, press the Red button.

- | | | | |
|----------|--|---|--|
| 1 | Selecting a language | Press the ▲ or ▼ button, then press the ENTER button. Select the desired OSD (On Screen Display) language. | |
| 2 | Selecting Store Demo or Home Use | Press the ◀ or ▶ button, then press the ENTER button. <ul style="list-style-type: none"> • Select the Home Use mode. Store Demo mode is for retail environments. • To return the unit's settings from Store Demo to Home Use (standard): Press the volume button on the TV. When you see the volume OSD, press and hold MENU for 5 sec. | |
| 3 | Selecting an antenna | Press the ▲ or ▼ button, then press the ENTER button. Select Air , Cable or Auto . | |
| 4 | Selecting a channel | Press the ▲ or ▼ button, then press the ENTER button. Select the channel source to memorize. When setting the antenna source to Cable , a step appears allowing you to assign numerical values (channel frequencies) to the channels. For more information, refer to Channel → Auto Program (p. 14). <p> Press the ENTER button at any time to interrupt the memorization process. Set the Clock Mode automatically or manually.</p> <ul style="list-style-type: none"> • Auto: Allows you to select DST (Daylight Saving Time) mode and time zone. • Manual: Allows you to manually set the current date and time (p. 19). | |
| 5 | Setting the Clock Mode | Set the Clock Mode automatically or manually. | |
| 6 | View the HD Connection Guide . | The connection method for the best HD screen quality is displayed. | |
| 7 | Enjoy your TV. | Press the ENTER button. | |

If You Want to Rerun Plug & Play...

MENU → **Setup** → **Plug & Play** → **ENTER**

NOTE

- To change the TV's setting from **Store Demo** to **Home Use** when not in **Plug & Play**, press the volume button on the TV. When you see the volume bar on the screen, press and hold the **MENU** button on the TV for 5 sec.

Connections

Connecting to an AV Device

Using an HDMI or an HDMI to DVI cable: HD connection (up to 1080p)

We recommend using the HDMI connection for the best quality HD picture.

Available devices: DVD, Blu-ray player, HD cable box, HD STB (Set-Top-Box) satellite receiver

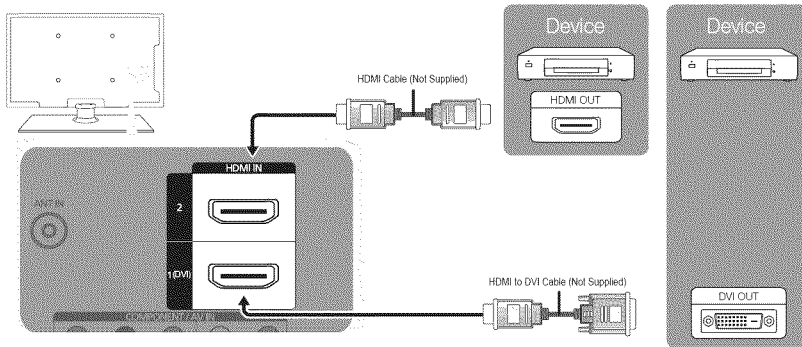

HDMI IN 1(DVI), 2

- When using an HDMI/HDMI cable connection, the picture may not display normally (if at all) or the audio may not work if an external device that uses an older version of HDMI mode is connected to the TV. If such a problem occurs, ask the manufacturer of the external device about the HDMI version and, if out of date, request an upgrade.
- Be sure to purchase a certified HDMI cable. Otherwise, the picture may not display or a connection error may occur.
- When using an HDMI/DVI cable connection, you must use the **HDMI IN 1(DVI)** jack for video. A DVD, Blu-ray player, HD cable box, HD STB satellite receiver may require a DVI-HDMI (DVI to HDMI) cable or DVI-HDMI (DVI to HDMI) adapter.
- If an HDMI to DVI cable is connected to the **HDMI IN 1(DVI)** port, the audio does not work.

Using a Component (up to 1080p) or an Audio/Video (480i only) Cable

Available devices: DVD, Blu-ray player, cable box, STB satellite receiver, VCR

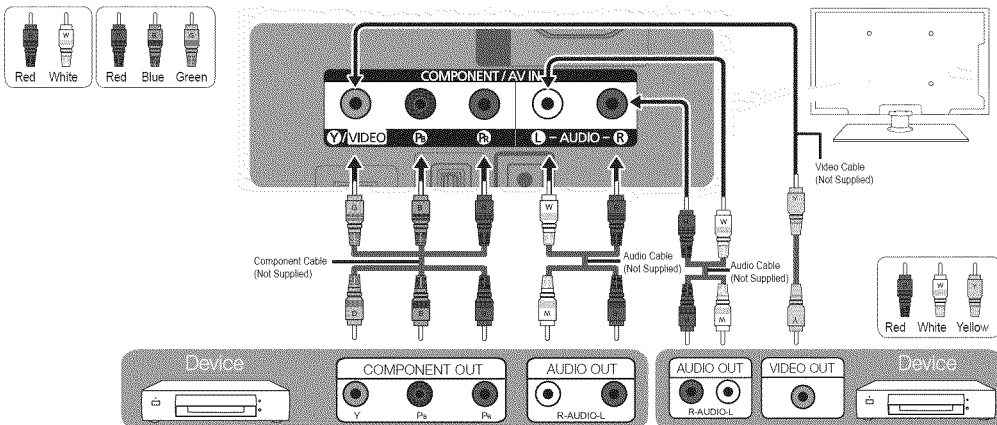

When connecting to AV IN, the color of the AV IN [Y/VIDEO] jack (green) will not match the video cable (yellow).

For better picture quality, the Component connection is recommended over the A/V connection.

Connecting to an Audio Device

Using a Optical (Digital) Cable Connection

Available devices: Digital Audio System, Amplifier, DVD home theater

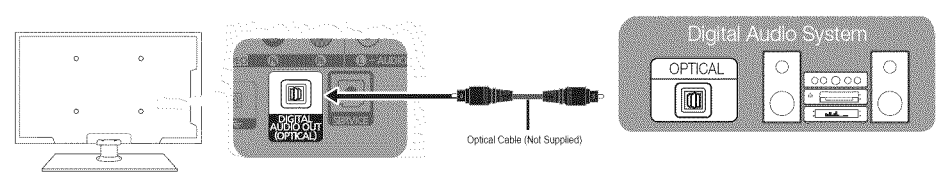

DIGITAL AUDIO OUT (OPTICAL)

- When a Digital Audio System is connected to the **DIGITAL AUDIO OUT (OPTICAL)** jack, decrease the volume of both the TV and the system.
- 5.1 CH (channel) audio is available when the TV is connected to an external device supporting 5.1 CH.
- When the receiver (home theater) is set to on, you can hear sound output from the TV's optical jack. When the TV is receiving a DTV signal, the TV will send 5.1 CH sound to the amplifier or DVD home theater. When the source is a digital component such as a DVD / Blu-ray player / cable box / STB (Set-Top-Box) satellite receiver and is connected to the TV via HDMI, only 2 CH audio will be heard from the amplifier or DVD home theater. If you want to hear 5.1 CH audio, connect the digital audio out jack from your DVD / Blu-ray player / cable box / STB satellite receiver directly to an amplifier or home theater.

Using a SERVICE Cable Connection



SERVICE: Connector for service only.

Connecting to a PC

Using an HDMI/DVI cable

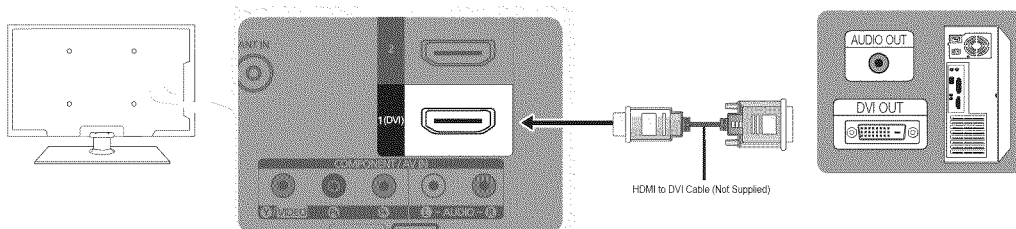

HDMI to DVI Cable (Not Supplied)

When connecting a HDMI to DVI cable, the Audio cable could not connect.

Connections

Display Modes (HDMI/DVI Input)

Optimal resolution (1920 X 1080 @ 60Hz)

Mode	Resolution	Horizontal Frequency (KHz)	Vertical Frequency (Hz)	Pixel Clock Frequency (MHz)	Sync Polarity (H / V)
IBM	640 x 350	31.469	70.086	25.175	+/-
	720 x 400	31.469	70.087	28.322	-/+
MAC	640 x 480	35.000	66.667	30.240	-/-
	832 x 624	49.726	74.551	57.284	-/-
	1152 x 870	68.681	75.062	100.000	-/-
VESA DMT	640 x 480	31.469	59.940	25.175	-/-
	640 x 480	37.861	72.809	31.500	-/-
	640 x 480	37.500	75.000	31.500	-/-
	800 x 600	37.879	60.317	40.000	+/+
	800 x 600	48.077	72.188	50.000	+/+
	800 x 600	46.875	75.000	49.500	+/+
	1024 x 768	48.363	60.004	65.000	-/-
	1024 x 768	56.476	70.069	75.000	-/-
	1024 x 768	60.023	75.029	78.750	+/+
	1152 x 864	67.500	75.000	108.000	+/+
	1280 x 1024	63.981	60.020	108.000	+/+
	1280 x 1024	79.976	75.025	135.000	+/+
	1280 x 800	49.702	59.810	83.500	-/+
	1280 x 800	62.795	74.934	106.500	-/+
	1280 x 960	60.000	60.000	108.000	+/+
	1360 x 768	47.712	60.015	85.500	+/+
	1440 x 900	55.935	59.887	106.500	-/+
1440 x 900	70.635	74.984	136.750	-/+	
1680 x 1050	65.290	59.954	146.250	-/+	
VESA DMT / DTV CEA	1920 x 1080p	67.500	60.000	148.500	+/+



NOTE

- For HDMI/DVI cable connection, you must use the **HDMI IN 1(DVI)** jack.
- The interlace mode is not supported.
- The set may operate abnormally if a non-standard video format is selected.
- PC(D-Sub) input is not supported.
- If a HDMI to DVI cable is connected to the **HDMI IN 1(DVI)** port, the audio does not work.

Changing the Input Source

Source List



Use to select TV or an external input sources such as a DVD / Blu-ray player / cable box / STB satellite receiver.

 MENU  → Input → Source List → **SOURCE**
ENTER 

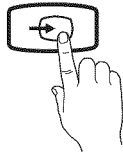

 You can use the **Edit name** and **Information** when you press the **TOOLS** button in the **Source list**.



■ TV / AV / Component / HDMI1/DVI / HDMI2

-  You can only choose external devices that are connected to the TV. In the **Source List**, connected inputs will be highlighted.
-  PC(D-Sub) input is not supported. If you want connect PC to the TV, use HDMI1/DVI input.

Edit Name

 MENU  → Input → Edit Name → ENTER 

- **VCR / DVD / Cable STB / Satellite STB / PVR STB / AV Receiver / Game / Camcorder / PC / DVI PC / DVI / TV / IPTV / Blu-ray / HD DVD / DMA:** Name the device connected to the input jacks to make your input source selection easier.

 When connecting a HDMI/DVI cable to the **HDMI IN 1(DVI)** port, you should set the TV to **DVI PC** or **DVI** mode under **Edit Name**.

Basic Features

How to Navigate Menus

Before using the TV, follow the steps below to learn how to navigate the menu and select and adjust different functions.

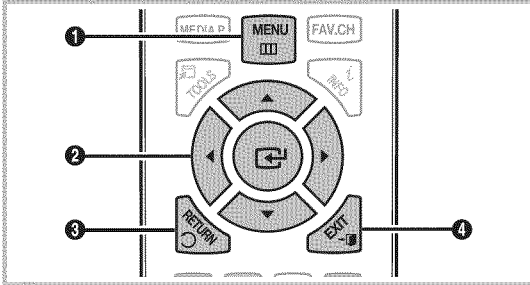

- 1 MENU button: Displays the main on-screen menu.
- 2 ENTER / Direction button: Move the cursor and select an item. Confirm the setting.
- 3 RETURN button: Returns to the previous menu.
- 4 EXIT button: Exits the on-screen menu.

How to Operate the OSD (On Screen Display)

The access step may differ depending on the selected menu.

- 1 MENU button: The main menu options appear on the screen:
Picture, Sound, Channel, Setup, Input, Application, Support.
- 2 Up / Down button: Select an icon with the Up or Down button.
- 3 ENTER button: Press ENTER to access the sub-menu.
- 4 Up / Down button: Select the desired submenu with the Up or Down button.
- 5 Left / Right button: Adjust the value of an item with the Left or Right button. The adjustment in the OSD may differ depending on the selected menu.
- 6 ENTER button: Press ENTER to confirm the selection.
- 7 EXIT button: Press EXIT.

Channel Menu

Seeing Channels

Channel List

Add, delete or set Favorite channels and use the program guide for digital broadcasts.

MENU → Channel → Channel List → ENTER



Select a channel in the **All Channels, Added Channels, Favorite or Programmed** screen by pressing the Up / Down and ENTER buttons. Then you can watch the selected channel.

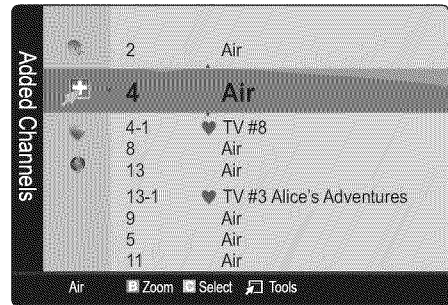

- All Channels: Shows all currently available channels.
- Added Channels: Shows all added channels.
- Favorite: Shows all favorite channels.
- Programmed: Shows all currently reserved programs.

Using the color buttons with the **Channel List**

- Green (Zoom): Enlarges or shrinks a channel number.
- Yellow (Select): Selects multiple channel lists. Select desired channels and press the Yellow button to set all the selected channels at the same time. The ✓ mark appears to the left of the selected channels.
- Tools: Displays the **Channel List** option menu. (The options menus may differ depending on the situation.)

Basic Features

Channel Status Display Icons

Icons	Operations
✓	A channel selected.
♥	A channel set as a Favorite.
⌚	A reserved Program.

Using Favorite Channels



MENU → Channel → Channel List → ENTER



Add to Favorite / Delete from Favorite



Set channels you watch frequently as Favorites.

1. Select a channel and press the **TOOLS** button.
2. Add or delete a channel using the **Add to Favorite** or **Delete from Favorite** menu respectively.

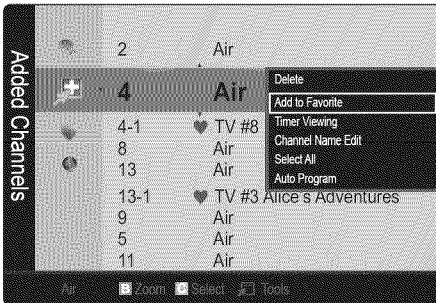

To show all Favorite channels, click on the button shown on the right.

Memorizing Channels



MENU → Channel → ENTER

Antenna (Air / Cable)

Before your television can begin memorizing the available channels, you must specify the type of signal source that is connected to the TV (i.e. an Air or a Cable system).

Auto Program

- **Air**: Air antenna signal.
- **Cable**: Cable antenna signal.
- **Auto**: Air and Cable antenna.



NOTE

- When selecting the Cable TV system: **STD**, **HRC** and **IRC** identify various types of cable TV systems. Contact your local cable company to identify the type of cable system that exists in your particular area. At this point, the signal source has been selected.
- After all the available channels are stored, it starts to remove scrambled channels. The **Auto Program** menu then reappears.

Editing Channels



MENU → Channel → Channel List → ENTER

Channel Name Edit

1. Select a channel and press the **TOOLS** button.
2. Edit the channel name using the **Channel Name Edit** menu.

- **Channel Name Edit** (analog channels only): Assign your own channel name.

Other Features



MENU → Channel → ENTER

Clear Scrambled Channel

This function is used to filter out scrambled channels after Auto Program is completed. This process may take up to 20~30 minutes.

How to Stop Searching Scrambled Channels

1. Press the ENTER button to select **Stop**.
2. Press the ◀ button to select **Yes**.
3. Press the ENTER button.

This function is only available in **Cable** mode.

Channel List



MENU → Channel → Channel List → ENTER

Channel List Option Menu

Set each channel using the Channel List menu options (**Add / Delete**, **Timer Viewing**, **Select All / Deselect All**, **Auto Program**). Option menu items may differ depending on the channel status.

1. Select a channel and press the **TOOLS** button.
2. Select a function and change its settings.

- **Add / Delete:** Delete or add a channel to display the channels you want.

 **NOTE**

- All deleted channels will be shown on the **All Channels** menu.
- A gray-colored channel indicates the channel has been deleted.
- The **Add** menu only appears for deleted channels.
- Delete a channel from the **Added Channels** or **Favorite** menu in the same manner.

- **Timer Viewing:** You can set a desired channel to be displayed automatically at the reserved time. Set the current time first to use this function.

1. Press the ◀ / ▶ / ▲ / ▼ buttons to select the desired channel in **Channel List**.
2. Press the **TOOLS** button, then select **Timer Viewing**.
3. Scroll up or down to adjust the settings in the box, or use the numeric buttons on your remote to enter the date and time.

 If you selected **Once, Everyday, Every Week, Mon~Fri, Mon~Tue, Wed~Thu, or Sat~Sun in Repeat**, you can enter the date you want.

4. Select **OK**, then press the **ENTER**  button when done.

 **NOTE**

- Only memorized channels can be reserved.
- Reserved programs will be displayed in the **Programmed** menu.
- When a digital channel is selected, press the ▶ button to view the digital program.

- **Select All:** Select all the channels in the channel list.

- **Deselect All:** Deselect all the selected channels.

 You can only select **Deselect All** when one or more channels are selected.

- **Auto Program:** Scans for a channel automatically and stores in the TV. (P.14)



Programmed

(in **Channel List**)



You can view, modify or delete a show you have reserved to watch. **Programmed** timer viewing is displayed here. Highlight a program and press the **TOOLS** button to display Options.

- **Change Info:** Change a show you have reserved to watch. Begin with step 3 of "Timer Viewing," above.

- **Cancel Schedules:** Cancel a show you have reserved to watch.

 This deletes the highlighted or selected program(s).

- **Information:** Display a show you have reserved to watch. (You can also change the reservation Information.)

 Alternatively, you can view Information by highlighting a program and pressing the **ENTER**  button

- **Select All / Deselect All:** Select or deselect all reserved programs.

Fine Tune

(analog channels only)

If the reception is clear, you do not have to fine tune the channel, as this is done automatically during the search and store operation. If the signal is weak or distorted, fine tune the channel manually. Scroll to the left or right until the image is clear.



 Settings are applied to the channel you're currently watching.

 Fine tuned channels that have been saved are marked with an asterisk "*" on the right-hand side of the channel number in the channel banner.

 To reset the fine-tuning, select **Reset**.

Picture Menu

Changing the Preset Picture Mode



 **MENU**  **Picture** → **Mode** → **ENTER** 

Mode

Select your preferred picture type.

- **Dynamic:** Suitable for a bright room.
- **Standard:** Suitable for a normal environment.
- **Movie:** Suitable for watching movies in a dark room.

Adjusting Picture Settings

 **MENU**  **Picture** → **ENTER** 

Cell Light / Contrast / Brightness / Sharpness / Color / Tint (G/R)

Your television has several setting options for picture quality control.



Basic Features

NOTE

- When you make changes to **Cell Light**, **Contrast**, **Brightness**, **Sharpness**, **Color** or **Tint (G/R)**, the OSD will be adjusted accordingly.
- Settings can be adjusted and stored for each external device connected to the TV.

Changing the Picture Options

Advanced Settings

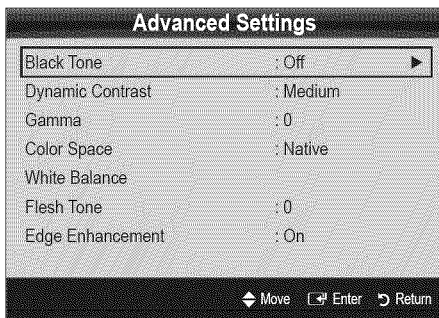

MENU  → Picture → Advanced Settings → ENTER 

(Advanced Settings are available in **Standard** / **Movie** mode)
Compared to previous models, new Samsung TVs have a more precise picture.



- **Black Tone (Off / Dark / Darker / Darkest):** Select the black level to adjust the screen depth.
- **Dynamic Contrast (Off / Low / Medium / High):** Adjust the screen contrast.
- **Gamma:** Adjust the primary color intensity.
- **Color Space (Auto / Native):** Adjust the range of colors available to create the image.
- **White Balance:** Adjust the color temperature for a more natural picture.
R-Offset / G-Offset / B-Offset: Adjust each color's (red, green, blue) darkness.
R-Gain / G-Gain / B-Gain: Adjust each color's (red, green, blue) brightness.
Reset: Resets the **White Balance** to its default settings.
- **Flesh Tone:** Emphasize pink "Flesh Tone."
- **Edge Enhancement (Off / On):** Emphasize object boundaries.

Picture Options

MENU  → Picture → Picture Options → ENTER 

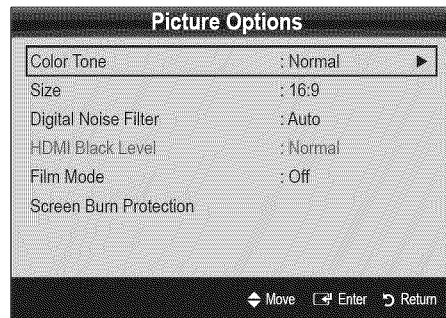

- **Color Tone (Cool / Normal / Warm1 / Warm2)**

 **Warm1** or **Warm2** will be deactivated when the picture mode is **Dynamic** or **Standard**.

 Settings can be adjusted and stored for each external device connected to an input on the TV.

- **Size:** Your cable box/satellite receiver may have its own set of screen sizes as well. However, we highly recommend you use 16:9 mode most of the time.



16:9 : Sets the picture to 16:9 wide mode.

Zoom1: Use for moderate magnification.

Zoom2: Use for a stronger magnification.

Wide Fit: Enlarges the aspect ratio of the picture to fit the entire screen.



 Available with HD 1080i / 720p signals in 16:9 mode.



4:3 : Sets the picture to basic (4:3) mode.

 Do not watch in 4:3 format for a long time. Traces of borders displayed on the left, right and center of the screen may cause image retention (screen burn) which are not covered by the warranty.



Screen Fit: Displays the full image without any cut-off when HDMI (720p / 1080i / 1080p) or Component (1080i / 1080p) signals are inputted.

NOTE

- After selecting **Zoom1**, **Zoom2** or **Wide Fit**:
 1. Press the **▶** button to select **Position**.
 2. Press the **ENTER**  button.
 3. Press the **▲** or **▼** button to move the picture up or down.
 4. Press the **ENTER**  button.
 5. Press the **▶** button to select **Reset**.
 6. Press the **ENTER**  button to reset the picture to its default position.

- After selecting **Screen Fit** in HDMI (1080i/1080p) or Component (1080i/1080p) mode, you may need to center the picture:
 1. Press the ◀ or ▶ button to select **Position**.
 2. Press the ENTER  button.
 3. Press the ▲, ▼, ◀ or ▶ button to move the picture.
 4. Press the ENTER  button.
 5. Press the ◀ or ▶ button to select **Reset**.
 6. Press the ENTER  button.
- HD (High Definition): 16:9 - 1080i/1080p (1920x1080), 720p (1280x720)
- Settings can be adjusted and stored for each external device you have connected to an input on the TV.

Input Source	Picture Size
ATV, AV, Component (480i, 480p)	16:9, Zoom1, Zoom2, 4:3
DTV(1080i), Component (1080i, 1080p), HDMI (720p, 1080i, 1080p)	16:9, 4:3, Wide Fit, Screen Fit

- **Digital Noise Filter (Off / Low / Medium / High / Auto):** If the broadcast signal received by your TV is weak, you can activate the **Digital Noise Filter** feature to reduce any static and ghosting that may appear on the screen.
 -  When the signal is weak, try other options until the best picture is displayed.
- **HDMI Black Level (Normal / Low):** Selects the black level on the screen to adjust the screen depth.
 -  Available only in HDMI mode.
- **Film Mode (Off / Auto):** Sets the TV to automatically sense and process film signals from all sources and adjusts the picture for optimum quality.
 -  Available in TV, AV, COMPONENT (480i / 1080i) and HDMI (480i / 1080i).
- **Screen Burn Protection:** To reduce the possibility of screen burn, this unit is equipped with screen burn prevention technology. The Time setting allows you to program the time between movement of the picture in minutes.

Pixel Shift (Off / On): Using this function, you can minutely move pixels on the PDP in horizontal or vertical direction to minimize after-images on the screen.

 Optimum condition for pixel shift

	Item	TV / AV / Component /HDMI
Horizontal	0~4	4
Vertical	0~4	4
Time (minute)	1~4 min	4 min

 The **Pixel Shift** value may differ depending on the TV size (inches) and mode.

 This function is not available in the **Screen Fit** mode.

Scrolling: This function removes after-images on the screen by moving all the pixels on the PDP according to a pattern. Use this function when there are remaining after-images or symbols on the screen, especially when you displayed a still image on the screen for a long time.

 The after-image removal function has to be executed for a long time (approximately 1 hour) to effectively remove after-images on the screen. If the after-image is not removed after performing the function, repeat the function again.

 Press any key on the remote control to cancel this feature.



Side Gray (Dark / Light): When you watch TV with the screen ratio set to 4:3, the screen is prevented from any damage by adjusting the white balance on both extreme left and right sides.

Picture Reset (Reset Picture Mode / Cancel)

Resets your current picture mode to its default settings.

Sound Menu

Changing the Preset Sound Mode



 MENU  → Sound → Mode → ENTER 

Mode

- **Standard:** Selects the normal sound mode.
- **Music:** Emphasizes music over voices.
- **Movie:** Provides the best sound for movies.
- **Clear Voice:** Emphasizes voices over other sounds.
- **Custom:** Increase the intensity of high-frequency sound to allow a better listening experience for the hearing impaired.

Basic Features

Adjusting Sound Settings



 MENU  → Sound → Equalizer → ENTER 

Equalizer

Adjusts the sound mode.

- **Balance L/R:** Adjusts the balance between the right and left speaker.
- **100Hz / 300Hz / 1kHz / 3kHz / 10kHz** (Bandwidth Adjustment): Adjusts the level of specific bandwidth frequencies.
- **Reset:** Resets the equalizer to its default settings.

Sound Settings

 MENU  → Sound → ENTER 

SRS TruSurround HD (Off / On)

SRS TruSurround HD is a patented SRS technology that solves the problem of playing 5.1 multichannel content over two speakers. TruSurround delivers a compelling, virtual surround sound experience through any two-speaker playback system, including internal television speakers. It is fully compatible with all multichannel formats.

Preferred Language

(digital channels only)

Digital-TV broadcasts are capable of simultaneous transmission of many audio tracks (for example, simultaneous translations of the program into foreign languages).

-  You can only select a language among the ones being broadcasted.

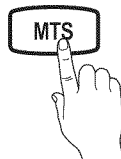

Multi-Track Sound (MTS)

(analog channels only)

- **Mono:** Choose for channels that are broadcasting in mono or if you are having difficulty receiving a stereo signal.
 - **Stereo:** Choose for channels that are broadcasting in stereo.
 - **SAP:** Choose to listen to the Separate Audio Program, which is usually a foreign-language translation.
-  Depending on the particular program being broadcast, you can listen to **Mono**, **Stereo** or **SAP**.

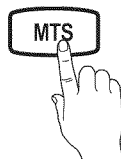





Auto Volume (Off / On)

Because each broadcasting station has its own signal conditions, the volume can vary as you switch between channels. This feature lets you automatically adjust the volume of the desired channel by lowering the sound output when the modulation signal is high or by raising the sound output when the modulation signal is low.

Speaker Select (External Speaker / TV Speaker)

A sound echo may occur due to a difference in decoding speed between the main speaker and the audio receiver. In this case, set the TV to **External Speaker**.



-  When **Speaker Select** is set to **External Speaker**, the volume and MUTE buttons will not operate and the sound settings will be limited.
-  When **Speaker Select** is set to **External Speaker**.
 - **TV Speaker: Off, External Speaker: On**
-  When **Speaker Select** is set to **TV Speaker**.
 - **TV Speaker: On, External Speaker: On**
-  If there is no video signal, both speakers will be mute.

Sound Reset (Reset All / Reset Sound Mode / Cancel)



- **Reset All:** Restore all sound settings to the factory defaults.
- **Reset Sound Mode:** Returns all sound values in the currently selected mode to the default settings.

Setup Menu



Setting the Time

 MENU  → Setup → Time → ENTER 



Time

- **Clock:** Setting the clock is for using various timer features of the TV.
 -  The current time will appear every time you press the INFO button.
 -  If you disconnect the power cord, you have to set the clock again.

Clock Mode (Auto / Manual)

- **Auto:** Set the current time automatically using the time from a digital channel.
 -  The antenna must be connected in order to set the time automatically.
- **Manual:** Set the current time manually.
 -  Depending on the broadcast station and signal, the auto time set up may not be correct. In this case, set the time manually.

Clock Set: Set the **Month, Day, Year, Hour, Minute** and **am/pm** manually.

-  Available only when **Clock Mode** is set to **Manual**.
-  You can set the **Month, Day, Year, Hour** and **Minute** directly by pressing the number buttons on the remote control.

Time Zone: Select your time zone.



-  This function is only available when the **Clock Mode** is set to **Auto**.

DST (Daylight Saving Time) (Off / On / Auto):

Switches the Daylight Saving Time function on or off.

-  This function is only available when the **Clock Mode** is set to **Auto**.



Using the Sleep Timer

 MENU  → Setup → Time → Sleep Timer → ENTER 

- **Sleep Timer** : Automatically shuts off the TV after a preset period of time. (30, 60, 90, 120, 150 and 180 minutes).

-  To cancel the **Sleep Timer**, select **Off**.

Setting the On/Off Timer

 MENU  → Setup → Time → Timer 1 → ENTER 

You can set the TV to turn on automatically at a preset time.

- **Timer 1 / Timer 2 / Timer 3:** Three different on / off timer settings can be made. You must set the clock first.

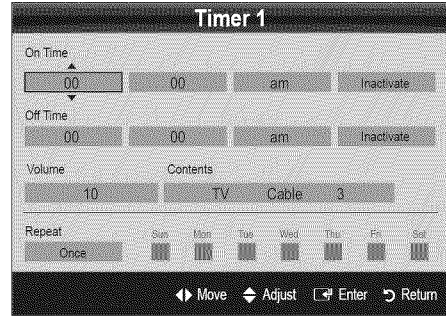

On Time / Off Time: Set the hour, minute, and activate / inactivate. (To activate the timer with the setting you've chosen, set to **Activate**.)

Volume: Set the desired volume level.

Contents : Select a folder in the USB device containing music or photo files to be played when the TV is turned on automatically.

NOTE



- If there is no music file on the USB device or the folder containing a music file is not selected, the Timer function does not operate correctly.
- When there is only one photo file in the USB, the Slide Show will not play.
- If a folder name is too long, the folder cannot be selected.
- Each USB you use is assigned its own folder. When using more than one of the same type of USB, make sure the folders assigned to each USB have different names.

Repeat: Select **Once, Everyday, Mon~Fri, Mon~Sat, Sat~Sun** or **Manual** to set at your convenience. If you select **Manual**, you can set up the day you want to activate the timer.

-  The mark indicates the day is selected.

-  **Auto Power Off** (available only when the TV is turned on by the Timer): The TV will be automatically turned off after 3 hours of being left idle to prevent overheating.

Locking Programs

 MENU  → Setup → V-Chip → ENTER 

V-Chip

The **V-Chip** feature automatically locks out programs that are deemed inappropriate for children. The user must enter a PIN (personal identification number) before any of the V-Chip restrictions are set up or changed.

Basic Features

NOTE

- **V-Chip** is not available in **HDMI** or **Component** mode.
- The default PIN number of a new TV set is "0-0-0-0"
- **Allow All**: Press to unlock all TV ratings.
- **Block All**: Press to lock all TV ratings.

■ **V-Chip Lock (Off / On)**: You can block rated TV Programs.

TV Parental Guidelines: You can block TV programs depending on their rating. This function allows you to control what your children are watching.

- **TV-Y**: Young children / **TV-Y7**: Children 7 and over / **TV-G**: General audience / **TV-PG**: Parental guidance / **TV-14**: Viewers 14 and over / **TV-MA**: Mature audience
- **ALL**: Lock all TV ratings. / **FV**: Fantasy violence / **V**: Violence / **S**: Sexual situation / **L**: Adult Language / **D**: Sexually Suggestive Dialog

 The **V-Chip** will automatically block certain categories dealing with more sensitive material. For example, if you block the **TV-Y** category, then **TV-Y7** will automatically be blocked. Similarly, if you block the **TV-G** category, then all the categories in the young adult group will be blocked (**TV-G**, **TV-PG**, **TV-14** and **TV-MA**). The sub-ratings (**D**, **L**, **S**, **V**) work similarly. So, if you block the **L** sub-rating in **TV-PG**, then the **L** sub-ratings in **TV-14** and **TV-MA** will automatically be blocked.

MPAA Rating: You can block movies depending on their MPAA rating. The Motion Picture Association of America(MPAA) has implemented a rating system that provides parents or guardians with advanced information on which films are appropriate for children.

- **G**: General audience (no restrictions). / **PG**: Parental guidance suggested. / **PG-13**: Parents strongly cautioned. / **R**: Restricted. Children under 17 should be accompanied by an adult. / **NC-17**: No children under age 17. / **X**: Adults only. / **NR**: Not rated.

 The **V-Chip** will automatically block any category that deals with more sensitive material. For example, if you block the **PG-13** category, then **R**, **NC-17** and **X** will automatically be blocked.

Canadian English: You can block TV programs depending on their Anglophone Canadian ratings.

- **C**: Programming intended for children under age 8. / **C8+**: Programming generally considered acceptable for children 8 years and over to watch on their own. / **G**: General programming, suitable for all audiences. / **PG**: Parental Guidance. / **14+**: Programming contains themes or content which may not be suitable for viewers under the age of 14. / **18+**: Adult programming.

 The **V-Chip** will automatically block any category that deals with more sensitive material. For example, if you block the **G** category, then **PG**, **14+** and **18+** will automatically be blocked.

Canadian French: You can block TV programs depending on their Anglophone Canadian ratings.

- **G**: General / **8 ans+**: Programming generally considered acceptable for children 8 years and over to watch on their own. / **13 ans+**: Programming may not be suitable for children under the age of 13. / **16 ans+**: Programming is not suitable for children under the age of 16. / **18 ans+**: Programming restricted to adults.

 The **V-Chip** will automatically block any category that deals with more sensitive material. For example, if you block the **8 ans+** category, then **13 ans+**, **16 ans+** and **18 ans+** will automatically be blocked also.

Downloadable U.S. Rating: Parental restriction information can be used while watching DTV channels.

NOTE

- If information is not downloaded from the broadcasting station, the **Downloadable U.S. Rating** menu is deactivated.
- Parental restriction information is automatically downloaded while watching DTV channels. It may take several seconds.
- The **Downloadable U.S. Rating** menu is available for use after information is downloaded from the broadcasting station. However, depending on the information from the broadcasting station, it may not be available for use.
- Parental restriction levels differ depending on the broadcasting station. The default menu name and **Downloadable US Rating** change depending on the downloaded information.
- Even if you set the on-screen display to another language, the **Downloadable U.S. Rating** menu will appear in English only.
- The rating will automatically block certain categories that deal with more sensitive material.
- The rating titles (For example: Humor Level..etc) and TV ratings (For example: DH, MH, H..etc) may differ depending on the broadcasting station.

- **Change PIN**: The **Change PIN** screen will appear. Choose any 4 digits for your PIN and enter it in the **Enter New PIN**. Re-enter the same 4 digits in the **Confirm New PIN**. When the Confirm screen appears, press the **OK** button. Your PIN has been memorized.



How to watch a restricted channel

If the TV is tuned to a restricted channel, the V-Chip will block it. The screen will go blank and the following message will appear:

This channel is blocked by V-Chip. Please enter the PIN to unblock.



-  If you forget the PIN code, press the remote control buttons in the following sequence in Standby mode, which resets the PIN to "0-0-0-0":
MUTE → 8 → 2 → 4 → POWER (on).

Other Features

 MENU  → Setup → ENTER 

Language

Set the menu language.

1. Select **Language** and press the ENTER  button.
2. Choose desired language and press the ENTER  button.

 Choose between **English**, **Español** and **Français**.

Game Mode (Off / On)

When connecting to a game console such as PlayStation™ or Xbox™, you can enjoy a more realistic gaming experience by selecting the game mode.

NOTE

- Precautions and limitations for game mode.
 - To disconnect the game console and connect another external device, set **Game Mode** to **Off** in the setup menu.
 - If you display the TV menu in **Game Mode**, the screen shakes slightly.
- **Game Mode** is not available when the input source is set to TV.
- After connecting the game console, set **Game Mode** to **On**. Unfortunately, you may notice reduced picture quality.
- If **Game Mode** is **On**:
 - **Picture** mode is set to **Standard** and **Sound** mode is set to **Custom**.
 - **Equalizer** is not available.

Caption

(On-Screen Text Messages)

- **Caption (Off / On)**: You can switch the caption function on or off. If captions are not available, they will not be displayed on the screen.

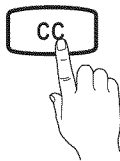

-  The Caption feature doesn't work in Component, HDMI modes.

- **Caption Mode**: You can select the desired caption mode.

 The availability of captions depends on the program being broadcast.

Default / CC1~CC4 / Text1~Text4: (analog channels only) The Analog Caption function operates in either analog TV channel mode or when a signal is supplied from an external device to the TV. (Depending on the broadcasting signal, the Analog Caption function may not work with digital channels.)

Default / Service1~Service6 / CC1~CC4 / Text1~Text4: (digital channels only) The Digital Captions function works with digital channels.

 **Service1~6** may not be available in digital caption mode depending on the broadcast.

- **Digital Caption Options**: (digital channels only)

Size: Options include Default, Small, Standard and Large. The default is Standard.

Font Style: Options include Default and Styles 0 to 7. The default is Style 0.

Foreground Color: Options include Default, White, Black, Red, Green, Blue, Yellow, Magenta and Cyan. You can change the color of the letter. The default is White.

Background Color: This adjusts the opacity of text. Options include of Default, White, Black, Red, Green, Blue, Yellow, Magenta and Cyan. You can change the background color of the caption. The default is Black.

Foreground Opacity: Options include Default, Transparent, Translucent, Solid and Flashing.

Background Opacity: This adjusts the opacity of the caption background. Options include Default, Transparent, Translucent, Solid and Flashing.

Return to Default: This option sets each Size, Font Style, Foreground Color, Background Color, Foreground Opacity and Background Opacity to its default.

NOTE

- **Digital Caption Options** are available only when **Default** and **Service1 ~ Service6** can be selected in Caption Mode.
- The availability of captions depends on the program being broadcasted.
- The **Default** setting follows the standards set by the broadcaster.
- The Foreground and Background cannot be set to have the same color.
- You cannot set both the **Foreground Opacity** and the **Background Opacity** to **Transparent**.

Basic Features





Melody (Off / Low / Medium / High)

Set so that a melody plays when the TV is turned on or off.

 The **Melody** does not play.

- When no sound is output from the TV because the **MUTE** button has been pressed.
- When no sound is output from the TV because the volume has been reduced to minimum with the **VOL -** button.
- When the TV is turned off by **Sleep Timer** function.

Economical Solutions

 **MENU**  **Setup**  **ENTER** 

The Eco Function can be used to enhance your power savings.

Energy Saving (Off / Low / Medium / High)

This adjusts the brightness of the TV in order to reduce power consumption. Press any button except the volume button to turn on the screen. Until the screen turns on again, a distorted picture will be displayed for about 4 seconds.

Support Menu

 **MENU**  **Support**  **ENTER** 

Self Diagnosis

 Self Diagnostic might take few seconds, this is part of the normal operation of the TV.

■ **Picture Test (Yes / No):** Use to check for picture problems.

Yes: If the test pattern does not appear or there is noise in the test pattern, select **Yes**. There may be a problem with the TV. Contact Samsung's Call Center for assistance (1-800-SAMSUNG).

No: If the test pattern is properly displayed, select **No**. There may be a problem with your external equipment. Please check your connections. If the problem persists, refer to the external device's user manual.

■ **Sound Test (Yes / No):** Use the built-in melody sound to check for sound problems.

 If you hear no sound from the TV's speakers, before performing the sound test, make sure **Speaker Select** is set to **TV Speaker** in the **Sound** menu.

 The melody will be heard during the test even if **Speaker Select** is set to **External Speaker** or the sound is muted by pressing the **MUTE** button.

Yes: If you can hear sound only from one speaker or not at all during the sound test, select **Yes**. There may be a problem with the TV. Contact Samsung's Call Center for assistance (1-800-SAMSUNG).

No: If you can hear sound from the speakers, select **No**. There may be a problem with your external equipment. Please check your connections. If the problem persists, refer to the external device's user manual.

■ **Signal Strength:** (Digital channels only) An HD channel's reception quality is either perfect or the channels are unavailable. Adjust your antenna to increase signal strength.

Software Upgrade

Samsung may offer upgrades for your TV's firmware in the future. Please visit

Samsung.com or contact the Samsung call center at 1-800-SAMSUNG (726-7864)

to receive information about downloading upgrades and using a USB drive. Upgrades will be possible by connecting a USB drive to the USB port.

 When software is upgraded, video and audio settings you have made will return to their default (factory) settings.

 We recommend you write down your settings so that you can easily reset them after the upgrade.

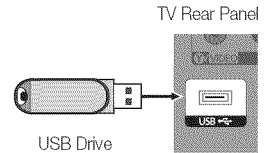

HD Connection Guide

Refer to this information when connecting external devices to the TV.

Contact Samsung

View this information when your TV does not work properly or when you want to upgrade the software. You can find information regarding our call centers and how to download products and software.

Advanced Features

Media Play

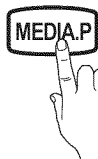

Enjoy photos and/or music files saved on a USB Mass Storage Class (MSC) device.

MENU → Application → Media Play (USB) → ENTER

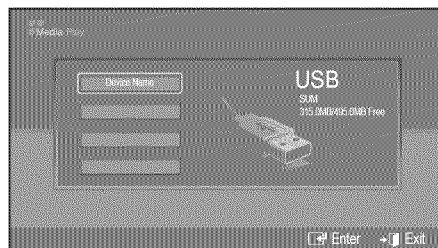

Connecting a USB Device

1. Turn on your TV.
2. Connect a USB device containing photo and/or music files to the **USB** jack on the Rear of the TV.
3. When USB is connected to the TV, popup window appears. Then you can select **Media Play**.

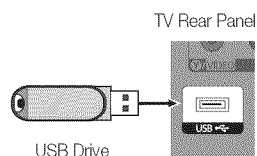

Using the Media Play Menu

Viewing a Photo (or Slide Show)

1. Press the MENU button. Press the ▲ or ▼ button to select **Application**, then press the ENTER button.
2. Press the ▲ or ▼ button to select **Media Play (USB)**, then press the ENTER button.
3. Press the ▲ or ▼ button to select the corresponding USB Memory Device, then press the ENTER button.
 - The Media Play menu differs depending on the USB Memory Device connected to TV.
 - Some devices may not be supported due to compatibility problems.
4. Press the ◀ or ▶ button to select an icon (**Photo**, **Music**, **Setup**), then press the ENTER button.



It might not work properly with unlicensed multimedia files.

Need-to-Know List before using **Media Play (USB)**









- Only alphanumeric characters must be used as a folder name or file name (photo, music).
- The file system only supports FAT16/32 (The NTFS file system is not supported) Certain types of USB Digital camera and audio devices may not be compatible with this TV.
- Media Play (USB) only supports the USB Mass Storage Class device (MSC). MSC is a Mass Storage Class Bulk-Only Transport device. Examples of MSC are Thumb drives and Flash Card Readers (Both USB HDD and HUB are not supported.)
- Before connecting your device to the TV, please back up your files to prevent them from damage or loss of data. SAMSUNG is not responsible for any data file damage or data loss.
- Please connect directly to the USB port of your TV. If you are using a separate cable connection, there may be a USB Compatibility problem.

Advanced Features

- Only MP3 and JPEG file formats are supported.
- The Media Play (USB) mp3 format only supports music files with a high sampling frequency (32 kHz, 44.1 kHz, or 48 kHz).
- We recommend the sequential jpeg format.
- Do not disconnect the USB device while it is loading.
- MTP (Media Transfer Protocol) is not supported.
- The playing duration of an mp3 file may be displayed as “00:00:00” if its playing time information is not found at the start of the file.
- The higher the resolution of the image, the longer it takes to display on the screen.
- The Photo or Music List displays up to 300 folders or files.
- Loading may take some time depending on the size of the file.
- MP3 files with DRM that have been downloaded from a non-free site cannot be played.
- Digital Rights Management (DRM) is a technology that supports the creation of content, distribution and management of the content in an integrated and comprehensive way, including the protection of the rights and interests of the content providers, the prevention of the illegal copying of contents, as well as managing billings and settlements.
- The power-saving mode of some external hard disk drives may be released automatically when connected to the TV.
- If a USB extension cable is used, the USB device may not be recognized or the files on the device may not be read.
- If a USB device connected to the TV is not recognized, the list of files on the device is corrupted or a file in the list is not played, connect the USB device to the PC, format the device and check the connection.
- If a file deleted from the PC is still found when Media Play is run, use the “Empty the Recycle Bin” function on the PC to permanently delete the file.

Photos



Viewing a Photo (or Slide Show)

1. Press the INFO button to display the option **View, Start Slide Show, Delete, Delete All, Deselect All**.
 2. Press the ▲ or ▼ button to select **Start Slide Show** then press the ENTER  button.
 -  During the slide show, files are displayed in order from the currently shown file.
 -  MP3 files can be automatically played during the Slide Show if the Default **Background Music** is set to **On**. To enable this function, MP3 files and other photo files must be located in the same folder on the USB Memory Device.
-  Press the INFO button during the slide show to set the following options **Slide Show Speed, Background Music, Background Music Setting, List**. Press the ▲ or ▼ button to select the option, then press the ENTER  button.
- After setting the option press the ENTER  button to make a change.
-  Press the INFO button during the play the photo files to set the following options **Start Slide Show, Zoom, Rotate, List**. Press the ▲ or ▼ button to select the option, then press the ENTER  button.
- After setting the option press the ENTER  button to make a change.







Music

Using the MP3 List

	Folder icon
	Music list icon
	Move to the previous folder stage icon

 The selected file is displayed on the top with its playing time.

- To select all files or a file, press the INFO button to display the **Music** menus.
Press the ENTER  button to select **Play** (or **Play the selected files**), **Repeat Music**, **Delete** (or **Delete Selected File**), **Delete All** or **Deselect All**.
- Press the ▲ or ▼ button to move to an icon, then press the ENTER  button.
Pressing the ENTER  button over a musical note icon immediately plays the music file.
Pressing the ENTER  button over a folder icon shows the music files included in the folder.

■ **Play:** Select to play MP3 files.







 This menu only shows files with the MP3 file extension. Files with other file extensions are not displayed, even if they are saved on the same USB device.

 To adjust the music volume, press the **-VOL+** button on the remote control. To mute the sound, press the **MUTE** button on the remote control.

■ **Repeat Music (On / Off):** Select to repeatedly play MP3 files in the current folder.

Playing Music

- Only displays files with the MP3 file extension. Other file extensions are not displayed, even if they are saved on the same USB device.
- If the sound is strange when playing MP3 files, adjust the **Equalizer** and **SRS TruSurround HD** in the **Sound** menu. (An over-modulated MP3 file may cause a sound problem.)
- Music function information icons

	Repeat Music is On.
	Repeat Music is Off.
	When pressing the  (Play) /  (Pause) button on the remote control while music is playing.
	When pressing the  (Stop) button on the remote control, the music stops.

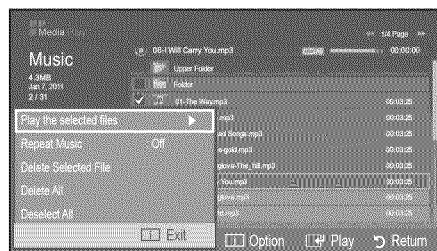
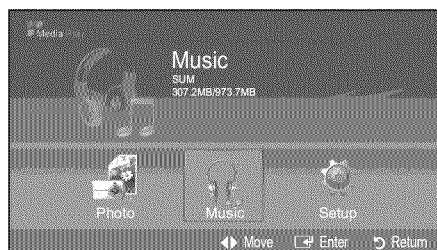

Advanced Features



Setup

Using the Setup Menu

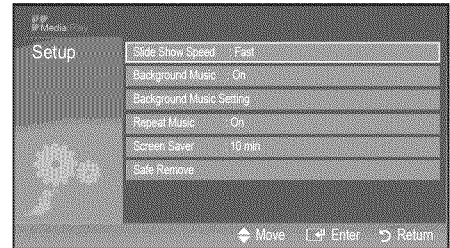
- **Slide Show Speed:** Select to control the slide show speed. You can select **Fast**, **Normal** or **Slow**.
- **Background Music:** Select to determine whether to play an MP3 file during a slide show. You can select Music **On** or Music **Off**.
- **Background Music Setting:** While a slide show is in progress, use the **Background Music Setting** to select a music file to listen to. Select an MP3 file as the background music.
- **Repeat Music:** Select to determine whether to repeat playing the music when all MP3 files in the current folder have been played.
- **Screen Saver:** Select to set the waiting time before the screen saver appears. The screensaver will appear when no button is pressed for **10 min**, **20 min**, **40 min**, **1 hour** or **Off**.
- **Safe Remove:** You can remove the device safely from the TV.



Playing the selected photos / music files

- Press the Yellow button.
- Repeat the above operation to select desired photos / music files.
 - ☞ Selected photos or files are marked with the symbol ✓. To cancel a selection, press the Yellow button again.
- Press the  (Play) / **ENTER**  button to play the selected photos or files.

Installing the Wall Mount

Installing the Wall Mount Kit

The wall mount kit (sold separately) allows you to mount the TV on the wall.

For detailed information on installing the wall mount, see the instructions provided with the wall mount. Contact a technician for assistance when installing the wall mount bracket.

Samsung Electronics is not responsible for any damage to the product or injury to yourself or others if you elect to install the TV on your own.

Wall Mount Kit Specifications (VESA)

 The wall mount kit is not supplied, but sold separately.

Install your wall mount on a solid wall perpendicular to the floor. When attaching to other building materials, please contact your nearest dealer. If installed on a ceiling or slanted wall, it may fall and result in severe personal injury.

NOTE

- Standard dimensions for wall mount kits are shown in the table below.
- When purchasing our wall mount kit, a detailed installation manual and all parts necessary for assembly are provided.
- Do not use screws that do not comply with the VESA standard screw specifications.
- Do not use screws that are longer than the standard dimension or do not comply with the VESA standard screw specifications. Screws that are too long may cause damage to the inside of the TV set.
- For wall mounts that do not comply with the VESA standard screw specifications, the length of the screws may differ depending on the wall mount specifications.
- Do not fasten the screws too strongly; this may damage the product or cause the product to fall, leading to personal injury. Samsung is not liable for these kinds of accidents.
- Samsung is not liable for product damage or personal injury when a non-VESA or non-specified wall mount is used or the consumer fails to follow the product installation instructions.
- Our 59" model do not comply with VESA Specifications. Therefore, you should use our dedicated wall mount kit for this model.
- Do not mount the TV at more than a 15 degree tilt.
- Always use two people to mount the TV to a wall.

Anti-theft Kensington Lock

The Kensington Lock is not supplied by Samsung. It is a device used to physically fix the system when using it in a public place. The appearance and locking method may differ from the illustration depending on the manufacturer. Refer to the manual provided with the Kensington Lock for additional information on proper use.

 Please find a "K" icon on the rear of the TV. A kensington slot is beside the "K" icon.

To lock the product, follow these steps:

1. Wrap the Kensington lock cable around a large, stationary object such as desk or chair.
2. Slide the end of the cable with the lock attached through the looped end of the Kensington lock cable.
3. Insert the locking device into the Kensington slot on the product .

4. Lock the lock.

 These are general instructions. For exact instructions, see the User manual supplied with the locking device.

 The locking device has to be purchased separately.

 The location of the Kensington slot may be different depending on the TV model.

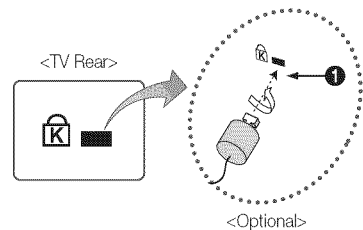

Other Information

Product Family	inches	VESA Spec. (A * B)	Standard Screw	Quantity
PDP TV	42~50	400 X 400	M8	4
	58~63	600 X 400		
	70~79	800 X 400		
	80~	1400 X 800		

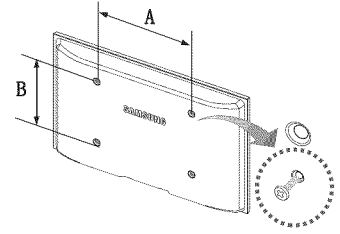

Remove the screws in the mounting holes before you install the wall mount.



Do not install your Wall Mount Kit while your TV is turned on. It may result in personal injury due to electric shock.

Securing the Installation Space

Keep the required distances between the TV, the wall, and other objects to ensure proper ventilation. Failing to do so may result in a fire or a problem with the TV caused by an increase in its internal temperature.

- When using a stand or wall-mount, use parts provided by Samsung Electronics only.
- If you use parts provided by another manufacturer, it may result in a problem with the product or an injury due to the product falling.

Installation with a stand.
Installation with a wall-mount.

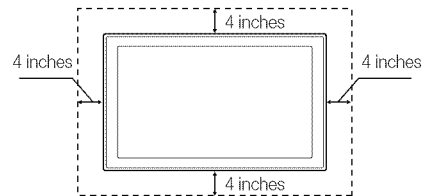
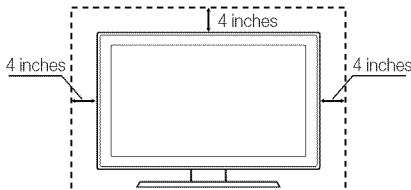

Other Warnings

- The actual appearance of the TV may differ from the images in this manual, depending on the model.
- Be careful when you touch the TV. Some parts can be somewhat hot.

Securing the TV to the Wall



Caution: Pulling, pushing, or climbing on the TV may cause the TV to fall. In particular, ensure your children do not hang over or destabilize the TV. Doing so may cause the TV to tip over, causing serious injuries or death. Follow all safety precautions provided in the included Safety Flyer with your TV. For added stability and safety, you can purchase and install the anti fall device as described below.

The TV-Holder Kit (Sold Separately):

The parts below are included in the TV Holder kit. In addition, you need to provide a wood screw, screw and molly, or other screw appropriate for the wall or cabinet you intend to secure the TV-Holder string to. We recommend a size M4xL20 wood screw.



TV-Holder (BN96-15753A)







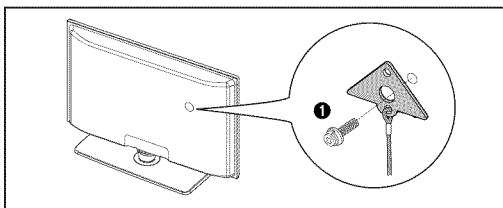

Screw ❶ (M8 X L28)

Installing the TV-Holder

1. Remove the screw attached to the back of your TV, and then connect the TV-Holder to the TV with the screw included in the TV-Holder Kit that is designated for your TV.

 Make sure to use only the appropriate supplied screw. If you use a different screw, you can damage your TV.



2. Firmly fasten the screw you provided (size M4xL20 or similar) to the wall or cabinet where the TV is to be installed.
 -  If you fasten the screw to the wall, we recommend you drive the screw into a stud. If that is not possible, use a molly to anchor the screw.
3. Tie the TV-Holder cord to the screw fastened on the wall or cabinet so that the TV is fixed. See the illustrations below.
 -  Install the TV close to the wall so that it does not fall.
 -  When attaching the TV-Holder cord to the wall, tie the cord level with the ground or slanted downwards for safety purposes.
 -  Check the cord occasionally to make sure it is secure.
 -  Before moving the TV, separate the connected cord first.

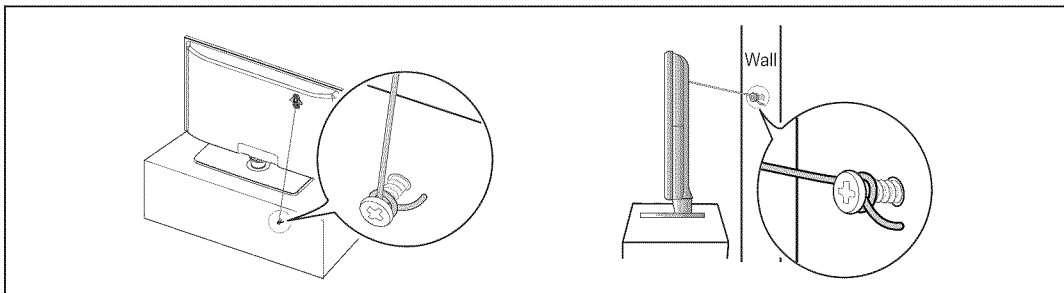

4. Verify all connections are properly secured. Periodically check the connections for any sign of fatigue or failure. If you have any doubt about the security of your connections, contact a professional installer.

To purchase the TV-Holder Kit, contact Samsung Customer Care

- In the United States: 1-800-SAMSUNG (1-800-726-7864)
- In Canada: 1-800-SAMSUNG (1-800-726-7864)

Other Information

Troubleshooting

If the TV seems to have a problem, first review this list of possible problems and solution. Also review the Troubleshooting Section in the e-Manual. If none of the troubleshooting tips apply, visit www.samsung.com/support or call Samsung customer Service at 1-800-SAMSUNG(1-800-726-7864).

Issues	Solutions and Explanations
Flickering and Dimming	<p>If your Samsung Television is flickering or dimming sporadically, you may need to disable some of its energy efficient features like the Eco Sensor or the Energy Saving feature. If you follow below step with your remote, you can turn these features off or on.</p> <ul style="list-style-type: none"> • Energy saving: User Menu → System → Eco Solution → Energy Saving • Eco Sensor: User Menu → System → Eco Solution → Eco Sensor
Component Connections / Screen Color	<p>If you find that the color on your Samsung television's screen is not correct or black and White, first run a Self Diagnosis on the TV to make sure there are no device issues.</p> <ul style="list-style-type: none"> • Self Diagnosis : User Menu → Support → Self Diagnosis → Picture Test <p>If the test is ok, try making sure ;</p> <ul style="list-style-type: none"> • Your connections are all consistent. For example, if you've used the AV In jack on your TV, make sure you have used the AV Out jack on your video source. • Try making sure you have connected to the correct jacks. For example, if you use the Component jacks, labeled Pb, Pr, and Y, to connect your TV and video source, make sure you have connected the blue Pb jack on the video source to the blue Pb jack on the TV, the red Pr jack on the source to the red Pr jack on the TV.
Screen Brightness	<p>If you find that the colors on your Samsung TV are correct but just a little too dark or bright, there are some settings you should check before calling for a repair.</p> <ul style="list-style-type: none"> • Backlight, Contrast, Brightness, Sharpness, Color, Tint and so on. <p>Go in to "Picture" on user Menu then try adjusting options mentioned above.</p>
Auto Motion Plus / Blur	<p>If you find that there is a blur or "ghostlike" appearance to the images on your television's screen, you might be able to correct it by taking advantage of Auto Motion Plus.</p> <ul style="list-style-type: none"> • Auto Motion Plus : User Menu → Picture → Picture Options → Auto Motion Plus
Unwanted Powering off	<p>If your Samsung TV appears to turn off by itself, there may be an issue with either your Timer settings or your Eco friendly No Signal Power Off feature.</p> <p>First make sure you Sleep Timer is not accidentally set. The sleep timer allows you the comfort of falling asleep with the TV still on but, turns it off after a certain period of time so as not to waste energy.</p> <ul style="list-style-type: none"> • Sleep Timer : User Menu → System → Time → Sleep Timer <p>If the Sleep Timer is not activated, you may have engaged the No Signal Power Off or Auto Power Off feature.</p> <ul style="list-style-type: none"> • No Signal Power Off : User Menu → System → Eco Solution → No Signal Power Off • Auto Power Off : User Menu → System → Eco Solution → Auto Power Off
Trouble Powering On	<p>Before Turn on check red light on the right or left bottom of your TV. Press power on button on TV or remote and it will blink about 5 times before turning on.</p> <p>If you find that you are having trouble powering on your Samsung television, there are a number of things to check before making a call to the service department.</p> <ul style="list-style-type: none"> • If you happen to be using the TV as a monitor and the stand-by light only blinks for a few seconds when you press the power button, your PC is in sleep mode. To take your PC out of sleep mode, press a key on your keyboard or move the mouse. Then try turning your TV on. <p>If you're sure your power cord, remote control, and PC are functioning properly, you may be having a cable issue. If you have a cable or satellite box, your TV may appear to be off because the cable or satellite box is not outputting a signal. To test the signal output of your cable or satellite box, press the guide or info button on the cable or satellite box remote control. If the screen displays the guide or info data, the problem is caused by the box.</p>
Stand Assembly	<p>If you have any trouble to assemble the stand though you refer to "Install the Stand" mentioned at this manual, visit www.samsung.com/spsn then check "2011 Stand Assembly" on "Top 7 TV Troubleshooting Tips".</p>
Cannot find channel	<p>Re-run plug and play. See page 10 for detail</p>

 Watch these troubleshooting on video at www.samsung.com/spsn

Issues	Solutions and Explanations
Poor picture	First of all, please perform the Picture Test and confirm that your TV is properly displaying the test image. (go to MENU - Support - Self Diagnosis - Picture Test) (p. 22) If the test image is properly displayed, the poor picture may be caused by the source or signal.
The TV image does not look as good as it did in the store.	<ul style="list-style-type: none"> • If you have an analog cable/satellite box, upgrade to an HD digital set top box. Use HDMI or Component cables to deliver HD (high definition) picture quality. • Cable/Satellite subscribers: Try HD stations from the channel line up. • Antenna connection: Try HD stations after performing Auto program. •  Many HD channels are up scaled from SD(Standard Definition) contents. • Adjust the Cable/Sat box video output resolution to 1080i or 720p.
The picture is distorted: macro block error, small block, dots, pixelization.	<ul style="list-style-type: none"> • Compression of video contents may cause picture distortion, especially in fast moving pictures such as sports and action movies. • Low signal level can cause picture distortion. This is not a TV problem. • Mobile phones used close to the TV (cca up to 1m) may cause noise in picture on analog and digital TV.
Color is wrong or missing.	<ul style="list-style-type: none"> • If you're using Component connection, make sure the component cables are connected to the correct jacks. Incorrect or loose connections may cause color problems or a blank screen.
There is poor color or brightness.	<ul style="list-style-type: none"> • Adjust the Picture options in the TV menu. (go to Picture mode / Color / Brightness / Sharpness) (p. 15) • Adjust Energy Saving option in the Setup menu (p. 22) • Try resetting the picture to view the default picture settings. (go to MENU - Picture - Picture Reset) (p. 17)
There is a dotted line on the edge of the screen.	<ul style="list-style-type: none"> • If the picture size is set to Screen Fit, change it to 16:9 (p. 16). • Change cable/satellite box resolution.
The picture is black and white.	<ul style="list-style-type: none"> • If you are using an AV composite input, connect the video cable (yellow) to the Green jack of component input 1 on the TV.
When changing channels, the picture freezes or is distorted or delayed.	<ul style="list-style-type: none"> • If connected to a cable box, please try to reset it. (reconnect the AC cord and wait until the cable box reboots. It may take up to 20 minutes) • Set the output resolution of the cable box to 1080i or 720p.
Sound Problem	First of all, please perform the Sound Test to confirm that your TV audio is properly operating. (go to MENU - Support - Self Diagnosis - Sound Test) (p. 22) If the audio is OK, the sound problem may be caused by the source or signal.
There is no sound or the sound is too low at maximum volume.	<ul style="list-style-type: none"> • Please check the volume of the device (Cable/Sat Box, DVD, Blu-ray etc) connected to your TV.
The picture is good but there is no sound.	<ul style="list-style-type: none"> • Set the Speaker Select option to TV Speaker in the sound menu (p. 18). • If you are using an external device, make sure the audio cables are connected to the correct audio input jacks on the TV. • If you are using an external device, check the device's audio output option (ex. you may need to change your cable box's audio option to HDMI when you have a HDMI connected to your TV). • If you are using a DVI to HDMI cable, a separate audio cable is required. • If your TV has a headphone jack, make sure there is nothing plugged into it. • Reboot the connected device by reconnecting the device's power cable.
The speakers are making an inappropriate noise.	<ul style="list-style-type: none"> • Check cable connections. Make sure a video cable is not connected to an audio input. • For antenna or Cable connections, check the signal strength. Low signal level may cause sound distortion. • Perform the Sound Test as explained above.



Other Information

Issues	Solutions and Explanations
No Picture, No Video	
The TV won't turn on.	<ul style="list-style-type: none"> • Make sure the AC power cord is securely plugged in to the wall outlet and the TV. • Make sure the wall outlet is working. • Try pressing the POWER button on the TV to make sure the problem is not the remote. If the TV turns on, refer to "Remote control does not work" below.
The TV turns off automatically.	<ul style="list-style-type: none"> • Ensure the Sleep Timer is set to Off in the Setup menu (p. 19). • If your PC is connected to the TV, check your PC power settings. • Make sure the AC power cord is plugged in securely to the wall outlet and the TV. • When watching TV from an antenna or cable connection, the TV will turn off after 10 - 15 minutes if there is no signal.
There is no picture/video.	<ul style="list-style-type: none"> • Check cable connections (remove and reconnect all cables connected to the TV and external devices). • Set your external device's (Cable/Sat Box, DVD, Blu-ray etc) video outputs to match the connections to the TV input. For example, if an external device's output is HDMI, it should be connected to an HDMI input on the TV. • Make sure your connected devices are powered on. • Be sure to select the TV's correct source by pressing the SOURCE button on the remote control. • Reboot the connected device by reconnecting the device's power cable.
RF(Cable/Antenna) Connection	
The TV is not receiving all channels.	<ul style="list-style-type: none"> • Make sure the coaxial cable is connected securely. • Please try Auto Program to add available channels to the channel list. Go to MENU - Channel - Auto Program then select Auto and make sure the correct Cable TV signal type is set in the menu. There are 3 options (STD, HRC and IRC) (p. 14). • Verify the Antenna is positioned correctly.
No Caption on digital channels.	<ul style="list-style-type: none"> • Check Caption Setup menu. Try changing Caption Mode Service1 to CC1 (p. 21). • Some channels may not have caption data.
The picture is distorted: macro block error, small block, dots, pixelization.	<ul style="list-style-type: none"> • Compression of video contents may cause picture distortion, especially with fast moving pictures such as sports and action movies. • A low signal can cause picture distortion. This is not a TV problem.
PC Connection	
A "Mode Not Supported" message appears.	<ul style="list-style-type: none"> • Set your PC's output resolution so it matches the resolutions supported by the TV (p. 12).
The video is OK but there is no audio.	<ul style="list-style-type: none"> • If you are using an HDMI connection, check the audio output setting on your PC. • If a HDMI to DVI cable is connected to the HDMI IN 1(DVI) port, the audio does not work.
Others	
Purple/green rolling horizontal bars and buzzing noise from the TV speakers with Component cable connection.	<ul style="list-style-type: none"> • Remove the left and right audio connections from the set-top-box. If the buzzing stops, this indicates that the set-top-box has a grounding issue. Replace the Component video cables with an HDMI connection.
The picture won't display in full screen.	<ul style="list-style-type: none"> • HD channels will have black bars on either side of the screen when displaying up scaled SD (4:3) contents. • Black bars on the Top & Bottom will be shown on movies that have aspect ratios different from your TV. • Adjust the picture size options on your external device or TV to full screen.
The remote control does not work.	<ul style="list-style-type: none"> • Replace the remote control batteries with the poles (+/-) in the right direction. • Clean the sensor's transmission window on the remote. • Try pointing the remote directly at the TV from 5-6 feet away.
The TV is making a humming noise.	<ul style="list-style-type: none"> • Plasma TVs typically make a soft humming sound. This is normal. It's caused by the electrical charges that are used to create the images on the screen. • If the humming sound is loud, you may have set the brightness on the TV too high. Try setting the brightness lower. • You can also have loud humming if the back of your Plasma TV is too close to a wall or other hard surface. Also try rerouting your connection cables. • Improper installation of wall mount can create excessive noise.

Issues	Solutions and Explanations
Image Retention (Burn In) Issue.	<ul style="list-style-type: none"> To minimize the possibility of screen burn, this unit is equipped with screen burn reduction technology. Pixel Shift technology enables you to set picture movement up/down (Vertical Line) and side to side (Horizontal Dot).
The cable/set top box remote control doesn't turn the TV on or off, or adjust the volume.	<ul style="list-style-type: none"> Program the Cable/Set remote control to operate the TV. Refer to the Cable/Set user manual for the SAMSUNG TV code.
Caption on TV menu is greyed out.	<ul style="list-style-type: none"> Caption can not be selected in the TV menu when connected via HDMI or Component (p. 21). Caption must be activated on the external device (p. 21).
A "Mode Not Supported" message appears.	<ul style="list-style-type: none"> Check the supported resolution of the TV, and adjust the external device's output resolution accordingly. Refer to the resolution settings on page 10 of this manual.
There is a plastic smell from the TV.	<ul style="list-style-type: none"> This smell is normal and will dissipate over time.
The TV Signal Strength is unavailable in the Self Diagnostic Test menu.	<ul style="list-style-type: none"> This function is only available with digital channels from an Antenna / RF/Coax connection (p. 22).
The TV is tilted to the side.	<ul style="list-style-type: none"> Remove the base stand from the TV and reassemble it.
The channel menu is greyed out (unavailable).	<ul style="list-style-type: none"> The Channel menu is only available when the TV source is selected.
Your settings are lost after 30 minutes or every time the TV is turned off.	<ul style="list-style-type: none"> If the TV is in the Store Demo mode, it will reset audio and picture settings every 30 minutes. Change the settings from Store Demo mode to Home Use mode in the Plug & Play procedure. Press the SOURCE button to select TV mode, and go to MENU → Setup → Plug & Play → ENTER [↵] (p. 9).
You have intermittent loss of audio or video.	<ul style="list-style-type: none"> Check the cable connections and reconnect them. Loss of audio or video can be caused by using overly rigid or thick cables. Make sure the cables are flexible enough for long term use. If mounting the TV to a wall, we recommend using cables with 90 degree connectors.
You see small particles when you look closely at the edge of the frame of the TV.	<ul style="list-style-type: none"> This is part of the product's design and is not a defect.
POP (TV's internal banner ad) appears on the screen.	<ul style="list-style-type: none"> Select Home Use under Plug & Play mode. For details, refer to Plug & Play Feature (p. 9).

 Some of above pictures and functions are available at specific models only.

Storage and Maintenance

-  If you attached some stickers on the TV screen, it remains some debris after removing the sticker. Please clean it to watch TV.
-  The exterior and screen of the product can get scratched during cleaning. Be sure to wipe the exterior and screen carefully using the cloth provided or a soft cloth to prevent scratches.

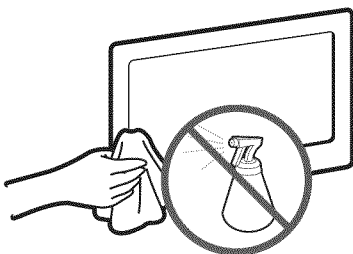

Do not spray water or a cleaning agent directly onto the product. Any liquid that goes into the product may cause a failure, fire, or electric shock.

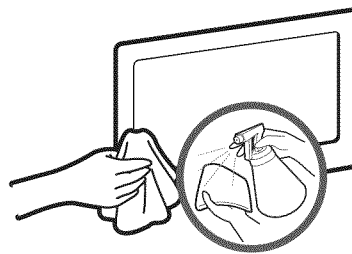

Clean the product with a soft cloth dampened with a small amount of water.

Other Information

License



TruSurround HD, SRS and  symbol are trademarks of SRS Labs, Inc. TruSurround HD technology is incorporated under license from SRS Labs, Inc.





Manufactured under license from Dolby Laboratories. Dolby and the double-D symbol are trademarks of Dolby Laboratories.

Open Source License Notice

In the case of using open source software, Open Source Licenses are available on the product menu. Open source used in this product can be found on the following webpage (<http://opensource.samsung.com>) Open source License Notice is written only English.

Specifications

Environmental Considerations		
Operating Temperature	50°F to 104°F (10°C to 40°C)	
Operating Humidity	10% to 80%, non-condensing	
Storage Temperature	-4°F to 113°F (-20°C to 45°C)	
Storage Humidity	5% to 95%, non-condensing	
Stand Swivel (Left / Right)	0°	
Model Name	PN51D530	PN59D530
Screen Size (Diagonal)	51 " Class (50.7 " measured diagonally)	59 " Class (59.0 " measured diagonally)
Sound (Output)	10 W X 2	
Dimensions (WxDxH)		
Body	46.8 x 2.2 x 27.8 inches (1187.8 x 56.0 x 706.6mm)	54.0 x 2.2 x 32.1 inches (1370.4 x 56.0 x 815.4 mm)
With stand	46.8 X 9.9 X 30.8 inches (1187.8 X 251.8 X 781.9 mm)	54.0 X 13.0 X 35.2 inches (1370.4 X 330.0 X 894.7 mm)
Weight		
Without Stand	48.1 lbs (21.8 kg)	69.7 lbs (31.6 kg)
With Stand	54.7 lbs (24.8 kg)	78.9 lbs (35.8 kg)
Display Resolution	1920 X 1080	1920 X 1080

-  Design and specifications are subject to change without prior notice.
-  This device is a Class B digital apparatus.
-  For information about power supply, and more about power consumption, refer to the label attached to the product.

Dispose unwanted electronics through an approved recycler.
To find the nearest recycling location, go to our website:
www.samsung.com/recyclingdirect Or call, (877) 278 - 0799

Dimensions

■ Front view / Side view

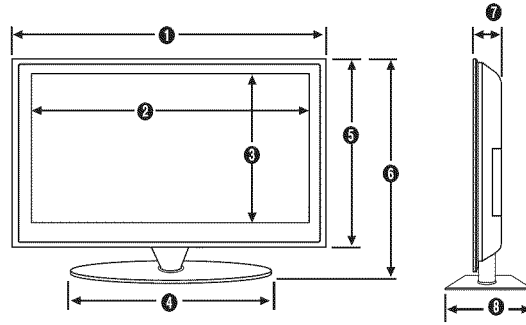

(Unit: inches)

Model name	1	2	3	4	5	6	7	8
PN51D530	46.8	44.6	25.0	20.1	27.8	30.8	2.2	9.8
PN59D530	54.0	51.8	29.2	21.3	32.1	35.2	2.2	13.0

■ Rear view

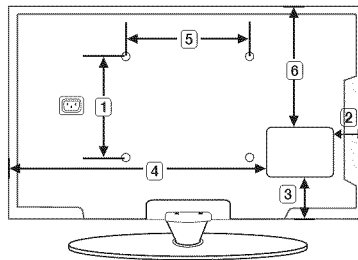

(Unit: inches)

Model name	1	2	3	4	5	6
PN51D530	15.7	3.9	4.7	36.2	15.7	18.7
PN59D530	15.7	6.8	7.5	40.5	23.6	20.1

NOTE: All drawings are not necessarily to scale. Some dimensions are subject to change without prior notice. Refer to the dimensions prior to performing installation of your TV. Not responsible for typographical or printed errors.

© 2011 Samsung Electronics America, Inc

Other Information

Index

A

Antenna	14
AUDIO OUT	11
Auto Volume	18

B

Background Music	26
Balance L/R	18
Batteries	8
Black Tone	16
Brightness	15

C

Change PIN	20
Channel Menu	13
Clock	18
Color Tone	16
Component	10
Connecting to a PC	11
Connecting to an Audio Device	11

D

DIGITAL AUDIO OUT	11
Dynamic	15
Dynamic Contrast	16

E

Edit Name	12
Editing Channels	14
Energy Saving	22
Equalizer	18
External Speaker	18

F

FAV.CH button	8, 14
Favorite Channel	14
Film Mode	17
Fine Tune	15
Flesh Tone	16
Frequency	12

H

HDMI	10
Home Theater	11

I

Installation Space	28
--------------------	----

K

Kensington Lock	27
-----------------	----

L

Language	21
License	34

M

Media Play	23
Melody	22
Mono	18
Music	25

N

Navigate	13
----------	----

O

Optimal resolution	12
--------------------	----

P

Photos	24
Picture Size	16
Plug & Play	9
Power Indicator	7

R

Remote Control	8
----------------	---

S

Select All	15
Self Diagnosis	22
Sharpness	15
Sleep Timer	19
Slide Show	24
Software Upgrade	22
Source List	12
Speaker Select	18
Specifications	34
Standby mode	7
Symbol	3

T

Timer	19
Tools	3
Troubleshooting	30
TV Speaker	18

U

USB Drive	22, 23
-----------	--------

V

Volume	7
--------	---

W

Wall Mount	27
Warm	16
White Balance	16