



AV Receiver

RX-V571

Owner's Manual

Please read "Safety Brochure" before use.

English

CONTENTS

Check the supplied items	4
---------------------------------------	----------

FEATURES

What you can do with the unit	5
--	----------

Full of useful functions!.....	6
At time like this	6

Part names and functions	7
---------------------------------------	----------

Front panel	7
Front display (indicator).....	8
Rear panel	9
Remote control	10

SETUP

General setup procedure	11
--------------------------------------	-----------

Speaker layout	12
-----------------------------	-----------

7.1-channel speaker layout	13
6.1-channel speaker layout	13
5.1-channel speaker layout	13
4.1-channel speaker layout	13
3.1-channel speaker layout	14
2.1-channel speaker layout	14

Connecting speakers	15
----------------------------------	-----------

7.1-channel speaker layout	15
6.1-channel speaker layout	15
Connecting front speakers compatible with bi-amp connection	16

Cable plugs and jacks	17
------------------------------------	-----------

Audio/video jacks	17
Analog video jacks	17
Audio jacks	17

Connecting a TV	18
------------------------------	-----------

Connecting playback devices	23
--	-----------

Connecting video devices (such as BD/DVD players)	23
Connecting audio devices (such as a CD player).....	26
Connecting to the jack on the front panel	26

Connecting the FM/AM antennas	27
--	-----------

Connecting recording devices	27
---	-----------

Connecting the power cable	28
---	-----------

Optimizing the speaker settings automatically (YPAO)	29
---	-----------

Preparation before using YPAO	29
Starting the measurement	30
Confirming the measurement result	31
Error messages	32
Warning messages.....	33

PLAYBACK

Basic playback procedure	34
---------------------------------------	-----------

Switching the sleep timer	34
Switching the information displayed on the front display	34

Changing input settings with a single key (SCENE function)	35
---	-----------

Changing the settings for the SCENE function	35
--	----

Enjoying the desired sound field effect	36
--	-----------

Enjoying sound field effects (CINEMA DSP)	37
Enjoying multi-channel sounds (surround decoder).....	39
Playback without sound field effects (straight decoding mode).....	40
Playing back fidelity sound of the selected source (direct mode).....	40
Playing back the compressed audio dynamically (Compressed Music Enhancer)	40
Enjoying surround audio with headphones (SILENT CINEMA).....	40

PLAYBACK (continued)

Listening to FM/AM	41
Changing FM/AM tuner frequency steps (Asia and General models only).....	41
Selecting a frequency for reception.....	41
Registering favorite stations (Preset tuning).....	42
Radio Data System tuning.....	44
Combining audio from the radio with video from an external device.....	45
Playing back songs with iPod	46
Connecting an iPod.....	46
Controlling while watching a TV monitor.....	49
Controlling by iPod itself.....	52
Playing back songs with Bluetooth devices	53
Connecting a Bluetooth wireless audio receiver.....	53
Pairing Bluetooth devices.....	53
Playing back songs by connecting to the Bluetooth device.....	54
Playing back songs with USB storage devices	55
Connecting a USB storage device.....	55
Controlling while watching a TV monitor.....	55
Combining a song from a USB storage device (iPod) with video from an external device.....	58
Configuring settings specific to an individual input source (Option menu)	59
Available settings in Option menu.....	59

CONFIGURATIONS

Configuring various functions (Setup menu)	63
Setup menu list.....	64
Configuring the speaker settings (Speaker).....	65
Configuring the settings of audio output signals (Sound).....	68
Setting sound program and decoder parameters (DSP).....	69
Configuring the various settings (Function).....	71
Setting HDMI functions (HDMI).....	72
Setting the language displayed on the TV screen (Language).....	75

Configuring the system settings of the unit (ADVANCED SETUP menu).....

76

Operating the ADVANCED SETUP menu.....	76
Features of the ADVANCED SETUP menu.....	76
Changing the speaker impedance (U.S.A. and Canada models only).....	76
Changing the remote control ID.....	76
Setting the bi-amp connections.....	77
Changing TV format.....	77
Removing HDMI video output upscaling limits.....	77
Changing FM/AM frequency steps (Asia and General models only).....	77
Initializing various settings for the unit.....	77

Controlling other devices with the remote control.....

78

Registering remote control codes for TV operations.....	78
Registering remote control codes for external device operations.....	79
Initializing all remote control codes.....	80

APPENDIX

Frequently asked questions.....

81

Troubleshooting.....

82

Power/system.....	82
Audio.....	83
Video.....	84
Tuner (FM/AM).....	85
Remote control.....	85

Message list.....

86

Ideal speaker layout.....

87

Glossary.....

88

Audio information.....	88
Video information.....	89
Video signal flow.....	91

Information on HDMI.....

92

HDMI Control.....	92
HDMI signal compatibility.....	93

Trademarks.....

93

Specifications.....

94

Check the supplied items

Check that the following accessories are supplied with this product.

■ **Remote Control**

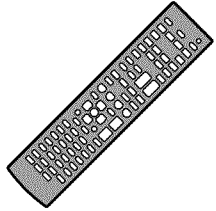

■ **Batteries (AAA, R03, UM-4) (x 2)**

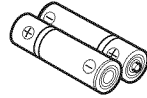

■ **YPAO microphone**

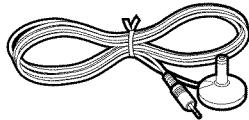

■ **VIDEO AUX input cover**

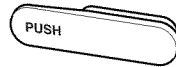

■ **AM antenna**

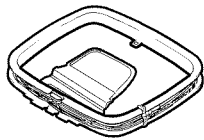

■ **FM antenna**

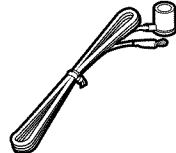

* The supplied FM antenna will differ depending on your country or region.

■ **CD-ROM (Owner's Manual)**



■ **Easy Setup Guide**



■ **Safety Brochure**

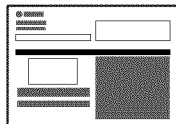

Preparing the remote control

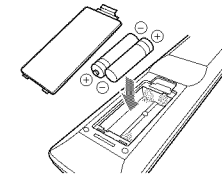

- Insert the two supplied AAA batteries into the battery case, following the polarity markings (+ and -).

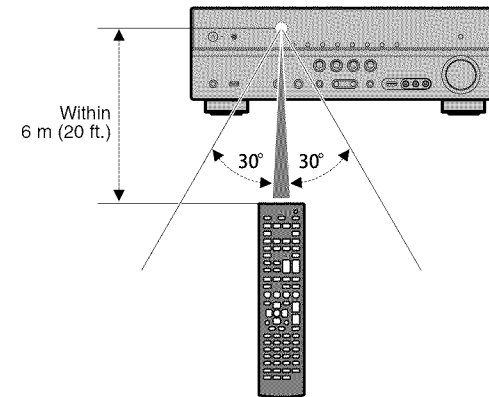

Operating range of the remote control

- Be sure to aim the remote control within the following range at the remote control sensor on the unit during operation.



- This manual is created prior to production of the product. Some parts of the product and the specifications may differ as a result of improvements, etc.
- This manual mainly explains operations using the supplied remote control.
- “” indicates the explanations for better use.
- “” indicates the cautions concerning operations or setup of the unit.
- This manual describes both the “iPod” and “iPhone” as the “iPod.” “iPod” means both “iPod” and “iPhone” unless the explanation describes exceptions.

FEATURES

What you can do with the unit

Enjoying music stored on iPod or Bluetooth devices  p.46, 53

Operating the iPod or USB menu (on TV)  p.49, 55

* Requires optional Yamaha products such as iPod dock, iPod wireless system, and Bluetooth receiver.

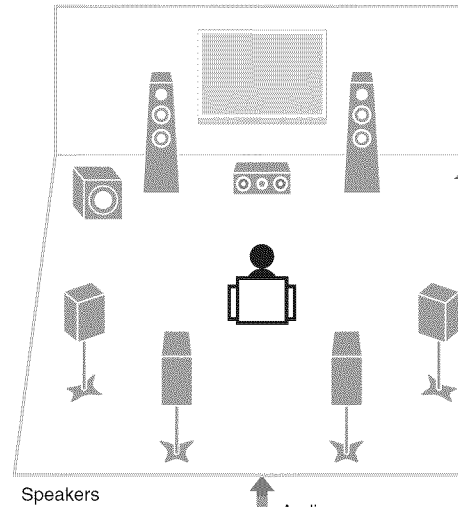
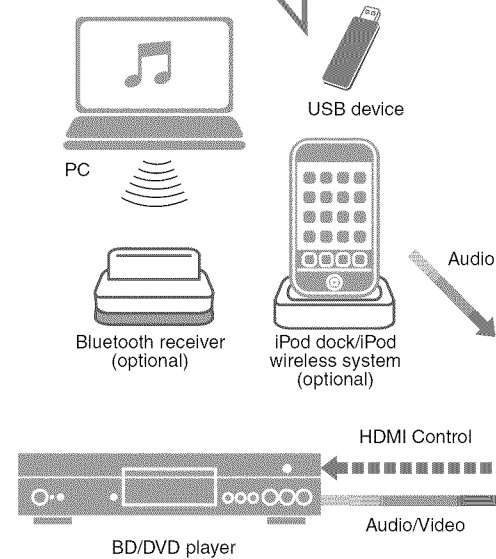

Supports 2 to 7.1 channel speaker system. Allows you to enjoy favorite acoustic spaces in various styles.

Automatically optimizing the speaker settings to suit your room (YPAO)  p.29

Sound field reproductions like actual movie theaters and concert halls (CINEMA DSP)  p.37

Multi-channel playback from stereo sounds (surround decoder)  p.39

Enjoying enhanced compression artifacts (Compressed Music Enhancer)  p.40

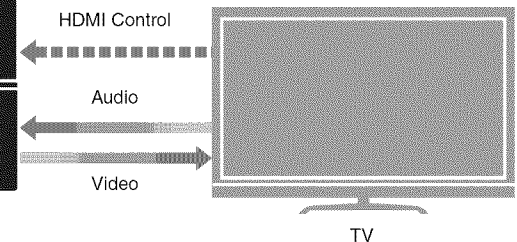
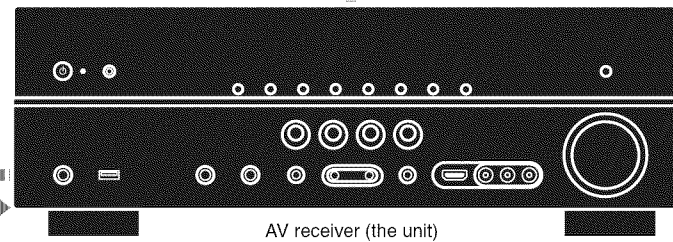



Operating external devices with the supplied remote control  p.78

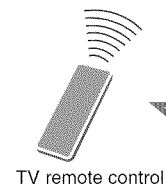

Selecting the input source and favorite settings at once (SCENE)  p.35

Easily connecting devices such as game console to the HDMI jack on the front panel  p.26



Operating the TV, AV receiver and BD/DVD player in combination (HDMI Control)  p.92

Full of useful functions!

● Connecting various devices (p.18, 23)

Various input/output jacks on the unit allow you to connect external devices such as BD/DVD player and CD player. The unit is also equipped with input jacks on the front panel which allow you easily connect and enjoy game consoles, camcorders and USB devices, and so on.

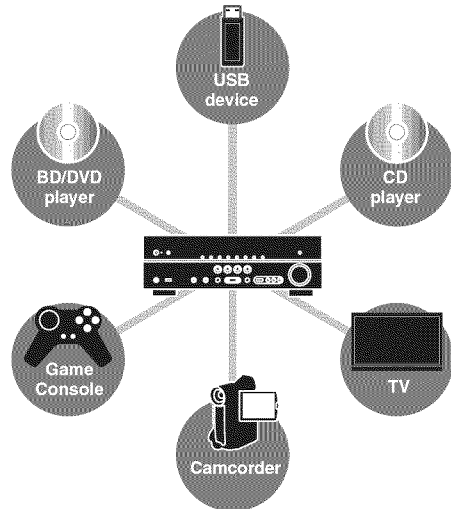

● Playing back TV audio in surround sound with a single HDMI cable connection (Audio Return Channel: ARC) (p.18, 73)

When using a TV that supports ARC, you only need an HDMI cable to connect the TV and this unit. Making such a simple connection enables to output video to the TV, input audio from the TV, and transmit HDMI Control signals at once.

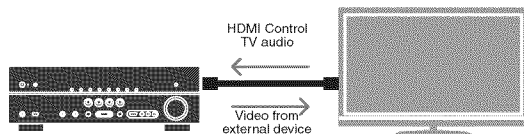

● Creating stereoscopic sound fields (p.39)

The unit supports the surround playback of up to 7.1 channel. Various sound programs and surround decoders equipped with the unit can supply more intensive and accurate stereoscopic sound field in your room. And, the unit creates virtual presence speakers to produce 3D surround sound (CINEMA DSP 3D).

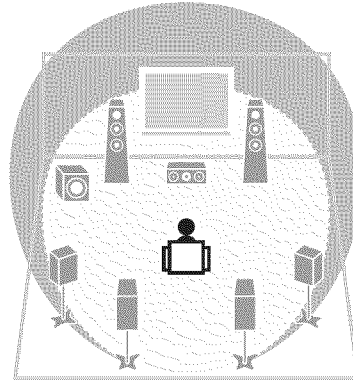

● Listening to radio with built-in receiver (p.41)

You can register up to 40 favorite radio stations as preset stations automatically or manually.

● Enjoying faithful sound compared to the original source (p.40)

When the Direct mode is enabled, the unit plays back the selected source with the least circuitry. It allows you to enjoy the faithful sound quality compared to the original source.

● Easy operation with a TV monitor

When connecting your TV to the unit with an HDMI cable, the menu of the unit can be displayed on the TV monitor to operate the unit. You can set the settings of the unit viewing the TV monitor.

- YPAO (p.29)
- Operation menus of iPod and USB device (p.49, 55)
- The "Option" menu (p.59)
- The "Setup" menu (p.63)

At time like this

The combination of video/audio input jacks prepared on this unit does not match an external device...

Use "Audio In" in the "Option" menu to change the combination of video/audio input jacks so that it matches the output jack of your external device (p.25).

I want to fine adjust sound quality...

Use "Equalizer" in the "Setup" menu to adjust sound quality of tone with an equalizer (p.67).

Video and audio are not synchronized...

Use "Lipsync" in the "Setup" menu to adjust the delay between video and audio output (p.68).

I want to hear audio from the TV speakers...

Use "Audio Output" in the "Setup" menu to redirect the output audio signal to the TV (p.73).

I want to prevent forgetting to turn the unit off...

Use "Auto Power Down" in the "Setup" menu to prevent forgetting to turn the unit off (p.71).

I want to play back BD/DVD player without the unit turned on...

Use "Standby Through" in the "Setup" menu to play back BD/DVD player while the unit keeps to be turned off (p.74).

There are many other functions to customize or confirm the settings of this unit.

For details, see the following pages.

- SCENE settings (p.35)
- Sound program and surround decoder settings (p.69)
- Various function settings (p.71)
- Current signal information (audio signal, video signal) (p.61)
- Basic settings before use (p.76)

Part names and functions

Front panel

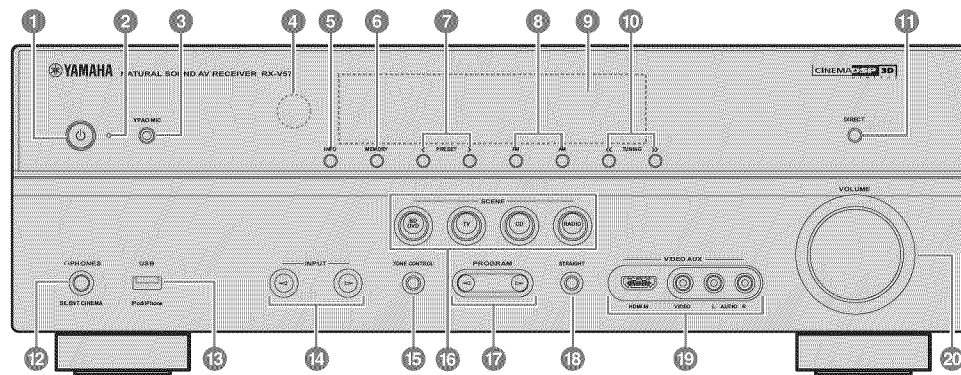

1 (power) key

Turns the unit on or into the standby mode.

2 Standby indicator

When the unit is in standby mode, lights up in any of the following cases when:

- The "Standby Through" function is working (p.74).
- The iPod is charging with "Standby Charge" (p.62).
- The Yamaha iPod wireless system is connected (p.48).

3 YPAO MIC jack

For connecting the supplied YPAO microphone (p.29).

4 Remote control receiver

Receives signals from remote control (p.4).

5 INFO

Changes the information displayed on the front display (p.34).

6 MEMORY

Registers FM/AM stations as preset stations (p.43).

7 PRESET

Selects the FM/AM preset stations (p.43).

8 FM/AM

Switches FM/AM tuner band to FM or AM (p.41).

9 Front display

Displays information about the unit (p.8).

10 TUNING

Changes FM/AM tuner frequency (p.41).

11 DIRECT

Enables/disables the direct mode (p.40).

12 PHONES jack

For connecting headphones.

13 USB port

For connecting USB devices (p.55).

14 INPUT

Switches the selected input source.

15 TONE CONTROL

Adjusts high-frequency/low-frequency output of speakers and headphones (p.60).

16 SCENE

Selects the input source and the sound programs with a single button. When the unit is in standby mode, press this key to turn on the unit (p.35).

17 PROGRAM

Selects a sound program and surround decoder (p.36).

18 STRAIGHT

Enables/disables the straight decoding mode (p.40).

19 VIDEO AUX jack

For connecting camcorders, game consoles, etc (p.26). Attach the supplied VIDEO AUX input cover (p.4) when not using this jack to protect against dust.

20 VOLUME

Adjusts the volume level.

Front display (indicator)

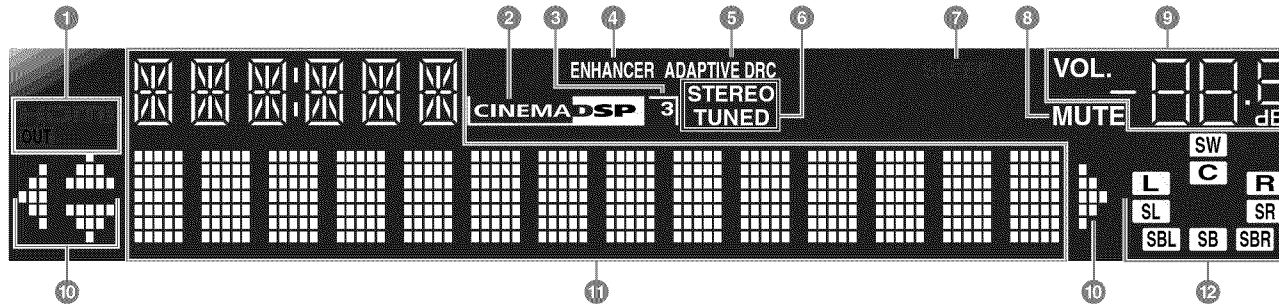

1 HDMI

Lights up when an HDMI device is connected to the unit or an HDMI signal is being output.

OUT

Lights up when HDMI signals are output.

2 CINEMA DSP

Lights up when a sound program with CINEMA DSP is activated.

3 CINEMA DSP 3D

Lights up when CINEMA DSP 3D (p.39) is activated.

4 ENHANCER

Lights up when the Compressed Music Enhancer (p.40) is activated.

5 ADAPTIVE DRC

Lights up when Adaptive DRC (p.60) is activated.

6 STEREO

Lights up when stereo broadcasting is input.

TUNED

Lights up when an FM/AM station is received.

7 SLEEP

Lights up when the sleep timer is on (p.34).

8 MUTE

Flashes when audio is muted.

9 VOLUME

Displays the current volume level.

10 Cursor indicators

Lights up the available cursors on the remote control for each operation.

11 Multi information display

Displays a range of information.

Press INFO on the remote control or front panel repeatedly to cycle through displayed information (p.34).

12 Speaker indicators

Displays speaker terminals from which signals are output.

L	Front speaker L
R	Front speaker R
C	Center speaker
SL	Surround speaker L
SR	Surround speaker R
SBL	Surround back speaker L
SBR	Surround back speaker R
SB	Surround back speaker (when connecting only a single surround back speaker)
SW	Subwoofer

Rear panel

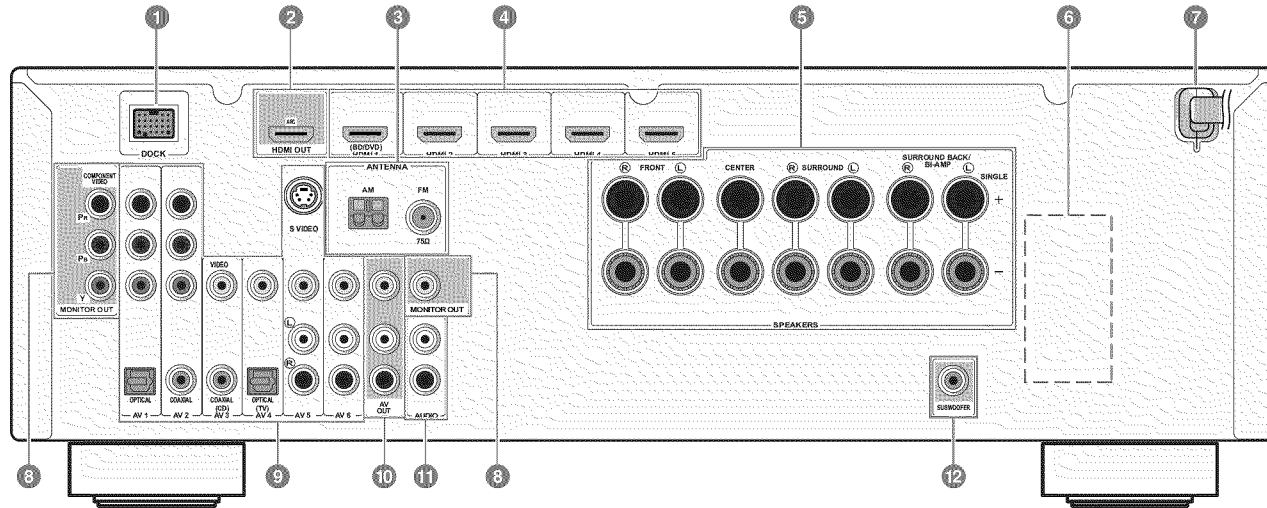

(U.K. and Europe models)

1 DOCK jack

For connecting an optional Yamaha iPod universal dock, Wireless System for iPod and Bluetooth wireless audio receiver (p.47, 48, 53).

2 HDMI OUT jack

For connecting a TV that is compatible with HDMI input to output audio/video signals. TV audio is input when ARC is used (p.18, 20, 21).

3 ANTENNA jacks

For connecting AM and FM antennas (p.27).

4 HDMI 1-5 jacks

For connecting external devices that are compatible with HDMI outputs to receive audio/video signals (p.23).

5 SPEAKERS terminals

For connecting speakers (p.15).

6 VOLTAGE SELECTOR

(General model only)

Select the switch position according to your local voltage (p.28).

7 Power cable

For connecting the unit to an AC wall outlet (p.28).

8 MONITOR OUT jacks

COMPONENT VIDEO jacks

For connecting a TV that is compatible with component video signals and outputting video signals (p.22).

VIDEO jack

For connecting a TV that is compatible with video signals to output video signals (p.22).

9 AV1-6 jacks

For connecting to playback devices equipped with audio/video outputs to receive audio/video signals (p.23).

10 AV OUT jacks

For outputting received audio/video signals when analog inputs (AV5-6 or AUDIO) are selected (p.27).

11 AUDIO jacks

For connecting to playback devices equipped with analog audio outputs to input audio signals (p.26).

12 SUBWOOFER jack

For connecting a subwoofer with a built-in amplifier (p.16).

The area around the audio/video output jacks is marked in white. Use these jacks to output audio/video signals to a TV or other external device.

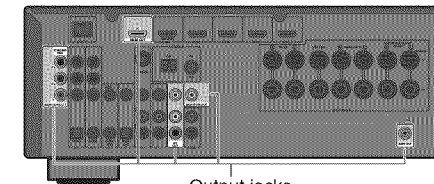

Output jacks

Remote control

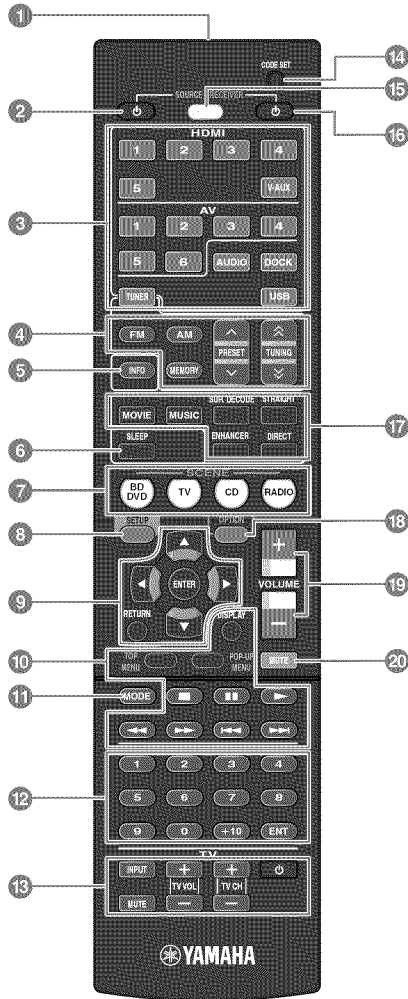

1 Remote control signal transmitter

Transmits infrared signals.

2 SOURCE (source power)

Switches an external device on and off.

3 Input selection keys

Select an input source on the unit to play back.

HDMI 1-5

HDMI 1-5 jacks

V-AUX

VIDEO AUX jack on the front panel

AV 1-6

AV 1-6 jacks

AUDIO

Audio jack

DOCK

A Yamaha iPod universal dock, iPod wireless receiver, and Bluetooth wireless receiver that are connected to the DOCK jack.

TUNER

FM/AM tuner

USB

USB devices connected the USB jack.

4 Radio keys

Operate the FM/AM tuner.

FM

Sets the FM/AM tuner band to FM.

AM

Sets the FM/AM tuner band to AM.

MEMORY

Presets radio stations.

PRESET

Selects a preset station.

TUNING

Changes tuning frequencies.

5 INFO

Switches the information displayed on the front display (p.34).

6 SLEEP

Selects the time of sleep timer (120 min., 90 min., 60 min., 30 min., and Off) by pressing this key repeatedly. SLEEP indicator lights up on the front display while using the sleep timer. After the selected time passes, the unit switches into the standby mode.

7 SCENE

Switch the input source and the sound program with a single button. When the unit is in standby mode, pressing this key turns on the unit (p.35).

8 SETUP

Displays/finishes the "Setup" menu for the unit (p.63).

9 Menu operation keys

Cursor keys

Select menu items and settings.

ENTER

Confirms a selected item.

RETURN

Returns to the previous screen when the menu is displayed.

10 External device operation keys

Operate recording, playback, menu displays, etc. for external devices (p.79, 80).

11 MODE

Switches the FM broadcast receiving modes (p.42) or the iPod operation modes (p.52).

12 Numeric keys

Enter numbers such as the frequency of FM/AM tuner and remote control codes.

13 TV control keys

Controls TV operation, such as input and volume level (p.78, 79).

14 CODE SET

Sets remote control codes for external devices (p.78).

15 SOURCE/RECEIVER

Switches the device (external device or the unit) that is available with remote control keys. Lights up in orange when the unit is selected, in green when an external device is selected.

16 RECEIVER (receiver power)

Switches the unit between on and standby mode.

17 Sound selection keys

Switches between the sound field effect (sound program) you are using and the surround decoder (p.36).

18 OPTION

Displays/finishes the "Option" menu for each input source (p.59).

19 VOLUME

Adjusts the volume balance (p.34).

20 MUTE

Turns the mute function on and off (p.34).



- Remote control codes need to be registered in advance to operate external devices with this remote control. If you use HDMI compatible devices, remote control might be available only by connecting them (p.92).

SETUP

General setup procedure

Perform the following 8 steps before use.

1 Speaker layout (p.12)

Select the speaker layout depending on the number of speakers, and then place the speakers in the room.

2 Connecting speakers (p.15)

Connect each speaker to the unit.

3 Connecting a TV (p.18)

Connect TV to the unit.

4 Connecting playback devices (p.23)

Connect video devices (BD/DVD players, etc.) or audio devices (CD players, etc.) to the unit.

5 Connecting the FM/AM antennas (p.27)

Connect the FM/AM antennas to the unit.

6 Connecting recording devices (p.27)

Connect external devices such as recording devices.

7 Connecting the power cable (p.28)

After all the settings above are complete, plug in the power cable.

8 Optimizing the speaker settings automatically (YPAO) (p.29)

Adjust the volume balance and tone of speakers automatically (YPAO).

All settings needed before use are completed here. Enjoy playing movies, music, radio, etc. with the unit!

1 Speaker layout

Select the speaker layout depending on the numbers of speakers, and then place the speakers and subwoofer (with a built-in amplifier) in the room. The following section describes the representative speaker configuration of 2.1 to 7.1 channel system.

- NOTES**
- (U.S.A. and Canada models only) The unit is configured to 8Ω speakers as the factory setting. 6Ω speakers can be also connected. For details on settings for 6Ω speaker connection, refer to “Changing the speaker impedance (U.S.A. and Canada models only)” (p.76).
 - (Except for U.S.A. and Canada models) Use speakers with an impedance of at least 6Ω.

Type of speakers	Abbr.	Function	Speaker system (the number of channels)					
			7.1	6.1	5.1	4.1	3.1	2.1
Front (L)	FL	For the front channel sound (stereo sound) and effect sound	●	●	●	●	●	●
Front (R)	FR		●	●	●	●	●	●
Center	C	For the center channel sound (dialogue, vocals, etc.)	●	●	●		●	
Surround (L)	SL	For effect and vocal sound from surround channel. Sound from surround back channel is also output when you do not use surround back speakers.	●	●	●	●		
Surround (R)	SR		●	●	●	●		
Surround back (L)	SBL	For the surround back channel sound and effect sound from rear.	●					
Surround back (R)	SBR		●					
Surround back	SB	For the surround back channel sound mixed with left and right and effect sound from rear.		●				
Subwoofer	SW	For low-frequency effect (LFE) sound and bass sound from front and surround channels.	●	●	●	●	●	●



- To get recommended speaker layout, refer to “Ideal speaker layout” (p.87).

7.1-channel speaker layout

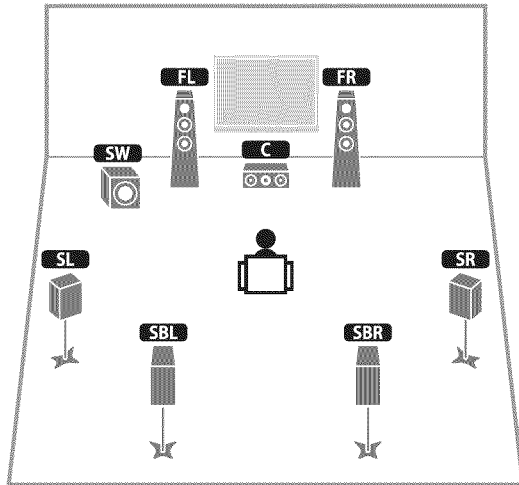

5.1-channel speaker layout

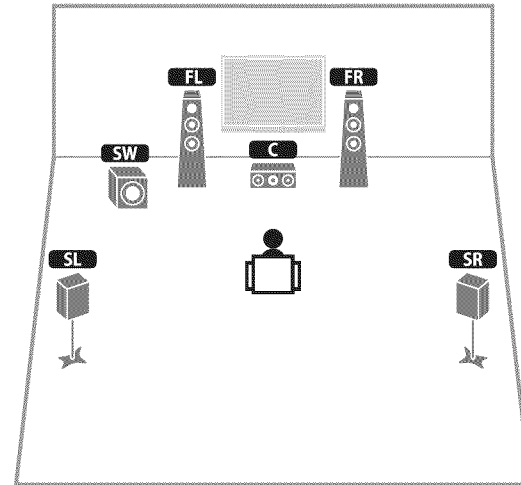

6.1-channel speaker layout

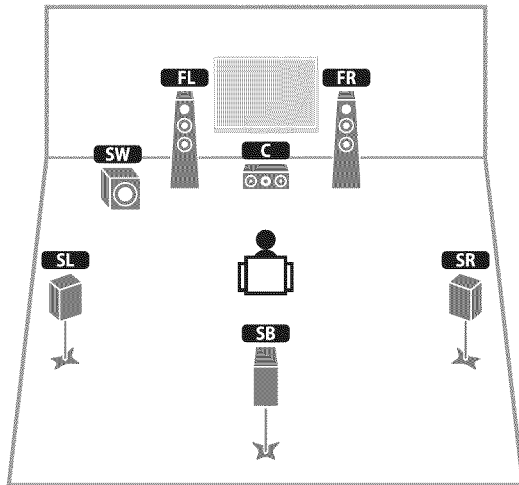

4.1-channel speaker layout

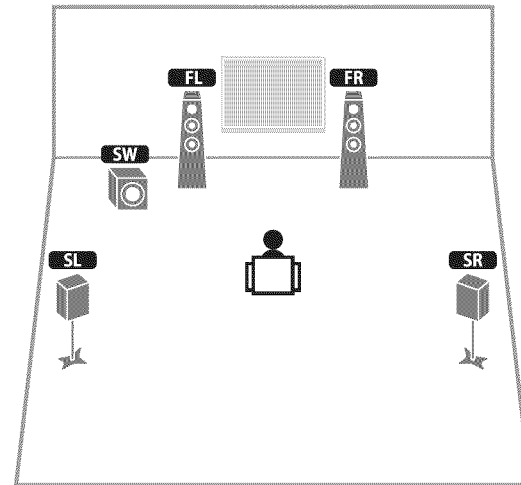

3.1-channel speaker layout

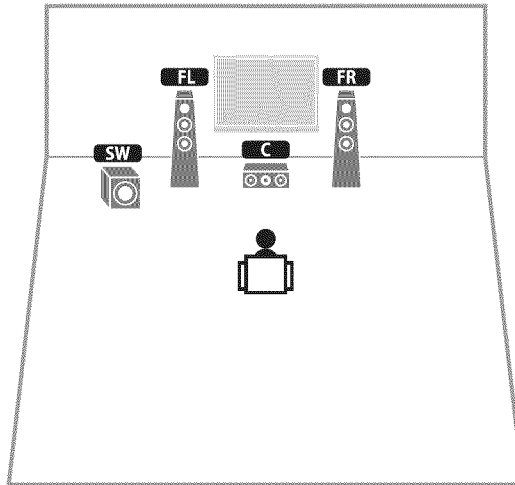

2.1-channel speaker layout

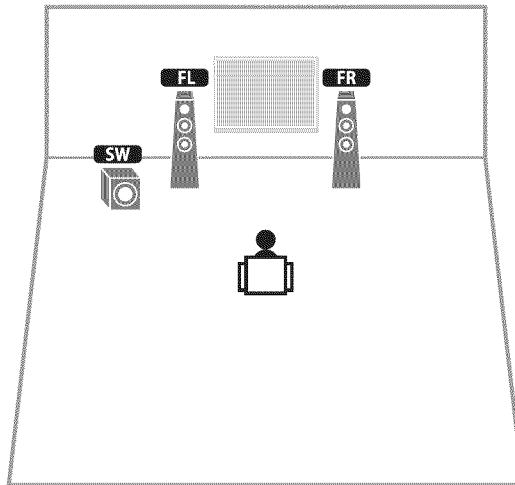

2 Connecting speakers

Connect speakers to the unit. Here are connections of 7.1- and 6.1-channel speaker layout as examples. If you select another channel speaker layout, connect speakers while referring to the connection of 6.1-channel speaker layout.

NOTES

- Disconnect the power plug before connecting speakers.
- Before connecting a subwoofer, turn off a subwoofer.
- Be careful that the core of the speaker cable does not touch anything or come into contact with the metal areas of the unit. This may damage the unit or the speakers. If the speaker cables short circuit, "CHECK SP WIRES!" will appear on the front display when the unit is switched on.

Necessary cables (not supplied)

□ Speaker cables x numbers of speakers



□ Monaural pin cable (for subwoofer) x 1



Speaker terminals on the rear of the unit

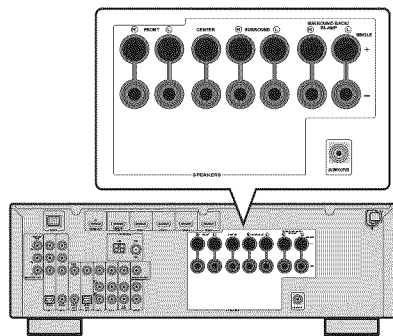

7.1-channel speaker layout

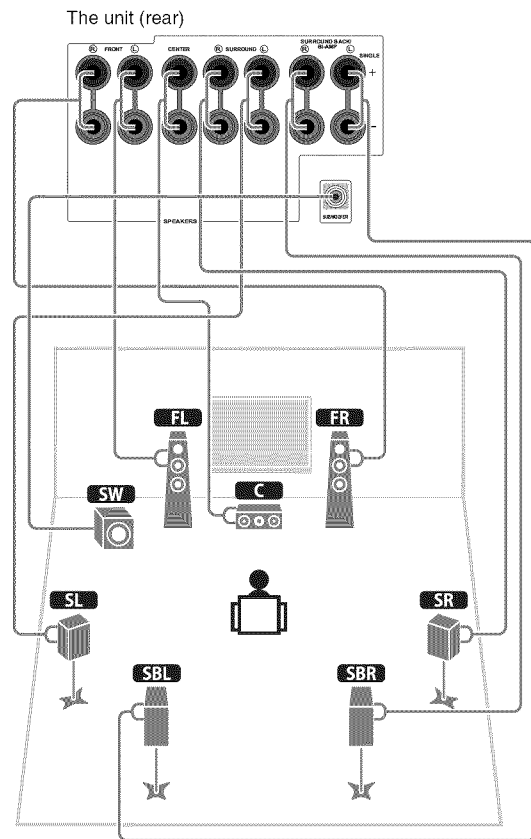

6.1-channel speaker layout

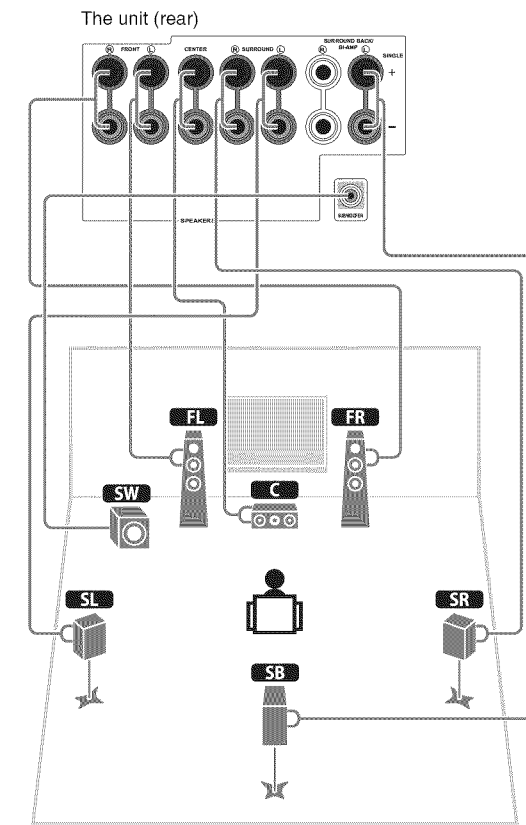

Connecting speaker cables

Each speaker has two speaker cables. One is for connecting the - (negative) terminal of the unit and the speaker, and the other is for the + (positive) terminal. The cables are different colors, so they do not get mixed up. Connect the black side to the - (negative) terminal and the other side to the + (positive) terminal.

- 1 Remove approximately 10 mm (0.4 in.) of insulation from the end of the speaker cable and twist the bare wire firmly.
- 2 Loosen the speaker terminal.
- 3 Insert the bare wire into the gap on the side of terminal. When it is difficult to insert the wire into the gap on the side, insert it into the gap downside of terminal.
- 4 Tighten the terminal.

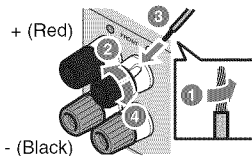

Connecting with a banana plug (Except for U.K., Europe, Asia and Korea models)

Tighten the knob, and then insert a banana plug into the end of the terminal.

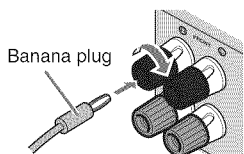

Connecting a subwoofer

Use monaural pin cable to connect a subwoofer. Before connecting a subwoofer, turn off the subwoofer.

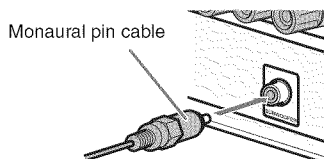

Connecting front speakers compatible with bi-amp connection

When you use front speakers that support bi-amp connection, connect the speakers to FRONT terminals and SURROUND BACK/ BI-AMP terminals.

To activate the bi-amplification connections, set the "BI-AMP" (p.77) to "ON" in the "ADVANCED SETUP" menu after connecting the power plug.

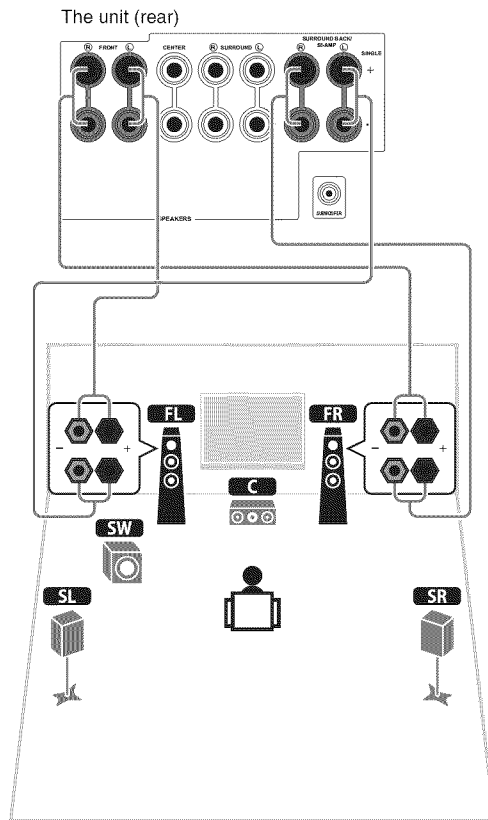

NOTES

- Before making the bi-amplification connections, remove any brackets or cables that connect a woofer with a tweeter. When not making bi-amplification connections, make sure that the brackets or cables are connected before connecting the speaker cables. Refer to the instruction manual of the speakers for more detail.
- When making the bi-amplification connections, the surround back speakers are not available.

Cable plugs and jacks

The unit is equipped with the following input/output jacks. Use jacks and cables appropriate for devices.

Audio/video jacks

HDMI jacks

Digital videos and sounds are transmitted. Use an HDMI cable for connection.

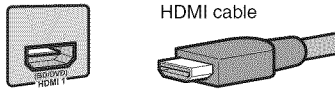

HDMI cable



- Use a 19-pin HDMI cable with the HDMI logo. Using an HDMI cable less than 5.0 m (16.4 ft.) long is recommended to prevent signal quality degradation.
- When connecting an external device with a DVI jack, use an HDMI/DVI-D cable.



- The HDMI control function, the Audio Return Channel function and transmission of 3D content are supported.

Analog video jacks

COMPONENT VIDEO jacks

The signal is separated into three devices: Luminance (Y), chrominance blue (PB) and chrominance red (PR).

Use a component video pin cable with three plugs.

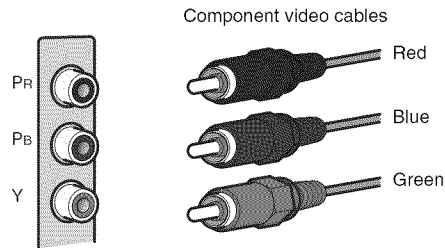

Component video cables

S VIDEO jack (U.K. and Europe models only)

This jack transmits S-video signals that include luminance (Y) and chrominance (C) components. Use S-video cable.

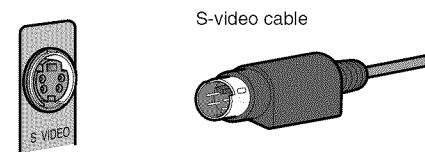

S-video cable

VIDEO jack

This jack transmits conventional analog video signal. Use a video pin cable.

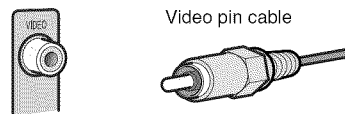

Video pin cable

Audio jacks

OPTICAL jacks

These jacks transmit optical digital audio signals. Use fiber-optic cables for connection. Remove the cap before using if needed.

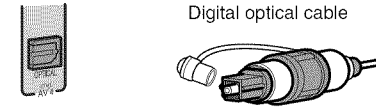

Digital optical cable

COAXIAL jacks

These jacks transmit coaxial digital audio signals. Use coaxial cables.

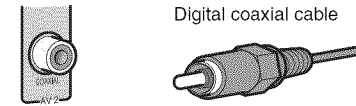

Digital coaxial cable

AUDIO jacks

These jacks transmit conventional analog audio signals. Use stereo pin cables.

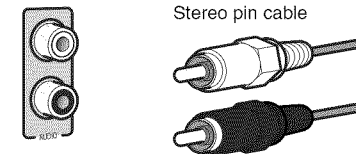

Stereo pin cable

3 Connecting a TV

Connect a TV to the unit. The video signals input to the unit are output to the TV. TV audio can also be output from the unit. The recommended way to connect a TV varies depending on types and functions of video input jacks on the TV. Select how to connect the TV to the unit while referring to the TV manual.

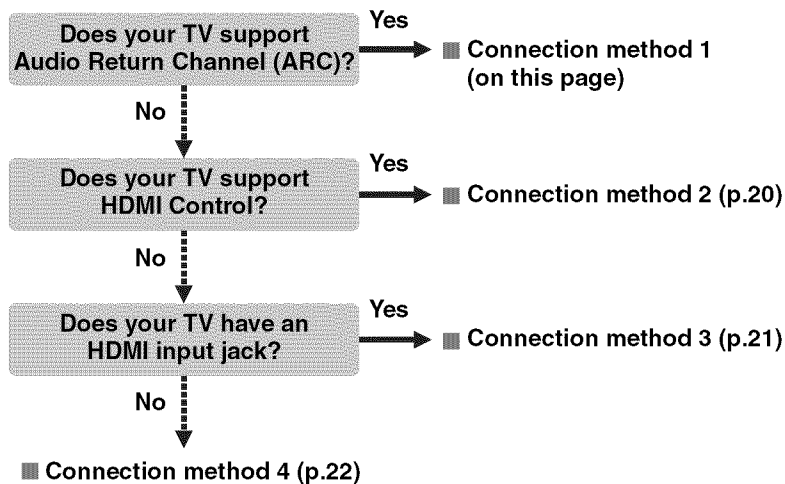

What is the HDMI control function?

By connecting a TV to the unit with an HDMI cable, some operations for the unit are available with the TV's remote control, such as turning on/standby and volume control. If playback devices that support the HDMI control function (BD/DVD players, etc.) are connected to the unit, these are also acceptable. For more details, refer to "HDMI Control" (p.92).

What is the Audio Return Channel (ARC)?

If your TV supports the ARC, TV audio can be output to the unit by using an HDMI cable transmitting video signals from the unit to a TV.

■ Connection method 1 (ARC-compatible TV)

Connect a TV to the unit with an HDMI cable.



- The following connections and steps are supplied, supposing that "HDMI" in the "Setup" menu has not been changed from the default setting (p.72).

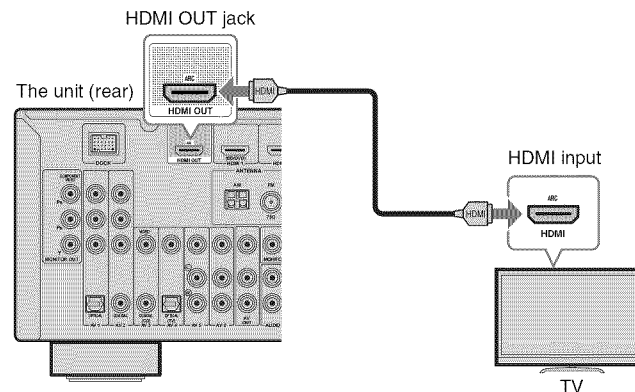

- When connecting a TV to the unit with an HDMI cable, video signals from all types of the video input jacks can be output from the HDMI OUT jack. For more details, refer to "Video signal flow" (p.91).
- By connecting a TV to the unit with an HDMI cable, each function for the unit can be configured while viewing the TV monitor (p.63).

Necessary settings

To use the HDMI control function and ARC, the following settings are required in advance.



1 After connecting external devices (TV, playback devices, etc.) and AC power cable, turn on the unit, TV and playback devices.

2 Configure the settings for ARC.

- ① Confirm that the ARC function for the TV is set to on.
For details on how to confirm, refer to manual of the TV.
- ② Change the input settings for the TV to video signals from the unit.
- ③ Press SETUP.

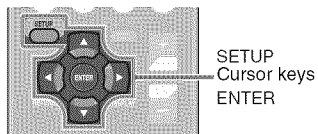

- ④ Press the cursor keys (◀/▶) to select "HDMI."

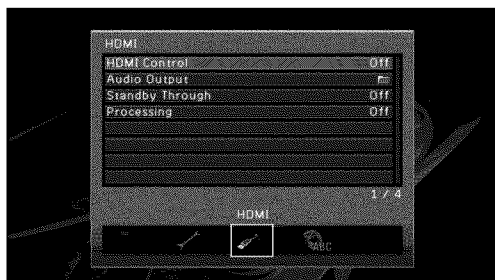

- ⑤ Press the cursor keys (▲/▼) to select "HDMI Control," and then press ENTER.

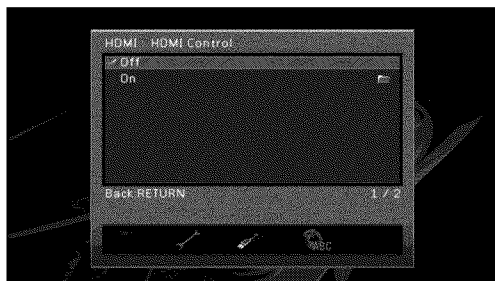

- ⑥ Press the cursor keys (▲/▼) to select "On," and then press ENTER.
- ⑦ Confirm that "ARC" is set to "On."



- "ARC" is set to "On" as the default setting. When "HDMI Control" is set to "On," the ARC function of the unit is enabled.
- ⑧ Press SETUP.

3 Configure the settings for HDMI Control.

- ① Activate the HDMI control function of the TV and the devices that support the HDMI control function.
For details on setting the HDMI control function, refer to the manual of each device.
- ② Turn off the TV.
The unit and devices are also turned off automatically with the TV's operation. If they do not turn off, turn them off manually.
- ③ Turn on the TV.
The unit also turns on with the TV. If the unit does not turn on, turn it on manually.
- ④ Change input video source on the TV to video signals from the unit.
- ⑤ Turn on the playback devices, and then confirm the following:

Unit: Whether the input signals from the playback devices are selected as the HDMI input source (any of "HDMI 1-5"). When it is not selected, select the correct input source manually.

TV: Whether the video signals from the playback devices are displayed on the TV screen.

- ⑥ Confirm whether the unit is linked with operations of the TV remote control as follows:
Turning on/standby, volume control and selecting audio output devices.
If these operations are not available, check that "HDMI Control" (p.72) in the "Setup" menu is set to "On."



- If playing back audio source by using the ARC function has a problem, set "ARC" in the "Setup" menu to "Off," and connect the TV and the unit with an optical cable (p.20).
- If the HDMI control function does not work correctly, it may be effective to turn off the devices to reset them or plug in the power cable and retry with the power cable plugged in.
- If the power-on operation is not linked, confirm the priority of audio output settings for the TV.

All settings have been completed.

When a TV program is selected with the TV remote control, input source of the unit is switched to "AV4" automatically, and TV sound is output.

If it does not work correctly, confirm that the "ARC" in the "Setup" menu is set to "On."



- "AV4" is selected as the input sound source from a TV as the default setting. When the AV4 jack is used for another device, select an input jack to be used for the TV audio in "TV Audio Input" on the "Setup" menu. Also, when using the SCENE functions (p.35), register the appropriate input source on SCENE (TV).

■ Connection method 2 (HDMI Control -compatible TV)

Connect a TV to the unit with an HDMI cable and an optical cable.



- The following connection and steps are supplied, supposing the "HDMI" in the "Setup" menu has not been changed from the default setting (p.72).

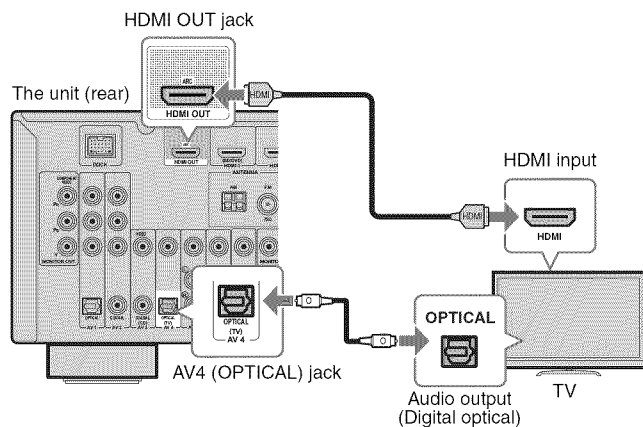

- When connecting a TV to the unit with an HDMI cable, video signals from all types of the video input jacks can be output from the HDMI OUT jack. For more details, refer to "Video signal flow" (p.91).
- By connecting a TV to the unit with an HDMI cable, each function for the unit can be configured while viewing the TV monitor (p.63).

Necessary setting

To use the HDMI control function, the following settings are required in advance.

1 After connecting external devices (TV, playback devices, etc.) and AC power cable, turn on the unit, TV and playback devices.

2 Configure the settings for HDMI Control.

- ① Activate the HDMI control function of the TV and the devices that support the HDMI control function.

For details on setting the HDMI control function, refer to manual of each device.

- ② Change the input settings for the TV to video signals from the unit.

- ③ Press SETUP.

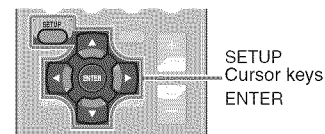

- ④ Press the cursor keys (</>) to select "HDMI."



- ⑤ Press the cursor keys (Δ/▽) to select "HDMI Control," and then press ENTER.



- ⑥ Press the cursor keys (Δ/▽) to select "On," and then press ENTER.

- ⑦ Press SETUP.

- ⑧ Turn off the TV.

The unit and devices are also turned off automatically with the TV's operation. If they do not turn off, turn them off manually.

- ⑨ Turn on the TV.

The unit also turns on. If the unit does not turn on, turn it on manually.

- ⑩ Change input video source on the TV to video signals from the unit.



⑪ Turn on the playback devices, and then confirm the following:

Unit: Whether the input signals from the playback devices are selected as the HDMI input source (any of "HDMI 1-5"). When it is not selected, select the correct input source manually.

TV: Whether the video signals from the playback devices are displayed on the TV screen.

⑫ Confirm whether the unit is linked with operations of the TV remote control as follows:

Turning on/standby, volume control and selecting audio output devices.

If these operations are not available, confirm that "HDMI Control" in the "Setup" menu is set to "On."

All settings have been completed.

When a TV program is selected with the TV's remote control, the input source of the unit is switched to "AV4" automatically, and TV sound is output.

When these operations are not linked, confirm that "HDMI Control" in the "Setup" menu is set to "On."



- When the HDMI control function does not work correctly, it may be effective to turn off the devices to reset or plug in the power cable and retry with the power cable plugged in.
- If the power-on operation is not linked, confirm the priority of audio output settings for the TV.



- "AV4" is selected as input sound source from a TV as the default setting. When the AV4 jack is used for another device, select an input jack to be used for the TV audio in "TV Audio Input" of the "Setup" menu. Also, when using the SCENE functions (p.35), register the appropriate input source for SCENE (TV).

■ Connection method 3 (TV with HDMI input jacks)

Connect a TV to the unit with an HDMI cable and an optical cable.

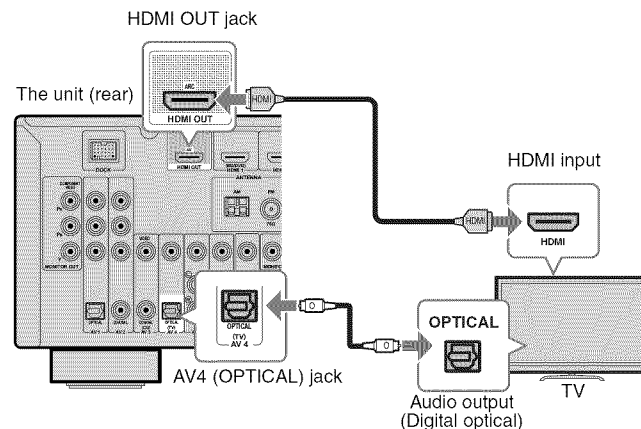

By switching input source into "AV4" with AV4 key on the remote control or SCENE, TV sound is output from the unit.



- When connecting a TV to the unit with an HDMI cable, video signals from all types of the video input jacks can be output from the HDMI OUT jack. For more details, refer to "Video signal flow" (p.91).
- By connecting a TV to the unit with an HDMI cable, each function for the unit can be configured while viewing the TV monitor (p.63).
- When the AV4 jack is used for another device, or another terminal, except when an OPTICAL jack (with an optical cable) is used for inputting TV sound, select another jack (any of AV 1-6 or AUDIO) for the connection. Also, set the input sources setting of SCENE (TV) (p.35).

■ Connection method 4 (TV without HDMI input jacks)

Connect a TV by any of the following connections depending on the input jack for TV video that is used.

By switching the input source to "AV4" with AV4 on the remote control or SCENE (TV), TV sound is output from the unit.



- When connecting to a TV with a cable, other than an HDMI cable, operations with TV screen (such as the setting of the unit, operations of iPod/USB devices) are not available.
- When connecting a TV with a cable, other than an HDMI cable, available video signals are limited as follows. For details, refer to the "Video signal flow" (p.91).
 - Video signal from the HDMI input jacks are not output from the video output jacks other than HDMI.
 - The component video and composite video signals input from an external device are only output from the MONITOR OUT jacks.
 - The S-video signals input from an external device are only output from the HDMI OUT jack (U.K. and Europe models).



- When the AV4 jack is used for another device, or another terminal, except for an OPTICAL jack (with an optical cable), is used for inputting TV sound, select another jack (any of AV1-6 or AUDIO) for the connection. Also, set the input sources setting of SCENE (TV) (p.35).

COMPONENT VIDEO connection (with a component cable)

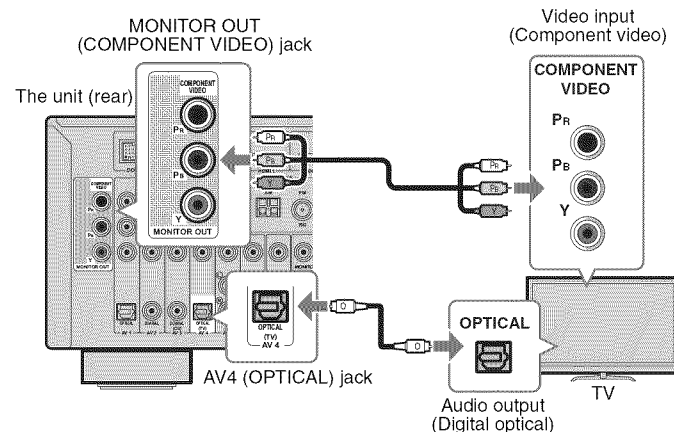

VIDEO connection (with a video pin cable)

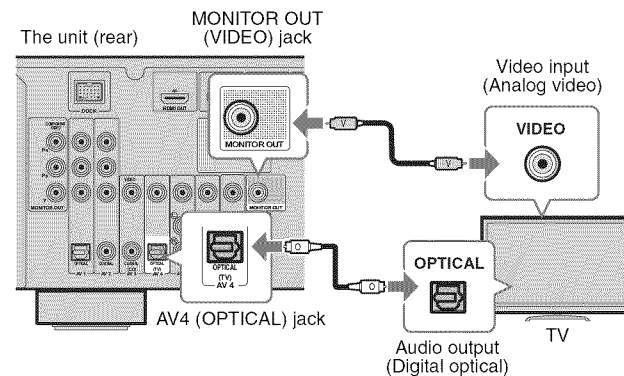

4 Connecting playback devices

The unit is equipped with various types of input jacks such as an HDMI jack. Connect them to the appropriate output jacks on the playback devices.

For connecting an iPod, Bluetooth devices and USB storage devices, refer to the following pages.

- Connecting an iPod (p.46)
- Connecting a Bluetooth wireless audio receiver (p.53)
- Connecting a USB storage device (p.55)

Connecting video devices (such as BD/DVD players)

Video devices, such as BD/DVD players, set-top boxes (STBs) and cable TV, and game consoles, are connected to the unit. Select the correct connection according to the output jacks (video/audio) of video devices connected to the unit. If a video device supports HDMI, HDMI connection is recommended.



- Video signals input with an HDMI cable can only be output to a TV connected to the unit with an HDMI cable.
- When an input jack of the unit does not match the output jack of a video device, select another jack of the unit for the video device (p.25).

HDMI connection

Connect a video device to the unit with an HDMI cable.

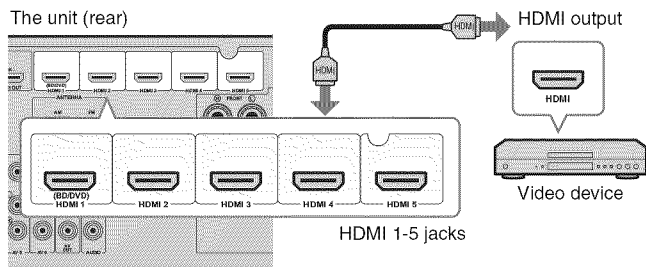

By selecting the input source with the HDMI 1-5 key, audio and video from video devices are output from the unit.

Component video connection

Connect a video device to the unit with a component cable and an audio cable (an optical cable or a coaxial cable). Input jacks of the unit (AV1-2) are different depending on the audio jacks of the video device.

Output jack of a video device		Input jack of the unit
Video	Audio	
Component video	Optical	AV1 (COMPONENT + OPTICAL)
	Coaxial	AV2 (COMPONENT + COAXIAL)

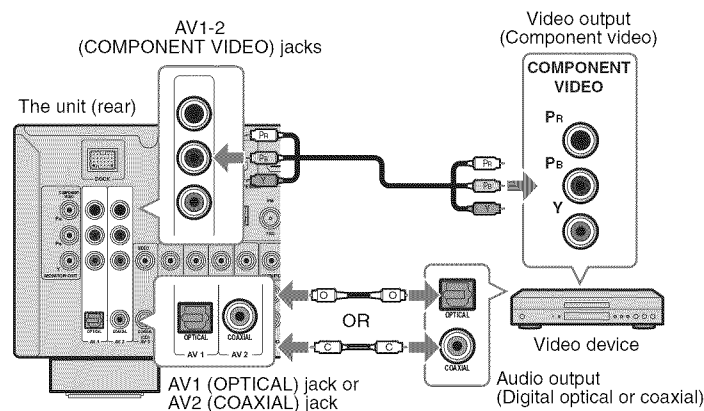

By selecting an input source with the AV1-2 key, audio and video from video devices are output from the unit.

S-video connection

(U.K. and Europe models only)

Connect a video device to the unit with a S-video cable and an audio cable (an analog stereo cable). AV5 is only available for S-video connection as the input source.

Output jack of a video device		Input jack of the unit
Video	Audio	
S-video	Analog stereo	AV5 (S VIDEO + AUDIO)

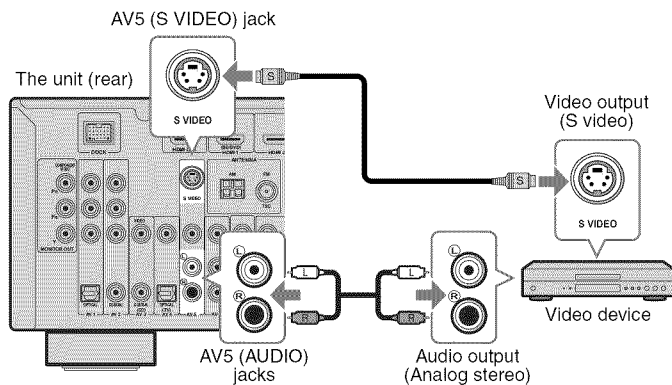

- The video signals input from S VIDEO jack are converted and output from only HDMI OUT jack.
- When connecting to a TV with a cable except for an HDMI cable, the video signals input from S VIDEO jack cannot be output to a TV.
- When connecting to S VIDEO jack, do not connect an analog video cable to VIDEO jack of the same input.

Analog video connection

Connect video devices to the unit with a video pin cable and an audio cable (any of a coaxial cable, an optical cable and stereo pin cable.) Input jacks of the unit (AV3-6) are different depending on the audio input jacks of the video devices.

Output jack of video device		Input jacks of the unit	
Video	Audio		
Analog video	Coaxial	AV3 (VIDEO + COAXIAL)	
	Optical	AV4 (VIDEO + OPTICAL)	
	Analog stereo		AV5 (VIDEO + AUDIO)
			AV6 (VIDEO + AUDIO)

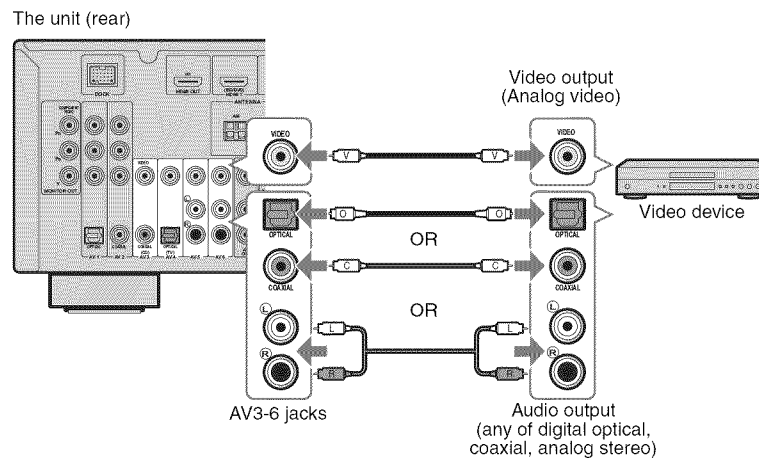

By selecting input source with the AV3-6 key, audio and video of video devices are output from the unit.

Change the combination of input jacks (video/audio)

When an input jack of the unit does not match an output jack of a video device, select another jack of the unit to match the jack of the video device. The Following connections become available with this setting.

Output jacks of a video device		Input jacks of the unit	
Video	Audio	Video	Audio
HDMI	Optical	HDMI 1-5	AV1 (OPTICAL) AV4 (OPTICAL)
	Coaxial	HDMI 1-5	AV2-3 (COAXIAL)
	Analog stereo	HDMI 1-5	AV5-6 (AUDIO) AUDIO
Component video	Analog stereo	AV1-2 (COMPONENT VIDEO)	AV5-6 (AUDIO) AUDIO

Necessary settings

As an example, the setting for connections, for which AV2 (COMPONENT VIDEO) jack is used for video signals and AV5 (AUDIO) jacks are used for audio signals, is shown below.

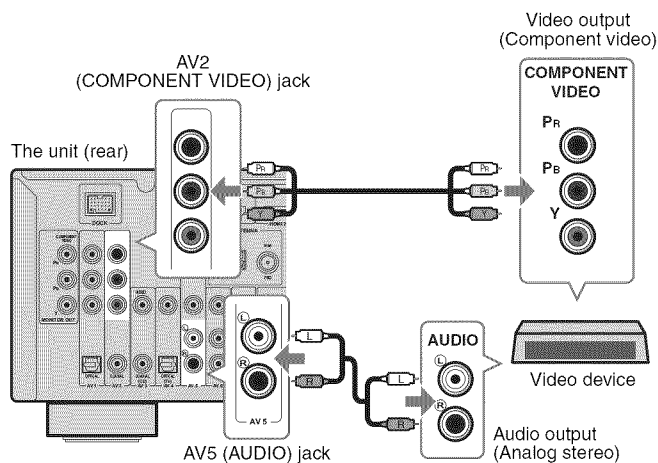

- 1 Complete the connections for external devices (such as a TV and playback device), the power cable and so on, and then turn on the unit and the TV.
- 2 Change the input source setting of the TV to the video from the unit.
- 3 Press AV2 to select “AV2” as the video input jack of the unit.
- 4 Press OPTION.



- 5 Press the cursor keys (Δ/▽) repeatedly to select “Audio In.”



- 6 Press ENTER.



- 7 Press the cursor keys (◀/▶) repeatedly to select “AV5” as the input source.



Input sources

HDMI1-5, AV1-2

Settings

HDMI1-5, AV1-6, AUDIO

- 8 Press OPTION.

All settings have been completed.

When switching the input source to “AV2” with the AV2 key, video and audio from the video device are output from the unit.

Connecting audio devices (such as a CD player)

Connect audio devices (such as a CD player, MD player and so on) to the unit. Select a correct connection depending on the output jacks of the audio devices connected to the unit.

Audio output jack of audio device	Audio input jack of the unit
Optical	AV1 (OPTICAL) AV4 (OPTICAL)
Coaxial	AV2-3 (COAXIAL)
Analog stereo	AV5-6 (AUDIO) AUDIO

The unit (rear)

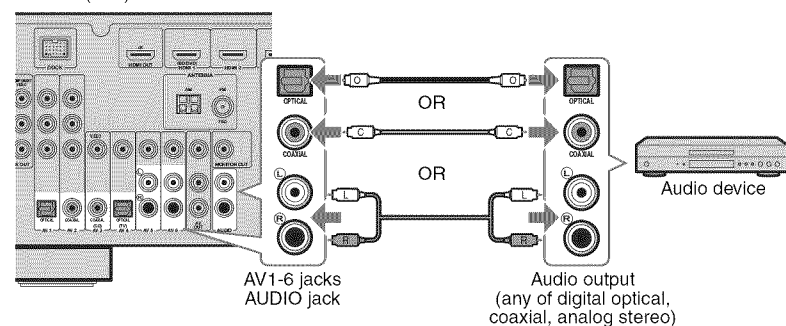

By selecting an input source with the AV1-6 key and AUDIO key, audio from audio devices is output from the unit.

Connecting to the jack on the front panel

Use the VIDEO AUX jacks on the front panel to temporarily connect devices such as a video camera and a game console. Be sure to stop the device and turn down the volume before connecting it to the unit.

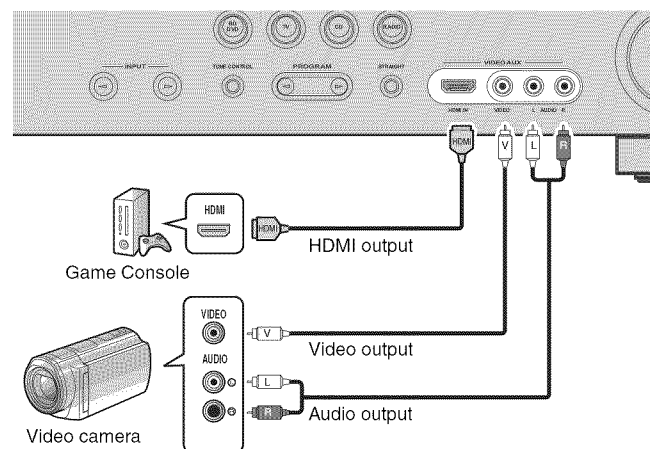

By selecting input source as "V-AUX" with the V-AUX key, audio and video from the connected device are output from the unit.



- When both the HDMI jack and the analog video/audio connection are connected, only the HDMI signal will be input.
- To protect against dust, attach the supplied VIDEO AUX input cover when not using this jack.

5 Connecting the FM/AM antennas

Connect supplied indoor FM antenna and an AM antenna.

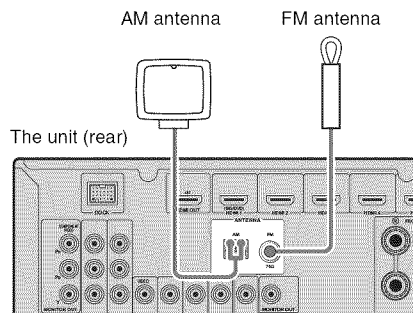

Assembling and connecting the AM antenna

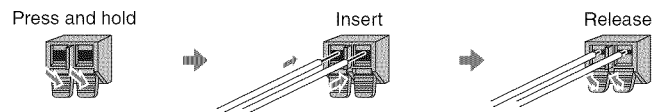
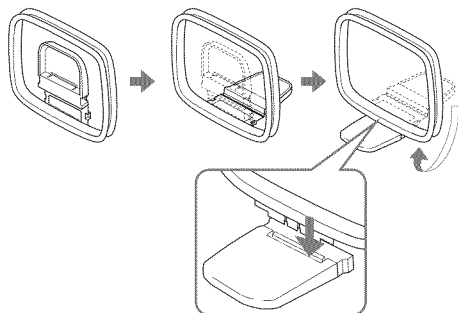

- From the AM antenna, take some wires, only the number needed for connections.
- The wires of the AM antenna have no polarity.

6 Connecting recording devices

Use AV OUT jacks to connect video and audio recording devices. Selected incoming analog audio/video signals are output through AV OUT jacks.



- When recording video/audio of the video device, use AV5-6 jacks or VIDEO AUX (VIDEO/AUDIO) jacks of the unit to connect video devices.
- When recording audio of the audio device, use any of AV5-6 jacks, AUDIO jacks or VIDEO AUX (AUDIO) jacks of the unit to connect audio devices.

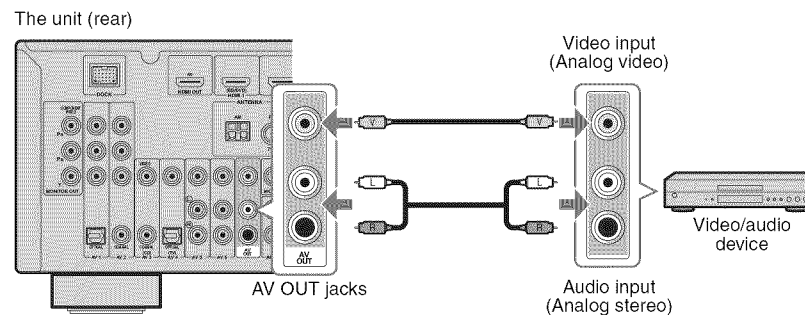

7 Connecting the power cable

Before connecting the power cable (General model only)

Set the switch position of the VOLTAGE SELECTOR according to your local voltage. Voltages are AC 110-120/220-240 V, 50/60 Hz.

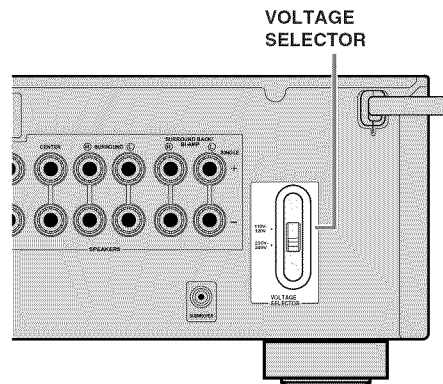

- The VOLTAGE SELECTOR on the rear panel of the unit must be set for your local voltage **BEFORE** plugging the power cable into the AC wall outlet. Improper setting of the VOLTAGE SELECTOR may cause damage to this unit and create a potential fire hazard.

After all connections are complete, connect the power plug to the outlet.

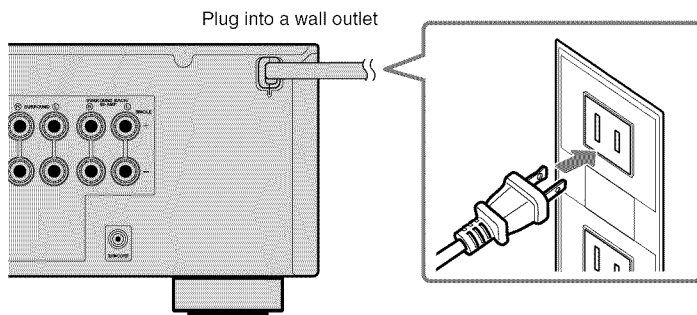

- The figure of the power plug may differ depending upon regions.

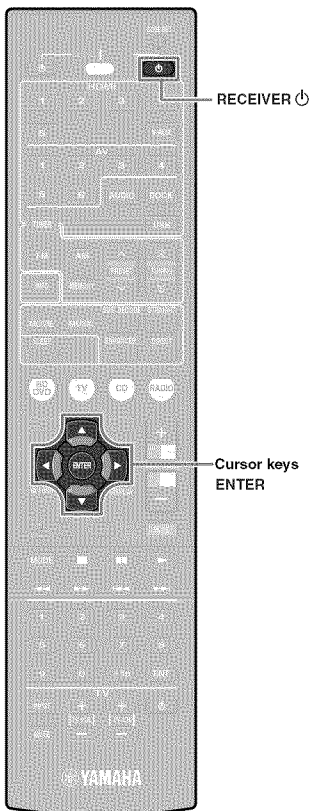

8 Optimizing the speaker settings automatically (YPAO)

The YPAO microphone (supplied) detects the status of speaker connections and the distance between these speakers and the listening position, and adjusts the volume balance and the tone settings automatically (YPAO: Yamaha Parametric room Acoustic Optimizer).



- Be aware of the following when using YPAO.
 - After completing the connection of a TV, speakers, and so on, start YPAO measurement.
 - The test tone is output at a high volume while measuring. Please take care that the test tone does not frighten any small children. Also, avoid using YPAO at night, so as to not make your neighbors troubled.
 - Keep your room quiet while measuring.
 - Do not connect headphones to the unit.
 - YPAO can be performed by viewing the front display of the unit.

Preparation before using YPAO

- 1** Press **RECEIVER** to turn on the unit.
- 2** Turn on the TV, and then select the input source of the TV to the video input from the HDMI OUT jack of the unit.
- 3** Turn on the subwoofer, and then set the volume of the subwoofer to half. The cross-over frequency is set to maximum if it is present.

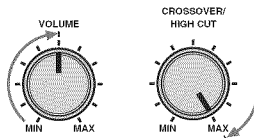

- When a subwoofer that supports the automatic standby function (turn off automatically during no signals input) is used, disable the function before going to the next step.

- 4** Set the YPAO microphone at the height of your ear in your listening position. Connect the YPAO microphone to the YPAO MIC jack on the front panel.

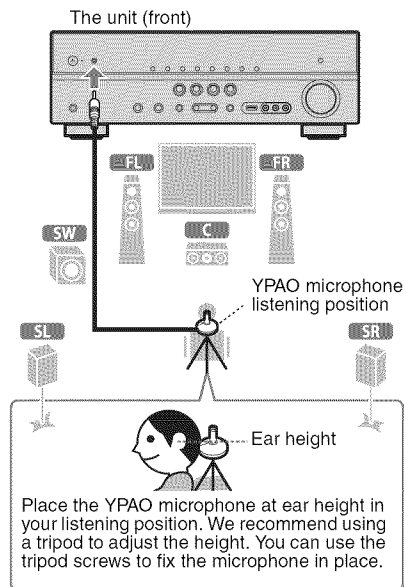

The following display appears on the TV monitor and front display.



- To cancel the measurement, disconnect the YPAO microphone before measuring or press the cursor key () to select "Exit" and press ENTER.

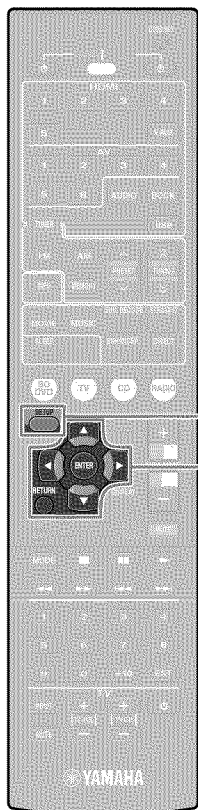

Starting the measurement

Start the measurement by following these steps.



- YPAO measurement is not performed correctly when any obstacles are in the room.
- While measuring, keep stuff in the corners or remove it from the room. It takes approximately 3 minutes to finish this measurement.

1 Confirm that “Start” is selected, and then press SETUP.

The measurement starts in 10 seconds. Press ENTER if you want to start the measurement immediately.



- To cancel the measurement, press RETURN to stop temporarily, press ENTER, select “EXIT” and then press ENTER.
- To retry the measurement from the temporary stop, select “RETRY” and then press ENTER.

The following screen appears on the TV when the measurement finishes.



- If an error message (such as “E-1:No Front SP”) or a warning message (such as “W-1:Out of Phase”) appears, refer to “Error messages” or “Warning messages” (p.32, 33).

2 Confirm that “Save / Exit” is selected and then press ENTER.



- To confirm the measurement result, select “Result.” For details, refer to the “Confirming the measurement result” (p.31).

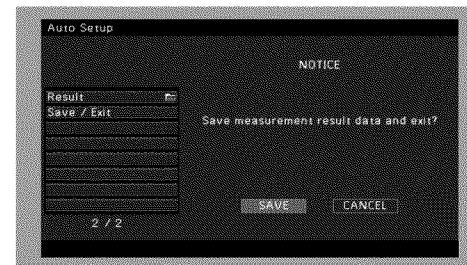

3 Confirm that “SAVE” is selected, and then press the ENTER.



- To finish the measurement without saving the result, press the cursor keys to select “CANCEL” and then press ENTER.



4 Remove the YPAO microphone.

All settings for the speakers have been completed.

CAUTION

- The YPAO microphone is sensitive to heat. Protect YPAO microphone from high temperatures (such as near AV equipment) and direct sunlight.

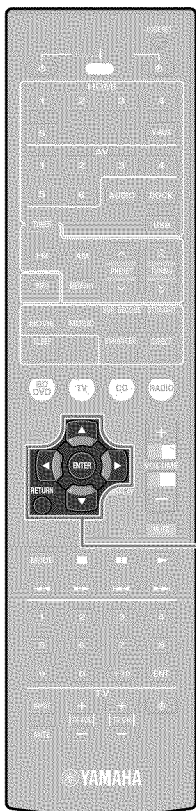

Cursor keys
ENTER
RETURN

Confirming the measurement result

Confirm the YPAO measurement result.

1 After measurement, press the cursor keys to select “Result,” and then press ENTER.

The following display appears.

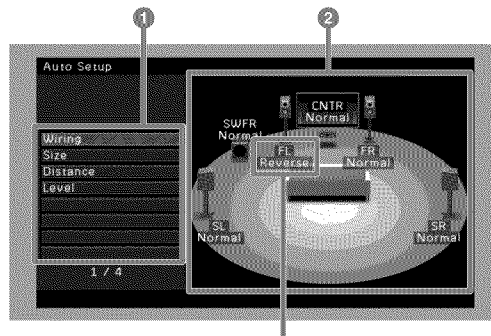

Red-boxed message indicates a speaker that has a problem.

1 Measurement items

2 Measurement result for each speaker

2 Press the cursor keys (Δ/▽) to select an item.

The red-box indicates the speaker that has a problem in the following items. For details on remedy of each problem, refer to “Warning messages” (p.33).

Wiring

Displays the condition of the polarity of each connected speaker.

“Normal”: Speakers are connected at the normal polarity. (+ and -)

“Reverse”: Speakers are connected at the opposite side of normal polarity. (+ and -)

Size

Displays the size of the connected speakers.

“Large”: The connected speaker has the ability to reproduce the low-frequency signals effectively.

“Small”: The connected speaker does not have the ability to reproduce the low-frequency signals effectively. The value displayed above “SWFR” describes the cross over frequency of the subwoofer.

Distance

Displays the distance between connected speakers and the listening position.

Level

Displays the result of the adjustment of output level of connected speakers.



- The speaker indicated with red box shows that it may have a certain problem. Check the connection or placement, and if necessary, perform YPAO again referring “Warning messages” (p.33).

3 To return the previous screen after confirmation, press ENTER or RETURN.

- **(If no problem with the result)** Press the cursor key (▽) to select “Save / Exit” and ENTER, and then confirm that “SAVE” is selected and press ENTER to finish the YPAO.
- **(If some problem with the result)** Press the cursor key (▽) to select “Save / Exit” and ENTER, and then press the cursor key (▷) to select “CANCEL” and ENTER. To restart the YPAO measurement, select “Start.” To finish the YPAO, select “Exit.”

Error messages

If any error message is displayed during the measurement, resolve the problem and perform YPAO again. Error message can be confirmed and controlled by viewing both a TV monitor and the front display.



TV monitor



Front display

■ Procedure to exit YPAO

- 1 Check the contents of error message, and then press ENTER.**
- 2 Press the cursor key (▷) to select “EXIT (Exit)” from the following choices, and then press ENTER.**
Choices: PROCEED (Proceed) (E-5, E-9 only), “RETRY (Retry),” “EXIT (Exit)”
- 3 Press the cursor key (▽) to select “Exit (Exit)” from the following choices, and then press ENTER.**
Choices: Start (Start), Exit (Exit)
- 4 Remove the YPAO microphone.**

■ Cause and remedy for each error message

Error message	Cause	Remedy
E-1:No Front SP (E-1:NO FRNT SP)	Front speakers are not detected.	Follow “Procedure to exit YPAO” to exit YPAO, turn off the unit, and then check the speaker connections. After removing problems, turn on the unit, and then perform YPAO again.
E-2:No Sur. SP (E-2:NO SUR SP)	Either of surround speakers is not detected.	
E-4:SBR→SBL (E-4:SBR->SBL)	A surround back speaker is connected to the R side only.	When using only one surround back speaker, you need to connect it to the SINGLE jack (L side). Follow “Procedure to exit YPAO” to exit YPAO, turn off the unit, and then reconnect the speaker. After reconnecting, turn on the unit, and then perform YPAO again.
E-5:Noisy (E-5:NOISY)	The noise is too loud.	Keep the room quiet and select “RETRY (Retry)” in step 2 of “Procedure to exit YPAO” to restart YPAO for an accurate measurement. Selecting “PROCEED (Proceed)” allows you to continue measuring, but may not achieve the optimal results. We recommend selecting “RETRY (Retry)” or “EXIT (Exit)” to retry YPAO again from the beginning.
E-6:Check Sur. (E-6:CHECK SUR)	Any surround back speaker is connected while no surround speakers are connected.	Surround speakers should be connected when using surround back speakers. Follow “Procedure to exit YPAO” to exit YPAO, turn off the unit, and then reconnect the speakers. After reconnecting, turn on the unit, and then perform the YPAO measurement again.
E-7:No MIC (E-7:NO MIC)	The YPAO microphone has been removed.	Connect the YPAO microphone to the YPAO MIC jack firmly and select “RETRY (Retry)” in step 2 of “Procedure to exit YPAO” to restart the measurement.
E-8:No Signal (E-8:NO SIGNAL)	The YPAO microphone cannot detect test tones.	Connect the YPAO microphone to the YPAO MIC jack firmly and select “RETRY (Retry)” in step 2 of “Procedure to exit YPAO” to restart the measurement. If this error occurs repeatedly, contact the nearest authorized Yamaha dealer or service center.
E-9:User Cancel (E-9:CANCEL)	The measurement has been canceled.	Select “PROCEED (Proceed)” in step 2 of “Procedure to exit YPAO” to resume the measurement. Select “RETRY (Retry)” to restart the measurement from first.
E-10:Internal Err. (E-10:INTERNAL)	An internal error has occurred.	Follow “Procedure to exit YPAO” to exit YPAO, turn off and on the unit. Perform YPAO again. If this error occurs repeatedly, contact the nearest authorized Yamaha dealer or service center.

Warning messages

Even if any warning message is displayed after the measurement, you can save the measurement results. However, we recommend that you perform YPAO again for the optimal speaker settings.

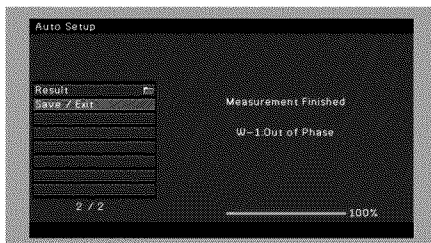

TV monitor

The speaker indicator that has a problem flashes.



Front display

Cause and remedy for each warning message

Warning message	Cause	Remedy
W-1: Out of Phase (W-1: PHASE)	Any of the speaker cables may be connected with the reversed polarity (+/-).	<ol style="list-style-type: none"> ① Check the speaker with warning (indicated with red box) in "Wiring" (p.31). ② Check the connection of the speaker with warning. ③ Press RETURN to return to the previous screen. ④ Press the cursor key (▽) to select "Save / Exit" and press ENTER. ⑤ (If some trouble): Select "EXIT (Exit)" and press ENTER. (If no trouble): Select "SAVE (Save)" and press ENTER. ⑥ Remove the YPAO microphone to finish YPAO. ⑦ (If some trouble) Turn off the unit and reconnect the speaker. After reconnecting, perform YPAO again. <p>When using the speakers that are designed with reverse polarity for better performance, this warning may appear even if the speakers are connected properly.</p>
W-2: Over Distance (W-2: DISTANCE)	Any of the speakers is placed too far from the listening position.	<ol style="list-style-type: none"> ① Check the speaker with warning (indicated with red box) in "Distance" (p.31). ② Check the placement of the speaker with warning. ③ Press RETURN to return to the previous screen. ④ Press the cursor key (▽) to select "Save / Exit" and press ENTER. ⑤ (If some trouble): Select "EXIT (Exit)" and press ENTER. (If no trouble): Select "SAVE (Save)" and press ENTER. ⑥ Remove the YPAO microphone to finish YPAO. ⑦ (If some trouble) Turn off the unit and relocate the speaker. After relocating, perform YPAO again.
W-3: Level Error (W-3: LEVEL)	There are a significant volume differences between the speakers.	<ol style="list-style-type: none"> ① Check the speaker with warning (indicated with red box) in "Level" (p.31). ② Check the connection of the speaker with warning. Also check the use environment, or the volume of the subwoofer. ③ Press RETURN to return to the previous screen. ④ Press the cursor key (▽) to select "Save / Exit" and press ENTER. ⑤ (If some trouble): Select "EXIT (Exit)" and press ENTER. (If no trouble): Select "SAVE (Save)" and press ENTER. ⑥ Remove the YPAO microphone to finish YPAO. ⑦ (If some trouble) Turn off the unit and resolve the problem. After resolving the problem, perform YPAO again. <p>We recommend using the same speakers or speakers with as similar as possible.</p>

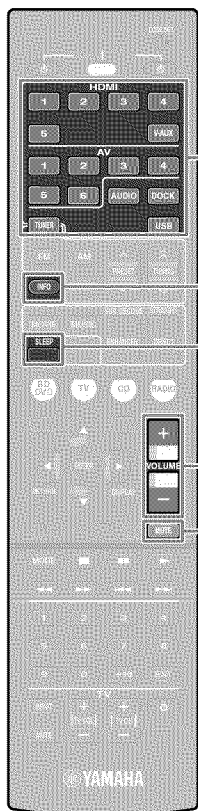

Input selection keys

INFO

SLEEP

VOLUME

MUTE

PLAYBACK

Basic playback procedure

- 1 Turn on external devices (TV, BD/DVD player, etc.) connected to the unit.
- 2 Use the Input selection keys to select the input source.
- 3 Play the external device selected as the input source, or select a radio station.
Refer to the instruction manuals provided with the external device.
For details on FM/AM tuning and playing the iPod, Bluetooth devices or USB devices, refer to the following pages.
 - Listening to FM/AM (p.41)
 - Playing back songs with iPod (p.46)
 - Playing back songs with Bluetooth devices (p.53)
 - Playing back songs with USB storage devices (p.55)
- 4 Press VOLUME to adjust the volume level.



- Press MUTE to turn the mute on. Press MUTE again to turn the mute off.
- High-frequency/low-frequency output can be adjusted in the "Option" menu (p.60) or with TONE CONTROL on the front panel (p.7).
- To correct the volume differences between each input source, adjust the parameter in "Volume Trim" of the "Option" menu (p.60).

Switching the sleep timer

Sleep timer function switches the unit to standby mode automatically after a specified period of time has elapsed. Press SLEEP on the remote control repeatedly to set the time for the sleep timer function as follows.

120 min. → 90 min. → 60 min. → 30 min. → Off



- The SLEEP indicator lights up when the sleep timer is on.

Switching the information displayed on the front display

- 1 Press INFO on the remote control or front panel repeatedly.

The information (such as the selected input, sound program, surround decoder, FM/AM frequency) displayed on the front display is switched.

Information for each input

The information displayed the front display varies depending on the selected input.

Input sources except for TUNER, DOCK (for wired iPod) and USB are selected:

Input → DSP Program → Audio Decoder

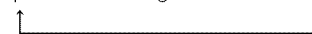

TUNER is selected:

Frequency → DSP Program → Audio Decoder

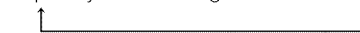

- When receiving Radio Data System (U.K. and Europe models only)

Program Service → Program Type → Radio Text → Clock Time



DOCK (for wired iPod) or USB is selected:

Song → Artist → Album → DSP Program → Audio Decoder



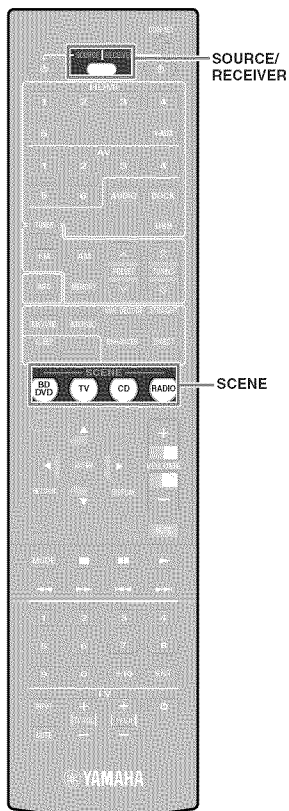

Changing input settings with a single key (SCENE function)

With the SCENE function, an input source and registered settings (the sound program/surround decoder, Compressed Music Enhancer, etc.) can be selected with a single key.

1 Press SCENE.

The registered settings on SCENE that you pressed are reflected. When the unit is in standby mode, press this key to turn it on.

Default settings for each SCENE are as follows.

SCENE	Input	Sound program/ surround decoder (p.36)	Compressed Music Enhancer (p.40)	SCENE synchronization (p.73)
BD/DVD	HDMI1	STRAIGHT	Off	On
TV	AV4	STRAIGHT	On	On
CD	AV3	STRAIGHT	Off	Off
RADIO	TUNER	7ch Stereo	On	Off

When external devices, such as a TV or BD/DVD player compatible with the HDMI control function, are connected to the unit, the HDMI control functions are enabled on the unit and the external devices and "SCENE" in the "Setup" menu is set to "On" for the corresponding SCENE, operations of the external device may be reflected by switching SCENE as follows.

- TV is turned on.
- TV is switched to a video input source that is connected to the unit.
- External device starts playback.



- The SCENE synchronization setting can be set for each SCENE. For details, refer to the "SCENE" (p.73) in the "Setup" menu.

Changing the settings for the SCENE function

1 Do the following steps to select the settings that you want to register for SCENE.

- Selecting the input source (p.34)
- Selecting the sound program (p.36)
- Enabling/disabling Compressed Music Enhancer (p.40)
- Enabling/disabling the SCENE synchronization function (p.73)

2 Press and hold SCENE on the remote control or front panel until "SET Complete" appears on the front panel.



When the input source setting of each SCENE is changed, the corresponding SCENE key setting on the remote control also needs to be changed. Refer step 3 to configure the setting for the remote control.

3 (If necessary) Press and hold the corresponding SCENE key and input selection key together for more than 3 seconds.

Once the setting is completed successfully, SOURCE/RECEIVER blinks twice.



- Apply the corresponding remote control code to the input selection key to control the playback device with the unit's remote control. For details on how to apply the remote control code, refer to "Registering remote control codes for external device operations" (p.79).

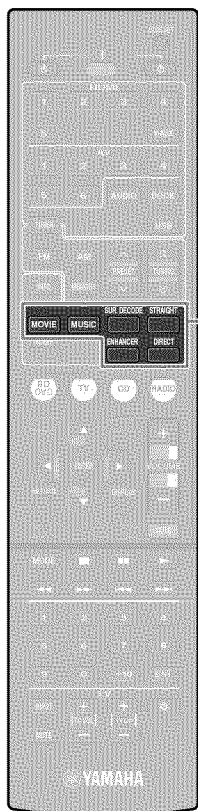

MOVIE
MUSIC
SUR.DECODE
STRAIGHT
ENHANCER
DIRECT

Enjoying the desired sound field effect

The unit is equipped with a variety of sound programs and sound decoders. Sound programs can make sounds richer, be played on the stereo and more. Choose a sound program that sounds best with the source you are playing back.

Selecting suitable sound programs for movies (p.37)

Press MOVIE repeatedly.

Selecting suitable sound programs for music or stereo playback (p.38)

Press MUSIC repeatedly.

Selecting the surround decoder (p.39)

Press SUR. DECODE repeatedly.

Switching to the straight decoding mode (p.40)

Press STRAIGHT repeatedly to switch the straight decoding mode between on and off.

Turning on the direct mode (p.40)

Press DIRECT repeatedly to switch the direct mode between on and off.

Turning on Compressed Music Enhancer (p.40)

Press ENHANCER repeatedly to switch Compressed Music Enhancer between on and off. Compressed Music Enhancer can be also switched between on and off in the "Option" menu (p.60).



- The settings for sound programs and the surround decoder can be configured in "DSP" (p.69) in the "Setup" menu.
- The sound program can be applied separately to each input.
- When playing back the audio that is DTS Express or has over a 96 kHz sampling rate, straight decoding mode (p.40) turns on automatically.
- The speaker indicator on the front display (p.8) can be used to confirm which jack is outputting audio currently.

Enjoying sound field effects (CINEMA DSP)

CINEMA DSP

This unit is equipped with a variety of sound programs that utilize Yamaha's original DSP technology (CINEMA DSP). It allows you to easily create sound fields like actual movie theaters or concert halls in your room.

Sound program categories "CINEMA DSP" lights up



Programs



- When DTS-HD Master Audio or DTS-HD High Resolution Audio is played back, it is decoded by normal DTS format.

■ Sound programs suitable for video contents (MOVIE)

Sound programs suitable for video contents, such as movies, TV programs and video games are included.

□ MOVIE

Standard	This program creates a sound field emphasizing the surround feeling without disturbing the original acoustic positioning of multi-channel audio such as Dolby Digital and DTS. It has been designed with the concept of an ideal movie theater, in which the audience is surrounded by beautiful reverberations from the left, right and rear.
Spectacle	This program represents the spectacular feeling of large-scale movie productions. It reproduces a broad theater sound field that matches cinemascope and wider-screen movies with an excellent dynamic range providing everything from very small sound effects to large, impressive sounds.
Sci-Fi	This program clearly reproduces the finely elaborated sound design of the latest science fiction and special effects-featuring movies. You can enjoy a variety of cinematographically created virtual spaces reproduced with clear separation between dialog, sound effects and background music.

Adventure

This program is ideal for precisely reproducing the sound design of action and adventure movies. The sound field restrains reverberations but puts emphasis on reproducing a powerful space expanded widely to the left and right. The reproduced depth is also restrained relatively to ensure the separation between audio channels and the clarity of the sound.

Drama

This sound field features stable reverberations that match a wide range of movie genres from serious dramas to musicals and comedies. The reverberations are modest but offer an optimum 3D feeling, reproducing effects tones and background music softly but cubically around clear words and center positioning in a way that does not fatigue the listener even after long hours of viewing.

Mono Movie

This program is provided for reproducing monaural video sources such as a classic movie in an atmosphere of a good old movie theater. The program produces the optimum expansion and reverberation to the original audio to create a comfortable space with a certain sound depth.

□ ENTERTAINMENT

Sports

This program allows the listeners to enjoy stereo sport broadcasts and studio variety programs with enriched live feeling. In sports broadcasts, the voices of the commentator and sportscaster are positioned clearly at the center while the atmosphere of the stadium expands in an optimal space to offer the listeners a feeling of presence in the stadium.

Action Game

This sound field is suitable for action games such as car racing, fighting games and FPS games. The reality of, and emphasis on, various effects makes the player feel like they are right in the middle of the action, allowing for greater concentration. Use this program in combination with Compressed Music Enhancer for a more dynamic and strong sound field.

Roleplaying Game

This sound field is suitable for role-playing and adventure games. This program adds depth to the sound field for natural and realistic reproduction of background music, special effects and dialog from a wide variety of scenes. Use this program in combination with Compressed Music Enhancer for a more clear and spatial sound field.

Music Video

This sound field offers an image of a concert hall for live performance of pop, rock and jazz music. The listener can indulge oneself in a hot live space thanks to the presence sound field that emphasizes the vividness of vocals and solo play and the beat of rhythm instruments, and to the surround sound field that reproduces the space of a big live hall.

■ Sound programs/stereo reproduction suitable for audio contents (MUSIC)

Include suitable sound programs for listening to music sources such as CDs.

□ CLASSICAL

Hall in Munich This sound field simulates a concert hall with approximately 2500 seats in Munich, using stylish wood for the interior finish as a normal standard for European concert halls. Fine, beautiful reverberations spread richly, creating a calming atmosphere. The listener's virtual seat is at the center left of the hall.

Hall in Vienna This sound program simulates an approximately 1700-seat, middle-sized concert hall with a shoebox shape that is traditional in Vienna. Pillars and ornate carvings create extremely complex reflections from all around the audience, producing a very full, rich sound.

Chamber This program creates a relatively wide space with a high ceiling like an audience hall in a palace. It offers pleasant reverberations that are suitable for courtly music and chamber music.

□ LIVE/CLUB

Cellar Club This program simulates a live venue with a low ceiling and homey atmosphere. A realistic, live sound field features powerful sound as if the listener is in a seat in front of a small stage.

The Roxy Theatre This is the sound field of a live rock music venue in Los Angeles, with approximately 460 seats. The listener's virtual seat is at the center left of the hall.

The Bottom Line This is the sound field in front of the stage in The Bottom Line, a once famous New York jazz club. The venue can seat 300 people ranging from left to right in a sound field offering real and vibrant sound.

□ STEREO

2ch Stereo Use this program to mix down multi-channel sources to 2-channels. When multi-channel signals are input, they are down mixed to 2-channels and output from the front speakers. (CINEMA DSP is not used.)

7ch Stereo Use this program to output sound from all speakers. When you playback multi-channel sources, this unit down-mixes the source to 2-channels, and then outputs the sound from all speakers. This program creates a larger sound field and is ideal for background music at parties, etc.

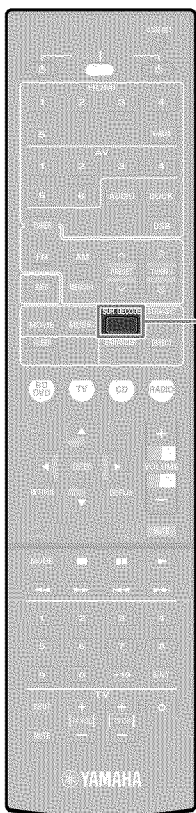

SUR.DECODE

■ Enjoying more spatial sound fields (CINEMA DSP 3D)

The CINEMA DSP 3D creates virtual speakers by using front speakers, center speakers and surround speakers, which brings you into a stereoscopic sound field.

When a sound program (except for 2ch stereo and 7ch stereo) is selected, the CINEMA DSP 3D is turned on automatically in the following situations:

- “Center” and “Surround” in the “Setup” menu are set to “Large” or “Small” (p.65).
- “CINEMA DSP 3D” in the “Setup” menu is set to “On” (p.69).

CINEMA DSP 3D indicator lights up



- When headphones are connected, the CINEMA DSP 3D is not available.

■ Enjoying sound programs without surround speakers (Virtual CINEMA DSP)

Without any surround speakers, only by using front side speakers, the unit creates virtual speakers, which recreate the sound field from the back automatically.

Select the sound program (except for 2ch stereo and 7ch stereo) when surround speakers are not connected.



- When headphones are connected, the Virtual CINEMA DSP is not available. Instead, SILENT CINEMA becomes effective (p.40).

Enjoying multi-channel sounds (surround decoder)

When using a surround decoder, audio sources can be played back with up to 7.1-channel.

For details, refer to “Glossary” (p.88).

1 Press SUR. DECODE to select a surround decoder.

By pressing SUR. DECODE repeatedly, the type of decoder changes.



<input checked="" type="checkbox"/> Pro Logic	Reproduces sound using the Dolby Pro Logic decoder. This is suitable for all kinds of audio sources.
<input checked="" type="checkbox"/> PLIIx Movie	Reproduces sound using the Dolby Pro Logic IIx (or Dolby Pro Logic II) decoder. This is suitable for movies.
<input checked="" type="checkbox"/> PLII Movie	Reproduces sound using the Dolby Pro Logic IIx (or Dolby Pro Logic II) decoder. This is suitable for music.
<input checked="" type="checkbox"/> PLIIx Music	Reproduces sound using the Dolby Pro Logic IIx (or Dolby Pro Logic II) decoder. This is suitable for music.
<input checked="" type="checkbox"/> PLII Music	Reproduces sound using the Dolby Pro Logic IIx (or Dolby Pro Logic II) decoder. This is suitable for games.
<input checked="" type="checkbox"/> PLIIx Game	Reproduces sound using the DTS Neo:6 decoder. This is suitable for movies.
<input checked="" type="checkbox"/> PLII Game	Reproduces sound using the DTS Neo:6 decoder. This is suitable for music.



- When headphones are connected or “Surround Back” is set to “None,” the Dolby Pro Logic IIx decoder is not available.

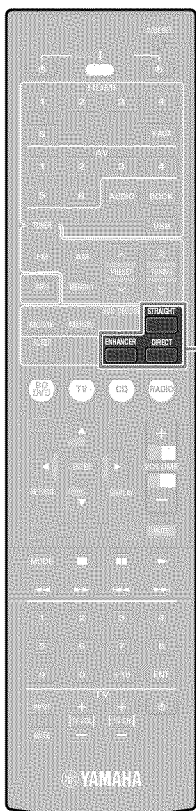

STRAIGHT
ENHANCER
DIRECT

Playback without sound field effects (straight decoding mode)

By using the straight decoding mode, sounds from each channel included in input sources are output from each speaker without sound field processing. When 2-channel sources such as CD are selected, they are played back by stereo sound through the front left and right speakers. When multi-channel playback sources are selected, they are played back without applying sound field effects, using an appropriate decoder.

1 Press STRAIGHT.

By pressing STRAIGHT repeatedly, the straight decoding mode switches to enable and disable.



Playing back fidelity sound of the selected source (direct mode)

When the direct mode is enabled, the circuitry regardless of playback (such as the front display or CINEMA DSP) is disabled to reduce noise and play back and reproduce original sound.

1 Press DIRECT.

By pressing DIRECT repeatedly, the direct mode switches to enable and disable.



- When the direct mode is enabled, there are some restrictions as follows.
 - Sound programs cannot be selected.
 - Tone control cannot be adjusted.
 - The "Option" menu and "Setup" menu cannot be operated.
 - Front display screen gets dimmer for reducing noise (during no operation).

Playing back the compressed audio dynamically (Compressed Music Enhancer)

compressed music ENHANCER

Compressed Music Enhancer improves the sound by adding depth and width and creates dynamic playback closer to the original sound. This mode can be used along with CINEMA DSP.

1 Press ENHANCER.

By pressing ENHANCER repeatedly, Compressed Music Enhancer switches to enable and disable.

Lights up when Compressed Music Enhancer is active.



- Compressed Music Enhancer is not available for the following audio formats:
 - Signals with a sampling rate over 48 kHz
 - High Definition Audio bitstream



- Compressed Music Enhancer can be also turned on/off in the "Option" menu (p.60).

Enjoying surround audio with headphones (SILENT CINEMA)



Connect headphones to the PHONES jack, and then select sound programs and surround decoders. Even when headphones are connected, you can enjoy a sound field.

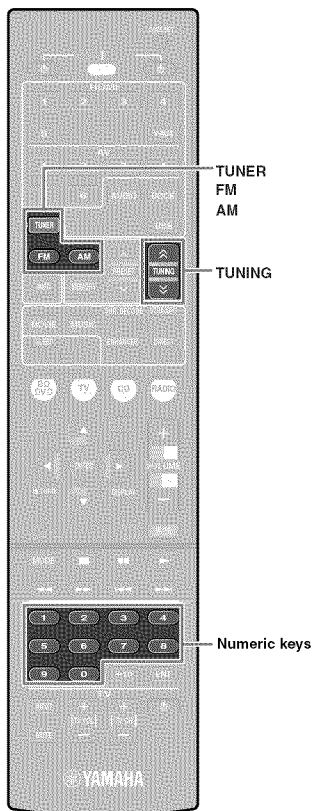

Listening to FM/AM

When tuning a radio, select a frequency or a registered station.



- To tune into the radio station, connect the antenna in advance (p.27).
- When the radio cannot get good reception, adjust the orientation of the antenna.

• FM/AM tuner frequencies will differ depending on the country or region where the unit is being used. The explanation of this section uses a display with frequencies used in U.K. and Europe models.

Changing FM/AM tuner frequency steps (Asia and General models only)

The factory pre-set FM/AM tuner frequency steps are 9 kHz for AM and 50 kHz for FM. Carry out the following settings and select the frequency steps suitable for your listening environment.

- 1 Switch this unit to the standby mode.
- 2 Press while pressing and holding STRAIGHT on the front panel.

Release the keys when "ADVANCED SETUP" (p.76) is displayed on the front display.

After approximately a few seconds, the top menu items are displayed.

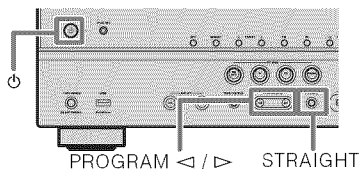

- 3 Press PROGRAM repeatedly to display "TU:"



- 4 Press STRAIGHT repeatedly to select one of the frequency steps.

- 5 Switch this unit to the standby mode, and then switch it on again.

The power turns on, with the settings you made configured.

Selecting a frequency for reception

- 1 Press TUNER to select "TUNER" as the input source.
- 2 Press FM or AM to select FM or AM to receive.



- 3 Select the frequency with the following keys.

TUNING: Selects a frequency.

Press and hold this key for approximately a second to search for a station automatically.

Numeric keys: Enter a frequency directly with numbers (For example, press "9," "8," "5" and "0" to select a station on 98.50 MHz.).



- "Wrong Station!" appears when a frequency is out of receivable range.



"TUNED" lights up when a broadcast is received from a station.

"STEREO" lights up when stereo broadcast is received from a station.

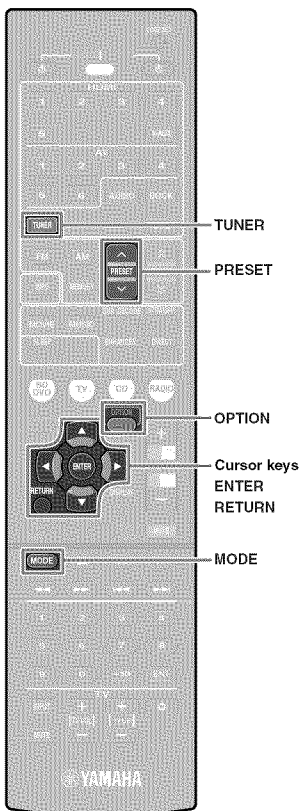

■ Receiving an FM broadcast that has a poor signal

It may be possible to receive an unstable FM broadcast by switching from stereo receiving to monaural receiving.

1 Press MODE.

By pressing MODE, the receiving mode is switched to monaural or stereo.



Registering favorite stations (Preset tuning)

Up to 40 FM/AM stations can be registered as preset stations. Registered stations can be chosen easily by selecting the preset numbers.

■ Registering FM stations automatically

Up to 40 FM stations with strong signals can be registered automatically (Auto Preset).



- AM stations cannot be registered automatically. Use manual station preset (p.43).

1 Press TUNER to select “TUNER” as the input source.

2 Press OPTION.



3 Press the cursor keys (Δ/▽) to select “Auto Preset.”



4 Press ENTER.



5 (If necessary) To change the preset number from which to start the Auto Preset function, press PRESET or the cursor keys.

Auto Preset starts in approximately 5 seconds after the preset number is selected.

When the preset number is not selected, “READY” appears on the display, and then Auto Preset starts in approximately 5 seconds.

Selecting a preset number



Currently selected preset number



- To cancel the Auto Preset, press RETURN.

During Auto Preset



During registration



When Auto Preset is completed



The “Option” menu closes automatically when registration is completed.

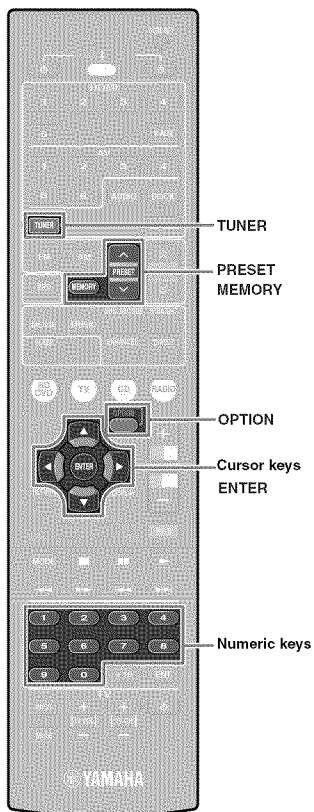

■ Registering stations manually

Select stations manually and register them to the preset numbers.

1 Tune the station that you want to register, referring to “Selecting a frequency for reception” (p.41).

2 Press MEMORY for 2 seconds or longer.

The station is registered automatically to the preset number “01” for the first registration. The station will be registered to the next preset number after the one registered most recently after the second registration.



Preset number



- To select the preset number for registration, press MEMORY once while receiving the station that you want to register. Press PRESET or numeric keys to select the preset number, and then press MEMORY again.



Empty, or the frequency currently registered

■ Selecting a registered station

Choose the station that you want to listen to from stations that are registered to the preset numbers.

1 Press TUNER to select “TUNER” as the input source.

2 Press PRESET to select the preset number.

After pressing PRESET once, numeric keys can be used for inputting the preset number (01 to 40) directly.



- When no stations are registered, “No presets” appears on the display.
- When an invalid preset number is input, “Wrong Num.” appears on the display.
- When the preset number that is not registered yet is entered, “Empty” appears on the display.

■ Clearing a registered station

Clear a radio station (preset station) registered to a preset number.

1 Press TUNER to select “TUNER” as the input source.

2 Press OPTION.



3 Press the cursor keys (Δ/∇) to display “Clear Preset.”



4 Press ENTER.



5 Press the cursor keys (Δ/∇) to select the preset number that you want to clear, and then press ENTER.

To clear multiple preset numbers, repeat the same procedure.

6 Press OPTION to finish this operation.

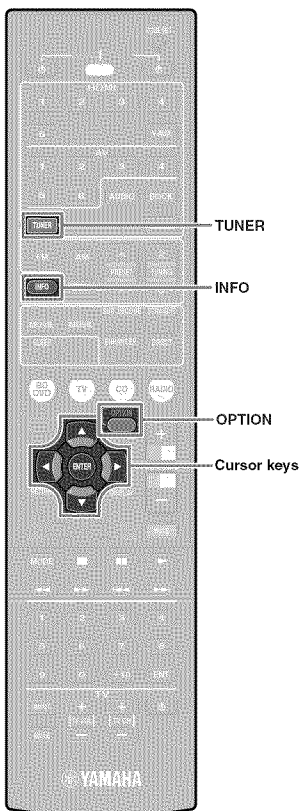

Radio Data System tuning

(U.K. and Europe models only)

Radio Data System is a data transmission system used by FM stations in many countries. This unit can receive various Radio Data System data such as “Program Service,” “Program Type,” “Radio Text,” “Clock Time” when receiving Radio Data System broadcasting stations.

■ Displaying the Radio Data System information

You can display the 4 types of the Radio Data System information: “Program Service,” “Program Type,” “Radio Text,” “Clock Time.”

1 Tune into the desired Radio Data System broadcasting station.



- We recommend that you use the automatic preset tuning to tune into the Radio Data System broadcasting stations (p.42).

2 Press INFO repeatedly until the desired information is displayed.

Information on the display changes as you press the key. The kind of information is displayed for a while and then the information is displayed.

Type of information	Description
Program Service	Displays the name of the Radio Data System program service currently being received.
Program Type	Displays the type of the Radio Data System program currently being received.
Radio Text	Displays the information on the Radio Data System program currently being received.
Clock Time	Displays the current time.
DSP Program	Displays the currently selected sound program.
Audio Decoder	Displays the currently selected surround decoder.
Frequency	Displays the received tuner frequency.

Front display (when “Program Type” selected)

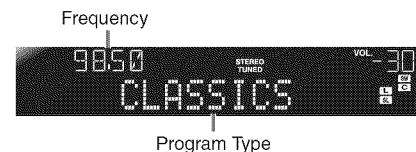

- “PTY Wait,” “RT Wait,” or “CT Wait” may appear when “Program Type,” “Radio Text,” or “Clock Time” is displayed. That shows this unit is receiving data (or stopping receiving data). If the data is receivable, the corresponding information is displayed after a while.
- “Program Service,” “Program Type,” “Radio Text” and “Clock Time” do not appear when the radio station does not provide the Radio Data System service.

■ Automatic traffic information reception

When the tuner is active, this unit can automatically search for and receive transmission from traffic information broadcast stations.

1 Press TUNER to select “TUNER” as the input source.

2 Press OPTION.



3 Press the cursor keys (Δ/▽) to select “TrafficProgram.”



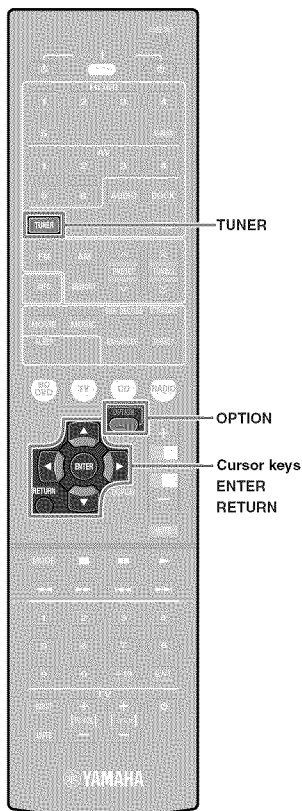

4 Press ENTER to start the search function.



The transmission search will begin upward from the current frequency in approximately 5 seconds. Or, when the status indicator reads “READY,” you can begin the search immediately by pressing ENTER.



- By pressing RETURN right before or during a search, it will return to the “Option” menu.
- When the status is “READY,” use the cursor keys (Δ/∇) to start a search in the specified direction. If no operation is performed for more than 5 seconds, a search automatically starts upward.
- Cursor key (Δ): Searches upward from the current frequency.
- Cursor key (∇): Searches downward from the current frequency.

When a traffic station is found, it will appear on the display and the “Option” menu will close.



Traffic information broadcast station (Frequency)



- If the receiver cannot find a traffic station, “TP Not Found” will appear on the display, and the “Option” menu will shortly close.

Combining audio from the radio with video from an external device

While listening to the radio, favorite videos can be output on a TV monitor.

- 1 Press TUNER to select “TUNER” as the input source, and then choose the station that you want to listen to.

- 2 Press OPTION.



- 3 Press the cursor keys (Δ/∇) to select “Video Out.”



- 4 Press ENTER.



- 5 Press the cursor keys ($\triangleleft/\triangleright$) to select the desired input video source.



Selectable video inputs

HDMI1-5	A video signal input from HDMI1-5 is output.
AV1-6	A video signal input from AV1-6 is output.
V-AUX	A video signal input from the VIDEO AUX jack on the front display panel is output. When the external devices are connected to both HDMI IN jack and VIDEO jack of the VIDEO AUX, the video signals input from the HDMI IN jack are output.
Off (default)	No video signals input from external devices is output.

- 6 Press OPTION to finish this operation.

Playing back songs with iPod

By using the USB cable supplied with iPod, optional Yamaha iPod universal dock (such as YDS-12) or optional Yamaha iPod wireless system (YID-W10), play back songs from connected iPod with the unit.



- In this manual, both iPod and iPhone are collectively represented as "iPod." When there is no explanation that is specific to either of them, "iPod" means both iPod and iPhone.
- Some functions may not be available depending on types or versions of iPod, or depending on types of docks.

Functional differences depending on the way of connection

	USB cable supplied with iPod	Yamaha iPod universal dock (such as YDS-12)	Yamaha iPod wireless system (YID-W10)
Audio output	✓	✓	✓
Video output	—	✓	—
Operation with remote control of the unit	✓	✓	—
Operation with iPod	✓	✓	✓
Operation on TV monitor	✓	✓	—
Charging	✓	✓	✓
Charging during standby mode	—	✓	✓
Supported iPod	iPod touch iPod nano (2 gen. to 6 gen.) iPod classic iPhone 4 iPhone 3GS iPhone 3G iPhone	iPod touch iPod nano iPod classic iPod with video iPod with color display iPod with click wheel iPod mini iPhone 4 iPhone 3GS iPhone 3G iPhone	iPod touch iPod nano iPod classic iPod with video iPhone 4 iPhone 3GS iPhone 3G iPhone

Connecting an iPod

■ Using a USB cable to connect an iPod

Connect the iPod to the unit with the USB cable supplied with the iPod.

Features

- Enjoying clear sounds by transmitting the digital audio signals input from iPod.
- Operating iPod using the unit's remote control.
- Displaying the content list and playback informations of the iPod on a TV monitor.

Supported iPod

iPod touch, iPod nano (2 gen. to 6 gen.), iPod classic, iPhone4, iPhone 3GS, iPhone 3G, iPhone

Procedure

Connect an iPod as follows.

- 1 Connect the USB cable to the iPod.

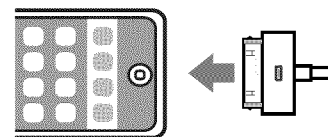

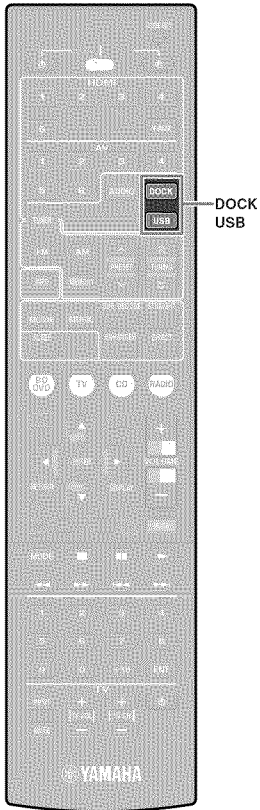

2 Connect the USB cable to the USB port on the front panel.

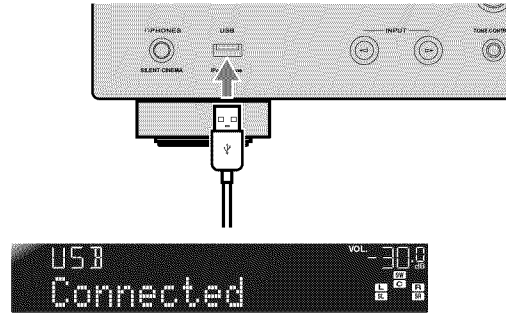

3 Press USB to select “USB” as the input source.

4 Select the content of the iPod, and then start playback.

- To operate with a TV monitor (p.49)
- To operate with iPod itself (p.52)



- Video signals cannot be output using the USB cable supplied with iPod.
- If noises are heard while using iPhone, change the position of the iPhone.

■ Using the iPod dock to connect an iPod

Connect the iPod to the unit with the optional Yamaha iPod universal dock.

Features

- Playing back not only songs but also video.
- Operating iPod using the unit's remote control.
- Displaying the content list and playback informations of the iPod on a TV monitor.

Supported iPod

iPod touch, iPod nano, iPod classic, iPod with video, iPod with color display, iPod with click wheel, iPod mini, iPhone4, iPhone 3GS, iPhone 3G, iPhone

Procedure

Connect an iPod as follows. Refer to the manual for iPod dock also.



- For connecting iPhone, use the YDS-12.

1 Turn the unit to the standby mode, and then connect the iPod dock to the DOCK jack.

Keep the iPod dock as far away from the unit as possible.

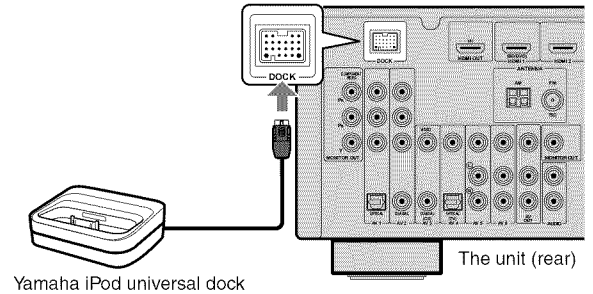

2 Connect the iPod to the iPod dock, and then turn on this unit.



3 Press DOCK to select “DOCK” as the input source.

4 Select the content of the iPod, and then start playback.

- To operate with a TV monitor (p.49)
- To operate with iPod itself (p.52)



- When the iPod is connected to the iPod dock, the iPod can be charged. You can set whether or not to charge the iPod when the unit is in the standby mode, in “Standby Charge” (p.62) on the “Option” menu.

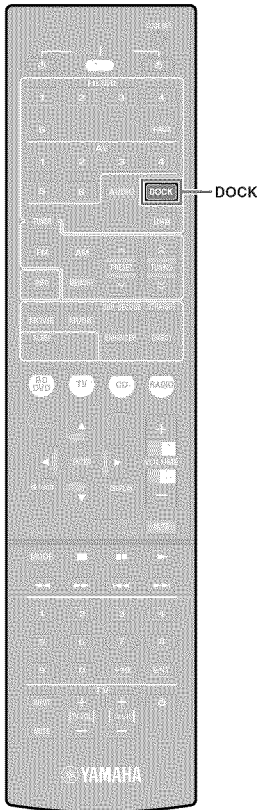

■ Using the iPod wireless system to connect an iPod

Connect the iPod to the unit with the optional Yamaha iPod wireless system.

Features

- Connecting iPod to the unit wirelessly and playing back audio source in real time without reducing the quality.
- Volume level or power-on/off operation of the unit can be linked synchronized with operations of iPod itself.

Supported iPod

iPod touch, iPod nano, iPod classic, iPod with video, iPhone4, iPhone 3GS, iPhone 3G, iPhone

Procedure

Connect an iPod as follows. The iPod can be controlled using iPod itself. Refer to the manual for iPod wireless system also.

1 Disconnect the power cable plug from the outlet, and then connect the iPod wireless system (receiver) to the DOCK jack.

Keep the iPod wireless system as far away from the unit as possible.

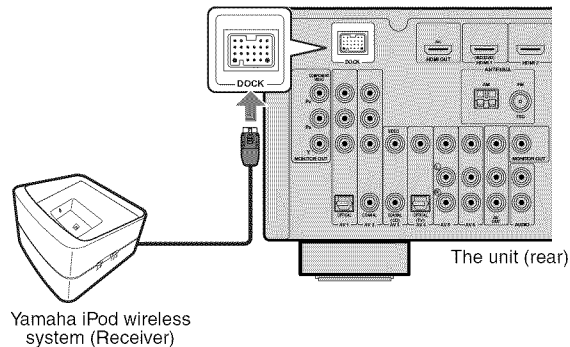

2 Connect the power cable plug to the outlet.

3 Connect the iPod to the iPod wireless system (transmitter).

Wait for a while until the following display appears on the front display.



4 Select the content with the iPod, and then start playback.

The unit turns on automatically, and then "DOCK" is selected as the input source.



- The video or content list of iPod cannot be displayed on a TV monitor.
- You can set whether operations for iPod link with operations for the unit (turning on/off, selecting input sources, and adjusting volume level) in "iPod Interlock (Interlock)" (p.62) on the "Option" menu. When the interlock function is set to "Off," operations for the unit such as turning on and selecting the input source, should be controlled manually.
- When putting a transmitter connected to the iPod on a receiver, iPod is charged automatically. You can set whether or not to charge iPod when the unit is in standby mode, in "Standby Charge" (p.62) on the "Option" menu.

CAUTION

- When using iPod to adjust the volume, the volume may be unexpectedly loud, which causes damage to the unit and speakers. In this case, remove the iPod from the iPod wireless system (transmitter) immediately. Set the restriction for the maximum volume level in "Max Volume" on "Setup" menu to prevent excessively loud playback.

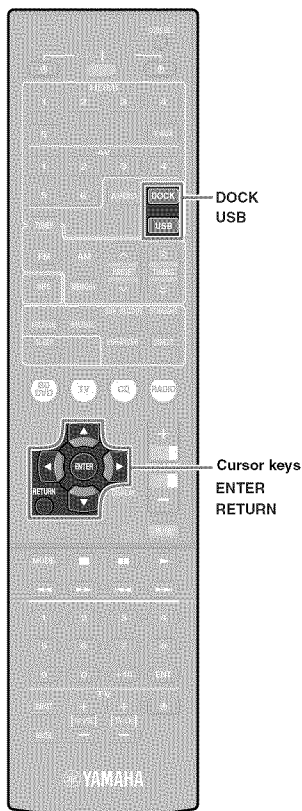

Controlling while watching a TV monitor

When connecting iPod with a USB cable or iPod dock, iPod can be controlled with the TV monitor.



- To operate an iPod on a TV monitor, connect the unit and TV with an HDMI cable, and change the input source on the TV to the video input from HDMI OUT jack of the unit before operation.
- An iPod connected to the iPod wireless system cannot be operated on a TV monitor.

1

Select the input source to which the iPod is connected.

When using the USB cable to connect the iPod:

Press USB to select “USB” as the input source.

When using the iPod dock to connect the iPod:

Press DOCK to select “DOCK” as the input source.

The following display is for the USB input source.

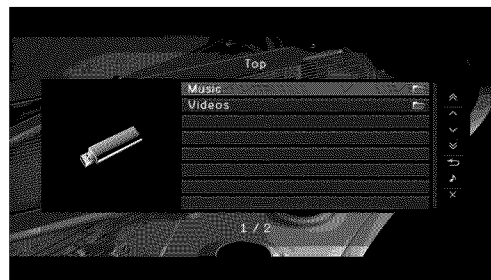

- When “No device” appears on the TV monitor, make sure that the iPod is connected to the unit properly.

2 Press the cursor keys to select the content, and then press ENTER to confirm the selection.

After selecting a song, playback starts and the Now Playing view appears.

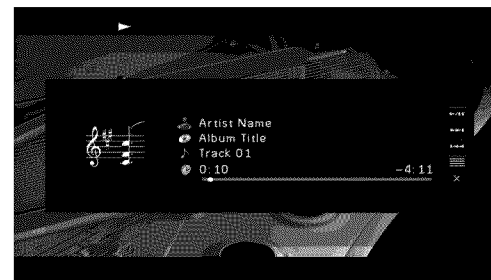

- Press RETURN or the cursor key (◀) to return to the previous screen.

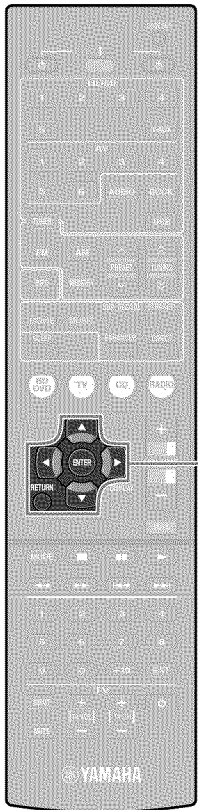

Cursor keys
ENTER
RETURN

■ Browse view

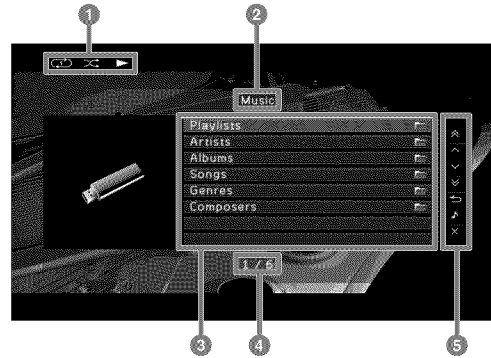

- 1 Play icon**
Settings for shuffle playback and repeat playback (p.51) and playback status (playback/pause) are displayed.
- 2 List name**
- 3 Content list**
List of iPod contents is displayed. Press the cursor keys to select the content, and then press ENTER to confirm the selection.
- 4 Current menu number/Numbers of all menu items**
- 5 Operation menu icon**
Press the cursor keys to select the item, and then press ENTER to execute the selection.

Menu	Explanation
10 Pages Up	Goes 10 pages backwards.
1 Page Up	Scrolls the list to the next or previous page.
1 Page Down	
10 Pages Down	Goes 10 pages forwards.
Return	Returns to the previous display.
Now Playing	Switches the display to the Now Playing view. When playing no contents, this menu is not available.
Screen Off	Closes the Browse view. Press ENTER or RETURN to display the Now Playing view while song or video content is being played back. If no content is being played back, the Browse view is displayed.

■ Now Playing view

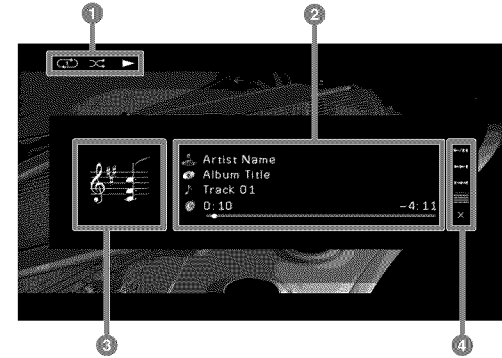

- 1 Play icon**
Settings for shuffle playback and repeat playback (p.51) and playback status (playback/pause) are displayed.
- 2 Song information**
The name of an artist, an album and a song and elapsed time/remaining time are displayed. Press the cursor keys (△/▽) to select an item to be scrolled.
- 3 Album image**
- 4 Operation menu icon**
Press the cursor keys to select the item, and then press ENTER to confirm the selection.

Menu	Explanation
Playback Control	Starts or pauses playback.
Playback Control	Skips to the beginning of the next song.
	Skips to the beginning of the song now playing, or to the song previously playing.
Browse	Switches the display to the Browse view.
Screen Off	Closes the Now Playing view. Press ENTER or RETURN to return to the Now Playing view.



- iPod can be controlled with the external device operation keys on remote control (p.51).
- If "View ON SCREEN" appears on the front display when controlling iPod viewing only the front display, press the cursor key (◀) to return to control screen.

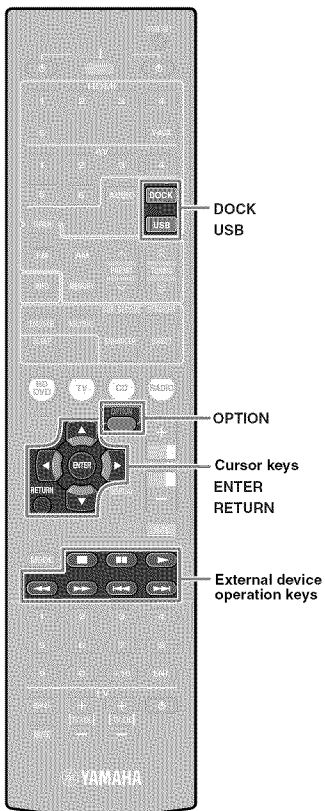

■ Controlling with the remote control

Without using “operation menu icon” on the Now Playing view, iPod can be operated directly with the remote control.

Available remote control keys	Explanations
	Starts playing back the selected song.
	Pauses playback.
	Stops playback.
External device operation keys	
	Searches backwards, while the button is pressed.
	Searches forwards, while the button is pressed.
	Skips to the beginning of the now playing song, or to the previous playing song.
	Skips to the next song.

■ Shuffle/repeat playback

Make a setting for playing iPod in random order or repeatedly.

- 1 Select “USB” or “DOCK” as the input source, and then press OPTION.



- 2 Press the cursor keys (Δ/∇) to select “Shuffle” or “Repeat.”



- 3 Press ENTER.



- Press RETURN to return to the previous display while operating the menu.

- 4 Press the cursor keys ($\triangleleft/\triangleright$) to adjust the setting.



Items	Parameters	Explanations
	Off	Turns off the shuffle function.
Shuffle	Songs	Plays back songs in random order. Shuffle icon appears on the Now Playing view (p.50).
	Albums	Plays back albums in random order. Shuffle icon appears on the Now Playing view (p.50).
Repeat	Off	Turns off the repeat function.
	One	Plays back a song repeatedly. Repeat One icon appears on the Now Playing view (p.50).
	All	Plays back all songs in a directory. Repeat All icon appears on the Now Playing view (p.50).

- 5 Press OPTION to close the menu.

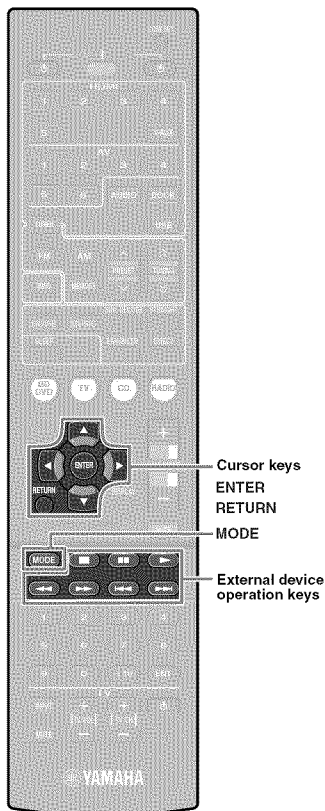

Controlling by iPod itself

Control iPod to play contents.

1 Press MODE.

The display on the TV monitor disappears, and then operations can be controlled by the iPod.







Press MODE again to return to the TV display (the Browse view.)

2 Select the content with the iPod, and then start playback.

For details on operation with the iPod, refer to the operation manual of your iPod.

■ Controlling with the remote control

iPod can be operated directly with the remote control.

Available remote control keys	Explanations
Cursor keys	Selects the content.
ENTER/ Cursor key (>)	Confirms the selected menu.
RETURN/ Cursor key (<)	Returns to the previous menu.
External device operation keys	
	Starts or pauses playing back the selected song.
	Stops playback.
	Searches backwards, while the button is pressed.
	Searches forwards, while the button is pressed.
	Skips to the beginning of the now playing song, or to the previous playing song.
	Skips to the next song.

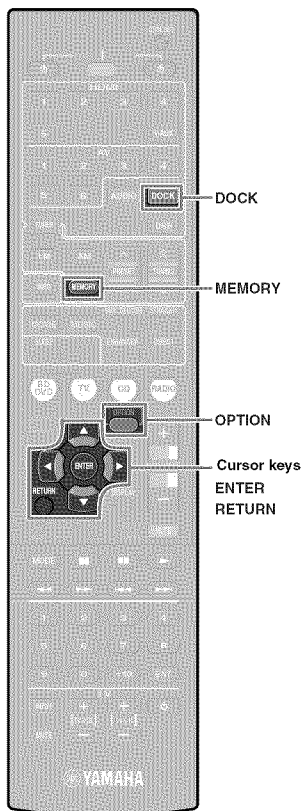

Playing back songs with Bluetooth devices

Use an optional Yamaha Bluetooth wireless audio receiver (such as YBA-10) to play back songs with Bluetooth devices. Refer to the manual for the Bluetooth receivers or your Bluetooth devices also. This unit supports A2DP (Advanced Audio Distribution Profile) Bluetooth profile.



- When connecting your Bluetooth device to a Bluetooth wireless audio receiver for the first time, it is necessary to do pairing (registration for matching two Bluetooth devices.) Once pairing is completed, communication between the Bluetooth device and the Bluetooth wireless audio receiver is established by only connecting them. Therefore, when Bluetooth devices are connected, they need to be paired with the Bluetooth wireless audio receiver.

Connecting a Bluetooth wireless audio receiver

- 1 Turn the unit to standby mode, and then connect the Bluetooth wireless audio receiver to the DOCK jack.

Keep the distance from the unit to the Bluetooth wireless audio receiver as far as possible.

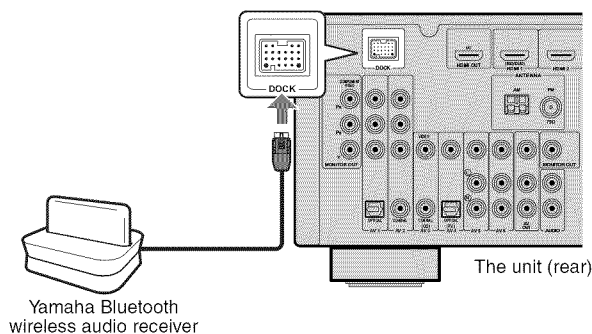

- 2 Turn on the unit.

Pairing Bluetooth devices

When your Bluetooth device is connected to a Bluetooth wireless audio receiver for the first time, or the pairing settings are deleted, it is necessary to do pairing.



- The Yamaha Bluetooth wireless audio receiver (YBA-10) can be paired with up to eight Bluetooth devices. When the ninth device is paired, the pairing setting for the device which has not been used for the longest period will be deleted.

- 1 Press DOCK to select the “DOCK” as the input source.
- 2 Turn on the Bluetooth device, and then set to the pairing mode.
- 3 Press OPTION and then press the cursor keys (Δ/∇) repeatedly to select “Pairing,” and then press ENTER.

The searching for the device starts. When the Bluetooth device recognizes the Bluetooth wireless audio receiver, the name of device (such as “YBA-10 YAMAHA”) appears on the Bluetooth device list.



- Press RETURN to cancel the searching.
- Instead of the step 3, it is also possible to press and hold MEMORY to start the searching. To cancel the searching, press MEMORY again.

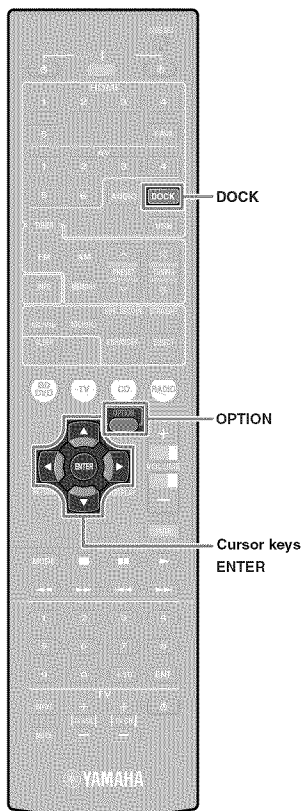

4 Select the Bluetooth wireless audio receiver from the Bluetooth device list, and then enter a pass key "0000."

When the pairing is completed, "Completed" appears.



- Depending on Bluetooth devices, "BT connected" appears after pairing. In this case, at the same time with pairing, wired connection is also completed. Therefore, only by starting playback with the Bluetooth device, audio output from the unit automatically.

5 Press OPTION to close the menu.

Playing back songs by connecting to the Bluetooth device

When pairing is completed, perform the wireless connection between the Bluetooth device and the Bluetooth wireless audio receiver. While connecting, when playback is started with the Bluetooth device, audio is output from the unit.



- Depending on the Bluetooth device, a wireless connection is established automatically by controlling the Bluetooth device. In this case, following steps from 2-3 is unnecessary.

1 Press DOCK to select "DOCK" as the input source.

2 Press OPTION.

3 Press the cursor keys (Δ/▽) repeatedly to select "Connect," and then press ENTER.

When the wireless connection is completed, "BT connected" appears.



- When some Bluetooth devices are paired with the Bluetooth wireless audio receiver, the Bluetooth device, which has the Bluetooth function enabled and was connected most recently, is automatically connected to the Bluetooth wireless audio receiver. When the device wireless audio receiver is connected to another device, disable the Bluetooth function of the device or connect them by operating Bluetooth device.
- "Not found" appears when the wireless connection is not established. Confirm the following, and then retry the connection.
 - Both the Bluetooth device and the Bluetooth wireless audio receiver are paired.
 - The Bluetooth device is turned on, and the Bluetooth function of that device is set to enable.
 - The Bluetooth device is within 10 m (32 ft.) from the Bluetooth wireless audio receiver.

4 Play back songs with the Bluetooth device.



- Select "Disconnect" in step 3 to disconnect the wireless connection.

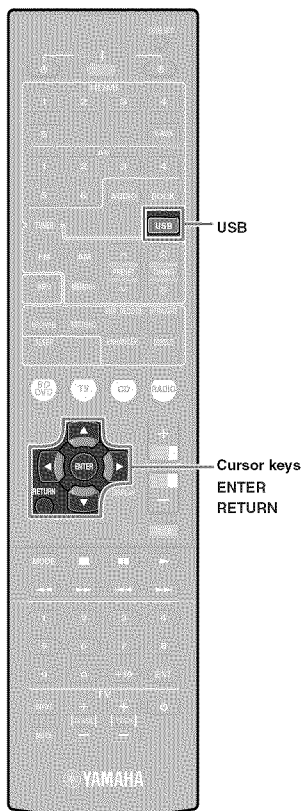

Playing back songs with USB storage devices

When a USB device is connected to the unit, audio files in the device, such as WAV (PCM format only), MP3, WMA and MPEG-4 AAC, can be played back.



- This unit is compatible with sampling frequency of up to 48 kHz for USB storage devices.

Connecting a USB storage device

This unit supports USB mass storage class devices (FAT 16 or FAT 32 format, except USB HDDs). Refer to the manual for your USB device also.

- 1 **Connect the USB storage device to the USB port on the front panel.**

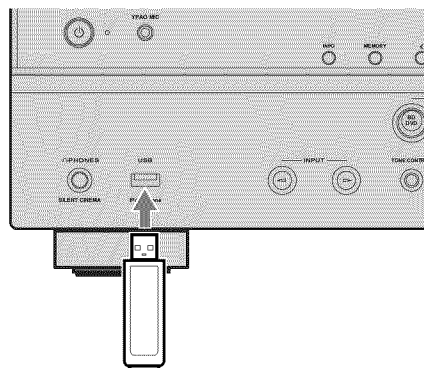

- Confirm that the USB storage device is facing the correct way when inserted into the USB port.
- For details on connecting an iPod, refer to "Using a USB cable to connect an iPod" (p.46).
- When connecting the USB storage device that contains many data files, it may take long time to load the files. During loading files, "Loading..." is displayed on the front panel and TV monitor.

Controlling while watching a TV monitor

While watching a TV monitor, selecting songs and playback are operated.



- To operate a USB storage device, connect the unit and a TV with an HDMI cable, and change the input source on the TV to the video input from HDMI OUT jack of the unit before operation.

- 1 **Press USB to select "USB" as the input source.**

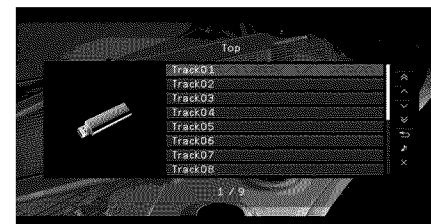

- When "No device" appears on the TV monitor, make sure that the USB storage device is connected to the unit properly.

- 2 **Press the cursor keys to select a folder (directory) or a song, and then press ENTER.**

After selecting a song, playback starts and the Now Playing view appears.



- Press RETURN or the cursor key (◀) to return to the previous screen.
- Files that are not compatible with the unit are not displayed.

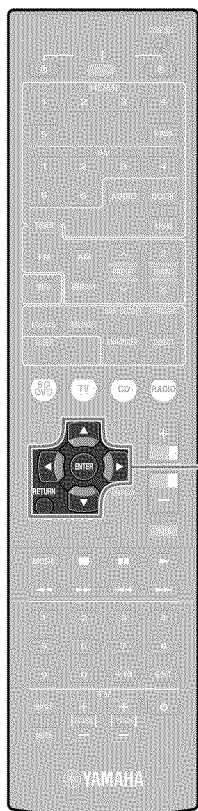

Cursor keys
ENTER
RETURN

■ Browse view

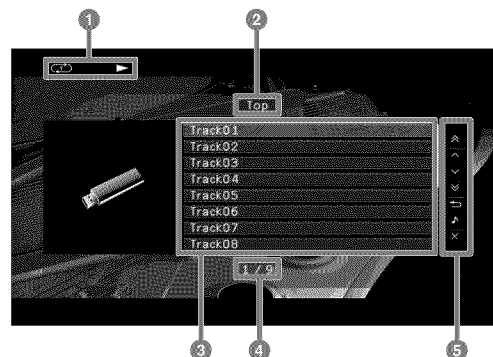

1 Play icon

Settings for random playback and repeat playback (p.57) and playback status (playback/pause) are displayed.

2 List name

3 Song list

The list of songs and folders is displayed (with up to 32 characters). Press the cursor keys to select a song, and then press ENTER to confirm the selection.

4 Current song number/Numbers of all songs

5 Operation menu icon

Press the cursor keys to select the item, and then press ENTER to confirm the selection.

Menus	Explanations
10 Pages Up	10 pages backwards.
1 Page Up	Scrolls the list to the next or previous page.
1 Page Down	
10 Pages Down	Goes 10 pages forwards.
Return	Returns to the previous display.
Now Playing	Switches the display to the Now Playing view. When playing no songs, this menu is not available.
Screen Off	Closes the Browse view. Press ENTER or RETURN to display the Now Playing view while song or video content is being played back. If no content is being played back, the Browse view is displayed.

■ Now Playing view

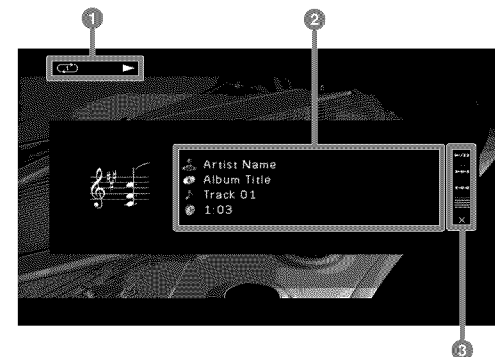

1 Play icon

Settings for random playback and repeat playback (p.57) and playback status (playback/pause) are displayed.

2 Song information

The name of an artist, an album and a song tagged with the file and elapsed time are displayed. Press the cursor keys (Δ/∇) to select an item to be scrolled.

3 Operation menu icon

Press the cursor keys to select the item, and then press ENTER to confirm the selection.

Menus	Explanations
	Starts or pauses playback.
Playback Control	Skips to the beginning of the next song.
	Skips to the beginning of the song now playing, or to the song previously playing.
Browse	Switches the display to the Browse view.
Screen Off	Closes the Now Playing view. Press ENTER or RETURN to return to the Now Playing view.



- USB devices can be controlled with the external device operation keys on remote control (p.57).
- If "View ON SCREEN" appears on the front display when controlling contents on the USB storage device viewing only the front display, press the cursor key (\langle) to return to control screen.

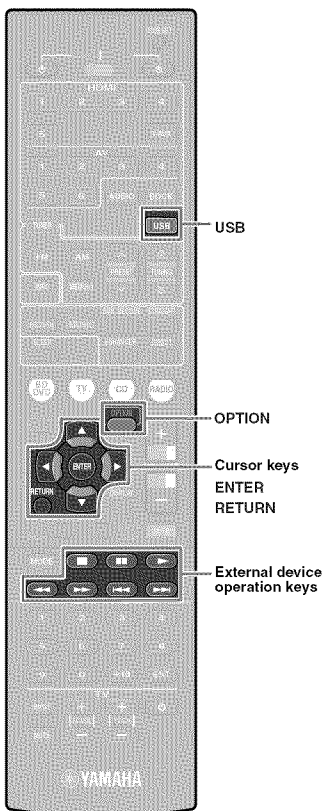

■ Controlling with the remote control

Without using the “operation menu icon” on the Now Playing view, USB devices can be operated directly with the remote control.

Enables remote control keys	Explanation
	Starts playing back the selected song.
	Pauses playback.
	Stops playback.
External device operation keys	
	Searches backwards, while the button is pressed.
	Searches forwards, while the button is pressed.
	Skips to the beginning of the song now playing, or to the song previously playing.
	Skips to the next song.

■ Repeat/random playback

Make a setting for playing a USB device repeatedly or in random order.



- When connecting an iPod with a USB cable, the settings of shuffle playback are available in addition to the repeat playback (p.51).

1 Press USB to select “USB” as the input source.

2 Press OPTION.



3 Press the cursor keys (Δ/▽) to select “Repeat.”



4 Press ENTER.



- Press RETURN to return to the previous display while operating the menu.

5 Press the cursor keys (◀/▶) to adjust the setting.



Items	Parameters	Explanations
	Off	Turns off the repeat function.
	Single	Plays back a song repeatedly. Repeat Single icon appears on the Now Playing view (p.56).
Repeat	All	Plays back all songs in a folder (directory). Repeat All icon appears on the Now Playing view (p.56).
	Random	Plays back songs in random order. Random icon appears on the Now Playing view (p.56).

6 Press OPTION to close the menu.

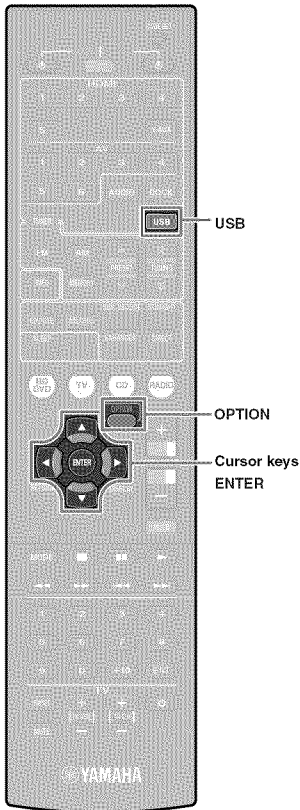

Combining a song from a USB storage device (iPod) with video from an external device

While listening to a song from a USB device, favorite videos can be output on the TV monitor.

1 Press USB to select “USB” as the input source, and then play back your desired song.

2 Press OPTION.



3 Press the cursor keys (△/▽) to select “Video Out.”



4 Press ENTER.



5 Press the cursor keys (◀/▶) to select the desired input video source.



Selectable video inputs

HDMI1-5	A video signal input from HDMI1-5 is output.
AV1-6	A video signal input from AV1-6 is output.
V-AUX	A video signal input from the VIDEO AUX jack on the front display panel is output. When the external devices are connected to both HDMI IN jack and VIDEO jack of the VIDEO AUX, the video signals input from the HDMI IN jack are output.
Off (default)	No signal is output.

6 Press OPTION to finish this operation.



- When the Browse view and Now Playing view is displayed on a TV monitor, close the screen with “.”
- “Video Out” is also available for iPod connected to the USB port.

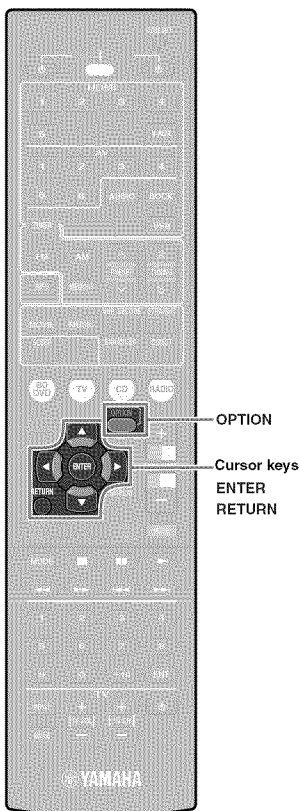

Configuring settings specific to an individual input source (Option menu)

Depending on the input source, configure settings for the function related to playback. An operation for settings is possible with only the front display without using a TV monitor. Therefore, settings can be changed easily as needed.



- To operate the "Option" menu on the TV monitor, connect the unit and a TV with an HDMI cable, and change the input source on the TV to the video input from HDMI OUT jack of the unit before operation.

1 Press OPTION.



Front display

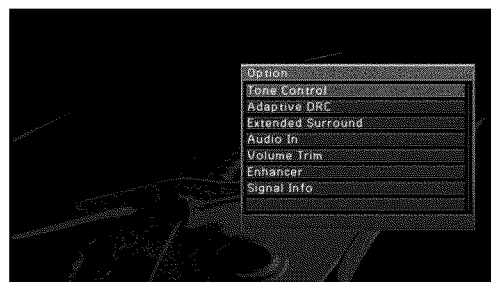

TV monitor

2 Press the cursor keys (Δ/∇) to select the desired setting, and then press ENTER.



- Press RETURN to return to the previous screen.

3 Press the cursor keys (\leftarrow/\rightarrow) to adjust the setting.

4 Press OPTION to finish the setting.

Available settings in Option menu



- Only the available settings that can be applied to the selected input are displayed.

Item	Description	Page
Tone Control	Adjusts the high-frequency range and low-frequency range of sounds.	60
Adaptive DRC	Sets whether dynamic range (from maximum to minimum) is adjusted automatically in conjunction with adjusting the volume level.	60
Enhancer	Enables/disables Compressed Music Enhancer.	60
Volume Trim	Adjusts the differences of the volume levels when switching the input source.	60
Extended Surround	Selects the 5.1 to 7.1-channel signal playback method when surround back speakers are used.	61
Signal Info	Displays information on the current video and audio signal.	61
Audio In	Combines video from the selected input source with audio input from other jacks.	25
Video Out	Combines audio of the TUNER or USB input with video from other input.	45, 58
Auto Preset	Registers FM stations with strong signals automatically in the preset numbers (up to 40).	42
Clear Preset	Deletes the registered stations.	43
Traffic Program	(U.K. and Europe models only) Automatically searches for traffic information with the Radio Data System.	44
Repeat	Sets repeat playback of an iPod or USB device.	51, 57
Shuffle	Sets shuffle playback of an iPod.	51
Standby Charge	Sets whether or not to charge an iPod while the unit is in standby mode.	62
iPod Interlock	Sets whether operations for the iPod connected to the iPod wireless audio receiver are in conjunction with operations for the unit.	62
Pairing	Pairs Bluetooth devices with the Bluetooth wireless audio receiver.	53
Connect/Disconnect	Connects or disconnects a wireless connection between Bluetooth devices with the Bluetooth wireless audio receiver.	54

■ Tone Control

Adjusts the balance of the high-frequency range (Treble) and low-frequency range (Bass) of sounds output from the front speakers. When headphones are connected, adjusts the balance of the high-frequency range and low-frequency range of sounds output from headphones.

Input sources

All (the setting is applied to all input sources)

Choices

High frequency range (Treble), Low-frequency range (Bass)

Setting range

-6.0 dB to +6.0 dB (0.5 dB increments)

Default setting

Bypass (0.0 dB)



- When you set the balance extremely off, sounds may not match those from other channels well.

The tone control can also be adjusted with the keys on the front panel (p.7).

- ① Press **TONE CONTROL** to select “Treble” or “Bass.”
- ② Press **PROGRAM** to adjust the setting.

■ Adaptive DRC

Sets whether dynamic range (from maximum to minimum) is adjusted automatically in conjunction with adjusting the volume level.

When it is set to “On,” it is useful for listening to playback at low volume at night.

Input sources

All (the setting is applied to all input sources)

Settings

Off (Default)	Does not adjust the dynamic range automatically
On	Adjusts the dynamic range automatically

When it is set to “On,” the dynamic range becomes narrow at a low level volume, and becomes wide at a high level volume.

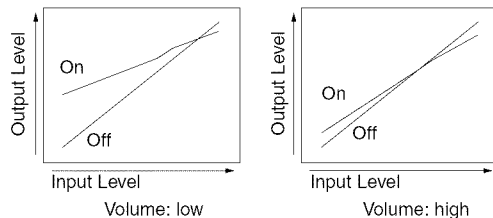

■ Enhancer

Enables/disables Compressed Music Enhancer (p.40).

Input sources

All (the setting is applied to each input source)

Settings

Off	Turns off the Compressed Music Enhancer mode.
On	Turns on the Compressed Music Enhancer mode.



- Compressed Music Enhancer can be enabled/disabled with **ENHANCER** on the remote control as well.

■ Volume Trim

Corrects the volume differences between each input source. Adjust the parameter to reduce any change in volume when switching between input sources.

Input sources

All (the setting is applied to each input source)



- Adjusted value is separately applied to the selected input.

Setting range

-6.0 dB to 6.0 dB (0.5 dB increments)

Default setting

0.0 dB

Extended Surround (EXTD Surround)

Selects the 5.1 to 7.1-channel signal playback method when surround back speakers are used.

Input sources

HDMI1-5, AV1-4, V-AUX and the input source set as a TV audio input when ARC is used

Settings

Auto (Default)	Automatically selects the most suitable decoder and reproduces the signal in 6.1 or 7.1-channel when audio including a flag for surround back channel is output. However, when the DTS or DTS-HD signal in 5.1 or 6.1-channel is input, the unit reproduces the signal in 7.1-channel despite a flag for surround back channel.
<input checked="" type="checkbox"/> PLIIx Movie <input checked="" type="checkbox"/> PLIIxMo	Always reproduces signals in 7.1-channel using the Dolby Pro Logic IIx Movie decoder. (It is available only when two surround back speakers are connected.)
<input checked="" type="checkbox"/> PLIIx Music <input checked="" type="checkbox"/> PLIIxMu	Always reproduces signals in 6.1- or 7.1-channel using the Dolby Pro Logic IIx Music decoder. (It is available when the number of connected surround back speakers is one or more.)
EX/ES	Automatically selects the most suitable decoder and always reproduces the signal in 6.1 or 7.1-channel.
Off	Always reproduces original channels.

Signal Info

Displays information on the current video and audio signals.

Input sources

HDMI1-5, AV1-4, V-AUX and the input source set as a TV audio input when ARC is used

Items

Format (FORMAT)	Audio signal format. When this unit is unable to detect a digital signal, it automatically switches to an analog input.
Channel (CHAN)	The number of source channels in the input signal (front/ surround/ LFE). For example, "3/2/0.1" means 3 front channels, 2 surround channels and LFE. If a channel that cannot be expressed as the above, a total number of channels such as "5.1ch" may be displayed.
Sampling (SAMPL)	The number of samples taken per second when converting an analog signal into a digital signal.
Bitrate (B RATE)	The number of bits passing a given point per second.
Input (V IN)	Video input signal format
Output (V OUT)	Video output signal format.
Message (V MSG)	Error messages about HDMI. This item appears only when error concerning HDMI occurs. HDCP Error (HDCP Error): The connected TV is not compliant to the High-bandwidth Digital Content Protection (HDCP). Make sure that the HDCP compliant TV is connected. Device Over (Device Over): The number of devices connected to HDMI OUT jack exceeded the limitation. Reduce the number of the connected devices.

Procedure to switch the items on the front display.

- 1 Press the cursor keys (Δ/∇) to switch the display of information on the front display.



Front display



- The list of all signal information is displayed on a TV monitor.

■ Standby Charge

Sets whether or not to charge an iPod connected to the iPod dock or iPod wireless audio receiver while the unit is in standby mode.

Input sources

DOCK (iPod)

Settings

On (Default)	Charges iPod when the unit is in standby mode.
Off	Does not charge iPod when the unit is in standby mode.



- When iPod is connected to the unit with a USB cable, iPod cannot be charged while the unit is in standby mode.

■ iPod Interlock (Interlock)

Sets whether operations for the iPod connected to the iPod wireless audio receiver are in linked with operations for the unit.

Input sources

DOCK (iPod)



- This setting is available only when the iPod wireless audio receiver is connected.

□ Power & Input (Pwr&Input)

Sets the operation for iPod related to the operation for the unit when adjusting the volume level, such as being turned on and selecting the input source.

Settings

Off	Turns off the interlock function.
On (Default)	Turns on the interlock function. When starting playback with the iPod, the unit is turned on, and then "DOCK" is selected as the input source. When a few minutes pass after playback is stopped, the unit goes into standby mode.

□ Volume

Sets whether the operation for iPod relates to the operation for the unit when adjusting the volume level.

Settings

Off	Turns off the interlock function.
On (Default)	Turns on the interlock function. When adjusting the volume level with an iPod, the volume level of the unit is also adjusted.

CONFIGURATIONS

Configuring various functions (Setup menu)

The settings of the unit can be changed from the "Setup" menu displayed on the TV screen.



- Connect the unit and a TV with an HDMI cable to display the "Setup" menu. If the TV is not connected with an HDMI cable, reconnect it with an HDMI cable.

1 Press SETUP.

When the HDMI control function is enabled on both the unit and a TV that supports the HDMI control, the TV may automatically operate as follows when SETUP is pressed.

- The TV turns on.
- The video input on the TV is switched to the HDMI input connected to the unit.
- The "Setup" menu is displayed on the TV screen.

2 Press the cursor keys (</>) to select the menu you want to configure.

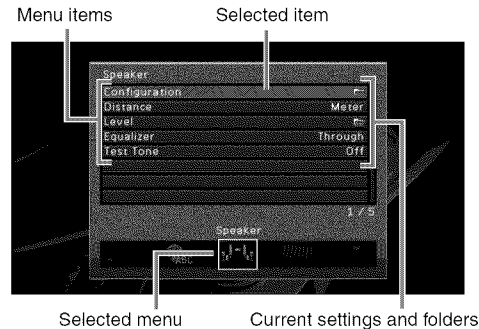

- Menus can be selected while the menu cursor is displayed (white box around the menu icon). When configuring the settings, press RETURN repeatedly to be able to select menus.
- For details on settings in the "Setup" menu, refer to the "Setup menu list" (p.64).

3 Press the cursor keys (Δ/▽) to select an item (p.64) and press ENTER.



- When pressing ENTER to select an item that has a folder icon (📁), a detail setting menu is displayed. Press RETURN to close the detail settings menu and return to the previous menu screen.

4 Press the cursor keys (Δ/▽/</>) to adjust the setting and press ENTER.

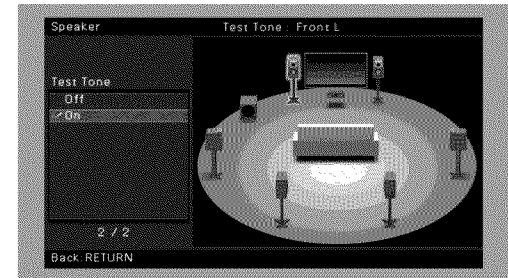

- Operation procedures vary depending on selected items. For details, refer to the directions for each setting item.

5 Press SETUP to close the "Setup" menu.

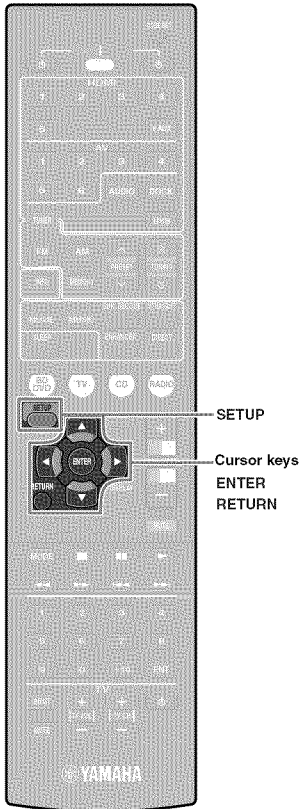

Setup menu list

Menu	Item	Description	Page		
Speaker	Front	Selects the size of the front speakers.	65		
	Center	Selects the size of the center speaker and whether or not to use the speaker.	65		
	Surround	Selects the size of the surround speakers and whether or not to use the speakers.	65		
	Configuration	Surround Back	Selects the size of the surround back speakers and whether or not to use the speakers.	65	
		Phase	Selects the phase of the subwoofer signals.	66	
		Subwoofer	Bass Cross Over	Sets the lower limit of the low-frequency component produced from speakers set to "Small."	66
			Extra Bass	Selects the speaker to produce the front channel low-frequency components.	66
		Distance	Separately adjusts the distance between each speaker and the listening position respectively.	66	
		Level	Separately adjusts the volume of each speaker.	66	
		Equalizer	Selects an equalizer type.	67	
Sound	Test Tone	Turns the test tone generator on or off.	67		
	Lipsync	Adjusts the delay between audio and video output.	68		
	Dynamic Range	Selects the dynamic range adjustment method for the audio bit stream (Dolby Digital and DTS) signal playback.	68		
	Max Volume	Specify the maximum volume level that can be adjusted by VOLUME on the remote control.	68		
	Initial Volume	Sets the initial volume for when the unit is turned on.	68		
DSP	CINEMA DSP 3D	Enables/disables CINEMA DSP 3D.	69		
	Program	Selects and adjusts a sound program and a decoder.	69		
Function	Input Rename	Changes the input source name.	71		
	Auto Power Down	Selects the amount of time after no operation is done that the unit enters standby.	71		
	Dimmer	Reduces the brightness of the front display.	71		
	Short Message	Turns the short messages displayed on the TV screen on or off.	71		
	Memory Guard	Prohibits setting changes to prevent careless changes being made to the settings of the "Setup" menu, YPAO, and SCENE.	72		
HDMI		TV Audio Input	Selects the input source that receives audio signals from a TV.	73	
	HDMI Control	ARC	Turns the Audio Return Channel function (ARC) on or off.	73	
		Standby Sync	Selects the interlocked operation of the unit when the TV is turned off.	73	
		SCENE	Selects whether or not to interlock an external device connected to this unit when selecting the appropriate SCENE.	73	
	Audio Output	Specifies where audio signal is output.	73		
	Standby Through	Specifies whether or not to transmit HDMI audio/video to the TV during standby mode.	74		
	Processing	Adjusts resolution and aspect ratio with conversion of video signal to HDMI.	74		
Language		Selects the language used for menus and messages output from the unit and displayed on the TV screen.	75		

Configuring the speaker settings (Speaker)

Adjust parameters for speakers manually.



Configuration

Adjusts the output characteristics of the speakers based on manually set parameters.



- When specifying the speaker size, set the speaker size to "Large" for each speaker with a 16 cm or larger woofer diameter, or to "Small" for a 16 cm or smaller woofer diameter.

Front

Selects the size (sound reproduction capacity) of the front speakers.

Settings

Large	Select this when large front speakers are connected.
Small (Default)	Select this when small front speakers are connected. The subwoofer will produce front channel low-frequency components.



- When "Subwoofer" is set to "None," "Large" is automatically selected.

Center

Selects the size of the center speaker and whether or not to use the speaker.

Settings

Large	Select this when a large center speaker is connected.
Small (Default)	Select this when a small center speaker is connected. The subwoofer (or front speakers) will produce center channel low-frequency components.
None	Select this when no center speaker is connected. The front speakers will produce center channel audio.

Surround

Selects the size of the surround speakers and whether or not to use the speakers.

Settings

Large	Select this when large surround speakers are connected.
Small (Default)	Select this when small surround speakers are connected. The subwoofer (or front speakers) will produce surround channel low-frequency components.
None	Select this when no surround speakers are connected. The front speakers will produce surround channel audio signals. When set to "None," the sound programs will change to Virtual CINEMA DSP mode.

Surround Back

Selects the size and number of the surround back speakers and whether or not to use the speakers.

Settings

Large x1	Select this when one large surround back speaker is connected.
Large x2	Select this when two large surround back speakers are connected.
Small x1	Select this when one small surround back speakers is connected. The subwoofer (or front speakers) will produce surround back channel low-frequency components.
Small x2 (Default)	Select this when no surround back speakers are connected. The subwoofer (or front speakers) will produce surround back channel low-frequency components.
None	Select this when no surround back speakers are connected. The surround speaker and subwoofer (or front speakers) will produce surround back channel.

Subwoofer

Set whether or not to use a subwoofer.

Settings

Use (Default)	Select this when a subwoofer is connected to the unit. During playback, the subwoofer will produce audio from the LFE (low-frequency effect) channel and bass audio from other channels.
None	Select this when no subwoofer is connected to the unit. The front speakers will produce bass frequency audio.

“Phase,” “Bass Cross Over” and “Extra Bass” can be set only when “Subwoofer” is set to “Use.”

Phase

Settings

Normal (Default)	Does not change the subwoofer phase.
Reverse	Reverses the subwoofer phase.



- If the bass audio is lacking or unclear, the audio may be improved by changing the phase of the subwoofer.

Bass Cross Over

Sets the lower limit of the low-frequency component output from speakers set to “Small.” Audio with a frequency below that limit will be produced from the subwoofer or the front speakers.

Settings

40 Hz, 60 Hz, 80 Hz (Default), 90 Hz, 100 Hz, 110 Hz, 120 Hz, 160 Hz, 200 Hz

Extra Bass

Specifies a speaker to produce the front channel low-frequency components.

Settings

Off (Default)	Depending on the size of the front speakers, either the front speakers or the subwoofer produce the front channel low-frequency components.
On	The subwoofer and the front speakers produce the front channel low-frequency components.



- When “Front” is set to “Small,” “Extra Bass” is automatically set to “Off.”

Distance

Separately adjusts the timing at which each speaker produce audio so that sounds from the speaker reach the listening position at the same time.

Submenu

Meter	Shows units of length in meters.
Feet	Shows units of length in feet.



- The default setting of units of length differs depending on your country or region.

Choices

Front L, Front R, Center, Surround L, Surround R, Surround Back L, Surround Back R, Subwoofer

Setting range

0.30 m to 24.00 m (1.0 ft to 80.0 ft) *In 0.05 m (0.2 ft) increments

Default setting

3.00 m (10.0 ft)

Level

Separately adjusts the volume of each speaker.

Choices

Front L, Front R, Center, Surround L, Surround R, Surround Back L, Surround Back R, Subwoofer

Setting range

-10.0 dB to +10.0 dB (0.5 dB increments)

Default setting

0.0 dB

■ Equalizer

Selects an equalizer type.

“YPAO:Flat,” “YPAO:Front” and “YPAO:Natural” can be set after performing YPAO.

Settings

Through (Default)	Disables the equalizer.
Graphic EQ	Uses the graphic equalizer to adjust sound quality manually. For details, refer to “Adjusting the graphic equalizer.”
YPAO:Flat	Sets uniform characteristics for each speaker.
YPAO:Front	Sets the characteristics of each speaker to match the front speakers.
YPAO:Natural	Adjusts all speaker sound to give natural acoustics.

■ Adjusting the graphic equalizer

- 1 Select “Graphic EQ” in “Equalizer,” and then press ENTER.
- 2 Press the cursor keys (Δ/∇) to select a speaker to adjust, and then press ENTER.
- 3 Press the cursor keys (\leftarrow/\rightarrow) to select a frequency you want to adjust.

Choices

63 Hz/160 Hz/400 Hz/1.0 kHz/2.5 kHz/6.3 kHz/16.0 kHz

- 4 Press the cursor keys (Δ/∇) to adjust the volume.

Setting range

-6.0 dB to +6.0 dB (0.5 dB increments)

Default setting

0.0 dB

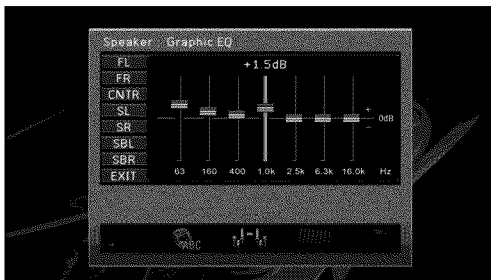

- Repeat steps 3-4 to adjust the tone to your liking.
- Press RETURN or the cursor keys (\leftarrow/\rightarrow) repeatedly to return to select a speaker to be adjusted (step 2).

- 5 Use the cursor keys (\leftarrow/\rightarrow) and select “EXIT,” and then press ENTER to finish “Equalizer.”

■ Test Tone

Turns the test tone generator on or off. When this setting is set to “On,” the volume balance settings for each speaker can be adjusted while listening to the output sound in other speaker settings (such as “Level” or “Graphic EQ”).

Settings

Off (Default)	Does not generate test tones.
On	Generates test tones. While “On” is selected, test tones are produced constantly.

Configuring the settings of audio output signals (Sound)

Configuring the settings of audio output signals.

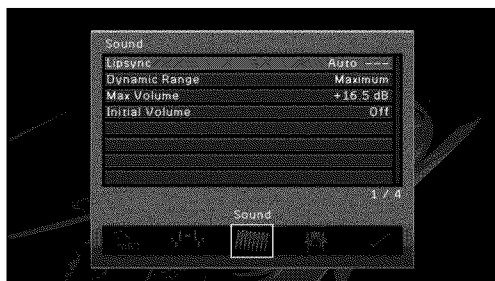

■ Lipsync

Adjusts the delay between audio and video output (Lipsync function).

Auto

When connected to a TV via HDMI, automatically adjusts audio output timing if the TV supports an automatic lipsync function. If necessary, fine adjustment of the audio output timing is possible. The difference between the result of auto delay and the fine adjustments is displayed to the right of "Offset."

Setting range

0 ms to 250 ms (1 ms increments)

Default setting

0 ms

Manual

Manually adjusts the correction time.

Setting range

0 ms to 250 ms (1 ms increments)

Default setting

0 ms

■ Dynamic Range

Selects the dynamic range adjustment method for audio bit stream (Dolby Digital and DTS) signal playback.

Settings

Maximum (Default)	Produces audio without adjusting the dynamic range.
Standard	Adjusts the dynamic range for optimum volume for regular home use. (Minimum) Sets the dynamic range suitable for low volume or a quiet environment, such as at night, for bit stream signals except for Dolby TrueHD signals.
Minimum/Auto	(Auto) Adjusts the dynamic range for Dolby TrueHD signals based on input signal information.

■ Max Volume

Specifies the maximum volume level that is adjustable with VOLUME on the remote control or VOLUME on the front panel.

Setting range

-30.0 dB to +15.0 dB (5.0 dB increments), +16.5 dB

Default setting

+16.5 dB

■ Initial Volume

Sets the initial volume for when the receiver is turned on.

Settings

Off (Default)	The volume is set at the level when the receiver last entered standby mode.
On	Makes the initial volume Mute or -80 dB to +16.5 dB (0.5 dB increments). (This setting is only available when setting a volume lower than Max Volume.)

Setting sound program and decoder parameters (DSP)

Configuring the settings of sound programs and surround decoders.



- Configurable items vary depending on the selected sound program or surround decoder.

CINEMA DSP 3D

Turns CINEMA DSP 3D (p.39) on or off. When CINEMA DSP 3D is set to On, the CINEMA DSP 3D mode automatically turns on in a sound program (except for 2ch Stereo and 7ch Stereo).

Settings

Off	Disables CINEMA DSP 3D.
On (Default)	Enables CINEMA DSP 3D.



- This setting can be set when the selected sound program supports CINEMA DSP.

Program

Select and adjust a sound program and decoder. Select a sound program of which you want to change the settings, and then set the parameters for each item. The sound program is switched at this time.

Procedure

- Press the cursor keys to select "Program" and then press ENTER.
- Press the cursor keys (Δ/∇) to select a sound program of which you want change the settings, and then press ENTER.
- Press the cursor keys (Δ/∇) to select an item of which you want to change the items, and then press ENTER.

- Press the cursor keys to adjust the parameters, and then press ENTER.
- If necessary, repeat step 3 to 4 to set other items.
- Press SETUP to finish "Program."



- For details on sound program, refer to "Enjoying the desired sound field effect" (p.36).
- Selectable items vary depending on the selected sound program or decoder.

2ch Stereo

Item	Description	Setting
Direct	Automatically bypasses the DSP circuit and tone control circuit depending on the condition of tone control etc., when an analog audio source is played back.	Auto (Default), Off "Auto" outputs sound by bypassing the DSP circuit and tone control circuit in the following situations. <ul style="list-style-type: none"> Tone controls of "Bass" and "Treble" are set to 0 dB (p.60). "Equalizer" is set to "Through" (p.67). "Adaptive DRC" is set to "Off" (p.60).

7ch Stereo

Item	Description	Setting
Center Level	Adjusts the center channel volume.	
Surround L Level	Adjusts the volume of the surround L channel.	0% to 100% (Default: 100%)
Surround R Level	Adjusts the volume of the surround R channel.	
Surround Back Level	Adjusts the volume of the surround back channel.	0% to 100% (Default: 50%)
Surround Back L Level	Adjusts the volume of the surround back L channel.	
Surround Back R Level	Adjusts the volume of the surround back R channel.	0% to 100% (Default: 30%)
Reset	Initializes the level of each speaker.	OK, CANCEL Press the cursor keys ($\triangleleft/\triangleright$) to select "OK," and then press ENTER to initialize all level settings.



- Selectable items in "7ch Stereo" vary depending on types of speakers connected to the unit.

Category: MUSIC (except 2ch Stereo and 7ch Stereo)

Sound programs

Hall in Munich, Hall in Vienna, Chamber, Cellar Club, The Roxy Theatre, The Bottom Line

Item	Description	Setting
DSP Level	Changes the effect level (level of the sound field effect to be added).	-6 dB to +3 dB (Default: 0 dB) The higher the value is, the stronger the effect level is output. The lower the value is, the smaller the effect level is output.

Category: MOVIE

Sound programs

Sports, Action Game, Roleplaying Game, Music Video, Standard, Spectacle, Sci-Fi, Adventure, Drama, Mono Movie

Item	Description	Setting
Decode Type	Select a decoder to play back sources combined with a sound program.	<input type="checkbox"/> PLIIX Movie (<input type="checkbox"/> PLII Movie), Neo:6 Cinema
DSP Level	Changes the effect level (level of the sound field effect to be added).	-6 dB to +3 dB (Default: 0 dB) The higher the value is, the stronger the effect level is output. The lower the value is, the smaller the effect level is output.



- “Decode Type” is only available when selecting “Standard,” “Spectacle,” “Sci-Fi,” “Adventure” and “Drama.”

SUR. DECODE

Item	Description	Setting
Decode Type	Select a decoder to play back sources	<input type="checkbox"/> Pro Logic, <input type="checkbox"/> PLIIX Movie (<input type="checkbox"/> PLII Movie), <input type="checkbox"/> PLIIX Music (<input type="checkbox"/> PLII Music), <input type="checkbox"/> PLIIX Game (<input type="checkbox"/> PLII Game), Neo:6 Cinema, Neo:6 Music
Reset	Initializes the settings of “SUR.DECODE.”	OK, CANCEL Press the cursor keys (</>) to select “OK,” and then press ENTER to initialize the settings.

When selecting “ PLIIX Music (PLII Music)” or “Neo:6 Music” in the “Decode Type,” the following settings can be set.

When “ PLIIX Music (PLII Music)” is selected:

Item	Description	Setting
Panorama	Adjusts the soundscape of the front sound field.	Off (Default), On When set to “On,” front left/right channels sounds are sent to the surround speakers as well as the front speakers for a wraparound effect.
Center Width	Spreads the center channel sound to the front left and right speakers to suit your needs or preferences.	0 to 7 (Default: 3) The higher the value is, the broader the center channel is output. The lower the value is, the narrower the center channel is output.
Dimension	Adjusts the difference in level between the front sound field and the surround sound field.	-3 to +3 (Default: 0) The higher the value is, the stronger the front sound field is. The lower the value is, the stronger the surround sound field is.

When “Neo:6 Music” is selected:

Item	Description	Setting
Center Image	Adjusts the front left and right channel output relative to the center channel to make the center channel more or less dominant as necessary.	0.0 to 1.0 (Default: 0.3) The higher the value is, the stronger the center channel is and the narrower the center width is. The lower the value is, the weaker the center channel is and the broader the center width is.

Configuring the various settings (Function)

Set the various features that have handy functions.



■ Input Rename

Changes the input name displayed on the front display and TV screen.

Input

All inputs except for TUNER

■ Procedure

- 1 Select "Input Rename," and press ENTER.
- 2 Press the cursor keys (Δ/∇) to select a name which you want to rename, and then press ENTER.
- 3 Press the cursor keys (Δ/∇) to select a preset name to your liking, and then press ENTER.

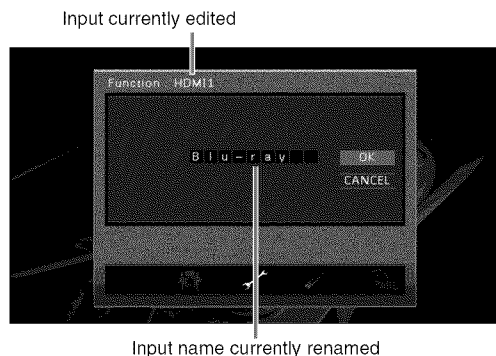

- 4 (To confirm the selected name) Press ENTER.
(To rename the selected name) Press the cursor keys ($\triangleleft/\triangleright$) to select a character that you want to change, and then press the cursor keys (Δ/∇) to change the character.

- 5 Press the cursor keys ($\triangleleft/\triangleright$) to select "OK," and then press ENTER.
- 6 To change other input names, repeat step 2 to 5.
- 7 Press SETUP to close "Input Rename."



- Select "CANCEL" in step 5 to return to the previous screen without confirming the name changed.

■ Auto Power Down

If you do not operate the unit or use the remote control for an extended period of time, it will automatically go into standby mode (Auto Power Down function).

Settings

Off	Auto Power Down function is disabled.
4Hours, 8Hours, 12Hours	Goes into standby mode, when you have not operated the unit for the selected amount time. A countdown of 30 seconds is displayed on the front display before entering the standby mode.

Default setting

8Hours (U.K. and Europe models)
Off (Other models)

■ Dimmer

Sets the brightness of the front display.

Setting range

-4 to 0 (The higher the value the brighter the display.)

Default setting

0

■ Short Message

Turns the short message displayed on the TV screen on or off. For example, this settings is set to "Off" to prevent that the subscription of video images is got behind the short message.

Settings

Off	Does not display the short message on the TV screen.
On (Default)	Displays the short message on the TV screen. When the output video signals are being upscalled, the short message may not be displayed.

■ Memory Guard

Prohibits setting changes to prevent careless changes being made to the settings of the "Setup" menu, YPAO, and SCENE.

Settings

Off (Default)	Settings are not protected.
On	Prohibits changes to the settings in the "Setup" menu until it is returned to "Off." During memory guard, the protection icon (🔒) is displayed at upper right on the TV monitor.



- If you try to set the protected items, "Memory Guard! (Memory Guard!)" is displayed on the front display and TV monitor.

Setting HDMI functions (HDMI)

Set the settings on HDMI functions.



■ HDMI Control

Enable or disable the HDMI control (p.92).

Settings

Off (Default)	Disables the HDMI control function.
On	Enables the HDMI control function.

When "HDMI Control" is set to "On," "TV Audio Input," "ARC," "Standby Sync" and "SCENE" can be set.



- When "HDMI Control" is set to "On," "Audio Output" (p.73) or "Standby Through" (p.74) is automatically fixed to "Control Sync" and cannot be set manually.

TV Audio Input

Select the input source that receives audio signals from TV while the HDMI Control function is on. When using a TV that supports the Audio Return Channel function and the function is enabled, the audio input for the TV is assigned to the input source selected here.

Settings

AV1-6	The selected input source between AV1 to 6 receives audio signals from TV.
AUDIO	AUDIO receives audio signals from TV.

Default setting

AV4



- While "ARC" is set to "On," the input source selected here is used for TV audio input. Therefore, the jack selected for the input source on the rear of the unit cannot be used.

ARC

Enable or disable ARC (Audio Return Channel) (p.18).

Settings

Off	Disables ARC (Audio Return Channel function).
On (Default)	Enables ARC (Audio Return Channel function).

Standby Sync

Specify whether or not to turn off the unit automatically when the TV connected to the unit with HDMI cable turns off.

Settings

Off	Does not turn off the unit when the TV is turned off.
On	Always turns off the unit when the TV is turned off.
Auto (Default)	In a case of the followings, the unit turns off by interlocking power-off of the TV: <ul style="list-style-type: none">Watching the TV (input source is set to AV4.)Using HDMI devices (input source is set to HDMI, and the device connected to HDMI jack is being played.)



- "Standby Sync" is available only if your TV is compatible with the HDMI control function.

SCENE

Specify whether or not a TV or external device (such as a BD/DVD player) connected to the unit is operated by interlocking by pressing SCENE.

Choices

BD/DVD, TV, CD, RADIO

Settings

Off	Does not synchronize the external device with SCENE.
On	Synchronizes the external device when pressing the appropriate SCENE.

Default setting

On (BD/DVD, TV)

Off (CD, RADIO)



- When this item is set to "On" and the external devices that are compatible with the HDMI control function (with some exceptions) are connected to the unit, the SCENE synchronization is activated (p.35).

Audio Output

Choose whether audio is played back through the unit or through a TV.

Amp

Specify whether or not audio signals are output through the unit.

Settings

Off	Audio is not output from speakers.
On (Default)	Audio is output from speakers.

HDMI OUT (TV)

Specify whether or not audio signals are output through a TV connected via the HDMI OUT jack.

Settings

Off (Default)	Audio is not output from the TV.
On	Audio is output from the TV.



- When "HDMI Control" is set to "On," "Audio Output" is automatically fixed to "Control Sync" and cannot be set manually.

■ Standby Through

Specify whether or not audio/video signals from HDMI inputs are to continue to be transmitted to a TV when the unit is in standby mode.

Settings

Off (Default)	Does not output HDMI signals to a TV.
On	Outputs HDMI signals to a TV (1 to 3 W power consumption)



- When “HDMI Control” is set to “On,” “Standby Through” is automatically fixed to “Control Sync” and cannot be set manually.
- While “Standby Through” is activated, the standby indicator on the front panel lights up.
- While “Standby Through” is activated, the input source can be switched between HDMI1-5 and V-AUX (HDMI) with the remote control. The standby indicator on the front panel flashes twice in response.

■ Processing

Specifies whether or not to adjust resolution and aspect ratio with the conversion of video input to HDMI video (upscaling).

Settings

Off (Default)	Does not adjust resolution and aspect ratio of video signals.
On	Adjusts resolution and aspect ratio of video signals. The each parameter can be set in the following “Resolution” and “Aspect.”



- Analog video signals can be converted and output to HDMI video despite the setting in this item.

□ Resolution

Select the resolution of HDMI output video signals. For details on conversion of video resolution, refer to “Video conversion table” (p.91).

Settings

Through	No upscaling.
Auto (Default)	Automatic upscaling in accordance with TV resolution.
480p/576p, 720p, 1080i, 1080p	Upscaling to the selected resolution. (Only resolutions that the TV supports can be selected.)

■ Procedure

- 1 Press the cursor keys (Δ/∇) to select a setting.
- 2 Press ENTER to confirm the selection.



- Only 480i/576i and 480p/576p-resolution video signals can be upscalled (p.91).
- When a resolution that is not supported by the TV needs to be selected, set “MON.CHK” in the “ADVANCED SETUP” menu to “SKIP” to select the all resolutions (p.77). Please note that selecting the resolution that the TV does not support may cause a black screen on the TV monitor.

□ Aspect

Select the aspect ratio of HDMI output video signals.

Settings

Through (Default)	Does not adjust the aspect ratio.
16:9 Normal	Converts 4:3 aspect ratio video signals to a 16:9 TV with black bands on either side of the screen.

Setting the language displayed on the TV screen (Language)

Selecting the language displayed on the TV screen.



Settings

English (Default)	English
日本語	Japanese
Français	French
Deutsch	German
Español	Spanish
Русский	Russian



- Only English is displayed on the front display.
- Even if selecting a language in this item, the characters contained in the name of file, folder and song cannot be displayed in the selected language.

Configuring the system settings of the unit (ADVANCED SETUP menu)

Operating the ADVANCED SETUP menu

Looking at the front display to configure the system settings of the unit.

- 1 Switch the unit to the standby mode if the unit is turned on.
- 2 Press  while pressing and holding STRAIGHT on the front panel.

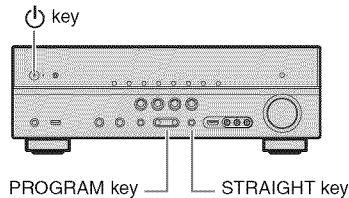

- 3 Press PROGRAM to select the item.
- 4 Press STRAIGHT to select the value.
- 5 Press  to switch the unit to the standby mode, and then switch it on again.

The settings become effective and the unit is turned on.

Features of the ADVANCED SETUP menu

Items	Descriptions
SP IMP.	(U.S.A. and Canada models only) Sets the impedance of speakers.
REMOTE ID	Changes the remote control ID of a receiver.
BI-AMP	Switches the bi-amp connections on or off.
TV FORMAT	Specifies the TV's color encoding format.
MON.CHK	Removes the up-scaling limitation on HDMI video output.
TU	(Asia and General models only) Selects one of the following FM/AM frequency steps.
INIT	Initializes various settings for the unit.

Changing the speaker impedance (U.S.A. and Canada models only)

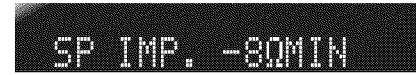

Changes the unit settings depending on the impedance of the speakers connected.

Settings

6ΩMIN	Select the impedance when 6Ω speakers are connected.
8ΩMIN (Default)	Select the impedance when speakers above 8Ω are connected.

Changing the remote control ID



The remote control of the unit can only receive signals from a receiver which has an identical ID (remote control ID). When using multiple Yamaha AV receivers, you can set each remote control with a unique remote control ID for its corresponding receiver.

Settings

ID1 (Default), ID2

■ To change the remote control ID of the remote control

Perform each of the following steps within 1 minute. Settings will be automatically stopped if more than 1 minute passes since the last operation.

- 1 Press CODE SET on the remote control using a pointed object such as the tip of a ballpoint pen.
- 2 Press SOURCE/RECEIVER.
- 3 Enter "5019" (to switch to ID1) or "5020" (to switch to ID2) with the numeric keys.

Once the remote control code is registered successfully the remote control will blink twice. If SOURCE/RECEIVER blinks 6 times, the registration failed. Repeat from step 1.



- If the remote control ID is changed, the registered settings of the remote control code (p.79) are kept.

Setting the bi-amp connections



Switch the bi-amp connections of the front speakers on or off. Refer to “Connecting front speakers compatible with bi-amp connection” (p.16) for details.

Settings

ON	Turns bi-amp connections on.
OFF (Default)	Turns bi-amp connections off.

Changing TV format



Change the color encoding format of TV monitor to PAL or NTSC, to match the format used by the TV connected to the unit.

Settings

NTSC, PAL



- The default setting differs depending on your country or region.

Removing HDMI video output upscaling limits



This unit automatically detects the resolutions supported by the TV connected to this unit with an HDMI cable, and restricts the resolution selected in the “Resolution” (p.74) of the “Setup” menu (monitor check function). When a resolution that the TV does not support needs to be selected, this menu will remove the limitation from the settings selected in “Resolution.”

Settings

YES (Default)	Enables the monitor check function. (Video output signals of a resolution not supported by the TV will not be transmitted.)
SKIP	Disables the monitor check function. (Video output signals of any resolution will be transmitted.)



- If no picture is output from the TV and this unit goes out of control after “MON.CHK” is set to “SKIP,” set this item back to “YES.”

Changing FM/AM frequency steps (Asia and General models only)



You can select one of the following FM/AM frequency steps:

Settings

AM10/FM100	You can adjust the AM frequency by steps of 10kHz and FM by steps of 100kHz.
AM9/FM50	You can adjust the AM frequency by steps of 9kHz and FM by steps of 50kHz.



- The default setting differs depending on your country or region.



- For details on setting FM/AM frequency steps, refer to “Changing FM/AM tuner frequency steps (Asia and General models only)” (p.41).

Initializing various settings for the unit



Initialize various settings stored in the unit depending on the selected item from the following.

Settings

DSP PARAM	Initializes all parameters for the sound programs.
ALL	Resets the unit to default factory settings.
CANCEL (Default)	Does not initialize.

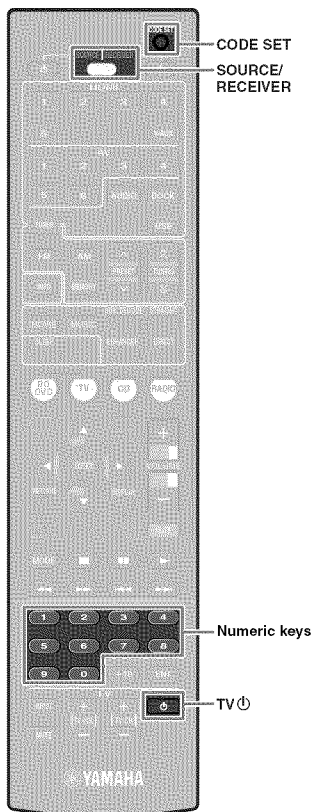

Controlling other devices with the remote control

You can operate an external device such as a TV or BD/DVD player with the remote control of the unit by setting the remote control code for the external device (remote control code).



- External devices that do not support infrared remote control cannot be used.
- Confirm that the remote control ID is set to "ID1" on the external device. If another remote control ID is set on the external device, the remote control does not work correctly even if the remote control codes for the external device are registered on the remote control.
- Leaving exhausted batteries in the remote control for more than 2 minutes, may clear the registered remote control codes. If this should occur, replace the batteries with new ones, and set the remote control codes.
- When the external device cannot be operated with the remote control even if all corresponding remote control codes are set to the remote control, the external device is not supported.
- The manufacturers and external devices that do not exit in "Remote Control Code Search" contained in the CD-ROM are not available for operations of the unit's remote control.
- Remote control code of an external device cannot be set from the name or model number of a unit.

When the HDMI control functions of both unit and the playback device are enabled, the devices may be controlled using the remote control even if not registering the remote control code.

Registering remote control codes for TV operations

Register a TV remote control code to control the TV with the remote control.



- When the audio output jack on the TV is connected to the input jack on the unit, follow the procedure in "Registering remote control codes for external device operations" (p.79) to register a TV remote control code.

- 1 Use "Remote Control Code Search" in the CD-ROM to search the available remote control codes from the category or manufacturer of the TV.**
- 2 Press CODE SET using a pointed object such as the tip of a ballpoint pen.**
SOURCE/RECEIVER blinks twice.
Perform each of the following steps within 1 minute. Settings will be automatically stopped if more than 1 minute passes after the last operation. To reset, repeat from step 2.
- 3 Press TV .**
- 4 Enter a remote control code (4-digit) using the numeric keys.**

Once the remote control code is registered successfully SOURCE/RECEIVER will blink twice.

If the registration fails, SOURCE/RECEIVER blinks six times.

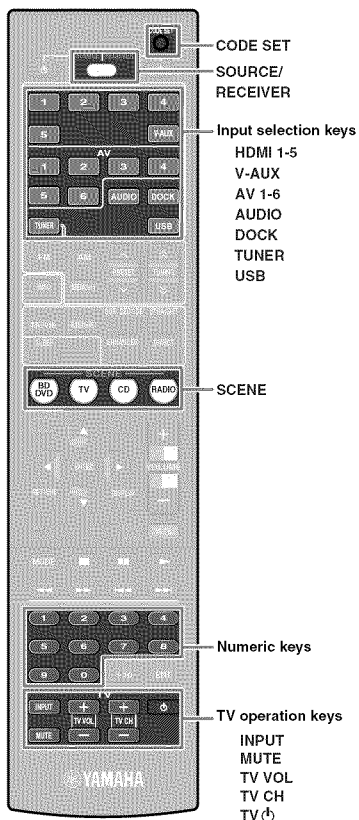

■ Operating the TV with the remote control

When the remote control codes for the TV are registered, the TV can be operated at any time using the TV control keys, regardless of the selected input source.

TV operation keys	INPUT	Switches video inputs to the TV.
	MUTE	Mutes TV volume temporarily.
	TV VOL	Controls the volume of the TV.
	TV CH	Switches TV channels.
	TV	Turns the TV on and off.



- When a TV remote control code is registered to an input selection key, the TV can be operated using the TV operation keys only when the input source with the TV code registered is selected.

Registering remote control codes for external device operations

Register remote control codes for external devices (such as a BD/DVD player) to control them with the unit's remote control. Because the remote control codes are registered to each input selection key, when you select an input source the remote control instantly switches to control that input source.



- The CD player (Yamaha: 5095) to AV3 as factory default settings. No remote control keys are assigned to other input selection keys.

1 Use “Remote Control Code Search” in the CD-ROM to search the available remote control codes for the category, manufacturer, or external device.

2 Press CODE SET using a pointed object such as the tip of a ballpoint pen.

SOURCE/RECEIVER blinks twice.

Perform each of the following steps within 1 minute. Settings will be automatically stopped if more than 1 minute passes after the last operation. To reset, repeat from step 2.

3 Press an input selection key.

(Example) When the remote control codes for the BD/DVD player connected to HDMI1 jack are assigned, press HDMI1.

4 Enter a remote control code (4-digit) using the numeric keys.

Once the remote control code is registered successfully SOURCE/RECEIVER will blink twice.

If the registration fails, SOURCE/RECEIVER blinks six times. If the registration fails, repeat from step 2.



- For details on how to register the input selection key applied the remote control code on a corresponding SCENE key, refer to “Changing the settings for the SCENE function” (p.35).

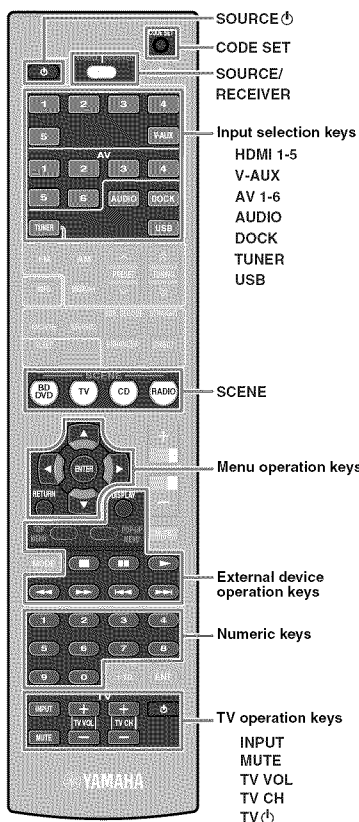

■ Operating external devices

When the remote control codes for external devices are assigned to an input selection key, the external device can be controlled with the following keys after selecting the appropriate input source or SCENE.



- Use SOURCE/RECEIVER to switch the device to be controlled with menu operation keys and numeric keys between the unit and external devices. The unit can be controlled when SOURCE/RECEIVER glows orange. External devices can be controlled when the key glows green.

SOURCE		Turns on and off external devices.
Menu operation keys	Cursor	Selects an item.
	ENTER	Confirms a selected item.
	RETURN	Returns to the previous screen.
	DISPLAY	Switch the content of display.
	TOP MENU	Displays the top menu.
	POP-UP MENU	Displays a pop-up menu.
External device operation keys		Stops playback.
		Stops playback temporarily.
		Starts playback of the currently selected song (or video).
		Searches backwards/forwards while pressing them.
		Searches backwards/forwards while pressing them.
		Skips to the beginning of the currently playing song (or video)/the next song (or video).
Numeric keys		Enter numbers.
TV operation keys		Operate a TV.



- The keys above are only available when there are the corresponding keys on the remote control of external devices.

Initializing all remote control codes

Initializing all remote control codes to the initial factory settings.

1 Press CODE SET using a pointed object such as the tip of a ballpoint pen.

SOURCE/RECEIVER blinks twice.

Perform each of the following steps within 1 minute. Settings will be automatically stopped if more than 1 minute passes after the last operation. To reset, repeat from step 1.

2 Press SOURCE/RECEIVER.

3 Enter “9981” using the numeric keys.

Once the remote control code is reset successfully SOURCE/RECEIVER will blink twice. If the reset fails, SOURCE/RECEIVER blinks six times. If setup fails, repeat from step 1.

APPENDIX

Frequently asked questions

The new speaker system does not provide an ideal sound balance...

If you have changed speakers or speaker system, perform YPAO to optimize the speaker settings again (p.29). If you want to adjust the speaker settings manually, use "Speaker" in the "Setup" menu (p.65).

Since we have small children, we want to set limitations on the volume control...

If a small child, etc. accidentally operates the controls on the main unit or remote control, the volume may suddenly increase. And this may cause injury or damage this unit or speakers. We recommend using "Max Volume" in the "Setup" menu to set the maximum volume level for this unit in advance (p.68).

I am occasionally startled by a sudden large sound when turning on this unit...

By default, the volume level when this unit last entered standby mode is automatically applied. If you want to fix the volume, use "Initial Volume" to set the volume to be applied when this receiver is turned on (p.68).

I want to prevent accidental changes to the settings...

You can protect the settings configured on this unit (speaker settings, etc.) by utilizing "Memory Guard" in the "Setup" menu (p.72).

The supplied remote control concurrently controls this unit and another Yamaha product that is not intended...

When using multiple Yamaha products, the supplied remote control may work on another Yamaha product or another remote control may work on this unit. In this case, set each remote control with a unique remote control ID for its corresponding receiver (p.76).

Troubleshooting



Refer to the table below if the unit does not function properly.

If the problem you are experiencing is not listed below, or if the instructions below do not help, turn off the unit, disconnect the power cable, and contact the nearest authorized Yamaha dealer or service center.

Confirm the following points first.

- ① The power plugs of the unit, TV and external devices (such as a BD/DVD player) are plugged into the electric outlet securely.
- ② The unit, subwoofer, TV and external devices (such as a BD/DVD player) are turned on.
- ③ The cables between devices are connected securely.

Power/system

Problem	Cause	Remedy
The power will not turn on.	The internal circuits of the unit have a problem.	The capability to turn on the power is disabled as a safety precaution. Contact your nearest Yamaha dealer or service center to request repairs.
The unit cannot be turned off.	The internal microcomputer is hung-up due to an external electric shock (such as lightning or excessive static electricity) or by a drop in the power supply voltage.	Press and hold  (power) for over 10 seconds. The unit will be initialized and rebooted.
The unit enters standby mode soon after the power is turned on.	The unit was turned on while a speaker cable is shorted.	Make sure that all speaker cables between the unit and speakers are connected properly.
The unit enters standby mode.	The sleep timer has turned the unit off.	Turn on the unit, and play the source again.
	The auto power down function is activated because of no operations with the remote control or the unit itself for a while.	Set "Auto Power Down" to "Off" to disable the auto power down function (p.71).
	The protection circuitry has been activated because of a short circuit, etc.	Make sure that all speaker cables between the unit and speakers are connected properly.
	The heat protection has been activated because sound was continually output at high volumes.	Wait until the unit cools to normal temperature, turn on the unit again and turn down the volume level and play the source again (p.34).
The unit does not work properly.	The internal microcomputer is hung-up due to an external electric shock (such as lightning or excessive static electricity) or by a drop in the power supply voltage.	Press and hold  (power) for over 10 seconds. The unit will be initialized and rebooted.

Audio

Problem	Cause	Remedy
No sound.	No appropriate input source has been selected.	Select an appropriate input source with the input selection key.
	Signals that the unit cannot reproduce are being input from a source device, such as a CD-ROM.	Use an input source that has signals that can be reproduced on the unit.
	The mute function is activated.	Press MUTE to unmute.
The volume cannot be increased.	The cable between the unit and the external device may be malfunctioning.	Make sure that all speaker cables between the unit and speakers are connected properly. If after checking you can find no problems, replace the cables.
	The max volume of the unit is restricted by "Max Volume" function.	Adjust the max volume of the unit in "Max Volume" in the "Setup" menu.
	The device connected to the output jack of the unit is not turned on. (This may occur because of the character of AV receiver.)	Turn on all devices connected to the unit.
No sound is output from one speaker.	Sound may not be output from certain channels, depending on the input source.	You can confirm the number of source channels in the input signal with "Channel (Chan)" of "Signal Info" in the "Option" menu (p.61).
	Sound may not be output from certain channels, depending on the sound program or decoder.	You can confirm the number of output channels with the speaker indicators on the front display (p.8).
	Output from the affected speaker is disabled.	Perform YPAO (p.29), or set the size or enable the affected speaker in "Configuration" (p.65) on the "Setup" menu.
	The volume of the affected speaker is set excessively low.	Perform YPAO (p.29), or adjust the volume level of the affected speaker in "Level" (p.66) on the "Setup" menu.
	The cable between the unit and the external device may be malfunctioning.	Make sure that all speaker cables between the unit and speakers are connected properly. If no problem, replace the cables.
	The affected speaker may be malfunctioning.	Replace the affected speaker with another speaker that is operating correctly to confirm whether the speaker is malfunctioning. If no sound comes from the replacement speaker, the unit may be malfunctioning.
	"Max Volume" is set to a low value.	Set it to a higher value.
	The speakers that have a problem cannot be confirmed.	Use "Test Tone" to confirm the speakers that do not output sounds (p.67).
No sound is heard from the surround back speakers.	"Extended Surround" is set to "Off."	Set "Extended Surround" to a decoder or "Auto" (p.61).
No sound is heard from the subwoofer.	The source does not contain LFE or low frequency signals.	To confirm, set "Extra Bass" to "On" to output the low frequency sound of the front channel from the subwoofer (p.66).
	The subwoofer is inactive.	Perform YPAO (p.29), or set "Subwoofer" to "Use" in the "Setup" menu (p.66).
	The subwoofer is tuned off.	Turn on the subwoofer.
	The volume of the subwoofer is set to a low value.	Set it to a higher value.
No sound from a device connected using an HDMI cable.	The connected HDMI device does not support high-bandwidth digital copyright protection (HDCP).	You can confirm if message concerning HDMI error is displayed in "Signal Info" in the "Option" menu (p.61).
	HDMI input audio is set to not output from the speakers.	Set "Amp" to "On" in "Audio Output" of the "Setup" menu (p.73).
	The number of devices is over the limit.	Disconnect some of the HDMI devices.

Problem	Cause	Remedy
TV sound is not output from the unit.	(When using HDMI Control function) The setting of "TV Audio Input" to match operations carried out on TV is not set.	Select the appropriate audio input jack in "TV Audio Input" on the "Setup" menu.
	(When using the Audio Return Channel function) The Audio Return Channel function is not working.	Set "ARC" in the "Setup" menu to "On" (p.73). Or, the Audio Return Channel function is activated on the TV.
	The TV is not ARC-compatible and connected to the unit only with an HDMI cable.	Connect an optical cable to AV4 (p.20, 21), or other cables and set the appropriate input source with "TV Audio Input" (p.73).
	Sound is output from the TV.	Set "HDMI Control" (p.72) or "Audio Output" (p.73) correctly to output sound from the unit.
Only the front speakers output sound during multi-channel playback.	The playback device is set to output only 2 channel sound (such as PCM).	Set the audio output settings on the playback device.
Noise/hum noise is heard.	The unit is too close to other digital or radio frequency equipment (including iPhone).	Move the unit further away from such equipment.
	The cable between the unit and the external device may be malfunctioning.	Make sure that all speaker cables between the unit and speakers are connected properly. If no problem, replace the cables.
Noise is heard when a DTS-CD is being played back.	(When only noise is output) The playback device is connected by analog connection.	Connect the playback device to the unit by a digital connection (optical or coaxial connection). If you still have a problem, the playback device may have a problem.
The sound is distorted.	The devices connected to the output jacks of the unit are not turned on.	Turn on all devices connected to the unit.
The songs from the USB storage device are played back intermittently.	The transfer rate of the USB storage device is too slow.	Try another USB storage device.

Video

Problem	Cause	Remedy
No picture.	An appropriate input source is not selected on the unit.	Select an appropriate input source (video device) using the input selection keys.
	An appropriate video input is not selected on the TV.	Select an appropriate input on the TV.
	The video signal output from the unit is not supported by a monitor connected to the unit.	Set "MON.CHK" to "YES" in the "ADVANCED SETUP" menu (p.77).
	The cable between the unit, the TV and the video devices may be malfunctioning.	Make sure that all cables are connected properly. If no problem, replace the cables.
No picture from the video device connected with an HDMI cable.	A video signal (resolution) that the unit does not support is being input.	You can confirm the video signal (resolution) currently being input in "Signal Info" in the "Option" menu (p.61). For detail on video signals which the unit supports, refer to "Information on HDMI" (p.92).
	The connected HDMI device does not support high-bandwidth digital copyright protection (HDCP).	Display "Signal Info" in the "Option" menu to confirm the video signal (resolution) currently input (p.61).
	The number of devices is over the limit.	Disconnect some of the HDMI devices.

Problem	Cause	Remedy
The menu of the unit is not displayed.	The TV is connected to the unit with a cable except for HDMI cable.	Use an HDMI cable to connect the TV to the unit.
	An appropriate video input is not selected on the TV.	Select the input source of the TV to the video input from the HDMI OUT of the unit.

Tuner (FM/AM)

Problem	Cause	Remedy
FM stereo radio reception is noisy.	There is multi-path interference.	Adjust the antenna height or orientation, or place it in a different location.
	You are too far from the station transmitter, or the input from the antenna is weak.	Switch the receiving mode to monaural using MODE (p.42). Replace the outdoor antenna with a more sensitive multi-element antenna.
AM radio reception is noisy.	The noises may be caused by lightning, fluorescent lamps, motors, thermostats, or other electrical equipment.	It is difficult to completely eliminate noise, but it can be reduced by installing an outdoor AM antenna.
	The signal is weak, or the antenna connections are loose.	Adjust the AM antenna orientation. Replace the outdoor antenna with a more sensitive multi-element antenna.
Radio stations cannot be selected automatically.	Your area is too far from the FM station transmitter.	Select the station manually (p.41).
		Use an outdoor antenna commercially available. We recommend using a sensitive multi-element antenna.
AM radio stations cannot be preset.	Automatic station preset is used to preset AM stations.	Automatic station preset is not available for AM stations. Use manual station preset.

Remote control

Problem	Cause	Remedy
The remote control does not work or function properly.	Wrong distance.	Operate the remote control within its operating range (p.4).
	The batteries are weak.	Replace the batteries (p.4).
	Direct sunlight or lighting (from an inverter type of fluorescent lamp, strobe light, etc.) is striking the remote control sensor of the unit.	Adjust the lighting angle, or reposition the unit.
	The operation device is set to an external device.	Switch the operation device to the unit using RECEIVER/SOURCE (it should glow orange) and operate the unit (p.10).
	The remote control ID of the remote control and the unit do not match.	Match the remote control ID of the unit and the remote control (p.76).
External devices cannot be controlled using the remote control.	The operation device is set to the unit.	Switch the operation device to the external device using RECEIVER/SOURCE (it should glow green) and operate the external device (p.10).
	The remote control code is not correctly set.	Set the remote control code correctly (p.78, 79). Even if the remote control code is correctly set, there are some devices that do not respond to the remote control.

Message list

Message (alphabetical order)	Cause	Remedy
Access error	The unit cannot access your USB storage device or iPod.	Try another USB device or iPod.
	There is a problem with the signal path from your USB storage device to the unit.	Turn off the unit and reconnect your USB storage device to the USB port of the unit.
		When an iPod is connected to the USB port, turn the iPod off and on.
CHECK SP WIRES!	The protection circuitry has been activated because this unit was turned on while a speaker cable was shorted.	Make sure that all speaker cables between this unit and speakers are connected properly.
Connect error	There is a problem with the signal path from your iPod to the unit.	Turn off the unit and reconnect the iPod dock (p.47).
		Reconnect the iPod to the iPod dock (p.47).
Loading...	The data of the USB storage devices and iPod are being loaded.	It takes a long while to load the data when connecting a device that has a large amount of data.
No content	There is no playable data on the USB storage devices or iPod.	Connect the USB storage device or iPod in which the playable data are stored.
No device	There is a problem with the signal path from your USB storage device to the unit.	Turn off the unit and reconnect your USB storage device to the USB port of the unit.
		When iPod is connected to the USB port, turn the iPod off and on.
	USB storage device is not connected to the USB port.	Connect the USB storage device to the USB port on the front panel of the unit.
Not found	The Bluetooth device is not found.	During pairing: - Pairing must be performed on the Bluetooth device and the unit simultaneously. Check if the Bluetooth device is in pairing mode.
		While connected: - Check if the Bluetooth device is turned on. - Check if the Bluetooth device is within 10 m (32 ft.) of the Yamaha Bluetooth Wireless Audio Receiver. - Do pairing again.
Unknown iPod	The iPod being used is not supported by the unit.	Connect an iPod that is supported by the unit (p.46).
Unable to play	The unit cannot play back the songs stored on your iPod.	Check the songs stored on your iPod.
	The song that the unit cannot play back is selected, or the selected song data is damaged.	Select and play another song.
View ON SCREEN	The selected item cannot be displayed on the front display.	Confirm the display on the TV connected with an HDMI cable.
		When "SETUP" is displayed at the upper left on the front display, press SETUP on the remote control to return to normal display on the front display.
		When "USB" or "DOCK" at the upper left on the front display, press the cursor key (<]) to return to the display of menu list or playing song.

Ideal speaker layout

The following illustration indicates the ideal speaker layout. We recommend using the following layout as a guide when placing the speakers. However, by using YPAO, you can automatically optimize the speaker settings to suit your speaker layout.

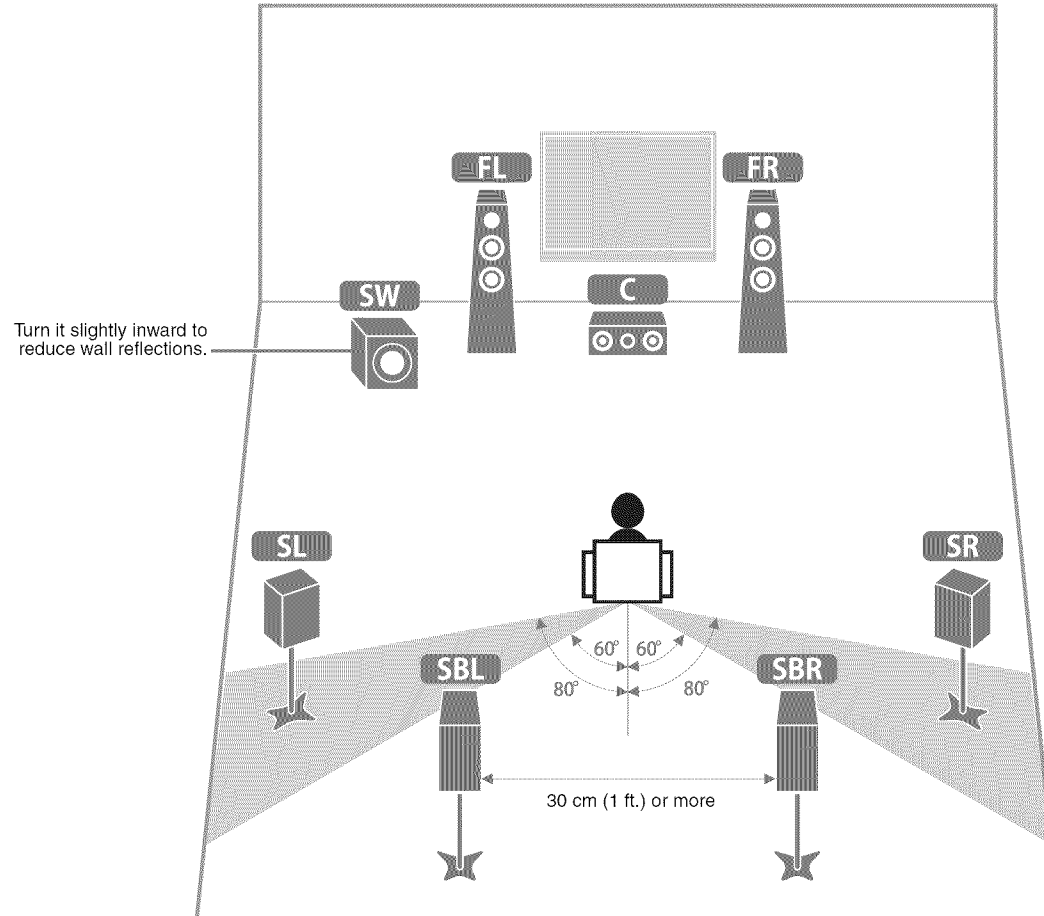

Audio information

Audio and video synchronization (lip sync)

Lip sync, an abbreviation for lip synchronization, is a technical term that involves both a problem, and the capability of maintaining audio and video signals synchronized during post-production and transmission.

Whereas the audio and video latency requires complex end-user adjustment, HDMI version 1.3 incorporates an automatic audio and video syncing capability that allows devices to perform this synchronization automatically and accurately without user interaction.

Bi-amplification connection

A bi-amplification connection uses two amplifiers for a speaker. One amplifier is connected to the woofer section of a loudspeaker while the other is connected to the combined mid and tweeter section. With this arrangement each amplifier operates over a restricted frequency range. This restricted range presents each amplifier with a much simpler job and each amplifier is less likely to influence the sound in some way.

CINEMA DSP

Since the Dolby Surround and DTS systems were originally designed for use in movie theaters, their effect is best felt in a theater having many speakers designed for acoustic effects. Since home conditions, such as room size, wall material, number of speakers, and so on, can differ so widely, it is inevitable that there are differences in the sound that is heard. Based on a wealth of actually measured data, Yamaha CINEMA DSP uses Yamaha's original DSP technology to combine Dolby Pro Logic, Dolby Digital, and DTS systems to provide the audiovisual experience of a movie theater in the listening room of your own home.

CINEMA DSP 3D

The actually measured sound field data contain the information of the height of the sound images. CINEMA DSP 3D feature achieves the reproduction of the accurate height of the sound images so that it creates the accurate and intensive stereoscopic sound fields in a listening room.

Compressed Music Enhancer

The Compressed Music Enhancer feature of this unit enhances your listening experience by regenerating the missing harmonics in compression artifacts. As a result, it compensates for flattened complexity due to the loss of high-frequency fidelity as well as lack of bass due to the loss of low-frequency bass, providing improved performance for the overall sound system.

Dolby Digital

Dolby Digital is a digital surround sound system that gives you completely independent multi-channel audio. With 3 front channels (front L/R and center), and 2 surround stereo channels, Dolby Digital provides 5 full-range audio channels. With an additional channel especially for bass effects, referred to as LFE (Low-Frequency Effect), the system has a total of 5.1-channels (LFE is counted as 0.1 channel). By using 2-channel stereo for the surround speakers, more accurate moving sound effects and surround sound environments are possible than with Dolby Surround. The wide dynamic range from maximum to minimum volumes that are reproduced by the 5 full-range channels, and the precise sound orientation generated using digital sound processing provides listeners with unprecedented excitement and realism. With this unit, any sound environment from monaural up to a 5.1-channel configuration can be freely selected for your enjoyment.

Dolby Pro Logic II

Dolby Pro Logic II is an improved technique used to decode vast numbers of existing Dolby Surround sources. This new technology enables a discrete 5-channel playback with 2 front left and right channels, 1 center channel, and 2 surround left and right channels, instead of only 1 surround channel for conventional Pro Logic technology. There are three modes available: "Music mode" for music sources, "Movie mode" for movie sources, and "Game mode" for game sources.

Dolby Pro Logic IIx

Dolby Pro Logic IIx is a new technology enabling discrete multichannel playback from 2-channel or multi-channel sources. There are three modes available: "Music mode" for music sources, "Movie mode" for movie sources and "Game mode" for game sources.

Dolby Surround

Dolby Surround uses a 4-channel analog recording system to reproduce realistic and dynamic sound effects: 2 front left and right channels (stereo), a center channel for dialog (monaural), and a surround channel for special sound effects (monaural). The surround channel reproduces sound within a narrow frequency range. Dolby Surround is widely used with nearly all video tapes and laser discs, as well as in many TV and cable broadcasts. The Dolby Pro Logic decoder built into this unit employs a digital signal processing system that automatically stabilizes the volume on each channel to enhance moving sound effects and directionality.

Dolby TrueHD

Dolby TrueHD is an advanced lossless audio technology developed for high-definition disc-based media including Blu-ray Disc. Selected as an optional audio standard for Blu-ray Disc, this technology delivers sound that is bit-for-bit identical to the studio master, offering a high-definition home theater experience. Supporting bitrates up to 18.0 Mbps, Dolby TrueHD can carry up to 8 discrete channels of 24-bit/96 kHz audio simultaneously. Dolby TrueHD also remains fully compatible with the existing multichannel audio systems and retains the metadata capability of Dolby Digital, allowing dialog normalization and dynamic range control.

DTS 96/24

DTS 96/24 offers an unprecedented level of audio quality for multichannel sound on DVD video, and is fully backward-compatible with all DTS decoders. "96" refers to a 96 kHz sampling rate compared to the typical 48 kHz sampling rate. "24" refers to 24-bit word length. DTS 96/24 offers sound quality transparent to the original 96/24 master, and 96/24 5.1-channel sound with full-quality full-motion video for music programs and motion picture soundtracks on DVD video.

DTS Digital Surround

DTS Digital Surround was developed to replace the analog soundtracks of movies with a 5.1-channel digital sound track, and is now rapidly gaining popularity in movie theaters around the world. DTS, Inc. has developed a home theater system so that you can enjoy the depth of sound and natural spatial representation of DTS Digital Surround in your home. This system produces practically distortion-free 5.1-channel sound (technically, left, right and center channels, 2 surround channels, plus an LFE 0.1 channel as a subwoofer, for a total of 5.1-channels).

DTS Express

This is an audio format for next-generation optical discs such as Blu-ray discs. It uses optimized low bit rate signals for network streaming. In the case of a Blu-ray disc, this format is used with secondary audio, enabling you to enjoy the commentary of the movie producer via the Internet while playing the main program.

DTS-HD High Resolution Audio

DTS-HD High Resolution Audio is a high resolution audio technology developed for high-definition disc-based media including Blu-ray Disc. Selected as an optional audio standard for Blu-ray Disc, this technology delivers sound that is virtually indistinguishable from the original, offering a high-definition home theater experience. Supporting bitrates up to 6.0 Mbps for Blu-ray Disc, DTS-HD High Resolution Audio can carry up to 7.1 discrete channels of 24-bit/96 kHz audio simultaneously. DTS-HD High Resolution Audio also remains fully compatible with the existing multichannel audio systems that incorporate DTS Digital Surround.

DTS-HD Master Audio

DTS-HD Master Audio is an advanced lossless audio technology developed for high-definition disc-based media including Blu-ray Disc. Selected as an optional audio standard for Blu-ray Disc, this technology delivers sound that is bit-for-bit identical to the studio master, offering a high-definition home theater experience. Supporting bitrates up to 24.5 Mbps for Blu-ray Disc, DTS-HD Master Audio can carry up to 7.1 discrete channels of 24-bit/96 kHz audio simultaneously. Supported by HDMI version 1.3 and designed for the optical disc players and AV receivers/amplifiers of the future, DTS-HD Master Audio also remains fully compatible with the existing multichannel audio systems that incorporate DTS Digital Surround.

DSD

Direct Stream Digital (DSD) technology stores audio signals on digital storage media, such as Super Audio CDs. Using DSD, signals are stored as single bit values at a high-frequency sampling rate of 2.8224 MHz, while noise shaping and oversampling are used to reduce distortion, a common occurrence with very high quantization of audio signals. Due to the high sampling rate, better audio quality can be achieved than that offered by the PCM format used for normal audio CDs. The frequency is equal to or higher than 100 kHz, with a dynamic range of 120 dB. This unit can transmit or receive DSD signals via the HDMI jack.

LFE 0.1 channel

This channel reproduces low-frequency bass signals, and has a frequency range from 20 Hz to 120 Hz. This channel is counted as 0.1, because it only enforces a low-frequency range compared to the full-range reproduced by the other 5-channels in Dolby Digital or DTS 5.1-channel systems.

Neo:6

Neo:6 decodes the conventional 2-channel sources for 6-channel playback by the specific decoder. It enables playback with the full-range channels with higher separation just like digital discrete signal playback. There are two modes available: "Music mode" for music sources and "Cinema mode" for movie sources.

PCM (Linear PCM)

Linear PCM is a signal format under which an analog audio signal is digitized, recorded and transmitted without using any compression. This is used as a method of recording CDs and DVD audio. The PCM system uses a technique for sampling the size of the analog signal per very small unit of time. Standing for "Pulse Code Modulation," the analog signal is encoded as pulses and then modulated for recording.

Sampling frequency and number of quantized bits

When digitizing an analog audio signal, the number of times the signal is sampled per second is called the sampling frequency, while the degree of accuracy when converting the sound level into a numeric value is called the number of quantized bits. The range of rates that can be played back is determined based on the sampling rate, whereas the dynamic range representing the sound level difference is determined by the number of quantized bits. In principle, the higher the sampling frequency, the wider the range of frequencies that can be played back, and the higher the number of quantized bits, the more accurately the sound level can be reproduced.

SILENT CINEMA

Yamaha has developed a natural, realistic sound effect DSP algorithm for headphones. Parameters for headphones have been set for each sound program, so that accurate representations of all the sound programs can be enjoyed on headphones.

Virtual CINEMA DSP

Yamaha has developed a Virtual CINEMA DSP algorithm that allows you to enjoy DSP surround effects even without any surround speakers, by using virtual surround speakers. It is even possible to enjoy Virtual CINEMA DSP using a minimal two-speaker system that does not include a center speaker.

Video information

Component video signal

With the component video signal system, the video signal is separated into the Y signal for luminance and the PB and PR signals for chrominance. Color can be reproduced more faithfully with this system because each of these signals is independent. The component signal is also called the "color difference signal" because the luminance signal is subtracted from the color signal. A monitor with component input jacks is required in order to output component signals.

Composite video signal

With the composite video signal system, the video signal comprises the three basic elements of a video picture: color, brightness and synchronization data. A composite video jack on a video component transmits these three elements combined.

Deep Color

Deep Color refers to the use of various color depths in displays, up from the 24-bit depths in previous versions of the HDMI specification. This extra bit depth allows HDTVs and other displays increase from millions of colors to billions of colors and eliminate on-screen color banding for smooth tonal transitions and subtle gradations between colors. The increased contrast ratio can represent many times more shades of gray between black and white. Additionally, Deep Color increases the number of available colors within the boundaries defined by the RGB or YCbCr color space.

HDMI

HDMI (High-Definition Multimedia Interface) is the first industry supported, uncompressed, all-digital audio/video interface. Providing an interface between any sources (such as set-top boxes or AV receivers) and audio/video monitors (such as digital televisions), HDMI supports standard, enhanced or high-definition video as well as multichannel digital audio using a single cable. HDMI transmits all ATSC HDTV standards and supports 8-channel digital audio, with bandwidth to spare to accommodate future enhancements and requirements.

When used in combination with HDCP (High-bandwidth Digital Content Protection), HDMI provides a secure audio/video interface that meets the security requirements of content providers and system operators. For further information on HDMI, visit the HDMI website at "<http://www.hdmi.org/>."

S-video signal

With the S-video signal system, the video signal normally transmitted using a pin cable is separated and transmitted as the Y signal for the luminance and the C signal for the chrominance through the S-video cable. Using the S VIDEO jack eliminates video signal transmission loss and allows recording and playback of even more beautiful images.

“x.v.Color”

A color space standard supported by HDMI version 1.3. It is a more extensive color space than sRGB, and allows the expression of colors that were not hitherto possible. While remaining compatible with the color gamut of sRGB standards, “x.v.Color” expands the color space, and can thus produce more vivid, natural images. It is particularly effective for still pictures and computer graphics.

Video signal flow

The video signals input from video devices to the unit are output to a TV.

Video conversion table



- Use "Processing" in the "Setup" menu to change the resolution and aspect ratio of video signals and output from the HDMI OUT jack.
- The unit does not convert 480 line video signals and 576 line video signals interchangeably.

→ : video signal flow

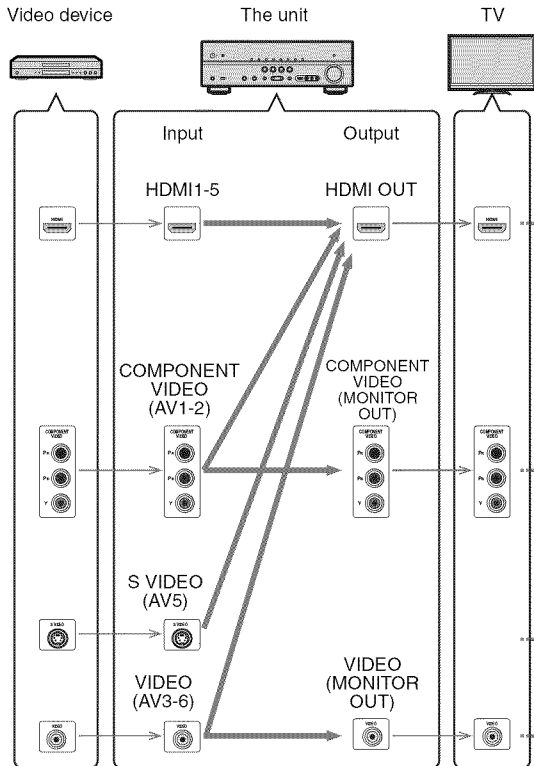

* S VIDEO is only available for U.K. and Europe models

	Resolution	HDMI output					COMPONENT VIDEO output				VIDEO output
		480i/576i	480p/576p	720p	1080i	1080p	480i/576i	480p/576p	720p	1080i	480i/576i
HDMI input	480i/576i	→	→	→	→	→					
	480p/576p		→	→	→	→					
	720p			→							
	1080i				→						
COMPONENT VIDEO input	480i/576i	→	→	→	→	→					
	480p/576p		→	→	→	→	→				
	720p			→				→			
	1080i				→				→		
S VIDEO Input (U.K. and Europe models only)	480i/576i	→	→	→	→	→					
VIDEO input	480i/576i	→	→	→	→	→					→

Information on HDMI

HDMI Control

Connecting the unit and TV with an HDMI cable links the TV's remote control to the unit so you can use it to turn on the power and adjust the volume of the unit (HDMI Control). Playback devices connected to the unit with an HDMI cable (such as a BD/DVD player compatible with HDMI control) can also be operated with the remote control. For details on operations between the TV and the playback devices using the HDMI control function, refer to the manual for each device.

For details on connections of HDMI cables, refer to "Connecting a TV" (p.18) and "Connecting video devices (such as BD/DVD players)" (p.23).

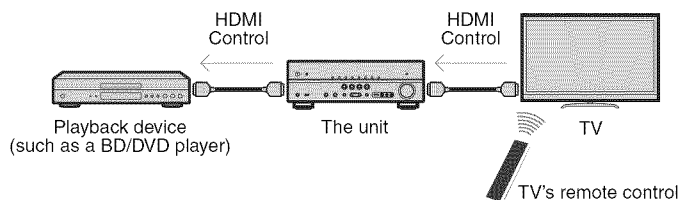

Operating the unit using the HDMI control function

- Turning the power on and off
- Volume control, including mute
- Changing the input to video/audio from the operated external device



- The following operations of the unit are interlocked with the TV/playback devices by HDMI control.
 - Switching a SCENE (p.35)
 - Displaying the "Setup" menu (p.63)
 - Operating external device with the unit's remote control (p.79)

The following settings are required after connecting the TV and playback devices to the unit to use the HDMI Control function.



- The following settings are required whenever a new HDMI compatible device is added.

- 1 Turn on the unit, the TV and external devices.**
- 2 Set the HDMI Control function of the unit, the TV and external devices compatible with HDMI Control (such as a BD/DVD player) to "On."**

Set "HDMI Control" in the "Setup" menu to "On" to enable the HDMI Control function of the unit.
- 3 Turn the TV off.**

Other synchronized HDMI Control devices are turned off with the TV. If they are not synchronized, unplug the power cable of the TV.
- 4 Turn the TV on.**

Confirm that the unit has turned on in conjunction with the TV. If it is still off, turn it on manually.
- 5 Change the TV's input setting to the input jack that is connected to the unit.**
- 6 Turn the playback devices on, and confirm the following points.**

The unit: Confirm that the input source for HDMI input (one of HDMI 1-5) has been selected. If a different input source has been selected, change it manually.

TV: Confirm that the video signal from the player is being properly received by the TV.
- 7 Confirm that the unit is properly synchronized with the TV by turning on/off the TV or adjusting the TV volume with the TV remote control.**



- If the HDMI Control function does not work properly, unplugging and re-plugging the power cable of the unit and the TV may solve the problem.
- If the unit is not synchronized to the TV's power operations, check the priority of video output settings on the TV.
- We recommend using TV and playback devices made by the same manufacturer so that the HDMI Control function works more effectively.

HDMI signal compatibility

Audio signals

Audio signal types	Audio signal formats	Compatible media
2ch Linear PCM	2ch, 32-192 kHz, 16/20/24 bit	CD, DVD-Video, DVD-Audio, etc.
Multi-ch Linear PCM	8ch, 32-192 kHz, 16/20/24 bit	DVD-Audio, Blu-ray Disc, HD DVD, etc.
DSD	2/5.1ch, 2.8224 MHz, 1 bit	SACD, etc.
Bitstream	Dolby Digital, DTS	DVD-Video, etc.
Bitstream (High definition audio)	Dolby TrueHD, Dolby Digital Plus, DTS-HD Master Audio, DTS-HD High Resolution Audio, DTS Express	Blu-ray Disc, HD DVD, etc.



- When CPPM copy-protected DVD-Audio is played back, video and audio signals may not be output, depending on the type of the DVD player.
- This unit is not compatible with HDCP-incompatible HDMI or DVI devices.
- To decode audio bitstream signals on this unit, set the input source device appropriately so that the device outputs the bitstream audio signals directly (does not decode the bitstream signals on the device). Refer to the supplied instruction manuals for details.
- This unit is not compatible with the audio commentary features (for example, the special audio contents downloaded via Internet) of Blu-ray Disc or HD DVD. This unit does not playback the audio commentaries of the Blu-ray Disc or HD DVD content.

Video signals

This unit is compatible with the video signals of the following resolutions:

- 480i/60 Hz
- 576i/50 Hz
- 480p/60 Hz
- 576p/50 Hz
- 720p/60 Hz, 50 Hz
- 1080i/60 Hz, 50 Hz
- 1080p/60 Hz, 50 Hz, 24 Hz

Trademarks



Manufactured under license from Dolby Laboratories. Dolby, Pro Logic and the double-D symbol are trademarks of Dolby Laboratories.



Manufactured under license under U.S. Patent #'s: 5,451,942; 5,956,674; 5,974,380; 5,978,762; 6,226,616; 6,487,535; 7,212,872; 7,333,929; 7,392,195; 7,272,567 & other U.S. and worldwide patents issued & pending. DTS and the Symbol are registered trademarks, & DTS-HD, DTS-HD Master Audio, and the DTS logos are trademarks of DTS, Inc. Product includes software. ©DTS, Inc. All Rights Reserved.

iPod™/iPhone™

"Made for iPod" and "Made for iPhone" mean that an electronic accessory has been designed to connect specifically to iPod or iPhone, respectively, and has been certified by the developer to meet Apple performance standards.

Apple is not responsible for the operation of this device or its compliance with safety and regulatory standards. Please note that the use of this accessory with iPod or iPhone may affect wireless performance.

iPhone and iPod are trademarks of Apple Inc., registered in the U.S. and other countries.

Bluetooth™

Bluetooth is a registered trademark of the Bluetooth SIG and is used by Yamaha in accordance with a license agreement.



"HDMI," the "HDMI" logo and "High-Definition Multimedia Interface" are trademarks, or registered trademarks of HDMI Licensing LLC.



"SILENT CINEMA" is a trademark of Yamaha Corporation.

Specifications

Input Jacks

- Analog Audio..... 4 (AV5, AV6, AUDIO, VIDEO AUX)
- Digital Audio
 - Optical.....2 (AV1, AV4)
 - Coaxial2 (AV2, AV3)
- Video
 - Composite5 (AV3-6, VIDEO AUX)
 - S-Video [U.K. and Europe models]..... 1 (AV5)
 - Component.....2 (AV1, AV2)
- Other
 - DOCK 1 (Audio, Composite Video)
 - USB 1
 - Device Type..... USB Mass Storage Class
 - Audio Format.....MP3, WMA, WAV (PCM), MPEG-4 AAC
 - Max Audio Support fs.....48 kHz/24 bit
 - Cover Art Format..... PNG, JPEG

Output Jacks

- Analog Audio
 - Speaker Out7ch
 - Front L/R (FRONT L/R)
 - Center (CENTER)
 - Surround L/R (SURROUND L/R)
 - Surround Back L/R (SURROUND BACK L/R)*
 - * Assignable (SURROUND BACK, BI-AMP)
 - Subwoofer Out1 (SUBWOOFER)
 - Rec Out 1 (AV OUT)
 - Headphone Out..... 1 (PHONES)
- Video
 - Monitor Out
 - Composite 1
 - Component..... 1
 - Rec Out
 - Composite 1 (AV OUT)

HDMI

- Input
 - Front..... 1 (VIDEO AUX)
 - Rear.....5 (HDMI1-5)
- Output..... 1 (HDMI OUT)
- HDMI Specification
 - Deep Color
 - “x.v.Color”
 - Auto Lip Sync
 - ARC (Audio Return Channel)
 - 3D Video
- Video Format
 - Repeater Mode
 - VGA
 - 480i@60 Hz
 - 576i@50 Hz
 - 480p@60 Hz
 - 576p@50 Hz
 - 1080i@50/60 Hz
 - 720p@50/60 Hz
 - 1080p@24/50/60 Hz
 - Analog Up Conversion
 - 480i@60 Hz (NTSC)
 - 576i@50 Hz (PAL)
 - 480p@60 Hz
 - 576p@50 Hz
 - 1080i@50/60 Hz
 - 720p@50/60 Hz
 - Up-Scaling
 - 480i → 480p/720p/1080i/1080p
 - 480p → 720p/1080i/1080p
 - 576i → 576p/720p/1080i/1080p
 - 576p → 720p/1080i/1080p
- Audio Format
 - Dolby Digital
 - DTS
 - DSD (6ch)
 - Dolby Digital Plus
 - Dolby TrueHD
 - DTS-HD
 - PCM (2ch to 8ch, Max 192 kHz/24 bit)
- Content ProtectionHDCP compatible
- Link Function CEC compatible

Tuner

- Analog Tuner
 - FM/AM 1 (TUNER)

Compatible Decoding Format

- Decoding Format
 - Dolby TrueHD
 - Dolby Digital Plus
 - Dolby Digital
 - Dolby Digital EX
 - DTS-HD Master Audio
 - DTS-HD High Resolution
 - DTS Express
 - DTS
 - DTS-ES Matrix 6.1
 - DTS-ES Discrete 6.1
 - DTS 96/24
- Post Decoding Format
 - Dolby Pro Logic
 - Dolby Pro Logic II Music
 - Dolby Pro Logic II Movie
 - Dolby Pro Logic II Game
 - Dolby Pro Logic IIx Music
 - Dolby Pro Logic IIx Movie
 - Dolby Pro Logic IIx Game
 - DTS Neo:6 Music
 - DTS Neo:6 Cinema

Audio Section

- Rated Output Power (1 channel driven)
[U.S.A. and Canada models] (1 kHz, 0.9% THD, 8 Ω)
[Other models] (1 kHz, 0.9% THD, 6 Ω)
Front L/R 105 W/ch
Center 105 W/ch
Surround L/R 105 W/ch
Surround Back L/R 105 W/ch
- Rated Output Power (2 channels driven simultaneously)
[U.S.A. and Canada models] (1 kHz, 0.9% THD, 8 Ω)
Front L/R 85 W+85 W
Center 85 W
Surround L/R 85 W+85 W
Surround Back L/R 85 W+85 W
- Maximum Effective Output Power (JEITA, 1 kHz, 10% THD, 6 Ω)
[China, Korea, Asia and General models]
Front L/R 135 W/ch
Center 135 W/ch
Surround L/R 135 W/ch
Surround Back L/R 135 W/ch
- Dynamic Power (IHF)
[U.S.A. and Canada models]
Front L/R (8/6/4/2 Ω) 110/130/160/180 W
[Other models]
Front L/R (6/4/2 Ω) 110/130/150 W
- Dynamic Headroom
[U.S.A. and Canada models]
8 Ω 0.23 dB
- Damping Factor
Front L/R, 20 Hz to 20 kHz, 8 Ω 120 or more
- Input Sensitivity / Input Impedance
AV5 etc. (1 kHz, 100 W/6 Ω) 200 mV/47 kΩ
- Maximum Input Signal
AV5 etc. (1 kHz, 0.5% THD, Effect On) 2.3 V
- Output Level / Output Impedance
AV OUT 200 mV/1.2 kΩ
SUBWOOFER (2ch Stereo, Front: Small) 1 V/1.2 kΩ
- Headphone Jack Rated Output / Impedance
AV5 etc. (1 kHz, 50 mV, 8 Ω) 100 mV/470 Ω
- Frequency Response
AV5 etc. to Front (10 Hz to 100 kHz) +0/-3 dB
- Signal to Noise Ratio (IHF-A Network)
AV5 etc. (DIRECT, Input Shorted 250 mV, Speaker Out)
..... 100 dB or more
- Residual Noise (IHF-A Network)
Front L/R 150 μV or less

- Channel Separation
AV5 etc. (Input 5.1 kΩ Shorted, 1 kHz/10 kHz)
..... 60 dB/45 dB or more
- Volume Control
Range MUTE, -80 dB to +16.5 dB
Step 0.5 dB
- Tone Control Characteristics (Front L/R)
Bass Boost/Cut ±6 dB/0.5 dB Step at 50 Hz
Bass Turnover 350 Hz
Treble Boost/Cut ±6 dB/0.5 dB Step at 20 kHz
Treble Turnover 3.5 kHz
- Filter Characteristics
(fc=40/60/80/90/100/110/120/160/200 Hz)
H.P.F. (Front, Center, Surround, Surround Back) 12 dB/oct.
L.P.F. (Subwoofer) 24 dB/oct.

Video Section

- Video Signal Type
[U.S.A., Canada, Korea and General models] NTSC
[Other models] PAL
- Video Signal Type (Video Conversion) NTSC/PAL
- Video Signal Level
Composite 1 Vp-p/75 Ω
S-Video [U.K. and Europe models]
Y 1 Vp-p/75 Ω
C 0.286 Vp-p/75 Ω
Component
Y 1 Vp-p/75 Ω
Cb/Cr 0.7 Vp-p/75 Ω
- Video Maximum Input Level (Video Conversion Off) ... 1.5 Vp-p
- Video Signal to Noise Ratio 50 dB or more
- Monitor Out Frequency Response (Video Conversion Off)
Component 5 Hz to 60 MHz, -3 dB

FM Section

- Tuning Range
[U.S.A. and Canada models] 87.5 MHz to 107.9 MHz
[Asia and General models]
..... 87.5/87.50 MHz to 108.0/108.00 MHz
[Other models] 87.50 MHz to 108.00 MHz
- 50 dB Quietening Sensitivity (IHF, 1 kHz, 100% MOD.)
Mono 3 μV (20.8 dBf)
- Signal to Noise Ratio (IHF)
Mono 72 dB
Stereo 70 dB

- Harmonic Distortion (IHF, 1 kHz)
Mono 0.3%
Stereo 0.5%
- Antenna Input 75 Ω unbalanced

AM section

- Tuning Range
[U.S.A. and Canada models] 530 kHz to 1710 kHz
[Asia and General models] 530/531 kHz to 1710/1611 kHz
[Other models] 531 kHz to 1611 kHz

General

- Power Supply
[U.S.A. and Canada models] AC 120 V, 60 Hz
[General model] AC 110-120/220-240 V, 50/60 Hz
[China model] AC 220 V, 50 Hz
[Korea model] AC 220 V, 60 Hz
[Australia model] AC 240 V, 50 Hz
[U.K. and Europe models] AC 230 V, 50 Hz
[Asia model] AC 220-240 V, 50/60 Hz
- Power Consumption
[U.S.A. and Canada models] 270 W/320 VA
[Other models] 280 W
- Standby Power Consumption
HDMI Control Off / Standby Through Off 0.1 W or less
HDMI Control On / Standby Through On 1.2 W or less
- Maximum Power Consumption
[Asia and General models] 490 W
- Dimensions (W x H x D) 435 x 151 x 363 mm
(17-1/8" x 6" x 14-5/16")
- Weight 8.3 kg (18.3 lbs)

* Specifications are subject to change without notice.



YAMAHA CORPORATION

© 2011 Yamaha Corporation © YD340B0/OMEN

AV Receiver

Safety Brochure

⏻ (Power key)

Turns on the power of this unit or sets it to the standby mode.

For more detailed information, refer to the Owner's Manual on the CD-ROM. To view the Owner's Manual, click on "English" in the screen displayed automatically when you insert the CD-ROM into your PC, or click on the model name if the screen to select models is displayed, and then click on "English" in the next screen. Then, follow the onscreen instructions. If the screen is not displayed automatically, open the "index.html" in the CD-ROM. Caution: Do not attempt to play this CD-ROM in an audio player. The Owner's Manual contained in the CD-ROM can be downloaded from the following website. <http://download.yamaha.com/>

IMPORTANT SAFETY INSTRUCTIONS

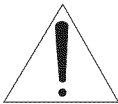
	CAUTION RISK OF ELECTRIC SHOCK DO NOT OPEN	
CAUTION: TO REDUCE THE RISK OF ELECTRIC SHOCK, DO NOT REMOVE COVER (OR BACK). NO USER-SERVICEABLE PARTS INSIDE. REFER SERVICING TO QUALIFIED SERVICE PERSONNEL.		

- Explanation of Graphical Symbols



The lightning flash with arrowhead symbol, within an equilateral triangle, is intended to alert you to the presence of uninsulated "dangerous voltage" within the product's enclosure that may be of sufficient magnitude to constitute a risk of electric shock to persons.



The exclamation point within an equilateral triangle is intended to alert you to the presence of important operating and maintenance (servicing) instructions in the literature accompanying the appliance.

- 1 Read these instructions.
- 2 Keep these instructions.
- 3 Heed all warnings.
- 4 Follow all instructions.
- 5 Do not use this apparatus near water.
- 6 Clean only with dry cloth.
- 7 Do not block any ventilation openings. Install in accordance with the manufacturer's instructions.
- 8 Do not install near any heat sources such as radiators, heat registers, stoves, or other apparatus (including amplifiers) that produce heat.
- 9 Do not defeat the safety purpose of the polarized or grounding-type plug. A polarized plug has two blades with one wider than the other. A grounding type plug has two blades and a third grounding prong. The wide blade or the third prong are provided for your safety. If the provided plug does not fit into your outlet, consult an electrician for replacement of the obsolete outlet.
- 10 Protect the power cord from being walked on or pinched particularly at plugs, convenience receptacles, and the point where they exit from the apparatus.
- 11 Only use attachments/accessories specified by the manufacturer.
- 12 Use only with the cart, stand, tripod, bracket, or table specified by the manufacturer, or sold with the apparatus. When a cart is used, use caution when moving the cart/apparatus combination to avoid injury from tip-over.
- 13 Unplug this apparatus during lightning storms or when unused for long periods of time.
- 14 Refer all servicing to qualified service personnel. Servicing is required when the apparatus has been damaged in any way, such as power-supply cord or plug is damaged, liquid has been spilled or objects have fallen into the apparatus, the apparatus has been exposed to rain or moisture, does not operate normally, or has been dropped.



FCC INFORMATION (for US customers)

1 IMPORTANT NOTICE: DO NOT MODIFY THIS UNIT!

This product, when installed as indicated in the instructions contained in this manual, meets FCC requirements. Modifications not expressly approved by Yamaha may void your authority, granted by the FCC, to use the product.

2 IMPORTANT: When connecting this product to accessories and/or another product use only high quality shielded cables. Cable/s supplied with this product MUST be used. Follow all installation instructions. Failure to follow instructions could void your FCC authorization to use this product in the USA.

3 NOTE: This product has been tested and found to comply with the requirements listed in FCC Regulations, Part 15 for Class "B" digital devices. Compliance with these requirements provides a reasonable level of assurance that your use of this product in a residential environment will not result in harmful interference with other electronic devices.

This equipment generates/uses radio frequencies and, if not installed and used according to the instructions found in the users manual, may cause interference harmful to the operation of other electronic devices.

Compliance with FCC regulations does not guarantee that interference will not occur in all installations. If this product is found to be the source of interference, which can be determined by turning the unit "OFF" and "ON", please try to eliminate the problem by using one of the following measures:

Relocate either this product or the device that is being affected by the interference.

Utilize power outlets that are on different branch (circuit breaker or fuse) circuits or install AC line filter/s.

In the case of radio or TV interference, relocate/reorient the antenna. If the antenna lead-in is 300 ohm ribbon lead, change the lead-in to coaxial type cable.

If these corrective measures do not produce satisfactory results, please contact the local retailer authorized to distribute this type of product. If you can not locate the appropriate retailer, please contact Yamaha Electronics Corp., USA, 6660 Orangethorpe Ave., Buena Park, CA 90620.

The above statements apply ONLY to those products distributed by Yamaha Corporation of America or its subsidiaries.

FOR CANADIAN CUSTOMERS

To prevent electric shock, match wide blade of plug to wide slot and fully insert. This Class B digital apparatus complies with Canadian ICES-003.

POUR LES CONSOMMATEURS CANADIENS

Pour éviter les chocs électriques, introduire la lame la plus large de la fiche dans la borne correspondante de la prise et pousser jusqu'au fond. Cet appareil numérique de la classe B est conforme à la norme NMB-003 du Canada.

IMPORTANT

Please record the serial number of this unit in the space below.

MODEL:

Serial No.:

The serial number is located on the rear of the unit. Retain this Owner's Manual in a safe place for future reference.

■ For U.K. customers

If the socket outlets in the home are not suitable for the plug supplied with this appliance, it should be cut off and an appropriate 3 pin plug fitted. For details, refer to the instructions described below.

Note

The plug severed from the mains lead must be destroyed, as a plug with bared flexible cord is hazardous if engaged in a live socket outlet.

■ Special Instructions for U.K. Model

IMPORTANT

THE WIRES IN MAINS LEAD ARE COLOURED IN ACCORDANCE WITH THE FOLLOWING CODE:

Blue: NEUTRAL

Brown: LIVE

As the colours of the wires in the mains lead of this apparatus may not correspond with the coloured markings identifying the terminals in your plug, proceed as follows:

The wire which is coloured BLUE must be connected to the terminal which is marked with the letter N or coloured BLACK. The wire which is coloured BROWN must be connected to the terminal which is marked with the letter L or coloured RED.

Making sure that neither core is connected to the earth terminal of the three pin plug.

We Want You Listening For A Lifetime



Yamaha and the Electronic Industries Association's Consumer Electronics Group want you to get the most out of your equipment by playing it at a safe level. One that lets the sound come through loud and clear without annoying blaring or distortion – and, most importantly, without affecting your sensitive hearing. Since hearing damage from loud sounds is often undetectable until it is too late, Yamaha and the Electronic Industries Association's Consumer Electronics Group recommend you to avoid prolonged exposure from excessive volume levels.

CAUTION: READ THIS BEFORE OPERATING YOUR UNIT.

- 1 To assure the finest performance, please read this manual carefully. Keep it in a safe place for future reference.
- 2 Install this sound system in a well ventilated, cool, dry, clean place - away from direct sunlight, heat sources, vibration, dust, moisture, and/or cold. For proper ventilation, allow the following minimum clearances.
Top: 30 cm, Rear: 20 cm, Sides: 20 cm
- 3 Locate this unit away from other electrical appliances, motors, or transformers to avoid humming sounds.
- 4 Do not expose this unit to sudden temperature changes from cold to hot, and do not locate this unit in an environment with high humidity (i.e. a room with a humidifier) to prevent condensation inside this unit, which may cause an electrical shock, fire, damage to this unit, and/or personal injury.
- 5 Avoid installing this unit where foreign object may fall onto this unit and/or this unit may be exposed to liquid dripping or splashing. On the top of this unit, do not place:
 - Other components, as they may cause damage and/or discoloration on the surface of this unit.
 - Burning objects (i.e. candles), as they may cause fire, damage to this unit, and/or personal injury.
 - Containers with liquid in them, as they may fall and liquid may cause electrical shock to the user and/or damage to this unit.
- 6 Do not cover this unit with a newspaper, tablecloth, curtain, etc. in order not to obstruct heat radiation. If the temperature inside this unit rises, it may cause fire, damage to this unit, and/or personal injury.
- 7 Do not plug in this unit to a wall outlet until all connections are complete.
- 8 Do not operate this unit upside-down. It may overheat, possibly causing damage.
- 9 Do not use force on switches, knobs and/or cords.
- 10 When disconnecting the power cable from the wall outlet, grasp the plug; do not pull the cable.
- 11 Do not clean this unit with chemical solvents; this might damage the finish. Use a clean, dry cloth.
- 12 Only voltage specified on this unit must be used. Using this unit with a higher voltage than specified is dangerous and may cause fire, damage to this unit, and/or personal injury. Yamaha will not be held responsible for any damage resulting from use of this unit with a voltage other than specified.
- 13 To prevent damage by lightning, keep the power cable and outdoor antennas disconnected from a wall outlet or this unit during a lightning storm.
- 14 Do not attempt to modify or fix this unit. Contact qualified Yamaha service personnel when any service is needed. The cabinet should never be opened for any reasons.
- 15 When not planning to use this unit for long periods of time (i.e. vacation), disconnect the AC power plug from the wall outlet.
- 16 Be sure to refer to the "Troubleshooting" section of the Owner's Manual on the CD-ROM for common operating errors before concluding that this unit is faulty.
- 17 Before moving this unit, press Φ to set it to standby mode and disconnect the AC power plug from the wall outlet.
- 18 **VOLTAGE SELECTOR (General model)**
The VOLTAGE SELECTOR on the rear panel of this unit must be set for your local main voltage BEFORE plugging into the AC wall outlet. Voltages are:
.....AC 110-120/220-240V, 50/60Hz
- 19 Condensation will form when the surrounding temperature changes suddenly. Disconnect the power cable from the outlet, then leave this unit alone.
- 20 When using this unit for a long time, this unit may become warm. Turn the power off, then leave this unit alone for cooling.
- 21 Install this unit near the AC outlet and where the AC power plug can be reached easily.

- 22 The batteries shall not be exposed to excessive heat such as sunshine, fire or the like. When you dispose of batteries, follow your regional regulations.
- 23 Excessive sound pressure from earphones and headphones can cause hearing loss.
- 24 When replacing the batteries, be sure to use batteries of the same type. Danger of explosion may happen if batteries are incorrectly replaced.

This unit is not disconnected from the AC power source as long as it is connected to the wall outlet, even if this unit itself is turned off by Φ . This state is called the standby mode. In this state, this unit is designed to consume a very small quantity of power.

WARNING

TO REDUCE THE RISK OF FIRE OR ELECTRIC SHOCK, DO NOT EXPOSE THIS UNIT TO RAIN OR MOISTURE.

■ Notes on remote controls and batteries

- Do not spill water or other liquids on the remote control.
- Do not drop the remote control.
- Do not leave or store the remote control in the following conditions:
 - places of high humidity, such as near a bath
 - places of high temperatures, such as near a heater or stove
 - places of extremely low temperatures
 - dusty places
- Insert the battery according to the polarity markings (+ and -).
- Change all batteries if you notice the following conditions:
 - the operation range of the remote control narrows
 - the transmit indicator does not flash or is dim
- If the batteries run out, immediately remove them from the remote control to prevent an explosion or acid leak.
- If you find leaking batteries, discard the batteries immediately, taking care not to touch the leaked material. If the leaked material comes into contact with your skin or gets into your eyes or mouth, rinse it away immediately and consult a doctor. Clean the battery compartment thoroughly before installing new batteries.
- Do not use old batteries together with new ones. This may shorten the life of the new batteries or cause old batteries to leak.
- Do not use different types of batteries (such as alkaline and manganese batteries) together. Specification of batteries may be different even though they look the same.
- Before inserting new batteries, wipe the compartment clean.
- If the remote control is without batteries for more than 2 minutes, or if exhausted batteries remain in the remote control, the contents of the memory may be cleared. In such a case, install new batteries and set the remote control code.
- Dispose of batteries according to your regional regulations.

Limited Guarantee for European Economic Area (EEA) and Switzerland

Thank you for having chosen a Yamaha product. In the unlikely event that your Yamaha product needs guarantee service, please contact the dealer from whom it was purchased. If you experience any difficulty, please contact Yamaha representative office in your country. You can find full details on our website (<http://www.yamaha-hifi.com/> or <http://www.yamaha-uk.com/> for U.K. resident).

The product is guaranteed to be free from defects in workmanship or materials for a period of two years from the date of the original purchase. Yamaha undertakes, subject to the conditions listed below, to have the faulty product or any part(s) repaired, or replaced at Yamaha's discretion, without any charge for parts or labour. Yamaha reserves the right to replace a product with that of a similar kind and/or value and condition, where a model has been discontinued or is considered uneconomic to repair.

Conditions

- 1 The original invoice or sales receipt (showing date of purchase, product code and dealer's name) MUST accompany the defective product, along with a statement detailing the fault. In the absence of this clear proof of purchase, Yamaha reserves the right to refuse to provide free of charge service and the product may be returned at the customer's expense.
- 2 The product MUST have been purchased from an AUTHORISED Yamaha dealer within the European Economic Area (EEA) or Switzerland.
- 3 The product must not have been the subject of any modifications or alterations, unless authorised in writing by Yamaha.
- 4 The following are excluded from this guarantee:
 - a. Periodic maintenance and repair or replacement of parts due to normal wear and tear.
 - b. Damage resulting from:
 - (1) Repairs performed by the customer himself or by an unauthorised third party.
 - (2) Inadequate packaging or mishandling, when the product is in transit from the customer. Please note that it is the customer's responsibility to ensure the product is adequately packaged when returning the product for repair.
 - (3) Misuse, including but not limited to (a) failure to use the product for its normal purpose or in accordance with Yamaha's instructions on the proper use, maintenance and storage, and (b) installation or use of the product in a manner inconsistent with the technical or safety standards in force in the country where it is used.
 - (4) Accidents, lightning, water, fire, improper ventilation, battery leakage or any cause beyond Yamaha's control.
 - (5) Defects of the system into which this product is incorporated and/or incompatibility with third party products.
 - (6) Use of a product imported into the EEA and/or Switzerland, not by Yamaha, where that product does not conform to the technical or safety standards of the country of use and/or to the standard specification of a product sold by Yamaha in the EEA and/or Switzerland.
- 5 Where the guarantee differs between the country of purchase and the country of use of the product, the guarantee of the country of use shall apply.
- 6 Yamaha may not be held responsible for any losses or damages, whether direct, consequential or otherwise, save for the repair or replacement of the product.
- 7 Please backup any custom settings or data, as Yamaha may not be held responsible for any alteration or loss to such settings or data.
- 8 This guarantee does not affect the consumer's statutory rights under applicable national laws in force or the consumer's rights against the dealer arising from their sales/purchase contract.

Information for Users on Collection and Disposal of Old Equipment and Used Batteries



These symbols on the products, packaging, and/or accompanying documents mean that used electrical and electronic products and batteries should not be mixed with general household waste. For proper treatment, recovery and recycling of old products and used batteries, please take them to applicable collection points, in accordance with your national legislation and the Directives 2002/96/EC and 2006/66/EC.



By disposing of these products and batteries correctly, you will help to save valuable resources and prevent any potential negative effects on human health and the environment which could otherwise arise from inappropriate waste handling.



For more information about collection and recycling of old products and batteries, please contact your local municipality, your waste disposal service or the point of sale where you purchased the items.



[Information on Disposal in other Countries outside the European Union]

These symbols are only valid in the European Union. If you wish to discard these items, please contact your local authorities or dealer and ask for the correct method of disposal.

Note for the battery symbol (bottom two symbol examples):

Pb

This symbol might be used in combination with a chemical symbol. In this case it complies with the requirement set by the Directive for the chemical involved.

List of remote control codes
Liste des codes de commande
Liste der Fernbedienungs-codes
Lista över fjärrstyrningskoder
Elenco dei codici di telecomando

Lista de códigos de mando a distancia
Lijst met afstandsbedieningscodes
Список кодов дистанционного управления
遥控器代码列表
리모콘코드목록

TV	
A.R. Systems	0320
Acme	0342
Acura	0323, 0343
ADC	0337
Admiral	0054, 0178, 0336, 0337, 0339, 0346, 0347
Advent	0158
Adventura	0057
Adyson	0277, 0282, 0342
Agashi	0277, 0282
Agazi	0337
Aiko	0277, 0282, 0320, 0323, 0342, 0343
Aim	0320
Aiwa	0078, 0379
Akai	0050, 0055, 0109, 0159, 0181, 0277, 0282, 0320, 0323, 0340, 0343, 0349, 0350
Akiba	0320, 0340
Akura	0320, 0323, 0337, 0340
Alaron	0277
Alba	0161, 0277, 0320, 0323, 0340, 0342, 0343, 0344, 0349, 0351, 0372, 0382
Albatron	0140
Alcyon	0171
Alleron	0059
Allorgan	0282
Allstar	0320, 0350
America Action	0179
AMOi	0276
Amplivision	0161, 0282, 0321, 0342
Amstrad	0320, 0323, 0337, 0340, 0343
Amtron	0058
Anam	0179, 0343
Anam National	0052, 0058
Anglo	0323, 0343
Anitech	0171, 0320, 0323, 0337, 0343
Ansonic	0161, 0168, 0320, 0323, 0341, 0343
AOC	0008, 0026, 0050, 0053
Apex	0039, 0111, 0217
Arcam	0277, 0282
Arcam Delta	0342
Aristona	0320, 0349, 0350
Arthur Martin	0321
ASA	0339, 0347
Asberg	0171, 0320, 0350
Astra	0343
Asuka	0277, 0282, 0337, 0340, 0342
Atlantic	0277, 0320, 0342, 0349, 0350
Atori	0323, 0343
Auchan	0321
Audiosonic	0161, 0282, 0320, 0340, 0342, 0343, 0349, 0350
AudioTon	0161, 0282, 0342
Audiovox	0058, 0179, 0194
Ausind	0171
Autovox	0171, 0282, 0337, 0339, 0342
Aventura	0051
Awa	0277, 0282
Axion	0156
Baird	0282
Bang & Olufsen	0180, 0339
Basic Line	0282, 0320, 0323, 0340, 0343, 0350
Bastide	0282, 0342
Baur	0320, 0349
Bazin	0282
Beko	0161, 0269, 0294, 0302, 0311, 0320, 0328, 0351
Belcor	0008
Bell & Howell	0019, 0054
Benq	0097, 0242, 0361
Beon	0320, 0349, 0350
Best	0161
Bestar	0161, 0320, 0350
Binatone	0282, 0342
Blue Sky	0320, 0340
Blue Star	0348
Boots	0282, 0342
BPL	0320, 0348
Bradford	0058, 0179
Brandt	0322, 0345
Brilliant	0182
Brinkmann	0320
Brionvega	0320, 0339, 0349, 0350
Britannia	0277, 0282, 0342
Brockwood	0008
Broksonic	0109, 0179
Bruns	0339
BTC	0340
Bush	0269, 0282, 0283, 0304, 0320, 0323, 0328, 0332, 0340, 0343, 0344, 0346, 0348, 0349, 0350, 0372, 0382, 0463, 0470, 0472
Candle	0008, 0026, 0050, 0057
Capsonic	0337
Carena	0320
Carnivale	0050
Carrefour	0344
Carver	0010
Cascade	0320, 0323, 0343
Casio	0367
Cathay	0320, 0349, 0350
CCE	0183, 0282
Celebrity	0055, 0107
Celera	0039
Centurion	0320, 0349, 0350
Century	0339
CGE	0161, 0171
Changhong	0039
Chimei	0273
Cimline	0323, 0343
Citizen	0007, 0008, 0026, 0050, 0058
City	0323, 0343
Clarion	0179
Clarivox	0349
Clatronic	0161, 0171, 0282, 0320, 0323, 0337, 0340, 0342, 0343, 0350, 0351
CMS	0277
CMS Hightec	0282
Coby	0197
Colortyme	0008, 0026
Commercial Solutions	0021
Concerto	0008, 0026
Concorde	0323, 0343
Condor	0161, 0277, 0320, 0323, 0342, 0350, 0351
Contec	0179, 0277, 0323, 0342, 0343, 0344
Contec/Cony	0012, 0058
Continental Edison	0345
Cosmel	0323, 0343
Craig	0058, 0179
Crosley	0010, 0037, 0171, 0339

Crown	0058, 0161, 0171, 0179, 0320, 0323, 0343, 0349, 0350, 0351	Electa	0348	Frontech	0282, 0323, 0337, 0343, 0346, 0347	Grunpy	0058, 0059, 0179
CS Electronics	0277, 0340, 0342	ELECTRO TECH	0343	Fujitsu	0059, 0069, 0074, 0075, 0282	Haier	0157, 0233
CTC Clatronic	0341	Electroband	0055, 0107	Fujitsu General	0282	Halifax	0277, 0282, 0337, 0342
CTX	0205	Electrograph	0176	Fujitsu Siemens	0504, 0505, 0507, 0510, 0511	Hallmark	0008, 0026, 0031
Curtis Mathes	0007, 0008, 0010, 0019, 0021, 0026, 0049, 0050, 0178	Electrohome	0008, 0026, 0052, 0055	Funai	0051, 0058, 0059, 0112, 0113, 0115, 0118, 0119, 0179, 0337	Hampton	0277, 0282, 0342
CXC	0058, 0179	Element	0230	Futurtech	0058, 0179	Hanseatic	0161, 0168, 0282, 0320, 0323, 0342, 0343, 0344, 0349, 0350
Cybertron	0340	Elin	0277, 0320, 0323, 0342, 0349, 0350	Galaxi	0320, 0351	Hantarex	0320, 0323, 0343
Cytron	0152	Elite	0320, 0340, 0350	Galaxis	0161, 0320	Hantor	0320
Daewoo	0007, 0008, 0026, 0037, 0053, 0167, 0266, 0275, 0277, 0282, 0315, 0320, 0323, 0331, 0335, 0342, 0343, 0350, 0381, 0465	Elman	0341	Gateway	0176, 0177, 0241	Harman/Kardon	0010
Dainichi	0277, 0340	Elta	0277, 0323, 0343	GBC	0323, 0343, 0344	Harvard	0058, 0179
Dansai	0277, 0282, 0320, 0337, 0349, 0350	Emerson	0000, 0007, 0008, 0012, 0013, 0019, 0026, 0031, 0037, 0051, 0058, 0059, 0161, 0179, 0320, 0339	GE	0008, 0021, 0023, 0026, 0027, 0031, 0034, 0049, 0052, 0056, 0209	Harwood	0320, 0323
Dantax	0161, 0349	Emprex	0154	Geant Casino	0321	Havermy	0178
Dawa	0320	Envision	0008, 0026, 0050	GEC	0282, 0320, 0342, 0347, 0349, 0350	HCM	0282, 0320, 0323, 0337, 0342, 0343, 0348
Daytron	0007, 0008, 0026, 0323, 0343	Epson	0155, 0206, 0359	Geloso	0323, 0343, 0346	Hema	0282, 0323
De Graaf	0346	Erres	0320, 0349, 0350	General Technic	0323, 0343	Hewlett Packard	0192
Decca	0282, 0320, 0342, 0349, 0350	ESA	0051	Genexxa	0320, 0340, 0347, 0350	Higashi	0277
Dell	0145, 0245	ESC	0282	GFM	0128, 0227	HiLine	0320
Denver	0358, 0362	Etron	0343	Giant	0282	Hinari	0320, 0323, 0340, 0343, 0344, 0349, 0350
Desmet	0320, 0349, 0350	Eurofeel	0282	Gibraltar	0008, 0030, 0050, 0062	Hisawa	0321, 0340, 0348
Diamant	0320	Euro-Feel	0337	GoldHand	0277	Hisense	0247
Diamond	0277	Euroline	0349	Goldline	0320	Hitachi	0008, 0012, 0026, 0066, 0084, 0092, 0093, 0120, 0172, 0173, 0255, 0270, 0271, 0282, 0320, 0335, 0338, 0342, 0344, 0346, 0347, 0365, 0382, 0448, 0456, 0467, 0482
DiamondVision	0135, 0143	Euromann	0161, 0277, 0282	GoldStar	0007, 0008, 0012, 0026, 0031, 0050, 0053, 0161, 0277, 0282, 0320, 0323, 0342, 0343, 0346, 0349, 0350	Hornophon	0320, 0350
Dimensia	0049	Europhon	0320, 0337, 0342, 0350	Goodmans	0246, 0272, 0282, 0320, 0323, 0337, 0343, 0344, 0349, 0350, 0462, 0473, 0477	Hoshai	0340
Disney	0219	Expert	0321	Gorenje	0161, 0351	Huanyu	0277, 0342
Dixi	0282, 0320, 0323, 0343, 0349, 0350	Exquisit	0320	GPM	0340	Hygashi	0277, 0282, 0342
Dream Vision	0461, 0498	Fenner	0323, 0343	GPX	0129	Hyper	0277, 0282, 0323, 0342, 0343
DTS	0323, 0343	Ferguson	0322, 0345, 0349	Gradiente	0240	Hypson	0282, 0320, 0321, 0337, 0342, 0348, 0349, 0350
Dual	0282, 0320, 0342	Fidelity	0277, 0320, 0342, 0346	Graetz	0347	Hyundai	0141
Dual-Tec	0342, 0343	Filsai	0282	Granada	0171, 0282, 0320, 0321, 0342, 0344, 0346, 0349, 0350	Iberia	0320
Dumont	0008, 0030, 0062, 0282, 0339, 0341, 0342	Finlandia	0346	Grandin	0340, 0343, 0348, 0349	ICE	0277, 0282, 0320, 0323, 0337, 0340, 0342, 0343, 0350
Durabrand	0031, 0051, 0179, 0215	Finlux	0171, 0282, 0320, 0339, 0341, 0342, 0349, 0350	Gronic	0282	ICeS	0277
Dux	0349	FIRST LINE	0342, 0343, 0350	Grundig	0160, 0161, 0171, 0310, 0320	Ilo	0148, 0153
Dwin	0178	Firstline	0277, 0282, 0320, 0323			IMA	0058
Dynatron	0320, 0349, 0350	Fisher	0019, 0161, 0282, 0339, 0342, 0344, 0351			Imperial	0161, 0171, 0320, 0347, 0350, 0351
Dynex	0228, 0231	Flint	0320, 0350			Indiana	0320, 0349, 0350
Elbe	0161, 0168, 0282, 0320	Formenti	0171, 0277, 0336, 0339, 0342, 0349				
Elcit	0339	Formenti/Phoenix	0277				
		Fortress	0336, 0339				
		Fraba	0161, 0320				
		Friac	0161				

Infinity	0010	KLH	0039	Magnavox	0008, 0009, 0010, 0013,	Motion	0171
InFocus	0250, 0327, 0363, 0479, 0508	Kloss Novabeam	0057, 0058		0026, 0032, 0033, 0048,	Motorola	0052, 0178
Ingelen	0347	Kneissel	0161, 0168, 0320		0050, 0128, 0211, 0212,	MTC	0008, 0026, 0050, 0053, 0161, 0277
Ingersol	0323, 0343	Kolster	0320, 0350	Magnum	0224, 0226, 0239	Multi System	0349
Initial	0153	Konka	0340	Majestic	0337, 0343	Multitech	0058, 0161, 0179, 0183, 0277, 0282, 0320, 0323, 0341, 0342, 0343, 0344, 0346, 0349
Inno Hit	0171, 0282, 0320, 0323, 0340, 0342, 0343, 0349, 0350	Korpel	0320, 0349, 0350	Mandor	0337		
Innovation	0337, 0343	Korting	0161, 0339	Manesth	0282, 0320, 0337, 0342, 0349, 0350	Murphy	0277, 0342
Insignia	0131, 0228, 0236, 0238	Kosmos	0320	Marantz	0008, 0010, 0026, 0050, 0204, 0320, 0349, 0350	NAD	0026, 0031, 0111
Inteq	0030	Koyoda	0343	Marelli	0339	Naonis	0346
Interactive	0161	KTV	0007, 0050, 0058, 0179, 0183, 0282, 0342	Mark	0277, 0282, 0320, 0323, 0349, 0350	NEC	0008, 0026, 0050, 0052, 0053, 0072, 0103, 0282, 0344
Interbuy	0323, 0343	Kyoto	0277, 0282	Masuda	0282	Neckermann	0161, 0282, 0320, 0339, 0342, 0346, 0349, 0350, 0351
Interfunk	0161, 0320, 0339, 0347, 0349, 0350	Lasat	0161	Matsui	0282, 0320, 0323, 0342, 0343, 0344, 0346, 0349, 0350, 0455	NEI	0320, 0349, 0350
International	0277	Lenco	0323, 0343	Matsushita	0017	Net-TV	0176
Intervision	0161, 0282, 0320, 0337, 0341, 0342	Lenoir	0323, 0342, 0343	Maxent	0147, 0176	Neufunk	0320, 0323
Irradio	0171, 0320, 0323, 0340, 0343, 0349, 0350	Leyco	0320, 0337, 0349, 0350	Mediator	0320, 0349, 0350	New Tech	0343, 0350
Isukai	0320, 0340	LG	0031, 0053, 0066, 0116, 0117, 0140, 0161, 0164, 0175, 0195, 0269, 0277, 0282, 0300, 0309, 0317, 0320, 0323, 0328, 0342, 0343, 0346, 0349, 0350, 0366, 0368, 0377, 0466, 0471, 0478	Medion	0320, 0337, 0343	New World	0340
ITC	0282, 0342	LG/GoldStar	0164	Megapower	0140	NewTech	0282, 0320, 0323
ITS	0277, 0320, 0340, 0348, 0350	Liesenk	0349	Megatron	0026, 0031	Nicamagic	0277, 0342
ITT	0343, 0347	Liesenkotter	0320	MElectronic	0277, 0282, 0320, 0323	Nikkai	0277, 0282, 0320, 0323, 0337, 0340, 0342, 0349, 0350
ITV	0320, 0343, 0349	Life	0337, 0343	Melvox	0321	Nikko	0026, 0031, 0050
Janeil	0057	Lifetec	0320, 0323, 0337, 0343	Memorex	0019, 0026, 0031, 0053, 0054, 0137, 0215, 0323, 0343	Noblisko	0171, 0277, 0341, 0342
JBL	0010	Lloyds	0323	Memphis	0323, 0343	Nokia	0347
JC Penney	0007, 0008, 0026, 0027, 0049, 0053, 0056	Loewe	0161, 0168, 0265, 0320, 0330, 0352	Mercury	0320, 0323	Norcent	0201
JCB	0055, 0107	Loewe Opta	0339, 0349, 0350	Metz	0339	Nordic	0282
Jensen	0008, 0026	Logik	0054	MGA	0008, 0026, 0031, 0050, 0053	Nordmende	0339, 0345, 0347, 0350
JVC	0012, 0014, 0015, 0056, 0064, 0065, 0067, 0169, 0174, 0297, 0314, 0344, 0350, 0375	Luma	0320, 0323, 0346, 0349	Micromaxx	0337, 0343	Nordvision	0349
Kaisui	0277, 0282, 0320, 0323, 0340, 0342, 0343, 0348	Lumatron	0282, 0320, 0346, 0349, 0350	Microstar	0337, 0343	Novatron	0320
Kamosonic	0342	Lux May	0350	Midland	0007, 0021, 0023, 0027, 0030, 0056, 0062	Oceanic	0321, 0347
Kamp	0277, 0342	Luxman	0008, 0026	Minerva	0171	Okano	0161, 0320, 0351
Kapsch	0347	Luxor	0282, 0342, 0346	Minoka	0320, 0350	Olevia	0102, 0199, 0200, 0207, 0222
Karcher	0161, 0320, 0342, 0343, 0349	LXI	0010, 0019, 0021, 0026, 0027, 0031, 0049, 0111	Mintek	0153	ONCEAS	0342
Kawasho	0008, 0026, 0055, 0277	M Electronic	0342, 0343, 0345, 0347, 0349, 0350	Mitsubishi	0008, 0026, 0031, 0053, 0066, 0084, 0093, 0098, 0150, 0178, 0289, 0320, 0339, 0344, 0350, 0376	Onwa	0058, 0179
KEC	0179	MAG	0096	Mivar	0161, 0168, 0171, 0277, 0282, 0342	Opera	0320
Kendo	0161, 0320, 0341, 0346	Magnadyne	0339, 0341, 0349	Monivision	0140	Oppo	0130
Kenwood	0008, 0026, 0050	Magnafon	0171, 0277, 0341, 0342	Montgomery Ward	0054	Optimus	0017, 0019
KIC	0282					Optoma	0144
Kingsley	0277, 0342					Optonica	0178
						Orbit	0320, 0350

Orion	0043, 0146, 0283, 0320, 0323, 0328, 0343, 0349, 0350	Phonola	0277, 0320, 0339, 0349, 0350	RCA	0008, 0021, 0024, 0025, 0026, 0027, 0042, 0049, 0052, 0053, 0063, 0136, 0225	Schneider	0282, 0316, 0318, 0320, 0333, 0340, 0342, 0349, 0350, 0382
Orline	0320	Pilot	0007, 0008, 0050	Realistic	0019, 0031, 0050, 0179	Scotch	0026, 0031
Osaki	0282, 0320, 0337, 0340, 0342	Pioneer	0008, 0026, 0094, 0095, 0161, 0320, 0345, 0347, 0349, 0350, 0458, 0480	Recor	0320	Scott	0008, 0012, 0026, 0031, 0058, 0059, 0149, 0179
Oso	0340	Plantron	0320, 0323, 0337, 0350	Redstar	0320	Sears	0008, 0010, 0019, 0021, 0026, 0027, 0031, 0049, 0051, 0059, 0111
Otto Versand	0282, 0320, 0336, 0342, 0344, 0348, 0349, 0350	Playsonic	0282	Reflex	0320	SEG	0277, 0282, 0320, 0323, 0337, 0341, 0342, 0344, 0349, 0382
Pael	0277, 0342	Polaroid	0039, 0142, 0202, 0234	Revox	0161, 0320, 0349, 0350	SEI	0320
Palladium	0161, 0282, 0320, 0342, 0351	Poppy	0323, 0343	Rex	0337, 0346, 0347	SEI-Sinudyne	0339, 0341, 0347
Palsonic	0282	Portland	0007, 0008, 0026, 0053	RFT	0161, 0168, 0339	Seleco	0344, 0346, 0347
Panama	0277, 0282, 0320, 0323, 0337, 0342, 0343	Prandoni-Prince	0171, 0346	Rhapsody	0277	Sencora	0323, 0343
Panasonic	0016, 0017, 0020, 0022, 0023, 0035, 0052, 0056, 0084, 0085, 0133, 0163, 0193, 0284, 0286, 0290, 0292, 0320, 0325, 0347, 0356, 0483	Precision	0282, 0342	R-Line	0320, 0349, 0350	Sentra	0323
Panavision	0320	Prima	0157, 0243, 0323, 0343, 0347	Roadstar	0323, 0337, 0340, 0343	Serino	0277
Pathe Cinema	0161, 0168, 0277, 0321, 0342	Princeton	0140	Robotron	0339	Sharp	0000, 0001, 0002, 0003, 0007, 0008, 0012, 0026, 0060, 0088, 0089, 0091, 0138, 0165, 0170, 0178, 0198, 0229, 0262, 0278, 0279, 0291, 0308, 0312, 0336, 0344, 0354, 0370, 0449, 0450, 0451, 0464, 0474, 0476, 0481
Pausa	0323, 0343	Prism	0023, 0056	Royal Lux	0161	Sheng Chia	0178
Penney	0021, 0023, 0031, 0050, 0111	Profex	0323, 0343	RTF	0339	Shogun	0008
Perdio	0277, 0320	Profi-Tronic	0320, 0350	Runco	0030, 0050, 0062	Siarem	0320, 0339, 0341
Perfekt	0320	Proline	0320, 0350	Saba	0298, 0322, 0339, 0345, 0347	Sierra	0320, 0350
Phileo	0008, 0009, 0010, 0012, 0026, 0050, 0052, 0053, 0161, 0171, 0320, 0339	Proscan	0021, 0027, 0049	Saisho	0282, 0323, 0337, 0342, 0343	Siesta	0161
Philharmonic	0282, 0342	Prosonic	0161, 0277, 0282, 0320, 0342, 0349	Salora	0346, 0347	Signature	0054
Philips	0008, 0009, 0010, 0011, 0012, 0032, 0048, 0049, 0052, 0122, 0128, 0134, 0186, 0187, 0213, 0221, 0224, 0226, 0239, 0256, 0257, 0259, 0261, 0263, 0267, 0280, 0281, 0287, 0296, 0299, 0301, 0303, 0305, 0313, 0319, 0320, 0324, 0333, 0339, 0342, 0349, 0350, 0353, 0357, 0360, 0380, 0383, 0452, 0459, 0460	Protech	0282, 0337, 0341, 0342, 0343, 0349, 0350	Sambers	0171, 0341	Silva	0277
Philips Magnavox	0011, 0032, 0033	Proton	0008, 0012, 0026, 0031	Sampo	0007, 0008, 0026, 0050, 0176	Silver	0344
Phoenix	0161, 0277, 0320, 0339, 0349, 0350	Protron	0196	Samsung	0004, 0005, 0006, 0007, 0008, 0012, 0026, 0031, 0036, 0050, 0053, 0076, 0077, 0079, 0114, 0124, 0125, 0126, 0127, 0139, 0161, 0183, 0185, 0190, 0191, 0258, 0264, 0277, 0282, 0320, 0323, 0334, 0337, 0342, 0343, 0349, 0350, 0351, 0373, 0453, 0468	Singer	0321, 0339, 0341
		PROVIEW	0096, 0246			Sinudyne	0320, 0339, 0341, 0349
		Provision	0320, 0349			Skantic	0347
		Pulsar	0008, 0030, 0062			Solavox	0347
		Pye	0256, 0320, 0349, 0350, 0378			Sonitron	0161, 0282
		Pymi	0323, 0343			Sonoko	0282, 0320, 0323, 0337, 0342, 0343, 0349, 0350
		Quandra Vision	0321			Sonolor	0321, 0347
		Quasar	0017, 0023, 0052, 0056			Sontec	0161, 0320, 0349, 0350
		Quelle	0282, 0320, 0337, 0342, 0349, 0350			Sony	0038, 0044, 0045, 0047, 0055, 0090, 0104, 0105, 0107, 0110, 0123, 0184, 0220, 0248, 0249, 0251,
		Questa	0344				
		Radialva	0320				
		RadioShack	0019, 0021, 0031, 0050, 0179, 0320	Sandra	0277, 0282, 0342		
		RadioShack/Realistic	0007, 0008, 0012, 0026, 0049, 0058	Sansui	0043, 0109, 0320, 0350		
		Radiola	0282, 0320, 0349, 0350	Sanyo	0008, 0019, 0068, 0070, 0071, 0099, 0161, 0168, 0223, 0237, 0277, 0282, 0288, 0295, 0323, 0342, 0344, 0369, 0469		
		Radiomarelli	0320, 0339				
		Radiotone	0161, 0320, 0323, 0350	SBR	0320, 0349		
		Rank	0344	Sceptre	0235, 0244		
				Schaub Lorenz	0347		

	0252, 0254, 0326, 0343, 0344, 0371, 0374, 0457, 0475, 0486	Techwood	0008, 0023, 0026, 0056	United	0349	Yorx	0340
		TEDELEX	0282	Universum	0161, 0171, 0282, 0320, 0337, 0349, 0350, 0351	Zanussi	0282, 0346
Sound & Vision	0340, 0341	Teknika	0007, 0008, 0010, 0012, 0026, 0053, 0054, 0058, 0059, 0179	Univox	0320	Zenith	0008, 0028, 0029, 0030, 0031, 0054, 0061, 0062
Soundesign	0008, 0026, 0031, 0058, 0059, 0179	Teleavia	0345	Vector Research	0050		
Soundwave	0320, 0349, 0350	Telecor	0282, 0320	Vestel	0282, 0320, 0346, 0347, 0349, 0350, 0351		
Squareview	0051	Telefunken	0320, 0322, 0345, 0350	Vexa	0320, 0323, 0343, 0349		
SSS	0008, 0058, 0179	Telegazi	0320	Victor	0015, 0344, 0350		
Standard	0282, 0320, 0323, 0340, 0342, 0343, 0350	Telemeister	0320	VIDEOLOGIC	0277		
Starlite	0058, 0179, 0320, 0323, 0349	Telesonic	0320	Videologique	0277, 0282, 0340, 0342		
Stenway	0348	Telestarc	0320	VideoSystem	0320, 0350		
Stern	0346, 0347	Teletech	0320, 0323, 0343, 0349	Videotechnic	0277, 0282		
Strato	0320, 0323	Teleton	0282, 0342	Vidikron	0010		
Stylandia	0282	Televideon	0277	Vidtech	0008, 0026, 0031, 0053		
Sunkai	0343	Televisto	0321	Viewsonic	0176, 0203, 0232, 0364		
Sunstar	0320, 0323	Tensai	0282, 0320, 0323, 0340, 0343, 0350	Viking	0057		
Sunwood	0320, 0323, 0343, 0350	Tesmet	0350	Viore	0148		
Superla	0277, 0282, 0342	Tevion	0337, 0343	Visiola	0277, 0342		
Superscan	0013, 0178	Texet	0277, 0282, 0323, 0342	Vision	0282, 0320, 0350		
SuperTech	0277, 0320, 0323	Thomson	0162, 0188, 0189, 0285, 0320, 0322, 0342, 0345, 0350	Vizio	0008, 0177, 0218, 0242, 0500, 0501, 0502, 0503, 0506		
Supra	0323, 0343	Thorn	0320, 0349	Vortec	0320, 0349, 0350		
Supre-Macy	0057	TMK	0008, 0026, 0031	Voxson	0171, 0320, 0339, 0346, 0347, 0350		
Supreme	0055, 0107	TNCi	0030	Waltham	0282, 0320, 0342		
Susumu	0340	Tokai	0282, 0320, 0350	Wards	0008, 0009, 0010, 0026, 0031, 0048, 0049, 0050, 0053, 0054, 0059		
Sutron	0323, 0343	Tokyo	0277, 0342	Watson	0320, 0349, 0350		
SVA	0151	Tomashi	0348	Watt Radio	0277, 0341, 0342		
Sydney	0277, 0282, 0342	Toshiba	0018, 0019, 0040, 0041, 0046, 0073, 0100, 0103, 0108, 0109, 0111, 0121, 0132, 0166, 0208, 0210, 0214, 0217, 0260, 0268, 0282, 0283, 0293, 0304, 0306, 0307, 0329, 0344, 0355, 0454	Waycon	0111		
Sylvania	0008, 0009, 0010, 0011, 0013, 0026, 0048, 0050, 0051, 0128, 0227, 0253			Wega	0320, 0339, 0344		
Symphonic	0051, 0058, 0062, 0128, 0179, 0215			Wegavox	0323		
Syntax	0199	Totevision	0007	Weltblick	0282, 0320, 0349, 0350		
Syntax-Brilliant	0199	Towada	0282, 0347	Westinghouse	0107, 0216, 0220		
Sysline	0349	Trakton	0282	White Westinghouse	0037, 0090, 0277, 0320, 0341, 0342, 0349		
Sytong	0277	Trans Continens	0282, 0320	Wincom	0101, 0106		
Tandy	0178, 0282, 0336, 0340, 0342, 0347	Transtec	0277	Xrypton	0320		
Tashiko	0277, 0282, 0342, 0344, 0346	Trident	0282	Yamaha	0008, 0026, 0050, 0053, 0080, 0081, 0082, 0083, 0086, 0087		
Tatung	0052, 0177, 0282, 0320, 0342, 0349, 0350	Triumph	0320	Yamishi	0282, 0320		
TCM	0337, 0343	Uher	0161, 0171, 0320, 0347, 0350	Yokan	0320		
Teac	0282, 0320	Ultravox	0277, 0320, 0339, 0341, 0342	Yoko	0161, 0277, 0282, 0320, 0323, 0337, 0340, 0342, 0343, 0349, 0350		
Tec	0282, 0323, 0342, 0343	Unic Line	0320				
Technics	0017, 0023, 0056						
TechniSat	0274, 0496, 0497, 0499						

VCR

ABS	1016
Adventura	1069
Adyson	1008
Aiwa	1024, 1026, 1027, 1069
Akai	1021, 1027
Akiba	1008, 1029
Akura	1008, 1027, 1029
Alba	1008, 1009, 1024, 1025, 1029, 1030
Alienware	1016
Ambassador	1030
American High	1068
Amstrad	1008, 1009, 1026
Anitech	1008, 1029
Apex	1088
ASA	1028, 1031
Asha	1070
Asuka	1008, 1026, 1028, 1029, 1031
Audio Dynamics	1064
Audiosonic	1009
Audiovox	1071
Baird	1009, 1025, 1026, 1027
Bang & Olufsen	1017
Basic Line	1008, 1009, 1024, 1025, 1029, 1030
Baur	1028
Beaumarck	1070
Bell & Howell	1065
Bestar	1009, 1025, 1030
Black Panther Line	1009, 1025
Blaupunkt	1028
Bondstec	1008, 1030
Broksonic	1100
Bush	1008, 1009, 1024, 1025, 1029, 1049, 1051, 1063, 1217
Calix	1071
Candle	1070, 1071
Canon	1068
Cathay	1009

Catron	1030	Firstline	1008, 1024, 1029, 1031	iBUYPOWER	1016	Matsushita	1068
CGE	1026, 1027	Fisher	1065	Impego	1030	Media Center PC	1016
Cimeline	1008, 1024, 1029	Flint	1024	Imperial	1026	Mediator	1028
CineVision	1104	Formenti/Phoenix	1028	Inno Hit	1008, 1009, 1025, 1028, 1029, 1030	Medion	1024
Citizen	1070, 1071	Frontech	1030			MEI	1068
Clatronic	1008, 1030	Fuji	1068	Innovation	1024	Memorex	1023, 1026, 1031, 1065, 1068, 1069, 1070, 1071, 1098, 1114
Colortyme	1064	Fujitsu	1026	Instant Replay	1068		
Condor	1009, 1025, 1030	Funai	1026, 1069	Interbuy	1008, 1031	Memphis	1008, 1029
Craig	1070, 1071	Galaxy	1026	Interfunk	1028	MGN Technology	1070
Crown	1008, 1009, 1025, 1029, 1030	Garrard	1069	Intervision	1009, 1026	Micromaxx	1024
		Gateway	1016	Irradio	1008, 1029, 1031	Microsoft	1016
Curtis Mathes	1064, 1068, 1070	GBC	1029, 1030	ITT	1027	Microstar	1024
Cybernex	1070	GE	1068, 1070	ITV	1009, 1025, 1031	Migros	1026
CyberPower	1016	GEC	1028	JC Penney	1064, 1065, 1068, 1070, 1071	Mind	1016
Daewoo	1009, 1025, 1030, 1038, 1069, 1223	Geloso	1029	JCL	1068	Mitsubishi	1026, 1028, 1079
		General	1030	JVC	1007, 1018, 1027, 1039, 1064, 1065, 1066, 1067, 1078, 1089, 1092, 1093, 1094, 1095, 1113, 1208, 1209, 1212, 1213, 1215, 1218	Motorola	1068
Dansai	1008, 1009, 1029	General Technic	1024			MTC	1070
Dantax	1024	GOI	1018			Multitech	1008, 1026, 1028, 1029, 1030, 1069, 1070
Daytron	1009, 1025	GoldHand	1008, 1029			Murphy	1026
DBX	1064	Goldstar	1026, 1031, 1064, 1071			NEC	1027, 1064, 1065
De Graaf	1028	Goodmans	1008, 1009, 1025, 1026, 1029, 1030, 1031	Kaisui	1008, 1029	Neckermann	1027, 1028
Decca	1026, 1027, 1028			Karcher	1028	NEI	1028
Dell	1016	Gradiente	1069	Kendo	1008, 1024, 1025, 1030	Nesco	1008, 1029
Denko	1008	Graetz	1027	Kenwood	1027, 1064, 1065	Nikkai	1008, 1009, 1030
DiamondVision	1096	Granada	1028	Kodak	1068, 1071	Nikko	1071
DigiFusion	1014	Grandin	1008, 1009, 1025, 1026, 1029, 1030, 1031	Korpel	1008, 1029	Niveus Media	1016
DIRECTV	1019, 1105, 1110, 1111, 1113, 1116, 1122	Grundig	1028, 1029	Kyoto	1008	Noblex	1070
		Hanseatic	1009, 1028, 1031	Lenco	1025	Nokia	1009, 1027
Dish Network	1018	Harley Davidson	1069	Leyco	1008, 1029	Nordmende	1027
Dishpro	1018	Harman/Kardon	1064	LG	1010, 1026, 1031, 1047, 1054, 1056, 1071, 1103, 1221	Northgate	1016
Dual	1009, 1027, 1028	Harwood	1008			Oceanic	1026, 1027
Dumont	1026, 1028	HCM	1008, 1029			Okano	1008, 1009, 1024
Durabrand	1114	Headquarter	1065	Lifetec	1024	Olympus	1068
Dynatech	1069	Hewlett Packard	1016	Linksys	1016	Optimus	1071
Echostar	1018	Hinari	1008, 1009, 1024, 1029	Lloyd's	1069	Orion	1023, 1024, 1051, 1115, 1217
Elbe	1009	Hisawa	1024	Loewe Opta	1028, 1031	Orson	1026
Elcatech	1008	Hitachi	1011, 1026, 1027, 1028, 1046, 1062	Logik	1008, 1029	Osaki	1008, 1026, 1029, 1031
Electrohome	1071	HNS	1110	Lumatron	1009, 1025	Otto Versand	1028
Electroponic	1071	Howard Computers	1016	Luxor	1008	Palladium	1008, 1027, 1029, 1031
Elsay	1008			LXI	1071	Panasonic	1000, 1022, 1044, 1055, 1068, 1072, 1085, 1090, 1091, 1120, 1121, 1214
Elta	1008, 1009, 1029	HP	1016	M Electronic	1026	Pathe Marconi	1027
Emerson	1008, 1020, 1068, 1069, 1071	HTS	1018	Magnavox	1020, 1068, 1114, 1126	Perdio	1026
		Hughes	1111, 1113, 1122	Magnin	1071	Philco	1008, 1068
ESC	1009, 1025	Hughes Network Systems	1110, 1116	Manesth	1008, 1029		
Etzuko	1008, 1029			Marantz	1028, 1064, 1065, 1068		
Expressvu	1018	Humax	1012, 1110, 1113	Mark	1009		
Ferguson	1027	Hush	1016	Marta	1071		
Fidelity	1008, 1026	Hypson	1008, 1009, 1024, 1029	Matsui	1024, 1031		
Finlandia	1028						
Finlux	1026, 1027, 1028						

Philips	1006, 1013, 1028, 1035, 1040, 1045, 1046, 1050, 1058, 1059, 1061, 1068, 1076, 1101, 1110, 1113, 1116, 1117, 1122, 1126, 1210, 1211	Sanky	1114	Tandberg	1009	Zenith	1114
Philips Magnavox	1076	Sansui	1023, 1027, 1106, 1115	Tandy	1065	ZT Group	1016
Phonola	1028	Sanyo	1032, 1065, 1070	Tashiko	1026, 1071		
Pilot	1071	Saville	1009	Tatung	1026, 1027, 1028		
Pioneer	1028, 1036	SBR	1028	TCM	1015, 1024, 1042		
Polaroid	1088, 1099	Schaub Lorenz	1026, 1027	Teac	1009, 1069		
Portland	1009, 1025, 1030	Schneider	1008, 1009, 1024, 1025, 1026, 1028, 1029, 1030, 1031	Tec	1008, 1009, 1030		
Prinz	1026			Technics	1068		
Profex	1029	Sears	1065, 1068, 1071	Teknika	1068, 1069, 1071		
Proline	1026	SEG	1008, 1009, 1029	Teleavia	1027		
Proscan	1019	SEI-Sinudyne	1028	Telefunken	1027		
Prosonic	1009, 1024	Seleco	1027	Teletech	1008, 1009		
Pulsar	1114	Sentra	1008, 1030	Tenosal	1008, 1029		
Pye	1028, 1102	Sentron	1008, 1029	Tensai	1008, 1026, 1029, 1031		
Quarter	1065	Sharp	1003, 1033, 1077, 1107, 1127, 1219	Tevion	1024		
Quartz	1065	Shintom	1008, 1029	Thomson	1005, 1027		
Quasar	1068	Shivaki	1031	Thorn	1027		
Quelle	1026, 1028	Shogun	1070	Tivo	1108, 1110, 1111, 1113, 1117, 1118, 1119, 1122		
Radialva	1008	Siemens	1031	TMK	1070		
RadioShack	1071	Silva	1031	Tokai	1008, 1029, 1031		
RadioShack/Realistic	1065, 1068, 1069, 1070, 1071	Silver	1009	Tonsai	1029		
Radiola	1028	Singer	1068	Toshiba	1004, 1016, 1027, 1028, 1037, 1049, 1052, 1086, 1087, 1097, 1109, 1112, 1194		
Radix	1071	Sinudyne	1028	Totevision	1070, 1071		
Randex	1071	Solavox	1030	Touch	1016		
RCA	1019, 1068, 1070, 1075, 1110, 1113, 1122, 1125	Sonic Blue	1022, 1123	Towada	1008, 1029		
Realistic	1065, 1068, 1069, 1070, 1071	Sonneclair	1008	Towika	1008, 1029		
ReplayTV	1022, 1123	Sonoko	1009, 1025	TVA	1030		
Rex	1027	Sontec	1031	Uher	1031		
RFT	1008, 1028, 1030	Sony	1001, 1016, 1048, 1053, 1073, 1074, 1080, 1081, 1082, 1083, 1108, 1118, 1216	UltimateTV	1019		
Ricavision	1016			Ultravox	1009		
Roadstar	1008, 1009, 1025, 1029, 1031	Stack	1016	Unitech	1070		
Royal	1008	Stack 9	1016	United Quick Star	1009, 1025		
Runco	1114	Standard	1009, 1025	Universum	1026, 1028, 1031		
Saba	1027	Stern	1009	Vector Research	1064		
Saisho	1024, 1029	STS	1068	Video Concepts	1064		
Samsung	1002, 1034, 1041, 1043, 1057, 1060, 1070, 1084, 1110, 1116, 1122, 1124, 1220, 1222	Sunkai	1024	Videon	1024		
Samurai	1008, 1030	Sunstar	1026	Videosonic	1070		
		Suntronic	1026	Viewsonic	1016		
		Sunwood	1008, 1029	Voodoo	1016		
		Superscan	1020	Wards	1068, 1069, 1070, 1071		
		Sylvania	1020, 1068, 1069, 1102, 1126	Weltblick	1031		
				XR-1000	1068, 1069		
		Symphonic	1008, 1069, 1126	Yamaha	1064, 1065		
		Systemax	1016	Yamishi	1008, 1029		
		Tagar Systems	1016	Yokan	1008, 1029		
		Taisho	1024	Yoko	1008, 1029, 1030, 1031		

DVD

4Kus	2051
Accurian	2142
Advent	2155, 2251
AEG	2362
Airis	2364
Aiwa	2322
Akai	2145, 2177, 2179, 2248
Akura	2356
Alba	2064, 2165, 2186, 2337, 2346
Alco	2149
Alize	2361
Allegro	2133
Amitech	2362
Amphion MediaWorks	2195
AMW	2195, 2363
Apex	2030, 2124, 2125, 2126, 2127, 2130, 2131
Apple	2241
Arrgo	2138
Asono	2364
Aspire	2152, 2222
Astar	2240
ATACOM	2364
Audiovox	2061, 2149
Avioius	2367
Awa	2363
Axion	2249
Bang & Olufsen	2128
Baze	2367
BBK	2364
Bellagio	2363
Best Buy	2359
Blaupunkt	2131
Blue Parade	2157
Boghe	2382
Brainwave	2362
Brandt	2148, 2188
Broksonic	2145, 2146
Bush	2064, 2110, 2170, 2268, 2290, 2346, 2358, 2367, 2383

California Audio Labs	Elta	2341, 2361, 2362	2260, 2262, 2263, 2321,	Minowa	2367
2151	Emerson	2129, 2137, 2150	2324, 2326, 2327, 2343,	Mintek	2131, 2245
Cambridge Audio	Enterprise	2129	2464, 2465, 2468, 2469,	Mitsubishi	2003
CAT	Enzer	2380	2471	Mizuda	2358, 2359
CAVS	Epson	2247	Jwin	Monyka	2380
Centrum	ESA	2137	Kansai	Mustek	2186
CGV	Finlux	2354, 2362, 2367	Kawasaki	Mx Onda	2354
Changhong	Fintec	2377	Kennex	Mystral	2366
Cinetec	Fisher	2134	Kenwood	Naiko	2362
CineVision	Funai	2137	KeyPlug	Nesa	2131
Clatronic	Gateway	2051	Kiuro	Neufunk	2380
Coby	GE	2029, 2131, 2156	Kingavon	Nevir	2362
Conia	Gericom	2351	Kiss	Next Base	2143
Continental Edison	GFM	2226	KLH	Nexxtech	2243
2363	Giec	2382	Koda	NU-TEC	2383
Crown	Global Solutions	2355	Koss	Onkyo	2159, 2368
2362	Global Sphere	2355	KXD	Oopla	2051
C-Tech	Go Video	2133, 2213	Landel	Oppo	2196, 2255
Curtis Mathes	Goodmans	2165, 2280, 2291, 2358,	Lasonic	Optim	2381
2139	2371, 2376, 2382	GPX	Lawson	Optimus	2180
CVG	2336	2227	Lecson	Orava	2358
CyberHome	Cytron	2244	Lenco	Orbit	2363
2022, 2098, 2138, 2187,	Daenyx	2363	Lenoxx	Orion	2073, 2110
2336	Daewoo	2001, 2133, 2276, 2298,	LG	Oritron	2148, 2158
2336	2330, 2362, 2363, 2377	Daewoo International	Life	P&B	2358
2336	2363	2363	Lifetec	Pacific	2355
Dalton	Dansai	2357	Limit	Panasonic	2011, 2024, 2034, 2042,
2362, 2381	Daytek	2184, 2195, 2363	Liquid Video	2058, 2062, 2066, 2067,	
Dayton	DEC	2358	Liteon	2093, 2116, 2117, 2118,	
2363	Decca	2362	Loewe	2119, 2120, 2121, 2122,	
Denon	Denon	2059, 2151, 2193, 2332	LogicLab	2123, 2151, 2159, 2164,	
2356, 2358, 2360, 2370	Denzel	2380	Magnavox	2166, 2167, 2172, 2173,	
Desay	Desay	2205	2025, 2050, 2137, 2150,	2175, 2209, 2214, 2275,	
Diamond	DiamondVision	2225, 2232	2159, 2224, 2230, 2358	2277, 2278, 2281, 2282,	
2010, 2028	Disney	2010, 2028	2367	2283, 2301, 2374, 2470	
DK Digital	Decca	2362	Magnex	Parasound	
Dmtech	Denon	2059, 2151, 2193, 2332	Majestic	peeKTON	
2176	Denver	2356, 2358, 2360, 2370	Marantz	2364	
Dual	Denzel	2380	Marquant	Philips	
Durabrand	Desay	2205	Matsui	2008, 2012, 2025, 2044,	
DVX	Diamond	2354, 2355	McIntosh	2050, 2051, 2053, 2060,	
2355	DiamondVision	2225, 2232	Mecotek	2072, 2108, 2111, 2147,	
Easy Home	Disney	2010, 2028	Medion	2159, 2163, 2169, 2174,	
2354	DK Digital	2339	Memorex	2181, 2185, 2230, 2261,	
Eclipse	Dmtech	2176	MiCO	2266, 2267, 2286, 2287,	
2364	Dual	2380	Micromaxx	2289, 2295, 2300, 2302,	
Electrohome	Durabrand	2136	Microsoft	2317, 2328, 2338, 2342,	
2362	DVX	2355	Microstar	2350, 2467	
Elin	Easy Home	2359	Minoka	Phonotrend	
2362	Eclipse	2354		Pioneer	
	Elin	2362		2016, 2017, 2018, 2019,	
	Electrohome	2362		2035, 2092, 2094, 2095,	
	Elin	2362		2109, 2157, 2180, 2190,	

2212, 2269, 2272, 2299,
 2304, 2305, 2306, 2307,
 2308, 2309, 2310, 2311,
 2344, 2345, 2347, 2379
 Pointer 2362
 Polaroid 2125, 2215, 2235
 Portland 2362
 Powerpoint 2363
 Prima 2252
 Proceed 2130
 Proscan 2156
 Prosonic 2360, 2377
 Protron 2202
 Provision 2358
 Pye 2144
 Qwestar 2148
 Raite 2380
 RCA 2021, 2029, 2104, 2105,
 2131, 2149, 2156, 2157,
 2229
 RedStar 2356, 2360, 2362
 Regent 2153
 Reoc 2355
 Rimax 2361
 Rio 2133
 Roadstar 2331, 2358
 Ronin 2363
 Rotel 2203
 Rowa 2154, 2383
 Rownsonic 2353
 Saba 2148, 2188
 Sabaki 2355
 Saivod 2362
 Sampo 2141
 Samsung 2000, 2045, 2077, 2112,
 2113, 2114, 2115, 2151,
 2200, 2216, 2219, 2228,
 2264, 2265, 2271, 2279,
 2294, 2303, 2329, 2365
 Sansui 2073, 2145, 2354, 2355,
 2362
 Sanyo 2134, 2145, 2217, 2292
 ScanMagic 2186
 Schaub Lorenz 2362
 Schneider 2176
 Scientific Labs 2355
 Scott 2161, 2357
 Seeltech 2364
 SEG 2162, 2355, 2363, 2380

Sharp 2006, 2040, 2088, 2091,
 2182, 2194, 2220, 2221,
 2231, 2236, 2293, 2340
 Shinsonic 2245
 Sigmatek 2359, 2364
 Silva 2356
 Singer 2354, 2355
 Skymaster 2325, 2355
 Skyworth 2356
 Slim Art 2362
 SM Electronic 2355
 Sonic Blue 2133
 Sontech 2366
 Sony 2004, 2005, 2007, 2009,
 2014, 2015, 2023, 2026,
 2027, 2052, 2068, 2069,
 2070, 2071, 2074, 2075,
 2084, 2085, 2087, 2168,
 2171, 2208, 2210, 2211,
 2258, 2273, 2284, 2285,
 2312, 2313, 2314, 2315,
 2318, 2319, 2466
 Soundmaster 2355
 Soundmax 2355
 Spectra 2363
 Spectroniq 2201
 Standard 2355
 Star Cluster 2355
 Starmedia 2358, 2364
 Sungale 2204
 Sunkai 2362
 Superscan 2150
 Supervision 2355
 Sylvania 2012, 2137, 2150, 2178,
 2230, 2239
 Symphonic 2108, 2230
 Synn 2355
 T.D.E. Systems 2366
 Tatung 2001, 2362
 TCM 2182, 2297
 Teac 2149, 2333, 2355, 2383
 Tec 2356
 Technics 2151
 Technika 2362, 2367
 Telefunken 2353
 Tensai 2362
 Tevion 2182, 2355, 2357
 Theta Digital 2157
 Thomson 2183, 2188, 2334, 2372
 Tokai 2356, 2380

Top Suxess 2364
 Toshiba 2032, 2036, 2037, 2039,
 2048, 2049, 2054, 2055,
 2072, 2073, 2076, 2078,
 2079, 2086, 2145, 2159,
 2218, 2233, 2256, 2259,
 2296, 2369
 TRANScontinents 2363, 2367
 Transonic 2367
 Trio 2362
 Trutech 2242
 TruVision 2359
 TSM 2364
 Umax 2361
 United 2367
 Urban Concepts 2159
 US Logic 2245
 Venturer 2149
 Viewmaster 2364
 Vocopro 2206
 VocoStar 2207
 Waitec 2364
 Welltech 2382
 Westinghouse 2063, 2250
 Wharfedale 2354, 2355
 Woxter 2361, 2364
 Xbox 2156, 2183
 Xlogic 2355, 2362
 XMS 2362
 Xoro 2382
 Yamada 2051, 2361, 2363
 Yamaha 2056, 2064, 2065, 2080,
 2081, 2082, 2083, 2089,
 2118, 2151, 2323
 Yamakawa 2363, 2380
 Yukai 2186
 Zenith 2002, 2129, 2133, 2159,
 2223

Blu-ray Disc

JVC 2475
 LG 2033
 Panasonic 2011, 2209, 2214
 Pioneer 2212
 Samsung 2045, 2113
 Sharp 2194, 2220, 2221
 Sony 2075
 Yamaha 2064, 2474

DVR

Bush 2110
 Hitachi 2090
 Panasonic 2066, 2067, 2093, 2116,
 2117, 2119, 2120, 2122,
 2123
 Philips 2108, 2111
 Pioneer 2016, 2017, 2018, 2019,
 2092, 2094, 2095, 2109
 2105
 RCA 2113, 2219
 Samsung 2088, 2091
 Sharp 2084, 2085, 2087
 Sony 2086, 2218
 Toshiba 2475
 Victor 2089, 2118
 Yamaha

DVD Recorder

Aspire 2222
 Astar 2240
 Broksonic 2146
 Go Video 2213
 Hitachi 2062
 Insignia 2002
 Irradio 2053
 JVC 2100, 2101, 2106, 2107
 LG 2033, 2057, 2223, 2238
 Liteon 2043
 Panasonic 2011, 2034, 2058, 2062,
 2116, 2117, 2119, 2120,
 2121, 2123
 Philips 2008, 2044, 2050, 2051,
 2147
 Pioneer 2017, 2035
 Pye 2144
 Samsung 2000, 2112, 2216
 Sansui 2073
 Sanyo 2217
 Sony 2004, 2005, 2007, 2052,
 2068, 2069, 2074, 2208,
 2210, 2211
 2239
 Sylvania 2032, 2036, 2037, 2039,
 2049, 2054, 2055, 2076
 Toshiba
 Yamaha 2056

Cable

ABC	3002, 3003, 3017, 3066, 3067, 3086, 3093, 3119, 3122
ADB	3020
Adelphia	3081
Alcatel	3016
Americast	3124
Amstrad	3022, 3098
Antronix	3065, 3070
Archer	3070
Arcon	3098
AT&T	3095
Axis	3098
Bell South	3124
Cable Vision	3092
Cabletenna	3065
Cabletime	3104
Cableview	3087
Clearmaster	3127
ClearMax	3127
Clyde Cablevision	3105
Colour Voice	3068
Comcast	3084, 3088, 3117
Comcrypt	3107
Comtronics	3069
Contec	3074
Coolmax	3127
COX	3084
Cryptovision	3110
Director	3084
Eastern	3075
Everquest	3123
Fidelity	3098
Filmnet	3107
Filmnet Cablecrypt	3111
Filmnet Comcrypt	3111
Finlux	3097
Focus	3126
Foxtel	3022
France Telecom	3100, 3101
Freebox	3023
GC Electronics	3070
GE	3066, 3093
GEC	3105
Gemini	3072, 3123

General Instrument

	3017, 3025, 3066, 3084, 3090, 3096, 3117
Goldstar	3120
Gooding	3099
Grundig	3098, 3099
Hamlin	3073, 3078
Hirschmann	3097
Hitachi	3066
HomeChoice	3106
Humax	3021, 3080, 3083
ITT Nokia	3097
Jasco	3123
Jerrold	3017, 3018, 3025, 3066, 3072, 3084, 3090, 3096, 3119, 3123
JVC	3099
Kabel Deutschland	3024, 3027, 3121
Macab	3101
Magnavox	3079
Maspro	3099
Matsui	3099
MegaCable	3117
Memorex	3076, 3122
Minerva	3099
Mnet	3107
Motorola	3025, 3026, 3084, 3088, 3090, 3095, 3117
Movie Time	3077, 3109
Mr Zapp	3101
Multichoice	3107
Multitech	3127
NEC	3064
NET Brazil	3085
Nokia	3097
Noos	3101
NSC	3077
Oak	3074
Pace	3006, 3089, 3121
Palladium	3099
Panasonic	3112, 3118, 3122
Paragon	3122
Philips	3068, 3071, 3079, 3099, 3100, 3101, 3103
Pioneer	3001, 3006, 3094, 3098, 3114, 3116, 3120
Popular Mechanics	3126
Proscan	3066, 3093

Pulsar	3122
PVP Stereo Visual Matrix	3018
Quasar	3122
RadioShack	3123, 3127
RCA	3030, 3031, 3087, 3118
Realistic	3070
Recoton	3126
Regal	3078
Regency	3075
Rembrandt	3066
Runco	3122
Sagem	3101
Samsung	3069, 3089, 3114, 3120
SAT	3098
Scientific Atlanta	3000, 3001, 3002, 3003, 3006, 3028, 3029, 3081, 3086, 3089, 3094, 3095, 3108
Signal	3072, 3123
Signature	3066
Sony	3092, 3125
Sprucer	3118
Standard Component	3115
Starcom	3017, 3072, 3119, 3123
Stargate	3072, 3123
Starquest	3072, 3123
Supercable	3090
Supermax	3127
Tele+1	3107, 3111
Telepiu	3107
Thomson	3082, 3091
TIME WARNER	3084
Tocom	3067
Torx	3017
Toshiba	3122
Tristar	3127
Tudi	3102
Tusa	3072, 3123
TV86	3077
Unika	3065, 3070
United Cable	3018, 3119
Universal	3065, 3070
Universon	3097, 3099
V2	3127
Videoway	3019
View Star	3074, 3077, 3079
Viewmaster	3127
Vision	3127

Visiopass	3097, 3100, 3101
Vortex View	3127
Wittenberg	3098
Zenith	3113, 3122, 3124
Zentek	3126

Satellite

AB Sat	4216, 4217
AccessHD	4104
ADB	4220
AGS	4216
Akai	4053, 4055
Alba	4001, 4004, 4006, 4007, 4062, 4217
Aldes	4005, 4007, 4010
Allsat	4048, 4053, 4055
Allsonic	4005, 4008, 4024
Alltech	4217
Alpha	4053
Alpha Digital	4104
Alphastar	4077
Amitronica	4217
Amstrad	4011, 4035, 4217, 4218
Anglo	4217
Ankaro	4005, 4008, 4024, 4217
Anttron	4001, 4004
Apollo	4001
Armstrong	4011, 4053
Artec	4100
Asat	4053, 4055
ASLF	4217
Astacom	4216
Astra	4009, 4011, 4054, 4217, 4219
Astro	4004, 4008, 4010, 4015, 4024, 4213, 4218, 4219
AudioTon	4004, 4048
Aurora	4222
Austar	4222
Axiel	4216
Axis	4008, 4009, 4024, 4050
Best	4008, 4024
Blaupunkt	4015
Blue Sky	4217
Boca	4011, 4054, 4059, 4217
Boston	4216
Brain Wave	4013
Broadcast	4012

Broco	4217	Dishpro	4018, 4117	Goldbox	4213	Kosmos	4049
BSkyB	4035, 4041	Distrisat	4053	GoldStar	4049	KR	4004
BT	4216	Ditristrad	4048	Goodmans	4002, 4006, 4029	Kreiselmeier	4015
Bubu Sat	4217	DNT	4014, 4053, 4055	Goodmind	4111	K-SAT	4217
Bush	4006, 4045	Drake	4072	Grandin	4031	Kyostar	4001
Cambridge	4218	DStv	4222	Grothusen	4001, 4049	L&S Electronic	4024
Canal Satellite	4213	Dune	4024	Grundig	4004, 4006, 4015, 4035, 4211, 4218, 4222	Lasat	4008, 4010, 4024, 4054, 4212, 4215, 4219
Canal+	4213	Echostar	4014, 4018, 4065, 4089, 4117, 4217	Hänsel & Gretel	4219	Lasonic	4108
CaptiveWorks	4099	Einhell	4001, 4005, 4011, 4217, 4218	Hantor	4001, 4013	Lenco	4001, 4024, 4049, 4215, 4217, 4219
Channel Master	4007, 4110	Elap	4216, 4217	Hanuri	4010	Leng	4013
Chaparral	4075	Elekta	4010	Hauppauge	4044	Lennox	4048
CHEROKEE	4216	Elsat	4217	Helium	4219	Lenson	4218
Chess	4212, 4217	Elta	4001, 4008, 4024, 4048, 4053, 4055	Hinari	4007	Lexus	4053
CityCom	4006, 4215, 4219	Emanon	4001	Hirschmann	4015, 4024, 4210, 4216, 4218, 4219	LG	4049, 4103, 4107
Clatronic	4013	Emme Esse	4008, 4024	Hisawa	4013	Lifesat	4008, 4024, 4212, 4217
CNT	4010	Engel	4217	Hisense	4016	Lifetec	4008
Comag	4080, 4081, 4082, 4083, 4086	Ep Sat	4006	Hitachi	4006, 4114, 4199, 4203	Lorenzen	4219
Commlink	4005	EURIEULT	4031	Homecast	4084, 4085, 4087	Lorraine	4049
Comtech	4050	Eurodec	4052	Houston	4048	Lupus	4008, 4024
Condor	4008, 4024, 4219	Europa	4053, 4218, 4219	HTS	4117	Luxor	4218
Connexions	4014, 4024	Europhon	4219	Hughes	4064, 4068, 4192, 4194, 4196, 4202	Lyonnaise	4052
Conrad	4024, 4215, 4218, 4219	Eurosats	4011	Hughes Network Systems	4071	Macab	4052
Conrad Electronic	4217, 4219	Eurosky	4008, 4011, 4215, 4218, 4219, 4024	Humax	4025, 4030, 4060, 4097	Magnavox	4127, 4101
Contec	4050	Eurostar	4011, 4215, 4219	Huth	4005, 4011, 4012, 4013, 4048, 4050, 4219, 4223	Manata	4031, 4216, 4217
Coolsat	4096	Eutelsat	4217	Hypson	4031	Manhattan	4006, 4010, 4048, 4216
Cosat	4048	Exator	4001, 4004	Ilo	4016	Marantz	4055
Coship	4109	Expressvu	4117	Imex	4031	Mascom	4010
Crown	4011	Fenner	4024, 4212, 4217	Innovation	4008	Maspro	4006, 4217
Daeryung	4014	Ferguson	4006, 4052, 4214	Insignia	4107	Matsui	4216
Daewoo	4057, 4217	Fidelity	4218	Intertronic	4011	Max	4219
DDC	4007	Finlandia	4006	Intervision	4048, 4219	Mediabox	4213
Delega	4007	Finlux	4006	ITT Nokia	4006	Mediamarkt	4011
Dew	4050	FinnSat	4050, 4052	Jerrold	4019	Mediasat	4009, 4213, 4218
Diamond	4051	Flair Mate	4217	Johansson	4013	Medion	4008, 4024, 4217
Digiality	4219	Foxtel	4222	JOK	4216	Medison	4217
Digital Stream	4105	Freecom	4001, 4049, 4218	JSR	4048	Mega	4053, 4055
DIRECTV	4056, 4064, 4067, 4068, 4070, 4071, 4074, 4107, 4116, 4119, 4121, 4122, 4123, 4127, 4192, 4193, 4194, 4195, 4196, 4197, 4198, 4199, 4200, 4201, 4202, 4203, 4206, 4207, 4221	FTEmaximal	4024, 4217	JVC	4029, 4065, 4089, 4117	Memorex	4127
Discoverer	4212	Fuba	4001, 4008, 4014, 4015, 4024, 4055, 4215	Kamm	4217	Metronic	4001, 4004, 4005, 4010, 4028, 4031, 4217
Discovery	4216	Galaxis	4005, 4008, 4009, 4024, 4048, 4050, 4215, 4222	Kathrein	4015, 4034, 4042, 4053, 4055, 4063, 4215, 4216, 4217	Metz	4015
Diseqc	4216	GE	4066, 4093, 4111, 4197	Kathrein Eurostar	4215	Micro electronic	4217, 4218, 4219
Dish Network	4018, 4065, 4089, 4092, 4094, 4095, 4117	General Instrument	4019, 4073	Klap	4216	Micro Technology	4217
		GMI	4011	Konig	4219	MicroGem	4106
		GOI	4117			Micromaxx	4008, 4024
						Microstar	4008
						Microtec	4217
						Minerva	4015
						Mitsubishi	4006, 4015, 4202

Mitsumi	4054	Pioneer	4046, 4213	Schwaiger	4051, 4212, 4219	Teleka	4004, 4011, 4014, 4218, 4219
Morgan's	4011, 4053, 4054, 4055, 4217	Polsat	4052	SCS	4215	Telemaster	4010
Motorola	4019, 4088, 4090, 4091	Predki	4013	Seemann	4009, 4011, 4014	Telesat	4219
Multichoice	4222	Premiere	4048, 4213	SEG	4001, 4008, 4013, 4024	Telesat	4212, 4213, 4218
Multitec	4212	Priesner	4011	Seleco	4048	Televest	4006, 4218
Muratto	4049	Primestar	4076	Servi Sat	4031, 4217	Telewire	4048
Mysat	4217	Profile	4216	Siemens	4015	Tempo	4223
Navex	4013	Promax	4006	Silva	4049	Tevion	4008, 4217
Neuhaas	4009, 4048, 4217, 4218, 4219	Prosat	4005, 4007	Skantin	4217	Thomson	4006, 4020, 4052, 4058, 4208, 4213, 4215, 4216, 4217, 4219
Neusat	4217	Proscan	4066, 4093, 4122, 4197	Skardin	4009	Thorens	4051
Next Level	4019	Protek	4051	Skinsat	4218	Thorn	4006
NextWave	4223	Proton	4016	SKR	4217	Tivax	4104
Nikko	4011, 4217	Provision	4010	Skymaster	4005, 4017, 4022, 4212, 4217	Tivo	4196
Nokia	4006, 4040	Quadral	4005, 4007, 4008, 4216, 4024	Skymax	4053, 4055	Tokai	4053
Nordmende	4001, 4006, 4007, 4010, 4052	Quelle	4015, 4215, 4219	SkySat	4212, 4217, 4218, 4219	Tonna	4006, 4012, 4048, 4217, 4218
Nova	4222	Quiero	4052	Skyvision	4048	Toshiba	4194, 4202, 4203
Novis	4013	RadioShack	4019	SM Electronic	4212, 4217	Triad	4049
Oceanic	4051	Radiola	4053, 4055	Smart	4215, 4217	Triasat	4218
Octagon	4001, 4004, 4050	Radix	4014, 4037	Sony	4067, 4070, 4213	Triax	4015, 4215, 4217, 4218
Okano	4011	Rainbow	4004	SR	4011, 4054	Turnsat	4217
Optex	4048	RCA	4066, 4093, 4112, 4113, 4116, 4118, 4119, 4197, 4122, 4207	Star Choice	4019	Tvonic	4214
Optus	4213, 4222, 4223	Realistic	4078	Starland	4217	Twiner	4031, 4217
Orbitech	4001, 4212, 4213, 4218	Redpoint	4009	Starring	4013	UEC	4222
OSat	4004	Redstar	4008, 4024	Start Trak	4001	Uher	4212
Otto Versand	4015	RFT	4005, 4053, 4055	Strong	4001, 4004, 4008, 4024, 4049, 4222	UltimateTV	4070
Pace	4006, 4015, 4035, 4043, 4047, 4216	Roadstar	4217	STS	4115	Uniden	4079, 4127
Pacific	4051	Roch	4031	STVI	4031	Unisat	4011, 4050, 4053
Packsat	4216	Rover	4024, 4217	Sumida	4011	Unitor	4013
Palcom	4007	Saba	4010, 4215, 4216, 4219	Sunny Sound	4024	Universum	4015, 4215, 4219
Palladium	4011, 4218	Sabre	4006	Sunsat	4217	US Digital	4016
Palsat	4212, 4218	Sagem	4023, 4052	Sunstar	4011, 4024, 4054	Variosat	4015
Panasat	4222	Sakura	4050	Supermax	4223	Vega	4024
Panasonic	4006, 4035, 4036, 4121, 4124, 4126, 4198, 4221	Samsung	4000, 4001, 4003, 4032, 4064, 4069, 4071, 4120, 4123, 4196, 4200	Tandberg	4052	Ventana	4053, 4055
Panda	4006, 4219	SAT	4007, 4218	Tandy	4004	Viewsat	4098
Pansat	4125	Sat Cruiser	4223	Tantec	4006	Visiosat	4013, 4048, 4216, 4217
Patriot	4216	Sat Partner	4001, 4004, 4010, 4013, 4049, 4218	TCM	4008	Voom	4019
Paysat	4127	Sat Team	4217	Techniland	4012	Vortec	4001
PCT	4110	Satcom	4012, 4219	TechniSat	4014, 4021, 4026, 4027, 4038, 4039, 4053, 4212, 4213, 4218	Welltech	4212
Philco	4101	Satec	4217	Technology	4222	WeTeKom	4212, 4218
Philips	4006, 4033, 4053, 4055, 4061, 4068, 4071, 4127, 4196, 4201, 4202, 4203, 4206, 4213, 4216	Sateleco	4024	Technowelt	4223	Wevasat	4006
Phoenix	4050	Sattford	4012	Teco	4219	Wewa	4006
Phonotrend	4006, 4005, 4048	Satmaster	4012	Telanor	4011, 4054	Winersat	4013
		Satplus	4212	Telasat	4007	Wisi	4006, 4014, 4015, 4218, 4219
		Schneider	4008, 4212, 4216	Telecom	4215, 4219	Woorisat	4010
				Telefunken	4217	Worldsat	4216

Xrypton 4024
XSat 4217
Zehnder 4008, 4209, 4010, 4215,
4024
Zenith 4102, 4107, 4195
Zodiac 4004

CD

Yamaha 5082, 5095

CD Recorder

Yamaha 5083

MD

Yamaha 5080, 5081, 5086

Tape

Yamaha 5084, 5087

Tuner

Yamaha 5066, 5085, 5088, 5090,
5092

XM

Yamaha 5091, 5093

SIRIUS

Yamaha 5064, 5067

DOCK

Yamaha 5068, 5089

NET

Yamaha 5071, 5076, 5079, 5094

LD

Yamaha 2080

Amplifier

Yamaha 5019, 5020, 5098

Apple TV

Apple 2241

“Apple TV” is a trademark or registered mark of Apple Inc.