



**HTR-3064**

**AV Receiver**

**Owner's Manual**

**English for North America**

# CONTENTS

## INTRODUCTION

<b>Features and capabilities</b> .....	3
About this manual .....	4
Supplied accessories .....	4
<b>Part names and functions</b> .....	5
Front panel .....	5
Rear panel .....	6
Front panel display .....	7
Remote control .....	8

## CONNECTIONS

<b>Connecting speakers</b> .....	9
Speaker channels and functions .....	9
Speaker layout .....	10
Connecting speakers .....	10
<b>Connecting external devices</b> .....	13
Cable plugs and jacks .....	13
Connecting a TV monitor .....	14
Connecting BD/DVD players and other devices .....	16
Connecting video cameras and portable audio players ..	20
Transmitting input A/V to external devices .....	20
<b>Connecting the FM/AM antennas</b> .....	21
<b>Setting up speaker parameters</b> .....	22
STEP 1: Display the setting menu .....	22
STEP 2: Set the speaker status and size .....	22
STEP 3: Set the distance from the listening point .....	23
STEP 4: Playback a test tone .....	24
STEP 5: Adjust the volume .....	24

## PLAYBACK

<b>Basic playback procedure</b> .....	25
Adjusting high/low-frequency sound (Tone control) .....	25
<b>Changing input settings with a single key</b> <b>(SCENE function)</b> .....	26
Registering input sources/sound field program .....	26

<b>Enjoying sound field programs</b> .....	26
Selecting sound field programs and sound decoders .....	26
Sound field programs .....	28
<b>FM/AM tuning</b> .....	30
Selecting a frequency for reception (Normal tuning) .....	30
Registering and recalling a frequency (Preset tuning) ...	31
Clearing preset stations .....	32
<b>Playing back tunes from your iPod™/iPhone™</b> .....	34
Connecting the Yamaha iPod universal dock .....	34
Controlling an iPod/iPhone .....	34
<b>Playing back tunes from Bluetooth™ components</b> .....	36
Connecting a Yamaha Bluetooth wireless audio receiver .....	36
Pairing Bluetooth™ components .....	36
Using Bluetooth™ components .....	37

## SETUP

<b>Configuring the settings specific for each input source</b> <b>(Option menu)</b> .....	38
Option menu display and setup .....	38
Option menu items .....	38
<b>Setting various functions (Setup menu)</b> .....	41
Setup menu display and settings .....	41
Setup menu items .....	41
Manages settings for speakers .....	42
Setting the audio output function of this unit .....	45
Setting HDMI functions .....	46
Making the receiver easier to use .....	48
Setting sound field program parameters .....	49
Prohibiting setting changes .....	49
<b>Setting sound field program parameters</b> .....	50
Setting sound field parameters .....	50
<b>Controlling other components with the</b> <b>remote control</b> .....	52
Keys connecting external components .....	52
Default remote control code settings .....	52

Registering remote control codes for external component operations .....	53
Resetting all remote control codes .....	54

<b>Extended functionality that can be configured</b> <b>as needed (Advanced Setup menu)</b> .....	55
Displaying/Setting the Advanced Setup menu .....	55
Setting the impedance of speakers .....	55
Avoiding crossing remote control signals when using multiple Yamaha receivers .....	56
Initializing various settings for this unit .....	56
<b>Using the HDMI Control function</b> .....	57

## APPENDIX

<b>Troubleshooting</b> .....	60
General .....	60
HDMI™ .....	63
Tuner (FM/AM) .....	63
Remote control .....	64
iPod™/iPhone™ .....	65
Bluetooth™ .....	65
<b>Glossary</b> .....	66
Audio information .....	66
Sound field program information .....	67
Video information .....	67
<b>Information on HDMI™</b> .....	68
<b>About trademarks</b> .....	68
<b>Specifications</b> .....	69
<b>Index</b> .....	70



# INTRODUCTION





## Features and capabilities

■ <b>Built-in high-quality, high-power 5-channel amplifier</b>	
■ <b>1-button input/sound field program switching (SCENE function)</b> .....	26
■ <b>Speaker connections for 2- to 5.1-channel configurations</b>	
– Speaker channels and functions .....	9
– Speaker layout .....	10
– Speaker cable connection .....	10
– Speaker impedance configuration .....	10
– Subwoofer cable connection .....	12
■ <b>Acoustic parameter adjustment to match your speakers and listening environment</b>	
– Setting for speaker acoustic parameters .....	22
– Specifying the settings for each speaker .....	42
– Volume control for each speaker .....	43
– Speaker distance settings .....	43
– Sound quality control with the equalizer <Graphic Equalizer> .....	44
– Test tone speaker adjustment .....	44
– Bass and treble level adjustment <Tone Control> .....	25
■ <b>External device connection and playback</b>	
– Cables and input/output jacks for this unit .....	13
– TV connection .....	14
– TV audio playback through this receiver .....	15
– Connections for BD/DVD players (recorders) and other devices .....	16
– Audio signal output to the TV connected via the HDMI jack .....	47
– Correction of lag between audio and video signals <Lipsync> .....	45
– External audio and video recorder connections .....	20
– HDMI/AV video input combining other audio input .....	39
– Front panel external device connections (for video cameras, portable music players, etc.) .....	20
– Protective cover for front panel jacks .....	4
– Changing the input source names <Input Rename> .....	48
– Configuring the settings specific for each input source <Option menu> .....	38
– Playback from external devices .....	25
– Playback from an iPod/iPhone (iPod/iPhone and components sold separately) .....	34
– Playback from a Bluetooth component (Bluetooth and components sold separately) .....	36
■ <b>FM/AM Tuner</b>	
– FM/AM broadcast listening .....	30
– Simple preset tuning .....	31
■ <b>Multi-channel, multi-format playback</b>	
– Sound field effect selection .....	26
– Playback without sound field effects .....	27
– Stereo playback .....	27
– Sound field effect configuration .....	50
– Compressed-music playback .....	26
■ <b>Front panel information display</b>	
– Front panel display information switching .....	7
– Front panel display brightness adjustment <Dimmer> .....	49
– Digital video/audio signal information display <Signal Info> .....	39
■ <b>Volume/sound quality adjustment functions</b>	
– Easy listening at low volumes <Adaptive DRC> .....	45
– Maximum volume settings .....	46
– Startup volume settings .....	46
– Adjusting volume between input sources <Volume Trim> .....	39
■ <b>Remote control operation</b>	
– Remote control names and functions .....	8
– Insert batteries into the remote control .....	4
– External device operation with this unit's remote control .....	52
– Multiple Yamaha receiver operation without signal interference <Remote ID Switching> .....	56
■ <b>Other features</b>	
– Standby mode after prolonged non-operation <Auto Power Down function> .....	49
– Standby mode after a specific amount of time <Sleep timer> .....	8
– To charge the iPod/iPhone when this unit is in standby mode <iPod Standby Charge> .....	35
– Initializing various settings for this unit .....	56
– Prohibiting setting changes <Memory Guard> .....	49



## About this manual

- This manual is printed prior to production. Design and specifications are subject to change in part as a result of improvements, etc. In case of differences between the manual and product, the product has priority.
- “**4**HDMI1” (example) indicates the name of the parts on the remote control. Refer to the “Remote control” (p. 8) for the information about each position of the parts.
-  1 indicates that the reference is in the footnote. Refer to the corresponding numbers on the bottom of the page.
-  indicates the page describing the related information.
- Click on the “ ” at the bottom of the page to display the corresponding page in “Part names and functions.”

-  Front panel
-  Rear panel
-  Front panel display
-  Remote control

## Supplied accessories

Check that you received all of the following parts.

- Remote control
- Batteries (AAA, R03, UM-4) x 2
- AM loop antenna
- Indoor FM antenna
- VIDEO AUX input cover

### ■ Attaching the VIDEO AUX input cover (included)

To protect against dust, attach the supplied VIDEO AUX input cover to the VIDEO AUX jacks when you do not use the jacks. To remove the cover, push the left section of it.

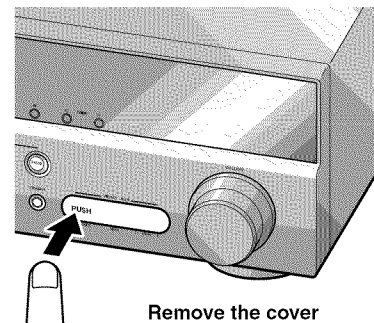
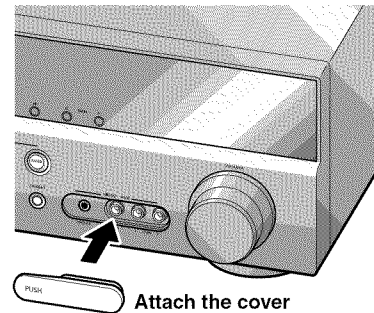

### ■ Installing batteries in the remote control

When inserting batteries in the remote control, remove the battery compartment cover from the reverse side of the remote control, and insert two AAA batteries into the battery compartment so that they match with the polarity markings (+ and -).

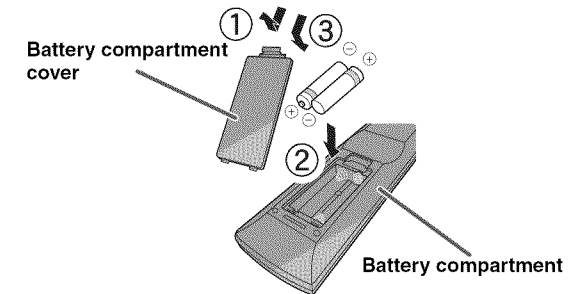

Replace the batteries with new ones if the following symptoms become evident:

- The remote control can only be operated within a narrow range.
- **2** TRANSMIT does not light up, or only lights dimly.

### NOTE

If there are remote control codes for external components registered to the remote control, removing the batteries for more than two minutes, or leaving exhausted batteries in the remote control, the remote control codes may be cleared. If this should occur, replace the batteries with new ones, and set the remote control codes.

## Part names and functions

### Front panel

- ① **⏻ (Power)**  
Switches this unit between on and standby modes.
- ② **INFO**  
Changes the information shown on the front panel display (p. 7).
- ③ **MEMORY**  
Registers FM/AM stations as preset stations (p. 32). ⚡1
- ④ **PRESET </>**  
Selects an FM/AM preset station (p. 32). ⚡1
- ⑤ **FM**  
Sets the FM/AM tuner band to FM (p. 30). ⚡1
- ⑥ **AM**  
Sets the FM/AM tuner band to AM (p. 30). ⚡1
- ⑦ **TUNING <</>>**  
Changes FM/AM tuner frequencies (p. 30). ⚡1
- ⑧ **Front panel display**  
Displays information on this unit (p. 7).
- ⑨ **PHONES jack**  
For plugging headphones in. Sound effects applied during playback can also be heard through the headphones.
- ⑩ **INPUT </>**  
Selects an input source from which to playback. Press either the left or right key repeatedly to cycle through the input sources in order.
- ⑪ **SCENE**  
Switches the input source and the sound field program with a single button (p. 26). Press this key when this unit is in standby mode to switch on the unit.
- ⑫ **TONE CONTROL**  
Adjusts high-frequency/low-frequency output of speakers/headphones (p. 25).
- ⑬ **PROGRAM </>**  
Switches between the sound field effect (sound field program) you are using and the surround sound decoder (p. 26). Press either the left or right key repeatedly to cycle through the input sources in order.
- ⑭ **STRAIGHT**  
Changes a sound field program to straight decoding mode (p. 27).
- ⑮ **VIDEO AUX jacks**  
For connecting video cameras, game consoles, and portable music players to this unit temporarily. Attach the supplied VIDEO AUX input cover when not using this jack.
- ⑯ **VOLUME**  
Adjusts the volume level.

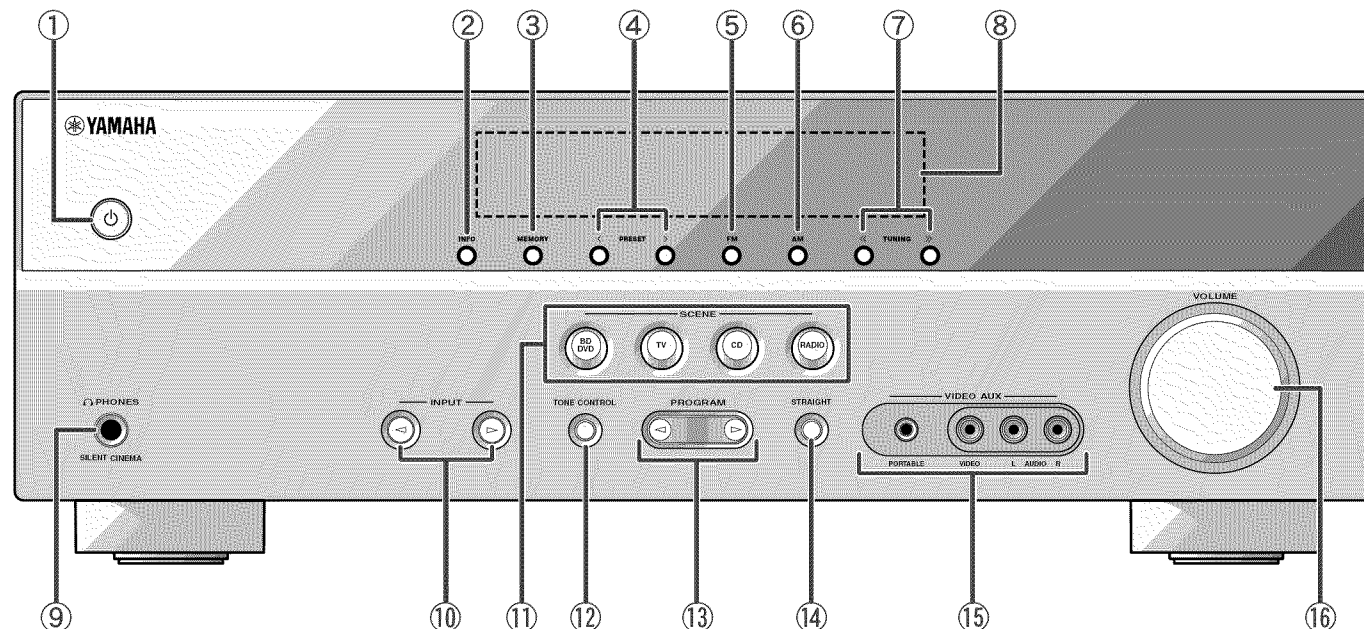

⚡ 1 : Usable when you have selected tuner input.

## Rear panel

① **DOCK jack**

For connecting an optional Yamaha iPod universal dock (such as YDS-12) (p. 34) or Bluetooth wireless audio receiver (YBA-10) (p. 36).

② **HDMI OUT jack**

For connecting an HDMI-compatible TV to output audio/video signals to (p. 14).

③ **HDMI1-4 jacks**

For connecting external components equipped with HDMI-compatible outputs to receive audio/video signals from (p. 16).

④ **ANTENNA jacks**

For connecting AM and FM antennas (p. 21).

⑤ **COMPONENT VIDEO jacks**

For connecting TV that are compatible with component video signals, using three cables to output video signal (p. 14).

⑥ **AV1-5 jacks**

For connecting to external devices equipped with audio/video outputs so that this unit can receive audio/video signals (p. 17, p. 18).

⑦ **AV OUT jacks**

For outputting audio/video signals received when analog inputs (AV3-5 or AUDIO1-2) are selected (p. 20).

⑧ **AUDIO1-2 jacks**

For connecting to external components equipped with analog audio outputs to input sound into this unit (p. 19).

⑨ **MONITOR OUT jack**

For connecting a TV capable of receiving video input, and outputting video signals to it (p. 15).

⑩ **AUDIO OUT jacks**

For outputting audio signals received when analog inputs such as the AV5 or AUDIO1-2 jacks are selected (p. 20).

⑪ **SUBWOOFER jack**

For connecting a subwoofer with a built-in amplifier (p. 12).

⑫ **SPEAKER terminals**

For connecting the front, center, and surround speakers (p. 12).

⑬ **Power cord**

For connecting this unit to an AC wall outlet.

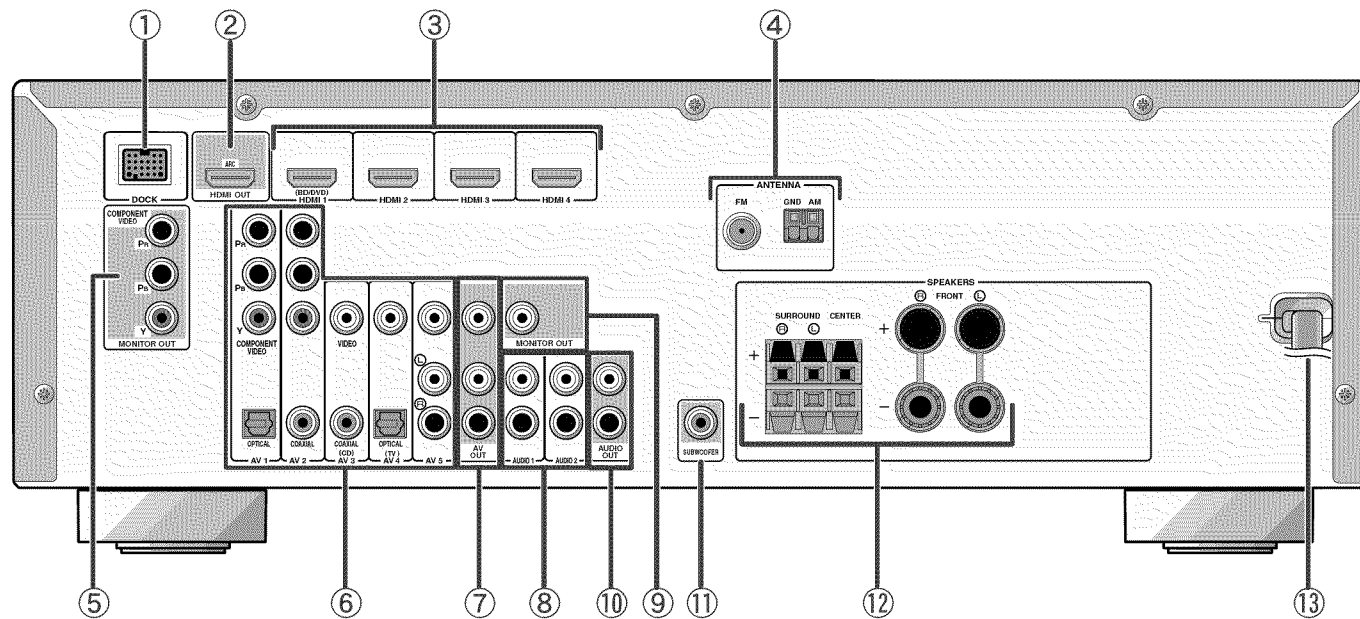

### Distinguishing the input and output jacks

The area around the audio/video output jacks is marked in white to prevent connection errors. Use these jacks to output audio/video signals to a TV or other external component.

### Output jacks

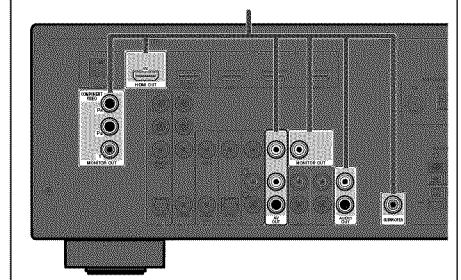

## Front panel display

- ① **HDMI indicator**  
Lights up when HDMI signals are input at the selected HDMI input source.
- ② **CINEMA DSP indicator**  
Lights up when a sound field effect that uses CINEMA DSP technology is selected.
- ③ **Tuner indicator**  
Lights up when receiving an FM/AM broadcast.
- ④ **iPod CHARGE indicator**  
Lights up when an iPod/iPhone is connected through an optional Yamaha iPod universal dock (such as YDS-12), and the iPod Standby Charge function is active (see p. 35).
- ⑤ **SLEEP indicator**  
Lights up when the sleep timer is activated (see p. 8).

- ⑥ **MUTE indicator**  
Flashes when audio is muted.
- ⑦ **VOLUME indicator**  
Displays the current volume level.
- ⑧ **Cursor indicators**  
Light up if corresponding cursors on the remote control are available for operations.
- ⑨ **Multi information display**  
Displays a range of information on menu items and settings.
- ⑩ **Speaker indicators**  
Indicate speaker terminals from which signals are output.

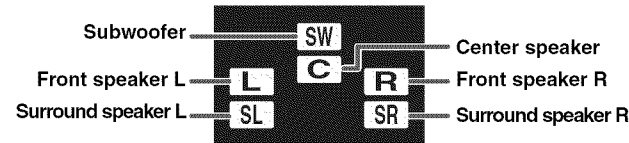

### ■ Changing the front panel display

The front panel can display sound field programs and surround decoder names as well as the active input source.

Press **6** **INFO** repeatedly to cycle through input source → sound field program → surround decoder in order. 1

Input source name



Sound field program (DSP program)

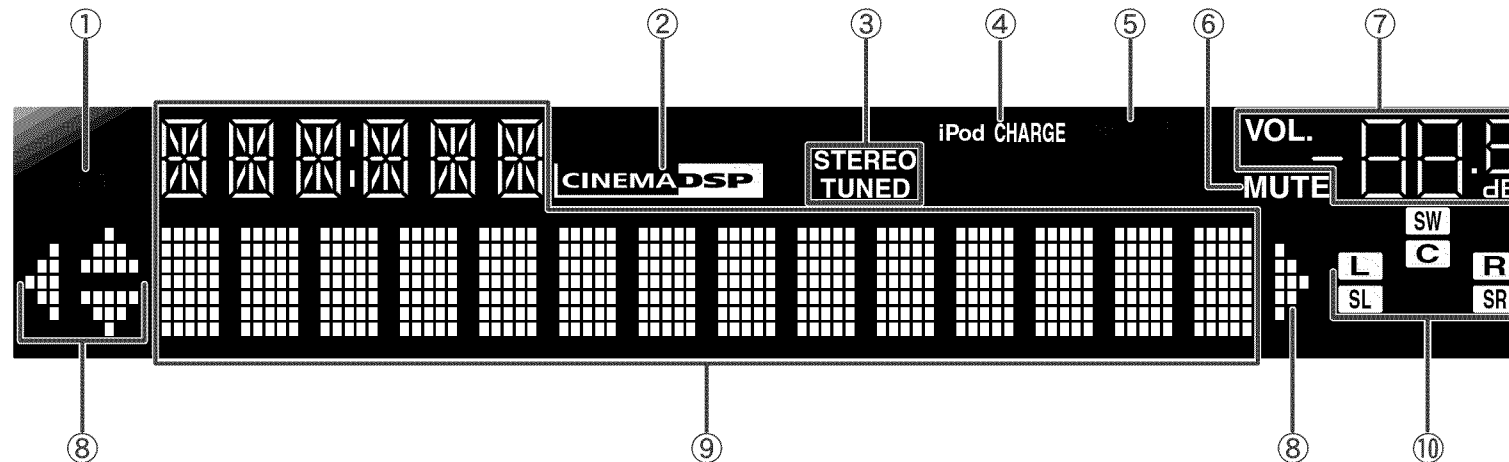

1 : While selecting a tuner input, the FM/AM frequency is displayed instead of the input source.



### Remote control

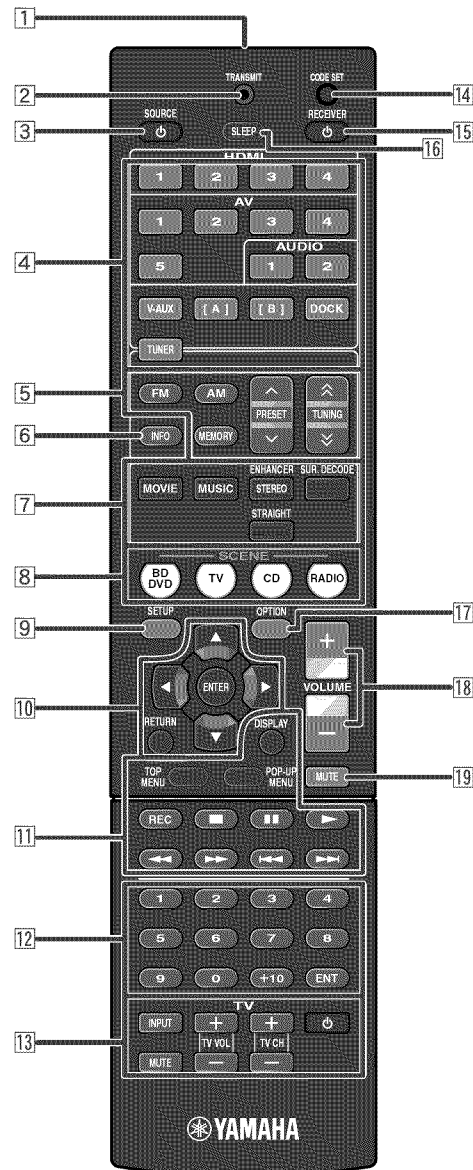

- 1 Remote control signal transmitter**  
Transmits infrared signals.
- 2 TRANSMIT**  
Lights up when a signal is output from the remote control.
- 3 SOURCE  $\phi$  (SOURCE Power)**  
Switches an external component on and off.
- 4 Input selector**  
Select an input source on this unit from which to playback.  
  
**HDMI1-4** HDMI1-4 jacks  
**AV1-5** AV1-5 jacks  
**AUDIO1-2** AUDIO1-2 jacks  
**V-AUX** Front panel VIDEO AUX jacks  
**[A]/[B]** Changes the external component you operating with the **11 External component operation keys** without changing inputs.  $\text{1}$   
  
**DOCK** A Yamaha iPod universal dock or Bluetooth wireless audio receiver connected to the DOCK jack.  
  
**TUNER** FM/AM tuner
- 5 Tuner keys**  
Operates the FM/AM tuner. These keys are used when using the tuner input.  
  
**FM** Sets the FM/AM tuner band to FM.  
**AM** Sets the FM/AM tuner band to AM.  
**MEMORY** Presets radio stations.  
**PRESET  $\wedge / \vee$**  Selects a preset station.  
**TUNING  $\wedge / \vee$**  Changes tuning frequencies.
- 6 INFO**  
Cycles the information displayed on the front panel display (the name of the currently selected input source, the sound field program, the surround decoder, the FM/AM tuner frequency, etc.) (p. 7).
- 7 Sound selection keys**  
Switch between the sound field effect (sound field program) you are using and the surround decoder (p. 26).
- 8 SCENE**  
Switches the input source and the sound field program with a single button (p. 26). Press this key when this unit is in standby mode to switch on the unit.

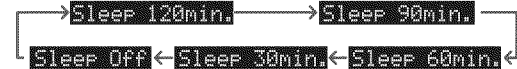
- 9 SETUP**  
Displays a detailed Setup menu for this unit (p. 41).
- 10 Cursor  $\Delta / \nabla / \triangleleft / \triangleright$ , ENTER, RETURN**  
  
**Cursor  $\Delta / \nabla / \triangleleft / \triangleright$**  Select menu items and change settings when settings menus, etc are displayed.  
**ENTER** Confirms a selected item.  
**RETURN** Returns to the previous screen when setting menus are displayed, or ends the menu display.
- 11 External component operation keys**  
Operate recording, playback, and menu displays etc. for external components.  $\text{1}$
- 12 Numeric keys**  
Enter numbers.
- 13 TV control keys**  
Operate a monitor such as a TV.
- 14 CODE SET**  
Sets remote control codes for external component operations (p. 52, p. 56).
- 15 RECEIVER  $\phi$  (RECEIVER Power)**  
Switches this unit between on and standby modes.
- 16 SLEEP**  
Sets this unit to place itself in standby mode automatically after a specified period of time has elapsed (sleep timer). Press this key repeatedly to set the time for the sleep timer function. The front panel display indicator lights up when the sleep timer is activated.  
  

- 17 OPTION**  
Displays the Option menu for each input source (p. 38).
- 18 VOLUME +/-**  
Adjusts the volume level (p. 25).
- 19 MUTE**  
Turns the mute function of the sound output on and off (p. 25).

$\text{1}$  : You can use separate **11 External component operation keys** for each input source to operate registered components. Remote control codes must be registered for each input in advance if you wish to operate external components (p. 52).





# CONNECTIONS

## Connecting speakers

This unit uses acoustic field effects and sound decoders to bring you the impact of a real movie theater or concert hall. These effects will be brought to you with ideal speaker positioning and connections in your listening environment.

### Speaker channels and functions

#### ■ Front left and right speakers

The front speakers are used for the front channel sounds (stereo sound) and effect sounds.

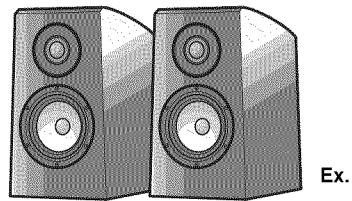

Front speaker layout:

Place these speakers at an equal distance from the ideal listening position in the front of the room.

When using a projector screen, the appropriate top positions of the speakers are about 1/4 of the screen from the bottom.

#### ■ Center speaker

The center speaker is for the center channel sounds (dialog, vocals, etc.).

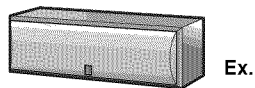

Center speaker layout:

Place it halfway between the left and right speakers. When using a TV, place the speaker just above or just under the center of the TV with the front surfaces of the TV and the speaker aligned.

When using a screen, place it just under the center of the screen.

#### ■ Surround left and right speakers

The surround speakers are for effect and vocal sounds with the 5.1-channel speakers providing rear-area sounds.

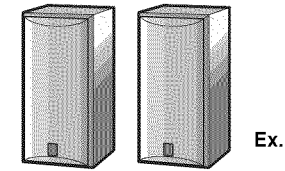

Surround speaker layout:

Place the speakers at the rear of the room on the left and right sides facing the listening position. They should be placed between 60 degrees and 80 degrees from the listening position and with the speaker tops at a height of 1.5 – 1.8 m from the floor.

#### ■ Subwoofer

The subwoofer speaker is used for bass sounds and low-frequency effect (LFE) sounds included in Dolby Digital and DTS. Use a subwoofer that is equipped with an internal amplifier.

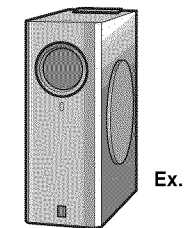

Subwoofer speaker layout:

Place it exterior to the front left and right speakers facing slightly inward to reduce echoes from the wall.

## Speaker layout

### 5.1-channel speaker layout (5 speakers + subwoofer)

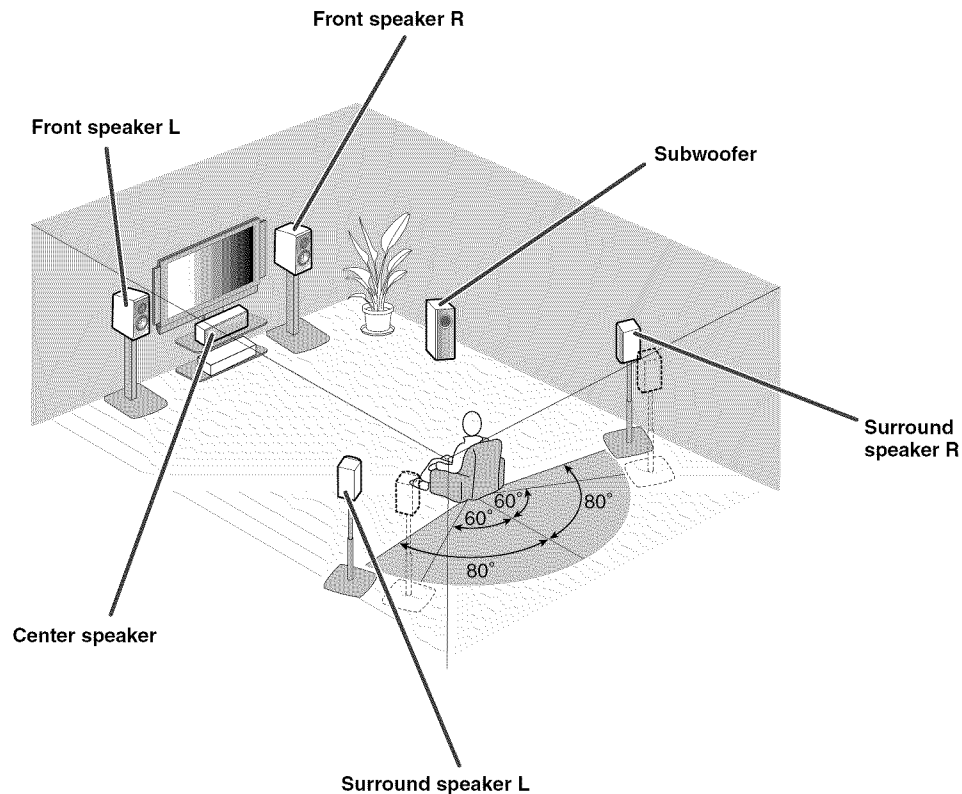

- Connect at least two speakers (front left and right).
- If you cannot connect all five speakers, give priority to the surround speakers.
- The surround speakers should be placed between 60 degrees and 80 degrees from the listening position.

#### ■ CRT monitors

We recommend that you use magnetically shielded speakers to avoid video distortion, especially for the front and center speakers near the screen.

If your screen still gets interference from magnetically shielded speakers, move the speakers farther away from your TV.

## Connecting speakers

### ■ Changing speaker impedance

This unit is configured for 8Ω speakers when it is dispatched from the factory. When connecting to 6Ω speakers, carry out the following procedure to switch to 6Ω.

- 1 **Set this unit to the standby mode.**
- 2 **Press  $\odot$  while pressing and holding STRAIGHT on the front panel.**  
Release the keys when “ADVANCED SETUP” is displayed on the front panel display. After approximately 3 seconds, the top menu items are displayed. 

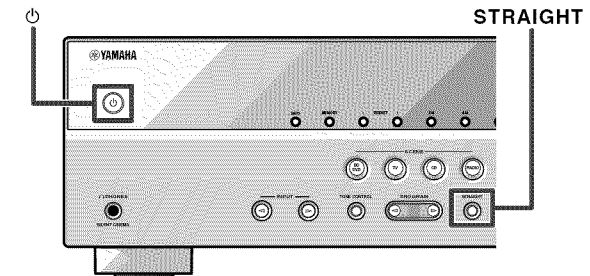

- 3 **Check that “SP IMP.” is displayed on the front panel.**
- 4 **Press STRAIGHT repeatedly to select a “6ΩMIN.”**
- 5 **Switch this unit to the standby mode, and then switch it on again.**  
The power turns on, when the settings you made has been configured.

 1 : See the section on “Extended functionality that can be configured as needed (Advanced Setup menu)” for details on the Advanced Setup menu ([p. 55](#)).



Connect your speakers to their respective terminals on the rear panel.

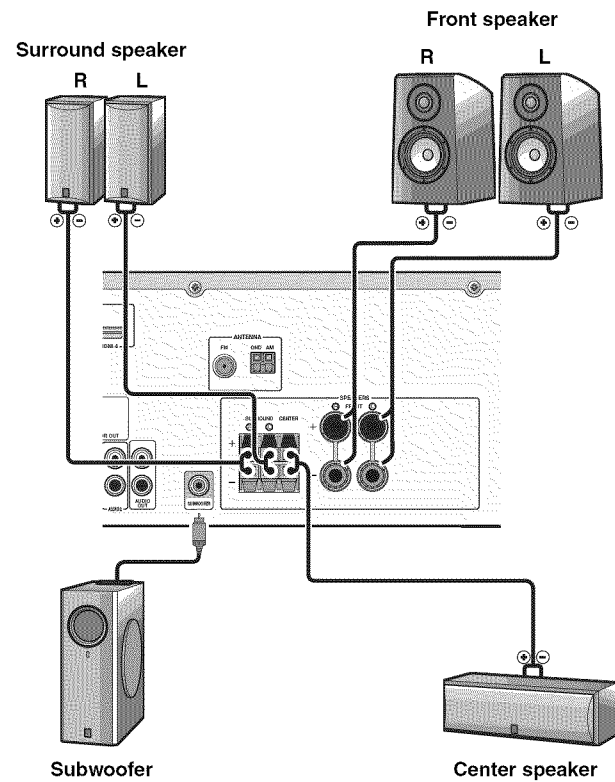

### CAUTION

- Remove the AC power cord of this unit from the power outlet before connecting the speakers.
- Generally speaker cables consist of two parallel insulated cables. One of these cables is a different color, or has a line running along it, to indicate different polarity. Insert the different colored (or lined) cable into the “+” (positive, red) terminal on this unit and the speakers, and the other cable into the “-” (minus, black) terminal.
- Be careful that the core of the speaker cable does not touch anything or come into contact with the metal areas of this unit. This may damage this unit or the speakers. If the speaker cables short circuit, “CHECK SP WIRES!” will appear on the front panel display when this unit is switched on.

## ■ Connecting front speakers

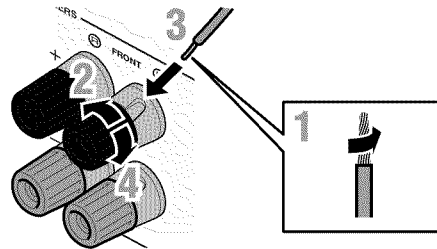

- 1** Remove approximately 10mm of insulation from the ends of the speaker cables, and twist the bare wires of the cables together firmly so that they will not cause short circuits.
- 2** Loosen the speaker terminals.
- 3** Insert the bare wire of the speaker cable into the gap on the side of the terminal.
- 4** Tighten the terminal.

### Connecting the banana plug (Except U.K., Europe, Asia and Korea models)

Tighten the knob, and then insert the banana plug into the end of the terminal.

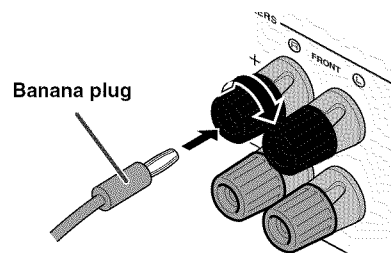

## ■ Connecting center speakers / surround speakers

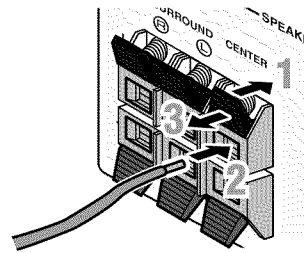

- 1** Press the tab on the speaker terminal down.
- 2** Insert the speaker cable end into the terminal.
- 3** Lift the tab to fix the speaker cable in place.

## ■ Connecting the subwoofer

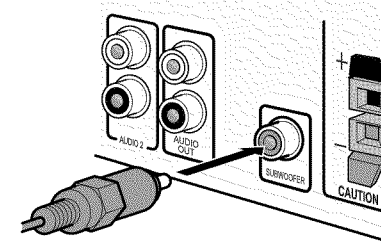

- 1** Connect the subwoofer input jack to the SUBWOOFER jack on this unit with an audio pin cable.
- 2** Set the subwoofer volume as follows.  
Volume: Set to approximately half volume (or slightly less than half).  
Crossover frequency (if available): Set to maximum.

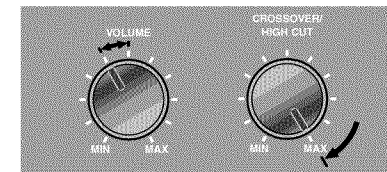

Subwoofer examples

## Connecting external devices

### Cable plugs and jacks

The main unit is equipped with the following input/output jacks. Use jacks and cables appropriate for components that you are going to connect.

#### Audio/Video jacks

##### HDMI jacks

Digital video and digital sound are transmitted through a single jack.  
Only use an HDMI cable.

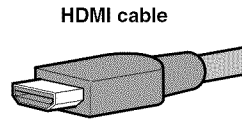
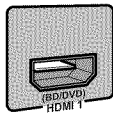

- Use a 19-pin HDMI cable with the HDMI logo.
- We recommend using a cable less than 5.0 m long to prevent signal quality degradation.

#### Analog video jacks

##### COMPONENT VIDEO jacks

The signal is separated into three components: luminance (Y), chrominance blue (PB), and chrominance red (PR).  
Use component video pin cables with three plugs.

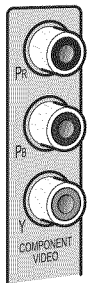

Component video pin cable

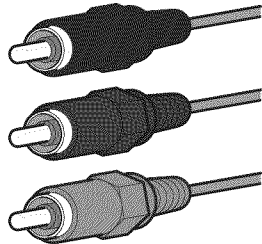

##### VIDEO jack

This jack transmits conventional analog video signals.  
Use video pin cables.

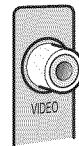

Video pin cable

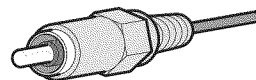

#### Audio jacks

##### OPTICAL jacks

These jacks transmit optical digital audio signals.  
Use fiber-optic cables for optical digital audio signals.



Digital audio fiber-optic cable

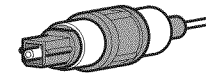

##### COAXIAL jacks

These jacks transmit coaxial digital audio signals.  
Use pin cables for digital audio signals.



Digital audio pin cable

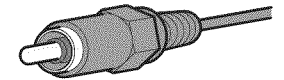

##### AUDIO jacks

These jacks transmit conventional analog audio signals.  
Use stereo pin cables, connecting the red plug to the red R jack, and the white plug to the white L jack.



Stereo audio pin cable

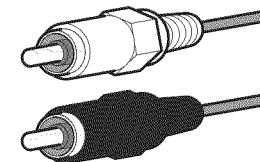

##### PORTABLE jack

This jack transmits conventional analog audio signals.  
Use a stereo mini-plug cable when connecting.

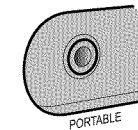

Stereo mini-plug cable

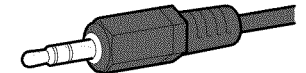

## Connecting a TV monitor

This unit is equipped with the following three types of output jack for connection to a TV. HDMI OUT, COMPONENT VIDEO or VIDEO. Select the proper connection according to the input signal format supported by your TV.

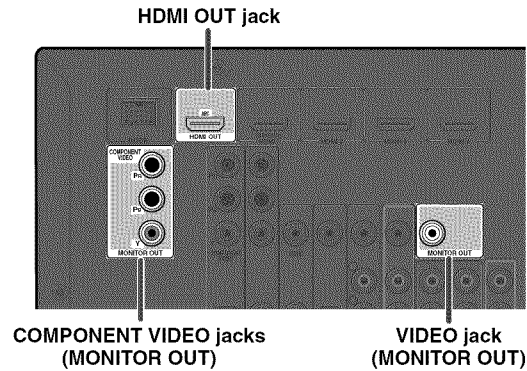

Video signals input from a particular type of jack(s) are output from the same type of jack(s). For example, these three output devices must be connected to the monitor by matching input/output jacks and cables, and then you must change the TV's input mode to the proper setting.

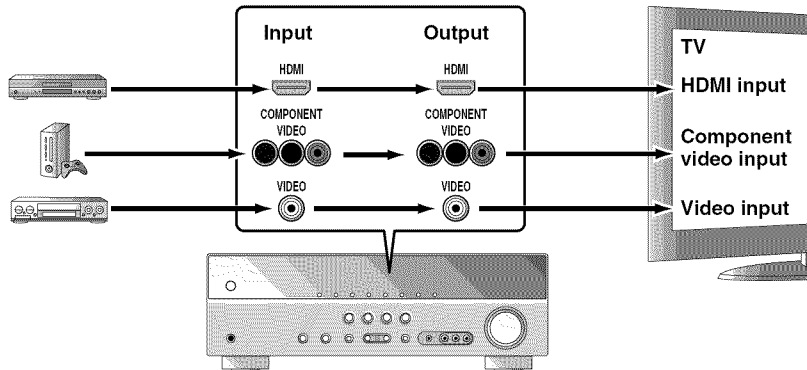

## Connecting an HDMI video monitor

Connect the HDMI cable to the HDMI OUT jack.

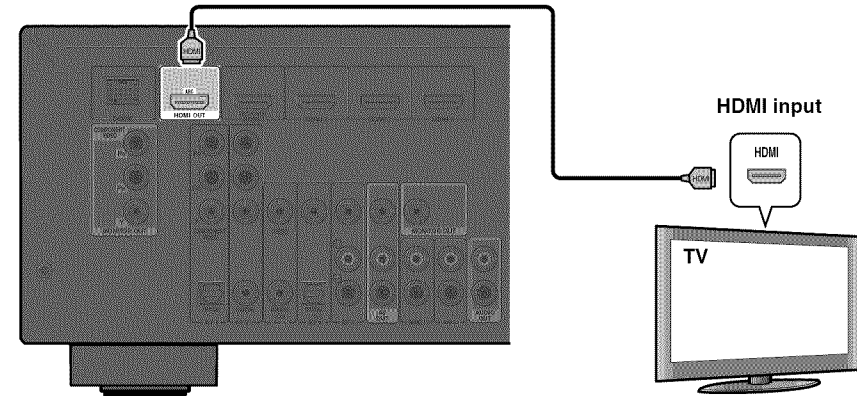

- Use a 19-pin HDMI cable with the HDMI logo.
- We recommend using a cable less than 5.0 m long to prevent signal quality degradation.
- When using a TV that supports Audio Return Channel function, audio/video signals can be transmitted mutually between the unit and TV with a single HDMI cable (see p. 59).

## Connecting a component video monitor

Connect the component video cable to the COMPONENT VIDEO (MONITOR OUT) jacks.

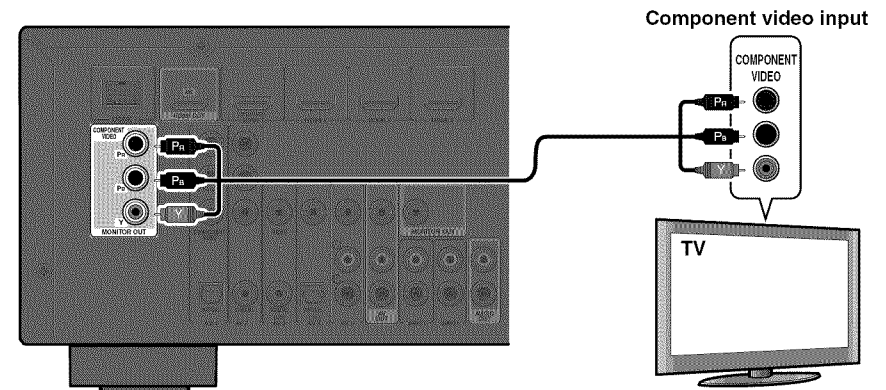

### ■ Connecting a video monitor

Connect the video pin cable to the VIDEO (MONITOR OUT) jack.

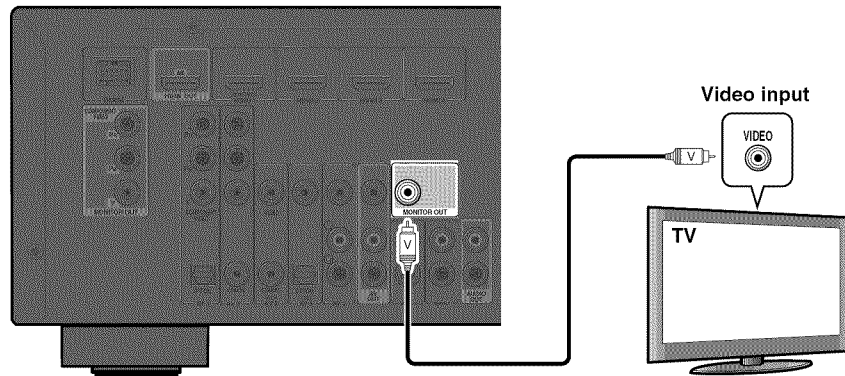

### When using other TVs

To transmit sound from the TV to this unit, connect its AV1-5 or AUDIO1-2 jacks to the TV's audio output jacks.

Depending on the connection on TV, connect the TV's audio output to the AV1-5 or AUDIO1-2.

TV audio output	Connection
Optical digital audio output	Connect to the OPTICAL jack of the AV1 or AV4 with a digital audio pin cable.
Coaxial digital audio output	Connect to the COAXIAL jack of the AV2 or AV3 with a fiber-optic cable.
Analog stereo output	Connect to one of the AV5, AUDIO1, AUDIO2, or V-AUX with a stereo pin cable.

Select the input source connected via TV's audio output jack to enjoy the TV sound.

If the TV supports optical digital audio output, we recommend that you connect the TV audio output to the receiver's AV4 jack.

Connecting to AV4 allows you to switch the input source to AV4 with just a single key operation using the SCENE function (see p. 26).

### ■ Listening to TV audio

To transmit sound from the TV to this unit, connect as followings according to the TV:

#### When using a TV that supports the Audio Return Channel function and HDMI Control function

When your TV supports both HDMI Control (Ex. Panasonic VIERA Link) and Audio Return Channel functions, audio/video output from the unit to the TV and audio output from the TV to the unit are possible using a single HDMI cable.

The input source is switched automatically to match operations carried out on the TV, and that makes TV sound control easier to use.

For the connections and settings, refer to "Single HDMI cable input to TV audio with Audio Return Channel function" (see p. 59).

#### When using a TV that supports the HDMI Control functions

When using a TV that supports HDMI Control functions (Ex. Panasonic VIERA Link), if HDMI Control functions are enabled on the unit, then input source can be switched automatically to match operations carried out on the TV.

For the connections and settings, refer to "Switching the input source on this unit automatically when listening to TV audio" (see p. 58).

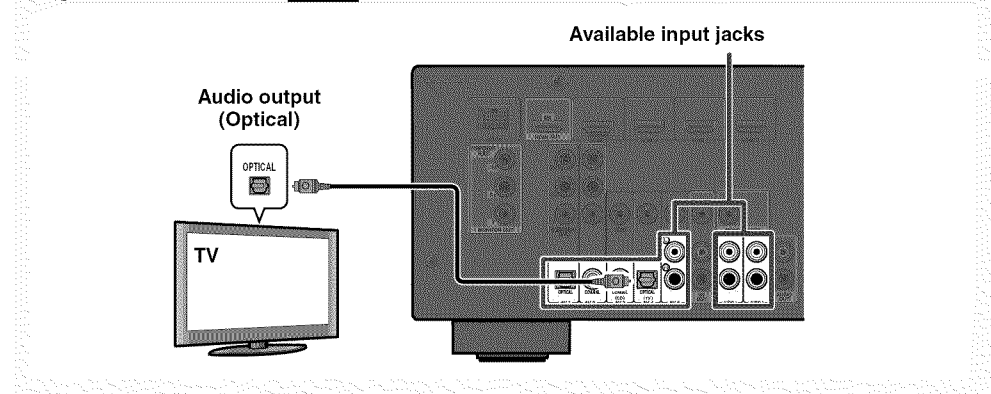

You can control your TV using the receiver's remote control by entering the TV's remote control code (see p. 52).

## Connecting BD/DVD players and other devices

This unit has the following input jacks. Connect them to the appropriate output jacks on the external components.

Input jack	Video input	Audio input
HDMI1	HDMI	HDMI
HDMI2	HDMI	HDMI
HDMI3	HDMI	HDMI
HDMI4	HDMI	HDMI
AV1	Component video	Optical
AV2	Component video	Coaxial digital
AV3	Video	Coaxial digital
AV4	Video	Optical
AV5	Video	Analog (Stereo)
AUDIO1	—	Analog (Stereo)
AUDIO2	—	Analog (Stereo)
VIDEO AUX	Video	Analog (Stereo)

## Connecting BD/DVD players and other devices with HDMI

Connect the device with an HDMI cable to one of the HDMI1-4 jacks. Select the HDMI input (HDMI1-4) that the external device is connected to for playback.

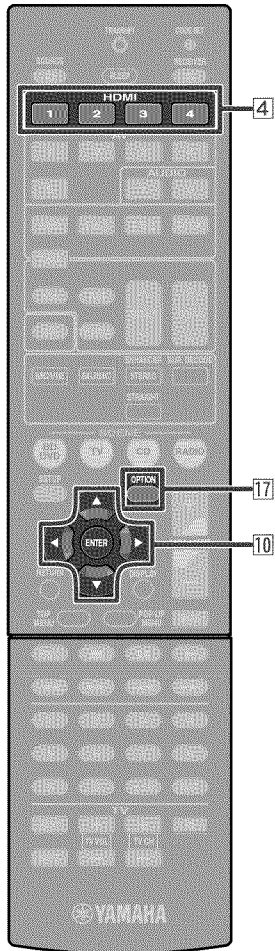

- 4 Input selector
- 10 Cursor ▽ / ◀ / ▶
- 10 ENTER
- 17 OPTION

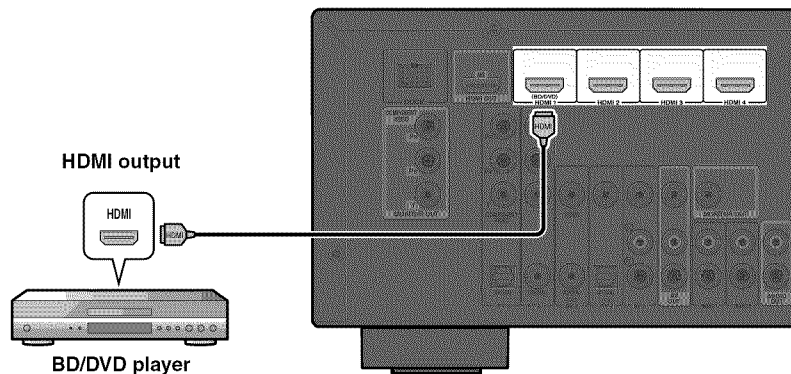

## Receiving audio from other input sources

This unit can use the AV1-5 or AUDIO1-2 input jacks to receive audio signals from other audio input sources.

For example, if an external device cannot produce audio signals from an HDMI jack, use the following method to change the audio input.

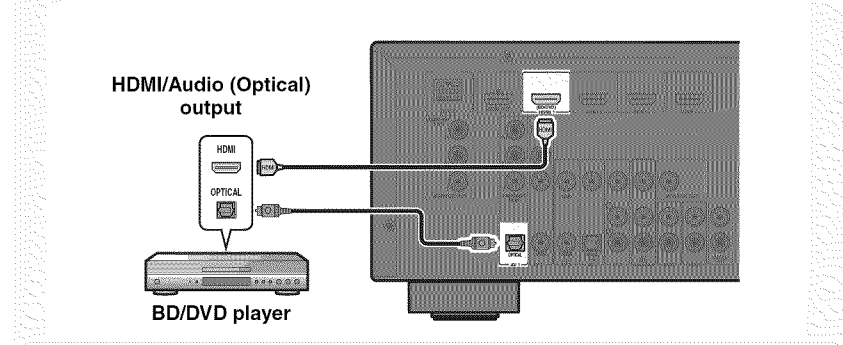

- 1 Use the 4 Input selector to select the desired HDMI input source.
- 2 Press 17 OPTION to display the Option menu. 1
- 3 Press 10 Cursor ▽ until "Audio In" is displayed, and then press 10 ENTER.
- 4 Press 10 Cursor ◀ / ▶ to select the audio input source.
 

Inputs that change the audio source

Assignable audio input jacks

If you have selected AV1 input audio (optical digital)
- 5 Once you have completed the setup, press 17 OPTION to close the Option menu.

1 : See the section on "Configuring the settings specific for each input source (Option menu)" for details on the Option menu (p. 38).



## ■ Connecting BD/DVD players and other devices with component cables

Connect the device with a component video cable to one of the AV1-2 input jacks.

### Using optical digital audio output sources

Select the AV1 input that the external device is connected to for playback.

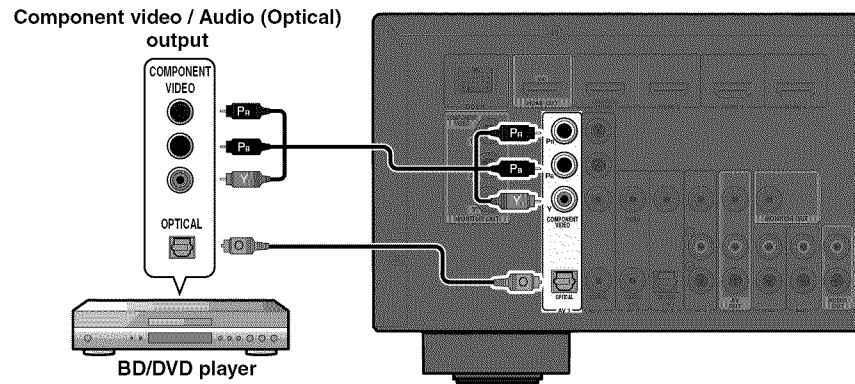

### Using coaxial digital audio output sources

Select the AV2 input that the external device is connected to for playback.

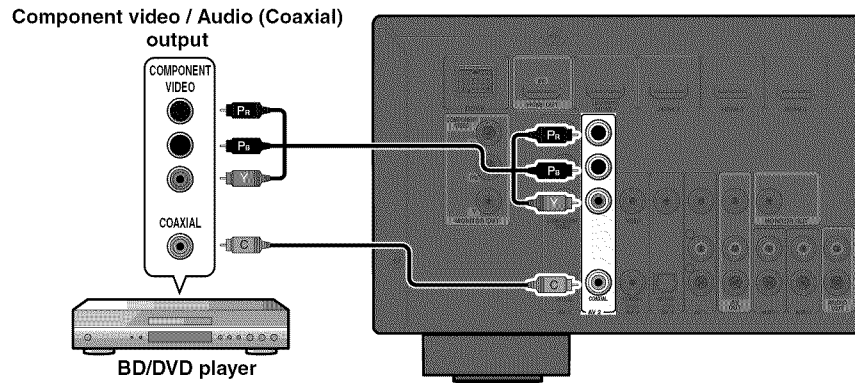

## ■ Component connections to analog audio output devices

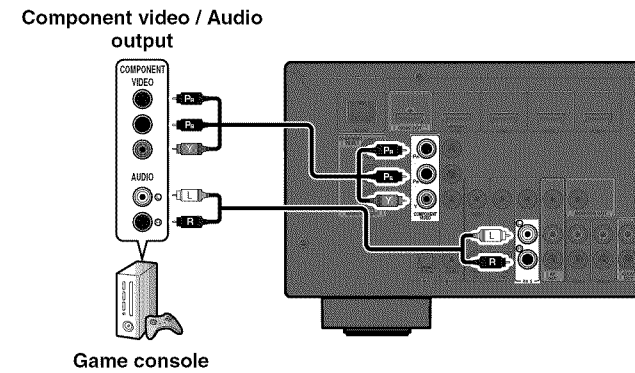

You can use the video input from the AV1-2 jacks in combination with the audio input from other AV inputs or AUDIO1-2.

When connecting these devices, select the AV3-5 or the AUDIO1-2 jacks as the audio input for AV1 or AV2. See "Receiving audio from other input sources" (p. 16) for detailed setup guidance. Select the AV input source (AV1-2) that is connected by component video cable to the external device for playback.



## ■ Connecting BD/DVD players and other devices with video cables

Connect the external device with a video pin cable to one of the AV3-5 input jacks.

### Using optical digital audio output sources

Select the AV4 input that the external device is connected to for playback.

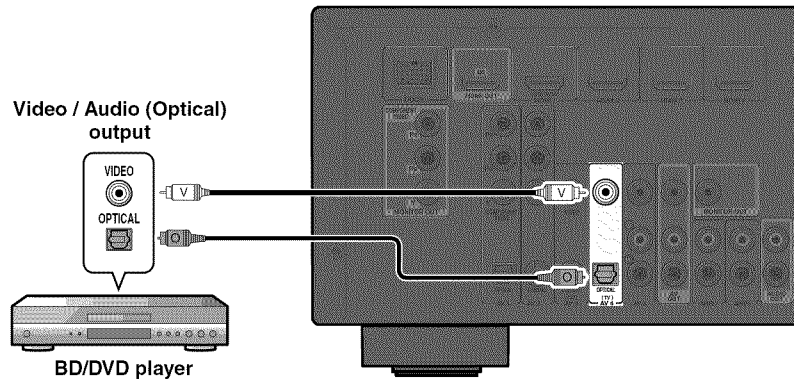

### Using coaxial digital audio output sources

Select the AV3 input that the external device is connected to for playback.

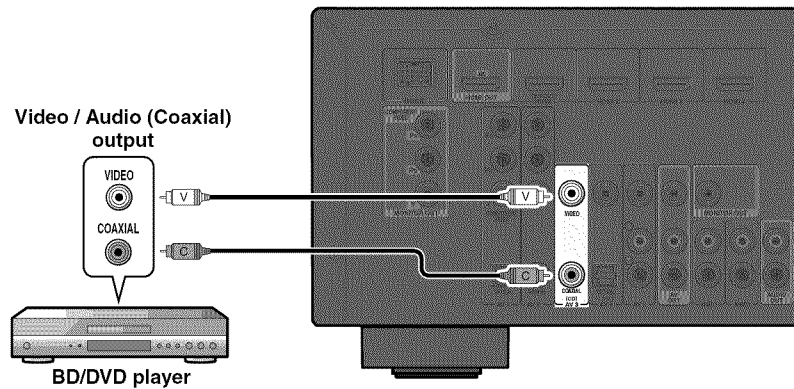

## Using analog stereo audio output sources

Select the AV5 input that the external device is connected to for playback.

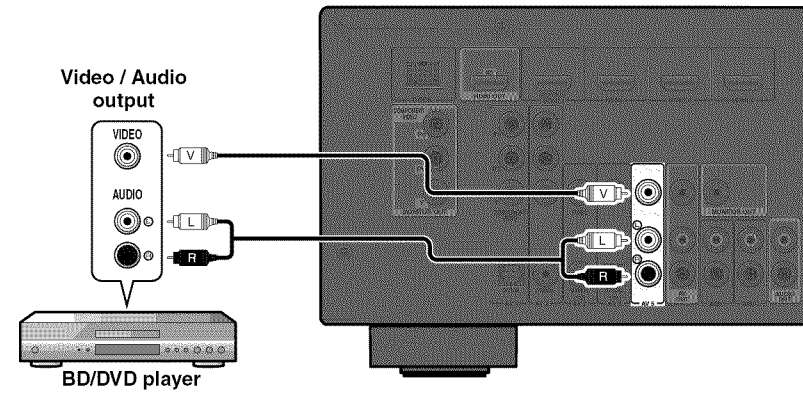

## ■ Connecting CD players and other audio devices

### Using analog stereo output sources

Select the audio input (AUDIO1-2) that the external device is connected to for playback.

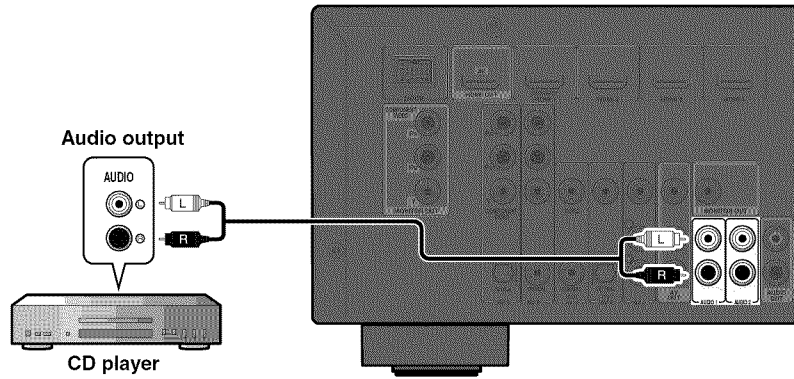

### Using optical digital output sources

Select the AV input (AV1 or AV4) that the external device is connected to for playback.

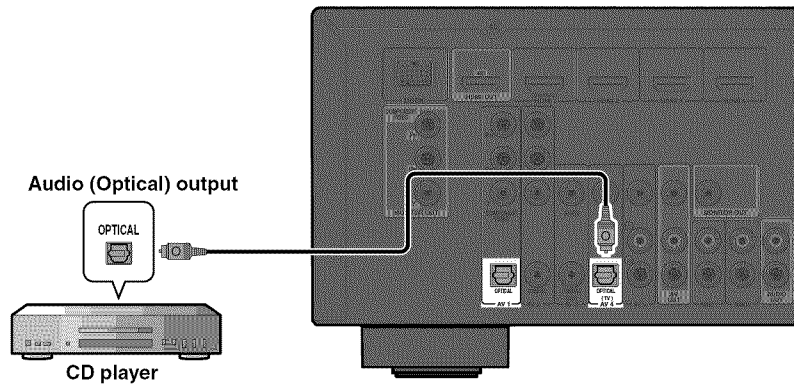

### Using coaxial digital output sources

Select the AV input (AV2 or AV3) that the external device is connected to for playback.

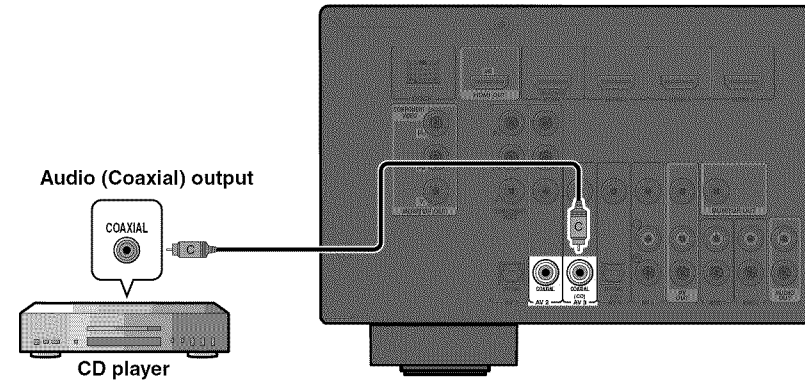

We recommend connecting audio devices with an coaxial digital output to the AV3 coaxial digital jack on this unit. This connection allows you to switch to the AV input 3 just by pressing the “CD” SCENE key (see p. 26).

## Connecting video cameras and portable audio players

Use the VIDEO AUX jacks on the front panel to temporarily connect video cameras, game consoles, or portable audio devices to the receiver.

Select the V-AUX input to use these connected devices.

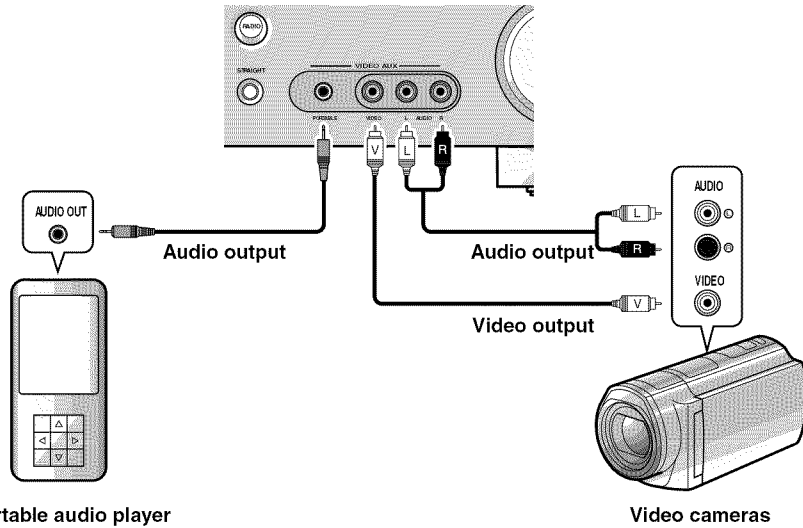

- Be sure to turn down the volume when connecting this unit and the other devices.
- When external components are connected to both the PORTABLE jack and the AUDIO jacks, the sound output from the PORTABLE jack is transmitted.

## Transmitting input A/V to external devices

This receiver can transmit selected incoming analog audio/video signals to external devices through the AV OUT and AUDIO OUT jacks. You can record these input audio and video signals to VCRs or similar devices, or send them to other TVs or external devices.

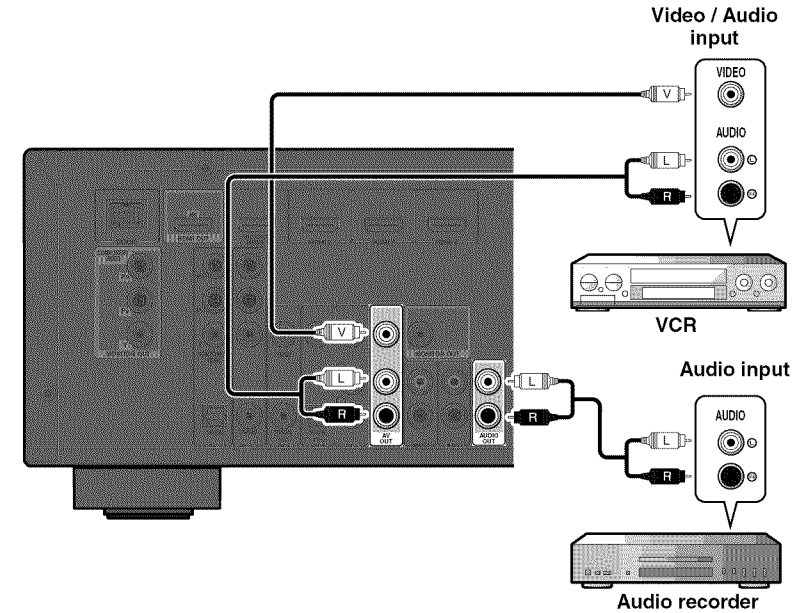

### Using the AV OUT jacks

Connect these jacks to the external device's video input jack and analog audio input jacks.

### Using the AUDIO OUT jacks

Connect these jacks to the external device's analog audio input jacks.

HDMI audio/video signals, component video signals, and digital audio signals cannot be transmitted from these jacks.

## Connecting the FM/AM antennas

An indoor FM antenna and an AM loop antenna are included with this receiver. Connect these antennas properly to their respective jacks.

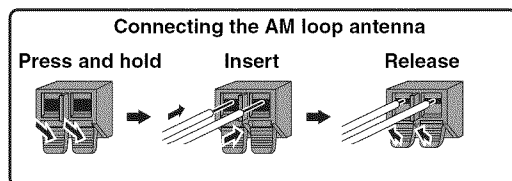
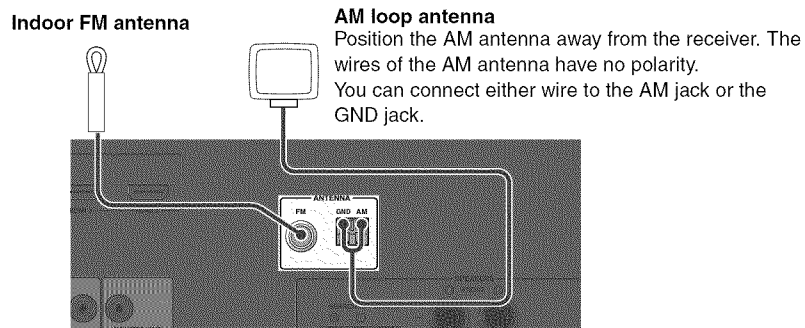

### ■ Improving FM reception

We recommend using an outdoor antenna. For more information, consult the nearest authorized dealer.

### ■ Improving AM reception

Connect this unit to an outdoor antenna with a 5-10 m vinyl-coated wire. Make sure the AM loop antenna is still connected.

Connecting the GND jack can reduce noise. Connect the jack to a store-bought ground bar or copper plate with a vinyl-covered wire and bury this new attachment in moist ground.

The GND jack is not to be connected to the ground socket of an electrical outlet.

## Setting up speaker parameters

When you have finished connecting your speakers, configure this unit so that they output sound normally. Carry out the following steps to configure this unit.

### STEP 1: Display the setting menu

Display the Setup menu from which you can configure all settings for this unit, and then display the menu for speaker settings.

### STEP 2: Set the speaker status and size

Set the size and connection status of speakers and subwoofers, and whether to designate a specific speaker (or subwoofer) for low-frequency sound.

### STEP 3: Set the distance from the listening point

Set the distance between the speakers and the listening point so that the sound from each speaker reaches the listening point at the appropriate timing.

### STEP 4: Playback a test tone

Playback a test tone to allow you to configure sound volumes while listening to the actual effect your settings are having.

### STEP 5: Adjust the volume

Adjust the volume for each speaker and configure them so that the sound is balanced.

### STEP 1: Display the setting menu

**1** Switch this unit on.

**2** Press **9** **SETUP** on the remote control.

The Setup menu that allows you to configure all parameters on this unit appears. <sup>1</sup>



**3** Check that “Speaker Setup” appears and press **10** **ENTER**.



This completes step 1.

### STEP 2: Set the speaker status and size

The settings in step 2 are not necessary with the following speaker configuration:

- Front speaker: woofer diameter is 16 cm or larger
- Center/surround speakers: woofer diameter is 16 cm or smaller
- Subwoofer: connected

**4** Check that “Config” appears and press **10** **ENTER**.



Continues to the next page

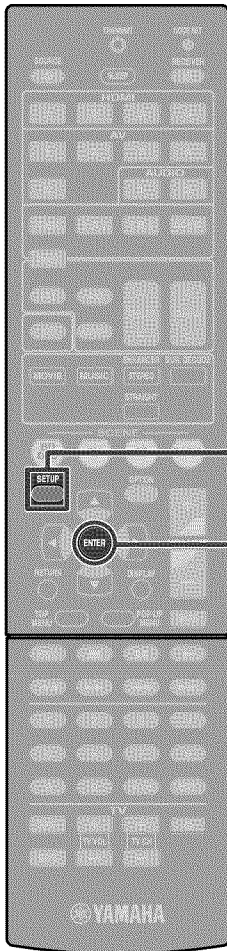

**9** **SETUP**

**10** **ENTER**

<sup>1</sup> : See the section “Setting various functions (Setup menu)” for details on the Setup menu (p. 41).

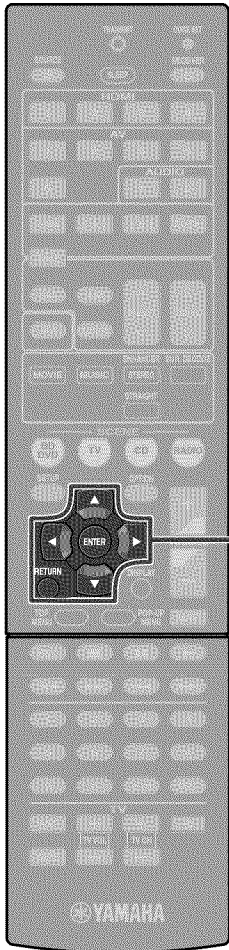

- 10 Cursor  $\Delta$  /  $\nabla$  /  $\triangleleft$  /  $\triangleright$
- 10 ENTER
- 10 RETURN

**5** Use **10**Cursor  $\Delta$  /  $\nabla$  to select the speaker (subwoofer) you want to configure, and then use **10**Cursor  $\triangleleft$  /  $\triangleright$  to select speaker status and size.

Information	Description	Setting
Subwoofer	Sets the subwoofer status.	Yes/None
Front	Selects the size (sound reproduction capacity) of the front speakers.	Small/Large
Center	Selects the size of the center speakers. Choose "None" if you do not have a center speaker connected.	None/Small/Large
Sur. LR	Selects the size of the surround speakers. Choose "None" if you do not have surround speakers connected.	None/Small/Large
Crossover	Audio with a frequency below this limit will be output from the subwoofer or the front speakers.	40Hz to 200Hz
SWFR Phase	Switches the phase of the subwoofer.	NRM/REV
Extra Bass	Selects whether to play front channel low-frequency components through either of the front speakers or the subwoofer (Off), or through both the subwoofer and front speakers (On).	On/Off

- Whether or not you set "Crossover," "SWFR Phase," and "Extra Bass" is optional. Check how the effects sound and then configure them to your liking.
- Use the following as a guide when setting speaker sizes.

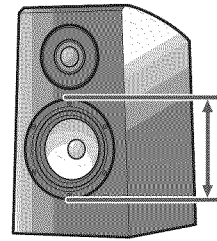

**Woofer diameter**

- 6-1/4 in (16 cm) or larger  
→ Large
- 6-1/4 in (16 cm) or smaller  
→ Small

When speaker size is set to "Small," low-frequency components of the speakers you configured are produced from the subwoofer (or from the front speakers if there is no subwoofer).

When you have completed the settings for one speaker, repeat the same procedure for all speakers to complete settings.

**6** Press **10**RETURN when setting is complete. Return to the previous menu.

This completes step 2.

### STEP 3: Set the distance from the listening point

**7** Press **10**Cursor  $\nabla$  to display "Distance" and press **10**ENTER.



**8** Press **10**Cursor  $\Delta$  /  $\nabla$  to select the speaker that you want to configure, and press **10**Cursor  $\triangleleft$  /  $\triangleright$  to change the distance.

If necessary, you can change the setting units under "Unit."

Information	Description	Setting
Unit	Switches between setting units (feet / meters).	feet (ft) / meters (m)
Front L	Front speaker L	1.0 ft to 80.0 ft (0.30 m to 24.0 m)
Front R	Front speaker R	1.0 ft to 80.0 ft (0.30 m to 24.0 m)
Center	Center speaker	1.0 ft to 80.0 ft (0.30 m to 24.0 m)
Sur. L	Surround speaker L	1.0 ft to 80.0 ft (0.30 m to 24.0 m)
Sur. R	Surround speaker R	1.0 ft to 80.0 ft (0.30 m to 24.0 m)
SWFR	Subwoofer	1.0 ft to 80.0 ft (0.30 m to 24.0 m)

When you have completed the settings for one speaker, repeat the same procedure for all speakers to complete settings.

**9** Press **10**RETURN when setting is complete. Return to the previous menu.

This completes step 3.

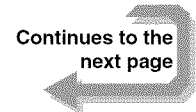

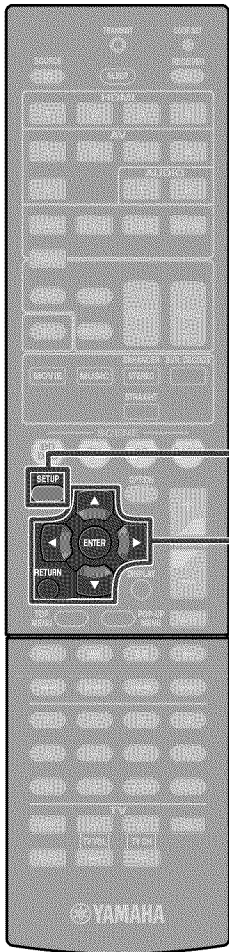

- 9 SETUP
- 10 Cursor  $\Delta$  /  $\nabla$  /  $\triangleleft$  /  $\triangleright$
- 10 ENTER
- 10 RETURN

### STEP 4: Playback a test tone

**10** Press **10**Cursor  $\nabla$  repeatedly to display “Test Tone” and press **10**ENTER.



**11** Use **10**Cursor  $\triangleleft$  /  $\triangleright$  to select “On.”  
A test tone plays back as soon as you select “On.”  
The test tone plays back in a clockwise fashion, as follows.

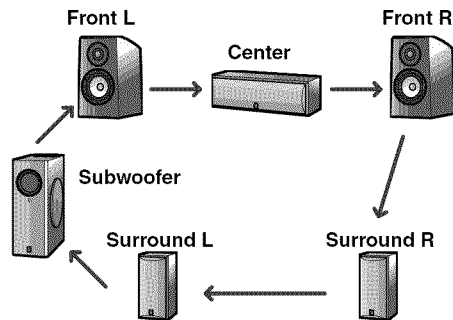

**12** Check that the test tone is playing back and press **10**RETURN.

Return to the previous menu.  
This completes step 4.

### STEP 5: Adjust the volume

**13** Press **10**Cursor  $\Delta$  repeatedly to display “Level” and press **10**ENTER.



**14** Use **10**Cursor  $\Delta$  /  $\nabla$  to switch the speaker that is outputting the test tone, looking for speakers with a different volume level to the others.

The front panel display shows the speaker that is outputting the test tone. 1

Information	Speakers
FL	Front speaker L
FR	Front speaker R
C	Center speaker
SL	Surround speaker L
SR	Surround speaker R
SWFR	Subwoofer

**15** If you find a speaker with a different volume level to the others, use **10**Cursor  $\triangleleft$  /  $\triangleright$  to adjust the volume. Use Front speaker L or R as a default when adjusting volumes.

To raise the volume: Press **10**Cursor  $\triangleright$ .

To lower the volume: Press **10**Cursor  $\triangleleft$ .

**16** Repeat steps 14 and 15 to adjust the volume balance for all speakers to your preference.

**17** Press **10**RETURN when setting is complete.

Return to the previous menu.

This completes step 5.

**18** Repeat procedures 10-12 (step 4) to stop playback of the test tone.

**19** Once you have completed all settings, press **9**SETUP to close the Setup menu.

1 : Only speakers configured for use in procedure 5 output the test tone.



# PLAYBACK

## Basic playback procedure

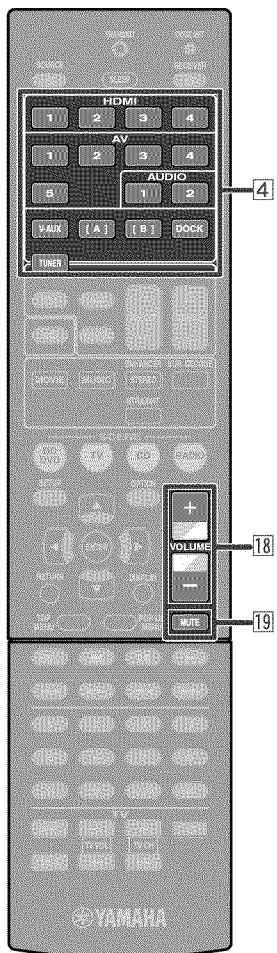

- 4 Input selector
- 18 VOLUME +/-
- 19 MUTE

- 1 Turn on external components (TV, DVD player, etc.) connected to this unit.
- 2 Turn on this unit and select the input source using 4 Input selector.

The name of the selected input source is displayed for a few seconds. 1

- 3 Play the external component that you have selected as the source input, or select a radio station on the tuner.

Refer to the instruction manuals provided with the external component for details on playback.

For details on the following operations, refer to the corresponding pages:

- “FM/AM tuning” (p. 30)
- “Playing back tunes from your iPod™/iPhone™” (p. 34)
- “Playing back tunes from Bluetooth™ components” (p. 36)

- 4 Press 18 VOLUME +/- to adjust the volume.

### To mute the output.

Press 19 MUTE to mute the audio output.

Press 19 MUTE again to unmute.

## Adjusting high/low-frequency sound (Tone control)

You can adjust the balance of the high-frequency range (Treble) and low-frequency range (Bass) of sounds output from the front left and right speakers to obtain desired tone.

The tone control of the speakers or headphones can be set separately. Set the headphone tone control with the headphones connected.

- 1 Press TONE CONTROL on the front panel repeatedly to select “Treble” or “Bass.”

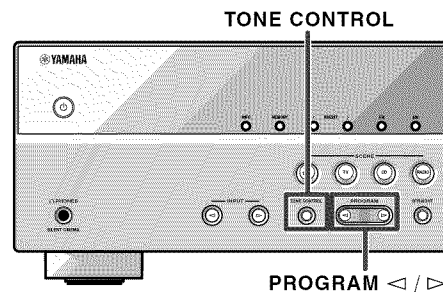

The current setting is displayed on the front panel display.



- 2 Press PROGRAM </> to adjust the output level in those frequency ranges.

Adjustable range	-10.0 dB to +10.0 dB
Adjustment increments	2.0 dB

The display returns to the previous display soon after you release the key.

If you set the balance extremely off, sounds may not match those from other channels well.

1 : You can change the input source name displayed on the front panel display as necessary (p. 48).

## Changing input settings with a single key (SCENE function)

This unit has a SCENE function that allows you to turn the power on and change input sources and sound field programs with one key.

Four scenes are available for different uses, such as playing movies or music. The following input sources and sound field programs are provided as the initial factory settings.

SCENE	Input	Sound field program
BD/DVD	HDMI1	STRAIGHT
TV	AV4	STRAIGHT
CD	AV3	STRAIGHT
RADIO	TUNER	5ch Enhancer

### Registering input sources/sound field program

**1** Use [4] Input selector to select the input source you want to register.

**2** Use the [7] Sound selection keys to select the sound field program you want to register.

Press one key repeatedly to select the sound field program in the same category. For details on sound field program, refer to "Selecting sound field programs and sound decoders" on this page.

**3** Press the [8] SCENE key until "SET Complete" appears on the front panel display.



Release the key when "SET Complete" is displayed.

When changing "SCENE," you can also use switch between the external components that the remote control operates (p. 52).

## Enjoying sound field programs

This unit is also equipped with a Yamaha digital sound field processing (DSP) chip. You can enjoy multi-channel playback for almost any sound source using various sound field programs stored on the chip, and a range of sound decoders.

### Selecting sound field programs and sound decoders

This unit offers sound field settings (sound field programs) in many different categories suitable for movies, music and other uses. Choose a sound field program that sounds best with the source you are playing back, rather than relying on the name or explanation of the program.

- Sound field programs are stored for each input source. When you change the input source, the sound field program previously selected for that input source is applied again.
- If the sampling frequency of an input source is higher than 96 kHz, this unit does not apply any sound field programs.

#### Selects sound field program:

MOVIE category: Press [7] MOVIE repeatedly.  
MUSIC category: Press [7] MUSIC repeatedly.

#### Selects stereo reproduction:

Press [7] STEREO repeatedly.

#### Selects compressed music enhancer:

Press [7] STEREO repeatedly.

#### Selects surround decoder:

Press [7] SUR. DECODE repeatedly.

#### Switches Straight decoding mode (p. 27):

Press [7] STRAIGHT.

#### Sound field program categories



- You can use the speaker indicators on the front panel display to check what speakers are currently outputting sound (p. 7).
- You can adjust sound field elements (sound field parameters) for each of the programs.

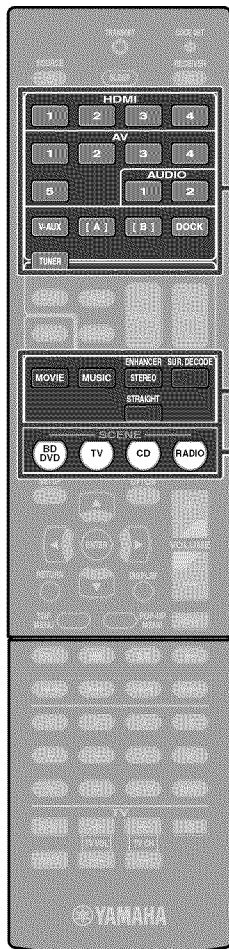

- 4 Input selector
- 7 Sound selection keys
- 7 MOVIE
- 7 MUSIC
- 7 STEREO
- 7 SUR. DECODE
- 7 STRAIGHT
- 8 SCENE



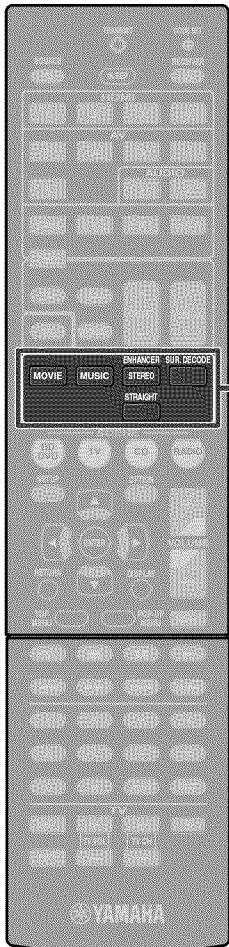

- 7 Sound selection keys
- 7 STRAIGHT
- 7 STEREO

### Enjoying unprocessed playback (Straight decoding mode)

Use straight decoding mode when you want to playback sound without sound field processing. You can playback as follows in straight decoding mode.

#### 2-channel sources such as CD

Stereo sound plays through the front left and right speakers.

#### Multi-channel playback sources such as BD/DVD

Plays back audio from a playback source without applying sound field effects, using an appropriate decoder to split the signal into multiple channels.

- 1 Press STRAIGHT to activate the straight decoding mode.



- 2 Press STRAIGHT again to exit straight decoding mode.



Previously selected program

### Enjoying stereo playback

Select “2ch Stereo” from the surround field programs when you want to playback 2-channel stereo sound (from the front speakers only), regardless of the playback source.

Selecting “2ch Stereo” will playback as follows for the playback of CD and BD/DVD sources.

#### 2-channel sources such as CD

Stereo sound plays back through the front speakers.

#### Multi-channel sources such as BD/DVD

Playback channels other than the front channels in the playback source are mixed with the front channels and played back through the front speakers.

- 1 Press STEREO repeatedly to select “2ch Stereo.”



- 2 To deactivate stereo playback, press any of the Sound selection keys to select a sound field program other than “2ch Stereo.”



### Enjoying sound field programs without surround sound speakers

This unit allows you to use virtual surround speakers to enjoy sound field surround effects, even without any surround speakers (Virtual CINEMA DSP mode). You can even enjoy surround sound presence with just a minimal configuration of the front speakers only.

This unit will switch to Virtual CINEMA DSP mode automatically when surround speakers are unavailable. 1

### Enjoying sound field programs with headphones

Even when headphones are connected, you can enjoy the reproduction sound field presence with ease (SILENT CINEMA mode). 2

1 : However, Virtual CINEMA DSP mode is not available in the following conditions:

- When headphones are connected to this unit.
- When a “2ch Stereo” sound field program is selected.
- When straight decoding mode is selected.

2 : However, SILENT CINEMA mode is not available in the following conditions:

- When a “2ch Stereo” sound field program is selected.
- When straight decoding mode is selected.







## Sound field programs

 in the table indicates the sound field program for CINEMA DSP.

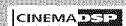
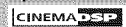
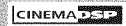
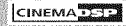
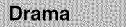
### Category: MOVIE

Sound field programs optimized for viewing video sources such as movies, TV programs, and games.

<b>Standard</b> 	This program creates a sound field emphasizing the surround feeling without disturbing the original acoustic positioning of multi-channel audio such as Dolby Digital and DTS. It has been designed with the concept of an ideal movie theater, in which the audience is surrounded by beautiful reverberations from the left, right and rear.
<b>Spectacle</b> 	This program represents the spectacular feeling of large-scale movie productions. It reproduces a broad theater sound field that matches cinemascope and wider-screen movies with an excellent dynamic range providing everything from very small sound effects to large, impressive sounds.
<b>Sci-Fi</b> 	This program clearly reproduces the finely elaborated sound design of the latest science fiction and special effects-featuring movies. You can enjoy a variety of cinematographically created virtual spaces reproduced with clear separation between dialog, sound effects and background music.
<b>Adventure</b> 	This program is ideal for precisely reproducing the sound design of action and adventure movies. The sound field restrains reverberations but puts emphasis on reproducing a powerful space expanded widely to the left and right. The reproduced depth is also restrained relatively to ensure the separation between audio channels and the clarity of the sound.
<b>Drama</b> 	This sound field features stable reverberations that match a wide range of movie genres from serious dramas to musicals and comedies. The reverberations are modest but offer an optimum 3D feeling, reproducing effects tones and background music softly but cubically around clear words and center positioning in a way that does not fatigue the listener even after long hours of viewing.
<b>Mono Movie</b> 	This program is provided for reproducing monaural video sources such as a classic movie in an atmosphere of a good old movie theater. The program produces the optimum expansion and reverberation to the original audio to create a comfortable space with a certain sound depth.
<b>Sports</b> 	This program allows the listeners to enjoy stereo sport broadcasts and studio variety programs with enriched live feeling. In sports broadcasts, the voices of the commentator and sportscaster are positioned clearly at the center while the atmosphere of the stadium expands in an optimal space to offer the listeners a feeling of presence in the stadium.
<b>Action Game</b> 	This sound field is suitable for action games such as car racing, fighting games and FPS games. The reality of, and emphasis on, various effects makes the player feel like they are right in the middle of the action, allowing for greater concentration.



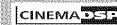



### Roleplaying Game

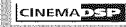

This sound field is suitable for role-playing and adventure games. This program adds depth to the sound field for natural and realistic reproduction of background music, special effects and dialog from a wide variety of scenes.

### Category: MUSIC

This sound field is suitable when listening to music sources such as CDs.

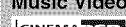
<b>Hall in Munich</b> 	This sound field simulates a concert hall with approximately 2500 seats in Munich, using stylish wood for the interior finishing as normal standards for European concert halls. Fine, beautiful reverberations spread richly, creating a calming atmosphere. The listener's virtual seat is at the center left of the arena.
<b>Hall in Vienna</b> 	This is an approximately 1700-seat, middle-sized concert hall with a shoebox shape that is traditional in Vienna. Pillars and ornate carvings create extremely complex reflections from all around the audience, producing a very full, rich sound.
<b>Chamber</b> 	This program creates a relatively wide space with a high ceiling like an audience hall in a palace. It offers pleasant reverberations that are suitable for courtly music and chamber music.
<b>Cellar Club</b> 	This program simulates a live house with a low ceiling and homey atmosphere. A realistic, live sound field features powerful sound as if the listener is in a row in front of a small stage.
<b>The Roxy Theatre</b> 	This is the sound field of a rock music live house in Los Angeles, with approximately 460 seats. The listener's virtual seat is at the center left of the hall.
<b>The Bottom Line</b> 	This is the sound field at stage front in The Bottom Line, a famous New York jazz club once. The floor can seat 300 people to the left and right in a sound field offering real and vibrant sound.
<b>Music Video</b> 	This sound field offers an image of a concert hall for live performance of pop, rock and jazz music. The listener can indulge oneself in a hot live space thanks to the presence sound field that emphasizes the vividness of vocals and solo play and the beat of rhythm instruments, and to the surround sound field that reproduces the space of a big live hall.



## ■ Category: STEREO

Suitable for listening to stereo sources.

<b>2ch Stereo</b>	Use this program to mix down multi-channel sources to 2 channels. When multi-channel signals are input, they are down mixed to 2 channels and output from the front left and right speakers.
<b>5ch Stereo</b> 	Use this program to output sound from all speakers. When you play back multi-channel sources, this unit down-mixes the source to 2 channels, and then outputs the sound from all speakers. This program creates a larger sound field and is ideal for background music at parties, etc.





## ■ Category: ENHNCR (Compressed music enhancer)

Suitable for listening to compressed audio, such as MP3.

<b>Straight Enhancer</b>	Use this program to restore the original depth and dynamics of 2-channel or multi-channel to compression audio.
<b>5ch Enhancer</b>	Use this program to play back compression artifacts in 5-channel stereo.

## ■ Category: SUR.DEC (Surround decode mode)

Select this program to playback sources with selected decoders. You can playback 2-channel sound sources in up to 5-channels using a surround decoder.

 <b>Pro Logic</b>	Reproduces sound using the Dolby Pro Logic decoder. This is suitable for all kinds of sound sources.
 <b>PLII Movie</b>	Reproduces sound using the Dolby Pro Logic II decoder. This is suitable for movies.
 <b>PLII Music</b>	Reproduces sound using the Dolby Pro Logic II decoder. This is suitable for music.
 <b>PLII Game</b>	Reproduces sound using the Dolby Pro Logic II decoder. This is suitable for games.
<b>Neo:6 Cinema</b>	Reproduces sound using the DTS Neo:6 decoder. This is suitable for movies.
<b>Neo:6 Music</b>	Reproduces sound using the DTS Neo:6 decoder. This is suitable for music.



## FM/AM tuning

When using the FM/AM tuner, adjust the direction of the FM/AM antenna connected to this unit to get the best reception.

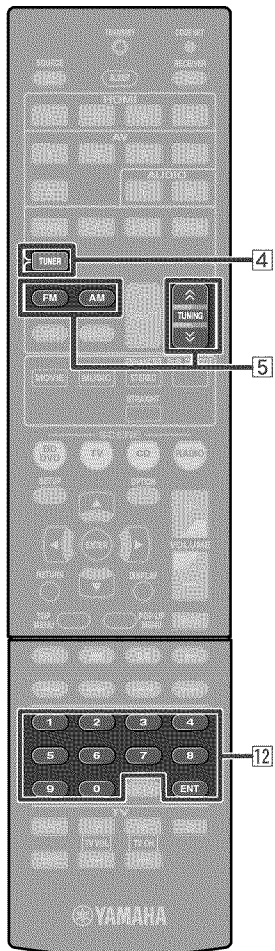

- 4 TUNER
- 5 FM
- 5 AM
- 5 TUNING  $\wedge$  /  $\vee$
- 12 Numeric keys

The FM/AM tuner of this unit provides the following two modes for tuning.

### Normal tuning

You can tune in to a desired FM/AM station by searching or specifying its frequency.

### Preset tuning (p. 31)

You can preset the frequencies of FM/AM stations by registering them to specific numbers, and later just select those numbers to tune in.

## Selecting a frequency for reception (Normal tuning)

1 Press 4 TUNER to switch to the tuner input.

2 Press 5 FM or 5 AM to select a band to receive.



3 Use 5 TUNING  $\wedge$  /  $\vee$  to set a frequency to receive.

### 5 TUNING $\wedge$

Increases the frequency. Press and hold this key for longer than a second to search automatically for a station on a higher frequency than the current one.  $\text{🔊}1$

### 5 TUNING $\vee$

Decreases the frequency. Press and hold this key for longer than a second to search automatically for a station on a lower frequency than the current one.  $\text{🔊}1$

Lights up when receiving a broadcast from a station

Lights up when receiving a stereo broadcast



### ■ Entering a frequency number

In normal tuning mode, use the 12 Numeric keys on the remote control to enter a frequency. Leave the decimal point out when entering a number.  $\text{🔊}2$   
For example, enter as follows to select a station on 98.5MHz.



$\text{🔊}1$  : When searching for a station, release the key once the search has started.

$\text{🔊}2$  : "Wrong Station!" appears on the front panel display when you enter a frequency that is out of receivable range. Make sure that the frequency entered is correct.

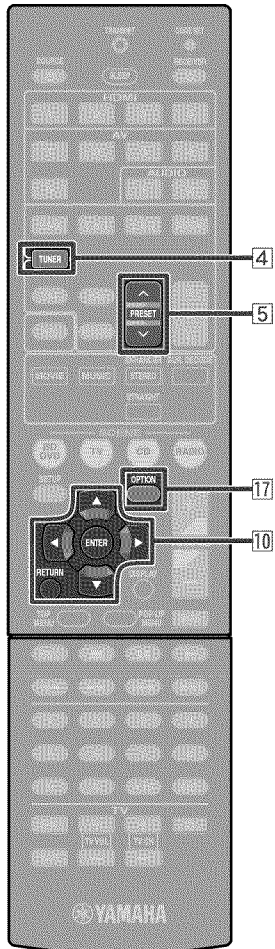

- 4 TUNER
- 5 PRESET ^ / v
- 10 Cursor Δ / ▽ / ◀ / ▶
- 10 ENTER
- 10 RETURN
- 17 OPTION

### ■ When signal reception is poor

When you are receiving an FM broadcast and cannot obtain a stable stereo broadcast, you can force this unit to receive in a monaural mode.

**1** Press **4** TUNER to switch to the tuner input.

**2** Press **17** OPTION to display the Option menu.

**3** Use **10** Cursor Δ / ▽ to select “FM Mode.”



**4** Press **10** ENTER and use the **10** Cursor ◀ / ▶ to select “Mono.”



**5** When setting is completed, press **17** OPTION to close the Option menu.

To return this unit to its original settings, use the same procedure to return the settings to “Stereo.”

## Registering and recalling a frequency (Preset tuning)

You can register up to 40 FM/AM stations as preset stations. There are two methods of presetting stations, “Auto Preset” and “Manual Preset.” Use one of these methods to register stations.

### ■ Presetting FM stations automatically (Auto Preset)

The tuner detects FM stations with strong signals and registers up to 40 automatically.

AM stations cannot be automatically registered. Use manual station preset ( p. 32).

**1** Press **4** TUNER to switch to the tuner input.

**2** Press **17** OPTION to display the Option menu.

**3** Use **10** Cursor Δ / ▽ to select “Auto Preset.”



**4** Press **10** ENTER, then press **5** PRESET ^ / v or **10** Cursor Δ / ▽ to choose the preset number from which to start the Auto Preset function.

Auto Preset will begin approximately 5 seconds after you select a preset number.

If you do not select a preset number, Auto Preset will begin approximately 5 seconds after “READY” is displayed.

#### Selecting a preset number

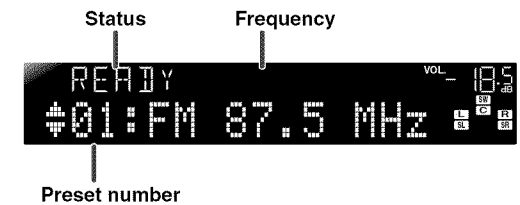

To cancel registration, press **10** RETURN.

#### During Auto Preset

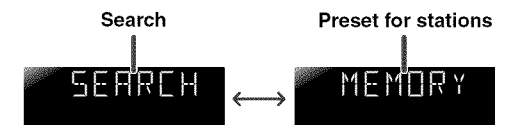

#### When Auto Preset is complete



The Option menu closes automatically when presetting is complete.

1 : See the section on “Configuring the settings specific for each input source (Option menu)” for details on the Option menu ( p. 38).

2 : The preset with the lowest preset number will be selected automatically immediately after presetting.

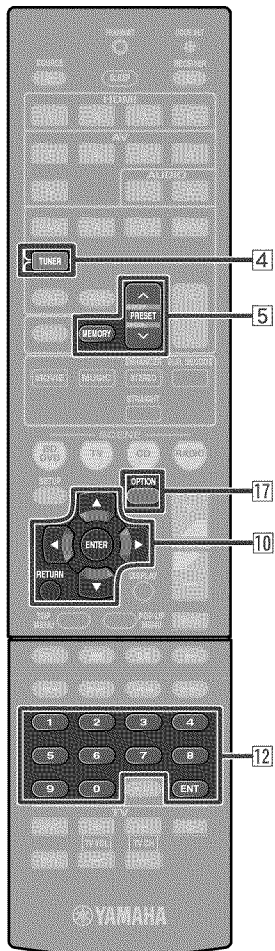

- 4 TUNER
- 5 MEMORY
- 5 PRESET ^ / ∇
- 10 Cursor Δ / ∇
- 10 ENTER
- 10 RETURN
- 12 Numeric keys
- 17 OPTION

### ■ Registering stations manually (Manual Preset)

Select stations by hand and register them as presets individually.

**1** Tune in to the station you wish to register, referring to “Selecting a frequency for reception (Normal tuning)” (p. 30).

**2** Use one of the following methods to register the station you are currently receiving.

### ■ Registering to a preset number to which no station is registered

Press **5** MEMORY for 2 seconds or longer.

The station will be registered automatically to the lowest open preset number (or the next number after the one registered most recently).



Registered frequencies

### ■ Designating a preset number for registration

Press **5** MEMORY once, to display “Manual Preset” on the front panel display. After a small wait, the preset number that the station has been registered to will appear.



Blinks      Empty, or the frequency registered most previously.

Press **5** PRESET ^ / ∇ to select the preset to register the station to, and then press **5** MEMORY to register.

To cancel registration, press **10** RETURN or do not operate the remote control for about 30 seconds.

### ■ Recalling a preset station

You can call preset stations registered by automatic station preset or manual station preset. <sup>1</sup>

To select a registered station, press **5** PRESET ^ / ∇ to select the preset number of the station. <sup>2</sup>

### Clearing preset stations

**1** Press **4** TUNER to switch to the tuner input.

**2** Press **17** OPTION to display the Option menu. <sup>3</sup>

**3** Use **10** Cursor Δ / ∇ to display “Clear Preset” and press **10** ENTER.

The number of the preset to be cleared



Blinks      Registered frequencies

Press **10** RETURN to cancel the operation.

**4** Use **10** Cursor Δ / ∇ to select the preset number you want to clear, and press **10** ENTER to clear it.

Repeat this operation to clear the registration of multiple numbers.

**5** Press **17** OPTION to finish this operation.

<sup>1</sup> : Preset numbers to which no stations are registered will be skipped. “No Presets” or “No Presets in Memory” is displayed when there are no stations are registered.

<sup>2</sup> : To select a station by selecting a preset number, use the **12** Numeric keys to enter the preset number of the station you wish listen to. When an invalid number is entered, “Wrong Num.” appears on the front panel display. Check that you have entered the correct number.

<sup>3</sup> : See the section on “Configuring the settings specific for each input source (Option menu)” for details on the Option menu (p. 38).





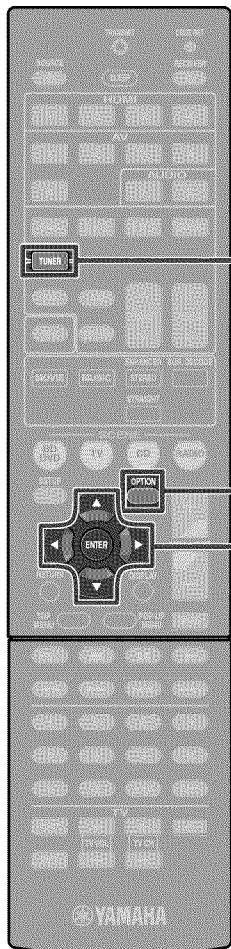

- 4 TUNER
- 10 Cursor  $\Delta$  /  $\nabla$  /  $\leftarrow$  /  $\rightarrow$
- 10 ENTER
- 17 OPTION

## Combining the video signals and radio audio signals

Select the video signal to be output from the video output jack on this unit when TUNER is selected as the input source. For example, when watching the sports relay on the TV, only audio can be switched to the radio audio.

1 Press **4**TUNER to switch to the tuner input.

2 Press **17**OPTION to display the Option menu. 1



3 Use **10**Cursor  $\Delta$  /  $\nabla$  to display "Video Out" and press **10**ENTER.



4 Use **10**Cursor  $\leftarrow$  /  $\rightarrow$  to select the video source you want to watch, and press **10**ENTER.



## Selectable video source:

HDMI1-4	Video signals input from one of the HDMI1 to 4 are output from the HDMI output jack on this unit.
AV1-2	Video signals input from either one of the AV1 and AV2 are output from the component output jack on this unit.
AV3-5, V-AUX	Video signals input from one of the AV3 to AV5 and VIDEO AUX are output from the composite output jack on this unit.
Off	Video signals are not output when TUNER is selected as the input source.

5 Press **17**OPTION to finish this operation.

1 : See the section on "Configuring the settings specific for each input source (Option menu)" for details on the Option menu (p. 38).

## Playing back tunes from your iPod™/iPhone™

Once you have connected a Yamaha iPod universal dock (such as the YDS-12, sold separately) to this unit, you can enjoy playback of your iPod/iPhone using the remote control supplied with this unit. When playing back from an iPod/iPhone, you can also use the compressed music enhancer sound field programs (see p. 29) to give compressed audio formats such as MP3 a sharper, more dynamic sound.

- iPhone 4, iPhone 3GS, iPhone 3G, iPhone, iPod touch (1st, 2nd, 3rd, and 4th generation), iPod (4th, and 5th generation, and Classic), iPod nano (1st, 2nd, 3rd, 4th, 5th, and 6th generation) and iPod mini are supported (As of October 2010).
- When connecting an iPhone, please use a YDS-12.
- Some features may not be compatible depending on the model or the software version of your iPod.
- Some functions may not be available for some Yamaha iPod universal dock models. This explanation focuses on the YDS-12.

### Connecting the Yamaha iPod universal dock

Use the dedicated cable to connect the dock to the DOCK jack on the rear panel of this unit. Refer to the operating instructions of the iPod universal dock for information on how to connect your iPod/iPhone.

#### CAUTION

To prevent accidents, place this unit in standby mode before connecting an iPod universal dock.

Switch the power on and place your iPod/iPhone in the dock. The unit is now ready for playback.



### Controlling an iPod/iPhone

After setting your iPod/iPhone in your dock, just press **DOCK** to switch to DOCK input and you can operate your iPod/iPhone.

You can use the remote control of this unit to carry out basic operations (playback, stop, skip etc) on your iPod/iPhone. You can check song information on the iPod/iPhone screen.

<b>DOCK</b>	Switches to the DOCK (iPod) input.
<b>Cursor</b> $\Delta / \nabla / \triangleleft / \triangleright$	Move the cursor up and down to different fields.
<b>Cursor</b> $\triangleleft / \triangleright$	Returns to the previous menu or enter the menu you have selected.
<b>ENTER</b>	Enters the selected menu.
$\triangleleft \triangleleft$	Searches backwards while held down.
$\triangleright \triangleright$	Searches forwards while held down.
$\triangleleft \triangleleft$	Skips to the beginning of the currently playing song. Pressing repeatedly skips one song backwards with each press.
$\triangleright \triangleright$	Skips to the beginning of the next song.
$\square$	Stops playback.
$\square$	Switches between playback and pause.
$\triangleright$	Switches between playback and pause.

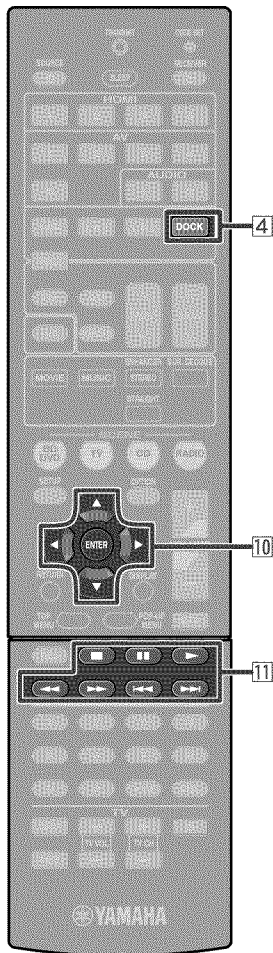

- DOCK**
- Cursor**  $\Delta / \nabla / \triangleleft / \triangleright$
- ENTER**
- $\square$
- $\square$
- $\triangleright$
- $\triangleleft \triangleleft$
- $\triangleright \triangleright$
- $\triangleleft \triangleleft$
- $\triangleright \triangleright$

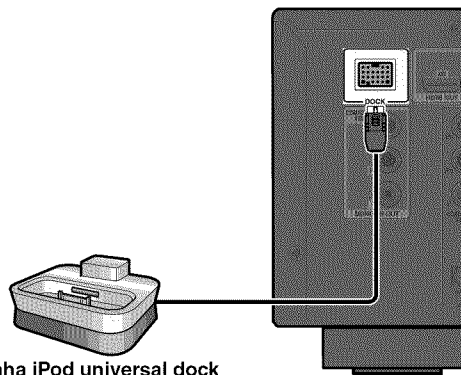

Yamaha iPod universal dock

**1** : These keys may not work for some types of iPod. In this case, carry out these operations directly with your iPod.



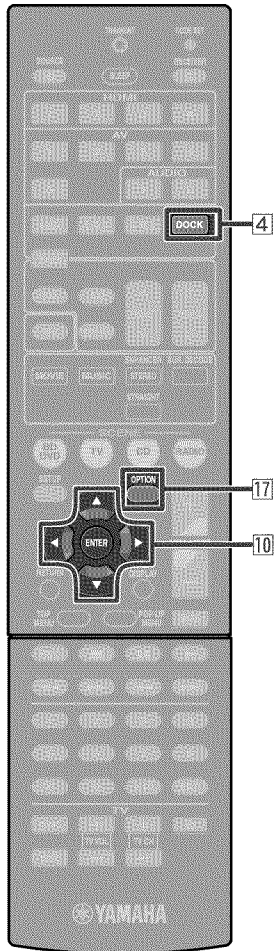

- 4 DOCK
- 10 Cursor  $\Delta$  /  $\nabla$  /  $\triangleleft$  /  $\triangleright$
- 10 ENTER
- 17 OPTION

## ■ To charge the iPod/iPhone when this unit is in standby mode

If you connect an iPod/iPhone to the iPod universal dock the iPod/iPhone will always charge when this unit is turned on.

This unit can charge an iPod/iPhone even when in standby mode (iPod Standby Charge function).

Check the iPod CHARGE indicator ( **iPod CHARGE** ) on the front panel display of this unit to check whether this unit is charging an iPod/iPhone while in standby mode. While charging an iPod/iPhone, the iPod charge indicator lights. The indicator goes out when charging is finished.

If necessary, you can also deactivate the iPod Standby Charge function.

**1** Press **4** DOCK to switch to the DOCK input.

**2** Press **17** OPTION to display the Option menu.

**3** Use **10** Cursor  $\Delta$  /  $\nabla$  to display "Standby Charge" and press **10** ENTER.



**4** Use **10** Cursor  $\triangleleft$  /  $\triangleright$  to switch the setting to "Off."

**5** When setting is completed, press **17** OPTION to close the Option menu.

To re-activate the Standby Charge function carry out this procedure again and change the "Standby Charge" setting back to "On."



## Playing back tunes from Bluetooth™ components

You can connect a Yamaha Bluetooth wireless audio receiver (such as the YBA-10, sold separately) to this unit and enjoy wireless playback from Bluetooth-compatible portable music players. 1

### NOTE

When playing back from a Bluetooth component for the first time, you must first pair the devices (register the Bluetooth components). When establishing a wireless connection you must carry out pairing on both this unit and on the Bluetooth component.

### Connecting a Yamaha Bluetooth wireless audio receiver

Use the dedicated cable to connect the dock to the DOCK jack on the rear panel of this unit.

The Bluetooth wireless audio receiver connection will be complete when this unit is turned on.

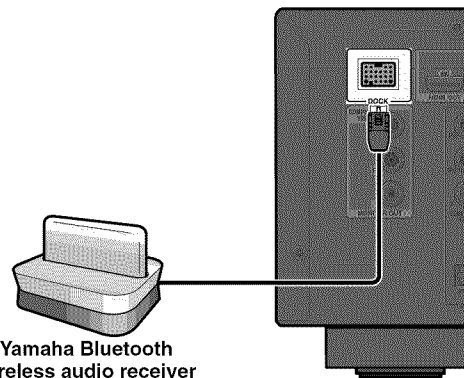

Yamaha Bluetooth wireless audio receiver

### Pairing Bluetooth™ components

Be sure to carry out pairing when connecting a Bluetooth component for the first time, or when settings have been deleted.

Refer to the operating instructions of your Bluetooth component as necessary when carrying out pairing.

The Yamaha Bluetooth wireless audio receiver can be paired with up to eight Bluetooth components. When the ninth device is paired, the pairing settings for the device which has not been used for the longest period of time will be deleted.

**1** Press **4** DOCK to switch to the DOCK input.

**2** Turn on the Bluetooth component you want to pair with and set it to pairing mode.

**3** Press **17** OPTION to display the Option menu and use **10** Cursor  $\Delta / \nabla$  to select "Pairing."



**4** Press **10** ENTER to start pairing.



- To cancel pairing, press **10** RETURN.
- You can also press and hold **5** MEMORY on the front panel to begin pairing.

**5** Make sure the Bluetooth component recognizes the Bluetooth wireless audio receiver.

When the device is recognized it will appear in the Bluetooth component list, for example as "YBA-10 YAMAHA."

**6** Select the Bluetooth wireless audio receiver from the Bluetooth component list, and enter a pass key "0000" into the Bluetooth component.

When pairing occurs correctly



- 4** DOCK
- 5** MEMORY
- 10** Cursor  $\Delta / \nabla$
- 10** ENTER
- 10** RETURN
- 17** OPTION

### CAUTION

To prevent accidents, place this unit in standby mode before connecting a Bluetooth wireless audio receiver.

1 : This unit supports A2DP (Advanced Audio Distribution Profile) of the Bluetooth profile.

## Using Bluetooth™ components

When pairing is complete, carry out the following procedure to achieve a wireless connection between this unit and the Bluetooth component. When the wireless connection is complete, you playback from Bluetooth components.

Depending on Bluetooth components, a wireless connection is established automatically or by operating the Bluetooth components. In that case, it is not necessary to carry out the following procedure.

- Use **10** Cursor  $\Delta / \nabla$  to select “Connect” and press **10** ENTER.  1

When wireless connection is complete



“Not found” is displayed when there is an error connecting. Check that the following conditions have been satisfied, and try to establish a wireless connection again.

- Both this unit and the Bluetooth component are paired.
- The Bluetooth component is switched on.
- The Bluetooth component is within 32 feet (10 meters) of the Bluetooth wireless audio receiver.

- Operate the Bluetooth component for playback.

To disconnect a wireless connection, repeat the same steps, and in step 3, select “Disconnect.”

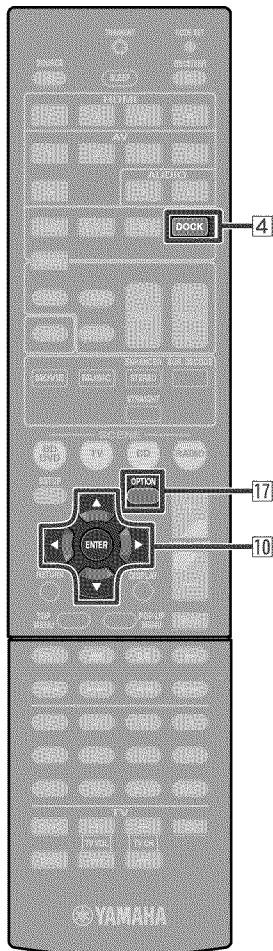

- Press **4** DOCK to switch to the DOCK input.

- Press **17** OPTION to display the Option menu.

- 4** DOCK
- 10** Cursor  $\Delta / \nabla$
- 10** ENTER
- 17** OPTION

 1 : “Disconnect” is displayed while a Bluetooth component has been connected.

# SETUP

## Configuring the settings specific for each input source (Option menu)

This receiver has a unique option menu specific for each type of input source, such as volume trim for compatible input sources, audio/video data display for signals from external devices, and other frequently used menu items.

### Option menu display and setup

**1** Use the **[4]** Input selector on the remote control to select the Option menu you wish to display.

**2** Press **[17]** OPTION.  
The Option menu appears for the desired input source.



**3** Select the desired control/setup item using **[10]** Cursor  $\Delta / \nabla$  and press **[10]** ENTER.

The displayed Option menu items differ depending on the input source.  
For details, read the following Option menu items section.

**4** Select the desired menu item (or enable a function) using **[10]** Cursor  $\Delta / \nabla / \triangleleft / \triangleright$  and **[10]** ENTER.

Parameters of the selected item are displayed. The parameters you can set differ depending on the menu items.

- You can also use **[10]** RETURN to return to the previous screen or close the Option menu.
- Certain selected menu items may automatically close the Option menu when their functions are enabled.

**5** To close the Option menu, press **[17]** OPTION.

For a few seconds after closing the Option menu, the remote control keys may not function. If this occurs, reselect the input source.

### Option menu items

The following items are provided for each input source. "✓" indicates the available menu for each input source.

	Volume Trim	Audio In	Signal Info	FM Mode	Auto Preset	Clear Preset	Video Out	Standby Charge	Connect/Disconnect	Pairing
HDMI1-4	✓	✓	✓							
AV1-2	✓	✓	✓							
AV3-4	✓		✓							
AV5	✓									
AUDIO1-2	✓									
V-AUX	✓									
TUNER	✓			✓	✓	✓	✓			
iPod (DOCK)	✓							✓		
Bluetooth (DOCK)	✓								✓	✓

- [4]** Input selector
- [10]** Cursor  $\Delta / \nabla / \triangleleft / \triangleright$
- [10]** ENTER
- [10]** RETURN
- [17]** OPTION



### Adjusting volume between input sources

#### Volume Trim

**Input source:** All

Reduces any change in volume when switching between input sources by correcting volume differences in each input source. You can adjust this parameter for each input source.

<b>Adjustable range</b>	-6.0 dB to 0.0 dB to +6.0 dB
<b>Default setting</b>	0.0 dB
<b>Adjustment increments</b>	0.5 dB steps

### Combining HDMI/AV1-2 input source video and audio

#### Audio In

**Input source:** HDMI1-4, AV1-2

Combines video from HDMI or AV input sources with analog/digital audio inputs in situations such as:

- an external device is connected with an HDMI cable but cannot transmit audio through HDMI
- an external device with component video output and analog audio output (such as certain game consoles) are connected to the system

Inputs that change the audio source



Assignable audio input jacks

To change assignments, select an input source (HDMI1-4 or AV1-2) as the video input first, and then select audio input jacks in this menu.

Set as follows according on the desired combination of audio input jacks.

Audio inputs	Settings method
Optical digital audio input	Select AV1 or AV4. Connect the external component audio cable to the optical jack for the selected input.
Coaxial digital audio input	Select AV2 or AV3. Connect the external component audio cable to the coaxial jack for the selected input.
Analog audio input	Select one of AV5, AUDIO1, or AUDIO2. Connect the external component audio cable to the audio jack for the selected input.

- For details of settings, refer to “Receiving audio from other input sources” (p. 16) and “Component connections to analog audio output devices” (p. 17).
- To return audio inputs to their previous settings, display this item again, and select the original input jack.

### Displaying information on audio/video signals

#### Signal Info

**Input source:** HDMI1-4, AV1-4 <sup>1</sup>

Displays information on digital audio and video signals on the front panel display. You can display the signal information by pressing **ENTER** on the menu item and using **Cursor**  $\Delta$  /  $\nabla$ .



Information

### Audio information

<b>FORMAT</b>	Format of audio signals.
<b>CHAN</b>	The number of input signal channels (front/surround/LFE). For example, if input signal channels are 3 front channels, 2 surrounds and LFE, “3/2/0.1” is displayed. If a channel that cannot be expressed as the above is input, a total number of channels such as “5.1ch” may be displayed.
<b>SAMPL</b>	The sampling frequency of analog-to-digital conversion.
<b>BIT RATE</b>	The bit rate of input signal per second.

### Video information

<b>V IN</b>	Format and resolution of video input signal.
<b>V OUT</b>	Format and resolution of video output signal.
<b>V MSG</b> (appears only when an error has occurred)	Error messages about HDMI signals and components. <b>Error message</b> HDCP Error    HDCP authentication failed. Device Over    The number of connected HDMI components is over the limit.

- “No Signal” is displayed when no signals are being received, and “---” is displayed if this unit cannot recognize the incoming signal.
- The bit rate may vary during playback.

<sup>1</sup> AV5 or AUDIO1-2 are also available when the “Audio Return Channel” function is on, and the source is used for the TV audio input (TVAudio).

## ■ Changing FM mode (Stereo/Monaural)

### FM Mode

**Input source:** TUNER

Sets this unit to automatically match FM broadcast frequencies in stereo, or to convert the frequency to monaural ([p. 31](#)).

## ■ Automatically presetting FM radio stations

### Auto Preset

**Input source:** TUNER

Automatically detects radio stations in the FM frequency and registers them as preset stations ([p. 31](#)).

## ■ Clearing preset FM stations

### Clear Preset

**Input source:** TUNER

Clears the preset stations ([p. 32](#)).

## ■ Combining the video signals and radio audio signals

### Video Out

**Input source:** TUNER

Select the type of video signals to be output from the video output jack on this unit when TUNER is selected as the input source ([p. 33](#)).

## ■ Charging an iPod™/iPhone™ in standby mode

### Standby Charge

**Input source:** iPod (DOCK)

Charges an iPod/iPhone stationed in the iPod universal dock while the receiver is in standby mode ([p. 35](#)).

## ■ Bluetooth™ wireless connections

### Connect

### Disconnect

**Input source:** Bluetooth (DOCK)

Enables/disables the Bluetooth wireless connection ([p. 37](#)). Select “Connect” to establish the wireless connection. Select “Disconnect” to disable the wireless connection.

## ■ Pairing the Bluetooth™ wireless audio receiver and your Bluetooth component

### Pairing

**Input source:** Bluetooth (DOCK)

Pairs your Bluetooth wireless device and this receiver ([p. 36](#)).





## Setting various functions (Setup menu)

You can configure various function settings of this unit using the Setup menu.

### Setup menu display and settings

1 Press **9** **SETUP** on the remote control.



2 Use the **10** **Cursor**  $\Delta / \nabla$  to select the desired menu and press **10** **ENTER**.

#### Setup menu categories

Speaker Setup	Manages settings for speakers.
Sound Setup	Manages settings for audio output.
Func. Setup	Manages settings to make receiver operation easier, such as input source labeling and auto-standby functions.
HDMI Setup	Manages settings for HDMI, such as HDMI Control functions.
DSP Parameter	Sets parameters for sound field programs.
Memory Guard	Protects settings against accidental alteration.



Ex: Sound Setup menu

3 Use **10** **Cursor**  $\Delta / \nabla$  to navigate the submenus to find the desired setting and press **10** **ENTER**.



4 When multiple items appear, use **10** **Cursor**  $\Delta / \nabla$  to select the desired item.

5 Press **10** **Cursor**  $\leftarrow / \rightarrow$  to change the setting. You can change other items by repeating step 4 and 5.

You can also use **10** **RETURN** to return to the previous screen.

6 Press **9** **SETUP** to exit the Setup menu.

For a few seconds after closing the Setup menu, the remote control keys may not function. If this occurs, reselect the input source.

### Setup menu items

#### Setup menu

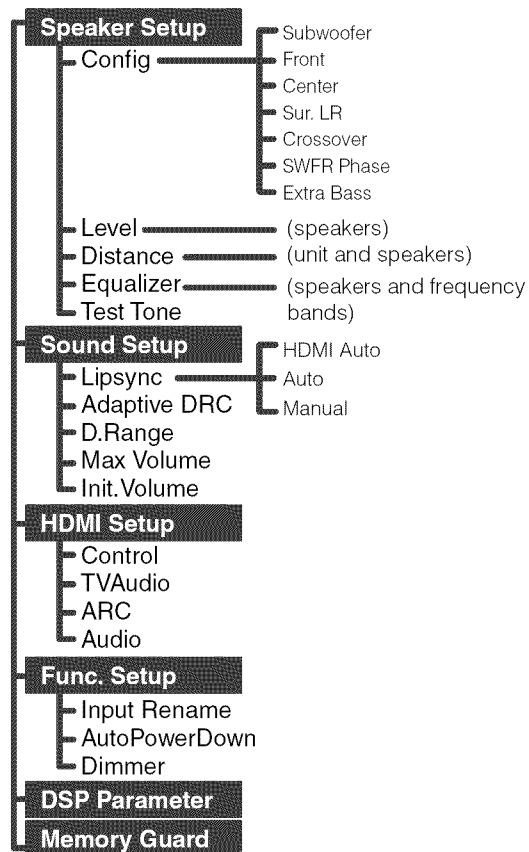

- 9** **SETUP**
- 10** **Cursor**  $\Delta / \nabla / \leftarrow / \rightarrow$
- 10** **ENTER**
- 10** **RETURN**



## Manages settings for speakers



### Speaker Setup submenu

Config	Manually manages speaker configuration, such as speaker size (sound production capacity), and bass audio processing.
Level	Manually adjusts the volume of each speaker.
Distance	Manually adjusts the output of each speaker based on distance to the listening point.
Equalizer	Selects an equalizer to adjust speaker output characteristics.
Test Tone	Generates test tones.

### Manual speaker setup

#### Config

Adjusts the output characteristics of the speakers based on manually set parameters.

In the Config submenu, you can select the speaker size characteristic (Large or Small). Select the size (sound reproduction capacity) that matches your speakers.

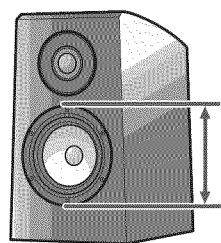

#### Woofer diameter

- 6-1/4 in (16 cm) or larger → Large
- 6-1/4 in (16 cm) or smaller → Small

When speaker size is set to “Small,” low-frequency components of the speakers that you configured are produced from the subwoofer (or from the front speakers if there is no subwoofer).

#### Subwoofer

Confirms the subwoofer.

Yes (Default)	Select this when you have a subwoofer connected. During playback, the subwoofer will produce audio from the LFE (low-frequency effect) channel and bass audio from other channels.
None	Select this when you do not have a subwoofer connected. The front speakers will produce audio from the LFE (low-frequency effect) channel and bass frequency audio from other channels.

#### Front

Selects the size (sound reproduction capacity) of the front speakers.

Small (Default)	Select this for small speakers. The subwoofer will produce front channel low-frequency components.
Large	Select this for large speakers. The front speakers will produce all of the front channel frequency components.

#### Center

Selects the size of the center speakers.

None	Select this when there is no center speaker. The front speakers will produce center channel audio.
Small (Default)	Select this when a small center speaker is connected.
Large	Select this when a large center speaker is connected.

#### Sur. LR

Selects the size of the surround speakers.

None	Select this when no surround speakers are connected. The front speakers will produce surround channel audio signals.
Small (Default)	Select this when the surround speakers are small.
Large	Select this when the surround speakers are large.

1 : Enabling the “Extra Bass” setting allows both the subwoofer and the front speakers to produce bass audio.

2 : When “Subwoofer” is set to “None,” you can only choose “Large.” If the front speaker setting is “Small” and you change “Subwoofer” to “None,” it will automatically change to “Large.”

3 : Enabling the “Crossover” setting allows you to set the frequency components of audio signals transmitted from the front speakers to the subwoofer.

### Crossover

Sets the lower limit of low-frequency component output from speakers set to “Small.”

Audio with a frequency below that limit will be produced from the subwoofer or the front speakers. 1

40Hz	110Hz
60Hz	120Hz
80Hz (Default)	160Hz
90Hz	200Hz
100Hz	

### SWFR Phase

Sets the phase of the subwoofer if the bass audio is lacking or unclear.

NRM (Default)	Does not change the subwoofer phase.
REV	Reverses the subwoofer phase.

### Extra Bass

Allows the front channel low-frequency components to be produced exclusively by the subwoofer, or by both the subwoofer and the front speakers.

Off (Default)	Depending on the size of the front speakers, either the front speakers or the subwoofer produce the front channel low-frequency components.
On	The subwoofer and the front speakers produce the front channel low-frequency components.

When the “Subwoofer” is set to “None,” the “Extra Bass” setting is disabled.

## Controlling the volume of each speaker

### Level

Separately adjusts the volume of each speaker. Use / to select the desired speaker and adjust the volume with / .

FL	Front speaker L
FR	Front speaker R
C	Center speaker
SL	Surround speaker L
SR	Surround speaker R
SWFR	Subwoofer

Adjustable range	-10.0 dB to +10.0 dB
Default setting	0 dB (FL / FR / SWFR) -1.0 dB (C / SL / SR)
Adjustment increments	0.5 dB

## Manually setting speaker distance

### Distance

Adjusts the timing at which the speakers produce audio so that sounds from the speakers reach the listening position at the same time.

### Selecting adjustment units

Use / to display “Unit,” and then use / to choose the units of length (feet or meters).

### Setting distances for each speaker

Use / to display the speaker you want to configure, and then use / to set the distance from the speaker to your listening position.

Unit	Selects the distance unit (feet or meters).
Front L	Front speaker L
Front R	Front speaker R
Center	Center speaker
Sur. L	Surround speaker L
Sur. R	Surround speaker R
SWFR	Subwoofer

Adjustable range	1.0 ft to 80.0 ft (0.30 m to 24.0 m)
Default setting	10.0 ft (3.00 m) (Front L/Front R/SWFR) 8.5 ft (2.60 m) (Center) 8.0 ft (2.40 m) (Sur. L/Sur. R)
Adjustment increments	0.5 ft (0.10 m)

1 : If your subwoofer has a volume control or a crossover frequency control, set the crossover frequency to maximum and the volume to half (or slightly less).

## ■ Adjusting sound quality with the equalizer

### Equalizer

Adjusts sound quality and tune with a graphic equalizer.

#### EQ Select

Turns the graphic equalizer on or off. By selecting GEQ and pressing **[10]ENTER**, you can adjust the characteristics of the graphic equalizer.

GEQ (Default)	Uses the graphic equalizer to adjust sound quality.
Off	Does not activate the equalizer.

## ■ Adjusting the graphic equalizer

**1** When “EQ Select” is displayed, use **[10]Cursor </>** to select “GEQ” and press **[10]ENTER**.

**2** Check that “Channel” appears and use **[10]Cursor </>** to select the speaker for which you want to adjust the equalizer.



The speaker you are adjusting

**3** Press **[10]Cursor ▾** repeatedly to select the frequency you want to adjust, then use **[10]Cursor </>** to adjust the volume.

Raising volume: Press **[10]Cursor ▷**.

Lowering volume: Press **[10]Cursor ◁**.



Frequency band

Setting the volume level for the selected frequency

Frequency range	63 Hz/160 Hz/400 Hz/1 kHz/2.5 kHz/6.3 kHz/16 kHz
Adjustable range	-6.0 dB to +6.0 dB
Default setting	0 dB
Adjustment increments	0.5 dB

You can use **[10]Cursor △ / ▽** to select another frequency or return to step 2. Repeat steps 2-3 to adjust the tone to your liking.

**4** When you have finished making adjustments, press **[9]SETUP** to close the Setup menu.

## ■ Generating test tones

### Test Tone

Turns the test tone generator on or off.

Off (Default)	Does not generate test tones.
On	Generates test tones. While “On” is selected, test tones are produced constantly.

You can use the test tone in a variety of circumstances. For example, you can adjust the volume balance settings for each speaker, or whenever you adjust the settings on the internal graphic equalizer, you can listen to the actual effect while operating this unit. Turn the test tone off when you have finished making adjustments.

## Setting the audio output function of this unit



### Sound Setup submenu

Lipsync	Adjusts the delay between video and audio output.
Adaptive DRC	Auto-adjusting the sound level to make even low volumes more audible.
D.Range	Selects the dynamic range adjustment method for digital audio playback.
Max Volume	Sets the maximum volume for this receiver.
Init. Volume	Sets the initial volume for when this receiver is turned on.

## Synchronizing audio/video output

### Lipsync

Adjusts the delay between audio and video output (Lipsync function).

### HDMI Auto

When connecting to a TV via HDMI, automatically adjusts output timing if the TV supports an automatic lipsync function.

Off	Select this when the connected TV does not support the automatic lipsync function or you do not wish to use the automatic lipsync function. Set the correction time in "Manual."
On (Default)	Select this when the TV supports the automatic lipsync function. Fine-adjust the correction time in "Auto."

### Auto

Fine-adjust the audio output timing by entering the correction time provided when "HDMI Auto" is set to "On."

Adjustable range	0 ms to 240 ms
Adjustment increments	1 ms

### Manual

Manually adjusts the correction time. Select this when the TV does not support the automatic lipsync function or "HDMI Auto" is set to "Off."

Adjustable range	0 ms to 240 ms
Adjustment increments	1 ms
Default setting	0 ms

## Auto-adjusting the sound level to make even low volumes more audible

### Adaptive DRC

Adjusts the dynamic range in conjunction with the volume level (from minimum to maximum). When you play audio at night or at low volumes, it is a good idea to set parameter to "On." 🗨️1

Off (Default)	Does not adjust the dynamic range automatically.
On	Adjusts the dynamic range automatically.

When the auto function is enabled, it adjusts the dynamic range as follows.

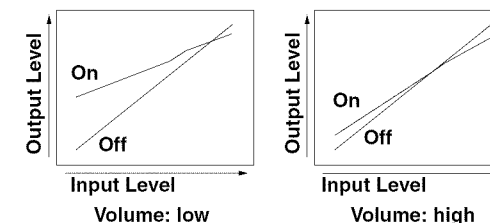

🗨️ 1 : The Adaptive DRC setting is also effective when you use headphones.

## Auto-adjusting Dolby Digital and DTS dynamic range

### D. Range

Selects the dynamic range adjustment method for audio bitstream (Dolby Digital and DTS) playback.

Min/Auto	(Min) Sets the dynamic range suitable for low volume or a quiet environment, such as at night, for bitstream signals except for Dolby TrueHD signals. (Auto) Adjusts the dynamic range for Dolby TrueHD signals based on input signal information.
Std	Adjusts the dynamic range for optimum volume for regular home use.
Max (Default)	Produces audio without adjusting the dynamic range.

## Setting the maximum volume

### Max Volume

Sets a maximum volume level so that the audio is not played too loudly. The default setting of +16.5 dB produces the highest volume.

Adjustable range	-30.0 dB to +15.0 dB / +16.5 dB (Maximum volume)
Default setting	+16.5 dB
Adjustment increments	5.0 dB

## Setting the startup volume

### Init. Volume



Sets the initial volume for when this receiver is turned on. When this parameter is set to "Off," the volume is set at the level when the receiver last entered standby mode. 1

Adjustable range	Off, Mute, -80 dB to +16.5 dB
Default setting	Off
Adjustment increments	0.5 dB

## Setting HDMI functions



### HDMI Setup submenu

Control	Turns the HDMI Control on or off.
TV Audio  2	Chooses automatically selected audio input in conjunction with TV operation when the HDMI Control is turned on.
ARC  2	Transmits audio/video output to the TV and audio input from the TV through a single HDMI cable.
Audio  2	Selects the audio output device connected to this unit via HDMI jacks.

 1 : When you set the "Max Volume" at a lower level than "Init. Volume," the "Max Volume" setting has priority.

 2 : When "Control" is set to On, "TV Audio" and "ARC" appear. When "Control" is set to Off, "Audio" appears.

### Receiver operation via TV (HDMI Control)

#### Control

Set the HDMI Control function to “On” to operate devices connected via HDMI. If the TV or other external components support HDMI Control (ex. Panasonic VIERA Link), you can use the remote controls of those devices to operate some of this unit’s functions, and to synchronize this unit with the operation of those devices.

Please refer to “Switching the input source on this unit automatically when listening to TV audio” (p. 58) for instructions.

Off (Default)	Sets HDMI Control to “Off.”
On	Sets HDMI Control to “On.”

If this unit is connected to HDMI devices that do not support the HDMI Control function, these functions will not operate.

### Selecting an input source to assign audio input for the TV

#### TVAudio

Select the input source that matches operations carried out on the TV while the HDMI Control function is on.

When using a TV that supports Audio Return Channel function and the function is enabled, the audio input for the TV is assigned to the input source selected here. 1

AV1 to AV5	Assigns any of the AV1-5 input source for the audio input from the TV.
AUDIO1/AUDIO2	Assigns AUDIO1 or AUDIO2 input source for the audio input from the TV.

Default setting	AV4
-----------------	-----

- “TVAudio” is only displayed with the HDMI Control function (Control) is set to “On.”
- Please refer to “Using the HDMI Control function” (p. 57) for setting instructions.
- For details on inputting the audio signal from the TV, refer to “Listening to TV audio” (p. 15).

### Listening to TV audio via single HDMI cable (Audio Return Channel)

#### ARC

You can enable or disable the Audio Return Channel function. When using a TV that supports Audio Return Channel function and the function is enabled, the TV’s audio output is transmit to this unit via an HDMI cable.

The TV audio input to this unit is regarded as the input source selected in “TVAudio.” 1

By means of this function, you do not need to connect the TV’s audio output (digital audio output or analog audio output) to the unit.

Off (Default)	Sets the Audio Return Channel to “Off.”
On	Sets the Audio Return Channel to “On.”

When the TV audio is input to the unit using Audio Return Channel, “TV” is displayed on the front panel display.



- “ARC” is only displayed with the HDMI Control function (Control) is set to “On.”
- Please refer to “Single HDMI cable input to TV audio with Audio Return Channel function” (p. 59) for setting instructions.

### Changing the output destination of HDMI input audio signals

#### Audio

Choose whether to playback audio from an external component such as a BD/DVD player connected via HDMI through this unit or through a TV.

Amp (Default)	Outputs audio through this unit only. When this setting is selected, the external component outputs an audio format compatible with this unit.
TV	Outputs audio through a TV only. When this setting is selected, the external component outputs an audio format compatible with the TV. 2
Amp+TV	Outputs audio from the TV and this unit. When this setting is selected, the external component outputs an audio format compatible with TV.

“Audio” is only displayed with the HDMI Control function (Control) is set to “Off.”

1 : While the Audio Return Channel function is on, the jack selected for the input source cannot be used.

2 : When “TV” is selected, the speakers of this unit do not output sound.

## Making the receiver easier to use



### Func. Setup submenu

Input Rename	Changes the input source names.
AutoPowerDown	Goes into standby mode.
Dimmer	Sets the Brightness of the front panel display.

### Changing input source names

#### Input Rename

Changes the input source names to be shown on the front panel display.

You can change an input source name by choosing from a list of templates, or make one of your own.

#### Selecting a template

- 1 Select "Input Rename" from the Setup menu and press **ENTER**.



Renaming the input source

- 2 Select the input source that you want to rename using **Cursor**  $\Delta / \nabla / \leftarrow / \rightarrow$ .

- 3 Use **Cursor**  $\leftarrow / \rightarrow$  to select a new name from the following templates.

Blu-ray	Satellite
DVD	VCR
SetTopBox	Tape
Game	MD
TV	PC
DVR	iPod
CD	HD DVD
CD-R	(blank)



- 4 Confirm the new display name by pressing **RETURN**. Press **SETUP** to exit the Setup menu.

To cancel a name change, select the original name and then press **RETURN** to exit renaming.

#### Entering an original name

- 1 Select "Input Rename" from the Setup menu and press **ENTER**.

- 2 Select the input source that you want to rename using **Cursor**  $\Delta / \nabla$ .

- 3 Press **ENTER**.



- 4 Use **Cursor**  $\Delta / \nabla$  to select the characters you wish to change, and use **Cursor**  $\leftarrow / \rightarrow$  to enter those characters.

The following characters are available for input source.

- A to Z, a to z
- 0 to 9
- Symbols (#, \*, -, +, etc.)
- Space

- 5 Repeat step 4 until you have entered the new input source name.



- 6 Confirm the new display name by pressing **ENTER**. Press **SETUP** to exit the Setup menu.

To cancel a name change, press **RETURN**.

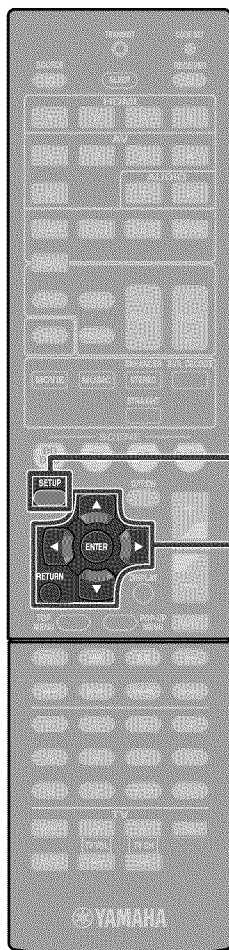

- 9 SETUP
- 10 Cursor  $\Delta / \nabla / \leftarrow / \rightarrow$
- 10 ENTER
- 10 RETURN



## ■ Goes enter standby mode automatically when you leave it without operating

### AutoPowerDown

If you do not operate this unit or use the remote control for an extended period of time, it will automatically go into standby mode (Auto Power Down function). This function's default setting is "Off." When you wish to activate this function, set the amount of time to pass before this unit will enter standby.

Off (Default)	Auto Power Down function is disabled.
4hours	Goes into standby mode, when you have not operated this unit for four hours.
8hours	Goes into standby mode, when you have not operated this unit for eight hours.
12hours	Goes into standby mode, when you have not operated this unit for twelve hours.

This unit starts a countdown of 30 seconds before entering the standby mode. Pressing any key of the remote control during the countdown cancels entering the standby mode and reset the timer.

## ■ Setting the brightness of the front panel display

### Dimmer

Sets the brightness of the front panel display. Lowering the setting dims the display.

Adjustable range	-4 to 0
Default setting	0

## Setting sound field program parameters

You can set the parameters for the sound field programs (p. 50).



## Prohibiting setting changes



Prohibits setting changes to prevent careless changes being made to the settings on Setup menu.

Off (Default)	Settings are not protected.
On	Prohibits changes to the settings on Setup menu until it is returned to "Off." While set to "On," the unit displays "Memory Guard!" when an attempt is made to change the settings.

## Setting sound field program parameters

Although the sound field programs would satisfy you as they are with the default parameters, you can arrange the effect by setting the sound field elements (parameters). To adjust the sound effects suitable for acoustical conditions of audio/video sources or rooms, perform the following operations.

### Setting sound field parameters

**1** Press **9** **SETUP** to display the Setup menu.

**2** Use **10** **Cursor**  $\Delta / \nabla$  to select "DSP Parameter" and press **10** **ENTER**.



**3** Use **10** **Cursor**  $\leftarrow / \rightarrow$  to choose the sound field program you want to edit.



Sound field program to be edited

**4** Press **10** **Cursor**  $\Delta / \nabla$  to select the parameter that you want to change, and press **10** **Cursor**  $\leftarrow / \rightarrow$  to change the parameter.



Sound field parameter

Choices

When there are multiple parameters in the sound field program you are configuring, repeat step 4 as necessary to change other parameters.

**5** Once you have completed editing, press **9** **SETUP** to close the Setup menu.

#### ■ To initialize the sound field parameters

To set the parameters of the sound field program back to default, press **10** **Cursor**  $\nabla$  repeatedly during editing to select "Initialize" and press **10** **Cursor**  $\triangleright$ . When "Press Again >" is displayed, press **10** **Cursor**  $\triangleright$  again to initialize.



To cancel operations, press **10** **Cursor**  $\leftarrow$  when "Press Again" appears and return to the original display.

### ■ CINEMA DSP parameters

#### DSP Level

Change the effect level (level of the sound field effect to be added). You can adjust the level of the sound field effect while checking the sound effect.

Adjustable range	-6 dB to 0 dB to +3 dB
Default setting	0 dB

Adjust "DSP Level" as follows:

- The effect sound is too soft.  
→ Increase the effect level.
- There are no differences between effects of the sound field programs.  
→ Increase the effect level.
- The sound is dull.  
→ Reduce the effect level.
- The sound field effect is added too much.  
→ Reduce the effect level.

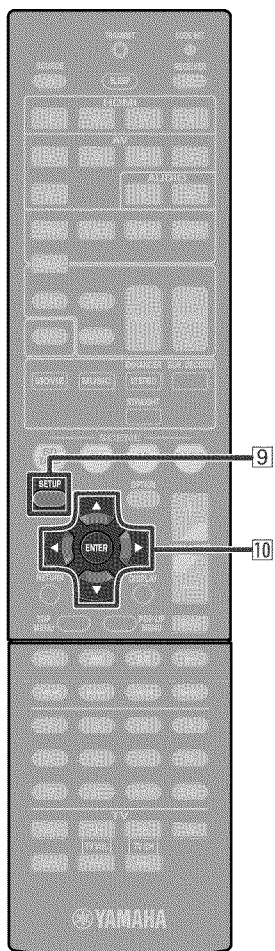

- 9** **SETUP**
- 10** **Cursor**  $\Delta / \nabla / \leftarrow / \rightarrow$
- 10** **ENTER**

### Parameters usable in certain sound field programs

#### 2ch Stereo only

##### Direct

Automatically bypasses the DSP circuit and tone control circuit depending on the condition of tone control etc., when an analog sound source is played back. You can enjoy a higher quality sound.

Auto (Default)	Outputs sound by bypassing the DSP circuit and tone control circuit when both tone controls of "Bass" and "Treble" are set to 0dB.
Off	Does not bypass the DSP circuit and tone control circuit.

#### 5ch Stereo only

##### CT Level

Adjusts the center channel volume.  1

Adjustable range	0 to 100%
Default setting	100%

##### SL Level

Adjusts the volume of the surround L channel.  1

Adjustable range	0 to 100%
Default setting	100%

##### SR Level

Adjusts the volume of the surround R channel.  1

Adjustable range	0 to 100%
Default setting	100%

### Straight Enhancer/5ch Enhancer only

##### EFCT LVL

Adjusts the effect level of the compressed music enhancer mode.

High (Default)	Standard effect.
Low	Sets when the high-frequency signals of the source are emphasized excessively.

### Parameters usable in surround decoder

#### PLII Music only

##### Panorama

Adjusts the soundscape of the front sound field. Sends front left/right channels sounds to the surround speakers as well as the front speakers for a wraparound effect.

Off (Default)	Disables the effect.
On	Enables the effect.

##### CT Width

Spreads the center channel sound to the front left and right speakers to suit your needs or preferences. Set this parameter to 0 for outputting the center sound from the center speaker only, or to 7 for outputting it from the front left/right speaker only.

Adjustable range	0 to 7
Default setting	3

##### Dimension

Adjusts the difference in level between the front sound field and the surround sound field. You can adjust the difference in level created by the software being played back to obtain the preferred sound balance.

The surround sound gets stronger as you make the value more negative, and the front sound gets stronger as you make the value more positive.

Adjustable range	-3 to +3
Default setting	0

#### When Neo:6 Music is selected

##### C. Image

Adjusts the front left and right channel output relative to the center channel to make the center channel more or less dominant as necessary.

Adjustable range	0.0 to 1.0
Default setting	0.3

 1 : Not displayed when speakers are set to be inactive.

## Controlling other components with the remote control

You can operate an external component such as TV and DVD player with the remote control of this unit by setting the code for external component (remote control code). The remote control code can be set for each input source. Individual setting allows you to switch external components seamlessly depending on the selected input source.

### Selecting input source connected to DVD player

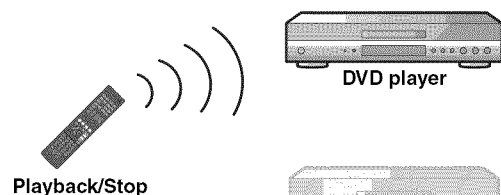

Playback/Stop  
DVD player

### Selecting input source connected to CD player

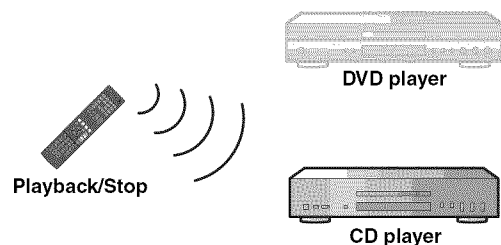

Playback/Stop  
CD player

If you are unable to operate this unit after operating an external component, press **9** **SETUP** or **17** **OPTION** and then try operating the remote control again.

### Keys connecting external components

The remote control keys for controlling external components are available only when the external components have corresponding control keys.

**3** **SOURCE** Switches an external component on and off.

**10** **Cursor**, **10** **ENTER**, **10** **RETURN** Operates the menus of external components.

**11** **DISPLAY** Switches an external component display.

**11** **External component operation keys** Functions as a recording or playback key of an external component, or a menu display key.

**12** **Numeric keys** Functions as numeric keys of an external component.

**13** **TV control keys** 1

<b>13</b> <b>INPUT</b>	Switches video inputs of TV
<b>13</b> <b>MUTE</b>	Mutes TV volume temporarily.
<b>13</b> <b>TV VOL +/-</b>	Controls the volume of TV
<b>13</b> <b>TV CH +/-</b>	Switches TV channels.
<b>13</b>	Turns on and off TV

### Default remote control code settings

The following remote control codes are assigned to input sources as factory default settings. For a complete list of available remote control codes, please refer to “Remote Control Code Search” in the CD-ROM.

Input	Category	Manufacturer	Remote control code
<b>HDMI1</b>	Blu-ray player/recorder	Yamaha	2064
<b>HDMI2</b>	—	—	—
<b>HDMI3</b>	—	—	—
<b>HDMI4</b>	—	—	—
<b>AV1</b>	—	—	—
<b>AV2</b>	—	—	—
<b>AV3</b>	CD player	Yamaha	5095
<b>AV4</b>	—	—	—
<b>AV5</b>	—	—	—
<b>AUDIO1</b>	—	—	—
<b>AUDIO2</b>	—	—	—
<b>V-AUX</b>	—	—	—
<b>A/B</b> 2	—	—	—
<b>DOCK</b>	DOCK	Yamaha	5089
<b>TUNER</b>	Tuner	Yamaha	5085

- 3** **SOURCE**
- 4** **Input selector**
- 9** **SETUP**
- 10** **Cursor**
- 10** **ENTER**
- 10** **RETURN**
- 11** **External component operation keys**
- 11** **DISPLAY**
- 12** **Numeric keys**
- 13** **TV control keys**
- 13** **INPUT**
- 13** **MUTE**
- 13** **TV VOL +/-**
- 13** **TV CH +/-**
- 13**
- 17** **OPTION**

1 : You can register remote control codes for external components to **4** **Input selector** and remote control codes for TVs in **13** (**13** **TV control keys**).  
To register a TV remote control code to **4** **Input selector**: You can use the **10** **Cursor**, **12** **Numeric keys**, and **13** **TV control keys** to control a TV you have registered.

To register a remote control code for a device other than a TV to **4** **Input selector**: You can use the **10** **Cursor** and **12** **Numeric keys** etc to control external components, and the **13** **TV control keys** to control TVs registered in **13** .

2 : Use A/B for external component operations only. Set these keys to remote control codes if you want to perform external component operations without linking to input source selection of this unit. For example, it may be convenient to assign remote control codes for devices such as TVs.



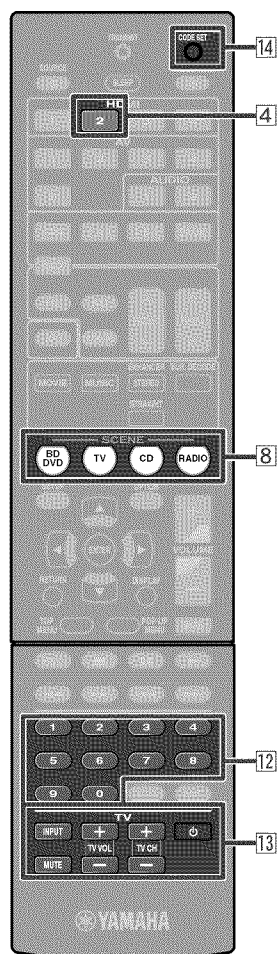

- 4 HDMl2
- 8 SCENE
- 12 Numeric keys
- 13 TV control keys
- 13
- 14 CODE SET

### Registering remote control codes for external component operations

The following section describes how to register remote control code using an example of the registration of the remote control codes of a Yamaha BD player connected to HDMI2 jack.

- Perform each of the following steps within 1 minute. Settings will be automatically stopped if more than 1 minute passes since the last operation. To reset, repeat from step 2.
- Remote control code of an external component cannot be set from the name or model number of a unit. Use “Remote Control Code Search” in the CD-ROM to search the available remote control codes from the category or manufacturer of external components.
- If multiple remote control codes exist, first set the first code in the list, if it does not work then try the other codes.

**1 Use “Remote Control Code Search” in the CD-ROM to search the available remote control codes from the category or manufacturer of external components.**

“2064” can be used for a Yamaha BD player.

**2 Press 14 CODE SET on the remote control using a pointed object such as the tip of a ballpoint pen.**

**3 Press 4 HDMl2 on the remote control to switch the input source to HDMl2. 1**

Perform the following steps to register the selected input source here to the remote control code.

**4 Enter a remote control code “2064” using 12 Numeric keys. 2**



Once the remote control code is registered successfully the remote control will blink twice.

Registration successful: blinks twice  
Registration failed: blinks 6 times

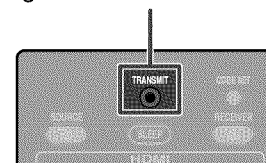

- If the registration fails, repeat the step 2.
- In case of an external component with multiple remote control codes, the other remote control codes may be supported. Repeat from step 2 with the other remote control codes.

1 : When you want to register a remote control code to the 13 TV control keys, press 13 (13 TV control keys) in step 3.

2 : When you want to register a remote control code to the 13 TV control keys, enter the TV remote control code in step 4.

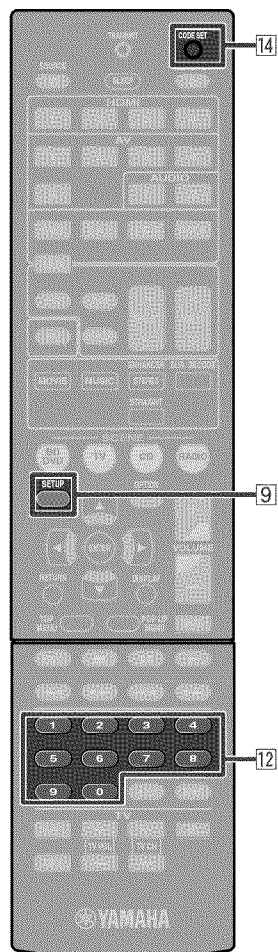

## Resetting all remote control codes

Resetting all remote control codes for external components to the initial factory settings.

Perform each of the following steps within 1 minute. Settings will be automatically stopped if more than 1 minute passes since the last operation. To reset, repeat from step 2.

**1** Press **14** CODE SET on the remote control using a pointed object such as the tip of a ballpoint pen.

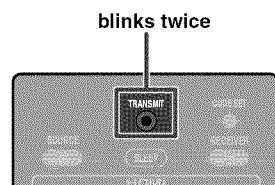

**2** Press **9** SETUP on the remote control.

**3** Enter "9981" using **12** Numeric keys.



Once the remote control code is registered successfully the remote control will blink twice.

Registration successful: blinks twice  
Registration failed: blinks 6 times

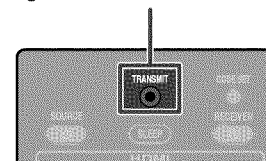

If setup fails, repeat from step 1.

- 9** SETUP
- 12** Numeric keys
- 14** CODE SET

## Extended functionality that can be configured as needed (Advanced Setup menu)

The Advanced Setup menu can be used for unit initialization and other useful extended functions. The Advanced Setup menu can be operated as follows.

### Displaying/Setting the Advanced Setup menu

**1** Set this unit to the standby mode.

**2** Press  while pressing and holding **STRAIGHT** on the front panel.

Release the keys when “ADVANCED SETUP” is displayed on the front panel display.

After approximately 3 seconds, the top menu items are displayed.

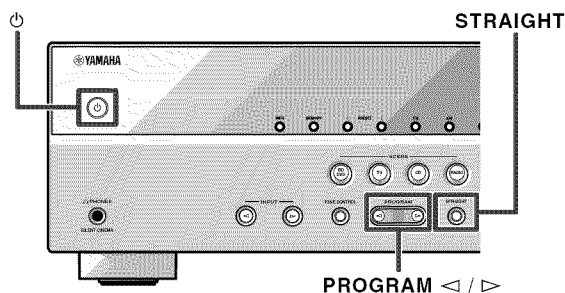

**3** Use **PROGRAM** to select the item to be set from the following items.

In the Advanced Setup menu, you can set the following settings.

SP IMP.	Sets the impedance of speakers.
REMOTE ID	Changes the remote control ID of a receiver.
INIT	Initializes various settings for this unit.

**4** Press **STRAIGHT** a few times to select the value you wish to change.

**5** Switch this unit to the standby mode, and then switch it on again.

The settings become effective and the unit is powered on. If initialization is selected, it will be performed when the unit is powered on again.

### Setting the impedance of speakers



Changes the unit settings depending on the impedance of the speakers connected.  1

6Ω MIN	Select the impedance when 6Ω speakers are connected.
8Ω MIN (Default)	Select the impedance when speakers above 8Ω are connected.

 1 : For detailed procedures of speaker impedance settings, refer to “Changing speaker impedance” (p. 10).

## Avoiding crossing remote control signals when using multiple Yamaha receivers



The remote control of the unit can only receive signals from a receiver which has an identical ID (remote control ID). When using multiple Yamaha AV receivers, you can set each remote control with a unique remote control ID for its corresponding receiver. On the contrary, if you are setting the same remote control ID for all receivers, you can use one remote control to operate 2 receivers.

ID1 (Default)	Receives the remote control signals set in ID1.
ID2	Receives the remote control signals set in ID2.

ID1 is set for both remote control and receiver by default. To avoid crossing remote control, change the remote control ID for both remote control and receiver.

### ■ To change the remote control ID

Perform each of the following steps within 1 minute. Settings will be automatically stopped if more than 1 minute passes since the last operation. To reset, repeat from step 1.

- 1 Press **14**CODE SET on the remote control using a pointed object such as the tip of a ballpoint pen.
- 2 Press **9**SETUP on the remote control.
- 3 Enter the desired remote control ID code.

To switch to ID1:  
Enter "5019" using **12**Numeric keys.

To switch to ID2:  
Enter "5020" using **12**Numeric keys.

Once the remote control code is registered successfully the remote control will blink twice.

Registration successful: blinks twice  
Registration failed: blinks 6 times

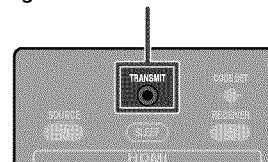

- If setup fails, repeat from step 1.
- Returns to ID1 after the remote control code is initialized (see p. 54).

## Initializing various settings for this unit



Initializes various settings stored in this unit and sets it back to default.

Select the items to be initialized from the following.

DSP PARAM	Initializes all parameters for the sound field programs.
ALL	Resets this unit to default factory settings.
CANCEL (Default)	Does not initialize.

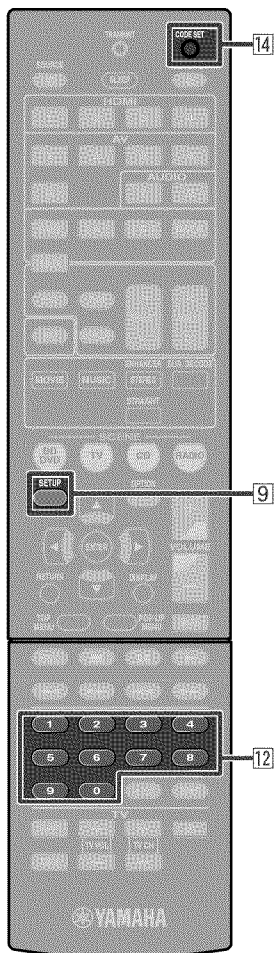

- 9** SETUP
- 12** Numeric keys
- 14** CODE SET



## Using the HDMI Control function

This unit supports the HDMI Control function, which allows you to operate external components via HDMI. If you connect devices that support HDMI Control (ex. Panasonic VIERA Link-compatible TVs, DVD/Blu-ray Disc recorders, etc.) <sup>1</sup>, you can use the following operations with the remote control of any of those devices:

- Power synchronization (on/standby)
- Volume control, including Mute
- Changing the volume of the audio output signal device (either the TV or this unit)

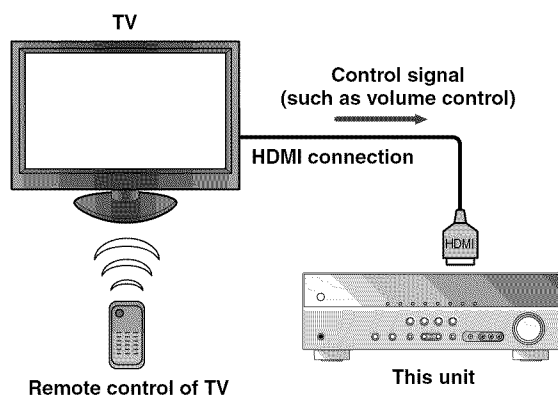

### NOTE

The following is an example of how to connect this unit, a TV, and a DVD recorder. Follow the instructions in your TV and DVD recorder manuals, as well as the ones written below.

- Set the TV's HDMI Control function to "On"
- Follow the AV amplifier connection instructions, and connect this unit to the TV

**1** Connect the TV, DVD recorder supporting HDMI Control to this unit's HDMI output jack.

**2** Turn on the TV and this unit.

Refer to the TV's instruction manual on how to operate external components.

**3** Press **[9]SETUP**. <sup>2</sup>

**4** Use **[10]Cursor**  $\Delta$  /  $\nabla$  to select "HDMI Setup" and press **[10]ENTER**.



**5** Make sure that "Control" is selected, and then use **[10]Cursor**  $\leftarrow$  /  $\rightarrow$  to select "On."



Press **[9]SETUP** when you have finished changing the setting.

**6** Set the TV/DVD recorder's HDMI Control function to On.

Check the instruction manuals for those devices.

**7** Turn the TV off.

Other synchronized HDMI Control devices are turned off with the TV. If they are not synchronized, turn them off manually.

**8** Turn the TV on.

Confirm that this unit has turned on in conjunction with the TV. If it is still off, turn it on manually.

**9** Change the TV's input setting to the input jack that is connected to this unit (ex. HDMI1).

**10** If DVD recorder that supports the HDMI Control function are connected to this unit, turn them on.

Receiver unit	Confirm that the input source for the DVD recorder has been selected. If a different input source has been selected, please change it manually.
TV/DVD Recorder	Confirm that the video signal from the recorder is being properly received by the TV.

Operations 1-10 will not be required more than twice.

**11** Confirm that this unit is properly synchronized with the TV through the following operations by using the TV remote control.

- Power On/Off
- Volume Control
- Switching between audio output devices

If this unit is not synchronized to the TV's power operations, check that the HDMI Control function is set to "On" for both devices.

If they will not properly synchronize, unplugging and re-plugging the devices and turning them on and off may solve the problem.

<sup>1</sup> : We recommend that you use TVs and DVD/BD recorders from the same manufacturer whenever possible.

<sup>2</sup> : Refer to the "Setting various functions (Setup menu)" (<sup>2</sup>p. 41) for details on the Setup menu.

### Switching the input source on this unit automatically when listening to TV audio

When the HDMI Control (p. 57) is operating properly, the input source of this unit is automatically changed to match operations carried out on the TV. The default input jack is AV4. If the AV4 optical digital jack is connected to the TV's audio output jack, then you can enjoy TV sound through this unit right away.

To use other jacks to input audio signals from TV, carry out the following procedure.

**1** Connect this unit and the TV with an HDMI cable.

**2** Connect TV's audio output to this unit.  
The input jacks listed below are available to input TV's audio signals. Use the same jack type as used for the TV.

TV output jack	Input jack
Optical digital audio output	AV1 or AV4 (default)
Coaxial digital audio output	AV2 or AV3
Analog stereo output	AV5, AUDIO1, or AUDIO2

Available input jacks

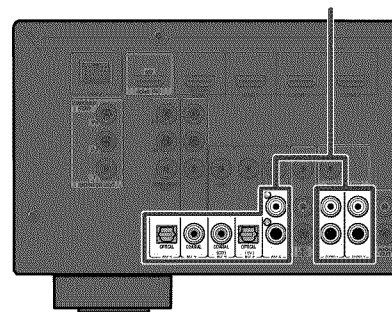

**3** Press **9**SETUP.

**4** Use **10**Cursor  $\Delta$  /  $\nabla$  to select "HDMI Setup" and press **10**ENTER.



**5** Make sure that "Control" is selected, and then use **10**Cursor  $\leftarrow$  /  $\rightarrow$  to select "On."



**6** Press **10**Cursor  $\nabla$  to select "TVAudio" and select the input jack connected in step 2 using **10**Cursor  $\leftarrow$  /  $\rightarrow$ .



**7** Press **9**SETUP when you have finished changing the settings.

If the TV hereafter transmits audio output signals, this unit will automatically switch to the input source chosen in step 6.

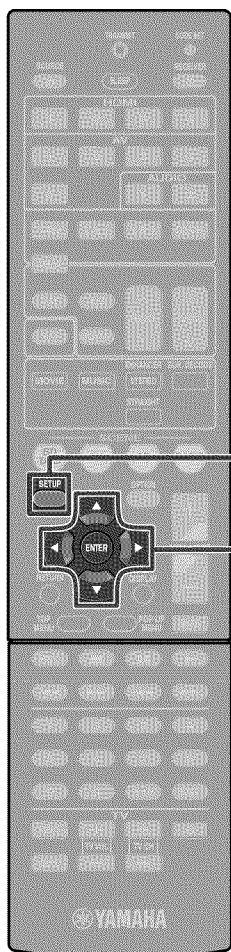

- 9** SETUP
- 10** Cursor  $\Delta$  /  $\nabla$  /  $\leftarrow$  /  $\rightarrow$
- 10** ENTER

1 : Refer to the "Setting various functions (Setup menu)" (p. 41) for details on the Setup menu.

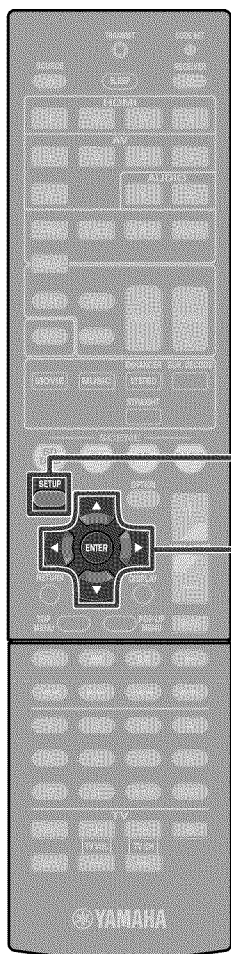

- 9 SETUP
- 10 Cursor  $\Delta$  /  $\nabla$  /  $\triangleleft$  /  $\triangleright$
- 10 ENTER

## Single HDMI cable input to TV audio with Audio Return Channel function

When using a TV that supports HDMI functions and Audio Return Channel function, audio/video output from this unit to the TV or audio output from the TV to this unit can be transmitted through a single HDMI cable (Audio Return Channel function). Audio signals transmitted from the TV to this unit can be assigned to any input source.

**1** Connect this unit and the TV with an HDMI cable.

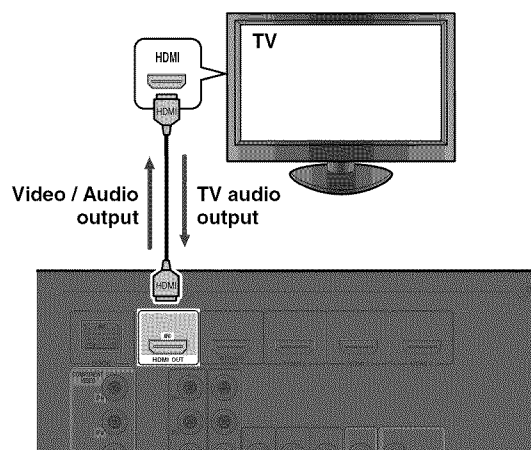

**2** Press 9 SETUP. <sup>⚠1</sup>

**3** Use 10 Cursor  $\Delta$  /  $\nabla$  to select “HDMI Setup” and press 10 ENTER.



**4** Make sure that “Control” is selected, and then use 10 Cursor  $\triangleleft$  /  $\triangleright$  to select “On.”



**5** Press 10 Cursor  $\nabla$  to select “TVAudio” and select the input source that you want to assign to the HDMI audio signals from the TV using 10 Cursor  $\triangleleft$  /  $\triangleright$ . <sup>⚠2</sup>

**6** Press 10 Cursor  $\nabla$  to select “ARC” and press 10 Cursor  $\triangleright$  to select “On.”

The Audio Return Channel function will turn on.



**7** Press 9 SETUP when you have finished changing the settings.

If the TV hereafter transmits audio output signals, this unit will automatically switch to the input source chosen in step 6.

<sup>⚠1</sup> : Refer to the “Setting various functions (Setup menu)” (p. 41) for details on the Setup menu.

<sup>⚠2</sup> : While the Audio Return Channel function is on, the jack selected for the input source cannot be used.

# APPENDIX

## Troubleshooting

Refer to the table below when this unit does not function properly.

If the problem you are experiencing is not listed below, or if the instructions below do not help, turn off this unit, disconnect the power cable, and contact the nearest authorized Yamaha dealer or service center.

### General

Problem	Cause	Remedy	See page
<b>The power will not turn on.</b>	The protection circuitry operated three times consecutively.	As a safety precaution, when the protection circuitry operates three times consecutively, the capability to turn on the power is disabled. Please contact your nearest Yamaha dealer or service center to request repair.	—
<b>The unit enters standby mode soon after the power is turned on.</b>	The power cable is not completely inserted.	Connect the power cable properly to an AC wall outlet.	—
	The speaker impedance settings are incorrect.	Set the speaker impedance to match your speakers.	<u>10</u>
	(When this unit is turned back on and “CHECK SP WIRES!” is displayed.) The protection circuitry has been activated because this unit was turned on while a speaker cable was shorted.	Make sure that all speaker cables between this unit and speakers are connected properly.	<u>12</u>
<b>This unit cannot be turned off or does not work properly.</b>	The internal microcomputer is hung-up due to an external electric shock (such as lightning or excessive static electricity) or by a drop in power supply voltage.	Disconnect the power cable from the AC wall outlet, wait about 30 seconds and then plug it in again.	—
	The batteries in the remote control may have lost their charge.	Replace all batteries.	<u>4</u>
<b>The unit enters standby mode.</b>	The protection circuitry has been activated because of a short circuit, etc.	Check that the speaker impedance settings are correct.	<u>10</u>

Problem	Cause	Remedy	See page
<b>After display of a countdown on the front panel, the unit goes into standby mode.</b>	If you do not use take any action, the Auto Power Down function operates.	Turn on the unit, and play the source again.	—
		In the Setup menu “AutoPowerDown” (“Func. Setup” → “AutoPowerDown”), increase the time until switching to standby mode, or turn off the Auto Power Down function.	<u>49</u>
<b>“Internal Error” is displayed on the front panel display.</b>	An internal error has occurred.	Please contact authorized Yamaha dealer or service center to request repair.	—
<b>Sound/images suddenly go off.</b>	The protection circuitry has been activated because of a short circuit, etc.	Check that the speaker impedance settings are correct.	<u>10</u>
		Check that the speaker wires are not touching each other, then turn the unit back on.	—
	The sleep timer has turned off the unit.	Turn on the unit, and play the source again.	—

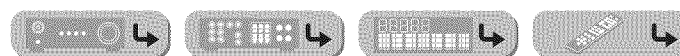

Problem	Cause	Remedy	See page
<b>No sound.</b>	Incorrect input or output cable connections.	Connect the cables properly. If the problem persists, the cables may be defective.	<u>16</u>
	If a DVI-HDMI cable is used to connect the unit with an external component, then it is necessary to use an audio input jack for a different input to output audio.	Display the HDMI Input Option menu for the connected cable, select "Audio In," and select the jack to use for audio input.	<u>39</u>
	Speaker connections are not secure.	Secure the connections.	<u>12</u>
	The HDMI components connected to the unit do not support the HDCP copy protection standards.	Connect HDMI components that support the HDCP copy protection standards.	<u>39</u>
	The audio input into the device is set to playback through the TV.	In the Setup menu, set the HDMI Audio Out ("HDMI Setup" → "Audio") to other than "TV."	<u>47</u>
	No appropriate input source has been selected.	Select an appropriate input source with <b>[4]Input selector</b> (on the remote control).	<u>25</u>
	The volume is turned down or muted.	Turn up the volume.	—
	Signals that this unit cannot reproduce are being input from a source component, such as a CD-ROM.	Use an input source that has signals that can be reproduced on this unit.	—
<b>No picture.</b>	A video jack (ex. Video input → HDMI output) type different to the input video is being used to try to display content on the TV.	Use video jacks of the same type (ex. Video input → Video output) to connect to the TV.	<u>14</u>
	An appropriate video input is not selected on the TV.	Select an appropriate video input on the TV.	—

Problem	Cause	Remedy	See page	
<b>No sound is output from a specific speaker.</b>	The speaker is malfunctioning. Check the Speaker indicators on the front panel display. If the corresponding indicator lights up, connect another speaker and check if sound is output.	If sound is not output, the unit may be malfunctioning.	<u>7</u>	
	The playback component or speakers are not connected properly.	Connect the cables properly. If the problem persists, the cables may be defective.	<u>12, 16</u>	
	Output from that speaker is disabled.	Check the Speaker indicators on the front panel display. If the corresponding indicator is turned off, try the following. 1) Change to a different input source. 2) With the selected sound field program, sound is not output from that speaker. Select another sound field program. 3) "None" may have been selected for that speaker on this unit. Display "Speaker Setup" in the Setup menu, and set respective parameters to enable output from that speaker ("Speaker Setup" → "Config").	<u>7, 42</u>	
	The volume of that speaker is set to the minimum in "Speaker Setup" in the Setup menu.	Display "Speaker Setup" in the Setup menu and adjust the volume ("Speaker Setup" → "Level").	<u>43</u>	
	(If hardly any sound comes from one channel) Speaker output balance is not set correctly.	Balance the volume of each speaker from "Level" in the Setup menu ("Speaker Setup" → "Level").	<u>43</u>	
	Sound may not be output from certain channels, depending on the input source or sound field program.	Try another sound field program.	<u>26</u>	
	<b>Only the center speaker outputs substantial sound.</b>	When a monaural source sound field program is applied, for some surround decoders, sound from all channels is output from the center speaker.	Try another sound field program.	<u>26</u>



Problem	Cause	Remedy	See page
<b>No sound is heard from the surround speakers.</b>	This unit is in straight decoding mode and a monaural source is being played back.	Press <b>[7] STRAIGHT</b> (on the remote control) to exit straight decoding mode.	<u>27</u>
	Sound may not be output from certain channels depending on input sources or sound field programs.	Try another sound field program.	<u>26</u>
<b>No sound is heard from the subwoofer.</b>	A subwoofer is not connected, or it is disabled.	Check that a subwoofer is connected correctly, and from the Setup menu "Subwoofer" ("Speaker Setup" → "Config" → "Subwoofer"), set the subwoofer to "On."	<u>42</u>
	The subwoofer is turned off.	Turn the subwoofer power on. If the subwoofer includes an Auto Power Off function, then lower the Auto Power Off sensitivity settings.	—
	The source does not contain LFE ( <u># p. 67</u> ) or low frequency signals.		—
<b>The right combination of audio / video jacks to connect cannot be found.</b>	Combine input connected to the external component video output with another input audio jack.	Select a desired input source (HDMI1-4 or AV1-2) as a video input and select a audio input source from "Audio In" in the Option menu.	<u>39</u>
<b>The audio input sources cannot be played in the desired digital audio signal format.</b>	The connected component is not set to output the desired digital audio signals.	Set the playback component properly referring to its instruction manual.	—
<b>There is noise interference from digital or radio frequency equipment.</b>	This unit is too close to other digital or radio frequency equipment.	Move this unit further away from such equipment.	—

Problem	Cause	Remedy	See page
<b>Noise/hum noise is heard.</b>	Incorrect cable connection. Connect the audio cables properly.	If the problem persists, the cables may be defective.	—
	A DTS-CD is being played back.	If a DTS bitstream signal is not properly input to this unit, only noise is output. Connect the playback component to this unit by digital connection and play back the DTS-CD. If the condition is not resolved, the problem may result from the playback component. Consult the manufacturer of the playback component.	—
<b>The volume cannot be increased, or the sound is distorted.</b>	The component connected to the output jacks of this unit is not turned on.	When the component connected to the output jacks of this unit is not turned on, the sound may be distorted, or the volume may decreased due to the nature of AV receivers. Turn on all components connected to this unit.	—
	"Max Volume" is set to a low value.	Set it to a higher value.	<u>46</u>

### HDMI™

Problem	Cause	Remedy	See page
<b>The front panel display HDMI indicator is flashing.</b>	An error with the HDMI connection has occurred.	Try re-inserting the HDMI cable.	—
		Confirm that HDMI video that is not supported by the unit is not being input (HDMI Input → Option menu → “Signal Info”).	<a href="#">39</a>
<b>No picture or sound.</b>	The number of components is over the limit.	Disconnect some of the HDMI components.	—
	The connected HDMI component does not support high-bandwidth digital copyright protection (HDCP).	Connect an HDMI component that supports HDCP.	—
<b>(When using HDMI Control function) TV sound is not output from this unit when operating the remote control of the TV.</b>	The TV audio output is not connected to this unit, or the setting to match operations carried out on TV is not set.	Connect the TV audio output to this unit, and then select the connected input source in “TVAudio” (Setup menu → HDMI Setup → TVAudio).	<a href="#">47</a>
	(When using Audio Return Channel function) The Audio Return Channel function is not working.	Make sure that your TV supports Audio Return Channel. Set the Audio Return Channel function to on (Setup menu → HDMI Setup → ARC).	<a href="#">47</a>

### Tuner (FM/AM)

#### FM

Problem	Cause	Remedy	See page
<b>FM stereo reception is noisy.</b>	You are too far from the station transmitter, or the input from the antenna is weak.	Check the antenna connections.	<a href="#">21</a>
		Switch to monaural mode.	<a href="#">31</a>
		Replace the outdoor antenna with a more sensitive multi-element antenna.	—
<b>There is distortion, and clear reception cannot be obtained even with a good FM antenna.</b>	There is multi-path interference.	Adjust the antenna height or orientation, or place it in a different location.	—
<b>The desired station cannot be tuned into with the automatic tuning method.</b>	You are in an area far from a station, or input from the antenna is weak.	Replace the outdoor antenna with a more sensitive multi element antenna.	—
		Use <b>[5] TUNING</b> $\wedge$ / $\vee$ (on the remote control) to manually select the station.	<a href="#">30</a>
<b>“No Presets” is displayed.</b>	No preset stations are registered.	Register stations you wish to listen to as preset stations before operation.	<a href="#">31</a>
<b>“Wrong Station” is displayed.</b>	An invalid FM/AM frequency has been input.	Input a frequency that can be received.	—



### AM

Problem	Cause	Remedy	See page
<b>The desired station cannot be tuned into with the automatic tuning method.</b>	The signal is weak, or the antenna connections are loose.	Adjust the AM loop antenna orientation.	<u>21</u>
		Use the manual tuning method.	<u>30</u>
<b>Automatic station preset does not work.</b>	Automatic station preset is not available for AM stations.	Use manual station preset.	<u>32</u>
<b>Continuous crackling and hissing noises are heard.</b>	The supplied AM loop antenna is not connected.	Connect the AM loop antenna correctly even if you use an outdoor antenna.	<u>21</u>
	The noises may be caused by lightning, fluorescent lamps, motors, thermostats, or other electrical equipment.	It is difficult to completely eliminate noise, but it can be reduced by installing and properly grounding an outdoor AM antenna.	<u>21</u>
<b>Buzzing and whining noises are heard.</b>	A TV set is being used nearby.	Move this unit away from the TV set.	—

### Remote control

Problem	Cause	Remedy	See page
<b>The remote control does not work or function properly.</b>	Wrong distance or angle.	The remote control will function within a maximum range of 20 ft / 6 m, and no more than 30 degrees off-axis from the front panel.	—
	Direct sunlight or lighting (from an inverter type of fluorescent lamp, strobe light, etc.) is striking the remote control sensor of this unit.	Adjust the lighting angle, or reposition this unit.	—
	The batteries are weak.	Replace all batteries.	<u>4</u>
	The remote control ID of the remote control and this unit do not match.	Match the remote control ID of this unit and the remote control.	<u>56</u>
<b>External components cannot be controlled using the remote control.</b>	The remote control code is not correctly set.	Set the remote control code correctly using “Remote control code search” on the CD-ROM.	—
		Try setting another code for the same manufacturer using “Remote control code search” on the CD-ROM.	—
		If this unit does not work when you press <b>Cursor</b> $\Delta / \nabla / \triangleleft / \triangleright$ (on the remote control), do the following. When the key does not work during DVD disc menu operation: press the <b>Input selector</b> (on the remote control) again.	—
		When the key does not work during Option menu/Setup menu operation: press the key corresponding to the current menu operation again.	—
		Even if the remote control code is correctly set, there are some models that do not respond to the remote control.	—





### iPod™/iPhone™

Display	Cause	Remedy	See page
Loading...	The unit is in the process of recognizing the connection with your iPod/iPhone.		—
	The unit is in the middle of acquiring song lists from your iPod/iPhone.		—
Connect error	There is a problem with the signal path from your iPod/iPhone to the unit.	Turn off the unit and reconnect the Yamaha iPod universal dock to the DOCK jack of the unit.	34
		Remove your iPod/iPhone from the Yamaha iPod universal dock and then place it back in the dock.	34
Unknown iPod	The iPod/iPhone being used is not supported by the unit.	Connect an iPod/iPhone supported by the unit.	—
iPod connected	Your iPod/iPhone is properly placed in the Yamaha iPod universal dock.		—
Disconnected	Your iPod/iPhone is removed from the Yamaha iPod universal dock.		—
Unable to play	The unit cannot play back the songs currently stored on your iPod/iPhone.	Check that songs are currently stored on your iPod/iPhone.	—

### Bluetooth™

Display	Cause	Remedy	See page
Searching...	The Yamaha Bluetooth wireless audio receiver and the Bluetooth component are in the process of pairing.		—
	The Yamaha Bluetooth wireless audio receiver and the Bluetooth component are in the process of establishing a connection.		—
Completed	The pairing is completed.		—
Canceled	The pairing is canceled.		—
BT connected	The connection between the Yamaha Bluetooth wireless audio receiver and the Bluetooth component is established.		—
Disconnected	The Bluetooth component is disconnected from the Yamaha Bluetooth wireless audio receiver.		—
Not found	The Bluetooth component is not found.	<p>During pairing:</p> <ul style="list-style-type: none"> <li>– pairing must be performed on the Bluetooth component and this unit simultaneously. Check if the Bluetooth component is in pairing mode.</li> </ul> <p>During connecting:</p> <ul style="list-style-type: none"> <li>– check if the Bluetooth component is turned on.</li> <li>– check if the Bluetooth component is within 32 feet (10 m) of the Yamaha Bluetooth wireless audio receiver.</li> </ul>	—



## Glossary

### Audio information

#### Audio and video synchronization (lip sync)

Lip sync, an abbreviation for lip synchronization, is a technical term that involves both a problem, and the capability of maintaining audio and video signals synchronized during post-production and transmission.

Whereas the audio and video latency requires complex end-user adjustment, HDMI version 1.3 incorporates an automatic audio and video syncing capability that allows devices to perform this synchronization automatically and accurately without user interaction.

#### Dolby Digital

Dolby Digital is a digital surround sound system that gives you completely independent multi-channel audio. With 3 front channels (front L/R and center), and 2 surround stereo channels, Dolby Digital provides 5 full-range audio channels. With an additional channel especially for bass effects, referred to as LFE (Low-Frequency Effect), the system has a total of 5.1-channels (LFE is counted as 0.1 channel). By using 2-channel stereo for the surround speakers, more accurate moving sound effects and surround sound environments are possible than with Dolby Surround. The wide dynamic range from maximum to minimum volumes that are reproduced by the 5 full-range channels, and the precise sound orientation generated using digital sound processing provides listeners with unprecedented excitement and realism. With this unit, any sound environment from monaural up to a 5.1-channel configuration can be freely selected for your enjoyment.

#### Dolby Pro Logic II

Dolby Pro Logic II is an improved technique used to decode vast numbers of existing Dolby Surround sources. This new technology enables a discrete 5-channel playback with 2 front left and right channels, 1 center channel, and 2 surround left and right channels, instead of only 1 surround channel for conventional Pro Logic technology. There are three modes available: “Music mode” for music sources, “Movie mode” for movie sources, and “Game mode” for game sources.

#### Dolby Surround

Dolby Surround uses a 4-channel analog recording system to reproduce realistic and dynamic sound effects: 2 front left and right channels (stereo), a center channel for dialog (monaural), and a surround channel for special sound effects (monaural). The surround channel reproduces sound within a narrow frequency range. Dolby Surround is widely used with nearly all video tapes and laser discs, as well as in many TV and cable broadcasts. The Dolby Pro Logic decoder built into this unit employs a digital signal processing system that automatically stabilizes the volume on each channel to enhance moving sound effects and directionality.

#### Dolby TrueHD

Dolby TrueHD is an advanced lossless audio technology developed for high-definition disc-based media including Blu-ray Disc. Selected as an optional audio standard for Blu-ray Disc, this technology delivers sound that is bit-for-bit identical to the studio master, offering a high-definition home theater experience. Supporting bitrates up to 18.0 Mbps, Dolby TrueHD can carry up to 8 discrete channels of 24-bit/96 kHz audio simultaneously. Dolby TrueHD also remains fully compatible with the existing multichannel audio systems and retains the metadata capability of Dolby Digital, allowing dialog normalization and dynamic range control.

#### DTS 96/24

DTS 96/24 offers an unprecedented level of audio quality for multichannel sound on DVD video, and is fully backward-compatible with all DTS decoders. “96” refers to a 96 kHz sampling rate compared to the typical 48 kHz sampling rate. “24” refers to 24-bit word length. DTS 96/24 offers sound quality transparent to the original 96/24 master, and 96/24 5.1-channel sound with full-quality full-motion video for music programs and motion picture soundtracks on DVD video.

#### DTS Digital Surround

DTS Digital Surround was developed to replace the analog soundtracks of movies with a 5.1-channel digital sound track, and is now rapidly gaining popularity in movie theaters around the world. DTS, Inc. has developed a home theater system so that you can enjoy the depth of sound and natural spatial representation of DTS Digital Surround in your home. This system produces practically distortion-free 5.1-channel sound (technically, left, right and center channels, 2 surround channels, plus an LFE 0.1 channel as a subwoofer, for a total of 5.1-channels).

#### DTS Express

This is an audio format for next-generation optical discs such as Blu-ray discs. It uses optimized low bit rate signals for network streaming. In the case of a Blu-ray disc, this format is used with secondary audio, enabling you to enjoy the commentary of the movie producer via the Internet while playing the main program.

#### DTS-HD High Resolution Audio

DTS-HD High Resolution Audio is a high resolution audio technology developed for high-definition disc-based media including Blu-ray Disc. Selected as an optional audio standard for Blu-ray Disc, this technology delivers sound that is virtually indistinguishable from the original, offering a high-definition home theater experience.

Supporting bitrates up to 6.0 Mbps for Blu-ray Disc, DTS-HD High Resolution Audio can carry up to 7.1 discrete channels of 24-bit/96 kHz audio simultaneously.

DTS-HD High Resolution Audio also remains fully compatible with the existing multichannel audio systems that incorporate DTS Digital Surround.

#### DTS-HD Master Audio

DTS-HD Master Audio is an advanced lossless audio technology developed for high-definition disc-based media including Blu-ray Disc. Selected as an optional audio standard for Blu-ray Disc, this technology delivers sound that is bit-for-bit identical to the studio master, offering a high-definition home theater experience.

Supporting bitrates up to 24.5 Mbps for Blu-ray Disc, DTS-HD Master Audio can carry up to 7.1 discrete channels of 24-bit/96 kHz audio simultaneously. Supported by HDMI version 1.3 and designed for the optical disc players and AV receivers/amplifiers of the future, DTS-HD Master Audio also remains fully compatible with the existing multichannel audio systems that incorporate DTS Digital Surround.

#### DSD

Direct Stream Digital (DSD) technology stores audio signals on digital storage media, such as Super Audio CDs. Using DSD, signals are stored as single bit values at a high-frequency sampling rate of 2.8224 MHz, while noise shaping and oversampling are used to reduce distortion, a common occurrence with very high quantization of audio signals. Due to the high sampling rate, better audio quality can be achieved than that offered by the PCM format used for normal audio CDs. The frequency is equal to or higher than 100 kHz, with a dynamic range of 120 dB. This unit can transmit or receive DSD signals via the HDMI jack.



**LFE 0.1 channel**

This channel reproduces low-frequency bass signals, and has a frequency range from 20 Hz to 120 Hz. This channel is counted as 0.1, because it only enforces a low-frequency range compared to the full-range reproduced by the other 5 channels in Dolby Digital or DTS 5.1-channel systems.

**Neo:6**

Neo:6 decodes the conventional 2-channel sources for 6-channel playback by the specific decoder. It enables playback with the full-range channels with higher separation just like digital discrete signal playback. There are two modes available: "Music mode" for music sources and "Cinema mode" for movie sources.

**PCM (Linear PCM)**

Linear PCM is a signal format under which an analog audio signal is digitized, recorded and transmitted without using any compression. This is used as a method of recording CDs and DVD audio. The PCM system uses a technique for sampling the size of the analog signal per very small unit of time. Standing for "Pulse Code Modulation," the analog signal is encoded as pulses and then modulated for recording.

**Sampling frequency and number of quantized bits**

When digitizing an analog audio signal, the number of times the signal is sampled per second is called the sampling frequency, while the degree of accuracy when converting the sound level into a numeric value is called the number of quantized bits. The range of rates that can be played back is determined based on the sampling rate, whereas the dynamic range representing the sound level difference is determined by the number of quantized bits. In principle, the higher the sampling frequency, the wider the range of frequencies that can be played back, and the higher the number of quantized bits, the more accurately the sound level can be reproduced.

**Sound field program information****CINEMA DSP**

Since the Dolby Surround and DTS systems were originally designed for use in movie theaters, their effect is best felt in a theater having many speakers designed for acoustic effects. Since home conditions, such as room size, wall material, number of speakers, and so on, can differ so widely, it is inevitable that there are differences in the sound that is heard. Based on a wealth of actually measured data, Yamaha CINEMA DSP uses Yamaha's original DSP technology to combine Dolby Pro Logic, Dolby Digital, and DTS systems to provide the audiovisual experience of a movie theater in the listening room of your own home.

**Compressed music enhancer**

The Compressed music enhancer feature of this unit enhances your listening experience by regenerating the missing harmonics in compression artifacts. As a result, it compensates for flattened complexity due to the loss of high-frequency fidelity as well as lack of bass due to the loss of low-frequency bass, providing improved performance for the overall sound system.

**SILENT CINEMA**

Yamaha has developed a natural, realistic sound effect DSP algorithm for headphones. Parameters for headphones have been set for each sound field program, so that accurate representations of all the sound field programs can be enjoyed on headphones.

**Virtual CINEMA DSP**

Yamaha has developed a Virtual CINEMA DSP algorithm that allows you to enjoy DSP surround effects even without any surround speakers, by using virtual surround speakers. It is even possible to enjoy Virtual CINEMA DSP using a minimal two-speaker system that does not include a center speaker.

**Video information****Component video signal**

With the component video signal system, the video signal is separated into the Y signal for luminance and the PB and PR signals for chrominance. Color can be reproduced more faithfully with this system because each of these signals is independent. The component signal is also called the "color difference signal" because the luminance signal is subtracted from the color signal. A monitor with component input jacks is required in order to output component signals.

**Composite video signal**

With the composite video signal system, the video signal comprises the three basic elements of a video picture: color, brightness and synchronization data. A composite video jack on a video component transmits these three elements combined.

**Deep Color**

Deep Color refers to the use of various color depths in displays, up from the 24-bit depths in previous versions of the HDMI specification. This extra bit depth allows HDTVs and other displays increase from millions of colors to billions of colors and eliminate on-screen color banding for smooth tonal transitions and subtle gradations between colors. The increased contrast ratio can represent many times more shades of gray between black and white. Additionally, Deep Color increases the number of available colors within the boundaries defined by the RGB or YCbCr color space.

**HDMI**

HDMI (High-Definition Multimedia Interface) is the first industry supported, uncompressed, all-digital audio/video interface. Providing an interface between any sources (such as set-top boxes or AV receivers) and audio/video monitors (such as digital TV), HDMI supports standard, enhanced or high-definition video as well as multichannel digital audio using a single cable. HDMI transmits all ATSC HDTV standards and supports 8-channel digital audio, with bandwidth to spare to accommodate future enhancements and requirements.

When used in combination with HDCP (High-bandwidth Digital Content Protection), HDMI provides a secure audio/video interface that meets the security requirements of content providers and system operators. For further information on HDMI, visit the HDMI website at "[http://www.hdmi.org/!](http://www.hdmi.org/)"

**"x.v.Color"**

A color space standard supported by HDMI version 1.3. It is a more extensive color space than sRGB, and allows the expression of colors that were not hitherto possible. While remaining compatible with the color gamut of sRGB standards, "x.v.Color" expands the color space, and can thus produce more vivid, natural images. It is particularly effective for still pictures and computer graphics.



## Information on HDMI™

### ■ HDMI signal compatibility

#### Audio signals

Audio signal types	Audio signal formats	Compatible media
2ch Linear PCM	2ch, 32-192 kHz, 16/20/24 bit	CD, DVD-Video, DVD-Audio, etc.
Multi-ch Linear PCM	8ch, 32-192 kHz, 16/20/24 bit	DVD-Audio, Blu-ray Disc, HD DVD, etc.
DSD	2/5.1ch, 2.8224 MHz, 1 bit	SACD, etc.
Bitstream	Dolby Digital, DTS	DVD-Video, etc.
Bitstream (High definition audio)	Dolby TrueHD, Dolby Digital Plus, DTS-HD Master Audio, DTS-HD High Resolution Audio, DTS Express	Blu-ray Disc, HD DVD, etc.

- If the input source component can decode the bitstream audio signals of audio commentaries, you can play back the audio sources with the audio commentaries mixed down by using the digital audio input (optical or coaxial) connections.
- Refer to the supplied instruction manuals of the input source component, and set the component appropriately.

#### NOTES

- When CPPM copy-protected DVD-Audio is played back, video and audio signals may not be output, depending on the type of the DVD player.
- This unit is not compatible with HDCP-incompatible HDMI or DVI components.
- Refer to the supplied instruction manuals for details.  
To decode audio bitstream signals on this unit, set the input source component appropriately so that the component outputs the bitstream audio signals directly (does not decode the bitstream signals on the component).
- This unit is not compatible with the audio commentary features (for example, the special audio contents downloaded via Internet) of Blu-ray Disc or HD DVD. This unit does not play back the audio commentaries of the Blu-ray Disc or HD DVD content.

#### Video signals

This unit is compatible with the video signals of the following resolutions:

- 480i/60 Hz
- 576i/50 Hz
- 480p/60 Hz
- 576p/50 Hz
- 720p/60 Hz, 50 Hz
- 1080i/60 Hz, 50 Hz
- 1080p/60 Hz, 50 Hz, 24 Hz

## About trademarks



Manufactured under license from Dolby Laboratories. Dolby, Pro Logic and the double-D symbol are trademarks of Dolby Laboratories.



Manufactured under license under U.S. Patent #'s: 5,451,942; 5,956,674; 5,974,380; 5,978,762; 6,226,616; 6,487,535; 7,212,872; 7,333,929; 7,392,195; 7,272,567 & other U.S. and worldwide patents issued & pending. DTS, DTS-HD and the Symbol are registered trademarks, & DTS-HD Master Audio, and the DTS logos are trademarks of DTS, Inc. Product includes software. © DTS, Inc. All Rights Reserved.

#### iPod™, iPhone™

“iPod” is a trademark of Apple Inc., registered in the U.S. and other countries. “iPhone” is a trademark of Apple Inc.

#### Bluetooth™

Bluetooth is a registered trademark of the Bluetooth SIG and is used by Yamaha in accordance with a license agreement.



“HDMI,” the “HDMI” logo and “High-Definition Multimedia Interface” are trademarks, or registered trademarks of HDMI Licensing LLC.



“SILENT CINEMA” is a trademark of Yamaha Corporation.



## Specifications

### ■ INPUT/OUTPUT

#### Input jacks

- HDMI input x 4
- AV input x 5
  - [Audio] Digital input (optical) x 2, digital input (coaxial) x 2, analog input x 1
  - [Video] Component video jacks x 2, video jacks x 3
- AUDIO input x 2
  - [Audio] Analog jack x 2
- VIDEO AUX input x 1
  - [Audio] Analog x 1, stereo mini jack x 1
  - [Video] Video jack x 1

#### DOCK input x 1

#### Output jacks

- TV output (monitor output) x 3
  - [Audio/Video] HDMI x 1
  - [Video] Component video jack x 1, video jack x 1
- AV output x 2
  - [Audio] Analog jack x 1
  - [Video] Video jack x 1
- AUDIO output x 1
  - [Audio] Analog jack x 1

### ■ HDMI

- HDMI Specification: Deep Color, "x.v.Color," Auto Lips Sync, ARC (Audio Return Channel)
- Video Format (Repeater Mode)
  - VGA
  - 480i/60 Hz
  - 576i/50 Hz
  - 480p/60 Hz
  - 576p/50 Hz
  - 720p/60 Hz, 50 Hz
  - 1080i/60 Hz, 50 Hz
  - 1080p/60 Hz, 50 Hz, 24 Hz

- Audio Format
  - Dolby Digital
  - DTS
  - DSD 6ch
  - Dolby Digital Plus
  - Dolby TrueHD
  - DTS-HD
  - PCM 2ch-8ch (Max 192 kHz/24 bit)
- Content Protection: HDCP compatible

### ■ Compatible Decoding Formats

- Decoding Format
  - Dolby TrueHD, Dolby Digital Plus
  - DTS-HD Master Audio, DTS-HD High Resolution, DTS Express
  - Dolby Digital
  - DTS, DTS 96/24
- Post Decoding Format
  - Dolby Pro Logic
  - Dolby Pro Logic II Music, Dolby Pro Logic II Movie, Dolby Pro Logic II Game
  - DTS Neo:6 Music, DTS Neo:6 Cinema

### ■ AUDIO SECTION

- Minimum RMS Output Power for Front, Center, Surround
  - [U.S.A. and Canada models]
  - (1 kHz, 0.9% THD, 8 Ω)
  - FRONT L/R.....100 W/ch
  - CENTER .....100 W
  - SURROUND L/R.....100 W/ch
  - [Other models]
  - (1 kHz, 0.9% THD, 6 Ω)
  - FRONT L/R.....100 W/ch
  - CENTER .....100 W
  - SURROUND L/R.....100 W/ch
- Dynamic Power (IHF)
  - [U.S.A. and Canada models]
  - Front Speakers 8/6/4/2 Ω ..... 110/130/160/180 W
  - [Other models]
  - Front Speakers 6/4/2 Ω ..... 105/130/150 W

- Maximum Useful Output Power (JEITA)
  - [China, Korea, General and Asia models]
  - 1 kHz, 10% THD, 6 Ω.....135 W
- Maximum Output Power [U.K., Europe and Asia models]
  - 1 kHz, 0.7% THD, 4 Ω.....120 W
- IEC Output Power [U.K., Europe and Asia models]
  - Front Speakers 1 kHz, 0.9% THD, 8 Ω.....95 W+95 W
- Dynamic Headroom [U.S.A. and Canada models]
  - 8 Ω .....0.23 dB
- Input Sensitivity/Input Impedance
  - AV5, etc .....200 mV/47 kΩ
- Maximum Input Voltage
  - AV5, etc. (1 kHz, 0.5% THD).....2.3 V or more
- Rated Output Voltage/Output Impedance
  - AUDIO OUT .....200 mV/1.2 kΩ
  - SUBWOOFER (2ch Stereo & Front: Small).....1.0 V/1.2 kΩ
- Headphone Jack Rated Output/Impedance
  - AV5, etc. (1 kHz, 50 mV, 8 Ω).....100 mV/470 Ω
- Frequency Response
  - AV5 to FRONT .....10 Hz to 100 kHz, +0/-3 dB
- Total Harmonic Distortion
  - AV5, etc. to FRONT
  - [U.S.A. and Canada models] (1 kHz, 50 W, 8 Ω).....0.06% or less
  - [Other models] (1 kHz, 50 W, 6 Ω).....0.06% or less
- Signal to Noise Ratio (IHF-A Network)
  - AV5, etc. Input Shorted (250 mV to Front Speakers)
  - .....98 dB or more
- Residual Noise (IHF-A Network)
  - Front Speakers .....150 μV or less
- Channel Separation (1 kHz/10 kHz)
  - AV5, etc. (5.1 kΩ shortened) .....60 dB/45 dB or more
- Volume Control .....MUTE / -80 dB to +16.5 dB
- Tone Control (Front Speakers)
  - BASS Boost/Cut .....±10 dB/2 dB at 50 Hz
  - BASS Turnover Frequency .....350 Hz
  - TREBLE Boost/Cut .....±10 dB/2 dB at 20 kHz
  - TREBLE Turnover Frequency.....3.5 kHz
- Filter Characteristics (fc=40/60/80/90/100/110/120/160/200 Hz)
  - H.P.F. (Front, Center, Surround).....12 dB/oct.
  - L.P.F. (Subwoofer).....24 dB/oct.

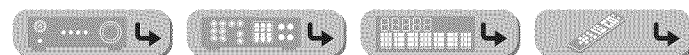

## ■ VIDEO SECTION

- Video Signal Type  
[U.S.A., Canada, Korea and General models].....NTSC  
[Other models].....PAL
- Signal Level  
Composite.....1 Vp-p/75 Ω  
Component ..... 1 Vp-p/75 Ω (Y), 0.7 Vp-p/75 Ω (PB/PR)
- Maximum Input Level (Video Conversion Off)..... 1.5 Vp-p or more
- Signal to Noise Ratio .....50 dB or more
- Frequency Response [MONITOR OUT]  
Component (Video Conversion Off)..... 5 Hz to 60 MHz, ±3 dB

## ■ FM SECTION

- Tuning Range  
[U.S.A. and Canada models] .....87.5 to 107.9 MHz  
[Asia and General models] ..... 87.5/87.50 to 108.0/108.00 MHz  
[Other models].....87.50 to 108.00 MHz
- 50 dB Quieting Sensitivity (IHF)  
Mono..... 3.0 μV (20.8 dBf)

- Signal to Noise Ratio (IHF)  
Mono/Stereo..... 74 dB/69 dB
- Harmonic Distortion (1 kHz)  
Mono/Stereo..... 0.3/0.3%
- Antenna Input (unbalanced)..... 75 Ω

## ■ AM SECTION

- Tuning Range  
[U.S.A. and Canada models].....530 to 1710 kHz  
[Asia and General models]..... 530/531 to 1710/1611 kHz  
[Other models] .....531 to 1611 kHz

## ■ GENERAL

- Power Supply  
[U.S.A. and Canada models]..... AC 120 V, 60 Hz  
[General models]..... AC 110-120/220-240 V, 50/60 Hz  
[China model]..... AC 220 V, 50 Hz  
[Korea model] ..... AC 220 V, 60 Hz  
[Australia model] ..... AC 240 V, 50 Hz  
[U.K. and Europe models] ..... AC 230 V, 50 Hz  
[Asia models] ..... AC 220-240 V, 50/60 Hz

- Power Consumption  
[U.S.A. and Canada models] .....250 W/320 VA  
[Other models] ..... 250 W
- Standby Power Consumption  
[General models] ..... 1.0 W or less  
[Other models] .....0.5 W or less
- Dimensions (W x H x D)  
435 x 151 x 315 mm (17-1/8 x 6 x 12-3/8 in)
- Weight  
7.5 kg (16.5 lbs)

\* Specifications are subject to change without notice.

## Index

### A

- Advanced Setup menu ..... 55
- AM tuning ..... 30
- Antenna connection ..... 21
- Audio Return Channel function ..... 59

### B

- Bluetooth™ component playback..... 36

### C

- Cable plug ..... 13
- Connections..... 9

### E

- External device connection ..... 13

### F

- FM tuning ..... 30
- Front panel ..... 5
- Front panel display ..... 7

### H

- HDMI Control function..... 57

### I

- iPod™/iPhone™ playback ..... 34

### J

- Jack..... 13

### O

- Option menu ..... 38

### R

- Rear panel..... 6
- Remote control, Controlling other components ..... 52
- Remote control, Part names and functions ..... 8

### S

- SCENE function ..... 26
- Setup menu ..... 41
- Sound field program ..... 26
- Sound field program parameter setting ..... 50
- Speaker connection..... 9
- Speaker setting ..... 22
- Supplied accessories ..... 4







U

## Additional information on specification for U.S.A. model

The following specification is added for U.S.A. model as well as “Specifications” in the Owner’s Manual.

- **Rated Output Power for Front, Center, Surround**

(1 kHz, 0.9% THD, 8Ω, 2 channels driven simultaneously)

FRONT L/R .....	80 W + 80 W
CENTER.....	80 W
SURROUND L/R .....	80 W + 80 W





# AV Receiver

---

For more detailed information, refer to the Owner's Manual on the CD-ROM. To view the Owner's Manual, click "English" in the screen displayed automatically when you insert the CD-ROM into your PC. Then follow the on-screen instructions. If the screen is not displayed automatically, open the "index.html" in the CD-ROM.

Caution: Do not attempt to play this CD-ROM on an audio CD player.

The Owner's Manual contained in the CD-ROM can be downloaded from the following URL:

<http://download.yamaha.com/>

Consulte informaciones más detalladas en el "Manual del usuario" del CD-ROM. Para visualizar el "Manual del usuario", haga clic en "Español" en la pantalla que aparece automáticamente después de introducir el CD-ROM en su PC. Siga entonces las instrucciones en pantalla. Si la pantalla no aparece automáticamente, abra el archivo "index.html" del CD-ROM.

Atención: No intente reproducir este CD-ROM en un reproductor de CDs de audio.

El Manual del Propietario que aparece en el CD-ROM se puede descargar en la siguiente dirección URL:

<http://download.yamaha.com/>

## (Power key)

Turns on the power of this unit or sets it to the standby mode.

## (Tecla de encendido)

Enciende esta unidad o la pone en modo de espera.

# CAUTION: READ THIS BEFORE OPERATING YOUR UNIT.

- 1 To assure the finest performance, please read this manual carefully. Keep it in a safe place for future reference.
- 2 Install this sound system in a well ventilated, cool, dry, clean place - away from direct sunlight, heat sources, vibration, dust, moisture, and/or cold. For proper ventilation, allow the following minimum clearances.  
Top: 30 cm, Rear: 10 cm, Sides: 10 cm
- 3 Locate this unit away from other electrical appliances, motors, or transformers to avoid humming sounds.
- 4 Do not expose this unit to sudden temperature changes from cold to hot, and do not locate this unit in an environment with high humidity (i.e. a room with a humidifier) to prevent condensation inside this unit, which may cause an electrical shock, fire, damage to this unit, and/or personal injury.
- 5 Avoid installing this unit where foreign object may fall onto this unit and/or this unit may be exposed to liquid dripping or splashing. On the top of this unit, do not place:
  - Other components, as they may cause damage and/or discoloration on the surface of this unit.
  - Burning objects (i.e. candles), as they may cause fire, damage to this unit, and/or personal injury.
  - Containers with liquid in them, as they may fall and liquid may cause electrical shock to the user and/or damage to this unit.
- 6 Do not cover this unit with a newspaper, tablecloth, curtain, etc. in order not to obstruct heat radiation. If the temperature inside this unit rises, it may cause fire, damage to this unit, and/or personal injury.
- 7 Do not plug in this unit to a wall outlet until all connections are complete.
- 8 Do not operate this unit upside-down. It may overheat, possibly causing damage.
- 9 Do not use force on switches, knobs and/or cords.
- 10 When disconnecting the power cable from the wall outlet, grasp the plug; do not pull the cable.
- 11 Do not clean this unit with chemical solvents; this might damage the finish. Use a clean, dry cloth.
- 12 Only voltage specified on this unit must be used. Using this unit with a higher voltage than specified is dangerous and may cause fire, damage to this unit, and/or personal injury. Yamaha will not be held responsible for any damage resulting from use of this unit with a voltage other than specified.
- 13 To prevent damage by lightning, keep the power cable and outdoor antennas disconnected from a wall outlet or this unit during a lightning storm.
- 14 Do not attempt to modify or fix this unit. Contact qualified Yamaha service personnel when any service is needed. The cabinet should never be opened for any reasons.
- 15 When not planning to use this unit for long periods of time (i.e. vacation), disconnect the AC power plug from the wall outlet.
- 16 Be sure to refer to the "Troubleshooting" section of the Owner's Manual on the CD-ROM for common operating errors before concluding that this unit is faulty.
- 17 Before moving this unit, press  $\Phi$  to set it to standby mode and disconnect the AC power plug from the wall outlet.
- 18 **VOLTAGE SELECTOR (Asia and General models only)**  
The VOLTAGE SELECTOR on the rear panel of this unit must be set for your local main voltage BEFORE plugging into the AC wall outlet. Voltages are:  
.....AC 110-120/220-240 V, 50/60 Hz (General model)  
..... AC 220-240 V, 50/60 Hz (Asia model)
- 19 Condensation will form when the surrounding temperature changes suddenly. Disconnect the power cable from the outlet, then leave this unit alone.
- 20 When using this unit for a long time, this unit may become warm. Turn the power off, then leave this unit alone for cooling.
- 21 Install this unit near the AC outlet and where the AC power plug can be reached easily.
- 22 The batteries shall not be exposed to excessive heat such as sunshine, fire or the like. When you dispose of batteries, follow your regional regulations.
- 23 Excessive sound pressure from earphones and headphones can cause hearing loss.
- 24 When replacing the batteries, be sure to use batteries of the same type. Danger of explosion may happen if batteries are incorrectly replaced.

This unit is not disconnected from the AC power source as long as it is connected to the wall outlet, even if this unit itself is turned off by  $\Phi$ . This state is called the standby mode. In this state, this unit is designed to consume a very small quantity of power.

## WARNING

TO REDUCE THE RISK OF FIRE OR ELECTRIC SHOCK,  
DO NOT EXPOSE THIS UNIT TO RAIN OR MOISTURE.

## ■ Notes on remote controls and batteries

- Do not spill water or other liquids on the remote control.
- Do not drop the remote control.
- Do not leave or store the remote control in the following conditions:
  - places of high humidity, such as near a bath
  - places of high temperatures, such as near a heater or stove
  - places of extremely low temperatures
  - dusty places
- Insert the battery according to the polarity markings (+ and -).
- Change all batteries if you notice the following conditions:
  - the operation range of the remote control narrows
  - the transmit indicator does not flash or is dim
- If the batteries run out, immediately remove them from the remote control to prevent an explosion or acid leak.
- If you find leaking batteries, discard the batteries immediately, taking care not to touch the leaked material. If the leaked material comes into contact with your skin or gets into your eyes or mouth, rinse it away immediately and consult a doctor. Clean the battery compartment thoroughly before installing new batteries.
- Do not use old batteries together with new ones. This may shorten the life of the new batteries or cause old batteries to leak.
- Do not use different types of batteries (such as alkaline and manganese batteries) together. Specification of batteries may be different even though they look the same.
- Before inserting new batteries, wipe the compartment clean.
- If the remote control is without batteries for more than 2 minutes, or if exhausted batteries remain in the remote control, the contents of the memory may be cleared. In such a case, install new batteries and set the remote control code.
- Dispose of batteries according to your regional regulations.

# PRECAUCIÓN: LEA LAS INDICACIONES SIGUIENTES ANTES DE UTILIZAR ESTE APARATO.

- 1 Para asegurar el mejor rendimiento de este aparato, lea atentamente este manual. Y luego guárdelo en un lugar seguro para poder consultarlo en el futuro en caso de ser necesario.
- 2 Instale este sistema de sonido en un lugar bien ventilado, fresco, seco y limpio, y alejado de la luz solar directa, fuentes de calor, vibración, polvo, humedad y/o frío. Para garantizar una ventilación correcta deberán existir las siguientes distancias mínimas.  
Arriba: 30 cm, Atrás: 10 cm, A los lados: 10 cm
- 3 Coloque este aparato lejos de otros aparatos eléctricos, motores o transformadores, para evitar así los ruidos de zumbido.
- 4 No exponga este aparato a cambios bruscos de temperaturas, del frío al calor, ni lo coloque en lugares muy húmedos (una habitación con deshumidificador, por ejemplo), para impedir así que se forme condensación en su interior, lo que podría causar una descarga eléctrica, un incendio, daños en el aparato y/o lesiones a las personas.
- 5 Evite instalar este aparato en un lugar donde puedan caerle encima objetos extraños y/o donde quede expuesto al goteo o a la salpicadura de líquidos. Encima de este aparato no ponga:
  - Otros componentes, porque pueden causar daños y/o decoloración en la superficie de este aparato.
  - Objetos con fuego (velas, por ejemplo), porque pueden causar un incendio, daños en el aparato y/o lesiones a las personas.
  - Recipientes con líquidos, porque pueden caerse y derramar el líquido, causando descargas eléctricas al usuario y/o dañando el aparato.
- 6 No tape este aparato con un periódico, mantel, cortina, etc. para no impedir el escape del calor. Si aumenta la temperatura en el interior del aparato, esto puede causar un incendio, daños en el aparato y/o lesiones a las personas.
- 7 No enchufe este aparato a una toma de corriente hasta después de haber terminado todas las conexiones.
- 8 No ponga el aparato al revés. Podría recalentarse y posiblemente causar daños.
- 9 No utilice una fuerza excesiva con los conmutadores, los controles y/o los cables.
- 10 Cuando desconecte el cable de alimentación de la toma de corriente, sujete la clavija y tire de ella; no tire del propio cable.
- 11 No limpie este aparato con disolventes químicos porque podría estropear el acabado. Utilice un paño limpio y seco para limpiar el aparato.
- 12 Utilice solamente la tensión especificada en este aparato. Utilizar el aparato con una tensión superior a la especificada resulta peligroso y puede producir un incendio, daños en el aparato y/o lesiones a las personas. Yamaha no se hará responsable de ningún daño debido al uso de este aparato con una tensión diferente de la especificada.
- 13 Para impedir daños debidos a relámpagos, desconecte el cable de alimentación y antenas externas de la toma de corriente durante una tormenta eléctrica.
- 14 No intente modificar ni arreglar este aparato. Póngase en contacto con el personal de servicio Yamaha cualificado cuando necesite realizar alguna reparación. La caja no deberá abrirse nunca por ninguna razón.
- 15 Cuando no piense utilizar este aparato durante mucho tiempo (cuando se ausente de casa por vacaciones, por ejemplo) desconecte el cable de alimentación de la toma de corriente.
- 16 Lea la sección "Resolución de problemas" sobre errores de funcionamiento habituales en el Manual de instrucciones del CD-ROM antes de dar por concluido que este aparato está averiado.
- 17 Antes de trasladar este aparato, pulse  $\phi$  para ponerlo en el modo de espera, y luego desconecte el cable de alimentación de CA de la toma de corriente.
- 18 VOLTAGE SELECTOR (Únicamente modelos Asia y General)  
El selector VOLTAGE SELECTOR del panel posterior de este aparato se deberá poner en la posición correspondiente a la tensión empleada en su localidad ANTES de conectar el aparato a la red de corriente. Tensiones:  
..... CA 110-120/220-240 V, 50/60 Hz (Modelo general)  
..... CA 220-240 V, 50/60 Hz (Modelo para Asia)
- 19 La condensación se formará cuando cambie de repente la temperatura ambiental. Desconecte en este caso el cable de alimentación de la toma de corriente y no utilice el aparato.
- 20 El aparato se calentará cuando la utilice durante mucho tiempo. Desconecte en este caso la alimentación y luego no utilice el aparato para permitir que se enfríe.
- 21 Instale este aparato cerca de la toma de CA y donde se pueda alcanzar fácilmente la clavija de alimentación.
- 22 Las baterías no deberán exponerse a un calor excesivo como, por ejemplo, el que producen los rayos del sol, el fuego y similares. Cuando deseche las baterías, por favor cumpla las regulaciones de su región.
- 23 La presión acústica excesiva de los auriculares puede causar pérdida auditiva.
- 24 Utilice pilas del mismo tipo cuando las sustituya. Se podría provocar explosiones si se emplean pilas erróneas.

Este aparato no se desconecta de la fuente de alimentación de CA si está conectada a una toma de corriente, aunque la propia aparato esté apagada con  $\phi$ . A este estado se le llama modo de espera. En este estado, este aparato ha sido diseñada para que consuma un cantidad de corriente muy pequeña.

## ADVERTENCIA

PARA REDUCIR EL RIESGO DE INCENDIO O DESCARGA ELÉCTRICA, NO EXPONGA ESTE APARATO A LA LLUVIA NI A LA HUMEDAD.

## ■ Observaciones sobre los mandos a distancia y las pilas

- No derrame agua u otros líquidos en el mando a distancia.
- No deje que el mando a distancia se caiga.
- No deje ni guarde el mando a distancia en uno de las siguientes lugares:
  - lugares con alta humedad, por ejemplo, cerca de un baño
  - lugares con temperaturas elevadas, por ejemplo, cerca de una calefacción o estufa
  - lugares con temperaturas muy bajas
  - lugares polvorientos
- Inserte la batería respetando las marcas de polaridad (+ y -).
- Cambie todas las pilas si observa alguna de las siguientes condiciones:
  - el radio de acción del mando a distancia se reduce
  - el indicador de transmisión no parpadea o está atenuado.
- Para impedir explosiones o pérdidas de ácido, retire inmediatamente las pilas del mando a distancia cuando se hayan gastado.
- Si encuentra pilas con fugas, deséchelas inmediatamente, procurando no tocar el material que sale de las pilas. Si el material que sale de las pilas entra en contacto con su piel o entra en sus ojos o boca, lávese inmediatamente y acuda a un médico. Limpie a fondo el compartimiento de las pilas antes de instalar otras nuevas.
- No utilice conjuntamente pilas viejas y pilas nuevas. Esto puede acortar la vida de las pilas nuevas o hacer que las pilas viejas tengan fugas.
- No utilice conjuntamente pilas de diferentes tipos (por ejemplo, alcalinas y de manganeso). La especificación de las pilas puede ser diferente aunque parezca la misma.
- Limpie el compartimiento de las pilas antes de introducir las nuevas.
- Si el mando a distancia se queda sin pilas durante más de 2 minutos, o si las pilas agotadas se quedan en su interior, se podría borrar el contenido de la memoria. En ese caso, instale pilas nuevas y establezca el código del mando a distancia.
- Siga la reglamentación local para deshacerse de las pilas.



© 2011 Yamaha Corporation

YAMAHA CORPORATION  
Printed in China © WW72190

# HTR-3064

## Quick Reference Guide

### Accessories

The following accessories are supplied with this product.



Remote control

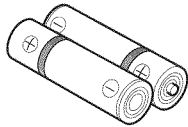

Batteries (2) (AAA, R03, UM-4)

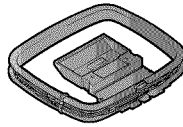

AM loop antenna

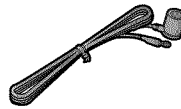

Indoor FM antenna

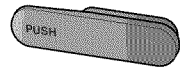

VIDEO AUX input cover

### Preparing the remote control

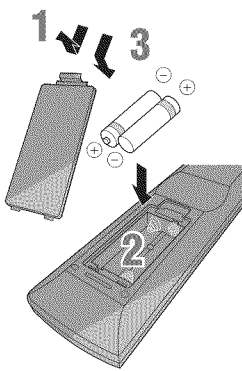
**1**

Take off the battery compartment cover.

**2**

Insert the two supplied AAA batteries into the battery case, following the polarity markings.

**3**

Snap the battery compartment cover back into place.

### Items necessary for connection

#### Speakers

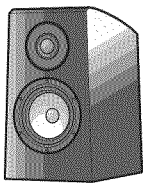

Ex.

Front speaker

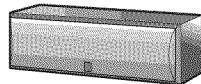

Ex.

Center speaker

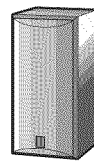

Ex.

Surround speaker

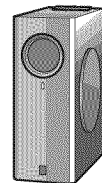

Ex.

Active subwoofer

- Use speakers with an impedance of at least 6Ω.
- If you are using a CRT TV, we recommend that you use magnetically shielded speakers.
- Prepare at least two speakers (for front). The priority of the other speakers is as follows:
  - 1 Two surround speakers
  - 2 One center speaker

#### External components

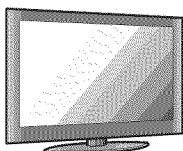

TV



 Playback device such as BD  
(Blu-ray Disc)/DVD players

#### Cable

- Cables for connecting external components (may differ depending on the devices you are connecting)
- Speaker cables (a quantity to match the number of speakers you are connecting)
- Audio pin cable (for subwoofer)

Connect and install as follows the first time you use this unit.

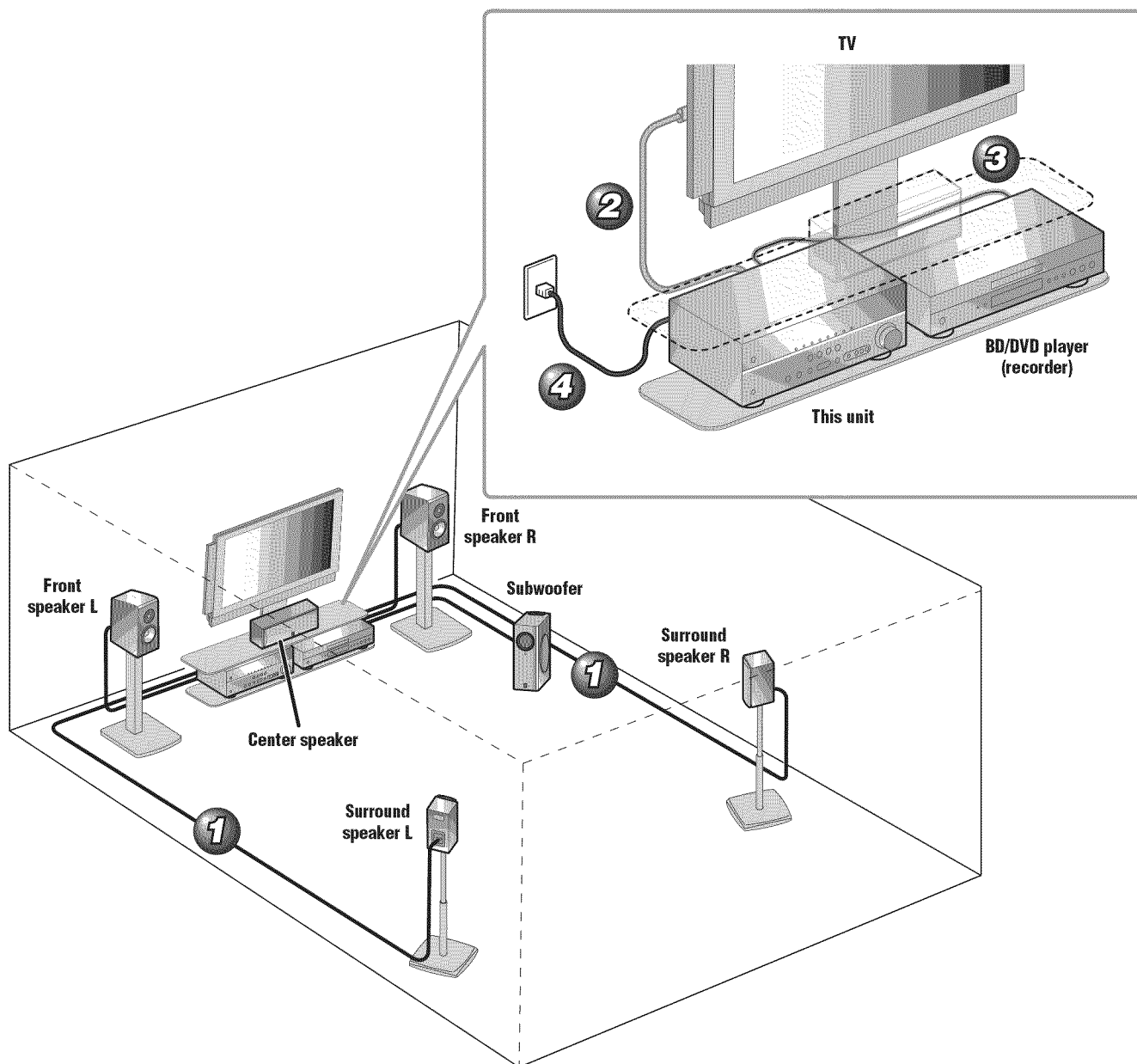
See the following explanations for the connections for each number.



**1** Connect the speakers

**2** Connect a TV

**3** Connect playback device such as BD/DVD players and recorders

**4** Connect the AC power cord, and turn the power on

When connection and installation is finished, set up the speaker parameters **5** .

# 1 Connect the speakers

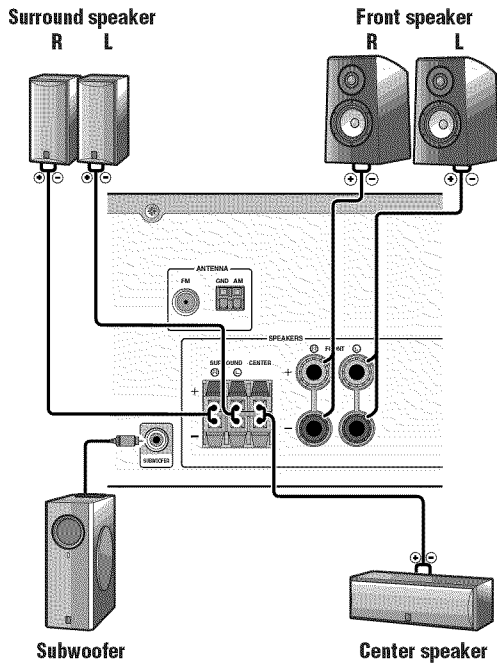

## Caution:

- Remove the AC power cord of this unit from the power outlet before connecting the speakers.
- Generally speaker cables consist of two parallel insulated cables. One of these cables is a different color, or has a line running along it, to indicate different polarity. Insert the different colored (or lined) cable into the "+" (positive, red) terminal on this unit and the speakers, and the other cable into the "-" (minus, black) terminal.
- Be careful that the core of the speaker cable does not touch anything or come into contact with the metal areas of this unit. This may damage this unit or the speakers. If the speaker cables short circuit, "CHECK SP WIRES!" will appear on the front panel display when this unit is switched on.
- When connecting 6Ω speakers, set the speaker impedance to 6Ω on this unit before making connections. Refer to Owner's Manual for information on settings.

## Connecting front speakers

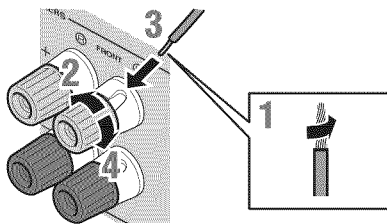

- 1 Remove approximately 10mm of insulation from the ends of the speaker cables, and twist the bare wires of the cables together firmly so that they will not cause short circuits.
- 2 Loosen the speaker terminals.
- 3 Insert the bare wire of the speaker cable into the gap on the side of the terminal.
- 4 Tighten the terminal.

## Connecting the banana plug (Except U.K., Europe, Asia and Korea models)

Tighten the knob, and then insert the banana plug into the end of the terminal.

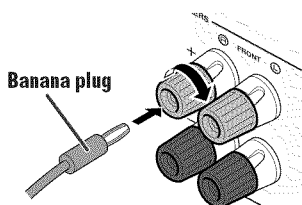

## Connecting center speakers / surround speakers

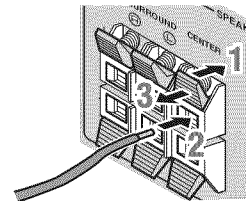

- 1 Press the tab on the speaker terminal down.
- 2 Insert the speaker cable end into the terminal.
- 3 Lift the tab to fix the speaker cable in place.

## Connecting the subwoofer

- 1 Connect the subwoofer input jack to the SUBWOOFER jack on this unit with an audio pin cable.

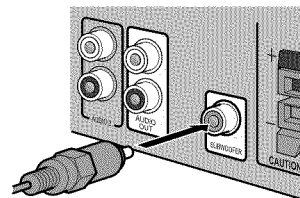

- 2 Set the subwoofer volume as follows.

Volume: Set to approximately half volume (or slightly less than half).

Crossover frequency (if available): Set to maximum.

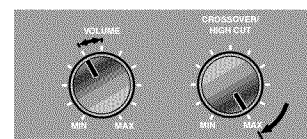

Subwoofer examples

## 2 Connect a TV

Video input to this unit is output to a TV using output jacks of the same kind.

When you have made connections using different types of video such as HDMI and component video, make the same connection with your TV. When viewing, be sure to switch the input source on your TV to match the playback device.

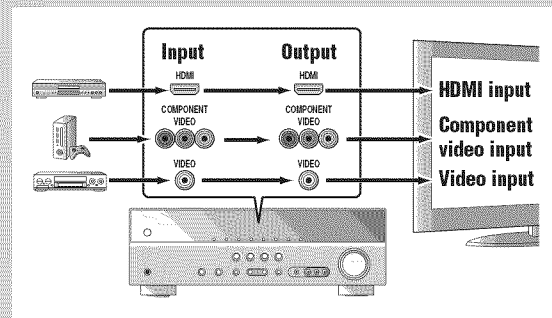

If your TV has multiple inputs, connect with the following priority (A) to (C).

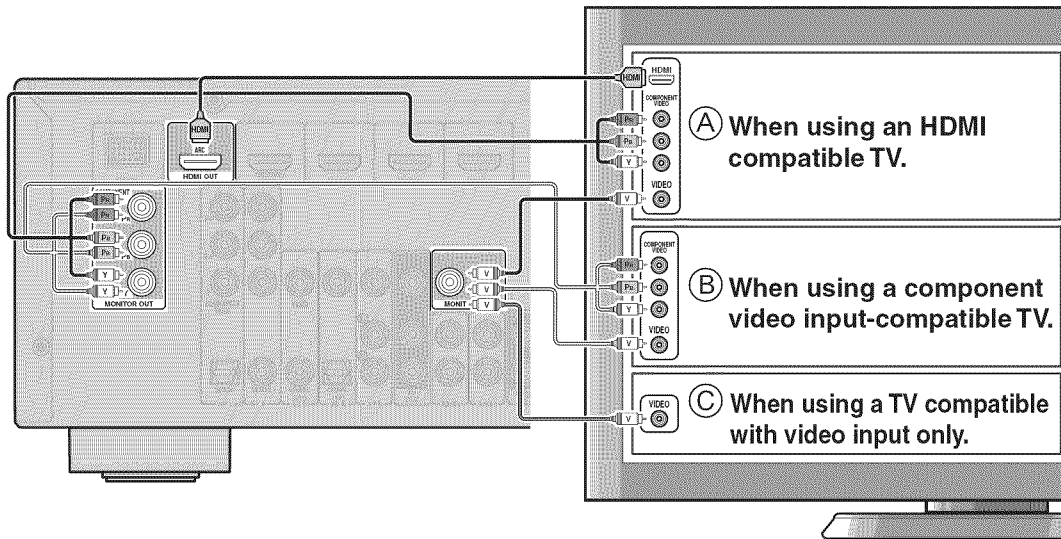

### Listening to TV audio

To playback TV audio on this unit, connect the TV audio output to this unit.

Connect the following input jacks, matching the audio output jacks on your TV. When viewing your TV, select the appropriate input source on this unit.

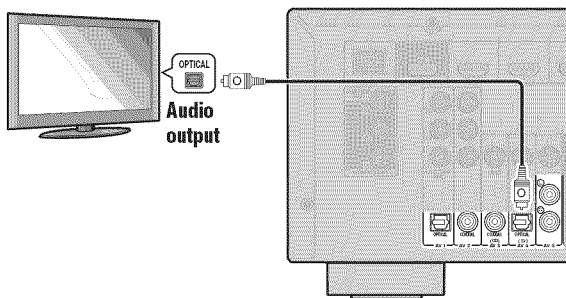

Audio output from TV	Input jack on this unit
Optical digital output	AV1 or AV4
Coaxial digital output	AV2 or AV3
Analog output	AV5, AUDIO1, AUDIO2, or V-AUX
HDMI Audio Return Channel (Described in the right column)	HDMI OUT

\* Connecting to AV4 allows you to playback TV audio just by pressing the "TV" under "SCENE" key.

When using an HDMI compatible TV that supports Audio Return Channel functions and / or HDMI Control functions (Ex. Panasonic VIERA Link), you can enjoy the TV sound on this unit as follows:

#### When using a TV that supports the Audio Return Channel functions and HDMI Control functions

The audio / video output from the unit to the TV and audio output from the TV to the unit are possible using a single HDMI cable.

The input source is switched automatically to match operations carried out on the TV, and that makes TV sound control easier to use.

For the connections and settings, refer to "Single HDMI cable input to TV audio with Audio Return Channel function" in Owner's Manual.

#### When using a TV that supports HDMI Control functions

When HDMI Control functions are enabled on the unit, input source can be switched automatically to match operations carried out on the TV.

For the connections and settings, refer to "Switching the input source on this unit automatically when listening to TV audio" in Owner's Manual.



### 3 Connect playback device such as BD/DVD players and recorders

If your playback device has multiple audio/video outputs, connect with the following priority (A to D) to enjoy a higher quality sounds and images.

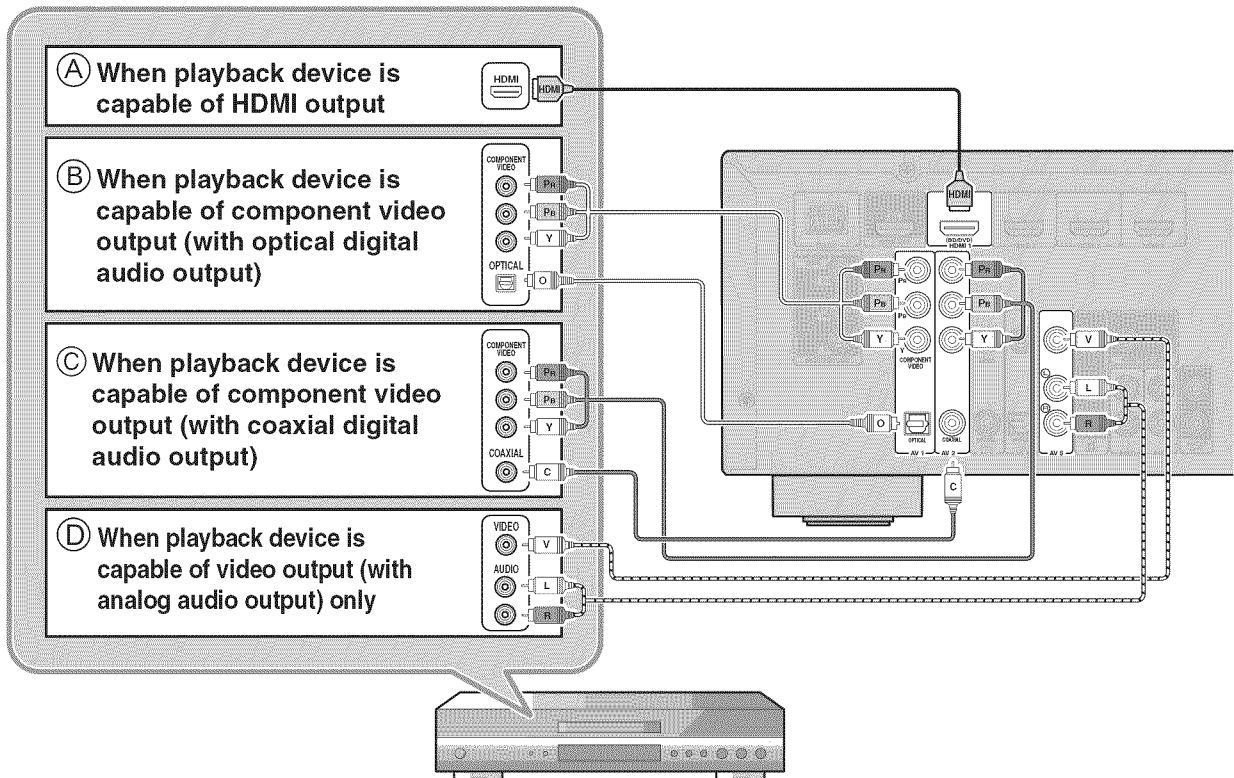

- When playback, select the corresponding input source the jack is connected.
- Connecting to HDMI1 allows you to select the HDMI input just by pressing the "BD/DVD" under "SCENE" key.
- Connecting to AV3 allows you to select the AV3 input just by pressing the "CD" under "SCENE" key.
- If necessary, you can connect components that cannot be connected using the above methods, such as devices that output video from component video output jacks and audio from analog output jacks. Refer to Owner's Manual for details.

### 4 Connect the AC power cord, and turn the power on

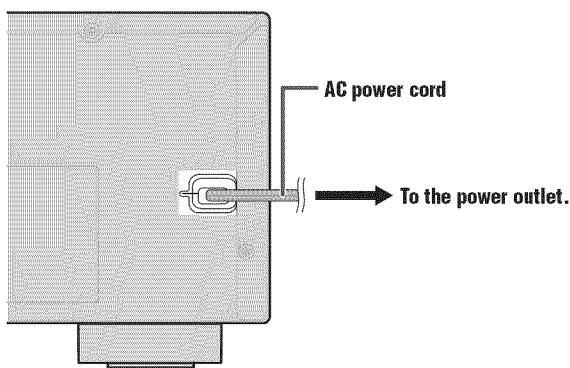

Be sure to aim the remote control directly at the remote control sensor on this unit during operation.

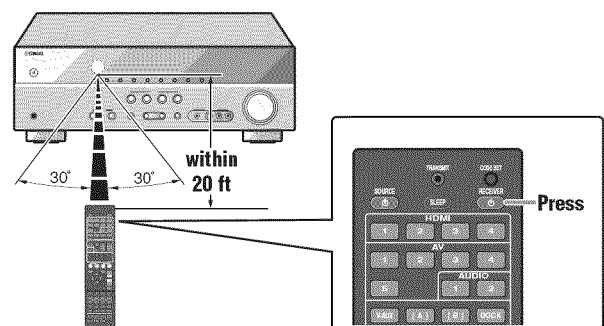

## 5 Set up speaker parameters

When you finish connecting, adjust the status, size, and volume of each speaker so that the output is normal.

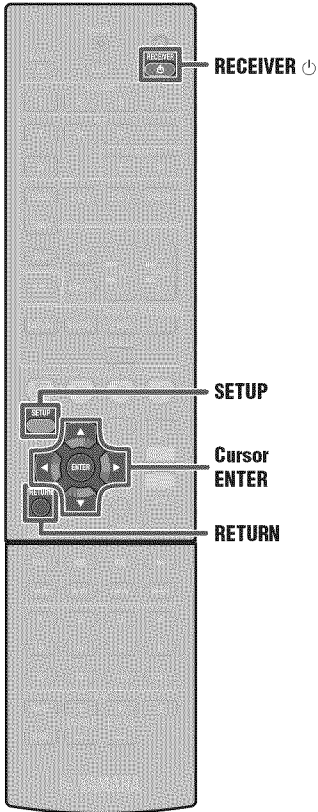

### STEP 1: Display the setting menu

- 1 Press **RECEIVER** on the remote control to switch this unit on.
- 2 Press **SETUP** on the remote control.
- 3 Check that "Speaker Setup" appears and press **ENTER**.



This completes step 1.

### STEP 2: Set the speaker status and size

The settings in step 2 are not necessary with the following speaker configuration:

- Front speaker: woofer diameter is 16 cm or larger
- Center/surround speakers: woofer diameter is 16 cm or smaller
- Subwoofer: connected

- 4 Check that "Config" appears and press **ENTER**.



- 5 Use **Cursor** / to select the speaker (subwoofer) you want to configure, and then use **Cursor** / to select speaker status and size.

Information	Description	Setting
Subwoofer	Sets the subwoofer status.	Yes/None
Front	Selects the size (sound reproduction capacity) of the front speakers.	Small/Large
Center	Selects the size of the center speakers. Choose "None" if you do not have a speaker connected.	None/Small/Large
Sur. LR	Selects the size of the surround speakers. Choose "None" if you do not have a speaker connected.	None/Small/Large
Crossover	Audio with a frequency below this limit will be output from the subwoofer or the front speakers.	40 Hz to 200 Hz
SWFR Phase	Switches the phase of the subwoofer.	NRM/REV
Extra Bass	Selects whether to play front channel low-frequency components through either the front speakers or the subwoofer (Off), or through both the subwoofer and front speakers (On).	On/Off

- Whether or not you set "Crossover," "SWFR Phase," and "Extra Bass" is optional. Check how the effects sound and then configure them to your liking.
- Use the following as a guide when setting speaker sizes.

When you have completed the settings for one speaker, repeat the same procedure for all speakers to complete settings.

- 6 Press **RETURN** when setting is complete.

This completes step 2.

### STEP 3: Set the distance from the listening point

- 7 Press **Cursor** to display "Distance" and press **ENTER**.



Continues to the next page

- 8 Press **Cursor**  $\Delta$  /  $\nabla$  to select the speaker (subwoofer) that you want to configure, and press **Cursor**  $\triangleleft$  /  $\triangleright$  to set the distance.

If necessary, you can change the setting units under "Unit."

Information	Description	Setting
Unit	Switches between setting units (feet / meters).	feet (ft) / meters (m)
Front L	Front speaker L	1.0 ft to 80.0 ft (0.30 m to 24.0 m)
Front R	Front speaker R	1.0 ft to 80.0 ft (0.30 m to 24.0 m)
Center	Center speaker	1.0 ft to 80.0 ft (0.30 m to 24.0 m)
Sur. L	Surround speaker L	1.0 ft to 80.0 ft (0.30 m to 24.0 m)
Sur. R	Surround speaker R	1.0 ft to 80.0 ft (0.30 m to 24.0 m)
SWFR	Subwoofer	1.0 ft to 80.0 ft (0.30 m to 24.0 m)

When you have completed the settings for one speaker, repeat the same procedure for all speakers to complete settings.

- 9 Press **RETURN** when setting is complete.

This completes step 3.

#### STEP 4: Playback a test tone

- 10 Press **Cursor**  $\nabla$  repeatedly to display "Test Tone" and press **ENTER**.



- 11 Use **Cursor**  $\triangleleft$  /  $\triangleright$  to select "On."

A test tone plays back from the speakers as soon as you select "On." The test tone plays back in a clockwise fashion. Only speakers configured for use in procedure 5 output the test tone.

- 12 Check that the test tone is playing back and press **RETURN**.

This completes step 4.

#### STEP 5: Adjust the volume

- 13 Press **Cursor**  $\Delta$  repeatedly to display "Level" and press **ENTER**.



- 14 Use **Cursor**  $\Delta$  /  $\nabla$  to switch the speaker that is outputting the test tone, looking for speakers with a different volume level to the others.

The front panel display shows the speaker that is outputting the test tone.  
Only speakers configured for use in procedure 5 output the test tone.

Information	Speakers
FL	Front speaker L
FR	Front speaker R
C	Center speaker
SL	Surround speaker L
SR	Surround speaker R
SWFR	Subwoofer

- 15 If you find a speaker with a different volume level to the others, use **Cursor**  $\triangleleft$  /  $\triangleright$  to adjust the volume. Use Front speaker L or R as a default when adjusting volumes.

To raise the volume: Press **Cursor**  $\triangleright$ .  
To lower the volume: Press **Cursor**  $\triangleleft$ .

- 16 Repeat steps 14 and 15 to adjust the volume balance for all speakers to your preference.

- 17 Press **RETURN** when setting is complete.

Return to the previous menu.  
This completes step 5.

- 18 Repeat procedures 10-12 (step 4) to stop playback of the test tone.

- 19 Once you have completed all settings, press **SETUP** to close the Setup menu.

# Operation guide

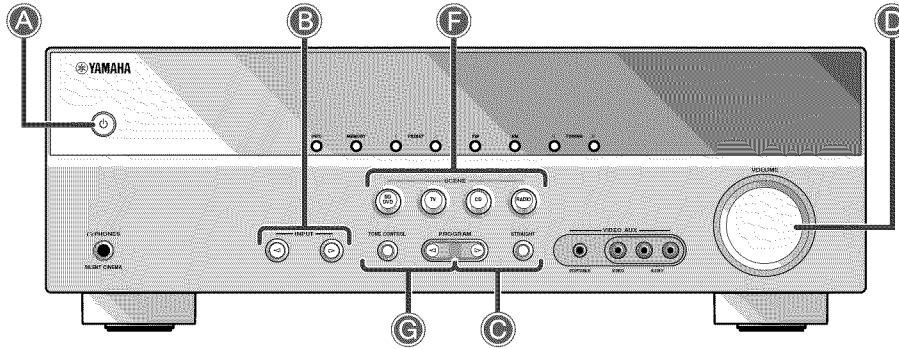

**A Switches this unit between on and standby modes**  
This unit switches between on and standby mode every time you press this key.

**B Choose an input source to listen to**  
The name of the selected input source appears on the front panel display.



**C Select sound field programs and sound decoders**

Front panel	Remote control	Description
PROGRAM	MOVIE	Selects sound field programs optimized for viewing movies, dramas, and sports.
	MUSIC	Selects sound field programs optimized for appreciating music.
	ENHANCER STEREO	Selects settings for stereo playback or enhancers for compressed audio.
STRAIGHT	SUR. DECODE	Selects surround decoders such as Dolby Pro Logic II.
STRAIGHT	STRAIGHT	Switches to straight decoding mode for faithful reproduction of audio / video.

**D Adjusts the volume level**  
The current volume level is displayed on the front panel display.



**E Mutes the sound**  
The indicator blinks while the sound is muted.

**F Switches between input settings**  
You can switch input sources and sound field programs with a single key.

SCENE	Input	Sound field program
BD/DVD	HDMI 1	STRAIGHT
TV	AV4	STRAIGHT
CD	AV3	STRAIGHT
RADIO	TUNER	5ch Enhancer

- Pressing and holding this key allows you to store input sources/sound field programs.
- Press this key when this unit is in standby mode to switch on the unit.

**G Adjusting high/low-frequency sound (Tone control)**

**1** Press **TONE CONTROL** to select "Treble" or "Bass."



**2** Press **PROGRAM** < / > to increase the setting.

- You can set the tone control for speakers and headphones separately. Connect the headphones when adjusting the headphone tone control.
- If you set an extreme tone balance, sounds may not match those from other channels.

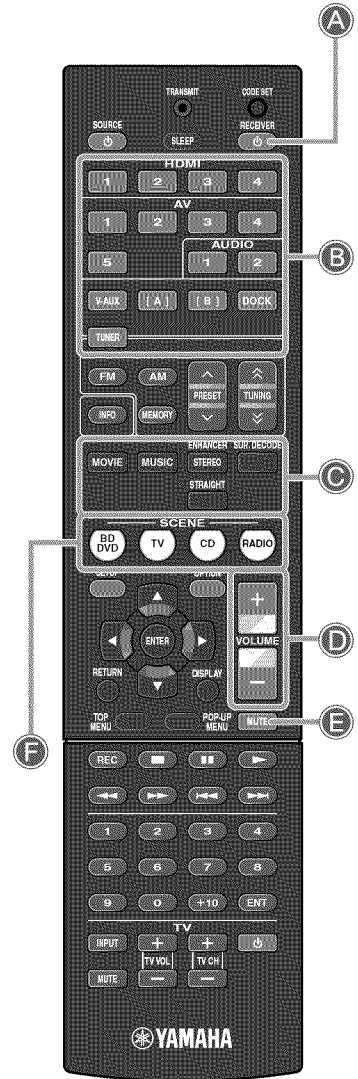

# List of remote control codes

## Liste des codes de commande

### Lista de códigos de mando a distancia

#### 遥控器代码列表

#### 리모콘코드목록

TV	
A.R. Systems	0320
Acme	0342
Acura	0323, 0343
ADC	0337
Admiral	0054, 0178, 0336, 0337, 0339, 0346, 0347
Advent	0158
Adventura	0057
Adyson	0277, 0282, 0342
Agashi	0277, 0282
Agazi	0337
Aiko	0277, 0282, 0320, 0323, 0342, 0343
Aim	0320
Aiwa	0078, 0379
Akai	0050, 0055, 0109, 0159, 0181, 0277, 0282, 0320, 0323, 0340, 0343, 0349, 0350
Akiba	0320, 0340
Akura	0320, 0323, 0337, 0340
Alaron	0277
Alba	0161, 0277, 0320, 0323, 0340, 0342, 0343, 0344, 0349, 0351, 0372, 0382
Albatron	0140
Alcyon	0171
Alleron	0059
Allorgan	0282
Allstar	0320, 0350
America Action	0179
AMOi	0276
Amplivision	0161, 0282, 0321, 0342
Amstrad	0320, 0323, 0337, 0340, 0343
Amtron	0058
Anam	0179, 0343
Anam National	0052, 0058
Anglo	0323, 0343
Anitech	0171, 0320, 0323, 0337, 0343
Ansonic	0161, 0168, 0320, 0323, 0341, 0343
AOC	0008, 0026, 0050, 0053
Apex	0039, 0111, 0217
Arcam	0277, 0282
Arcam Delta	0342
Aristona	0320, 0349, 0350
Arthur Martin	0321
ASA	0339, 0347
Asberg	0171, 0320, 0350
Astra	0343
Asuka	0277, 0282, 0337, 0340, 0342
Atlantic	0277, 0320, 0342, 0349, 0350
Atori	0323, 0343
Auchan	0321
Audiosonic	0161, 0282, 0320, 0340, 0342, 0343, 0349, 0350
AudioTon	0161, 0282, 0342
Audiovox	0058, 0179, 0194
Ausind	0171
Autovox	0171, 0282, 0337, 0339, 0342
Aventura	0051
Awa	0277, 0282
Axion	0156
Baird	0282
Bang & Olufsen	0180, 0339
Basic Line	0282, 0320, 0323, 0340, 0343, 0350
Bastide	0282, 0342
Baur	0320, 0349
Bazin	0282
Beko	0161, 0269, 0294, 0302, 0311, 0320, 0328, 0351
Belcor	0008
Bell & Howell	0019, 0054
Benq	0097, 0242, 0361
Beon	0320, 0349, 0350
Best	0161
Bestar	0161, 0320, 0350
Binatone	0282, 0342
Blue Sky	0320, 0340
Blue Star	0348
Boots	0282, 0342
BPL	0320, 0348
Bradford	0058, 0179
Brandt	0322, 0345
Brilliant	0182
Brinkmann	0320
Brionvega	0320, 0339, 0349, 0350
Britannia	0277, 0282, 0342
Brockwood	0008
Broksonic	0109, 0179
Bruns	0339
BTC	0340
Bush	0269, 0282, 0283, 0304, 0320, 0323, 0328, 0332, 0340, 0343, 0344, 0346, 0348, 0349, 0350, 0372, 0382, 0463, 0470, 0472
Candle	0008, 0026, 0050, 0057
Capsonic	0337
Carena	0320
Carnivale	0050
Carrefour	0344
Carver	0010
Cascade	0320, 0323, 0343
Casio	0367
Cathay	0320, 0349, 0350
CCE	0183, 0282
Celebrity	0055, 0107
Celera	0039
Centurion	0320, 0349, 0350
Century	0339
CGE	0161, 0171
Changhong	0039
Chimei	0273
Cimline	0323, 0343
Citizen	0007, 0008, 0026, 0050, 0058
City	0323, 0343
Clarion	0179
Clarivox	0349
Clatronic	0161, 0171, 0282, 0320, 0323, 0337, 0340, 0342, 0343, 0350, 0351
CMS	0277
CMS Hightec	0282
Coby	0197
Colortyme	0008, 0026
Commercial Solutions	0021
Concerto	0008, 0026
Concorde	0323, 0343
Condor	0161, 0277, 0320, 0323, 0342, 0350, 0351
Contec	0179, 0277, 0323, 0342, 0343, 0344
Contec/Cony	0012, 0058
Continental Edison	0345
Cosmel	0323, 0343
Craig	0058, 0179
Crosley	0010, 0037, 0171, 0339
Crown	0058, 0161, 0171, 0179, 0320, 0323, 0343, 0349, 0350, 0351
CS Electronics	0277, 0340, 0342
CTC Clatronic	0341
CTX	0205
Curtis Mathes	0007, 0008, 0010, 0019, 0021, 0026, 0049, 0050, 0178
CXC	0058, 0179
Cybertron	0340
Cytron	0152
Daewoo	0007, 0008, 0026, 0037, 0053, 0167, 0266, 0275, 0277, 0282, 0315, 0320, 0323, 0331, 0335, 0342, 0343, 0350, 0381, 0465
Dainichi	0277, 0340
Dansai	0277, 0282, 0320, 0337, 0349, 0350
Dantax	0161, 0349
Dawa	0320
Daytron	0007, 0008, 0026, 0323, 0343
De Graaf	0346
Decca	0282, 0320, 0342, 0349, 0350
Dell	0145, 0245
Denver	0358, 0362
Desmet	0320, 0349, 0350
Diamant	0320
Diamond	0277
DiamondVision	0135, 0143
Dimensia	0049
Disney	0219
Dixi	0282, 0320, 0323, 0343, 0349, 0350
Dream Vision	0461, 0498
DTS	0323, 0343
Dual	0282, 0320, 0342
Dual-Tec	0342, 0343
Dumont	0008, 0030, 0062, 0282, 0339, 0341, 0342
Durabrand	0031, 0051, 0179, 0215
Dux	0349
Dwin	0178
Dynatron	0320, 0349, 0350
Dynex	0228, 0231
Elbe	0161, 0168, 0282, 0320
Elcit	0339
Electa	0348
ELECTRO TECH	0343
Electroband	0055, 0107
Electrograph	0176
Electrohome	0008, 0026, 0052, 0055
Element	0230
Elin	0277, 0320, 0323, 0342, 0349, 0350
Elite	0320, 0340, 0350
Elman	0341
Elta	0277, 0323, 0343
Emerson	0000, 0007, 0008, 0012, 0013, 0019, 0026, 0031, 0037, 0051, 0058, 0059, 0161, 0179, 0320, 0339
Emprex	0154
Envision	0008, 0026, 0050
Epson	0155, 0206, 0359
Erres	0320, 0349, 0350
ESA	0051
ESC	0282
Etron	0343
Eurofeel	0282
Euro-Feel	0337
Euroline	0349
Euroman	0161, 0277, 0282
Euromann	0320, 0337, 0342, 0350
Europhon	0277, 0282, 0320, 0341, 0342, 0350
Expert	0321
Exquisit	0320
Fenner	0323, 0343
Ferguson	0322, 0345, 0349
Fidelity	0277, 0320, 0342, 0346
Filsai	0282
Finlandia	0346
Finlux	0171, 0282, 0320, 0339, 0341, 0342, 0349, 0350
FIRST LINE	0342, 0343, 0350
Firstline	0277, 0282, 0320, 0323
Fisher	0019, 0161, 0282, 0339, 0342, 0344, 0351
Flint	0320, 0350
Formenti	0171, 0277, 0336, 0339, 0342, 0349
Formenti/Phoenix	0277
Fortress	0336, 0339
Fraba	0161, 0320
Friac	0161
Frontech	0282, 0323, 0337, 0343, 0346, 0347
Fujitsu	0059, 0069, 0074, 0075, 0282
Fujitsu General	0282
Fujitsu Siemens	0504, 0505, 0507, 0510, 0511
Funai	0051, 0058, 0059, 0112, 0113, 0115, 0118, 0119, 0179, 0337
Futuretech	0058, 0179
Galaxi	0320, 0351
Galaxis	0161, 0320
Gateway	0176, 0177, 0241
GBC	0323, 0343, 0344
GE	0008, 0021, 0023, 0026, 0027, 0031, 0034, 0049, 0052, 0056, 0209
Geant Casino	0321
GEC	0282, 0320, 0342, 0347, 0349, 0350
Geloso	0323, 0343, 0346
General Technic	0323, 0343
Genexxa	0320, 0340, 0347, 0350
GFM	0128, 0227
Giant	0282

Gibraltar	0008, 0030, 0050, 0062	Ingersol	0323, 0343	Loewe	0161, 0168, 0265, 0320, 0330, 0352	Naonis	0346
GoldHand	0277	Initial	0153	Loewe Opta	0339, 0349, 0350	NEC	0008, 0026, 0050, 0052, 0053, 0072, 0103, 0282, 0344
Goldline	0320	Inno Hit	0171, 0282, 0320, 0323, 0340, 0342, 0343, 0349, 0350	Logik	0054	Neckermann	0161, 0282, 0320, 0339, 0342, 0346, 0349, 0350, 0351
GoldStar	0007, 0008, 0012, 0026, 0031, 0050, 0053, 0161, 0277, 0282, 0320, 0323, 0342, 0343, 0346, 0349, 0350	Innovation	0337, 0343	Luma	0320, 0323, 0346, 0349	NEI	0320, 0349, 0350
Goodmans	0246, 0272, 0282, 0320, 0323, 0337, 0343, 0344, 0349, 0350, 0462, 0473, 0477	Insignia	0131, 0228, 0236, 0238	Lumatron	0282, 0320, 0346, 0349, 0350	Net-TV	0176
Gorenje	0161, 0351	Inteq	0030	Lux May	0350	Neufunk	0320, 0323
GPM	0340	Interactive	0161	Luxman	0008, 0026	New Tech	0343, 0350
GPX	0129	Interbuy	0323, 0343	Luxor	0282, 0342, 0346	New World	0340
Gradiente	0240	Interfunk	0161, 0320, 0339, 0347, 0349, 0350	LXI	0010, 0019, 0021, 0026, 0027, 0031, 0049, 0111	NewTech	0282, 0320, 0323
Graetz	0347	International	0277	M Electronic	0342, 0343, 0345, 0347, 0349, 0350	Nicamagic	0277, 0342
Granada	0171, 0282, 0320, 0321, 0342, 0344, 0346, 0349, 0350	Intervision	0161, 0282, 0320, 0337, 0341, 0342	MAG	0096	Nikkai	0277, 0282, 0320, 0323, 0337, 0340, 0342, 0349, 0350
Grandin	0340, 0343, 0348, 0349	Irradio	0171, 0320, 0323, 0340, 0343, 0349, 0350	Magnadyne	0339, 0341, 0349	Nobliko	0171, 0277, 0341, 0342
Gronic	0282	Isukai	0320, 0340	Magnafon	0171, 0277, 0341, 0342	Nokia	0347
Grundig	0160, 0161, 0171, 0310, 0320	ITC	0282, 0342	Magnavox	0008, 0009, 0010, 0013, 0026, 0032, 0033, 0048, 0050, 0128, 0211, 0212, 0224, 0226, 0239	Norcent	0201
Grunpy	0058, 0059, 0179	ITS	0277, 0320, 0340, 0348, 0350	Magnum	0337, 0343	Nordic	0282
Haier	0157, 0233	ITT	0343, 0347	Majestic	0054	Nordmende	0339, 0345, 0347, 0350
Halifax	0277, 0282, 0337, 0342	ITV	0320, 0343, 0349	Mandor	0337	Nordvision	0349
Hallmark	0008, 0026, 0031	Janeil	0057	Manesth	0282, 0320, 0337, 0342, 0349, 0350	Novatronic	0320
Hampton	0277, 0282, 0342	JBL	0010	Marantz	0008, 0010, 0026, 0050, 0204, 0320, 0349, 0350	Oceanic	0321, 0347
Hanseatic	0161, 0168, 0282, 0320, 0323, 0342, 0343, 0344, 0349, 0350	JC Penney	0007, 0008, 0026, 0027, 0049, 0053, 0056	Marelli	0339	Okano	0161, 0320, 0351
Hantarex	0320, 0323, 0343	JCB	0055, 0107	Mark	0277, 0282, 0320, 0323, 0349, 0350	Olevia	0102, 0199, 0200, 0207, 0222
Hantor	0320	Jensen	0008, 0026	Masuda	0282	ONCEAS	0342
Harman/Kardon	0010	JVC	0012, 0014, 0015, 0056, 0064, 0065, 0067, 0169, 0174, 0297, 0314, 0344, 0350, 0375	Matsui	0282, 0320, 0323, 0342, 0343, 0344, 0346, 0349, 0350, 0455	Onwa	0058, 0179
Harvard	0058, 0179	Kaisui	0277, 0282, 0320, 0323, 0340, 0342, 0343, 0348	Matsushita	0017	Opera	0320
Harwood	0320, 0323	Kamosonic	0342	Maxent	0147, 0176	Oppo	0130
Havermy	0178	Kamp	0277, 0342	Mediator	0320, 0349, 0350	Optimus	0017, 0019
HCM	0282, 0320, 0323, 0337, 0342, 0343, 0348	Kapsch	0347	Medion	0320, 0337, 0343	Optoma	0144
Hema	0282, 0323	Karcher	0161, 0320, 0342, 0343, 0349	Megapower	0140	Optonica	0178
Hewlett Packard	0192	Kawasho	0008, 0026, 0055, 0277	Megatron	0026, 0031	Orbit	0320, 0350
Higashi	0277	KEC	0179	MElectronic	0277, 0282, 0320, 0323	Orion	0043, 0146, 0283, 0320, 0323, 0328, 0343, 0349, 0350
HiLine	0320	Kendo	0161, 0320, 0341, 0346	Melvox	0321	Orline	0320
Hinari	0320, 0323, 0340, 0343, 0344, 0349, 0350	Kenwood	0008, 0026, 0050	Memorex	0019, 0026, 0031, 0053, 0054, 0137, 0215, 0323, 0343	Osaki	0282, 0320, 0337, 0340, 0342
Hisawa	0321, 0340, 0348	KIC	0282	Memphis	0323, 0343	Oso	0340
Hisense	0247	Kingsley	0277, 0342	Mercury	0320, 0323	Otto Versand	0282, 0320, 0336, 0342, 0344, 0348, 0349, 0350
Hitachi	0008, 0012, 0026, 0066, 0084, 0092, 0093, 0120, 0172, 0173, 0255, 0270, 0271, 0282, 0320, 0335, 0338, 0342, 0344, 0346, 0347, 0365, 0382, 0448, 0456, 0467	KLH	0039	Metz	0339	Pael	0277, 0342
Hornymphon	0320, 0350	Kloss Novabeam	0057, 0058	MGA	0008, 0026, 0031, 0050, 0053	Palladium	0161, 0282, 0320, 0342, 0351
Hoshai	0340	Kneissel	0161, 0168, 0320	Micromaxx	0337, 0343	Palsonic	0282
Huanyu	0277, 0342	Kolster	0320, 0350	Microstar	0337, 0343	Panama	0277, 0282, 0320, 0323, 0337, 0342, 0343
Hygashi	0277, 0282, 0342	Konka	0340	Midland	0007, 0021, 0023, 0027, 0030, 0056, 0062	Panasonic	0016, 0017, 0020, 0022, 0023, 0035, 0052, 0056, 0084, 0085, 0133, 0163, 0193, 0284, 0286, 0290, 0292, 0320, 0325, 0347, 0356
Hyper	0277, 0282, 0323, 0342, 0343	Korpel	0320, 0349, 0350	Minerva	0171	Panavision	0320
Hypson	0282, 0320, 0321, 0337, 0342, 0348, 0349, 0350	Korting	0161, 0339	Minoka	0320, 0350	Pathe Cinema	0161, 0168, 0277, 0321, 0342
Hyundai	0141	Kosmos	0320	Mintek	0153	Pausa	0323, 0343
Iberia	0320	Koyoda	0343	Mitsubishi	0008, 0026, 0031, 0053, 0066, 0084, 0093, 0098, 0150, 0178, 0289, 0320, 0339, 0344, 0350, 0376	Penney	0021, 0023, 0031, 0050, 0111
ICE	0277, 0282, 0320, 0323, 0337, 0340, 0342, 0343, 0350	KTV	0007, 0050, 0058, 0179, 0183, 0282, 0342	Mivara	0161, 0168, 0171, 0277, 0282, 0342	Perdio	0277, 0320
ICeS	0277	Kyoto	0277, 0282	Monivision	0140	Perfekt	0320
Ilo	0148, 0153	Lasat	0161	Montgomery Ward	0054	Philco	0008, 0009, 0010, 0012, 0026, 0050, 0052, 0053, 0161, 0171, 0320, 0339
IMA	0058	Lenco	0323, 0343	Motion	0171	Philharmonic	0282, 0342
Imperial	0161, 0171, 0320, 0347, 0350, 0351	Lenoir	0323, 0342, 0343	Motorola	0052, 0178	Philips	0008, 0009, 0010, 0011, 0012, 0032, 0048, 0049, 0052, 0122, 0128, 0134, 0186, 0187, 0213, 0221, 0224, 0226, 0239, 0256, 0257, 0259, 0261, 0263, 0267, 0280, 0281, 0287, 0296, 0299, 0301, 0303, 0305, 0313, 0319, 0320, 0324, 0333, 0339,
Indiana	0320, 0349, 0350	Leyco	0320, 0337, 0349, 0350	MTC	0008, 0026, 0050, 0053, 0161, 0277		
Infinity	0010	LG	0031, 0053, 0066, 0116, 0117, 0140, 0161, 0164, 0175, 0195, 0269, 0277, 0282, 0300, 0309, 0317, 0320, 0323, 0328, 0342, 0343, 0346, 0349, 0350, 0366, 0368, 0377, 0466, 0471, 0478	Multi System	0349		
InFocus	0250, 0327, 0363, 0479, 0508	Liesenk	0349	Multitech	0058, 0161, 0179, 0183, 0277, 0282, 0320, 0323, 0341, 0342, 0343, 0344, 0346, 0349		
Ingelen	0347	Liesenkotter	0320	Murphy	0277, 0342		
		Life	0337, 0343	NAD	0026, 0031, 0111		
		Lifetec	0320, 0323, 0337, 0343				
		Lloyds	0323				

	0342, 0349, 0350, 0353, 0357, 0360, 0380, 0383, 0452, 0459, 0460	Saisho	0282, 0323, 0337, 0342, 0343	Sony	0038, 0044, 0045, 0047, 0055, 0104, 0105, 0107, 0110, 0123, 0184, 0220, 0248, 0249, 0251, 0252, 0254, 0326, 0343, 0344, 0371, 0374, 0457, 0475	Thomson	0162, 0188, 0189, 0285, 0320, 0322, 0342, 0345, 0350 0320, 0349
Philips Magnavox	0011, 0032, 0033		0171, 0341			Thorn	0008, 0026, 0031
Phoenix	0161, 0277, 0320, 0339, 0349, 0350		0007, 0008, 0026, 0050, 0176			TMK	0030
Phonola	0277, 0320, 0339, 0349, 0350		0004, 0005, 0006, 0007, 0008, 0012, 0026, 0031, 0036, 0050, 0053, 0076, 0077, 0079, 0114, 0124, 0125, 0126, 0127, 0139, 0161, 0183, 0185, 0190, 0191, 0258, 0264, 0277, 0282, 0320, 0323, 0334, 0337, 0342, 0343, 0349, 0350, 0351, 0373, 0453, 0468	Sound & Vision	0340, 0341	TNCi	0282, 0320, 0350
Pilot	0007, 0008, 0050		0277, 0282, 0342	Sounddesign	0008, 0026, 0031, 0058, 0059, 0179	Tokai	0277, 0342
Pioneer	0008, 0026, 0094, 0095, 0161, 0320, 0345, 0347, 0349, 0350, 0458		0043, 0109, 0320, 0350	Soundwave	0320, 0349, 0350	Tokyo	0348
Plantron	0320, 0323, 0337, 0350		0008, 0019, 0068, 0070, 0071, 0099, 0161, 0168, 0223, 0237, 0277, 0282, 0288, 0295, 0323, 0342, 0344, 0369, 0469	Squareview	0051	Tomashi	0018, 0019, 0040, 0041, 0046, 0073, 0100, 0103, 0108, 0109, 0111, 0121, 0132, 0166, 0208, 0210, 0214, 0217, 0260, 0268, 0282, 0283, 0293, 0304, 0306, 0307, 0329, 0344, 0355, 0454
Playsonic	0282		0320, 0349	SSS	0008, 0058, 0179	Toshiba	0007
Polaroid	0039, 0142, 0202, 0234		0277, 0282, 0342	Standard	0282, 0320, 0323, 0340, 0342, 0343, 0350	Totevision	0282, 0347
Poppy	0323, 0343		0043, 0109, 0320, 0350	Starlite	0058, 0179, 0320, 0323, 0349	Towada	0282
Portland	0007, 0008, 0026, 0053	Sandra	0277, 0282, 0342	Stenway	0348	Trakton	0282
Prandoni-Prince	0171, 0346	Sansui	0043, 0109, 0320, 0350	Stern	0346, 0347	Trans Continen	0282, 0320
Precision	0282, 0342	Sanyo	0008, 0019, 0068, 0070, 0071, 0099, 0161, 0168, 0223, 0237, 0277, 0282, 0288, 0295, 0323, 0342, 0344, 0369, 0469	Strato	0320, 0323	Transtec	0277
Prima	0157, 0243, 0323, 0343, 0347		0320, 0333, 0340, 0342, 0349, 0350, 0382	Stylandia	0282	Trident	0282
Princeton	0140		0026, 0031	Sunkai	0343	Triumph	0320
Prism	0023, 0056		0008, 0012, 0026, 0031, 0058, 0059, 0149, 0179	Sunstar	0320, 0323	Uher	0161, 0171, 0320, 0347, 0350
Profex	0323, 0343		0008, 0019, 0019, 0021, 0026, 0027, 0031, 0049, 0051, 0059, 0111	Sunwood	0320, 0323, 0343, 0350	Ultravox	0277, 0320, 0339, 0341, 0342
Profi-Tronic	0320, 0350		0277, 0282, 0320, 0323, 0337, 0341, 0342, 0344, 0349, 0382	Superla	0277, 0282, 0342	Unic Line	0320
Proline	0320, 0350	SBR	0320, 0349	Superscan	0013, 0178	United	0349
Proscan	0021, 0027, 0049	Sceptre	0235, 0244	SuperTech	0277, 0320, 0323	Universum	0161, 0171, 0282, 0320, 0337, 0349, 0350, 0351
Prosonic	0161, 0277, 0282, 0320, 0342, 0349	Schaub Lorenz	0347	Supra	0323, 0343	Univox	0320
Protech	0282, 0337, 0341, 0342, 0343, 0349, 0350	Schneider	0282, 0316, 0318, 0320, 0333, 0340, 0342, 0349, 0350, 0382	Supre-Macy	0057	Vector Research	0050
Proton	0008, 0012, 0026, 0031	Scotch	0026, 0031	Supreme	0055, 0107	Vestel	0282, 0320, 0346, 0347, 0349, 0350, 0351
Protron	0196	Scott	0008, 0012, 0026, 0031, 0058, 0059, 0149, 0179	Susumu	0340	Vexa	0320, 0323, 0343, 0349
PROVIEW	0096, 0246		0008, 0012, 0026, 0031, 0058, 0059, 0149, 0179	Sutron	0323, 0343	Victor	0015, 0344, 0350
Provision	0320, 0349	Sears	0008, 0010, 0019, 0021, 0026, 0027, 0031, 0049, 0051, 0059, 0111	SVA	0151	VIDEOLÓGIC	0277
Pulsar	0008, 0030, 0062		0277, 0282, 0320, 0323, 0337, 0341, 0342, 0344, 0349, 0382	Sydney	0277, 0282, 0342	Videologique	0277, 0282, 0340, 0342
Pye	0256, 0320, 0349, 0350, 0378		0339, 0341, 0347 0344, 0346, 0347	Sylvania	0008, 0009, 0010, 0011, 0013, 0026, 0048, 0050, 0051, 0128, 0227, 0253 0051, 0058, 0062, 0128, 0179, 0215	VideoSystem	0320, 0350
Pymi	0323, 0343	SEG	0277, 0282, 0320, 0323, 0337, 0341, 0342, 0344, 0349, 0382	Syntex	0199	Videotechnic	0277, 0282
Quandra Vision	0321		0320	Syntax-Brilliant	0199	Vidikron	0010
Quasar	0017, 0023, 0052, 0056	SEI	0320	Sysline	0349	Vidtech	0008, 0026, 0031, 0053
Quelle	0282, 0320, 0337, 0342, 0349, 0350	SEI-Sinudyne	0339, 0341, 0347 0344, 0346, 0347	Sytong	0277	Viewsonic	0176, 0203, 0232, 0364
Questa	0344	Seleco	0344, 0346, 0347	Tandy	0178, 0282, 0336, 0340, 0342, 0347	Viking	0057
Radialva	0320	Sencora	0323, 0343	Tatung	0052, 0177, 0282, 0320, 0342, 0349, 0350	Viore	0148
RadioShack	0019, 0021, 0031, 0050, 0179, 0320	Sentra	0323	TCM	0337, 0343	Visiola	0277, 0342
RadioShack/Realistic	0007, 0008, 0012, 0026, 0049, 0058	Serino	0277	Teac	0282, 0320	Vision	0282, 0320, 0350
Radiola	0282, 0320, 0349, 0350	Sharp	0000, 0001, 0002, 0003, 0007, 0008, 0012, 0026, 0060, 0088, 0089, 0091, 0138, 0165, 0170, 0178, 0198, 0229, 0262, 0278, 0279, 0291, 0308, 0312, 0336, 0344, 0354, 0370, 0449, 0450, 0451, 0464, 0474, 0476	Tec	0282, 0323, 0342, 0343	Vizio	0008, 0177, 0218, 0242, 0500, 0501, 0502, 0503, 0506 0320, 0349, 0350
Radiomarelli	0320, 0339		0320, 0339, 0341, 0349	Technics	0017, 0023, 0056	Vortec	0171, 0320, 0339, 0346, 0347, 0350
Radiotone	0161, 0320, 0323, 0350		0320, 0339, 0341, 0349	TechmiSat	0274, 0496, 0497, 0499	Voxson	0282, 0320, 0342
Rank	0344		0320, 0339, 0341, 0349	Techwood	0008, 0023, 0026, 0056	Waltham	0008, 0009, 0010, 0026, 0031, 0048, 0049, 0050, 0053, 0054, 0059
RCA	0008, 0021, 0024, 0025, 0026, 0027, 0042, 0049, 0052, 0053, 0063, 0136, 0225	Sheng Chia	0178	TEDELEX	0282	Wards	0007, 0008, 0010, 0012, 0026, 0053, 0054, 0058, 0059, 0179
Realistic	0019, 0031, 0050, 0179	Shogun	0008	Teknika	0007, 0008, 0010, 0012, 0026, 0053, 0054, 0058, 0059, 0179	Watson	0320, 0349, 0350
Recor	0320	Siarem	0320, 0339, 0341	Telecor	0282, 0320	Watt Radio	0277, 0341, 0342
Redstar	0320	Sierra	0320, 0350	Telefunken	0320, 0322, 0345, 0350	Waycon	0111
Reflex	0320	Siesta	0161	Telegazi	0320	Wega	0320, 0339, 0344
Revox	0161, 0320, 0349, 0350	Signature	0054	Telemeister	0320	Wegavox	0323
Rex	0337, 0346, 0347	Silva	0277	Telesonic	0320	Weltblick	0282, 0320, 0349, 0350
RFT	0161, 0168, 0339	Silver	0344	Telestas	0320	Westinghouse	0107, 0216, 0220
Rhapsody	0277	Singer	0321, 0339, 0341	Teletech	0320, 0323, 0343, 0349	White Westinghouse	0037, 0090, 0277, 0320, 0341, 0342, 0349
R-Line	0320, 0349, 0350	Skantic	0347	Teleton	0282, 0342	Wincom	0101, 0106
Roadstar	0323, 0337, 0340, 0343	Solavox	0347	Televideon	0277	Xrypton	0320
Robotron	0339	Sonitron	0161, 0282	Televiso	0321	Yamaha	0008, 0026, 0050, 0053, 0080, 0081, 0082, 0083, 0086, 0087
Rowa	0277, 0282	Sonoko	0282, 0320, 0323, 0337, 0342, 0343, 0349, 0350	Tensai	0282, 0320, 0323, 0340, 0343, 0350	Yamishi	0282, 0320
Royal Lux	0161		0321, 0347	Tesmet	0350	Yokan	0320
RTF	0339	Sonolor	0321, 0347	Tevion	0337, 0343		
Runco	0030, 0050, 0062	Sontec	0161, 0320, 0349, 0350	Textet	0277, 0282, 0323, 0342		
Saba	0298, 0322, 0339, 0345, 0347						

Yoko	0161, 0277, 0282, 0320, 0323, 0337, 0340, 0342, 0343, 0349, 0350	Dumont	1026, 1028	JC Penney	1064, 1065, 1068, 1070, 1071	Panasonic	1000, 1022, 1044, 1055, 1068, 1072, 1085, 1090, 1091, 1120, 1121, 1214
Yorx	0340	Durabrand	1114	JCL	1068	Pathe Marconi	1027
Zanussi	0282, 0346	Dynatech	1069	JVC	1007, 1018, 1027, 1039, 1064, 1065, 1066, 1067, 1078, 1089, 1092, 1093, 1094, 1095, 1113, 1208, 1209, 1212, 1213, 1215, 1218	Perdio	1026
Zenith	0008, 0028, 0029, 0030, 0031, 0054, 0061, 0062	Echostar	1018	Kaisui	1008, 1029	Philco	1008, 1068
<hr/>							
<b>VCR</b>							
ABS	1016	Elbe	1009	Karcher	1028	Philips	1006, 1013, 1028, 1035, 1040, 1045, 1046, 1050, 1058, 1059, 1061, 1068, 1076, 1101, 1110, 1113, 1116, 1117, 1122, 1126, 1210, 1211
Adventura	1069	Elcatech	1008	Kendo	1008, 1024, 1025, 1030	Philips Magnavox	1076
Adyson	1008	Electrohome	1071	Kenwood	1027, 1064, 1065	Phonola	1028
Aiwa	1024, 1026, 1027, 1069	Electrophonic	1071	Kodak	1068, 1071	Pilot	1071
Akai	1021, 1027	Elsay	1008	Korpel	1008, 1029	Pioneer	1028, 1036
Akiba	1008, 1029	Elta	1008, 1009, 1029	Kyoto	1008	Polaroid	1088, 1099
Akura	1008, 1027, 1029	Emerson	1008, 1020, 1068, 1069, 1071	Lenco	1025	Portland	1009, 1025, 1030
Alba	1008, 1009, 1024, 1025, 1029, 1030	ESC	1009, 1025	Leyco	1008, 1029	Prinz	1026
Alienware	1016	Etzuko	1008, 1029	LG	1010, 1026, 1031, 1047, 1054, 1056, 1071, 1103, 1221	Profex	1029
Ambassador	1030	Expressvu	1018	Lifetec	1024	Proline	1026
American High	1068	Ferguson	1027	Linksys	1016	Proscan	1019
Amstrad	1008, 1009, 1026	Fidelity	1008, 1026	Lloyd's	1069	Prosonic	1009, 1024
Anitech	1008, 1029	Finlandia	1028	Loewe Opta	1028, 1031	Pulsar	1114
Apex	1088	Finlux	1026, 1027, 1028	Logik	1008, 1029	Pye	1028, 1102
ASA	1028, 1031	Firstline	1008, 1024, 1029, 1031	Lumatron	1009, 1025	Quarter	1065
Asha	1070	Fisher	1065	Luxor	1008	Quartz	1065
Asuka	1008, 1026, 1028, 1029, 1031	Flint	1024	LXI	1071	Quasar	1068
Audio Dynamics	1064	Formenti/Phoenix	1028	M Electronic	1026	Quelle	1026, 1028
Audiosonic	1009	Frontech	1030	Magnavox	1020, 1068, 1114, 1126	Radialva	1008
Audiovox	1071	Fuji	1068	Magnin	1071	RadioShack	1071
Baird	1009, 1025, 1026, 1027	Fujitsu	1026	Manesth	1008, 1029	RadioShack/Realistic	1065, 1068, 1069, 1070, 1071
Bang & Olufsen	1017	Funai	1026, 1069	Marantz	1028, 1064, 1065, 1068	Radiola	1028
Basic Line	1008, 1009, 1024, 1025, 1029, 1030	Galaxy	1026	Mark	1009	Radix	1071
Baur	1028	Garrard	1069	Marta	1071	Randex	1071
Beaumarck	1070	Gateway	1016	Matsui	1024, 1031	RCA	1019, 1068, 1070, 1075, 1110, 1113, 1122, 1125
Bell & Howell	1065	GBC	1029, 1030	Matsushita	1068	Realistic	1065, 1068, 1069, 1070, 1071
Bestar	1009, 1025, 1030	GE	1068, 1070	Media Center PC	1016	ReplayTV	1022, 1123
Black Panther Line	1009, 1025	GEC	1028	Mediator	1028	Rex	1027
Blaupunkt	1028	Geloso	1029	Medion	1024	RFT	1008, 1028, 1030
Bondstec	1008, 1030	General	1030	MEI	1068	Ricavision	1016
Broksonic	1100	General Technic	1024	Memorex	1023, 1026, 1031, 1065, 1068, 1069, 1070, 1071, 1098, 1114	Roadstar	1008, 1009, 1025, 1029, 1031
Bush	1008, 1009, 1024, 1025, 1029, 1049, 1051, 1063, 1217	GOI	1018	Memphis	1008, 1029	Royal	1008
Calix	1071	GoldHand	1008, 1029	MGN Technology	1070	Runco	1114
Candle	1070, 1071	Goldstar	1026, 1031, 1064, 1071	Micromaxx	1024	Saba	1027
Canon	1068	Goodmans	1008, 1009, 1025, 1026, 1029, 1030, 1031	Microsoft	1016	Saisho	1024, 1029
Cathay	1009	Gradiente	1069	Microstar	1024	Samsung	1002, 1034, 1041, 1043, 1057, 1060, 1070, 1084, 1110, 1116, 1122, 1124, 1220, 1222
Catron	1030	Graetz	1027	Migros	1026	Samurai	1008, 1030
CGE	1026, 1027	Granada	1028	Mind	1016	Sanky	1114
Cimline	1008, 1024, 1029	Grandin	1008, 1009, 1025, 1026, 1029, 1030, 1031	Mitsubishi	1026, 1028, 1079	Sansui	1023, 1027, 1106, 1115
CineVision	1104	Hanseatic	1009, 1028, 1031	Motorola	1068	Sanyo	1032, 1065, 1070
Citizen	1070, 1071	Harley Davidson	1069	MTC	1070	Saville	1009
Clatronic	1008, 1030	Harman/Kardon	1064	Multitech	1008, 1026, 1028, 1029, 1030, 1069, 1070	SBR	1028
Colortyme	1064	Harwood	1008	Murphy	1026	Schaub Lorenz	1026, 1027
Condor	1009, 1025, 1030	HCM	1008, 1029	NEC	1027, 1064, 1065	Schneider	1008, 1009, 1024, 1025, 1026, 1028, 1029, 1030, 1031
Craig	1070, 1071	Headquarter	1065	Neckermann	1027, 1028	Sears	1065, 1068, 1071
Crown	1008, 1009, 1025, 1029, 1030	Hewlett Packard	1016	NEI	1028	SEG	1008, 1009, 1029
Curtis Mathes	1064, 1068, 1070	Hinari	1008, 1009, 1024, 1029	Nesco	1008, 1029	SEI-Sinudyne	1028
Cybernex	1070	Hisawa	1024	Nikkai	1008, 1009, 1030	Selec	1027
CyberPower	1016	Hitachi	1011, 1026, 1027, 1028, 1046, 1062	Nikko	1071	Sentra	1008, 1030
Daewoo	1009, 1025, 1030, 1038, 1069, 1223	HNS	1110	Niveus Media	1016	Sentron	1008, 1029
Dansai	1008, 1009, 1029	Howard Computers	1016	Noblex	1070	Sharp	1003, 1033, 1077, 1107, 1127, 1219
Dantax	1024	HP	1016	Nokia	1009, 1027	Shintom	1008, 1029
Daytron	1009, 1025	HTS	1018	Nordmende	1027	Shivaki	1031
DBX	1064	Hughes	1111, 1113, 1122	Northgate	1016	Shogun	1070
De Graaf	1028	Hughes Network Systems	1110, 1116	Oceanic	1026, 1027	Siemens	1031
Decca	1026, 1027, 1028	Humax	1012, 1110, 1113	Okano	1008, 1009, 1024	Silva	1031
Dell	1016	Hush	1016	Olympus	1068	Silver	1009
Denko	1008	Hypson	1008, 1009, 1024, 1029	Optimus	1071	Singer	1068
DiamondVision	1096	iBUYPOWER	1016	Orion	1023, 1024, 1051, 1115, 1217	Sinudyne	1028
DigiFusion	1014	Impego	1030	Orson	1026	Solavox	1030
DIRECTV	1019, 1105, 1110, 1111, 1113, 1116, 1122	Imperial	1026	Osaki	1008, 1026, 1029, 1031	Sonic Blue	1022, 1123
Dish Network	1018	Inno Hit	1008, 1009, 1025, 1028, 1029, 1030	Otto Versand	1028		
Dishpro	1018	Innovation	1024	Palladium	1008, 1027, 1029, 1031		
Dual	1009, 1027, 1028	Instant Replay	1068				
		Interbuy	1008, 1031				
		Interfunk	1028				
		Intervision	1009, 1026				
		Irradio	1008, 1029, 1031				
		ITT	1027				
		ITV	1009, 1025, 1031				



Sonneclair	1008	Airis	2364	Easy Home	2359	Limit	2355
Sonoko	1009, 1025	Aiwa	2322	Eclipse	2354	Liquid Video	2158
Sontec	1031	Akai	2145, 2177, 2179, 2248	E-Dem	2364	Liteon	2043, 2051, 2142
Sony	1001, 1016, 1048, 1053, 1073, 1074, 1080, 1081, 1082, 1083, 1108, 1118, 1216	Akura	2356	Electrohome	2362	Loewe	2320
Stack	1016	Alba	2064, 2165, 2186, 2337, 2346	Elin	2362	LogicLab	2355
Stack 9	1016	Alco	2149	Elta	2341, 2361, 2362	Magnavox	2025, 2050, 2137, 2150, 2159, 2224, 2230, 2358
Standard	1009, 1025	Alize	2361	Emerson	2129, 2137, 2150	Magnex	2367
Stern	1009	Allegro	2133	Enterprise	2129	Majestic	2360
STS	1068	Amitech	2362	Enzer	2380	Marantz	2328
Sunkai	1024	Amphion MediaWorks	2195	Epson	2247	Marquant	2362
Sunstar	1026	AMW	2195, 2363	ESA	2137	Matsui	2148, 2378
Suntronic	1026	Apex	2030, 2124, 2125, 2126, 2127, 2130, 2131	Finlux	2354, 2362, 2367	McIntosh	2199
Sunwood	1008, 1029	Apple	2241	Fintec	2377	Mecotek	2362
Superscan	1020	Argo	2138	Fisher	2134	Medion	2182
Sylvania	1020, 1068, 1069, 1102, 1126	Asono	2364	Funai	2137	Memorex	2028, 2145, 2234
Symphonic	1008, 1069, 1126	Aspire	2152, 2222	Gateway	2051	MiCO	2354, 2382
Systemax	1016	Astar	2240	GE	2029, 2131, 2156	Micromaxx	2182
Tagar Systems	1016	ATACOM	2364	Gericom	2351	Microsoft	2156
Taisho	1024	Audiosvox	2061, 2149	GFM	2226	Microstar	2182
Tandberg	1009	Avioius	2367	Giec	2382	Minoka	2362
Tandy	1065	Awa	2363	Global Solutions	2355	Minowa	2367
Tashiko	1026, 1071	Axion	2249	Global Sphere	2355	Mintek	2131, 2245
Tatung	1026, 1027, 1028	Bang & Olufsen	2128	Go Video	2133, 2213	Mitsubishi	2003
TCM	1015, 1024, 1042	Baze	2367	Goodmans	2165, 2280, 2291, 2358, 2371, 2376, 2382	Mizuda	2358, 2359
Teac	1009, 1069	BBK	2364	GPX	2227	Monyka	2380
Tec	1008, 1009, 1030	Bellagio	2363	Gradiente	2151	Mustek	2186
Technics	1068	Best Buy	2359	Graetz	2380	Mx Onda	2354
Teknika	1068, 1069, 1071	Blaupunkt	2131	Greenhill	2131	Mystral	2366
Teleavia	1027	Blue Parade	2157	Grundig	2349	Naiko	2362
Telefunken	1027	Boghe	2382	Grunkel	2362, 2366	Nesa	2131
Teletech	1008, 1009	Brainwave	2362	GVG	2377	Neufunk	2380
Tenosal	1008, 1029	Brandt	2148, 2188	H&B	2358	Nevir	2362
Tensai	1008, 1026, 1029, 1031	Brokronic	2145, 2146	H.her	2364	Next Base	2143
Tevion	1024	Bush	2064, 2110, 2170, 2268, 2290, 2346, 2358, 2367, 2383	Haaz	2354, 2355	Nexxtech	2243
Thomson	1005, 1027	California Audio Labs	2151	Haier	2254	NU-TEC	2383
Thorn	1027	Cambridge Audio	2354	Harman/Kardon	2047, 2135	Onkyo	2159, 2368
Tivo	1108, 1110, 1111, 1113, 1117, 1118, 1119, 1122	CAT	2352, 2353	HiMAX	2359	Oopla	2051
TMK	1070	CAVS	2192	Hitachi	2062, 2090, 2115, 2274, 2282, 2316, 2359, 2380	Oppo	2196, 2255
Tokai	1008, 1029, 1031	Centrum	2353	Hitek	2130	Optim	2381
Tonsai	1029	CGV	2354, 2362	Home Tech Industries	2364	Optimus	2180
Toshiba	1004, 1016, 1027, 1028, 1037, 1049, 1052, 1086, 1087, 1097, 1109, 1112, 1194	Changhong	2140	Hyundai	2366	Orava	2358
Totevision	1070, 1071	Cinetec	2363	Ilo	2245	Orbit	2363
Touch	1016	CineVision	2133, 2237	Initial	2131, 2245	Orion	2073, 2110
Towada	1008, 1029	Clatronic	2358, 2367	Innovation	2182	Oritron	2148, 2158
Towika	1008, 1029	Coby	2031, 2046, 2360	Insignia	2002, 2137, 2253	P&B	2358
TVA	1030	Conia	2383	Integra	2157	Pacific	2355
Uher	1031	Continental Edison	2363	Irradio	2053	Panasonic	2011, 2024, 2034, 2042, 2058, 2062, 2066, 2067, 2093, 2116, 2117, 2118, 2119, 2120, 2121, 2122, 2123, 2151, 2159, 2164, 2166, 2167, 2172, 2173, 2175, 2209, 2214, 2275, 2277, 2278, 2281, 2282, 2283, 2301, 2374, 2470
UltimateTV	1019	Crown	2362	iSymphony	2246	Parasound	2197
Ultravox	1009	C-Tech	2355	JBL	2135	peeKTON	2364
Unitech	1070	Curtis Mathes	2139	JVC	2020, 2096, 2097, 2099, 2100, 2101, 2102, 2103, 2106, 2107, 2160, 2257, 2260, 2262, 2263, 2321, 2324, 2326, 2327, 2343, 2464, 2465, 2468, 2469, 2471	Philips	2008, 2012, 2025, 2044, 2050, 2051, 2053, 2060, 2072, 2108, 2111, 2147, 2159, 2163, 2169, 2174, 2181, 2185, 2230, 2261, 2266, 2267, 2286, 2287, 2289, 2295, 2300, 2302, 2317, 2328, 2338, 2342, 2350, 2467
United Quick Star	1009, 1025	CVG	2377	Jwin	2198	Phonotrend	2367
Universum	1026, 1028, 1031	CyberHome	2022, 2098, 2138, 2187, 2336	Kansai	2360	Pioneer	2016, 2017, 2018, 2019, 2035, 2092, 2094, 2095, 2109, 2157, 2180, 2190, 2212, 2269, 2272, 2299, 2304, 2305, 2306, 2307, 2308, 2309, 2310, 2311, 2344, 2345, 2347, 2379
Vector Research	1064	Cytron	2244	Kawasaki	2149	Pointer	2362
Video Concepts	1064	Daenyx	2363	Kenex	2362	Polaroid	2125, 2215, 2235
Videon	1024	Daewoo	2001, 2133, 2276, 2298, 2330, 2362, 2363, 2377	Kenwood	2041, 2151, 2348	Portland	2362
Videosonic	1070	Daewoo International	2363	KeyPlug	2362	Powerpoint	2363
Viewsonic	1016	Dalton	2357	Kiuro	2362		
Voodoo	1016	Dansai	2362, 2381	Kingavon	2358		
Wards	1068, 1069, 1070, 1071	Daytek	2184, 2195, 2363	Kiss	2380		
Weltblick	1031	Dayton	2363	KLH	2131, 2149		
XR-1000	1068, 1069	DEC	2358	Koda	2358		
Yamaha	1064, 1065	Decca	2362	Koss	2013, 2148, 2158		
Yamashi	1008, 1029	Denon	2059, 2151, 2193, 2332	KXD	2359		
Yokan	1008, 1029	Denver	2356, 2358, 2360, 2370	Landel	2143		
Yoko	1008, 1029, 1030, 1031	Denzel	2380	Lasonic	2132		
Zenith	1114	Desay	2205	Lawson	2355		
ZT Group	1016	Diamond	2354, 2355	Lecson	2381		
		DiamondVision	2225, 2232	Lenco	2358, 2362, 2367		
		Disney	2010, 2028	Lenoxx	2136, 2153		
		DK Digital	2339	LG	2002, 2033, 2038, 2057, 2129, 2133, 2189, 2191, 2223, 2238, 2270, 2288, 2335, 2373, 2375		
		Dmtech	2176				
		Dual	2380				
		Durabrand	2136				
		DVX	2355				
				Life	2182		
				Lifetec	2182		

## DVD

4Kus	2051
Accurian	2142
Advent	2155, 2251
AEG	2362

Prima	2252	Teac	2149, 2333, 2355,	Hitachi	2062	HomeChoice	3106
Proceed	2130	Tec	2383	Insignia	2002	Humax	3021, 3080, 3083
Proscan	2156	Technics	2356	Irradio	2053	ITT Nokia	3097
Prosonic	2360, 2377	Technika	2151	JVC	2100, 2101, 2106,	Jasco	3123
Protron	2202	Telefunken	2362, 2367	LG	2107	Jerrold	3017, 3018, 3025,
Provision	2358	Tensai	2353		2033, 2057, 2223,		3066, 3072, 3084,
Pye	2144	Tevision	2362		2238		3090, 3096, 3119,
Qwestar	2148	Theta Digital	2182, 2355, 2357	Liteon	2043		3123
Raite	2380	Thomson	2157	Panasonic	2011, 2034, 2058,	JVC	3099
RCA	2021, 2029, 2104,		2183, 2188, 2334,		2062, 2116, 2117,	Kabel Deutschland	
	2105, 2131, 2149,	Tokai	2372		2119, 2120, 2121,		3024, 3027, 3121
	2156, 2157, 2229	Top Sucess	2356, 2380		2123	Macab	3101
RedStar	2356, 2360, 2362	Toshiba	2364	Philips	2008, 2044, 2050,	Magnavox	3079
Regent	2153		2032, 2036, 2037,		2051, 2147	Maspro	3099
Reoc	2355		2039, 2048, 2049,	Pioneer	2017, 2035	Matsui	3099
Rimax	2361		2054, 2055, 2072,	Pye	2144	MegaCable	3117
Rio	2133		2073, 2076, 2078,	Samsung	2000, 2112, 2216	Memorex	3076, 3122
Roadstar	2331, 2358		2079, 2086, 2145,	Sansui	2073	Minerva	3099
Ronin	2363		2159, 2218, 2233,	Sanyo	2217	Mnet	3107
Rotel	2203		2256, 2259, 2296,	Sony	2004, 2005, 2007,	Motorola	3025, 3026, 3084,
Rowa	2154, 2383		2369		2052, 2068, 2069,		3088, 3090, 3095,
Rownsonic	2353	TRANScontinents	2363, 2367		2074, 2208, 2210,		3117
Saba	2148, 2188	Transonic	2367		2211	Movie Time	3077, 3109
Sabaki	2355	Trio	2362	Sylvania	2239	Mr Zapp	3101
Saivod	2362	Trutech	2242	Toshiba	2032, 2036, 2037,	Multichoice	3107
Sampo	2141	TruVision	2359		2039, 2049, 2054,	Multitech	3127
Samsung	2000, 2045, 2077,	TSM	2364		2055, 2076	NEC	3064
	2112, 2113, 2114,	Umax	2361	Yamaha	2056	NET Brazil	3085
	2115, 2151, 2200,	United	2367			Nokia	3097
	2216, 2219, 2228,	Urban Concepts	2159			Noos	3101
	2264, 2265, 2271,	US Logic	2245			NSC	3077
	2279, 2294, 2303,	Venturer	2149			Oak	3074
	2329, 2365	Viewmaster	2364			Pace	3006, 3089, 3121
Sansui	2073, 2145, 2354,	Vocopro	2206			Palladium	3099
	2355, 2362	VocoStar	2207			Panasonic	3112, 3118, 3122
Sanyo	2134, 2145, 2217,	Waitec	2364			Paragon	3122
	2292	Welltech	2382			Philips	3068, 3071, 3079,
ScanMagic	2186	Westinghouse	2063, 2250				3099, 3100, 3101,
Schaub Lorenz	2362	Wharfedale	2354, 2355				3103
Schneider	2176	Woxter	2361, 2364			Pioneer	3001, 3006, 3094,
Scientific Labs	2355	Xbox	2156, 2183				3098, 3114, 3116,
Scott	2161, 2357	Xlogic	2355, 2362				3120
Seeltech	2364	XMS	2362			Popular Mechanics	
SEG	2162, 2355, 2363,	Xoro	2382				3126
	2380	Yamada	2051, 2361, 2363			Proscan	3066, 3093
Sharp	2006, 2040, 2088,	Yamaha	2056, 2064, 2065,			Pulsar	3122
	2091, 2182, 2194,		2080, 2081, 2082,			PVP Stereo Visual Matrix	
	2220, 2221, 2231,		2083, 2089, 2118,				3018
	2236, 2293, 2340		2151, 2323			Quasar	3122
Shinsonic	2245	Yamakawa	2363, 2380			RadioShack	3123, 3127
Sigmatek	2359, 2364	Yukai	2186			RCA	3030, 3031, 3087,
Silva	2356	Zenith	2002, 2129, 2133,				3118
Singer	2354, 2355		2159, 2223			Realistic	3070
Skymaster	2325, 2355					Recoton	3126
Skyworth	2356					Regal	3078
Slim Art	2362					Regency	3075
SM Electronic	2355					Rembrandt	3066
Sonic Blue	2133					Runco	3122
Sontech	2366					Sagem	3101
Sony	2004, 2005, 2007,					Samsung	3069, 3089, 3114,
	2009, 2014, 2015,						3120
	2023, 2026, 2027,					SAT	3098
	2052, 2068, 2069,					Scientific Atlanta	3000, 3001, 3002,
	2070, 2071, 2074,						3003, 3006, 3028,
	2075, 2084, 2085,						3029, 3081, 3086,
	2087, 2168, 2171,						3089, 3094, 3095,
	2208, 2210, 2211,						3108
	2258, 2273, 2284,					Signal	3072, 3123
	2285, 2312, 2313,					Signature	3066
	2314, 2315, 2318,					Sony	3092, 3125
	2319, 2466					Sprucer	3118
Soundmaster	2355					Standard Component	3115
Soundmax	2355					Starcom	3017, 3072, 3119,
Spectra	2363						3123
Spectroniq	2201					Stargate	3072, 3123
Standard	2355					Starquest	3072, 3123
Star Cluster	2355					Supercable	3090
Starmedia	2358, 2364					Supermax	3127
Sungale	2204					Tele+1	3107, 3111
Sunkai	2362					Telepiu	3107
Superscan	2150					Thomson	3082, 3091
Supervision	2355					TIME WARNER	3084
Sylvania	2012, 2137, 2150,					Tocom	3067
	2178, 2230, 2239					Torx	3017
Symphonic	2108, 2230					Toshiba	3122
Synn	2355					Tristar	3127
T.D.E. Systems	2366					Tudi	3102
Tatung	2001, 2362					Tusa	3072, 3123
TCM	2182, 2297						

## Cable

ABC	3002, 3003, 3017,
	3066, 3067, 3086,
	3093, 3119, 3122
ADB	3020
Adelphia	3081
Alcatel	3016
Americast	3124
Amstrad	3022, 3098
Antronix	3065, 3070
Archer	3070
Arcon	3098
AT&T	3095
Axis	3098
Bell South	3124
Cable Vision	3092
Cabletenna	3065
Cabletime	3104
Cableview	3087
Clearmaster	3127
ClearMax	3127
Clyde Cablevision	3105
Colour Voice	3068
Comcast	3084, 3088, 3117
Comcrypt	3107
Comtronics	3069
Contec	3074
Coolmax	3127
COX	3084
Cryptovision	3110
Director	3084
Eastern	3075
Everquest	3123
Fidelity	3098
Filmnet	3107
Filmnet Cablecrypt	3111
Filmnet Comcrypt	3111
Finlux	3097
Focus	3126
Foxtel	3022
France Telecom	3100, 3101
Freebox	3023
GC Electronics	3070
GE	3066, 3093
GEC	3105
Gemini	3072, 3123
General Instrument	3017, 3025, 3066,
	3084, 3090, 3096,
	3117
Goldstar	3120
Gooding	3099
Grundig	3098, 3099
Hamlin	3073, 3078
Hirschmann	3097
Hitachi	3066

## Blu-ray Disc

LG	2033
Panasonic	2011, 2209, 2214
Pioneer	2212
Samsung	2045, 2113
Sharp	2194, 2220, 2221
Sony	2075
Yamaha	2064

## DVR

Bush	2110
Hitachi	2090
Panasonic	2066, 2067, 2093,
	2116, 2117, 2119,
	2120, 2122, 2123
Philips	2108, 2111
Pioneer	2016, 2017, 2018,
	2019, 2092, 2094,
	2095, 2109
RCA	2105
Samsung	2113, 2219
Sharp	2088, 2091
Sony	2084, 2085, 2087
Toshiba	2086
Yamaha	2089, 2118

## DVD Recorder

Aspire	2222
Astar	2240
Broksonic	2146
Go Video	2213

TV86	3077	Conrad Electronic	4217, 4219	Grundig	4006, 4004, 4015, 4035, 4211, 4218, 4222	Mega	4055, 4053
Unika	3065, 3070	Contec	4050	Hänsel & Gretel	4219	Memorex	4127
United Cable	3018, 3119	Coolsat	4096	Hantor	4001, 4013	Metronic	4031, 4028, 4001, 4004, 4005, 4010, 4217
Universal	3065, 3070	Cosat	4048	Hanuri	4010	Metz	4015
Universum	3097, 3099	Coship	4109	Hauppauge	4044	Micro electronic	4218, 4219, 4217
V2	3127	Crown	4011	Helioacom	4219	Micro Technology	4217
Videoway	3019	Daeryung	4014	Helium	4219	MicroGem	4106
View Star	3074, 3077, 3079	Daewoo	4057, 4217	Hinari	4007	Micromaxx	4024, 4008
Viewmaster	3127	DDC	4007	Hirschmann	4024, 4015, 4210, 4218, 4219, 4216	Microstar	4008
Vision	3127	Delega	4007	Hisawa	4013	Microtec	4217
Visiopass	3097, 3100, 3101	Dew	4050	Hisense	4016	Minerva	4015
Vortex View	3127	Diamond	4051	Hitachi	4114, 4006, 4199, 4203	Mitsubishi	4006, 4015, 4202
Wittenberg	3098	Digitality	4219	Homecast	4087, 4084, 4085	Mitsumi	4054
Zenith	3113, 3122, 3124	Digital Stream	4105	Houston	4048	Morgan's	4011, 4054, 4055, 4053, 4217
Zentek	3126	DIRECTV	4056, 4064, 4067, 4068, 4070, 4071, 4074, 4107, 4116, 4119, 4121, 4122, 4123, 4127, 4192, 4193, 4194, 4195, 4196, 4197, 4198, 4199, 4200, 4201, 4202, 4203, 4206, 4207, 4221	HTS	4117	Motorola	4090, 4091, 4088, 4019
<b>Satellite</b>							
AB Sat	4216, 4217	Discoverer	4212	Hughes	4064, 4068, 4194, 4192, 4196, 4202	Multichoice	4222
AccessHD	4104	Discovery	4216	Hughes Network Systems	4071	Multitec	4212
ADB	4220	Diseqc	4216	Humax	4097, 4025, 4030, 4060	Muratto	4049
AGS	4216	Dish Network	4018, 4065, 4089, 4092, 4094, 4095, 4117	Huth	4005, 4011, 4012, 4013, 4050, 4048, 4219, 4223	Mysat	4217
Akai	4053, 4055	Dishpro	4018, 4117	Hypson	4031	Navex	4013
Alba	4001, 4004, 4006, 4007, 4062, 4217	Distrisat	4053	Ilo	4016	Neuhaus	4009, 4048, 4218, 4219, 4217
Aldes	4005, 4007, 4010	Ditristrad	4048	Imex	4031	Neusat	4217
Allsat	4048, 4053, 4055	DNT	4014, 4053, 4055	Innovation	4008	Next Level	4019
Allsonic	4005, 4008, 4024	Drake	4072	Insignia	4107	NextWave	4223
Alltech	4217	DStv	4222	Intertronic	4011	Nikko	4011, 4217
Alpha	4053	Dune	4024	Intervision	4048, 4219	Nokia	4006, 4040
Alpha Digital	4104	Echostar	4014, 4018, 4065, 4089, 4117, 4217	ITT Nokia	4006	Nordmende	4001, 4006, 4007, 4010, 4052
Alphastar	4077	Einhell	4001, 4005, 4011, 4217, 4218	Jerrold	4019	Nova	4222
Amitronica	4217	Elap	4216, 4217	Johansson	4013	Novis	4013
Amstrad	4011, 4035, 4217, 4218	Elekta	4010	JOK	4216	Oceanic	4051
Anglo	4217	Elsat	4217	JSR	4048	Octagon	4001, 4004, 4050
Ankaro	4005, 4008, 4024, 4217	Elta	4001, 4008, 4024, 4048, 4053, 4055	JVC	4089, 4065, 4117, 4029	Okano	4011
Anttron	4001, 4004	Emanon	4001	Kamm	4217	Optex	4048
Apollo	4001	Emme Esse	4008, 4024	Kathrein	4015, 4055, 4053, 4063, 4034, 4042, 4215, 4216, 4217	Optus	4213, 4222, 4223
Armstrong	4011, 4053	Engel	4217	Kathrein Eurostar	4215	Orbitech	4001, 4212, 4213, 4218
Artec	4100	Ep Sat	4006	Klap	4216	OSat	4004
Asat	4053, 4055	EURIEULT	4031	Konig	4219	Otto Versand	4015
ASLF	4217	Eurodec	4052	Kosmos	4049	Pace	4006, 4015, 4035, 4043, 4047, 4216
Astacom	4216	Europa	4053, 4218, 4219	KR	4004	Pacific	4051
Astra	4009, 4011, 4054, 4217, 4219	Europhon	4219	Kreiselmeyer	4015	Packsat	4216
Astro	4004, 4008, 4010, 4015, 4024, 4213, 4218, 4219	Eurosat	4011	K-SAT	4217	Palcom	4007
AudioTon	4004, 4048	Eurosky	4024, 4011, 4008, 4215, 4218, 4219	Kyostar	4001	Palladium	4011, 4218
Aurora	4222	Eurostar	4011, 4215, 4219	L&S Electronic	4024	Palsat	4212, 4218
Austar	4222	Eutelsat	4217	Lasat	4024, 4010, 4008, 4054, 4215, 4212, 4219	Panasat	4222
Axiel	4216	Exator	4001, 4004	Lasonic	4108	Panasonic	4121, 4126, 4124, 4006, 4035, 4036, 4221, 4198
Axis	4008, 4009, 4024, 4050	Expressvu	4117	Lenco	4024, 4001, 4049, 4215, 4219, 4217	Panda	4006, 4219
Best	4008, 4024	Fenner	4024, 4212, 4217	Leng	4013	Pansat	4125
Blaupunkt	4015	Ferguson	4006, 4052, 4214	Lennox	4048	Patriot	4216
Blue Sky	4217	Fidelity	4218	Lenxon	4218	Paysat	4127
Boca	4011, 4054, 4059, 4217	Finlandia	4006	Lexus	4053	PCT	4110
Boston	4216	Finlux	4006	LG	4103, 4107, 4049	Philco	4101
Brain Wave	4013	FinnSat	4050, 4052	Lifesat	4024, 4008, 4212, 4217	Philips	4071, 4068, 4127, 4006, 4055, 4053, 4061, 4033, 4213, 4216, 4196, 4202, 4203, 4201, 4206
Broadcast	4012	Flair Mate	4217	Lifetec	4008	Phoenix	4050
Broco	4217	Foxtel	4222	Lorenzen	4219	Phonotrend	4006, 4005, 4048
BSkyB	4035, 4041	Freecom	4001, 4049, 4218	Lorraine	4049	Pioneer	4046, 4213
BT	4216	FTEmaximal	4024, 4217	Lupus	4024, 4008	Polsat	4052
Bubu Sat	4217	Fuba	4024, 4001, 4008, 4014, 4015, 4055, 4215	Luxor	4218	Predki	4013
Bush	4006, 4045	Galaxis	4024, 4005, 4008, 4009, 4050, 4048, 4215, 4222	Lyonnaise	4052	Premiere	4048, 4213
Cambridge	4218	GE	4093, 4066, 4111, 4197	Macab	4052	Priesner	4011
Canal Satellite	4213	General Instrument	4073, 4019	Magnavox	4127, 4101	Primestar	4076
Canal+	4213	GMI	4011	Manata	4031, 4216, 4217	Profile	4216
CaptiveWorks	4099	GOI	4117	Manhattan	4006, 4010, 4048, 4216	Promax	4006
Channel Master	4007, 4110	Goldbox	4213	Marantz	4055	Prosat	4007, 4005
Chaparral	4075	GoldStar	4049	Mascom	4010	Proscan	4093, 4066, 4122, 4197
CHEROKEE	4216	Goodmans	4029, 4002, 4006	Maspro	4006, 4217	Protek	4051
Chess	4212, 4217	Goodmind	4111	Matsui	4216	Proton	4016
CityCom	4006, 4215, 4219	Grandin	4031	Max	4219	Provision	4010
Clatronic	4013	Grothusen	4001, 4049	Mediabox	4213	Quadral	4024, 4007, 4005, 4008, 4216
CNT	4010			Mediamarkt	4011	Quelle	4015, 4215, 4219
Comag	4080, 4081, 4082, 4083, 4086			Mediasat	4009, 4213, 4218	Quiero	4052
CommLink	4005			Medion	4024, 4008, 4217	RadioShack	4019
Comtech	4050			Medison	4217	Radiola	4055, 4053
Condor	4008, 4024, 4219					Radix	4014, 4037
Connexions	4014, 4024						
Conrad	4024, 4215, 4218, 4219						

Rainbow 4004  
RCA 4093, 4066, 4112, 4113, 4118, 4119, 4116, 4122, 4197, 4207  
Realistic 4078  
Redpoint 4009  
Redstar 4024, 4008  
RFT 4005, 4055, 4053  
Roadstar 4217  
Roch 4031  
Rover 4024, 4217  
Saba 4010, 4215, 4219, 4216  
Sabre 4006  
Sagem 4023, 4052  
Sakura 4050  
Samsung 4064, 4071, 4069, 4123, 4120, 4003, 4000, 4001, 4032, 4196, 4200  
SAT 4007, 4218  
Sat Cruiser 4223  
Sat Partner 4001, 4004, 4010, 4013, 4049, 4218  
Sat Team 4217  
Satcom 4012, 4219  
Satec 4217  
Sateleco 4024  
Safford 4012  
Satmaster 4012  
Satplus 4212  
Schneider 4008, 4212, 4216  
Schwaiger 4051, 4212, 4219  
SCS 4215  
Seemann 4011, 4009, 4014  
SEG 4024, 4001, 4008, 4013  
Seleco 4048  
Servi Sat 4031, 4217  
Siemens 4015  
Silva 4049  
Skantin 4217  
Skardin 4009  
Skinsat 4218  
SKR 4217  
Skymaster 4017, 4022, 4005, 4212, 4217  
Skymax 4055, 4053  
SkySat 4212, 4218, 4219, 4217  
Skyvision 4048  
SM Electronic 4212, 4217  
Smart 4215, 4217  
Sony 4067, 4070, 4213  
SR 4011, 4054  
Star Choice 4019  
Starland 4217  
Starring 4013  
Start Trak 4001  
Strong 4024, 4001, 4004, 4008, 4049, 4222  
STS 4115  
STVI 4031  
Sumida 4011  
Sunny Sound 4024  
Sunsat 4217  
Sunstar 4024, 4011, 4054  
Supermax 4223  
Tandberg 4052  
Tandy 4004  
Tantec 4006  
TCM 4008  
Techniland 4012  
TechniSat 4021, 4026, 4027, 4014, 4053, 4038, 4039, 4212, 4213, 4218  
Technology 4222  
Technosat 4223  
Technowelt 4219  
Teco 4011, 4054  
Telanor 4007  
Telasat 4215, 4219  
Telecom 4217  
Telefunken 4017, 4001, 4216  
Teleka 4004, 4011, 4014, 4218, 4219  
Telemaster 4010

Telesat 4219  
Telestar 4212, 4213, 4218  
Teledes 4006, 4218  
Telewire 4048  
Tempo 4223  
Tevion 4008, 4217  
Thomson 4020, 4006, 4052, 4058, 4208, 4215, 4213, 4219, 4216, 4217  
Thorens 4051  
Thorn 4006  
Tivax 4104  
Tivo 4196  
Tokai 4053  
Tonna 4006, 4012, 4048, 4218, 4217  
Toshiba 4194, 4202, 4203  
Triad 4049  
Triasat 4218  
Triax 4015, 4215, 4218, 4217  
Turnsat 4217  
Tvonics 4214  
Twiner 4031, 4217  
UEC 4222  
Uher 4212  
UltimateTV 4070  
Uniden 4079, 4127  
Unisat 4011, 4050, 4053  
Unitor 4013  
Universum 4015, 4215, 4219  
US Digital 4016  
Variosat 4015  
Vega 4024  
Ventana 4055, 4053  
Viewsat 4098  
Visiosat 4013, 4048, 4216, 4217  
Voom 4019  
Vortec 4001  
Welltech 4212  
WeTeKom 4212, 4218  
Wevasat 4006  
Wewa 4006  
Winersat 4013  
Wisi 4006, 4014, 4015, 4218, 4219  
Woorisat 4010  
Worldsat 4216  
Xrypton 4024  
XSat 4217  
Zehnder 4024, 4010, 4008, 4209, 4215  
Zenith 4102, 4107, 4195  
Zodiac 4004

---

## DOCK

Yamaha 5068, 5089

---

## NET

Yamaha 5076, 5079

---

## LD

Yamaha 2080

---

## Amplifier

Yamaha 5019, 5020

---

## CD

Yamaha 5082, 5095

---

## CD Recorder

Yamaha 5083

---

## MD

Yamaha 5080, 5081, 5086

---

## Tape

Yamaha 5084, 5087

---

## Tuner

Yamaha 5066, 5071, 5085, 5088, 5090, 5092, 5094

---

## XM

Yamaha 5091, 5093

---

## SIRIUS

Yamaha 5064, 5067

YAMAHA CORPORATION

© 2010 Yamaha Corporation

Ⓞ YC434C0/RC