



OWNER'S MANUAL  
Network 3D Blu-ray™  
Home Theater

Please read this manual carefully before operating your set and retain it for future reference.

LHB976

P/NO : SAC35095601

[www.lg.com](http://www.lg.com)



# Safety Information



**CAUTION:** TO REDUCE THE RISK OF ELECTRIC SHOCK DO NOT REMOVE COVER (OR BACK) NO USER-SERVICEABLE PARTS INSIDE REFER SERVICING TO QUALIFIED SERVICE PERSONNEL.



This lightning flash with arrowhead symbol within an equilateral triangle is intended to alert the user to the presence of uninsulated dangerous voltage within the product's

enclosure that may be of sufficient magnitude to constitute a risk of electric shock to persons.



The exclamation point within an equilateral triangle is intended to alert the user to the presence of important operating and maintenance (servicing)

instructions in the literature accompanying the product.

**WARNING:** TO PREVENT FIRE OR ELECTRIC SHOCK HAZARD, DO NOT EXPOSE THIS PRODUCT TO RAIN OR MOISTURE.

**WARNING:** Do not install this equipment in a confined space such as a book case or similar unit.

**CAUTION:** Do not block any ventilation openings. Install in accordance with the manufacturer's instructions.

Slots and openings in the cabinet are provided for ventilation and to ensure reliable operation of the product and to protect it from over heating. The openings shall be never be blocked by placing the product on a bed, sofa, rug or other similar surface. This product shall not be placed in a built-in installation such as a bookcase or rack unless proper ventilation is provided or the manufacturer's instruction has been adhered to.



**CAUTION:** This product employs a Laser System. To ensure proper use of this product, please read this owner's manual carefully and retain it for future reference. Shall the unit require maintenance, contact an authorized service center. Use of controls, adjustments or the performance of procedures other than those specified herein may result in hazardous radiation exposure. To prevent direct exposure to laser beam, do not try to open the enclosure. Visible laser radiation when open. DO NOT STARE INTO BEAM.

## CAUTION concerning the Power Cord

Most appliances recommend they be placed upon a dedicated circuit;

That is, a single outlet circuit which powers only that appliance and has no additional outlets or branch circuits. Check the specification page of this owner's manual to be certain. Do not overload wall outlets. Overloaded wall outlets, loose or damaged wall outlets, extension cords, frayed power cords, or damaged or cracked wire insulation are dangerous. Any of these conditions could result in electric shock or fire. Periodically examine the cord of your appliance, and if its appearance indicates damage or deterioration, unplug it, discontinue use of the appliance, and have the cord replaced with an exact replacement part by an authorized service center. Protect the power cord from physical or mechanical abuse, such as being twisted, kinked, pinched, closed in a door, or walked upon. Pay particular attention to plugs, wall outlets, and the point where the cord exits the appliance. To disconnect power from the mains, pull out the mains cord plug. When installing the product, ensure that the plug is easily accessible.

This device is equipped with a portable battery or accumulator.

**Safety way to remove the battery or the battery from the equipment:** Remove the old battery or battery pack, follow the steps in reverse order than the assembly. To prevent contamination of the environment and bring on possible threat to human and animal health, the old battery or the battery put it in the appropriate container at designated collection points. Do not dispose of batteries or battery together with other waste. It is recommended that you use local, free reimbursement systems batteries and accumulators. The battery shall not be exposed to excessive heat such as sunshine, fire or the like.

**CAUTION:** The apparatus shall not be exposed to water (dripping or splashing) and no objects filled with liquids, such as vases, shall be placed on the apparatus.

#### FCC Compliance Statement

This device complies with part 15 of the FCC rules. Operation is subject to the following two conditions:

- (1) This device may not cause harmful interference, and
- (2) This device must accept any interference received, including interference that may cause undesired operation.

**NOTE:** This equipment has been tested and found to comply with the limits for a Class B digital device, pursuant to Part 15 of the FCC Rules. These limits are designed to provide reasonable protection against harmful interference in a residential installation. This equipment generates, uses, and can radiate radio frequency energy and, if not installed and used in accordance with the instructions, may cause harmful interference to radio communications. However, there is no guarantee that interference will not occur in a particular installation.

If this equipment does cause harmful interference to radio or television reception, which can be determined by turning the equipment off and on, the user is encouraged to try to correct the interference by one or more of the following measures:

- Reorient or relocate the receiving antenna.
- Increase the separation between the equipment and receiver.

- Connect the equipment into an outlet on a circuit different from that to which the receiver is connected.
- Consult the dealer or an experienced radio/TV technician for help.

**CAUTION:** Any changes or modifications not expressly approved by the party responsible for compliance could void the user's authority to operate this equipment.

**FCC RF Radiation Exposure Statement :** This equipment complies with FCC radiation exposure limits set forth for an uncontrolled environment. This equipment should be installed and operated with minimum distance 20 cm between the radiator and your body. End users must follow the specific operating instructions for satisfying RF exposure compliance. This transmitter must not be co-located or operating in conjunction with any other antenna or transmitter.

#### FCC Radio Frequency Interference

**Requirements :** This device is restricted to indoor use due to its operation in the 5.15 to 5.25 GHz frequency range. FCC requires this product to be used indoors for the frequency range 5.15 to 5.25 GHz to reduce the potential for harmful interference to co-channel Mobile Satellite systems.

**CAUTION:** Regulations of the FCC and FAA prohibit airborne operation of radio-frequency wireless devices because their signals could interfere with critical aircraft instruments.

#### Responsible Party :

LG Electronics USA, Inc.1000 Sylvan Avenue,  
Englewood Cliffs, NJ 07632

TEL. : +1-800-243-0000

## Notes on Copyrights

- Because AACs (Advanced Access Content System) is approved as content protection system for BD format, similar to use of CSS (Content Scramble System) for DVD format, certain restrictions are imposed on playback, analog signal output, etc., of AACs protected contents. The operation of this product and restrictions on this product may vary depending on your time of purchase as those restrictions may be adopted and/or changed by AACs after the production of this product.
- Furthermore, BD-ROM Mark and BD+ are additionally used as content protection systems for BD format, which imposes certain restrictions including playback restrictions for BD-ROM Mark and/or BD+ protected contents. To obtain additional information on AACs, BD-ROM Mark, BD+, or this product, please contact an authorized Customer Service Center.
- Many BD-ROM/DVD discs are encoded with copy protection. Because of this, you should only connect your player directly to your TV, not to a VCR. Connecting to a VCR results in a distorted picture from copy-protected discs.
- This product incorporates copyright protection technology that is protected by U.S. patents and other intellectual property rights. Use of this copyright protection technology must be authorized by Rovi, and is intended for home and other limited viewing uses only unless otherwise authorized by Rovi. Reverse engineering or disassembly is prohibited.
- Under the U.S. Copyright laws and Copyright laws of other countries, unauthorized recording, use, display, distribution, or revision of television programs, videotapes, BD-ROM discs, DVDs, CDs and other materials may subject you to civil and/or criminal liability.

## IMPORTANT SAFETY INSTRUCTIONS

1. Read these instructions.
2. Keep these instructions.
3. Heed all warnings.
4. Follow all instructions.
5. Do not use this apparatus near water.
6. Clean only with dry cloth.
7. Do not block any ventilation openings. Install in accordance with the manufacturer's instructions.
8. Do not install near any heat sources such as radiators, heat registers, stoves, or other apparatus (including amplifiers) that produce heat.
9. Do not defeat the safety purpose of the polarized or grounding-type plug. A polarized plug has two blades with one wider than the other. A grounding type plug has two blades and a third grounding prong. The wide blade or the third prong are provided for your safety. If the provided plug does not fit into your outlet, consult an electrician for replacement of the obsolete outlet.
10. Protect the power cord from being walked on or pinched particularly at plugs, convenience receptacles, and the point where they exit from the apparatus.
11. Only use attachments/accessories specified by the manufacturer.
12. Use only with the cart, stand, tripod, bracket, or table specified by the manufacturer, or sold with the apparatus. When a cart is used, use caution when moving the cart/apparatus combination to avoid injury from tip-over.
 
13. Unplug this apparatus during lightning storms or when unused for long periods of time.
14. Refer all servicing to qualified service personnel. Servicing is required when the apparatus has been damaged in any way, such as power-supply cord or plug is damaged, liquid has been spilled or objects have fallen into the apparatus, the apparatus has been exposed to rain or moisture, does not operate normally, or has been dropped.

# Table of Contents

## 1 Getting Started

---

- 3 Safety Information
- 8 Introduction
- 8
  - Playable Discs and symbols used in this manual
- 9
  - About the "⓪" Symbol Display
- 10
  - File compatibility
- 11
  - AVCHD (Advanced Video Codec High Definition)
- 11
  - About DLNA
- 12
  - Certain System Requirements
- 12
  - LG Remote
- 12
  - WOL (Wake On LAN)
- 12
  - Regional Code
- 12
  - Compatibility Notes
- 13 Remote control
- 14 Front panel
- 15 Rear panel

## 2 Connecting

---

- 16 Assembling the speaker (Front)
- 18 Positioning the system
- 19 Connecting the System
- 19
  - Attaching the speakers to the player
- 19
  - Attaching the rear speakers to the wireless receiver
- 20
  - Wireless connection
- 20
  - Wireless connection, manually
- 21 Connecting to Your TV
- 21
  - HDMI Connection
- 22
  - What is SIMPLINK?
- 22
  - ARC (Audio Return Channel) function
- 23
  - Component Video Connection
- 23
  - Video Connection
- 24
  - Resolution Setting
- 24 Antenna connection
- 25 Connections with external device
- 25
  - AUX Connection
- 25
  - PORT. IN connection
- 26
  - OPTICAL IN connection
- 26
  - HDMI IN 1/2 connection

- 27 Connecting to your Home Network
- 27
  - Wired network connection
- 28
  - Wired Network Setup
- 29
  - Wireless Network Connection
- 29
  - Wireless Network Setup
- 32 USB device connection
- 32
  - Playback content in the USB device

## 3 System Setting

---

- 33 Settings
- 33
  - Adjust the Setup Settings
- 33
  - [DISPLAY] Menu
- 35
  - [LANGUAGE] Menu
- 35
  - [AUDIO] Menu
- 37
  - [LOCK] Menu
- 38
  - [NETWORK] Menu
- 39
  - [OTHERS] Menu
- 40 Sound Effect

## 4 Operating

---

- 41 General Playback
- 41
  - Using [HOME] menu
- 41
  - Playing a Disc
- 41
  - Playing a file on a disc/USB device
- 42
  - Playing Blu-ray 3D disc
- 42
  - Enjoying BD-LIVE
- 43
  - Playing a file on a network server
- 44
  - Connecting to a Wi-Fi Direct™ certified server
- 44
  - Basic operations for video and audio content
- 45
  - Basic operations for photo content
- 45
  - Using the disc menu
- 45
  - Resume playback
- 46 Advanced Playback
- 46
  - Repeat Playback
- 46
  - Repeating a specific portion
- 47
  - Marker Search
- 47
  - Using the search menu
- 48
  - Changing content list view
- 48
  - Viewing content information
- 48
  - Selecting a subtitle file
- 49
  - Last Scene Memory
- 49
  - Applying your photo to the Wallpaper
- 49
  - Options while viewing a photo

- 50 – Listening to music while slide show
- 50 On-Screen display
- 50 – Displaying content information on-screen
- 51 – Playing from selected time
- 51 – Hearing a different audio
- 52 – Selecting a subtitle language
- 52 – Watching from a different angle
- 52 – Changing the TV Aspect Ratio
- 52 – Changing subtitle code page
- 53 – Changing the Picture Mode
- 54 Audio CD Recording
- 55 Viewing information from Gracenote Media Database
- 56 Playing the iPod
  - 56 – Enjoying iPod on the screen
- 57 – Enjoying the iPod IN mode
- 58 Radio Operations
  - 58 – Presetting the Radio Stations
  - 58 – Deleting a saved station
  - 58 – Deleting all the saved stations
  - 58 – Improving poor FM reception
- 59 Using the Premium
- 59 Using the TV Apps
- 60 – Signing in
- 60 – Managing my Apps

## 5 Troubleshooting

---

- 61 Troubleshooting
  - 61 – General
  - 62 – Network
  - 63 – Picture
  - 63 – Sound
  - 63 – Customer Support
  - 63 – Open source software notice

## 6 Appendix

---

- 64 Controlling a TV with the Supplied Remote Control
  - 64 – Setting up the remote to control your TV
- 65 Network Software Update
  - 65 – Network update notification
  - 65 – Software Update
- 66 About Nero MediaHome 4 Essentials
  - 66 – Installing Nero MediaHome 4 Essentials
    - 67 – Sharing files and folders
- 68 Area Code List
- 69 Language code List
- 70 Trademarks and Licenses
- 72 Video Output Resolution
- 73 Specifications
- 75 Maintenance
  - 75 – Handling the Unit
  - 75 – Notes on Discs
- 76 Important Information Relating to Network Services

1

2

3













4

5

6

# Introduction

## Playable Discs and symbols used in this manual

Media/Term	Logo	Symbol	Description
Blu-Ray	  	<b>BD</b>	<ul style="list-style-type: none"> <li>Discs such as movies that can be purchased or rented.</li> <li>"Blu-ray 3D" discs and "Blu-ray 3D ONLY" discs.</li> <li>BD-R/RE discs that are recorded in BDAV format.</li> </ul>
		<b>MOVIE</b> <b>MUSIC</b> <b>PHOTO</b>	<ul style="list-style-type: none"> <li>BD-R/RE discs that contain Video, Audio or Photo files.</li> <li>ISO 9660+JOLIET, UDF and UDF Bridge format</li> </ul>
DVD-ROM DVD-R DVD-RW DVD+R DVD+RW (8 cm / 12 cm)	  	<b>DVD</b>	<ul style="list-style-type: none"> <li>Discs such as movies that can be purchased or rented.</li> <li>Video mode and finalized only</li> <li>Supports the dual layer disc also</li> </ul>
		<b>AVCHD</b>	Finalized AVCHD format
	 	<b>MOVIE</b> <b>MUSIC</b> <b>PHOTO</b>	<ul style="list-style-type: none"> <li>DVD±R/RW discs that contain Video, Audio or Photo files.</li> <li>ISO 9660+JOLIET, UDF and UDF Bridge format</li> </ul>
DVD-RW (VR) (8 cm / 12 cm)		<b>DVD</b>	VR mode and finalized only
Audio CD (8 cm / 12 cm)		<b>ACD</b>	Audio CD
CD-R/RW (8 cm / 12 cm)		<b>MOVIE</b> <b>MUSIC</b> <b>PHOTO</b>	<ul style="list-style-type: none"> <li>CD-R/RW discs that contain Video, Audio or Photo files.</li> <li>ISO 9660+JOLIET, UDF and UDF Bridge format</li> </ul>
Note	–		Indicates special notes and operating features.
Caution	–		Indicates cautions for preventing possible damages from abuse.



### Note

- Depending on the conditions of the recording equipment or the CD-R/RW (or DVD±R/RW) disc itself, some CD-R/RW (or DVD±R/RW) discs cannot be played on the unit.
- Depending on the recording software & the finalization, some recorded discs (CD-R/RW, DVD±R/RW, BD-R/RE) may not be playable.
- BD-R/RE, DVD±R/RW and CD-R/RW discs recorded using a personal computer or a DVD or CD Recorder may not play if the disc is damaged or dirty, or if there is dirt or condensation on the player's lens.
- If you record a disc using a personal computer, even if it is recorded in a compatible format, there are cases in which it may not play because of the settings of the application software used to create the disc. (Check with the software publisher for more detailed information.)
- This player requires discs and recordings to meet certain technical standards in order to achieve optimal playback quality.
- Pre-recorded DVDs are automatically set to these standards. There are many different types of recordable disc formats (including CD-R containing MP3 or WMA files) and these require certain pre-existing conditions to ensure compatible playback.
- Customers should note that permission is required in order to download MP3 / WMA files and music from the Internet. Our company has no right to grant such permission. Permission should always be sought from the copyright owner.
- You have to set the disc format option to [Mastered] in order to make the discs compatible with the LG players when formatting rewritable discs. When setting the option to Live System, you cannot use it on LG player. (Mastered/Live File System : Disc format system for windows Vista)

### About the “⊘” Symbol Display

“⊘” may appear on your TV display during operation and indicates that the function explained in this owner's manual is not available on that specific media.

## File compatibility

### Video files

File Location	File Extension	Codec Format	Audio Format	Subtitle
Disc, USB	“.avi”, “.divx”, “.mpg”, “.mpeg”, “.mkv”, “.mp4”, “.asf”, “.wmv”, “.m4v” (DRM free)	DIVX3.xx, DIVX4.xx, DIVX5.xx, DIVX6.xx (Standard playback only), XVID, MPEG1 SS, H.264/MPEG-4 AVC, MPEG2 PS, MPEG2 TS, VC-1 SM (WMV3)	Dolby Digital, DTS, MP3, WMA, AAC, AC3	SubRip (.srt / .txt), SAMI (.smi), SubStation Alpha (.ssa/.txt), MicroDVD (.sub/.txt), VobSub (.sub), SubViewer 1.0 (.sub), SubViewer 2.0 (.sub/.txt), TMLPlayer (.txt), DVD Subtitle System (.txt)
DLNA, PC	“.avi”, “.divx”, “.mpg”, “.mpeg”, “.mkv”, “.mp4”, “.asf”, “.wmv”, “.m4v” (DRM free)	DIVX3.xx, DIVX4.xx, DIVX5.xx, DIVX6.xx, XVID, MPEG1 SS, H.264/MPEG-4 AVC, MPEG2 PS, MPEG2 TS, VC-1 SM (WMV3)	Dolby Digital, DTS, MP3, WMA, AAC, AC3	SubRip (.srt / .txt), SAMI (.smi), SubStation Alpha (.ssa/.txt), MicroDVD (.sub/.txt), SubViewer 1.0 (.sub), SubViewer 2.0 (.sub/.txt), TMLPlayer (.txt), DVD Subtitle System (.txt)

### Audio files

File Location	File Extension	Sampling Frequency	Bitrate	Note
Disc, USB, DLNA, PC	“.mp3”, “.wma”, “.wav”, “.m4a” (DRM free)	within 32 - 48 kHz (WMA), within 16 - 48 kHz (MP3)	within 20 - 320 kbps (WMA), within 32 - 320 kbps (MP3)	Some wav files are not supported on this player.

### Photo files

File Location	File Extension	Recommended Size	Note
Disc, USB, DLNA, PC	“.jpg”, “.jpeg”, “.png”	Less than 4,000 x 3,000 x 24 bit/pixel Less than 3,000 x 3,000 x 32 bit/pixel	Progressive and lossless compression photo image files are not supported.

### Note

- The file name is limited to 180 characters.
- Maximum files/folder: Less than 2 000 (total number of files and folders)
- Depending on the size and number of the files, it may take several minutes to read the contents on the media.
- File compatibility may differ depending on the server.
- Because the compatibility on DLNA server are tested on the bundle DLNA server (Nero MediaHome 4 Essentials) environment, file requirements and playback functions may differ depending on media servers.
- The file requirements on page 10 are not always compatible. There may have some restrictions by file features and media server's ability.
- Playing a video subtitle files are only available on share folder of a PC or DLNA media server created by supplied Nero MediaHome 4 Essentials software on this player package.
- The files from removable media such as USB drive, DVD-drive etc. on your media server may not be shared properly.
- This unit cannot support the ID3 Tag embedded MP3 file.
- The total playback time of audio file indicated on the screen may not correct for VBR files.
- HD video files contained on the CD or USB 1.0/1.1 may not played properly. BD, DVD or USB 2.0 are recommended to play back HD video files.
- This player supports H.264/MPEG-4 AVC profile Main, High at Level 4.1. For a file with higher level, the warning message will appear on the screen.
- This player does not support files that are recorded with GMC\*<sup>1</sup> or Qpel\*<sup>2</sup>.

\*1 GMC – Global Motion Compensation

\*2 Qpel – Quarter pixel

## AVCHD (Advanced Video Codec High Definition)

- This player can playback AVCHD format discs. These discs are normally recorded and used in camcorders.
- The AVCHD format is a high definition digital video camera format.
- The MPEG-4 AVC/H.264 format is capable of compressing images at higher efficiency than that of the conventional image compressing format.
- This player can playback AVCHD discs using “x.v.Color” format.
- Some AVCHD format discs may not play depending on the recording condition.
- AVCHD format discs need to be finalized.
- “x.v.Color” offers a wider color range than normal DVD camcorder discs.

## About DLNA

This Player is a DLNA Certified digital media player that can display and play movie, photo and music content from your DLNA-compatible digital media server (PC and Consumer Electronics).

The Digital Living Network Alliance (DLNA) is a cross-industry organization of consumer electronics, computing industry and mobile device companies. Digital Living provides consumers with easy sharing of digital media through your home network.

The DLNA certification logo makes it easy to find products that comply with the DLNA Interoperability Guidelines. This unit complies with DLNA Interoperability Guidelines v1.5.

When a PC running DLNA server software or other DLNA compatible device is connected to this player, some setting changes of software or other devices may be required. Please refer to the operating instructions for the software or device for more information.

## Certain System Requirements

For high definition video playback:

- High definition display that has COMPONENT or HDMI input jacks.
- BD-ROM disc with high definition content.
- HDMI or HDCP capable DVI input on your display device is required for some content (as specified by disc authors).

For playing files on your PC's share folder via your home network, the PC requires below.

- Windows® XP (Service Pack 2 or higher), Windows Vista® (no Service Pack required) Windows 7® (no Service Pack required)
- 1.2 GHz Intel® Pentium® III or AMD Sempron™ 2200+ processors
- Network environment: 100 Mb Ethernet, WLAN (IEEE 802.11a/b/g/n)
- More than 1 folder on your PC has to be shared. Visit support link of your operating system for more information on file share settings.

## LG Remote

You can control this player with your iPhone or Android phone via your home network. This player and your phone must be connected to your wireless network device such as access point. Visit "Apple iTunes" or "Google Apps Marketplace" for detailed information of "LG Remote".

## WOL (Wake On LAN)

Users can turn on this player using WOL embedded utility on your personal computer or smartphone via your home network. To use this feature, this player must be connected to the WOL available access point or router with wired network connection. Refer to the relevant manual of the utility or network devices for more detailed information.

## Regional Code

This unit has a regional code printed on the rear of the unit. This unit can play only BD-ROM or DVD discs labeled same as the rear of the unit or "ALL".

## Compatibility Notes

- Because BD-ROM is a new format, certain disc, digital connection and other compatibility issues are possible. If you experience compatibility problems, please contact an authorized Customer Service Center.
- This unit allows you to enjoy functions such as picture-in-picture, secondary audio and Virtual packages, etc., with BD-Video supporting BONUSVIEW (BD-ROM version 2 Profile 1 version 1.1/ Final Standard Profile). Secondary video and audio can be played from a disc compatible with the picture-in-picture function. For the playback method, refer to the instructions in the disc.
- Viewing high-definition content and up-converting standard DVD content may require a HDMI-capable input or HDCP-capable DVI input on your display device.
- Some BD-ROM and DVD discs may restrict the use of some operation commands or features.
- Dolby TrueHD, Dolby Digital Plus and DTS-HD are supported with maximum 5.1 channels if you use HDMI connection for the audio output of the unit.
- You can use a USB device to store some disc related information, including downloaded on-line content. The disc you are using will control how long this information is retained.

# Remote control

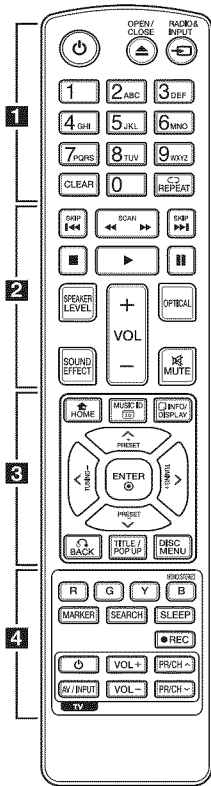

## Battery Installation

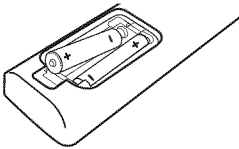

Remove the battery cover on the rear of the Remote Control, and insert two R03 (size AAA) batteries with **+** and **-** matched correctly.

..... **1** .....

**⏻ (POWER):** Switches the player ON or OFF.

**⏴ (OPEN/CLOSE):** Opens and closes the disc tray.

**RADIO&INPUT:** Changes input mode.

**0-9 numerical buttons:** Selects numbered options in a menu or inputs letters in the keypad menu.

**CLEAR:** Removes a mark on the search menu or a number when setting the password.

**REPEAT (↺):** Repeats a desired section or sequence.

..... **2** .....

**⏮/⏭ (SCAN):** Searches backward or forward.

**⏪/⏩ (SKIP):** Goes to the next or previous chapter / track / file.

**■ (STOP):** Stops playback.

**▶ (PLAY):** Starts playback.

**⏸ (PAUSE):** Pauses playback.

**SPEAKER LEVEL:** Sets the sound level of desired speaker.

**SOUND EFFECT:** Selects a sound effect mode.

**VOL +/-:** Adjusts speaker volume.

**OPTICAL:** Changes input mode to optical directly.

**MUTE:** Mute the unit.

..... **3** .....

**HOME (🏠):** Displays or exits the [Home Menu].

**MUSIC ID:** When connected to the network, can provide information about the current song while video playback.

**INFO/DISPLAY (ℹ):** Displays or exits On-Screen Display.

**Direction buttons:** Selects an option in the menu.

**PRESET +/-:** Selects programme of Radio.

**TUNING +/-:** Tunes in the desired radio station.

**ENTER (⊙):** Acknowledges menu selection.

**BACK (↶):** Exits the menu or resumes playback. The resume play function may not work depending on the BD-ROM disc.

**TITLE/POP-UP:** Displays the DVD title menu or BD-ROM's pop-up menu, if available.

**DISC MENU:** Accesses menu on a disc.

..... **4** .....

**Colored (R, G, Y, B) buttons:**

- Use to navigate BD-ROM menus. They are also used for [MOVIE], [PHOTO], [MUSIC], [Premium] and [TV Apps] menu.

- **B** button: Selects mono/ stereo in FM mode.

**MARKER:** Marks any point during playback.

**SEARCH:** Displays or exits the search menu.

**SLEEP:** Sets a certain period of time after which the unit will switch to off.

● **(REC):** Records an audio CD.

**TV Control Buttons:** See page 64.

# Front panel

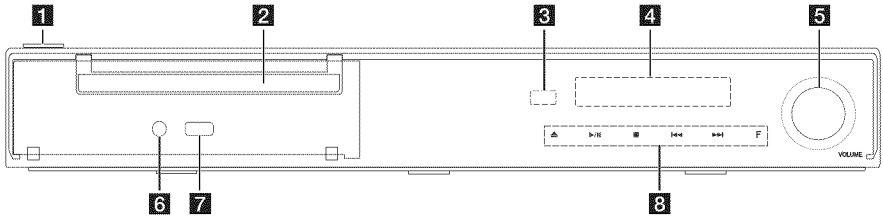

**1** (POWER) Button

**2** Disc Tray

**3** Remote Sensor

**4** Display Window

**5** Volume Control

**6** PORT.IN

**7** USB Port

**8** Operation buttons

(OPEN/CLOSE)

(PLAY / PAUSE)

(STOP)

(SKIP)

F (Function)

Changes the input source or function.

## Caution

Precautions in using the touch buttons

- Use the touch buttons with clean and dry hands.
  - In a humid environment, wipe out any moisture on the touch buttons before using.
- Do not press the touch buttons hard to make it work.
  - If you apply too much strength, it can damage the sensor of the touch buttons.
- Touch the button that you want to work in order to operate the function correctly.
- Be careful not to have any conductive material such as metallic object on the touch buttons. It can cause malfunctions.

## Rear panel

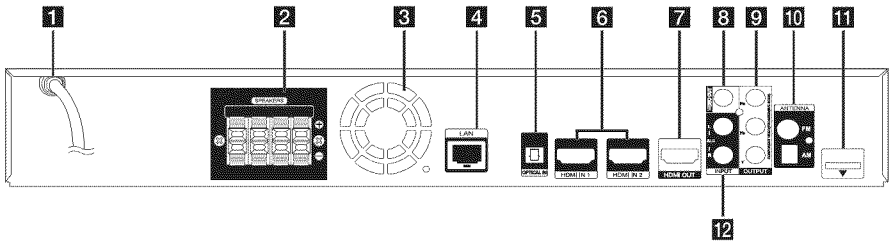

- |                              |  |
|------------------------------|--|
| <b>1</b> AC power cord       | <b>8</b> VIDEO OUT   |
| <b>2</b> Speakers connectors | <b>9</b> COMPONENT VIDEO (Y PB PR)<br>OUTPUT (PROGRESSIVE SCAN)  |
| <b>3</b> Cooling Fan         | <b>10</b> Antenna Connector                                      |
| <b>4</b> LAN port            | <b>11</b> iPod (24 pin)<br>Connect to the furnished iPod cradle. |
| <b>5</b> OPTICAL IN          | <b>12</b> AUX (L/R) INPUT  |
| <b>6</b> HDMI IN 1/2         |  |
| <b>7</b> HDMI OUT            |  |

# Assembling the speaker (Front)

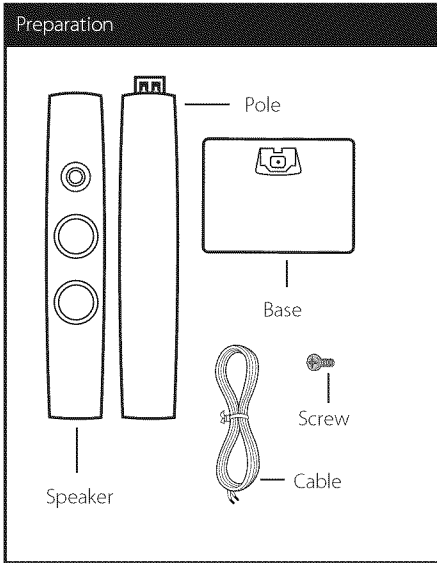

1. Attach the pole to the base, then secure the connection with a supplied screw.

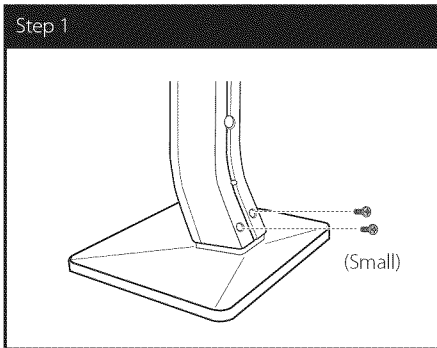

2. Secure the connection with a supplied screw, then insert a speaker wire from the bottom of the base.

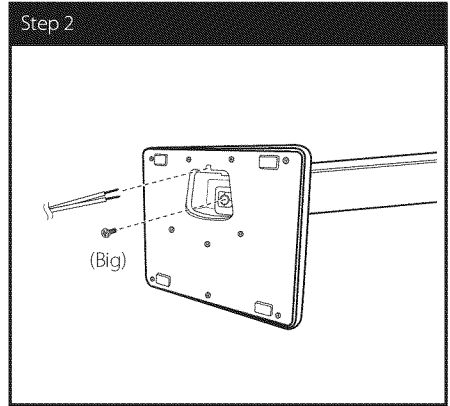

3. Attach the speaker to the pole, then secure the connection with a supplied screw.

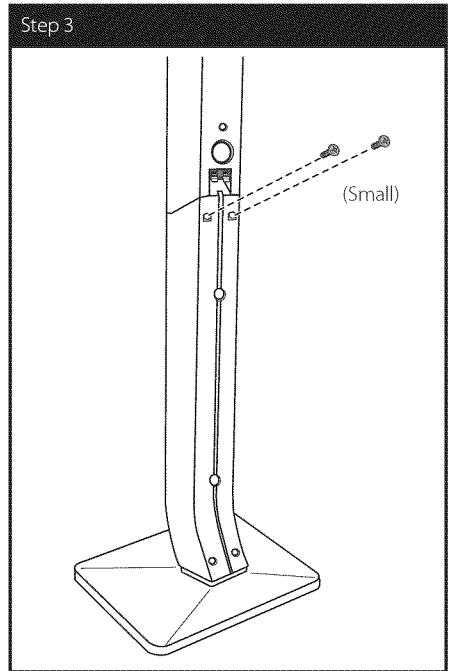



4. Connect the speaker wire to the terminal on the speaker.

Make sure the wire marked black goes in to the terminal marked “-” (minus) and the other wire goes in to the terminal marked “+” (plus).

Step 4

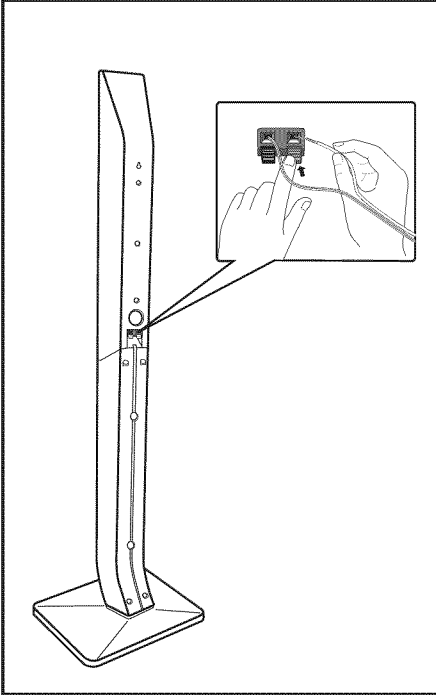
**Caution**

Be careful that the speaker does not fall down. Otherwise it may result in the speaker malfunctioning and causing personal injury and/ or property damage.

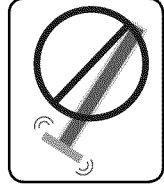

## Positioning the system

The following illustration shows an example of positioning the system. Note that the illustrations in these instructions differ from the actual unit for explanation purposes.

For the best possible surround sound, all the speakers other than the subwoofer should be placed at the same distance from the listening position (A).

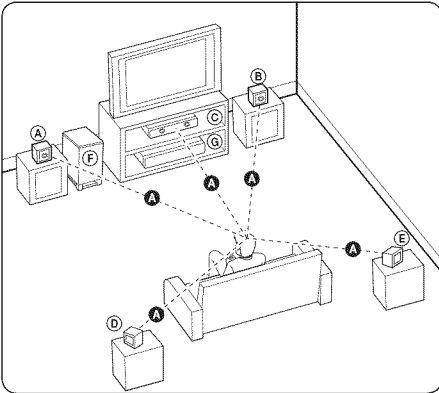

**(A) Front left speaker (L)/**

**(B) Front right speaker (R):**

Place the front speakers to the sides of the monitor or screen and as flush with the screen surface as possible.

**(C) Center speaker:**

Place the center speaker above or below the monitor or screen.

**(D) Surround left speaker (L)/**

**(E) Surround right speaker (R):**

Place these speakers behind your listening position, facing slightly inwards.

**(F) Subwoofer:**

The position of the subwoofer is not so critical, because low bass sounds are not highly directional. But it is better to place the subwoofer near the front speakers. Turn it slightly toward the center of the room to reduce the wall reflections.

**(G) Unit**

### ! Caution

- Be careful to make sure children not to put their hands or any objects into the \*speaker duct.  
\*Speaker duct: A hole for plentiful bass sound on speaker cabinet (enclosure).
- Place the center speaker at a safe distance from the child's reach.  
Otherwise it may result in the speaker falling down and causing personal injury and/or property damage.
- The speakers contain magnetic parts, so colour irregularity may occur on the CRT TV screen or PC monitor screen. Please use the speakers away from the TV screen or PC monitor screen.

# Connecting the System

## Attaching the speakers to the player

1. Connect speaker wires to the player.  
Each speaker wire is color-coded. Use matching color wires for corresponding speakers.

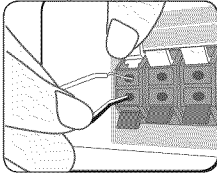

Color	Speaker	Position
Green	Center	Center
Orange	Sub woofer	Any front position
Red	Front	Front right
White	Front	Front left

2. Connect the speaker wire to the terminal on the speaker.

Make sure the wire marked black goes in to the terminal marked "-" (minus) and the other wire goes in to the terminal marked "+" (plus).

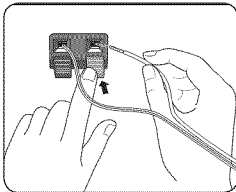

## Attaching the rear speakers to the wireless receiver

Connect the rear speakers to the wireless receiver with the speaker cables.

Make sure the wire marked black goes in to the terminal marked "-" (minus) and the other wire goes in to the terminal marked "+" (plus).

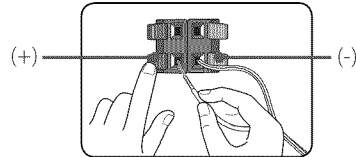

### About Ferrite Core (for EMI only)

Be sure to attach the ferrite core to the speaker cable. This ferrite core can reduce noises.

### How to attach the ferrite core

1. Press the stopper [a] of the ferrite core to open.
2. Wind the speaker cables once on the ferrite core.
3. Close the ferrite core until it clicks. Refer to the fig.3 and comment.

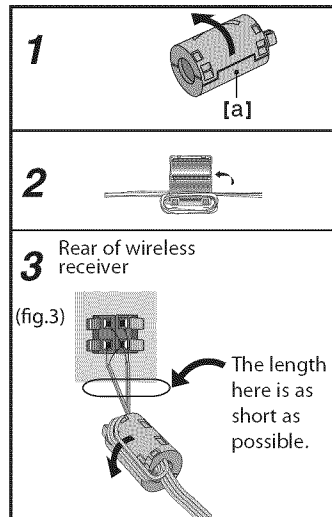

## Wireless connection

When you turn on the player, the wireless connection will be completed automatically.

When the connection is completed, you can see the icon (●) on the display window.

### LED indicator of wireless receiver

LED Color	Operation
Blue (Blink)	The connection is not completed.
Blue	The connection is completed.
Red	The connection is in standby mode or failed.
Off (No display)	The AC power cord is unplugged.

#### Note

- Be sure to match the speaker, cable to the appropriate terminal on the unit: + to + and – to –. If the cables are reversed, the sound will be distorted and will lack bass.
- If there is a strong electromagnetic wave product nearby, interference may occur. Put the unit (Wireless Receiver and main unit) away from there.
- It takes a few seconds (and may take longer) for the player with the built-in wireless transmitter and wireless receiver to communicate with each other.
- The available range is 20 m for wireless connection in an open place.

## Wireless connection, manually

You can set up wireless connection manually, when your connection is not completed.

Refer to the "Connect wireless speakers" on page 36.

## Connecting to Your TV

Make one of the following connections, depending on the capabilities of your existing equipment.

- HDMI connection (page 21)
- Component Video connection (page 23)
- Video connection (page 23)

### Note

- Depending on your TV and other equipment you wish to connect, there are various ways you could connect the player. Use only one of the connections described in this manual.
- Please refer to the manuals of your TV, stereo system or other devices as necessary to make the best connections.
- Make sure the player is connected directly to the TV. Tune the TV to the correct video input channel.
- Do not connect your player via your VCR. The image could be distorted by the copy protection system.

## HDMI Connection

If you have a HDMI TV or monitor, you can connect it to this player using a HDMI cable (Type A, High speed HDMI™ cable with Ethernet). Connect the HDMI jack on the player to the HDMI jack on a HDMI compatible TV or monitor.

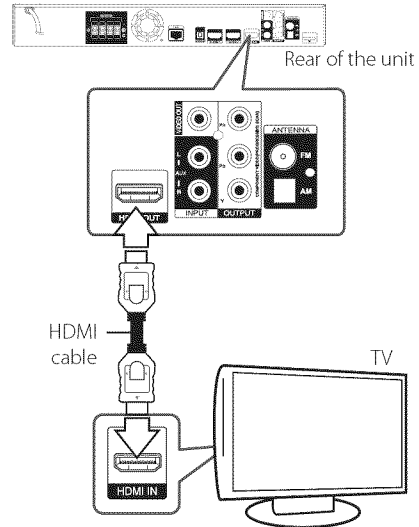

Set the TV's source to HDMI (refer to TV's Owner's manual).

### Additional Information for HDMI

- When you connect a HDMI or DVI compatible device make sure of the following:
  - Try switching off the HDMI/DVI device and this player. Next, switch on the HDMI/DVI device and leave it for around 30 seconds, then switch on this player.
  - The connected device's video input is set correctly for this unit.
  - The connected device is compatible with 720x480p, 1280x720p, 1920x1080i or 1920x1080p video input.
- Not all HDCP-compatible HDMI or DVI devices will work with this player.
  - The picture will not be displayed properly with non-HDCP device.

### ! Note

- If a connected HDMI device does not accept the audio output of the player, the HDMI device's audio sound may be distorted or may not output.
- When you use HDMI connection, you can change the resolution for the HDMI output. (Refer to "Resolution Setting" on page 24.)
- Select the type of video output from the HDMI OUT jack using [HDMI Color Setting] option on the [Setup] menu (see page 34).
- Changing the resolution when the connection has already been established may result in malfunctions. To solve the problem, turn off the player and then turn it on again.
- When the HDMI connection with HDCP is not verified, TV screen is changed to black screen. In this case, check the HDMI connection, or disconnect the HDMI cable.
- If there are noises or lines on the screen, please check the HDMI cable (length is generally limited to 4.5 m(15 ft.)).

## ARC (Audio Return Channel) function

The ARC function enables an HDMI capable TV to send the audio stream to HDMI OUT of this player.

To use this function:

- Your TV must support the HDMI-CEC and ARC function and the HDMI-CEC and ARC must be set to On.
- The setting method of HDMI-CEC and ARC may differ depending on the TV. For details about ARC function, refer to your TV manual.
- You must use the HDMI cable (Type A, High Speed HDMI™ cable with Ethernet).
- You must connect with the HDMI IN that supports the ARC function using the HDMI OUT on this player.
- You can connect only one Home Theater to TV compatible with ARC.

## What is SIMPLINK?



Some functions of this unit are controlled by the TV's remote control when this unit and LG TV's with SIMPLINK are connected through HDMI connection.

Controllable functions by LG TV's remote control; Play, Pause, Scan, Skip, Stop, Power Off, etc.

Refer to the TV owner's manual for the details of SIMPLINK function.

LG TV's with SIMPLINK function has the logo as shown above.

### ! Note

Depending on the disc type or playing status, some SIMPLINK operation may differ from your purpose or not work.

## Component Video Connection

Connect the COMPONENT VIDEO OUT jacks on the player to the corresponding input jacks on the TV using component video cable. You can hear the sound through the system's speaker.

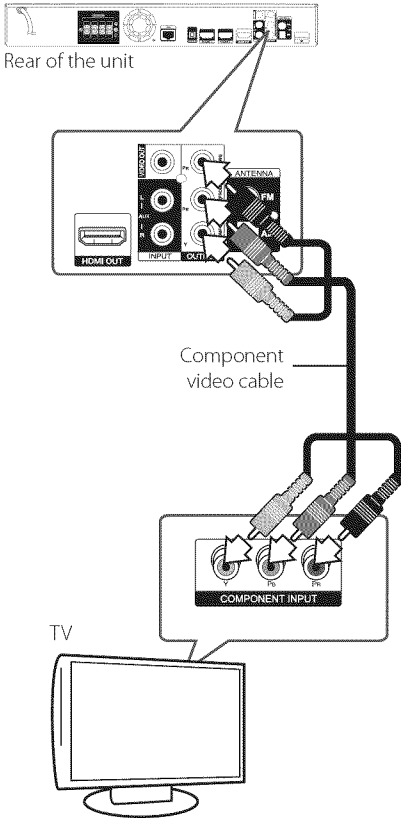

### Note

When you use COMPONENT VIDEO OUT connection, you can change the resolution for the output. (Refer to "Resolution setting" on page 24.)

## Video Connection

Connect the VIDEO OUT jack on the player to the video in jack on the TV using a video cable. You can hear the sound through the system's speakers.

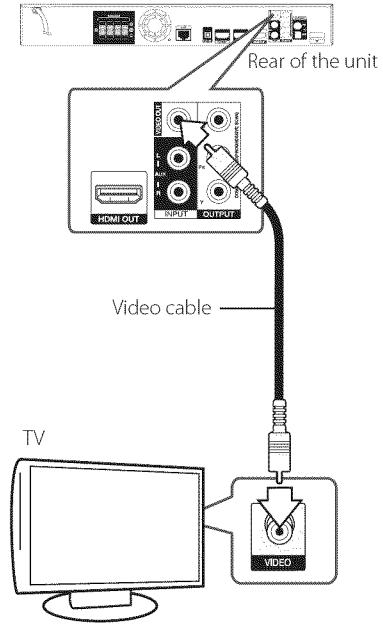

## Resolution Setting

The player provides several output resolutions for HDMI OUT and COMPONENT VIDEO OUTPUT jacks. You can change the resolution using [Setup] menu.

1. Press HOME (🏠).
2. Use </> to select the [Setup] and press ENTER (⊙). The [Setup] menu appears.
3. Use ^/∨ to select [DISPLAY] option then press > to move to the second level.
4. Use ^/∨ to select the [Resolution] option then press ENTER (⊙) to move to the third level.

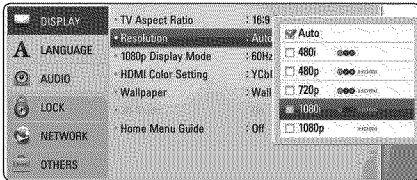

5. Use ^/∨ to select the desired resolution then press ENTER (⊙) to confirm your selection.

### ! Note

- If your TV does not accept the resolution you have set on the player, you can set resolution to 480p as follows:
  1. Press ▲ to open the disc tray.
  2. Press ■ (STOP) for more than 5 seconds.
- Since several factors affect the resolution of video output, see "Video Output Resolution" on page 72

## Antenna connection

Connect the supplied antenna for listening to the radio.

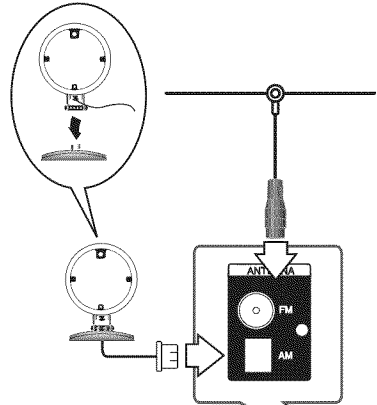

Rear of the unit



### ! Note

- To prevent noise pickup, keep the AM Loop antenna away from the unit and other components.
- After connecting the FM wire antenna, keep it as horizontal as possible. Be sure to fully extend the FM wire antenna.



## Connections with external device

### AUX Connection

You can enjoy the sound from an external component through the speakers of this system.

Connect the analog audio output jacks of your component into the AUX L/R (INPUT) on this unit. And then select the [AUX] option by pressing RADIO&INPUT and ENTER (⊙).

You can also use the F (Function) button on the front panel to select the input mode.

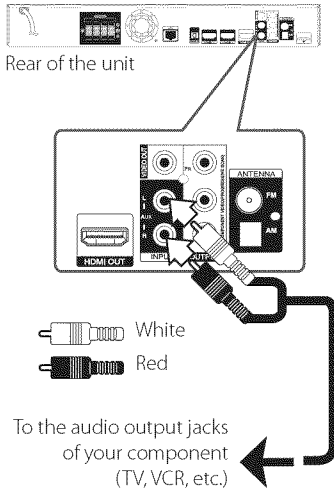

### PORT. IN connection

You can enjoy the sound from your portable audio player through the speakers of this system.

Connect the headphones (or line out) jack of the portable audio player into the PORT. IN socket of this unit. And then select the [PORTABLE] option by pressing RADIO&INPUT and ENTER (⊙).

You can also use the F (Function) button on the front panel to select the input mode.

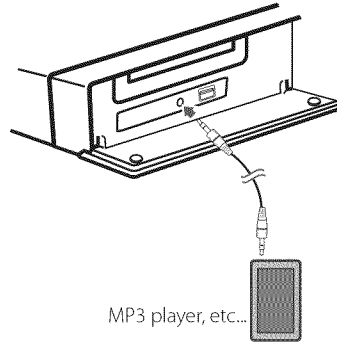

## OPTICAL IN connection

You can enjoy the sound from your component with a digital optical connection through the speakers of this system.

Connect the optical output jack of your component into the OPTICAL IN jack on the unit. And then select the [OPTICAL] option by pressing RADIO&INPUT and ENTER (⊙). Or press OPTICAL to select directly.

You can also use the F (Function) button on the front panel to select the input mode.

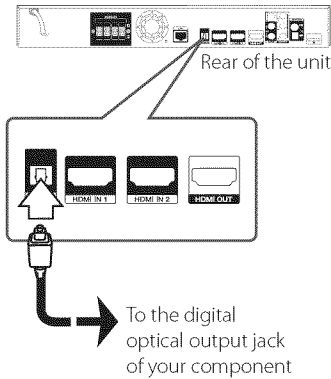

## HDMI IN 1/2 connection

You can enjoy the pictures and sound from your component through this connection.

Connect the HDMI OUT jack of your component into the HDMI IN 1 or 2 jack on this unit. And then select the [HDMI IN 1/2] option by pressing RADIO&INPUT and ENTER (⊙).

You can also use the F (Function) button on the front panel to select the input mode.

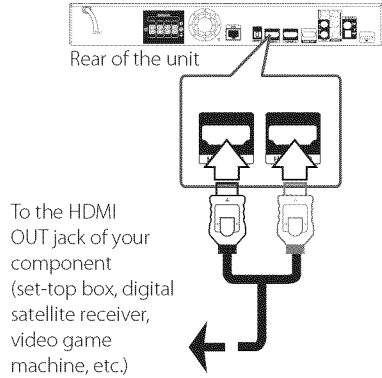

### ! Note

- You cannot change the video resolution in the HDMI IN 1/2 mode. Change the video resolution of the connected component.
- If the video output signal is abnormal when your personal computer is connected to HDMI IN 1/2 jack, change the resolution of your personal computer to 480p, 720p, 1080i or 1080p.
- The video signal from the HDMI input cannot be output from the component or composite video outputs.
- The player sends audio from the HDMI inputs to both the HDMI output and to the unit's speakers.

# Connecting to your Home Network

This player can be connected to a local area network (LAN) via the LAN port on the rear panel or the internal wireless module.

By connecting the unit to a broadband home network, you have access to services such as software updates, BD-LIVE interactivity and on-line content services.

## Wired network connection

Using a wired network provides the best performance, because the attached devices connect directly to the network and are not subject to radio frequency interference.

Please refer to the documentation for your network device for further instructions.

Connect the player's LAN port to the corresponding port on your Modem or Router using a commercially available LAN or Ethernet cable.

### Note

- When plugging or unplugging the LAN cable, hold the plug portion of the cable. When unplugging, do not pull on the LAN cable but unplug while pressing down on the lock.
- Do not connect a modular phone cable to the LAN port.
- Since there are various connection configurations, please follow the specifications of your telecommunication carrier or internet service provider.
- If you want to access content from PCs or DLNA servers, this player must be connected to the same local area network with them via a router.

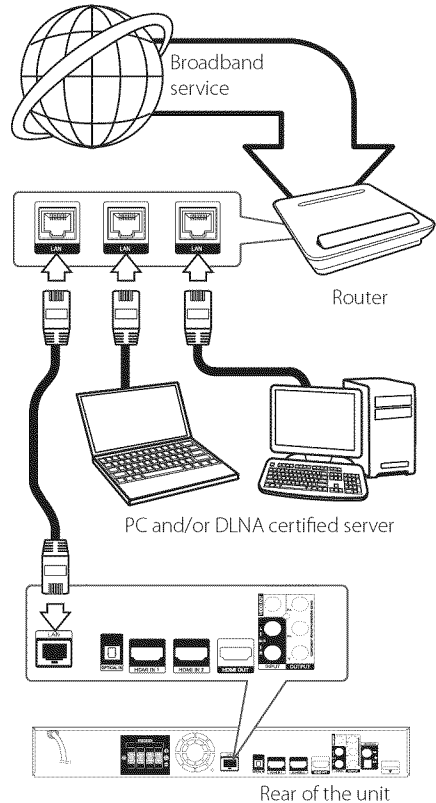

## Wired Network Setup

If there is a DHCP server on the local area network (LAN) via wired connection, this player will automatically be allocated an IP address. After making the physical connection, a small number of home networks may require the player's network setting to be adjusted. Adjust the [NETWORK] setting as follow.

### Preparation

Before setting the wired network, you need to connect the broadband internet to your home network.

1. Select [Connection Setting] option in the [Setup] menu then press ENTER (⊙).

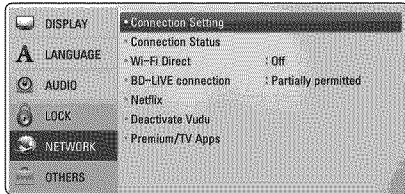

2. The [Connection Setting] menu appear on the screen. Use  $\wedge / \vee$  to select the [Wired] and press ENTER (⊙).

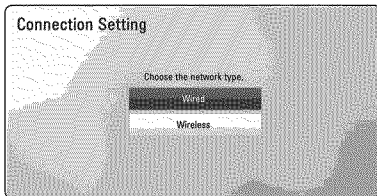

3. Use  $\wedge / \vee / < / >$  to select the IP mode between [Dynamic] and [Static].

Normally, select [Dynamic] to allocate an IP address automatically.

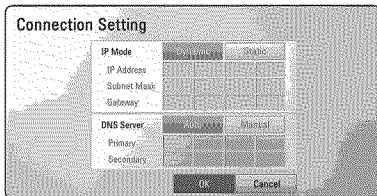

### Note

If there is no DHCP server on the network and you want to set the IP address manually, select [Static] then set [IP Address], [Subnet Mask], [Gateway] and [DNS Server] using  $\wedge / \vee / < / >$  and numerical buttons. If you make a mistake while entering a number, press CLEAR to clear the highlighted part.

4. Select [OK] and press ENTER (⊙) to apply network settings.
5. The player will ask you to test the network connection. Select [OK] and press ENTER (⊙) to complete the network connection.
6. If you select [Test] and press ENTER (⊙) at step 5 above, the network connection status is displayed on the screen.

You can also test it on the [Connection Status] in the [Setup] menu.

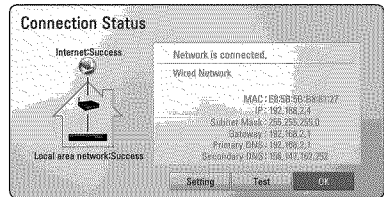

## Wireless Network Connection

Another connection option is to use an Access Point or a wireless router. The network configuration and connection method may vary depending on the equipment in use and the network environment.

This player is equipped with an IEEE 802.11n (Dual-band, 5 GHz and 2.4 GHz band) wireless module, which also supports the 802.11a/b/g standards. For the best wireless performance, we recommend using a IEEE 802.11n certified Wi-Fi network (access point or wireless router).

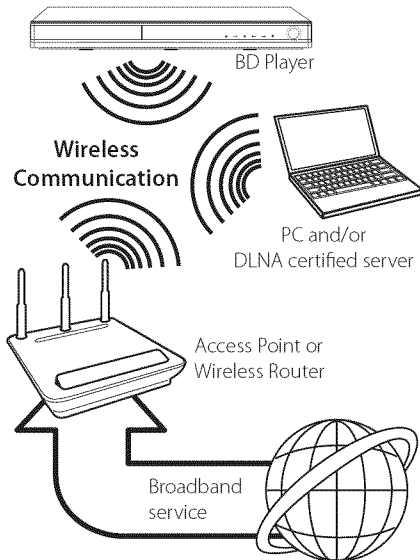

Refer to the setup instructions supplied with your access point or wireless router for detailed connection steps and network settings.

For best performance, a direct wired connection from this player to your home network's router or cable/DSL modem is always the best option. If you do choose to use the wireless option, note that performance can sometimes be affected by other electronic devices in the home.

### Note

Available frequency range and channels for 5 GHz band are listed as below. But, there may have the differences and restrictions depending on the country. Try setting your access point with other channel if you have difficulties in wireless network connection.

Area	Frequency Range
North America	5.15-5.25 GHz (ch. 36-48),
	5.725-5.825 GHz (ch. 149-161), 5.825- 5.850 (ch.165)
Europe	5.15-5.25 GHz (ch. 36-48)
Others	5.15-5.25 GHz (ch. 36-48),
	5.725-5.825 GHz (ch. 149-161), 5.825- 5.850 (ch.165)

## Wireless Network Setup

For the wireless network connection, the player needs to be set up for network communication. This adjustment can be done from the [Setup] menu. Adjust the [NETWORK] setting as follow. Setting up the access point or the wireless router is required before connecting the player to the network.

### Preparation

Before setting the wireless network, you need to:

- connect the broadband internet to the wireless home network.
- set the access point or wireless router.
- note the SSID and security code of the network.

1. Select [Connection Setting] option in the [Setup] menu then press ENTER (Ⓢ).

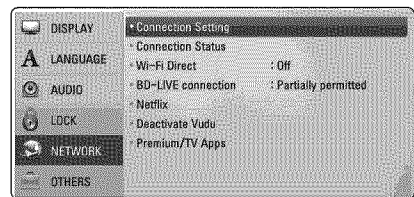

- The [Connection Setting] menu appear on the screen. Use  $\wedge / \vee$  to select [Wireless] and press ENTER (⊙).
- Select [Yes] and press ENTER (⊙) to continue. The new connection settings reset the current network settings.
- The player scans the all available access points or wireless routers within range and display them as a list. Use  $\wedge / \vee$  to select an access point or wireless router on the list, and then press ENTER (⊙).

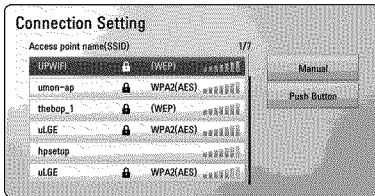

If you have security on your access point or wireless router, verify that the WEP or WPA key that was entered into the player matches the router's information exactly. You need to input the security code as necessary.

### Note

- WEP security mode generally have 4 keys available on an access point or wireless router's setting. If your access point or wireless router use WEP security, enter the security code of the key "No.1" to connect on your home network.
- An Access Point is a device that allows you to connect to your home network wirelessly.
- If your access point or wireless router supports the PIN Code configuration method based on WPS(Wi-Fi Protected Setup), press yellow (Y) colored button and note the code number on the screen. And then, enter the PIN number on a setting menu of your access point or wireless router to connect. Refer to the documentation for your network device.

**[Manual]** – Your access point may not be broadcasting its access point name (SSID). Check your router settings through your computer and either set your router to broadcast SSID, or manually enter the access point name (SSID) in [Manual].

**[Push Button]** – If your access point or wireless router that supports the Push Button Configuration method, select this option and press the Push Button on your access point or wireless router within 120 counts. You do not need to know the access point name (SSID) and security code of your access point or wireless router.

- Use  $\wedge / \vee / < / >$  to select the IP mode between [Dynamic] and [Static]. Normally, select [Dynamic] to allocate an IP address automatically.

### Note

If there is no DHCP server on the network and you want to set the IP address manually, select [Static] then set [IP Address], [Subnet Mask], [Gateway] and [DNS Server] using  $\wedge / \vee / < / >$  and numerical buttons. If you make a mistake while entering a number, press CLEAR to clear the highlighted part.

- Select [OK] and press ENTER (⊙) to apply network settings.
- The player will ask you to test the network connection. Select [OK] and press ENTER (⊙) to complete the network connection.
- If you select [Test] and press ENTER (⊙) at step 7 above, the network connection status is displayed on the screen. You can also test it on the [Connection Status] in the [Setup] menu.

## Notes on Network Connection:

- Many network connection problems during set up can often be fixed by re-setting the router or modem. After connecting the player to the home network, quickly power off and/or disconnect the power cable of the home network router or cable modem. Then power on and/or connect the power cable again.
- Depending on the internet service provider (ISP), the number of devices that can receive internet service may be limited by the applicable terms of service. For details, contact your ISP.
- Our company is not responsible for any malfunction of the player and/or the internet connection feature due to communication errors/malfunctions associated with your broadband internet connection, or other connected equipment.
- The features of BD-ROM discs made available through the Internet Connection feature are not created or provided by our company, and our company is not responsible for their functionality or continued availability. Some disc related material available by the Internet Connection may not be compatible with this player. If you have questions about such content, please contact the producer of the disc.
- Some internet contents may require a higher bandwidth connection.
- Even if the player is properly connected and configured, some internet contents may not operate properly because of internet congestion, the quality or bandwidth of your internet service, or problems at the provider of the content.
- Some internet connection operations may not be possible due to certain restrictions set by the Internet service provider (ISP) supplying your broadband Internet connection.
- Any fees charged by an ISP including, without limitation, connection charges are your responsibility.
- A 10 Base-T or 100 Base-TX LAN port is required for wired connection to this player. If your internet service does not allow for such a connection, you will not be able to connect the player.
- You must use a Router to use xDSL service.
- A DSL modem is required to use DSL service and a cable modem is required to use cable modem service. Depending on the access method of and subscriber agreement with your ISP, you may not be able to use the internet connection feature contained in this player or you may be limited to the number of devices you can connect at the same time. (If your ISP limits subscription to one device, this player may not be allowed to connect when a PC is already connected.)
- The use of a "Router" may not be allowed or its usage may be limited depending on the policies and restrictions of your ISP. For details, contact your ISP directly.
- The wireless network operate at 2.4GHz radio frequencies that are also used by other household devices such as cordless telephone, *Bluetooth*® devices, microwave oven, and can be affected by interference from them.
- Turn off all unused network equipment in your local home network. Some devices may generate network traffic.
- For the purpose of the better transmission, placing the player from the access point as close as possible.
- In some instances, placing the access point or wireless router at least 0.45 m (1.5 ft.) above the floor may improve the reception.
- Move closer to the access point if possible or re-orient the player so there is nothing between it and the access point.
- The reception quality over wireless depends on many factors such as type of the access point, distance between the player and access point, and the location of the player.
- Set your access point or wireless router to Infrastructure mode. Ad-hoc mode is not supported.

## USB device connection

This player can play video, audio and photo files contained in the USB device.

### Playback content in the USB device

1. Insert a USB device to the USB port until it fits into place.

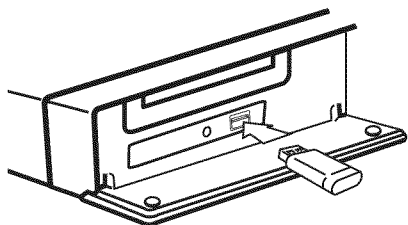

When you connect the USB device on the HOME menu, the player plays a audio file contained in the USB storage device automatically. If the USB storage device is containing various types of files, a menu for the file type selection will appear.

File loading may takes few minutes depending on the number of content stored in the USB storage device. Press ENTER (⊙) while [Cancel] is selected to stop loading.

2. Press HOME (🏠).
3. Select [Movie], [Photo] or [Music] using </>, and press ENTER (⊙).
4. Select the [USB] option using </>, and press ENTER (⊙).

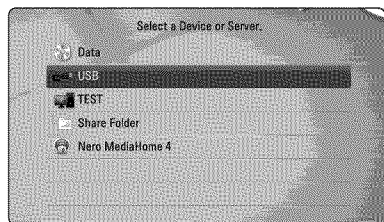

5. Select a file using ^ / v / </>, and press PLAY or ENTER (⊙) to play the file.
6. Withdraw the USB device carefully.

### Note

- This player supports USB flash drive/ external HDD formatted in FAT16, FAT32 and NTFS when accessing files (audio, photo, video). However, for BD-LIVE and Audio CD recording, only FAT16 and FAT32 formats are supported. Use the USB flash drive/ external HDD formatted in either FAT16 or FAT32 when using BD-LIVE and Audio CD recording.
- The USB device can be used for the local storage for enjoying BD-LIVE discs with Internet.
- This unit can support up to 8 partitions of the USB device.
- Do not extract the USB device during operation (play, etc.).
- A USB device which requires additional program installation when you have connected it to a computer, is not supported.
- USB device: USB device that supports USB1.1 and USB2.0.
- Video, audio and photo files can be played. For details of operations on each file, refer to relevant pages.
- Regular back up is recommended to prevent data loss.
- If you use a USB extension cable, USB HUB or USB Multi-reader, the USB device may not be recognized.
- Some USB device may not work with this unit.
- Digital camera and mobile phone are not supported.
- USB Port of the unit cannot be connected to PC. The unit cannot be used as a storage device.



# Settings

## Adjust the Setup Settings

You can change the settings of the player in the [Setup] menu.

1. Press HOME (🏠).

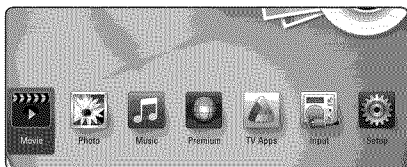

2. Use </> to select the [Setup] and press ENTER (⊙). The [Setup] menu appears.

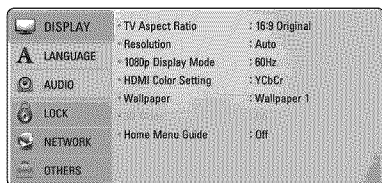

3. Use ^ / v to select the first setup option, and press > to move to the second level.

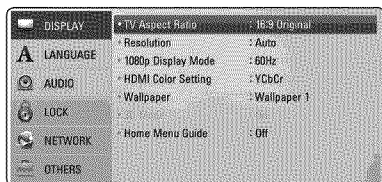

4. Use ^ / v to select a second setup option, and press ENTER (⊙) to move to the third level.

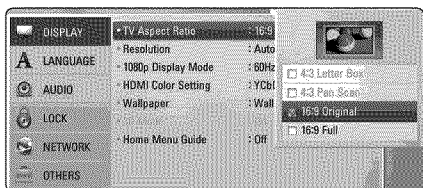

5. Use ^ / v to select a desired setting, and press ENTER (⊙) to confirm your selection.

## [DISPLAY] Menu

### TV Aspect Ratio

Select a TV aspect ratio option according to your TV type.

#### [4:3 Letter Box]

Select when a standard 4:3 TV is connected. Displays theatrical images with masking bars above and below the picture.

#### [4:3 Pan Scan]

Select when a standard 4:3 TV is connected. Displays pictures cropped to fill your TV screen. Both sides of the picture are cut off.

#### [16:9 Original]

Select when a 16:9 wide TV is connected. The 4:3 picture is displayed with an original 4:3 aspect ratio, with black bars appearing at the left and right sides.

#### [16:9 Full]

Select when a 16:9 wide TV is connected. The 4:3 picture is adjusted horizontally (in a linear proportion) to fill the entire screen.

#### ! Note

You cannot select [4:3 Letter Box] and [4:3 Pan Scan] option when the resolution is set to higher than 720p.

## Resolution

Sets the output resolution of the Component and HDMI video signal. Refer to page 24 and 72 for details about the resolution setting.

### [Auto]

If the HDMI OUT jack is connected to TVs providing display information (EDID), automatically selects the resolution best suited to the connected TV.

### [1080p]

Outputs 1080 lines of progressive video.

### [1080i]

Outputs 1080 lines of interlaced video.

### [720p]

Outputs 720 lines of progressive video.

### [480p]

Outputs 480 lines of progressive video.

### [480i]

Outputs 480 lines of interlaced video.

## 1080p Display Mode

When the resolution is set to 1080p, select [24 Hz] for smooth presentation of film material (1080p/24 Hz) with a HDMI-equipped display compatible with 1080p/24 Hz input.

### Note

- When you select [24 Hz], you may experience some picture disturbance when the video switches video and film material. In this case, select [60 Hz].
- Even when [1080p Display Mode] is set to [24 Hz], if your TV is not compatible with 1080p/24 Hz, the actual frame frequency of the video output will be 60 Hz to match the video source format.

## HDMI Color Setting

Select the type of output from the HDMI OUT jack. For this setting, please refer to the manuals of your display device.

### [YCbCr]

Select when connecting to a HDMI display device.

### [RGB]

Select when connecting to a DVI display device.

## Wallpaper

Changes the background of the initial screen.

## 3D Mode

Select the type of output mode for Blu-ray 3D disc playback.

### [Off]

Blu-ray 3D disc playback will output as 2D mode like a normal BD-ROM disc playback.

### [On]

Blu-ray 3D disc playback will output as 3D mode.

## Home Menu Guide

This function allows you to display or delete the guide bubble on the Home Menu. Set this option to [On] for displaying guide.

## [LANGUAGE] Menu

### Display Menu

Select a language for the [Setup] menu and on-screen display.

### Disc Menu/Disc Audio/ Disc Subtitle

Select the language you prefer for the audio track (disc audio), subtitles, and the disc menu.

---

#### [Original]

Refers to the original language in which the disc was recorded.

---

#### [Other]

Press ENTER (Ⓜ) to select another language. Use number buttons then press ENTER (Ⓜ) to enter the corresponding 4-digit number according to the language code list on page 69.

---

#### [Off] (Disc Subtitle only)

Turn off Subtitle.



#### Note

Depending on the disc, your language setting may not work.

## [AUDIO] Menu

### Speaker Setup

To obtain the best possible sound, use the speaker setup display to specify the volume of the speakers you have connected and their distance from your listening position. Use the test to adjust the volume of the speakers to the same level.

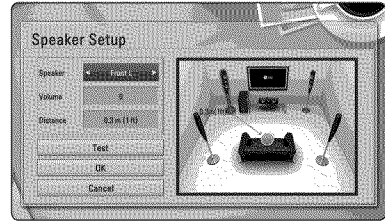

---

#### [Speaker]

Select a speaker that you want to adjust.

---

#### [Volume]

Adjust the output level of each speaker.

---

#### [Distance]

Adjust the distance between each speaker and the listening position.

---

#### [Test/ Stop test tone]

The speakers will emit a test tone.

---

#### [OK]

Confirms the setting.

---

#### [Cancel]

Cancels the setting.

---

## HD AV Sync

Sometimes Digital TV encounters a delay between picture and sound. If this happens you can compensate by setting a delay on the sound so that it effectively 'waits' for the picture to arrive: this is called HD AV Sync. Use U to scroll up and down through the delay amount, which you can set at anything between 0 and 300 ms.

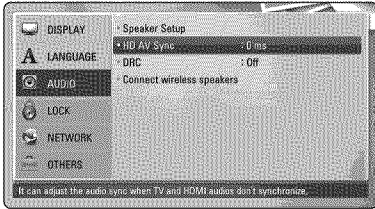

## DRC (Dynamic Range Control)

This function allows you to listen to a movie at a lower volume without losing clarity of sound.

### [Off]

Turns off this function.

### [On]

Compress the dynamic range of the Dolby Digital, Dolby Digital Plus or Dolby TrueHD audio output.

### [Auto]

The dynamic range of the Dolby TrueHD audio output is specified by itself.

And the dynamic range of the Dolby Digital and Dolby Digital Plus are operated as same as the [On] mode.



### Note

The DRC setting can be changed only when a disc is not inserted or the unit is in complete stop mode.

## Connect wireless speakers

When the unit is manufactured, the ID is already set. If interference occurs or you use a new wireless unit, an ID should be set again.

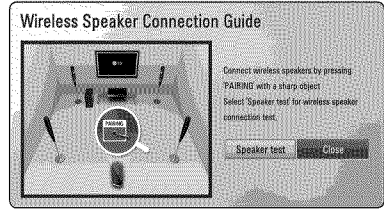

When the [Wireless Speaker Connection Guide] appears, press the PAIRING button on the receiver.

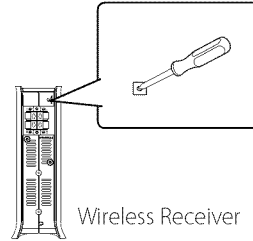

- If you see the blue LED indicator light on the wireless receiver, the pairing was successful. Select the [Speaker test] to test the connection.

## [LOCK] Menu

The [LOCK] settings affect only CinemaNow movie, BD and DVD playback.

To access the any features in [LOCK] settings, you must enter the 4-digit security code you have created.

If you have not entered a password yet, you are prompted to do so. Enter a 4-digit password twice, and press ENTER (⊙) to create a new password.

### Password

You can create or change the password.

#### [None]

Enter a 4-digit password twice, and press ENTER (⊙) to create a new password.

#### [Change]

Enter the current password and press ENTER (⊙). Enter a 4-digit password twice, and press ENTER (⊙) to create a new password.

### If you forget your password

If you forget your password, you can clear it using the following steps:

1. Remove any disc that might be in the player.
2. Select [Password] option in the [Setup] menu.
3. Use Number buttons to enter "210499". The password is cleared.

#### ! Note

If you make a mistake before pressing ENTER (⊙), press CLEAR. Then input the correct password.

## DVD Rating

Blocks playback of rated DVD based on their content. (Not all discs are rated.)

#### [Rating 1-8]

Rating one (1) has the most restrictions and rating eight (8) is the least restrictive.

#### [Unlock]

If you select [Unlock], parental control is not active and the disc plays in full.

## BD Rating

Set an age limit of BD-ROM play. Use number buttons to input an age limit for BD-ROM viewing.

#### [255]

All BD-ROM can be played.

#### [0-254]

Prohibits play of BD-ROM with corresponding ratings recorded on them.

#### ! Note

- The [BD Rating] will be applied only for the BD disc that containing the Advanced Rating Control.
- For the region using MPAA rating level, refer to the table below as an example.

BD Rating	MPAA Rating
0	G
8	PG
13	PG-13
17	R
18	NC-17
255	Not restricted

## Area Code

Enter the code of the area whose standards were used to rate the DVD video disc, based on the list on page 68.

## [NETWORK] Menu

The [NETWORK] settings are needed to use the software update, BD Live and on-line content services.

### Connection Setting

If your home network environment is ready to connect the player, the player needs to be set the wired or wireless network connection for network communication. (See "Connecting to your Home Network" on pages 27-31.)

### Connection Status

If you want to check the network status on this player, select the [Connection Status] options and press ENTER (⊙) to check whether a connection to the network and the internet have been established.

### Wi-Fi Direct

This player is a Wi-Fi Direct™ certified device. Wi-Fi Direct™ is the technology that devices to connect each other without connecting to an Access point or a router. Set this option to [On] for activating the Wi-Fi Direct™ mode. Refer to page 44 for the device connection.

### BD-LIVE connection

You can restrict Internet access when BD-LIVE functions are used.

---

#### [Permitted]

Internet access is permitted for all BD-LIVE contents.

---

#### [Partially permitted]

Internet access is permitted only for BD-LIVE contents which have content owner certificates. Internet access and AACS Online functions are prohibited for all BD-LIVE contents without a certificate.

---

#### [Prohibited]

Internet access is prohibited for all BD-LIVE contents.

---

## Netflix

---

### [Netflix ESN]

Display its unique Netflix ESN (Electronic Serial Number) that allows you to use the Netflix streaming.

---

### [Deactivate Netflix]

Deactivates your player. To activate the Netflix again, contact to the service provider.

---

## Deactivate Vudu

You can deactivate your player from your Vudu account. It is recommended that you do this if you give your player to someone else who should not share your Vudu account.

## Premium/TV Apps

---

### [Country Setting]

Select your area for displaying proper services and contents on the [Premium] and [TV Apps] feature.

---

### [Registration Code]

Display the unique code of this player for servicing [Premium] and [TV Apps] feature.

---

## [OTHERS] Menu

### DivX VOD

ABOUT DIVX VIDEO: DivX® is a digital video format created by DivX, Inc. This is an official DivX Certified® device that plays DivX video. Visit [divx.com](http://divx.com) for more information and software tools to convert your files into DivX video.

ABOUT DIVX VIDEO-ON-DEMAND: This DivX Certified® device must be registered in order to play purchased DivX Video-on-Demand (VOD) movies. To obtain your registration code, locate the DivX VOD section in your device setup menu. Go to [vod.divx.com](http://vod.divx.com) for more information on how to complete your registration.

---

#### [Register]

Displays the registration code of your player.

---

#### [Deregister]

Deactivate your player and display the deactivation code.

---

#### Note

All the downloaded videos from DivX VOD with this player's registration code can only be played back on this unit.

### Auto Power Off

The screen saver appears when you leave the player in Stop mode for about five minutes. If you set this option to [On], the unit automatically turns off within 25 minutes since the Screen Saver is displayed. Set this option to [Off] to leave the screen saver until the unit is operated by the user.

## Initialize

---

### [Factory Set]

You can reset the player to its original factory settings.

---

### [BD Storage Clear]

Initializes the BD contents from the connected USB storage.

---

#### Note

If you reset the player to its original factory settings using [Factory Set] option, you have to set all the activation for the on-line services and network settings again.

---

## Software

---

### [Information]

Displays the current software version.

---

### [Update]

You can update the software by connecting the unit directly to the software update server (see page 65-66).

---

## Disclaimer Notice

Press ENTER (⊙) to view the notice of Network Service Disclaimer.

## Sound Effect

You can select a suitable sound mode. Press SOUND EFFECT repeatedly until the desired mode appears on the front panel display or the TV screen. The displayed items for the equalizer maybe different depending on sound sources and effects.

**[Natural]:** You can enjoy comfortable and natural sound.

**[Bypass]:** Software with multichannel surround audio signals is played according to the way it was recorded.

**[Bass Blast]:** Reinforce the bass sound effect from front left and right speaker and subwoofer.

**[Clear Voice]:** This mode makes voice sound clear, improving the quality of voice sound.

**[Virtual]:** You can enjoy more dynamic sound with improved center channel.

**[Game]:** You can enjoy more virtual sound while playing video games.

**[Night]:** This may be useful when you want to watch movies at low volumes late at night.

**[Up Scaler]:** When listening to MP3 files or other compressed music, you can enhance the sound. This mode is available only to 2 channel sources.

**[Loudness]:** Improves bass and treble sound.

**[User EQ]:** You can adjust the sound by raising or lowering the level of specific frequency.

### Setting the [User EQ]

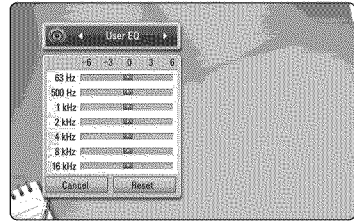

1. Use  $\wedge / \vee$  to select the desired frequency.
2. Use  $< / >$  to select the desired level.

Select [CANCEL] option then press ENTER (⊙) to cancel the setting.

Select [RESET] option then press ENTER (⊙) to reset the all adjustments.

**[Natural Plus]:** You can enjoy the natural sound effect same as 5.1 channel.



## General Playback

### Using [HOME] menu

The home menu appears when you press HOME (🏠). Use  $\wedge / \vee / \langle / \rangle$  to select a category and press ENTER (⊙).

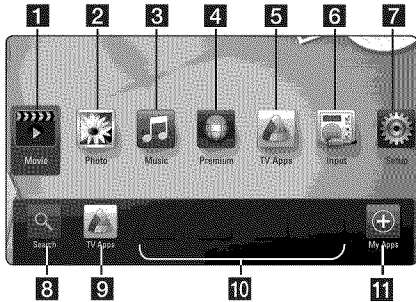

1	[Movie] - Plays video contents.
2	[Photo] - Plays photo contents.
3	[Music] - Plays audio contents.
4	[Premium] - Displays the Premium Home screen.
5	[TV Apps] - Displays the [TV Apps] screen.
6	[Input] - Changes input mode.
7	[Setup] - Adjusts the system settings.
8	[Search] - This function will be updated later.
9	[TV Apps] - Displays the [TV Apps] screen.
10	[Favorite Apps] - Shortcut for user's favorite Apps.
11	[My Apps] - Displays the My Apps screen.

### Playing a Disc

#### BD DVD ACD

1. Press  $\blacktriangle$  (OPEN/CLOSE), and place a disc on the disc tray.
2. Press  $\blacktriangle$  (OPEN/CLOSE) to close the disc tray.  
For the most Audio CD, BD-ROM and DVD-ROM discs, playback starts automatically.
3. Press HOME (🏠).
4. Select [Movie] or [Music] using  $\langle / \rangle$ , and press ENTER (⊙).
5. Select [BD], [DVD], [VR] or [Audio] option using  $\wedge / \vee$ , and press ENTER (⊙).

#### ! Note

- Playback functions described in this manual are not always available in every files and media. Some functions can be restricted depending on many factors.
- Depending on the BD-ROM titles, a USB device connection may be needed for the proper playback.
- Unfinalized DVD VR format discs may not be played in this player.
- Some DVD-VR discs are made with CPRM data by DVD RECORDER. This unit cannot support these kinds of discs.

### Playing a file on a disc/USB device

#### MOVIE MUSIC PHOTO

This player can play video, audio and photo files contained in the disc or USB device.

1. Insert a data disc on the tray or connect a USB device.
2. Press HOME (🏠).
3. Select [Movie], [Photo] or [Music] using  $\langle / \rangle$ , and press ENTER (⊙).
4. Select [Data] or [USB] option using  $\wedge / \vee$ , and press ENTER (⊙).
5. Select a file using  $\wedge / \vee / \langle / \rangle$ , and press  $\blacktriangleright$ (PLAY) or ENTER (⊙) to play the file.

## Playing Blu-ray 3D disc

### BD

This player can play the Blu-ray 3D discs which contains separate views for the left and right eyes.

#### Preparation

In order to playback Blu-ray 3D title in stereoscopic 3D mode, you need to:

- Check your TV is 3D capable and has HDMI 1.4 input(s).
- Wear 3D glasses to enjoy the 3D experience if it is necessary.
- Check whether the BD-ROM title is the Blu-ray 3D disc or not.
- Connect an HDMI cable (High Speed HDMI™ Cable with Ethernet) between the player's HDMI output and TV's HDMI input.

1. Press HOME (🏠), and set the [3D Mode] option on the [Setup] menu to [On] (page 34).
2. Press ▲ (OPEN/CLOSE), and place a disc on the disc tray.
3. Press ▲ (OPEN/CLOSE) to close the disc tray. The playback starts automatically.
4. Refer to the owner's manual of your 3D-ready TV for the further instruction.

You may need to adjust the display settings and focus on your TV's setting for the improved 3D effect.

#### ⚠ Caution

- Watching a 3D content for a long period time may cause dizziness or tiredness.
- It is not recommended to watch a movie in 3D mode for infirm, child and pregnant woman.
- If you are experiencing headache, tiredness or dizziness while viewing contents in 3D, it is strongly recommended to stop the playback and rest until you feel normal.

## Enjoying BD-LIVE

### BD

BD-Video supporting BD-LIVE (BD-ROM version 2 Profile 2) that has a network extension function allows you to enjoy more functions such as downloading new movie trailers by connecting this unit to the internet.

1. Check the network connection and settings (pages 27-31).
2. Insert a USB storage device to the USB port on the front panel.  
A USB storage device is needed to download bonus content.
3. Press HOME (🏠), and set the [BD-LIVE connection] option on the [Setup] menu (page 38).

Depending on a disc, the BD-LIVE function may not be operated if [BD-LIVE connection] option is set to [Partially Permitted].

4. Insert a BD-ROM with BD-LIVE.

The operations are differ depending on the disc. Refer to the manual supplied with the disc.

#### ⚠ Caution

Do not extract the connected USB device while content is being downloaded or a Blu-ray disc is still in the disc tray. Doing so may damage the connected USB device and BD-LIVE features may not operate properly with the damaged USB device anymore. If the connected USB device seems damaged from such an action, you can format the connected USB device from the PC and reuse it with this player.

#### ⓘ Note

- Some BD-LIVE contents may be restrictively accessed in some territories by contents provider's own decision.
- It may take up to several minutes to load and start enjoying BD-LIVE contents.

## Playing a file on a network server

### MOVIE MUSIC PHOTO

This player can play video, audio and photo files located in a PC or a DLNA server through your home network.

1. Check the network connection and settings (pages 27-31).
2. Press HOME (🏠).
3. Select [Movie], [Photo] or [Music] using </>, and press ENTER (⊙).
4. Select a DLNA media server or a share folder on your PC on the list using ^/v/</>, and press ENTER (⊙).

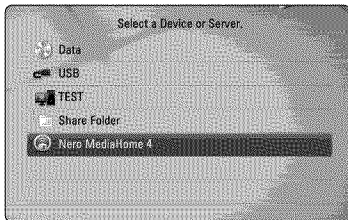

If you want to rescan available media server, press the green (G) colored button.

5. Select a file using ^/v/</>, and press ENTER (⊙) to play the file.

#### ! Note

- The file requirements are described on page 10.
- The thumbnail of the unplayable files can be displayed, but those cannot be played on this player.
- The subtitle file name and video file name have to be the same and located at the same folder.
- The playback and operating quality may be affected by your home network condition.
- You may experience connection problems depending on your server's environment.

## Entering a network user ID and the password

Depending on your PC's environment, you may need to enter a network user ID and the password for accessing a shared folder.

1. The keyboard menu appears automatically if the network user ID and the password are required.
2. Use ^/v/</> to select a character then press ENTER (⊙) to confirm your selection on the virtual keyboard.

To enter a letter with an accent mark, press INFO/DISPLAY (ℹ) to display the extended character set.

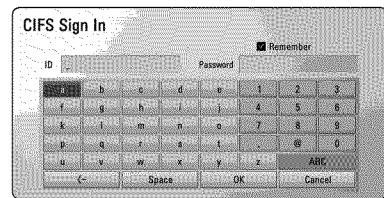

**[Cancel]** – Clear all entered characters.

**[Space]** – Inserts a space at the cursor position.

**[<-]** – Deletes the previous character at the cursor position.

**[ABC / abc / #+==&]** – Change the keyboard menu settings to capital letters, small letters or symbols.

3. When you finish entering the network user ID and password, select [OK] using ^/v/</> and press ENTER (⊙) to access the folder.

The network user ID and password will be remembered after accessing the folder for your convenience. If you do not want the network user ID and password to be remembered, press red (R) colored button to un-tick the [Remember] check box before accessing the folder.

## Connecting to a Wi-Fi Direct™ certified server

### MOVIE MUSIC PHOTO

This player can play video, audio and photo files located in a Wi-Fi Direct™ certified server. The Wi-Fi Direct™ technology make the player to be directly connected to a Wi-Fi Direct™ certified server without connecting to a network device such as access point.

1. Set the [Wi-Fi Direct] option on the [Setup] menu to [On] (page 38).
2. Press HOME (🏠).
3. Select [Movie], [Photo] or [Music] using </>, and press ENTER (⊙).
4. Select a Wi-Fi Direct™ certified server on the list using ^/v, and press ENTER (⊙).

Wi-Fi Direct™ connection will be automatically proceeded.

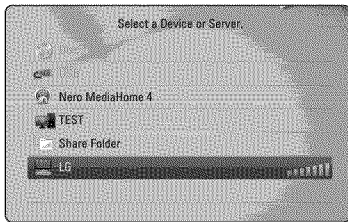

If you want to rescan available media server, press the green (G) colored button.

5. Select a server using ^/v, and press ENTER (⊙) to navigate the server.
6. Select a file using ^/v/</>, and press ENTER (⊙) to play the file.

#### ! Note

- For the purpose of the better transmission, placing the player from the Wi-Fi Direct™ certified server as close as possible.
- If you return to the Home screen after connecting to a Wi-Fi Direct™ device, the connection will be disconnected.

## Basic operations for video and audio content

### To stop playback

Press ■ (STOP) while playback.

### To pause playback

Press || (PAUSE) while playback.  
Press ▶ (PLAY) to resume playback.

### To play frame-by-frame (Video)

Press || (PAUSE) while movie playback.  
Press || (PAUSE) repeatedly to play Frame-by-Frame playback.

### To scan forward or backward

Press ◀◀ or ▶▶ to play fast forward or fast reverse during playback.

You can change the various playback speeds by pressing ◀◀ or ▶▶ repeatedly.

### To slow down the playing speed

While the playback is paused, press ▶▶ repeatedly to play various speeds of slow motion.

### To skip to the next/previous chapter/track/file

During playback, press ◀◀ or ▶▶ to go to the next chapter/track/file or to return to the beginning of the current chapter/track/file.

Press ◀◀ twice briefly to step back to the previous chapter/track/file.

In the file list menu of a server, there may have many types of contents in a folder together. In this case, press ◀◀ or ▶▶ to go to the previous or next content with same type.

## Basic operations for photo content

### To play a slide show

Press ► (PLAY) to start slide show.

### To stop a slide show

Press ■ (STOP) while slide show.

### To pause a slide show

Press || (PAUSE) while slide show.

Press ► (PLAY) to re-start the slide show.

### To skip to the next/previous photo

While viewing a photo in full screen, press < or > to go to the previous or next photo.

## Using the disc menu

**BD DVD AVCHD**

### To display the disc menu

The menu screen may be displayed first after loading a disc which contains a menu. If you want to display the disc menu while playback, press DISC MENU.

Use ▲/▼/◀/▶ buttons to navigate through menu items.

### To display the Pop-up menu

Some BD-ROM discs contain Pop-up menu that appears while playback.

Press TITLE/POPUP while playback, and use ▲/▼/◀/▶ buttons to navigate through menu items.

## Resume playback

**BD DVD AVCHD MOVIE ACD**  
**MUSIC**

The unit records the point where you pressed the ■ (STOP) depending on the disc.

If "||■ (Resume Stop)" appears on the screen briefly, press ► (PLAY) to resume playback (from the scene point).

If you press ■ (STOP) twice or unload the disc, "■ (Complete Stop)" appears on the screen. The unit will clear the stopped point.

### ! Note

- The resume point may be cleared when a button is pressed (for example; ⏻ (POWER), ▲ (OPEN/CLOSE), etc).
- On BD-Video discs with BD-J, the resume playback function does not work.
- If you press ■ (STOP) once during BD-ROM interactive title playback, the unit will be in Complete Stop mode .

## Advanced Playback

### Repeat Playback

**BD DVD AVCHD ACD MUSIC**

During playback, press REPEAT (⏮) repeatedly to select a desired repeat mode.

#### BDs/DVDs

- ⏮ **A-** – Selected portion will be repeated continually.
- ⏮ **Chapter** – The current chapter will be played back repeatedly.
- ⏮ **Title** – The current title will be played back repeatedly.

To return to normal playback, press REPEAT (⏮) repeatedly to select [Off].

#### Audio CDs/Audio files

- ⏮ **Track** – The current track or file will be played back repeatedly.
- ⏮ **All** – All the tracks or files will be played back repeatedly.
- ⏮ **Shuffle** – The tracks or files will be played back in random order.
- ⏮ **Shuffle All** – All the tracks or files will be played back repeatedly in random order.
- ⏮ **A-B** – Selected portion will be repeated continually. (Audio CD only)

To return to normal playback, press CLEAR.

#### ! Note

- If you press ⏮ once during Repeat Chapter/Track playback, the repeat playback cancels.
- This function may not work on some disc or title.

### Repeating a specific portion

**BD DVD AVCHD ACD**

This player can repeat a portion you have selected.

1. While playback, press REPEAT (⏮) to select [A-] at the beginning of the portion you wish to repeat.
2. Press ENTER (⏹) at the end of the portion. Your selected portion will be repeated continually.
3. To return to normal playback, press REPEAT (⏮) repeatedly to select [Off].

#### ! Note

- You cannot select a portion less than 3 seconds.
- This function may not work on some disc or title.

## Marker Search

**BD DVD AVCHD MOVIE**

You can start playback from up to nine memorized points.

### To enter a marker

1. While playback, press MARKER at the desired point. The Marker icon appears on the TV screen briefly.
2. Repeat step 1 to add up to nine markers.

### To recall a marked scene

1. Press SEARCH and the search menu appears on the screen.
2. Press a number button to select a marker number that you want to recall. Playback starts from the marked scene.

### To delete a Marker

1. Press SEARCH and the search menu appears on the screen.



2. Press **V** to highlight a marker number. Use **</>** to select a marked scene that you want to delete.
3. Press CLEAR and the marked scene is erased from the search menu.

#### ! Note

- This function may not work depending on discs, titles, server ability.
- All marked points are cleared if the title is in complete stop (■) mode, the title is changed or if you unload the disc.
- If the total length of the title is less than 10 seconds, this function is not available.

## Using the search menu

**BD DVD AVCHD MOVIE**

Using search menu, you can easily to find the point where you want to start playback.

### To search a point

1. During playback, press SEARCH to display the search menu.



2. Press **</>** to skip the playback 15 seconds forward or backward. You can select a point that you want to skip by pressing and holding **</>** button.

### To start playback from a marked scene

1. Press SEARCH and the search menu appears on the screen.
2. Press **V** to highlight a marker number. Use **</>** to select a marked scene that you want to start playback.
3. Press ENTER (⊙) to start playback from the marked scene.

#### ! Note

- This function may not work depending on discs, titles, server ability.
- This function may not work depending on the file type and ability of the media server.

## Changing content list view

### MOVIE MUSIC PHOTO

On the [Movie], [Music] or [Photo] menu, you can change the content list view.

#### Method 1

Press red (R) colored button repeatedly.

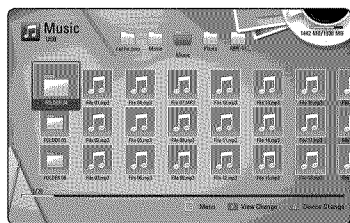
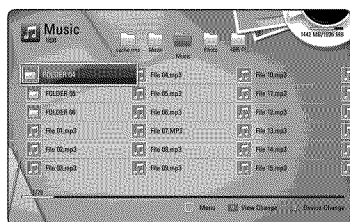
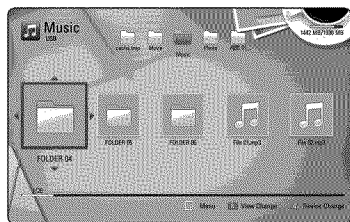

#### Method 2

1. On the content list, press INFO/DISPLAY (I) to display the option menu.
2. Use  $\wedge / \vee$  to select the [View Change] option.
3. Press ENTER (O) to change the content list view.

## Viewing content information

### MOVIE

The player can display the content information.

1. Select a file using  $\wedge / \vee / < / >$ .
2. Press INFO/DISPLAY (I) to display the option menu.
3. Select the [Information] option using  $\wedge / \vee$ , and press ENTER (O).

The file information appears on the screen.

While movie playback, you can display the file information by pressing TITLE/POPUP.

#### ! Note

The information displayed on the screen may not correct comparing actual content information.

## Selecting a subtitle file

### MOVIE

If the subtitle file name is different from the video file name, you need to select the subtitle file on the [Movie] menu before playing the movie.

1. Use  $\wedge / \vee / < / >$  to select the subtitle file you wish to play in the [Movie] menu.
2. Press ENTER (O).

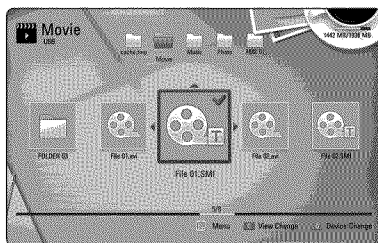

Press ENTER (O) again to deselect the subtitle file. Selected subtitle file will be displayed when you play the video file.

#### ! Note

- If you press ■ (STOP) while playback, the subtitle selection is cancelled.
- This function is not available for playing file on a server via home network.



## Last Scene Memory

### BD DVD

This unit memorizes the last scene from the last disc that is viewed. The last scene remains in memory even if you remove the disc from the unit or switch off the unit. If you load a disc that has the scene memorized, the scene is automatically recalled.

#### ! Note

- Last Scene Memory function for a previous disc is erased once a different disc is played.
- This function may not work depending on the disc.
- On BD-Video discs with BD-J, the last scene memory function does not work.
- This unit does not memorize settings of a disc if you switch off the unit before commencing to play it.

## Applying your photo to the Wallpaper

You can apply your photo to the wallpaper.

1. Press HOME (🏠).
2. Select [Photo] using </>, and press ENTER (⊙).
3. Select [Data] or [USB] option using ^/v, and press ENTER (⊙).
4. Select a photo file, and press INFO/DISPLAY (ℹ) to display the option menu.
5. Use ^/v to select [Wallpaper], and press ENTER (⊙) to apply.

The photo will be set as [Wallpaper 5] on the [Setup] menu.

## Options while viewing a photo

### PHOTO

You can use various options during viewing a photo in full screen.

1. While viewing a photo in full screen, press INFO/DISPLAY (ℹ) to display the option menu.
2. Select an option using ^/v.

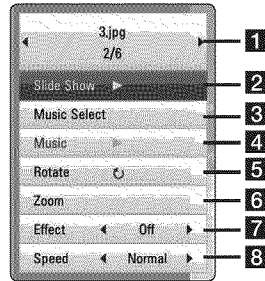

**1** **Current photo/Total number of photos**  
– Use </> to view previous/next photo.

**2** **Slide Show** – Press ENTER (⊙) to start or pause slide show.

**3** **Music Select** – Select the background music for the slide show (page 50).

**4** **Music** – Press ENTER (⊙) to start or pause background music.

**5** **Rotate** – Press ENTER (⊙) to rotate the photo clockwise.

**6** **Zoom** – Press ENTER (⊙) to display the [Zoom] menu.

**7** **Effect** – Use </> to select a transition effect between photos in a slide show.

**8** **Speed** – Use </> to select a delaying speed between photos in a slide show.

3. Press BACK (⏪) to exit the option menu.

## Listening to music while slide show

### PHOTO

You can display photo files while listening to audio files.

1. While viewing a photo in full screen, press INFO/DISPLAY (□) to display the option menu.
2. Use  $\wedge/\vee$  to select [Music Select] option, and press ENTER (⊙) to display the [Music Select] menu.
3. Use  $\wedge/\vee$  to select a device, and press ENTER (⊙).

Device that you can select are differ depending on the location of the photo file you are displaying in full screen.

Photo location	Available Device
Disc, USB	Disc, USB
Share Folder (PC)	Share Folder (PC)
DLNA server	DLNA server

4. Use  $\wedge/\vee$  to select a file or a folder you wish to play.

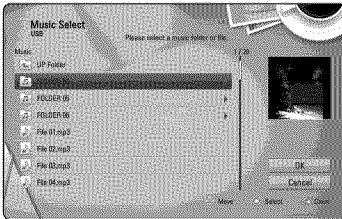

Select  $\square$  and press ENTER (⊙) to display the upper directory.

### Note

When selecting audio file from a server, folder selection is not available. Only file selection is available.

5. Use  $\triangleright$  to select [OK], and press ENTER (⊙) to complete music selection.

## On-Screen display

You can display and adjust various information and settings about the content.

### Displaying content information on-screen

#### BD DVD AVCHD MOVIE

1. While playback, press INFO/DISPLAY (□) to show various playback information.

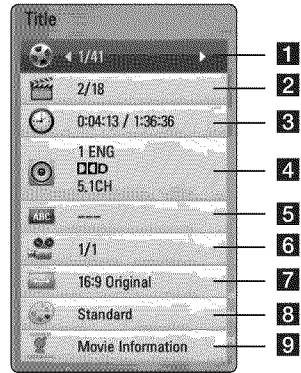

**1 Title** – current title number/total number of titles

**2 Chapter** – current chapter number/total number of chapters

**3 Time** – elapsed playing time/total playback time

**4 Audio** – selected audio language or channel

**5 Subtitle** – selected subtitle.

**6 Angle** – selected angle/total number of angles

**7 TV Aspect Ratio** – selected TV aspect Ratio

**8 Picture Mode** – selected picture mode

**9 Movie Information** – Select this option and press ENTER (⊙) to display movie information from Gracenote Media Database (BD/DVD only).

2. Select an option using  $\wedge / \vee$ .
3. Use  $\langle / \rangle$  to adjust the selected option value.
4. Press BACK (↶) to exit the On-Screen display.

### ! Note

- If no button is pressed for a few seconds, the on-screen display disappears.
- A title number cannot be selected on some discs.
- Available items may differ depending on discs or titles.
- If BD interactive title is playing back, some setting information is displayed on the screen but prohibited to be changed.
- To use the [Movie Information] option, the player must be connected to the broadband internet for accessing the Gracenote Media Database.
- If the information from the Gracenote Media Database is either not correct or does not exist, please contact [www.gracenote.com](http://www.gracenote.com) for support.
- LG is a licensee of Gracenote technology and is not responsible or reliable for information from the Gracenote Media Database.

## Playing from selected time

### BD DVD AVCHD MOVIE

1. Press INFO/DISPLAY (ℹ) during playback. The time search box shows the elapsed playing time.
2. Select the [Time] option and then input the required start time in hours, minutes, and seconds from left to right.  
For example, to find a scene at 2 hours, 10 minutes, and 20 seconds, enter "21020".  
Press  $\langle / \rangle$  to skip the playback 60 seconds forward or backward.
3. Press ENTER (⊙) to start playback from selected time.

### ! Note

- This function may not work on some disc or titles.
- This function may not work depending on the file type and ability of the DLNA server.

## Hearing a different audio

### BD DVD AVCHD MOVIE

1. During playback, press INFO/DISPLAY (ℹ) to display the On-Screen display.
2. Use  $\wedge / \vee$  to select the [Audio] option.
3. Use  $\langle / \rangle$  to select desired audio language, audio track or audio channel.

### ! Note

- Some discs allow you to change audio selections only via the disc menu. In this case, press TITLE/POP-UP or DISC MENU button and choose the appropriate audio from the selections on the disc menu.
- Immediately after you have switched sound, there may be a temporary discrepancy between the display and actual sound.
- On BD-ROM disc, the multi audio format (5.1CH or 7.1CH) is displayed with [MultiCH] in the on-screen display.

## Selecting a subtitle language

**BD DVD AVCHD MOVIE**

1. During playback, press INFO/DISPLAY (□) to display the On-Screen display.
2. Use  $\wedge / \vee$  to select the [Subtitle] option.
3. Use  $\langle / \rangle$  to select desired subtitle language.
4. Press BACK (⏪) to exit the On-Screen display.

### ! Note

Some discs allow you to change subtitle selections only via the disc menu. If this is the case, press TITLE/POPUP or DISC MENU button and choose the appropriate subtitle from the selections on the disc menu.

## Watching from a different angle

**BD DVD**

If the disc contains scenes recorded at different camera angles, you can change to a different camera angle during playback.

1. During playback, press INFO/DISPLAY (□) to display the On-Screen display.
2. Use  $\wedge / \vee$  to select the [Angle] option.
3. Use  $\langle / \rangle$  to select desired angle.
4. Press BACK (⏪) to exit the On-Screen display.

## Changing the TV Aspect Ratio

**BD DVD AVCHD MOVIE**

You can change the TV aspect ratio setting while playback.

1. During playback, press INFO/DISPLAY (□) to display the On-Screen display.
2. Use  $\wedge / \vee$  to select the [TV Aspect Ratio] option.
3. Use  $\langle / \rangle$  to select desired option.
4. Press BACK (⏪) to exit the On-Screen display.

### ! Note

Even if you change the value of the [TV Aspect Ratio] option in On-Screen display, the [TV Aspect Ratio] option in the [Setup] menu is not changed.

## Changing subtitle code page

**MOVIE**

If the subtitle is displayed in broken letter, you can change the subtitle code page to view the subtitle file properly.

1. During playback, press INFO/DISPLAY (□) to display the playback menu.
2. Use  $\wedge / \vee$  to select the [Code Page] option.
3. Use  $\langle / \rangle$  to select desired code option.

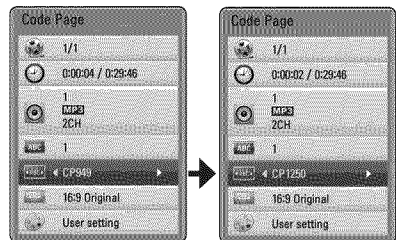

4. Press BACK (⏪) to exit the On-Screen display.

## Changing the Picture Mode

### BD DVD AVCHD MOVIE

You can change the [Picture mode] option while playback.

1. During playback, press INFO/DISPLAY (□) to display the On-Screen display.
2. Use  $\wedge / \vee$  to select the [Picture Mode] option.
3. Use  $\lt / \gt$  to select desired option.
4. Press BACK (⏪) to exit the On-Screen display.

### Setting the [User] option

1. During playback, press INFO/DISPLAY (□) to display the On-Screen display.
2. Use  $\wedge / \vee$  to select the [Picture Mode] option.
3. Use  $\lt / \gt$  to select the [User setting] option, and press ENTER (⊙).

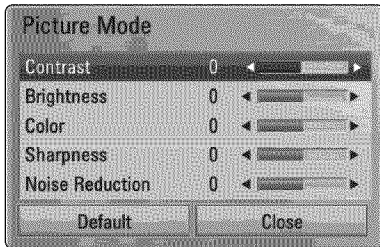

4. Use  $\wedge / \vee / \lt / \gt$  to adjust the [Picture Mode] options.  
Select [Default] option then press ENTER (⊙) to reset the all video adjustments.
5. Use  $\wedge / \vee / \lt / \gt$  to select the [Close] option, and press ENTER (⊙) to finish setting.

## Audio CD Recording

You can record one desired track or all of the tracks in Audio CD to a USB storage device.

1. Insert a USB storage device to the USB port on the front panel.
2. Press **▲** (OPEN/CLOSE), and place an Audio CD on the disc tray.

Press **▲** (OPEN/CLOSE) to close the disc tray. The playback starts automatically.

3. Press INFO/DISPLAY (**□**) to display the option menu.

Or

Press **●** REC button on the remote control. You can record all musics in the audio CD.

4. Use **▲/▼** to select [CD Recording] option, and press ENTER (**⊙**).
5. Use **▲/▼** to select a track you wish to copy on the menu, and press ENTER (**⊙**).

Repeat this step to select tracks as many as you can.

<b>Select All</b>	Selects all the tracks on an Audio CD.
<b>Option</b>	Selects an encoding option from the pop-up menu (128kbps, 192kbps, 320kbps or Lossless).
<b>Close</b>	Cancels the recording and returns to the previous screen.

6. Use **▲/▼/◀/▶** to select [Start], and press ENTER (**⊙**).
7. Use **▲/▼/◀/▶** to select a destination folder to be copied.

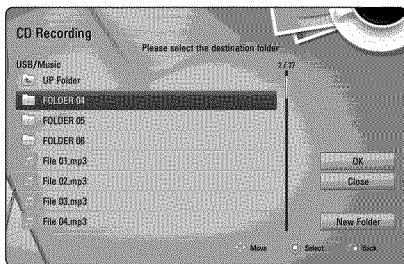

If you want to create a new folder, use **▲/▼/◀/▶** to select [New Folder] and press ENTER (**⊙**).

Enter a folder name using virtual keyboard, and press ENTER (**⊙**) while [OK] is selected.

8. Use **▲/▼/◀/▶** to select [OK], and press ENTER (**⊙**) to start Audio CD recording.

If you want to stop in progressing Audio CD recording, press ENTER (**⊙**) while [Cancel] is highlighted.

9. A message appears when Audio CD recording is completed. Press ENTER (**⊙**) to check the audio file created in the destination folder.

### ! Note

- The table below shows the average recording time from an audio track with 4 minutes of playback time to a audio file with 192 kbps as an example.

stop mode	while playback
1.4 min.	2 min.

- Recording times in the table above are approximate.
- Actual recording time for USB storage device varies depending on the USB storage device's ability.
- Make sure that there is minimum of 50 MB free space is needed when recording into the USB storage device.
- The length of the audio should be longer than 20 seconds for the proper recording.
- Do not turn off this player or extract the connected USB storage device during Audio CD recording.

### ! Caution

The recording or copying features on this player are provided for your personal and noncommercial use. The making of unauthorized copies of copy-protected material, including computer programs, files, broadcasts and sound recordings, may be an infringement of copyrights and constitute a criminal offense. This equipment should not be used for such purposes. LG expressly disclaims any responsibility for illegal distribution or use of unauthorized content in commercial purpose.

**Be Responsible  
Respect Copyrights**

## Viewing information from Gracenote Media Database

The player can access the Gracenote Media Database and loads the music information so that Track name, Artist Name, Genre and other text information can be displayed on the list.

### Audio CD

When you insert an Audio CD, the player starts playback automatically and load the music title from the Gracenote Media Database.

If there is no music information from the database, music titles will not appear on the screen.

### Audio file

1. Select a audio file or audio track using  $\wedge / \vee / < / >$ .
2. Press INFO/DISPLAY ( $\square$ ) to display the option menu.
3. Select the [Information] option using  $\wedge / \vee$ , and press ENTER ( $\odot$ ).

The player accesses to Gracenote Media Database for the music information.

### Blu-ray Disc/DVD/Video file

While listening to a music from the movie being played, press MUSIC ID to start loading the music information from the Gracenote Media Database.

### Note

- The player must be connected to the broadband internet for accessing the Gracenote Media Database.
- If the music information is not in the Gracenote Media Database, message appears on the screen.
- If the information from the Gracenote Media Database is either not correct or does not exist, please contact [www.gracenote.com](http://www.gracenote.com) for support.
- Depending on the cases, it will takes a few minutes to load music information from the Gracenote Media Database.
- Information may be displayed in broken letters, if the language you selected is not available on the Gracenote Media Database.
- This function is not available for on-line content and content in DLNA servers.
- LG is a licensee of Gracenote technology and is not responsible or reliable for information from the Gracenote Media Database.
- Audio CDs that users made for their only private purposes cannot be supported in this feature because they are not in the Gracenote Media Database.

## Playing the iPod

You can enjoy the sound with your iPod. For details about iPod, refer to the iPod's User Guide.

### Preparation

- To view iPod's Videos and Photos on the TV screen.
    - Be sure to use the video connection through the VIDEO OUT jack on the rear panel of this unit. Select the appropriate video input mode on the TV.
    - Depending on the iPod, make sure that select Videos > Video settings, and then set TV Out to Ask or On from your iPod. For details about Video Settings, refer to the iPod User Guide.
    - The viewing photos is available only if this unit is in iPod IN mode and you can view photos only as a slide show. You have to start a slide show on your iPod to view a photo on a TV. For details about a slide show, refer to the iPod User Guide.
  - Before connecting the iPod, turn this unit off and reduce the volume of this unit to its minimum.
1. Connect the cradle so that the mark ▼ is downwards. Put your iPod on it. Connect the iPod firmly. If you turn this unit on, your iPod is automatically turned on and recharging starts.

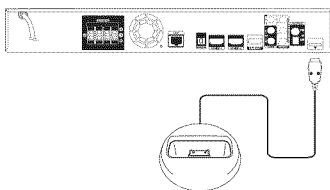

When you connect the iPod on the HOME menu, the player plays a music automatically. Or a menu for the file type selection will appear.

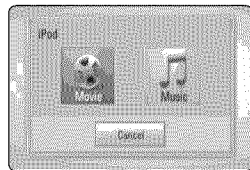

2. Select a file using  $\wedge / \vee / \langle / \rangle$ , and press ENTER (⊙) to play the file.

### Enjoying iPod on the screen

1. Connect the iPod firmly.
2. Press HOME (🏠).
3. Select [Music] or [Movie] using  $\langle / \rangle$ , and press ENTER (⊙).  
If you connected the other device (CD or USB), select the iPod on the menu.
4. Select a content using  $\wedge / \vee / \langle / \rangle$ , and press ENTER (⊙) to play.

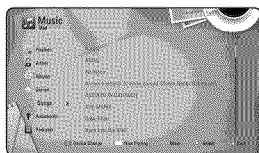

You can search easily a content by power scroll on the screen.

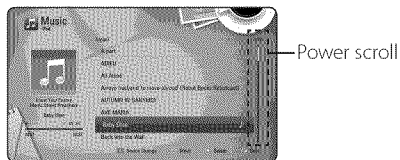

#### ! Note

If the iPod's OSD language is selected to simple chinese, the power scroll function is not operated correctly.



## Enjoying the iPod IN mode

You can operate your iPod by using the supplied remote control and controls on your iPod.

1. Connect the cradle so that the mark ▼ is downwards. Put your iPod on it.  
Connect the iPod firmly.  
If you turn this unit on, your iPod is automatically turned on and recharging starts.
2. Press RADIO&INPUT to select iPod IN mode.

▲ / ▼ / < / >	Selects an option in the menu.
▶ / ENTER	Starts playback the music or video.
	To pause while it is playing. To resume playing, press ▶ (PLAY) again.
◀◀▶▶	Fast-forward or rewind a song or video
◀◀▶▶▶	Skip the playback forward or backward .
REPEAT	To select a desired repeat mode: Track (🔁), All (🔁), Off (No display).

### Note

- An error message “CHECK IPOD” or “Connected iPod model is not supported.” appears when:
  - your iPod is not available for the function to be operated.
- An error message “CHECK IPOD” or “Please update iPod’s software.” appears when:
  - your iPod has an old software version.
    - ➔ Update your iPod software to latest version.
- If this unit displays an error message, follow the message. An error message “CHECK IPOD” or “Please check your iPod.” appears when:
  - the communication between this unit and your iPod is failed.
    - ➔ Undo & re-dock your iPod in this unit.
  - your iPod is not connected firmly.
  - this unit recognises your iPod as unknown device.
  - your iPod is exceptionally low on power.
    - ➔ The battery needs to be charged.
    - ➔ If you charge the battery while iPod is extremely low in power, it may take longer to charge.
- Compatibility with your iPod may vary depending on the type of your iPod.
- iPod touch and iPhone have any difference in operation other than iPod. You may need any additional control to use them with this unit. (e.g. “slide to unlock”)
- If you use an application, make a call, or send and receive SMS text message, etc. on iPod touch or iPhone, disconnect it from iPod dock of this unit and then use it.
- Depending on your iPod’s software version, it may not be possible to control your iPod from this unit. We recommend installing the latest software version.
- The video quality depends on the video sources on your iPod.
- If you have a problem with your iPod, please visit [www.apple.com/support/ipod](http://www.apple.com/support/ipod).

## Radio Operations

Be sure that the antennas are connected.  
(Refer to the page 24)

### Listening to the radio

1. Press RADIO&INPUT until TUNER (FM/AM) appears in the display window. The last received station is tuned in.
2. Press and hold TUNING (-/+) for about two seconds until the frequency indication starts to change. Scanning stops when the unit tunes in a station. Or Press TUNING (-/+) repeatedly.
3. Adjust the volume by rotating VOLUME on the front panel or by pressing VOL (+/-) on the remote control.

### Presetting the Radio Stations

You can preset 50 stations for FM/AM.  
Before tuning, make sure that you have turned down the volume.

1. Press RADIO&INPUT until the TUNER (FM/AM) appears in the display window.
2. Select the desired frequency by using TUNING (-/+).
3. Press ENTER (⊙) a preset number will flash in the display window.
4. Press PRESET (-/+) to select the preset number you want.
5. Press ENTER (⊙). The station is stored.
6. Repeat the steps 2 to 5 to store other stations.

### Deleting a saved station

1. Press PRESET (- / +) to select a preset number you want to delete.
2. Press CLEAR, the preset number will blink in the display window.
3. Press CLEAR again, to delete the selected preset number.

### Deleting all the saved stations

Press and hold CLEAR for two seconds.  
"ERASE ALL" will flash up. Press CLEAR again. Then all the saved stations are deleted.

### Improving poor FM reception

Press B (blue) (MONO/STEREO) colored button on the remote control. This will change the tuner from stereo to mono and usually improve the reception.

## Using the Premium

You can use various content services via Internet with the Premium feature.

1. Check the network connection and settings (pages 27-31).
2. Press HOME (🏠).
3. Select the [Premium] using </>, and press ENTER (⊙).



4. Select an on-line service using ^ / v / </>, and press ENTER (⊙).

### ! Note

- Detailed information of each service, contact to the content provider or visit support link of the service.
- The content of Premium services and service related information, including user interface, is subject to changes. Please refer to the web site of each service for most up-to-date information.
- Using Premium features with wireless network connection may result in improper streaming speed by interference from household devices that are using radio frequencies.
- When you are first time to access [Premium] or [TV apps] feature, current country setting appears. If you want to change the country setting, select [EDIT] and press ENTER (⊙).

## Using the TV Apps

You can use the LG application services on this player via Internet. You can easily find and download various applications from LG App store.

1. Check the network connection and settings (pages 27-31).
2. Press HOME (🏠).
3. Select the [TV Apps] using </>, and press ENTER (⊙).

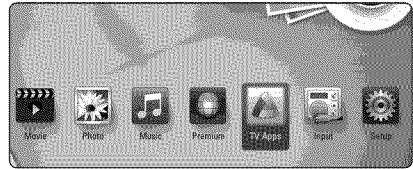

4. Select a category using </>, and press ENTER (⊙).
5. Use ^ / v / </> to select an application, and press ENTER (⊙) to display the information.
6. Press ENTER (⊙) while [Install] icon is highlighted. The application will be installed to the player.

To install an application to the player, user needs to sign in. Refer to page 60 for more information of signing in.

7. Press yellow (Y) colored button to display the [My Apps] screen.
8. Select the installed application and press ENTER (⊙) to execute it.

### ! Note

To install a paid application, you need to be a paid member. Visit [www.lgtvapp.com](http://www.lgtvapp.com) for more information.

## Signing in

To use the [TV Apps] feature, you need to sign in with your account.

1. On the [TV Apps] or [My Apps] screen, press red (R) colored button.
2. Fill the [ID] and [Password] field using the virtual keyboard.  
If you do not have an account, press red (R) colored button to register.
3. Use  $\wedge / \vee / < / >$  to select [OK], and press ENTER (⊙) to sign in with your account.

If you select the [Auto Sign In] check box, your ID and password are remembered and automatically signed in without entering them.

### ! Note

- If you want to sign in with other account, press red (R) colored button on [TV Apps] or [My Apps] screen, and select [Change User] option.
- To view the information of your account and applications, press red (R) colored button on [TV Apps] or [My Apps] screen, and select [Account Setting] option.

## Managing my Apps

You can move or delete an installed application in the [My Apps] menu.

### Move an application

1. Select an application, and press green (G) colored button to display the options.
2. Use  $\wedge / \vee$  to select [Move], and press ENTER (⊙).
3. Use  $\wedge / \vee / < / >$  to select a position you want to move to, and press ENTER (⊙).

### Delete an application

1. Select an application, and press green (G) colored button to display the options.
2. Use  $\wedge / \vee$  to select [Delete], and press ENTER (⊙).
3. Use  $< / >$  to select [Yes], and press ENTER (⊙) to confirm.

# Troubleshooting

## General

Symptom	Cause & Solution
The Power does not turned on.	<ul style="list-style-type: none"> <li>• Plug the power cord into the wall outlet securely.</li> </ul>
The unit does not start playback.	<ul style="list-style-type: none"> <li>• Insert a playable disc. (Check the disc type, color system, and regional code.)</li> <li>• Place the disc with the playback side down.</li> <li>• Place the disc on the disc tray correctly inside the guide.</li> <li>• Clean the disc.</li> <li>• Cancel the Rating function or change the rating level.</li> </ul>
The angle cannot be changed.	<ul style="list-style-type: none"> <li>• Multi-angles are not recorded on the DVD Video being played.</li> </ul>
Cannot play video, photo or audio files.	<ul style="list-style-type: none"> <li>• The files are not recorded in a format that the unit can play.</li> <li>• The unit does not support the codec of the video file.</li> </ul>
The remote control does not work properly.	<ul style="list-style-type: none"> <li>• The remote control is not pointed at the remote sensor of the unit.</li> <li>• The remote control is too far from the unit.</li> <li>• There is an obstacle in the path of the remote control and the unit.</li> <li>• The batteries in the remote control are exhausted.</li> </ul>
The unit is plugged in, but the power will not turn on or off.	<p>You can reset the unit as follows.</p> <ol style="list-style-type: none"> <li>1. Press and hold the POWER button for at least five seconds. This will force the unit to power off then turn the unit back on.</li> <li>2. Unplug the power cord, wait at least five seconds, and then plug it in again.</li> </ol>
The unit is not operating normally.	

## Network

Symptom	Cause & Solution
BD-LIVE feature does not work.	<ul style="list-style-type: none"> <li>The connected USB storage may not have enough space. Connect the USB storage with at least 1GB free space.</li> <li>Ensure that the unit is correctly connected to the local area network and can access the internet (see page 27-31).</li> <li>Your broadband speed may not fast enough to use the BD-LIVE features. Contact your Internet Service Provider (ISP) and increase the broadband speed is recommended.</li> <li>The [BD-LIVE connection] option in the [Setup] menu is set to [Prohibited]. Set the option to [Permitted].</li> </ul>
Streaming video services (such as YouTube™, etc.) are often stopped or “buffer” during playback.	<ul style="list-style-type: none"> <li>Your broadband service speed may not be fast enough to stream video services. Contact your Internet Service Provider (ISP) and increase the broadband speed is recommended.</li> </ul>
Shared folder or files from your PC or a media server are not displayed on the device list.	<ul style="list-style-type: none"> <li>The firewall or anti-virus software on your media server is running. Turn off the firewall or anti-virus software running on your PC or media server.</li> <li>The player is not connected to the local area network that your PC or the media server are connected.</li> </ul>
Cannot connect the player to the access point or wireless LAN router.	<ul style="list-style-type: none"> <li>The wireless communication may be interrupted from household devices that are using radio frequencies. Move the player away from them.</li> </ul>
Access point is not displayed on the “Access point name” list.	<ul style="list-style-type: none"> <li>The access point or wireless LAN router may not broadcast its SSID. Set your access point to broadcast its SSID through your computer.</li> <li>Your network device such as access point may not set with available frequency range and channel that this player can support. Try setting the frequency range and channel on the network device setting.</li> </ul>

## Picture

Symptom	Cause & Solution
There is no picture.	<ul style="list-style-type: none"> <li>• Select the appropriate video input mode on the TV so the picture from the unit appears on the TV screen.</li> <li>• Connect the video connection securely.</li> <li>• Check the [HDMI Color Setting] in the [Setup] menu is set to the appropriate item that conforms to your video connection.</li> <li>• Your TV may not support the resolution you have set on the player. Change the resolution that your TV accepts.</li> <li>• The player's HDMI OUT jack is connected to a DVI device that does not support copyright protection.</li> </ul>
Picture noise appears	<ul style="list-style-type: none"> <li>• You are playing a disc recorded in a colour system that is different from your TV.</li> <li>• Set the resolution which your TV accepts.</li> </ul>
Blu-ray 3D disc playback does not output 3D views.	<ul style="list-style-type: none"> <li>• Connect the player to your TV with HDMI cable (Type A, High Speed HDMI™ Cable with Ethernet).</li> <li>• Your TV may not support "HDMI 1.4 3D mandatory format".</li> <li>• The [3D Mode] option in the [Setup] menu is set to [Off]. Set the option to [On].</li> </ul>

## Sound

Symptom	Cause & Solution
There is no sound or the sound is distorted.	<ul style="list-style-type: none"> <li>• The unit is in scan, slow motion, or pause mode.</li> <li>• The sound volume is low.</li> <li>• Check the speaker cable connection. (page 19)</li> </ul>

## Customer Support

You can update the Player using the latest software to enhance the products operation and/or add new features. To obtain the latest software for this player (if updates have been made), please visit <http://us.lgservice.com> or contact LG Electronics customer care center.

## Open source software notice

To obtain the corresponding source code under GPL, LGPL, MPL and other open source licenses, please visit <http://opensource.lge.com>. All referred license terms, warranty disclaimers and copyright notices are available to download with the source code.

## Controlling a TV with the Supplied Remote Control

You can control your TV using the buttons below.

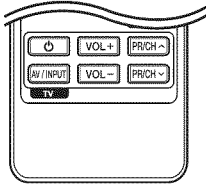

By pressing	You can
⏻ (TV POWER)	Turn the TV on or off.
AV/INPUT	Switch the TV's input source between the TV and other input sources.
PR/CH ▲ / ▼	Scan up or down through memorized channels.
VOL +/-	Adjust the volume of the TV

### ! Note

Depending on the unit being connected, you may not be able to control your TV using some of the buttons.

## Setting up the remote to control your TV

You can operate your TV with the supplied remote control.

If your TV is listed in the table below, set the appropriate manufacturer code.

1. While holding down ⏻ (TV POWER) button, and press the manufacturer code for your TV with the numerical buttons (see the table below).

Manufacturer	Code Number
LG	1(Default), 2
Zenith	1, 3, 4
GoldStar	1, 2
Samsung	6, 7
Sony	8, 9
Hitachi	4

2. Release the ⏻ (TV POWER) button to complete setting.

Depending on your TV, some or all buttons may not function on the TV, even after entering the correct manufacturer code. When you replace the batteries of the remote, the code number you have set may be reset to the default setting. Set the appropriate code number again.



# Network Software Update

## Network update notification

From time to time, performance improvements and/or additional features or services may be made available to units that are connected to a broadband home network. If there is new software available and the unit is connected to a broadband home network, the player will inform you about the update as follows.

### Option 1:

1. The update menu will appear on the screen when you turn on the player.
2. Use  $\langle \rangle$  to select a desired option and then press ENTER (⊙).

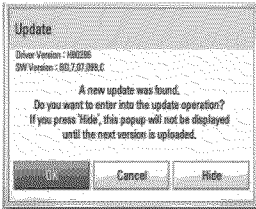

<b>[OK]</b>	Starts the software update.
<b>[Cancel]</b>	Exits the update menu and displays it next booting.
<b>[Hide]</b>	Exits the update menu and it does not appear until next software is uploaded in the update server.

### Option 2:

If the software update is available from the update server, the "Update" icon appears in the Home menu. Press blue (B) colored button to start the update procedure.

## Software Update

You can update the player using the latest software to enhance the products operation and/or add new features. You can update the software by connecting the unit directly to the software update server.

### ! Note

- Before updating the software in your player, remove any disc and USB Device from the player.
- Before updating the software in your player, turn the player off and then turn it back on.
- **During the software update procedure, do not turn off the player or disconnect AC power, or do not press any button.**
- If you cancel the update, turn off the power and turn it on for stable performance.
- This unit cannot be updated to previous software version.

1. Check the network connection and settings (page 27-31).
2. Select [Software] option in the [Setup] menu then press ENTER (⊙).
3. Select [Update] option, and press ENTER (⊙).

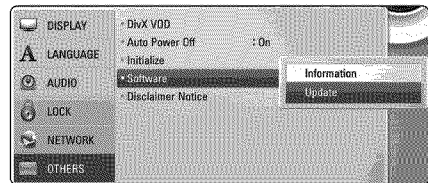

The player will check for the newest update.

### ! Note

- Pressing ENTER (⊙) while checking for the update will end the process.
- If there is no update available, the Message, "No update is found." appears. Press ENTER (⊙) to return to the [Home Menu].

4. If newer version exists, the message “Do you want to update?” appears.
5. Select [OK] to start update. (Selecting [Cancel] will end the update.)

**Caution**

Do not turn off the power during the software update.

**Note**

If the software includes the driver update, disc tray may open during the process.

6. When update is completed, the message, “Update is complete.” will appear, and then power will turn off automatically after 5 seconds.
7. Turn the power back on. The system now operates with the new version.

**Note**

The Software Update function may not work properly depending on your internet environment. In this case, you can obtain the latest software from the authorized LG Electronics Service Center then update your player. Refer to “Customer Support” on page 63.

## About Nero MediaHome 4 Essentials

Nero MediaHome 4 Essentials is a software for sharing video, audio and photo files stored on your computer to this player as a DLNA-compatible digital media server.

**Note**

- The Nero MediaHome 4 Essentials CD-ROM is designed for PCs and should not be inserted in this player or in any product other than a PC.
- The supplied Nero MediaHome 4 Essentials CD-ROM is a customized software edition only for sharing files and folders to this player.
- The supplied Nero MediaHome 4 Essentials software does not support following functions: Transcoding, Remote UI, TV control, Internet services and Apple iTunes
- This manual explains operations with the English version of Nero MediaHome 4 Essentials as examples. Follow the explanation referring to the actual operations of your language version.

## Installing Nero MediaHome 4 Essentials

Before you install Nero MediaHome 4 Essentials, check the system requirement shown below.

- Windows® XP (Service Pack 2 or higher), Windows Vista® (no Service Pack required), Windows® XP Media Center Edition 2005 (Service Pack 2 or higher), Windows Server® 2003
- Windows Vista® 64-bit edition (application runs in 32-bit mode)
- Hard drive space: 200 MB hard drive space for a typical installation of Nero MediaHome stand-alone
- 1.2 GHz Intel® Pentium® III or AMD Sempron™ 2200+ processors
- Memory: 256 MB RAM

- Graphics card with at least 32 MB video memory, minimum resolution of 800 x 600 pixels, and 16-bit color settings
- Windows® Internet Explorer® 6.0 or higher
- DirectX® 9.0c revision 30 (August 2006) or higher
- Network environment: 100 Mb Ethernet, WLAN (IEEE 802.11a/b/g/n)

Start up your computer, and insert the supplied CD-ROM disc into your computer's CD-ROM drive. An installation wizard will walk you through the quick and uncomplicated installation process. To install Nero MediaHome 4 Essentials, proceed as follows:

1. Close all Microsoft Windows programs and exit any anti-virus software that may be running.
2. Insert the supplied CD-ROM disc into your computer's CD-ROM drive.
3. Click [Nero MediaHome 4 Essentials].
4. Click [Run] to start installation.
5. Click [Nero MediaHome 4 Essentials]. The installation is prepared and the installation wizard appears.
6. Click the [Next] button to display the serial number input screen. Click [Next] to go to the next step.
7. If you accept all conditions, click [I accept the License Conditions] check box and click [Next]. Installation is not possible without this agreement.
8. Click [Typical] and click [Next]. The installation process is started.
9. If you want to take part in the anonymous collection of data, select the check box and click the [Next] button.
10. Click the [Exit] button to complete the installation.

## Sharing files and folders

On your computer, you must share the folder contained video, audio and/or photo content to play them on this player.

This part explains the procedure for selecting the shared folders on your computer.

1. Double-click the "Nero MediaHome 4 Essentials" icon on the desktop.
2. Click [Network] icon on the left and define your network name in the [Network name] field. The Network name you enter will be recognized by your player.
3. Click [Shares] icon on the left.
4. Click [Local Folders] tab on the [Shares] screen.
5. Click [Add] icon to open the [Browse Folder] window.
6. Select the folder containing the files you want to share. The selected folder is added to the list of shared folders.
7. Click [Start Server] icon to start the server.

### Note

- If the shared folders or files are not displayed on the player, click the folder on the [Local Folders] tab and click [Rescan Folder] at the [More] button.
- Visit [www.nero.com](http://www.nero.com) for more information and software tools

## Area Code List

Choose an area code from this list.

Area	Code	Area	Code	Area	Code	Area	Code
Afghanistan	AF	Fiji	FJ	Monaco	MC	Singapore	SG
Argentina	AR	Finland	FI	Mongolia	MN	Slovak Republic	SK
Australia	AU	France	FR	Morocco	MA	Slovenia	SI
Austria	AT	Germany	DE	Nepal	NP	South Africa	ZA
Belgium	BE	Great Britain	GB	Netherlands	NL	South Korea	KR
Bhutan	BT	Greece	GR	Antilles	AN	Spain	ES
Bolivia	BO	Greenland	GL	New Zealand	NZ	Sri Lanka	LK
Brazil	BR	Hong Kong	HK	Nigeria	NG	Sweden	SE
Cambodia	KH	Hungary	HU	Norway	NO	Switzerland	CH
Canada	CA	India	IN	Oman	OM	Taiwan	TW
Chile	CL	Indonesia	ID	Pakistan	PK	Thailand	TH
China	CN	Israel	IL	Panama	PA	Turkey	TR
Colombia	CO	Italy	IT	Paraguay	PY	Uganda	UG
Congo	CG	Jamaica	JM	Philippines	PH	Ukraine	UA
Costa Rica	CR	Japan	JP	Poland	PL	United States	US
Croatia	HR	Kenya	KE	Portugal	PT	Uruguay	UY
Czech Republic	CZ	Kuwait	KW	Romania	RO	Uzbekistan	UZ
Denmark	DK	Libya	LY	Russian		Vietnam	VN
Ecuador	EC	Luxembourg	LU	Federation	RU	Zimbabwe	ZW
Egypt	EG	Malaysia	MY	Saudi Arabia	SA		
El Salvador	SV	Maldives	MV	Senegal	SN		
Ethiopia	ET	Mexico	MX				

## Language code List

Use this list to input your desired language for the following initial settings: [Disc Audio], [Disc Subtitle] and [Disc Menu].

Language	Code	Language	Code	Language	Code	Language	Code
Afar	6565	French	7082	Lithuanian	7684	Sindhi	8368
Afrikaans	6570	Frisian	7089	Macedonian	7775	Singhalese	8373
Albanian	8381	Galician	7176	Malagasy	7771	Slovak	8375
Ameharic	6577	Georgian	7565	Malay	7783	Slovenian	8376
Arabic	6582	German	6869	Malayalam	7776	Spanish	6983
Armenian	7289	Greek	6976	Maori	7773	Sudanese	8385
Assamese	6583	Greenlandic	7576	Marathi	7782	Swahili	8387
Aymara	6588	Guarani	7178	Moldavian	7779	Swedish	8386
Azerbaijani	6590	Gujarati	7185	Mongolian	7778	Tagalog	8476
Bashkir	6665	Hausa	7265	Nauru	7865	Language	Code
Basque	6985	Hebrew	7387	Nepali	7869	Tajik	8471
Bengali; Bangla	6678	Hindi	7273	Norwegian	7879	Tamil	8465
Bhutani	6890	Hungarian	7285	Oriya	7982	Telugu	8469
Bihari	6672	Icelandic	7383	Panjabi	8065	Thai	8472
Breton	6682	Indonesian	7378	Pashto, Pushto	8083	Tonga	8479
Bulgarian	6671	Interlingua	7365	Persian	7065	Turkish	8482
Burmese	7789	Irish	7165	Polish	8076	Turkmen	8475
Byelorussian	6669	Italian	7384	Portuguese	8084	Twi	8487
Chinese	9072	Japanese	7465	Quechua	8185	Ukrainian	8575
Croatian	7282	Kannada	7578	Rhaeto-Romance	8277	Urdu	8582
Czech	6783	Kashmiri	7583	Rumanian	8279	Uzbek	8590
Danish	6865	Kazakh	7575	Russian	8285	Vietnamese	8673
Dutch	7876	Kirghiz	7589	Samoan	8377	Volapük	8679
English	6978	Korean	7579	Sanskrit	8365	Welsh	6789
Esperanto	6979	Kurdish	7585	Scots Gaelic	7168	Wolof	8779
Estonian	6984	Laothian	7679	Serbian	8382	Xhosa	8872
Faroese	7079	Latin	7665	Serbo-Croatian	8372	Yiddish	7473
Fiji	7074	Latvian, Lettish	7686	Shona	8378	Yoruba	8979
Finnish	7073	Lingala	7678			Zulu	9085

## Trademarks and Licenses



Blu-ray Disc™, Blu-ray™, Blu-ray 3D, BD-LIVE, BONUSVIEW and the logos are trademarks of the Blu-ray Disc Association.



“DVD Logo” is a trademark of DVD Format/Logo Licensing Corporation.



Java and all Java-based trademarks and logos are trademarks or registered trademarks of Sun Microsystems, Inc. in the United States and other countries.



HDMI, the HDMI logo and High-Definition Multimedia Interface are trademarks or registered trademarks of HDMI licensing LLC.



Manufactured under license from Dolby Laboratories. Dolby and the double-D symbol are trademarks of Dolby Laboratories.



Manufactured under license under U.S. Patent #'s: 5,451,942; 5,956,674; 5,974,380; 5,978,762; 6,226,616; 6,487,535; 7,392,195; 7,272,567; 7,333,929; 7,212,872 & other U.S. and worldwide patents issued & pending. DTS and the Symbol are registered trademarks, & DTS-HD, DTS-HD Master Audio | Essential and the DTS logos are trademarks of DTS, Inc. Product includes software. © DTS, Inc. All Rights Reserved.



DLNA®, the DLNA Logo and DLNA CERTIFIED® are trademarks, service marks, or certification marks of the Digital Living Network Alliance.



The Wi-Fi CERTIFIED Logo is a certification mark of the Wi-Fi Alliance.



The Wi-Fi Protected Setup Mark is a trademark of the Wi-Fi Alliance.

“x.v.Color” is a trademark of Sony Corporation.



“AVCHD” and the “AVCHD” logo are trademarks of Panasonic Corporation and Sony Corporation.



DivX®, DivX Certified® and associated logos are trademark of DivX, Inc., and are used under license.



Gracenote®, Gracenote logo and logotype, and the “Powered by Gracenote” logo are either registered trademarks or trademarks of Gracenote, Inc. in the United States and/or other countries.

Music recognition technology and related data are provided by Gracenote®.

Portions of the content is copyright © Gracenote or its providers.

### Gracenote® End User License Agreement

This application or device contains software from Gracenote, Inc. of Emeryville, California (“Gracenote”). The software from Gracenote (the “Gracenote Software”) enables this application to perform disc and/or file identification and obtain music-related information, including name, artist, track, and title information (“Gracenote Data”) from online servers or embedded databases (collectively, “Gracenote Servers”) and to perform other functions. You may use Gracenote Data only by means of the intended End-User functions of this application or device.

You agree that you will use Gracenote Data, the Gracenote Software, and Gracenote Servers for your own personal non-commercial use only. You agree not to assign, copy, transfer or transmit the Gracenote Software or any Gracenote Data to any third party. YOU AGREE NOT TO USE OR EXPLOIT GRACENOTE DATA, THE GRACENOTE SOFTWARE, OR GRACENOTE SERVERS, EXCEPT AS EXPRESSLY PERMITTED HEREIN.

You agree that your non-exclusive license to use the Gracenote Data, the Gracenote Software, and Gracenote Servers will terminate if you violate these restrictions. If your license terminates, you agree to cease any and all use of the Gracenote Data, the Gracenote Software, and Gracenote Servers. Gracenote reserves all rights in Gracenote Data, the Gracenote Software, and the Gracenote Servers, including all ownership rights. Under no circumstances will Gracenote become liable for any payment to you for any information that you provide. You agree that Gracenote, Inc. may enforce its rights under this Agreement against you directly in its own name.

The Gracenote service uses a unique identifier to track queries for statistical purposes. The purpose of a randomly assigned numeric identifier is to allow the Gracenote service to count queries without knowing anything about who you are. For more information, see the web page for the Gracenote Privacy Policy for the Gracenote service.

The Gracenote Software and each item of Gracenote Data are licensed to you “AS IS.” Gracenote makes no representations or warranties, express or implied, regarding the accuracy of any Gracenote Data from in the Gracenote Servers. Gracenote reserves the right to delete data from the Gracenote Servers or to change data categories for any cause that Gracenote deems sufficient. No warranty is made that the Gracenote Software or Gracenote Servers are error-free or that functioning of Gracenote Software or Gracenote Servers will be uninterrupted. Gracenote is not obligated to provide you with new enhanced or additional data types or categories that Gracenote may provide in the future and is free to discontinue its services at any time.

GRACENOTE DISCLAIMS ALL WARRANTIES EXPRESS OR IMPLIED, INCLUDING, BUT NOT LIMITED TO, IMPLIED WARRANTIES OF MERCHANTABILITY, FITNESS FOR A PARTICULAR PURPOSE, TITLE, AND NON-INFRINGEMENT. GRACENOTE DOES NOT WARRANT THE RESULTS THAT WILL BE OBTAINED BY YOUR USE OF THE GRACENOTE SOFTWARE OR ANY GRACENOTE SERVER. IN NO CASE WILL GRACENOTE BE LIABLE FOR ANY CONSEQUENTIAL OR INCIDENTAL DAMAGES OR FOR ANY LOST PROFITS OR LOST REVENUES.

© Gracenote, Inc. 2009

# Video Output Resolution

When the non-copy protected media is playing back

Resolution \ Video Out	HDMI OUT	COMPONENT VIDEO OUT	
		HDMI connected	HDMI disconnected
480i	480p	480i	
480p	480p	480p	
720p	720p	720p	
1080i	1080i	1080i	
1080p/24 Hz	1080p / 24 Hz	480i	1080i
1080p / 60 Hz	1080p / 60 Hz	480i	1080i

When the copy protected media is playing back

Resolution \ Video Out	HDMI OUT	COMPONENT VIDEO OUT	
480i	480p	480i	
480p	480p	480i	
720p	720p	480i	
1080i	1080i	480i	
1080p/24 Hz	1080p / 24 Hz	480i	
1080p / 60 Hz	1080p / 60 Hz	480i	

## HDMI OUT connection

- If you select a resolution manually and then connect the HDMI jack to TV and your TV does not accept it, the resolution setting is set to [Auto].
- If you select a resolution that your TV does not accept, the warning message will appear. After resolution change, if you cannot see the screen, please wait 20 seconds and the resolution will automatically revert back to the previous resolution.
- The 1080p video output frame rate may be automatically set to either 24 Hz or 60 Hz depending both on the capability and preference of the connected TV and based on the native video frame rate of the content on the BD-ROM disc.

## COMPONENT VIDEO OUT Connection

Blu-ray Disc, DVD, Netflix or CinemaNow video stream could prevent up-scaling on analog output.

## VIDEO OUT connection

The resolution of the VIDEO OUT jack is always outputted at 480i resolution.



# Specifications

General	
Power requirements	Refer to main label on the rear panel.
Power consumption	Refer to main label on the rear panel.
Dimensions (W x H x D)	Approx. 433.5 x 57 x 281 mm (17 x 2.2 x 11 inches)
Net Weight (Approx.)	3.5 kg (7.7 lbs)
Operating temperature	5 °C to 35 °C (41 °F to 95 °F)
Operating humidity	5 % to 90 %

Inputs/Outputs	
VIDEO OUT	1.0 V (p-p), 75 Ω, sync negative, RCA jack x 1
COMPONENT VIDEO OUT	(Y) 1.0 V (p-p), 75 Ω, sync negative, RCA jack x 1 (Pb)/(Pr) 0.7 V (p-p), 75 Ω, RCA jack x 2
HDMI IN/OUT (video/audio)	19 pin (Type A, HDMI™ Connector)
ANALOG AUDIO IN	2.0 Vrms (1 kHz, 0 dB), 600 Ω, RCA jack (L, R) x 1
DIGITAL IN (OPTICAL)	3 V (p-p), Optical jack x 1
PORT. IN	0.5 Vrms (3.5 mm stereo jack)

Tuner	
FM Tuning Range	87.5 to 108.0 MHz or 87.50 to 108.00 MHz
AM Tuning Range	520 to 1,710 kHz

Amplifier	
Power output (4 Ω/ 3 Ω), (RMS), THD 10 %	
Total	1100 W
Front	180 W x 2
Center	180 W
Rear	180 W x 2
Sub-Woofer	200 W (Passive)

System	
Laser	Semiconductor laser
Wavelength	405 nm / 650 nm
Signal system	Standard NTSC color TV system
Frequency response	20 Hz to 18 kHz (48 kHz, 96 kHz, 192 kHz sampling)
Harmonic distortion	Less than 0.05 %
Dynamic range	More than 80 dB
LAN port	Ethernet jack x 1, 10BASE-T / 100BASE-TX
Wireless LAN (internal antenna)	Integrated IEEE 802.11n (5 GHz and 2.4 GHz bands) wireless networking access, compatible with 802.11a/b/g Wi-Fi networks.
Bus Power Supply (USB)	DC 5 V $\overline{\text{---}}$ 500 mA

Speakers			
Front speaker (Left/ Right)			
Type	2 Way 3 speaker	Max. Input power	360 W
Impedance Rated	4 $\Omega$	Net Dimensions (W x H x D)	280 x 1152 x 225 mm (11 x 45 x 8.9 inches)
Input Power	180 W	Net Weight	3.33 kg (7.34 lbs)
Rear speaker (Left/ Right)			
Type	1 Way 1 speaker	Max. Input power	360 W
Impedance Rated	4 $\Omega$	Net Dimensions (W x H x D)	94 X 182 X 83 mm (3.7 X 7.2 X 3.3 inches)
Input Power	180 W	Net Weight	0.61 kg (1.34 lbs)
Center speaker			
Type	2 Way 3 speaker	Max. Input power	360 W
Impedance Rated	4 $\Omega$	Net Dimensions (W x H x D)	327 X 99 X 76 mm (12.9 X 3.9 X 3.0 inches)
Input Power	180 W	Net Weight	1.21 kg (2.67 lbs)
Subwoofer			
Type	1 Way 1 speaker	Max. Input power	400 W
Impedance Rated	3 $\Omega$	Net Dimensions (W x H x D)	190 X 385 X 358 mm (7.5 x 15.2 x 14.1 inches)
Input Power	200 W	Net Weight	5.4 kg (11.9 lbs)

Wireless receiver			
Power requirements	Refer to main label on the bottom of the receiver.		
Power consumption	Refer to main label on the bottom of the receiver.		
External dimensions (WxHxD)	64 x 213.6 x 180 mm (2.5 x 8.4 x 7.1 inches)		
Net Weight	1 kg (2.2 lbs)	Reception Output	5.8 GHz

- Design and specifications are subject to change without notice.

## Maintenance

### Handling the Unit

#### When shipping the unit

Please save the original shipping carton and packing materials. If you need to ship the unit, for maximum protection, re-pack the unit as it was originally packed at the factory.

Keeping the exterior surfaces clean

- Do not use volatile liquids such as insecticide spray near the unit.
- Wiping with strong pressure may damage the surface.
- Do not leave rubber or plastic products in contact with the unit for a long period of time.

#### Cleaning the unit

To clean the player, use a soft, dry cloth. If the surfaces are extremely dirty, use a soft cloth lightly moistened with a mild detergent solution. Do not use strong solvents such as alcohol, benzene, or thinner, as these might damage the surface of the unit.

#### Maintaining the Unit

The unit is a high-tech, precision device. If the optical pick-up lens and disc drive parts are dirty or worn, the picture quality could be diminished. For details, please contact your nearest authorized service center.

## Notes on Discs

### Handling Discs

Do not touch the playback side of the disc. Hold the disc by the edges so that fingerprints do not get on the surface. Never stick paper or tape on the disc.

### Storing Discs

After playing, store the disc in its case. Do not expose the disc to direct sunlight or sources of heat and never leave it in a parked car exposed to direct sunlight.

### Cleaning Discs

Fingerprints and dust on the disc can cause poor picture quality and sound distortion. Before playing, clean the disc with a clean cloth. Wipe the disc from the center to out.

Do not use strong solvents such as alcohol, benzene, thinner, commercially available cleaners, or anti-static spray intended for older vinyl records.

## Important Information Relating to Network Services

All information, data, documents, communications, downloads, files, text, images, photographs, graphics, videos, webcasts, publications, tools, resources, software, code, programs, applets, widgets, applications, products and other content ("Content") and all services and offerings ("Services") provided or made available by or through any third party (each a "Service Provider") is the sole responsibility of the Service Provider from whom it originated.

The availability of and access to Content and Services furnished by the Service Provider through the LGE Device are subject to change at any time, without prior notice, including, but not limited to the suspension, removal or cessation of all or any part of the Content or Services.

Should you have any inquiry or problem related to the Content or Services, you may refer to the Service Provider's website for the most up-to-date information. LGE is neither responsible nor liable for customer service related to the Content and Services. Any question or request for service relating to the Content or Services should be made directly to the respective Content and Service Providers.

Please note that LGE is not responsible for any Content or Services provided by the Service Provider or any changes to, removal of, or cessation of such Content or Services and does not warrant or guaranty the availability of or access to such Content or Services.



