

VIZIO

E421VL  
E470VL  
E551VL

LCD HDTV

[www.VIZIO.com](http://www.VIZIO.com)



Dear VIZIO Customer,

Congratulations on your new VIZIO E421VL, E470VL, or E551VL television purchase. To get the most out of your new VIZIO HDTV, read these instructions before making any adjustments, and retain them for future reference. We hope you will experience many years of enjoyment from your new VIZIO HDTV High Definition Television.

For assistance, call **877-MYVIZIO** (877-698-4946) or e-mail us at [www.VIZIO.com](http://www.VIZIO.com).

To purchase or inquire about accessories and installation services for your VIZIO HDTV, visit our website at [www.VIZIO.com](http://www.VIZIO.com) or call toll free at **(888) 849-4623**.

We recommend you register your VIZIO HDTV either at our website [www.VIZIO.com](http://www.VIZIO.com) or fill out and mail your registration card. For peace of mind and to protect your investment beyond the standard warranty, VIZIO offers on-site extended warranty service plans. These plans give additional coverage during the standard warranty period. Visit our website or call us to purchase a plan.

Write down the serial number located on the back of your HDTV for easy reference when obtaining warranty support:

Serial #: _____	Purchase Date _____
-----------------	---------------------

*VIZIO is a registered trademark of VIZIO, Inc. dba V, Inc.*

*HDMI logo and "High Definition Multimedia Interface" are registered trademarks of HDMI Licensing LLC.*

*Manufactured under license from Dolby Laboratories.*

*Dolby and the double-D symbol are trademarks of Dolby Laboratories.*



*TruSurround HD and TruVolume are trademarks of SRS Labs, Inc.*

*TruSurround HD and TruVolume technologies are incorporated under license from SRS Labs, Inc.*



This product qualifies for ENERGY STAR in the "factory default (Home Use)" setting and this is the setting in which power savings will be achieved. Changing the factory default picture setting or enabling other features will increase power consumption that could exceed the limits necessary to qualify for Energy Star rating.

*THE TRADEMARKS SHOWN HEREIN ARE THE PROPERTY OF THEIR RESPECTIVE OWNERS; IMAGES USED ARE FOR ILLUSTRATION PURPOSES ONLY. VIZIO, THE V LOGO, WHERE VISION MEETS VALUE AND OTHER VIZIO TRADEMARKS ARE THE INTELLECTUAL PROPERTY OF VIZIO INC. PRODUCT SPECIFICATIONS ARE SUBJECT TO CHANGE WITHOUT NOTICE. © 2010 VIZIO INC. ALL RIGHTS RESERVED.*

## Important Safety Instructions

Your HDTV is designed and manufactured to operate within defined design limits. Misuse may result in electric shock or fire. To prevent your HDTV from being damaged, the following rules should be observed for the installation, use, and maintenance of your HDTV. Read the following safety instructions before operating your HDTV. Keep these instructions in a safe place for future reference.

- To reduce the risk of electric shock or component damage, switch off the power before connecting other components to your HDTV.
- Unplug the power cord before cleaning your HDTV. A damp cloth is sufficient for cleaning your HDTV. Do not use a liquid or a spray cleaner for cleaning your HDTV. Do not use abrasive cleaners.
- Always use the accessories recommended by the manufacturer to insure compatibility.
- When moving your HDTV from an area of low temperature to an area of high temperature, condensation may form in the housing. Wait before turning on your HDTV to avoid causing fire, electric shock, or component damage.
- Use only with the cart, stand, tripod, bracket, or table specified by manufacturer or sold with your HDTV. When a cart is used, use caution when moving the cart/HDTV combination to avoid injury from tip-over. Do not place your HDTV on an unstable cart, stand, or table. If your HDTV falls, it can injure a person and cause serious damage to your HDTV. Use only a cart or stand recommended by the manufacturer or sold with your HDTV.
- A distance of at least three feet should be maintained between your HDTV and any heat source, such as a radiator, heater, oven, amplifier etc. Do not install your HDTV close to smoke. Operating your HDTV close to smoke or moisture may cause fire or electric shock.
- Slots and openings in the back and bottom of the cabinet are provided for ventilation. To ensure reliable operation of your HDTV and to protect it from overheating, be sure these openings are not blocked or covered. Do not place your HDTV in a bookcase or cabinet unless proper ventilation is provided.
- Never push any object into the slots and openings on your HDTV cabinet. Do not place any objects on the top of your HDTV. Doing so could short circuit parts causing a fire or electric shock. Never spill liquids on your HDTV.
- Your HDTV should be operated only from the type of power source indicated on the label. If you are not sure of the type of power supplied to your home, consult your dealer or local power company.
- Do not apply pressure or throw objects at your HDTV. This may compromise the integrity of the display. The manufacturer's warranty does not cover user abuse or improper installations.
- The power cord must be replaced when using different voltage than the voltage specified. For more information, contact your dealer.
- Your HDTV is equipped with a **three-pronged grounded plug (a plug with a third grounding pin)**. This plug will fit only into a grounded power outlet. This is a safety feature. If your outlet does not accommodate the three-pronged, have an electrician install the correct outlet, or use an adapter to ground your HDTV safely. **Do not defeat the safety purpose of the grounded plug.**
- When connected to a power outlet, power is always flowing into your HDTV. To totally disconnect power, unplug the power cord.



- The lightning flash with arrowhead symbol within an equilateral triangle is intended to alert the user to the presence of un-isolated, dangerous voltage within the inside of your HDTV that may be of sufficient magnitude to constitute a risk of electric shock to persons.
- The exclamation point within an equilateral triangle is intended to alert the user to the presence of important operating and servicing instructions in the literature accompanying your HDTV.
- Do not overload power strips and extension cords. Overloading can result in fire or electric shock.



- The wall socket should be installed near your HDTV and easily accessible.
- Only power of the marked voltage can be used for your HDTV. Any other voltage than the specified voltage may cause fire or electric shock
- Do not touch the power cord during lightning. To avoid electric shock, avoid handling the power cord during electrical storms.
- Unplug your HDTV during a lightning storm or when it will not be used for long period of time. This will protect your HDTV from damage due to power surges.
- Do not attempt to repair or service your HDTV yourself. Opening or removing the back cover may expose you to high voltages, electric shock, and other hazards. If repair is required, contact your dealer and refer all servicing to qualified service personnel.
- Keep your HDTV away from moisture. Do not expose your HDTV to rain or moisture. If water penetrates into your HDTV, unplug the power cord and contact your dealer. Continuous use in this case may result in fire or electric shock.
- Do not use your HDTV if any abnormality occurs. If any smoke or odor becomes apparent, unplug the power cord and contact your dealer immediately. Do not try to repair your HDTV yourself.
- Avoid using dropped or damaged appliances. If your HDTV is dropped and the housing is damaged, the internal components may function abnormally. Unplug the power cord immediately and contact your dealer for repair. Continued use of your HDTV may cause fire or electric shock.
- Do not install your HDTV in an area with heavy dust or high humidity. Operating your HDTV in environments with heavy dust or high humidity may cause fire or electric shock.
- Follow instructions for moving your HDTV. Ensure that the power cord and any other cables are unplugged before moving your HDTV.
- When unplugging your HDTV, hold the power plug, not the cord. Pulling on the power cord may damage the wires inside the cord and cause fire or electric shock. When your HDTV will not be used for an extended period of time, unplug the power cord.
- To reduce risk of electric shock, do not touch the connector with wet hands.
- Insert batteries in accordance with instructions. Incorrect polarities may cause the batteries to leak which can damage the remote control or injure the operator.
- If any of the following occurs, contact the dealer:
  - The power cord fails or frays.
  - Liquid sprays or any object drops into your HDTV.
  - Your HDTV is exposed to rain or other moisture.
  - Your HDTV is dropped or damaged in any way.
  - The performance of your HDTV changes substantially.



## Television Antenna Connection Protection

### External Television Antenna Grounding

If an outside antenna/satellite dish or cable system is to be connected to the TV, make sure that the antenna or cable system is electrically grounded to provide some protection against voltage surges and static charges.

Article 810 of the National Electrical Code, ANSI/NFPA 70, provides information with regard to proper grounding of the mast and supporting structure, grounding of the lead-in wire to an antenna discharge unit, size of the grounding conductors, location of antenna discharge unit, connection to grounding electrodes, and requirements of the grounding electrode.

### Lightning Protection

For added protection of the TV during a lightning storm or when it is left unattended or unused for long periods of time, unplug the TV from the wall outlet and disconnect the antenna or cable system.

### Power Lines

Do not locate the antenna near overhead light or power circuits, or where it could fall into such power lines or circuits.

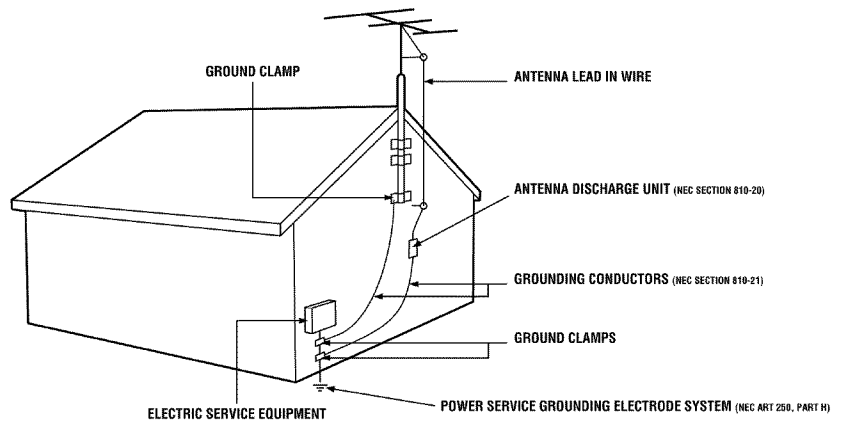

**Remember, the screen of the coaxial cable is intended to be connected to earth in the building installation.**

## Advisory of the DTV Transition

The nationwide switch to digital television broadcasting will be complete on June 12, 2009, but your local television stations may switch sooner. After the switch, analog-only television sets that receive TV programming through an antenna will need a converter box to continue to receive over-the-air TV. Watch your local stations to find out when they will turn off their analog signal and switch to digital-only broadcasting. Analog-only TVs should continue to work as before to receive low power, Class A or translator television stations and with cable and satellite TV services, gaming consoles, VCRs, DVD players, and similar products.

For additional information, contact the parties listed below, as appropriate:

FCC (US Federal Communications Commission)

<http://www.fcc.gov/>

Phone: 1-888-CALL-FCC (1-888-225-5322)

TTY: 1-888-TELL-FCC (1-888-835-5322)

Fax: 1-866-418-0232

E-mail: [fccinfo@fcc.gov](mailto:fccinfo@fcc.gov)

NTIA (National Telecommunications and Information Administration)

<http://www.ntia.doc.gov/>

1-888-DTV-2009

Listings of US Television Stations

<http://www.high-techproductions.com/usTVstations.htm>

**Note:** Your VIZIO HDTV is capable of receiving Digital Broadcasts, and no Digital Converter Box is required.

**Table of Contents**

Important Safety Instructions..... 2  
 Television Antenna Connection Protection ..... 4  
 Advisory of the DTV Transition..... 5

**CHAPTER 1 SETTING UP YOUR HDTV ..... 10**

Attaching the E421VL TV Stand..... 11  
 Attaching the E470VL TV Stand..... 12  
 Wall Mounting your HDTV..... 13

**CHAPTER 2 BASIC CONTROLS AND CONNECTIONS ..... 14**

Front Panel..... 14  
 Side Panel Controls..... 14  
 Side Panel Connection..... 14  
 Rear Panel Connections..... 15

**CHAPTER 3 VIZIO REMOTE CONTROL ..... 16**

Installing the Batteries ..... 16  
 Remote Control Range..... 16  
 VIZIO Remote Control Precautions..... 16  
 E421VL Remote Control Buttons ..... 17  
 E470VL & E551VL Remote Control Buttons..... 18

**CHAPTER 4 GETTING STARTED..... 19**

**CHAPTER 5 USING YOUR HDTV FOR THE FIRST TIME ..... 20**

Select Input Source ..... 20  
 Watching a TV Program ..... 20  
 Viewing Digital TV Program Information ..... 21

**CHAPTER 6 CONNECTING EQUIPMENT ..... 22**

Which Video Connection Should I Use? ..... 22  
 Connecting Your Cable or Satellite Box ..... 23  
     Using HDMI (Best)..... 23  
     HDMI Connections for Cable or Satellite Boxes with DVI ..... 23  
     Using Component Video (Better)..... 24  
     Using Composite Video (Good)..... 24  
     Using Coaxial (Antenna) (Good)..... 24  
 Connecting Your DVD Player..... 25  
     Using HDMI (Best)..... 25  
     HDMI Connections for DVD Players with DVI ..... 25  
     Using Component Video (Better)..... 26  
     Using Composite (AV) Video (Good)..... 26  
 Connecting Coaxial (RF)..... 27  
     Using Your Antenna or Digital Cable for Standard or Digital TV ..... 27  
 Connecting Your VCR or Video Camera..... 27  
 Connecting a Home Theater System ..... 28  
 Using RCA..... 28  
 Using Optical (S/PDIF) ..... 28  
 Connecting a Computer..... 29  
     Using RGB (VGA)..... 29  
     Using HDMI..... 29

**CHAPTER 7 VIEWING PICTURES ..... 30**

Viewing Pictures ..... 30

Slideshow Mode.....	31
Repeat.....	31
Sort By .....	31
Duration .....	31
Slideshow Effect .....	31
Thumbnail Size .....	31
Info .....	31
<b>CHAPTER 8 ADJUSTING YOUR HDTV SETTINGS.....</b>	<b>32</b>
Using the On-screen Display (OSD) .....	32
Input Menu.....	32
Wide Menu .....	33
Normal.....	33
Wide.....	33
Zoom.....	33
Panoramic.....	33
Stretch.....	33
CC (Closed Caption) Menu .....	34
Analog Closed Caption .....	34
Digital Closed Caption .....	34
Digital CC Style.....	34
Sleep Timer Menu .....	34
Picture Menu .....	34
Picture Mode.....	34
Backlight .....	34
Brightness .....	34
Contrast .....	35
Color.....	35
Tint .....	35
Sharpness.....	35
More .....	35
PIP Menu.....	37
PIP Mode .....	37
Source.....	37
Position .....	37
Size .....	37
Audio.....	37
Settings Menu.....	38
Audio Menu .....	38
Tuner.....	40
Name Input .....	41
Parental Controls .....	41
Menu Language.....	43
Time & Local Settings .....	43
CEC.....	44
Media Menu.....	44
Slideshow Mode.....	44
Repeat.....	44
Sort By .....	44
Duration .....	45
Slideshow Effect .....	45
Thumbnail Size .....	45
Info .....	45
Help Menu .....	45
System Info .....	45
Reset TV Settings.....	45

Clear Memory (Factory Default) .....	45
Start Setup Wizard .....	45
<b>CHAPTER 9 PROGRAMMING THE VIZIO UNIVERSAL REMOTE CONTROL .....</b>	<b>46</b>
Using a Cable or Satellite Box Remote .....	46
Programming other devices .....	46
Programming your Blu-Ray or DVD Player .....	46
Programming your Home Theater System .....	46
Programming your Cable or Satellite Set-Top Box .....	47
Searching for Device Codes .....	47
Reset Remote to Factory Settings .....	47
Remote Control Codes .....	48
Television Codes .....	48
Cable Box Codes .....	50
Converters .....	50
Decoders .....	50
IPTV .....	50
Satellite Receiver Codes .....	50
PVR Codes .....	51
Blu-Ray DVD Codes .....	51
DVD/VCR Player Codes .....	51
DVD Player Codes .....	51
Amplifier / Receiver / Tuner Codes .....	52
Satellite Receiver Codes .....	53
Audio Accessory Codes .....	53
Video Accessory Codes .....	54
VCR Codes .....	54
<b>CHAPTER 10 MAINTENANCE AND TROUBLESHOOTING .....</b>	<b>56</b>
Cleaning the TV and Remote Control .....	56
Troubleshooting Guide .....	56
Telephone & Technical Support .....	59
Compliance .....	59
FCC Class B Radio Interference Statement .....	59
<b>CHAPTER 11 SPECIFICATIONS .....</b>	<b>60</b>
E421VL Specifications .....	60
E470VL Specifications .....	61
E551VL Specifications .....	62
Preset PC Resolutions .....	64
Resolution through RGB Input .....	64
<b>WARRANTY .....</b>	<b>65</b>
<b>INDEX .....</b>	<b>66</b>

## Opening the Package

Your HDTV and its accompanying accessories are carefully packed in a cardboard carton that has been designed to protect it from transportation damage. After you have opened the carton, check that your HDTV is in good condition and that all of the contents are included.

The glass surface can easily be scratched or broken, so handle your HDTV gently and never place your HDTV with the glass facing downwards on a surface without protective padding.

**IMPORTANT:** Save the carton and packing material for future shipping.

## Package Contents

- VIZIO E421VL or E470VL or E551VL
- VIZIO remote control VR15 (E421VL only)
- VIZIO remote control VUR13M (E470VL and E551VL only)
- AA batteries for the VR15 remote control (2)
- AAA batteries for the VUR13M remote control (2)
- Power cord
- Detachable base with thumbscrew (E421VL and E470VL only)
- This user manual
- Quick Setup Guide
- Registration Card

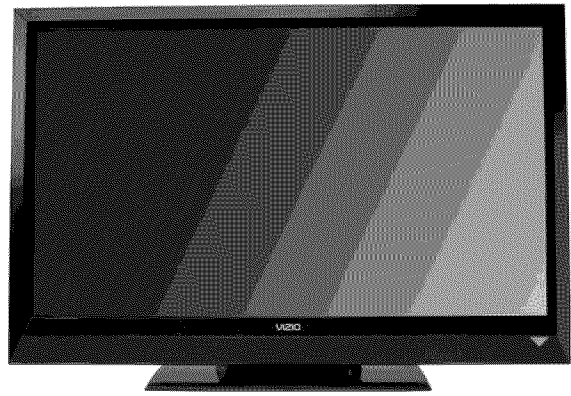

## HDTV Accessories and Services

**Additional certified accessories for your HDTV are sold separately, including:**

- Wall mounts
- High Definition cables
- Extra or replacement remote controls
- Sound Bars
- Blu-ray DVD Players

VIZIO also offers installation services and extended warranty services for your HDTV.

To purchase or inquire about additional accessories and services for your VIZIO HDTV, visit our website at [www.VIZIO.com](http://www.VIZIO.com) or call us toll free at **877-MYVIZIO** (877-698-4946).

**Caution:** Do not apply pressure or throw objects at your HDTV (including game controllers). This may compromise the integrity of the display. The manufacturer's warranty does not cover user abuse or improper installations.

## Chapter 1 Setting Up Your HDTV

- Read this user manual carefully before installing your HDTV.
- The power consumption of your HDTV is about 111W (E421VL); 134W (E470VL); 155W (E551VL) average. Use the included AC/DC power adapter. When an extension cord is required, use one with the correct power rating. The cord must be grounded and the grounding feature must not be compromised.
- Install your HDTV on a flat surface to avoid tipping.
- For proper ventilation, you must allow a 1" space between the back of your HDTV and the wall.
- Avoid installing your HDTV in places with high humidity, dust, or smoke so you do not shorten the service life of the electronic components.
- Install your HDTV in a level, landscape orientation, with the VIZIO logo at the bottom to prevent poor ventilation and excessive component damage.
- If you want to mount your HDTV on the wall, see below for additional information.
- Read this user manual carefully before installing your HDTV.

VIZIO offers professional installation services including home networking. Contact VIZIO for more information on these services at **877-MYVIZIO** (877-698-4946) or [www.VIZIO.com](http://www.VIZIO.com).

## Attaching the E421VL TV Stand

**Note:** We strongly recommend that two people perform the setup and assembly due to the weight and size of the TV.

### Unpack the TV and stand base:

1. Remove the remote control, batteries, and power cord from the foam end caps.
2. Remove the two top foam end caps.
3. Remove the stand base from the packaging.
4. Remove the TV from the box and lay it face down on a clean, flat surface.

**Note:** Make sure that the surface is free of debris to prevent the TV screen from getting scratched.

### Attach the TV stand base:

1. Push the stand base onto the stand neck (already connected to TV).
2. On the bottom of the base, insert the thumb screw and tighten. Move the TV into an upright position.

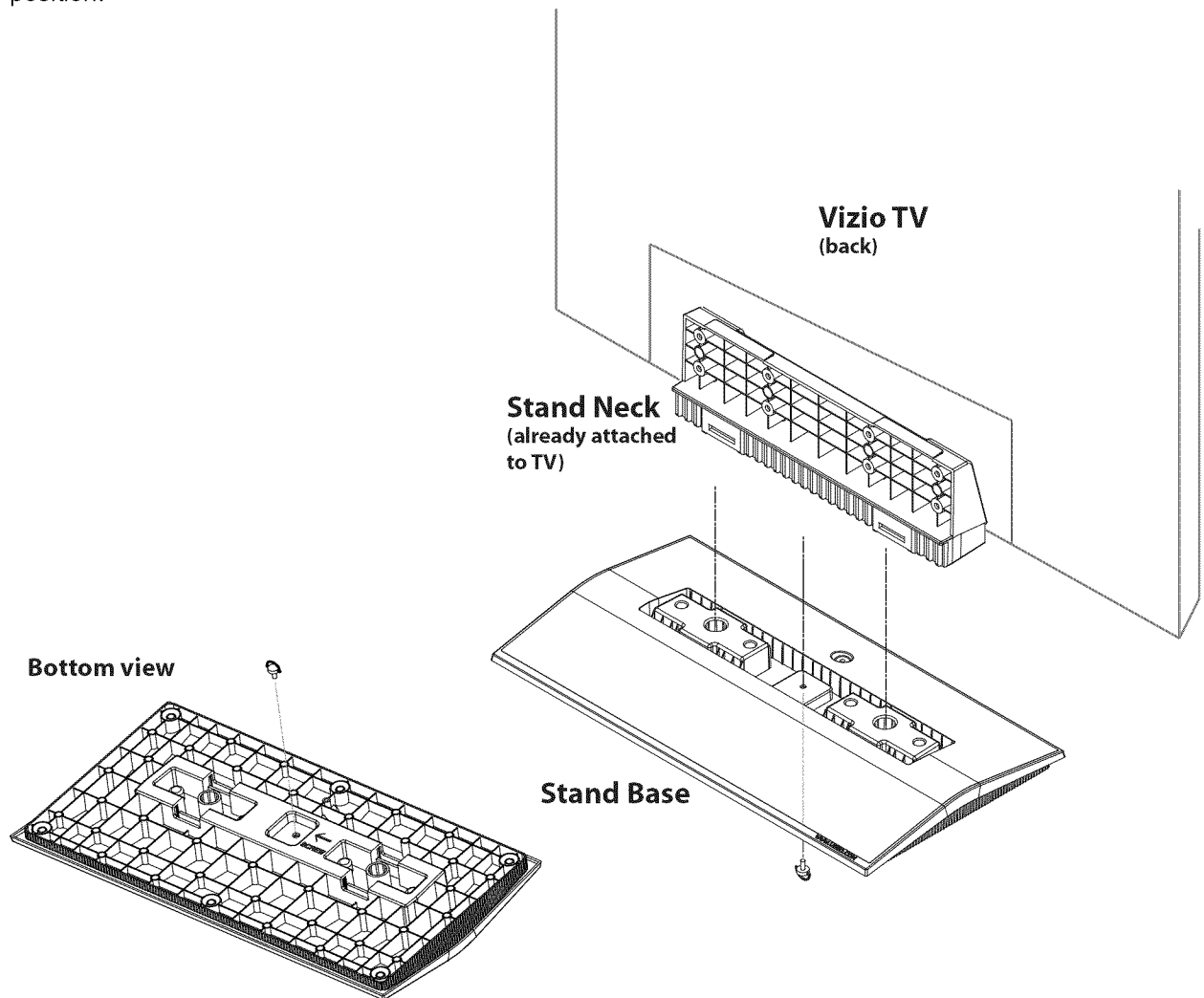



## Attaching the E470VL TV Stand

**Note:** We strongly recommend that two people perform the setup and assembly due to the weight and size of the TV.

### Unpack the TV and stand base:

1. Remove the remote control, batteries, and power cord from the foam end caps.
2. Remove the two top foam end caps.
3. Remove the stand base from the packaging.
4. Remove the TV from the box and lay it face down on a clean, flat surface.

**Note:** Make sure that the surface is free of debris to prevent the TV screen from getting scratched.

### Attach the TV stand base:

1. Align the stand base to the back of the TV.
2. Insert the four screws provided and tighten.

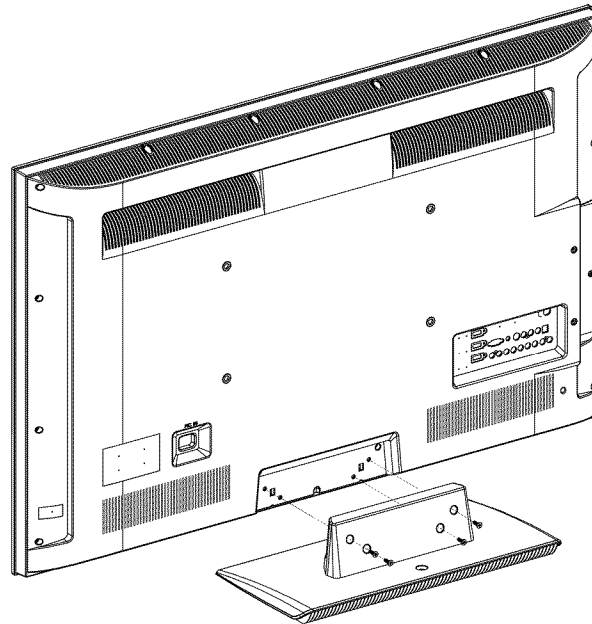

## Wall Mounting your HDTV

Your HDTV can be mounted on the wall for viewing. If you choose to mount your HDTV on the wall, follow the instructions below.

1. Write down the serial number located on the back of your HDTV in the space provided on page 1 to have it handy if you need to call for support.

2. Remove the stand base and neck:
  - a. Disconnect the cables from your HDTV.
  - b. Place your HDTV face down on a soft, flat surface to prevent damage to the screen.
  - c. Remove the six (6) screws holding the stand neck, and then remove the neck and base.

**Note:** To remove the base from the neck, unscrew thumbscrew on bottom.

3. Mount your HDTV on the wall:
  - a. Attach your HDTV to a wall mount (sold separately) using the mounting holes in the back panel of your HDTV.
  - b. Read the instructions that came with your specific wall mount to properly hang your HDTV.

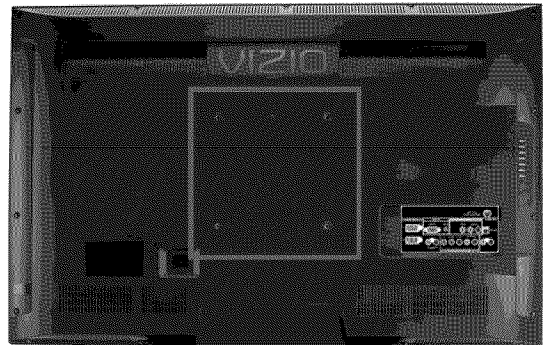

### Wall Mounting Specifications (E421VL & E470VL)

Screw Size	M6
Screw Length	20.0 mm
Screw Pitch	1.0 mm
Hole Pattern	VESA standard 200 x 200 mm spacing

### Wall Mounting Specifications (E551VL)

Screw Size	M8
Screw Length	25 mm
Screw Pitch	1.25 mm
Hole Pattern	VESA standard 400 x 200 mm spacing

## Chapter 2 Basic Controls and Connections

### Front Panel

1. **Remote Control Sensor**—Point the remote control directly at this window on the lower left corner of your HDTV for the best response to the remote signal.
2. **POWER 'VIZIO' LIGHT**—The VIZIO name lights white when powered on and orange when powered off.

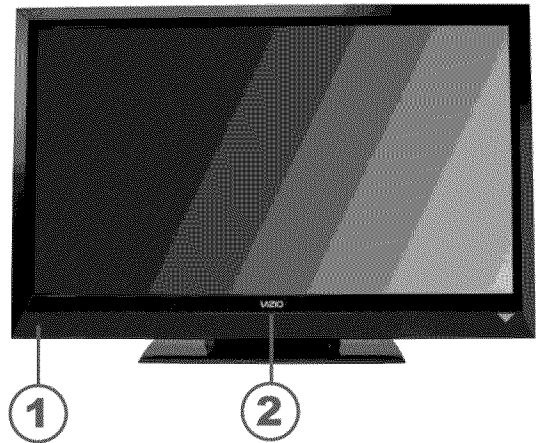

### Side Panel Controls

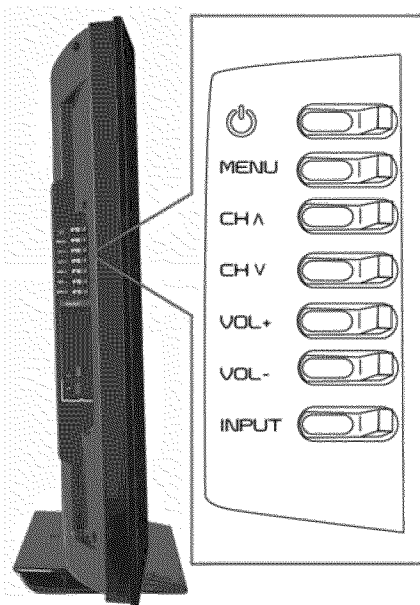

**POWER** (  )—Turn your HDTV on by pressing the button once. Press the button again to turn your HDTV off.

**MENU**—Press to launch the on-screen menu. If a sub-menu is active, this button will proceed to the next level.

**CH ▲/▼**—Press to change the channels up or down. While the menu is active, these buttons function as up and down controls.

**VOL + / -**—Press to increase or decrease the speaker volume. While the menu is active, these buttons function as left and right controls.

**INPUT (ENTER)** —Press to cycle through the various devices connected to your TV (called Inputs). The inputs cycle in the following sequence: TV, AV, Comp, HDMI-1, HDMI-2, HDMI SIDE, RGB, and Media. After you have stepped through the entire sequence, you will return to the beginning.

Additionally, when the OSD is active, this button confirms the menu function to be adjusted.

### Side Panel Connection

**HDMI**—Connect digital video devices such as a DVD player or Set-Top Box through this all digital connector. There are additional HDMI connectors on the back.

**USB:**

- Insert a FAT/FAT32 formatted USB drive to view pictures.
- Service port for use by a professional service technician.

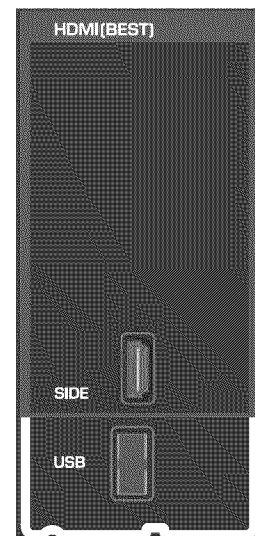

## Rear Panel Connections

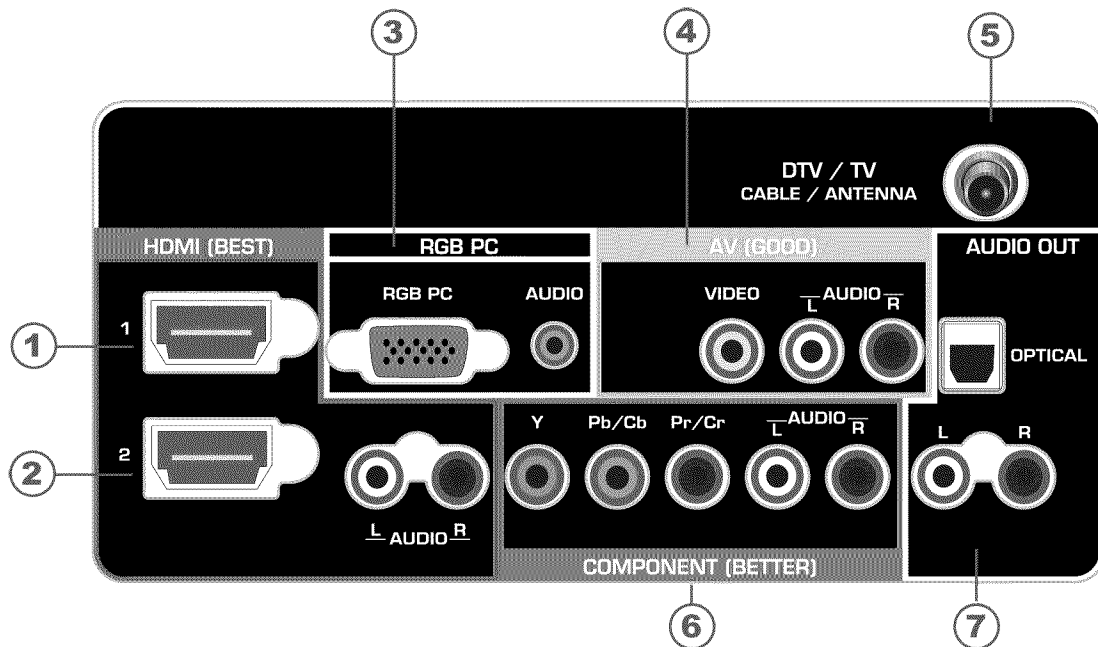

1. **HDMI 1**—Connect digital video devices such as a DVD player or Set-Top Box through this all digital connector. There is an additional HDMI connector on the side.
2. **HDMI 2 with L/R Audio**—Connect another digital video device such as a DVD player or Set-Top Box through this all digital connector. For users who want to connect to a DVI enabled device, use a DVI-HDMI cable and connect the analog audio output of the device to the **L / R AUDIO** here. Your VIZIO Certified HDMI-DVI cables are available for purchase from [www.VIZIO.com](http://www.VIZIO.com) or by calling **877-MYVIZIO** (877-698-4946).
3. **RGB PC**—Connect the video and audio from a computer here. Connect a 1/8" mini plug stereo connector from the computer to the TV if you want the sound to come from the HDTV speakers.
4. **AV**—Connect composite video devices, such as a VCR or game console. Use the white and red connectors to connect the external audio from the same source.
5. **DTV/TV**— Connect to an antenna or digital cable source. For digital TV stations in your area visit [www.antennaweb.org](http://www.antennaweb.org). For cable and satellite Set-Top boxes, we recommend that you use a HDMI or component cable connection for high definition image quality.
6. **COMPONENT (Y Pb/Cb Pr/Cr with L/R Audio)**—Connect component video devices such as a DVD Player or set top box here.
7. **AUDIO OUT:**
  - **OPTICAL**—When digital TV is selected for viewing, the audio associated with the programming will be available on the S/PDIF Optical connector for connection to a VIZIO Sound Bar or your Home Theater system.
  - **ANALOG L/R**—Connect the audio from the HDTV to an external device, such as a home theater system, external amplifier, or stereo. Speakers cannot be connected directly here.

## Chapter 3 VIZIO Remote Control

### Installing the Batteries

1. Remove the battery cover.
2. Insert the batteries into the remote control. Make sure that you match the (+) and (-) symbols on the batteries with the (+) and (-) symbols inside the battery compartment.
3. Replace the battery cover.

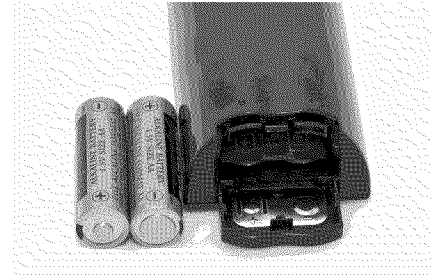

#### Precautionary Tips for Inserting the Batteries:

- Do not mix new and old batteries. This may result in cracking or leakage that may cause a fire or lead to personal injury.
- Inserting the batteries incorrectly may also result in cracking or leakage that may cause a fire or lead to personal injury.
- Dispose of batteries according to local hazardous waste regulations.
- Keep the batteries away from children and pets.

#### Remote Control Range

- Point the remote control directly at this sensor for the best response to the remote signal.
- Do not place any obstacles between the remote control and the remote control sensor.
- The effective range of the remote control is approximately 22 feet (7 meters) from the front of the remote control sensor, 30° to the left and right, 20° up and down.

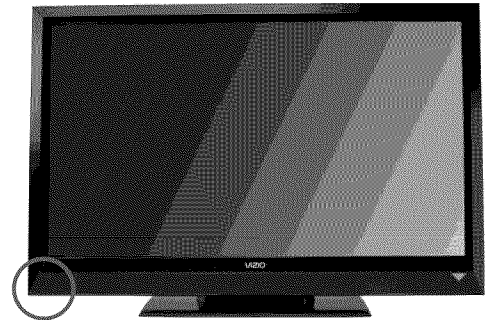

#### VIZIO Remote Control Precautions

- The remote control should be kept dry and away from heat sources. Avoid humidity.
- If the TV responds erratically to the remote control or does not respond at all, check the batteries. If the batteries are low or exhausted, replace them with fresh batteries.
- When not using the remote control for a long period of time, remove the batteries.
- Do not take the batteries apart, heat them, or throw them into a fire.
- Do not subject the remote control to undue physical stress, such as striking or dropping it.
- Do not attempt to clean the remote control with a volatile solvent. Wipe it with a clean, damp cloth.

## E421VL Remote Control Buttons

**POWER** (  )—Press to turn the TV on from the Standby mode. Press it again to return to the Standby mode.

### CEC-Supported Buttons:

CEC needs to be set up and enabled for these buttons to work. See *CEC* on page 44 for more information.

- (Record)—Press to begin recording on your CEC-supported device.
- ⏸ (Pause)—Press to pause playback on your CEC-supported device.
- ▶ (Play)—Press to start Playback on your CEC-supported device.
- (Stop)—Press to stop playback/recording on your CEC-supported device.
- ⏮ (Previous)—Press to skip the previous track on your CEC-supported device.
- ◀ (Reverse)—Press to reverses playback on your CEC-supported device.
- ▶▶ (Fast Forward)—Press to fast forward playback on your CEC-supported device.
- ▶▶ (Next)—Press to skip to the next chapter on your CEC-supported device.

**EXIT**—Press to exit from open menus.

**MENU**—Press to open the On-Screen Display (OSD) menu.

**OK**—Press this button to display the Channel List. Press to confirm selections for On-Screen Display (OSD) menus.

**Silver Diamond** (represented by ▲▼◀▶ in the manual instructions)—Pressing up, down, left, or right on the points of the diamond are used to navigate the OSD menu. They will also be used as value settings when the slide bar is shown on the screen and option settings to turn a feature off or on.

**BACK**—Press to return to a previous OSD menu.

**GUIDE**—Press to display detailed program information when viewing a digital TV program.

**Color Buttons (Yellow, Blue, Red, & Green)**—These buttons currently do not operate any functions on your HDTV.

**VOL +/-** —Press to turn the volume up or down.

**MEDIA** – Use this button to access the USB drive to view your pictures.

**MUTE**—Press to turn the sound on and off.

**LAST**— Press to recall the previously viewed channel.

**CH +/-** —Press to change the channels up or down

**HDMI**—Press to select the HDMI input. Press repeatedly to cycle between both HDMI inputs.

**AV**—Press to select the AV input.

**TV**—Press to select the TV input.

**Number Button Pad**—Press to select a channel or enter a password.

**INPUT**—Press to cycle through the various devices connected to your TV (called Inputs). The inputs cycle in the following sequence: TV, AV, Comp, HDMI-1, HDMI-2, HDMI SIDE, RGB, and Media. After you have stepped through the entire sequence, you will return to the beginning.

- (**DASH**)—Press to insert a dash between the main and sub-channels. For example, channel 28-2 would be selected by the button sequence 2, 8, DASH, 2.

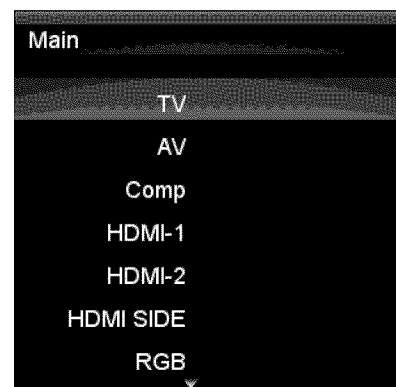
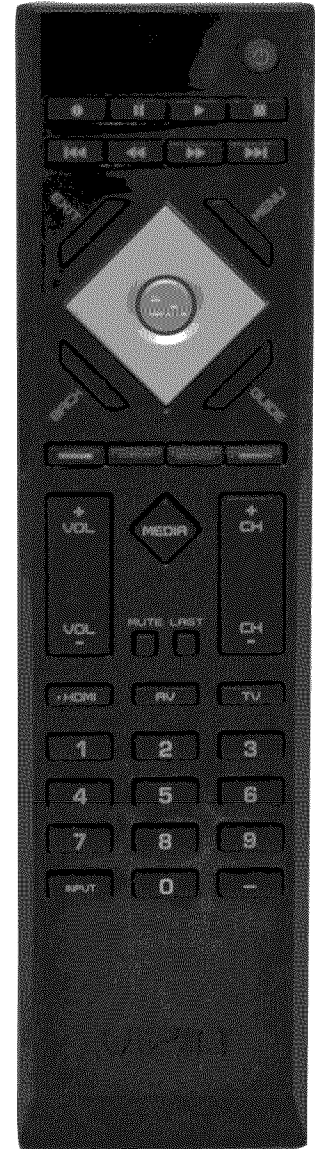

## E470VL & E551VL Remote Control Buttons

**POWER** (  )—Press to turn the TV on from the Standby mode. Press it again to return to the Standby mode.

### Device Buttons:

- **DVD**—Press to select a DVD player that has been programmed to work with this remote. See page 46 to program your remote control.
- **AUDIO**—Press to select a Home Theater System or Audio Amplifier that has been programmed to work with this remote. See page 46 to program your remote control.
- **CABLE**—Press to select a cable or satellite Set-Top box that has been programmed to work with this remote. See page 46 to program your remote control.
- **TV**—Press to return to TV mode. If the remote is not working, press this button to return the functions back to TV.

### CEC-Supported Buttons:

CEC needs to be set up and enabled for these buttons to work. See *CEC* on page 44 for more information.

- (Record)—Press to begin recording on your CEC-supported device.
- **II** (Pause)—Press to pause playback on your CEC-supported device.
- **▶** (Play)—Press to start Playback on your CEC-supported device.
- **■** (Stop)—Press to stop playback/recording on your CEC-supported device.
- **⏮** (Previous)—Press to skip the previous track on your CEC-supported device.
- **⏪** (Reverse)—Press to reverses playback on your CEC-supported device.
- **⏩** (Fast Forward)—Press to fast forward playback on your CEC-supported device.
- **⏭** (Next)—Press to skip to the next chapter on your CEC-supported device.

**EXIT**—Press to exit from open menus.

**MENU**—Press to open the On-Screen Display (OSD) menu.

**OK**—Press this button to display the Channel List. Press to confirm selections for On-Screen Display (OSD) menus.

**Silver Diamond** (represented by **▲▼◀▶** in the manual instructions)—Pressing up, down, left, or right on the points of the diamond are used to navigate the OSD menu. They will also be used as value settings when the slide bar is shown on the screen and option settings to turn a feature off or on.

**BACK**—Press to return to a previous OSD menu.

**GUIDE**—Press to display detailed program information when viewing a digital TV program.

**Color Buttons (Yellow, Blue, Red, & Green)**—These buttons currently do not operate any functions on your HDTV.

**VOL +/-** —Press to turn the volume up or down.

**MEDIA** – Use this button to access the USB drive to view your pictures.

**MUTE**—Press to turn the sound on and off.

**LAST**— Press to recall the previously viewed channel.

**CH +/-** —Press to change the channels up or down

**HDMI**—Press to select the HDMI input. Press repeatedly to cycle between both HDMI inputs.

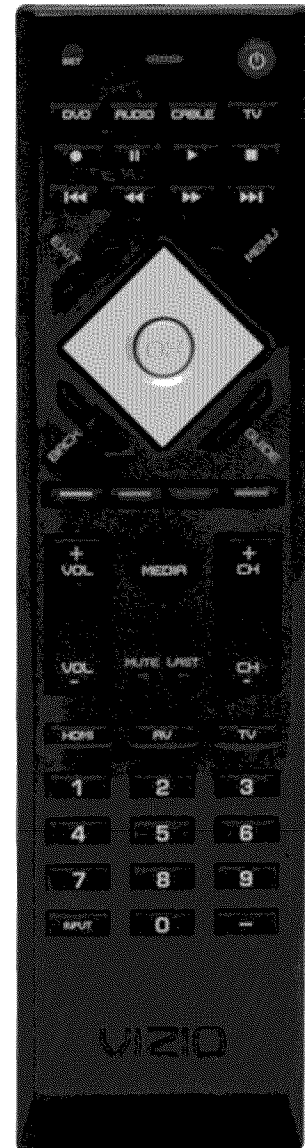

**AV**—Press to select the AV input.

**TV**—Press to select the TV input.

**Number Button Pad**—Press to select a channel or enter a password.

**INPUT**—Press to cycle through the various devices connected to your TV (called Inputs). The inputs cycle in the following sequence: TV, AV, Comp, HDMI-1, HDMI-2, HDMI SIDE, RGB, and Media. After you have stepped through the entire sequence, you will return to the beginning.

- **(DASH)**—Press to insert a dash between the main and sub-channels. For example, channel 28-2 would be selected by the button sequence 2, 8, DASH, 2.

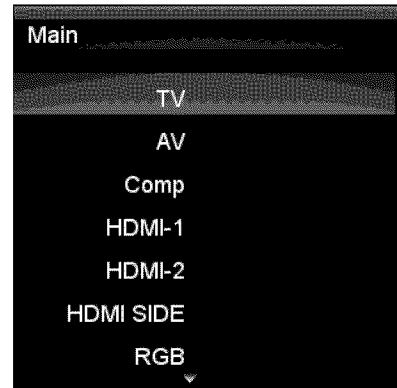

## Chapter 4 Getting Started

Your HDTV has a built-in setup App that runs when you turn on your TV for the first time. Follow the on-screen directions to easily setup your new HDTV.

1. Insert the batteries into the remote control.
2. Connect the power cord to the power cord connector on the back of your HDTV, and then plug the power cord into an AC wall socket.
3. Connect your devices to your HDTV (see Chapter 6 for detailed steps).
4. Turn on your TV. The Setup App will automatically play and guide you thru the initial setup of your HDTV. Use the Arrow and OK buttons to navigate through the setup App. During the setup process you will:
  - Choose your Menu language
  - Set the TV to Home Mode for the best picture and most efficient energy usage.
  - Set your Time Zone and Daylight Savings preferences
  - Add your TV channels (unless you have a Cable/Satellite Set-Top Box)

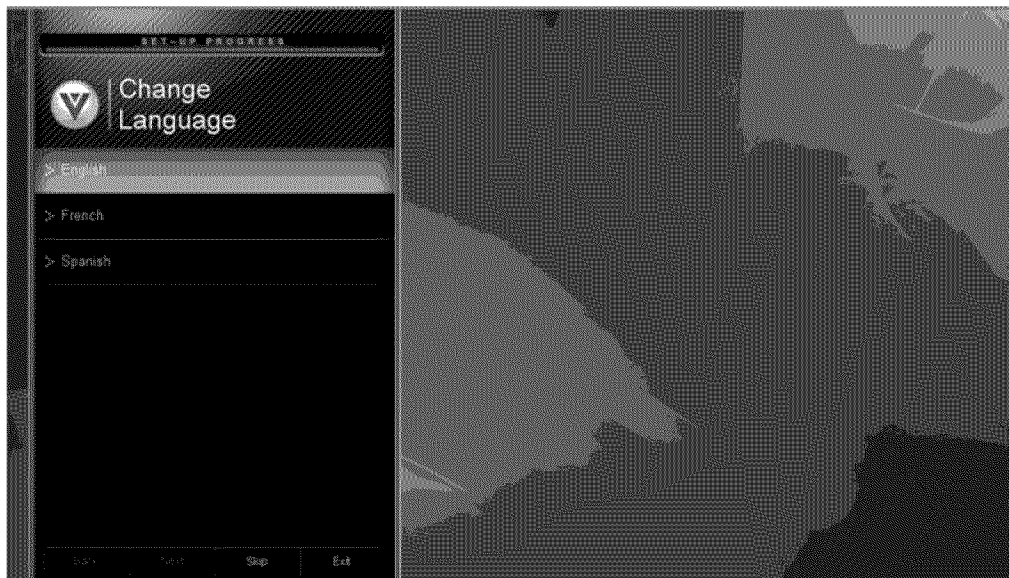



## Chapter 5 Using your HDTV for the first time

### Select Input Source

Select the input source for your HDTV by pressing the **INPUT** button on the remote control or the side of your TV. Pressing this button will cycle you through the following options: TV, AV, Comp, HDMI-1, HDMI-2, HDMI SIDE, RGB, and Media.

Turn on your device and you will see a picture on your HDTV. If there is no picture, make sure you have selected the correct input on your HDTV.

**Note:** If the selected device is RF connected, your HDTV needs to be in **TV** mode and on either channel 3 or channel 4 matching the channel which has been selected on the back of the VCR, Cable Box, External TV Tuner or Satellite Receiver. Refer to Owner or User's Manual of such equipment for details.

### Watching a TV Program

Before you start watching TV, make sure that any cable, satellite or off-air antenna connections are secure. Also, verify that the AC/DC power adapter is plugged into a correctly grounded electrical outlet or surge protector.

1. Press the power button on the remote control. The VIZIO logo on the front will light up white.
2. Select the input to which your device is connected that provides TV programming (i.e. TV, HDMI, COMP).

**Note:** You should be able to see a picture. If you do not, make sure that all of your HDTV connections are secure and you have selected the correct video input source. Each press of the **INPUT** button on the remote control will cycle through the available inputs. Press the button until the input associated with the device you want to view is shown.

3. When using the TV input, press the channel buttons on the remote control or the TV to change the channel. The channel buttons will not work if you are watching a program using HDMI, Component, or AV inputs.

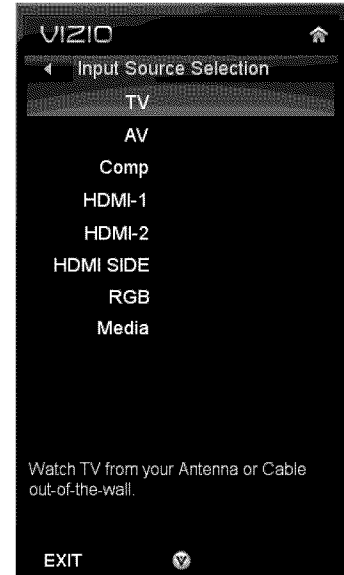

## Viewing Digital TV Program Information



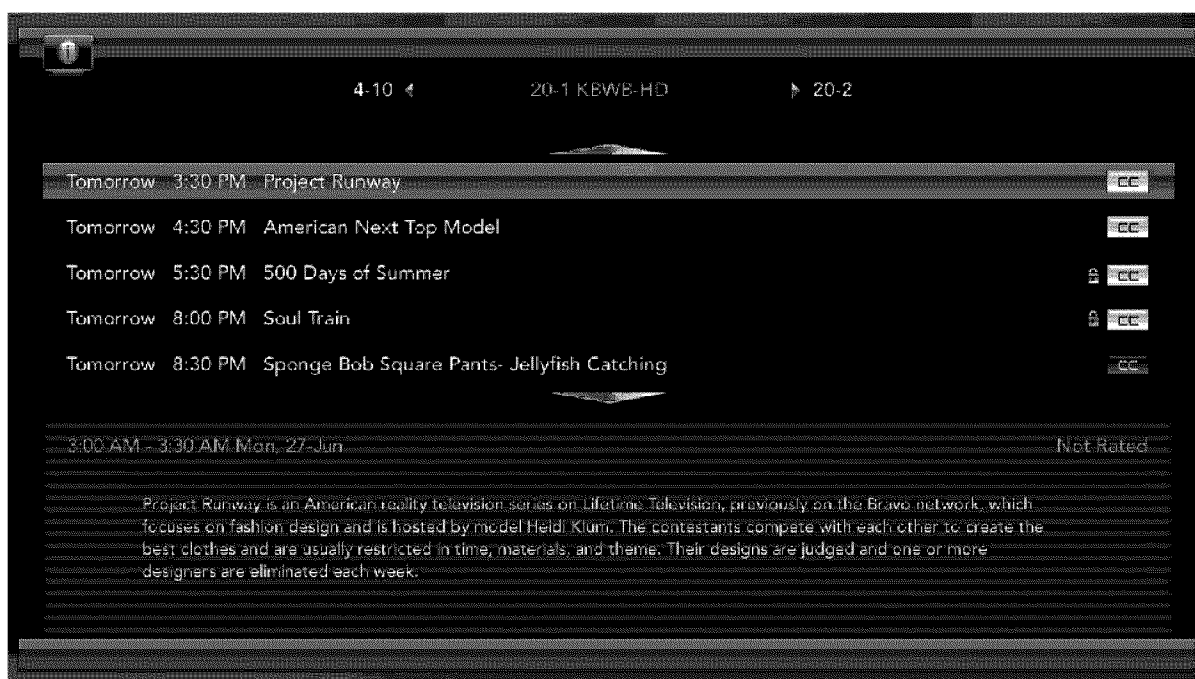
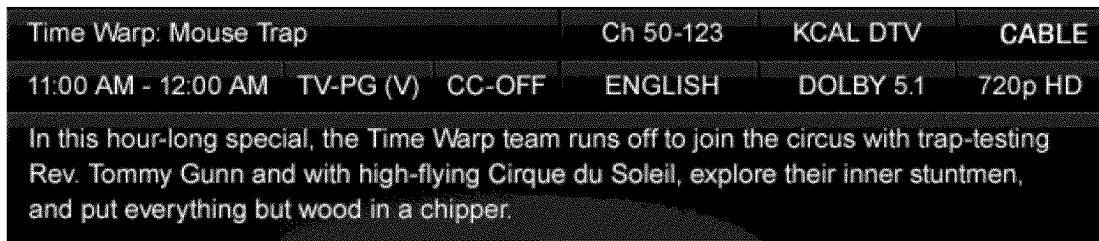

When the channel is changed or when you press the **GUIDE** button, an information header is shown over the picture for a few seconds. Each press of the **GUIDE** button will display more information about the program:

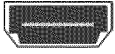

## Chapter 6 Connecting Equipment

### Which Video Connection Should I Use?

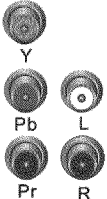
You have six options for connecting your video equipment box to your HDTV from a basic connection to the most advanced for digital displays. Based on your Home Theater configuration, you can decide which option is the right one for you.

Connection Quality (type)	Connector	Description
Best (digital)	 HDMI	<b>HDMI</b> delivers the best image quality of any of the cable types available and it's all done over one cable. You get a great picture and cut down on your cable clutter. HDMI provides digital quality and amazing sound so if your TV has HDMI, this is the connection type you should be using.
Best (digital) ----- Good (analog)		Connect your <b>antenna</b> or <b>coaxial</b> cable to watch TV programming. This cable usually comes from your cable box or right out of the wall.
Best (analog)	 VGA	The <b>RGB (VGA)</b> port allows you to connect your computer so you can use the TV as your monitor.
Better (analog)	 Y Pb L Pr R	<b>Component</b> consists of three cables for transmitting video and two cables for transmitting audio: one red and one white. Component video provides a sharper image than Composite video and should be used instead of composite when possible. However, because it is still an analog connection, it won't provide the high-quality video and audio that HDMI can produce.
Good (analog)	 VIDEO L R	<b>Composite</b> consists of one yellow cable for transmitting video and two cables for transmitting audio: one red and one white. It is capable of transmitting stereo sound and standard definition video (480i). While it provides a good image, it has lower image quality than HDMI or Component. So try to use one of those connections first.

**Note:** To maintain the display quality, use a VIZIO certified HDMI cable. This cable is available in 6, 8, and 12 foot lengths. Visit [www.vizio.com](http://www.vizio.com) or call 1-888-VIZIOCE (1-888-849-4623) for details.

## Connecting Your Cable or Satellite Box

### Using HDMI (Best)

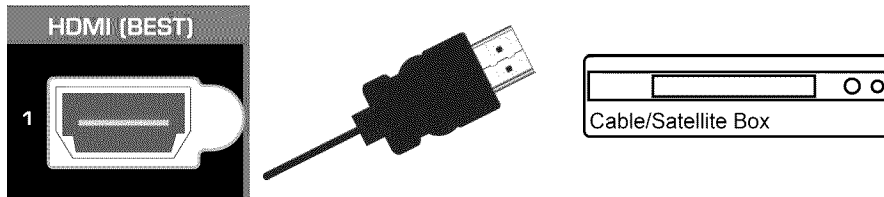

Cable and Satellite Boxes that have a HDMI digital interface should be connected using HDMI for optimal results. To maintain image quality, use a VIZIO certified HDMI cable. This cable is available in 6, 15, and 30 foot lengths. Visit [www.VIZIO.com](http://www.VIZIO.com) or call **877-MYVIZIO** (877-698-4946) for details.

1. Turn off your HDTV and cable/satellite box.
2. Connect an HDMI cable to the **HDMI** output of your cable/satellite box and the other end to the **HDMI 1** or **2** jack on your HDTV.
3. Turn on the power to your HDTV and your cable/satellite box.
4. Select **HDMI-1**, **HDMI-2**, or **HDMI SIDE** using the **INPUT** button on the remote control or side of the TV.

#### Note:

- The HDMI input on your HDTV supports High-bandwidth Digital Content Protection (HDCP). HDCP encrypts the transmission between the video source and the digital display for added security and protection.
- Refer to your cable/satellite Set-Top box user manual for more information about the video output requirements of the product or consult your cable or satellite operator.

### HDMI Connections for Cable or Satellite Boxes with DVI

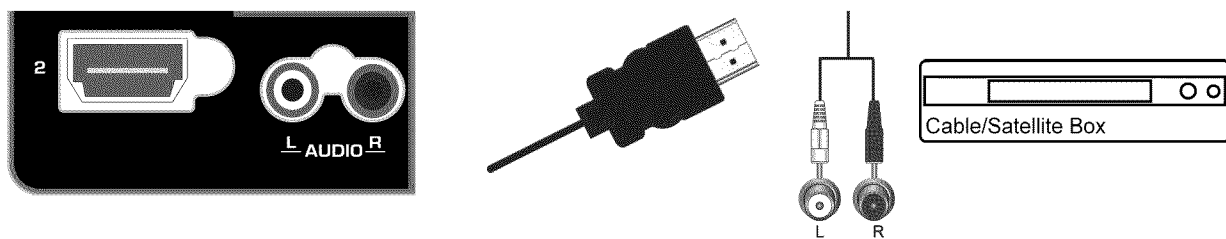

1. Turn off the power to your HDTV and HDTV cable/satellite box.
2. Using a HDMI-DVI cable, connect the DVI end to your cable/satellite box and the HDMI end to the **HDMI 2** jack on your HDTV.
3. Connect the audio cables (white and red) from the DVI audio output jacks on the cable/satellite box to the **HDMI 2 L** and **R AUDIO** jacks on your HDTV.
4. Turn on the power to your HDTV and your cable/satellite box.
5. Select **HDMI-2** using the **INPUT** button on the remote control or side of the TV.

### Using Component Video (Better)

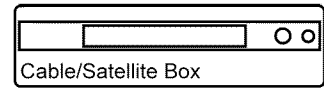
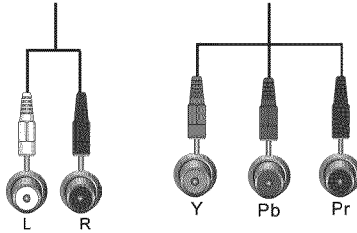
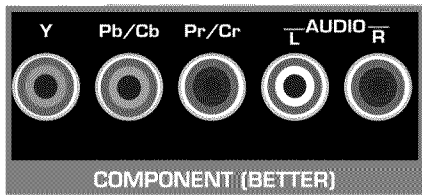

1. Turn off your HDTV and cable/satellite box.
2. Connect the component cables (green, blue, and red) from your cable/satellite box to the **COMPONENT** jacks on your HDTV.
3. Connect the audio cables (white and red) from your Set-Top box to the **COMPONENT L** and **R AUDIO** jacks on your HDTV.
4. Turn on your HDTV and cable/satellite box.
5. Select **Comp** using the **INPUT** button on the remote control or side of the TV.

### Using Composite Video (Good)

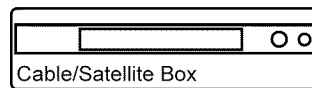
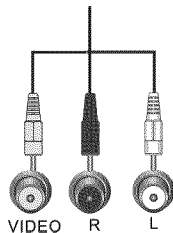
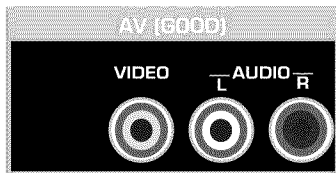

1. Turn off your HDTV and Set-Top box.
2. Connect the video cable (yellow) from your Set-Top box to the **AV** jack (yellow) on your HDTV.
3. Connect the audio cables (white and red) on your Set-Top box to the **AV L** and **R AUDIO** jacks on your HDTV.
4. Turn on your HDTV and Set-Top box.
5. Select **AV** using the **INPUT** button on the remote control or side of the TV.

### Using Coaxial (Antenna) (Good)



COAXIAL

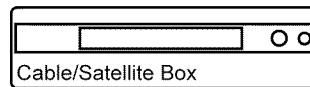

1. Turn off the power to your HDTV.
2. Connect the coaxial (RF) connector from your antenna or digital cable to the **DTV/TV CABLE/ANTENNA** connector on your HDTV.
3. Turn on the power to your HDTV.
4. Select **TV** using the **INPUT** button on the remote control or side of the TV.
5. Search for new channels. See *Auto Channel Scan* on page 24 for more information on scanning for channels.

## Connecting Your DVD Player

### Using HDMI (Best)

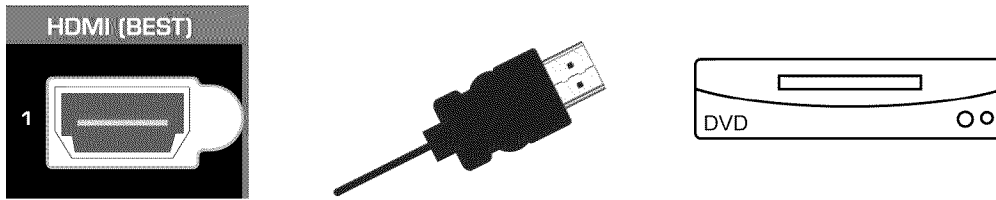

DVD players that have a HDMI digital interface should be connected using HDMI for optimal results. To maintain image quality, use a VIZIO certified HDMI cable. This cable is available in 6, 15, and 30 foot lengths. Visit [www.VIZIO.com](http://www.VIZIO.com) or call **877-MYVIZIO** (877-698-4946) for details.

1. Turn off your HDTV and DVD player.
2. Connect a HDMI cable to the HDMI output of your DVD player and the other end to the **HDMI 1** or **2** jack on your HDTV.
3. Turn on the power to your HDTV and your DVD player.
4. Select **HDMI-1**, **HDMI-2**, or **HDMI SIDE** using the **INPUT** button on the remote control or side of the TV.

#### Note:

- The HDMI input on your HDTV supports High-bandwidth Digital Content Protection (HDCP). HDCP encrypts the transmission between the video source and the digital display for added security and protection.
- Refer to your DVD player user manual for more information about the video output requirements.

### HDMI Connections for DVD Players with DVI

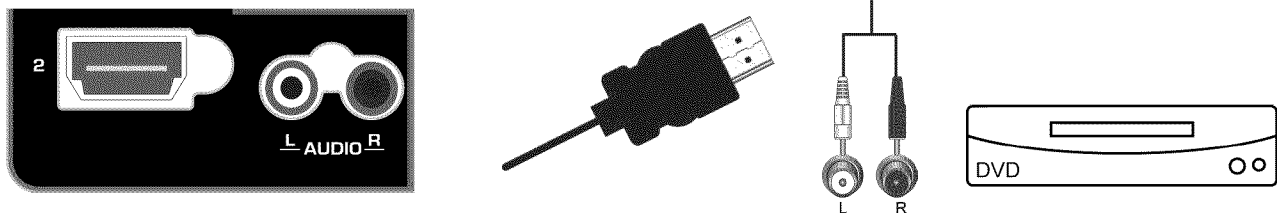

1. Turn off your HDTV and DVD player.
2. Using a HDMI-DVI cable, connect the DVI end to your DVD player and the HDMI end to the **HDMI 2** Jack on your HDTV.
3. Connect the audio cables (white and red) from the DVI audio output jacks on the DVD player to the **HDMI 2 L** and **R AUDIO** jacks on your HDTV.
4. Turn on the power to your HDTV and your DVD player.
5. Select **HDMI-2** using the **INPUT** button on the remote control or side of the TV.

### Using Component Video (Better)

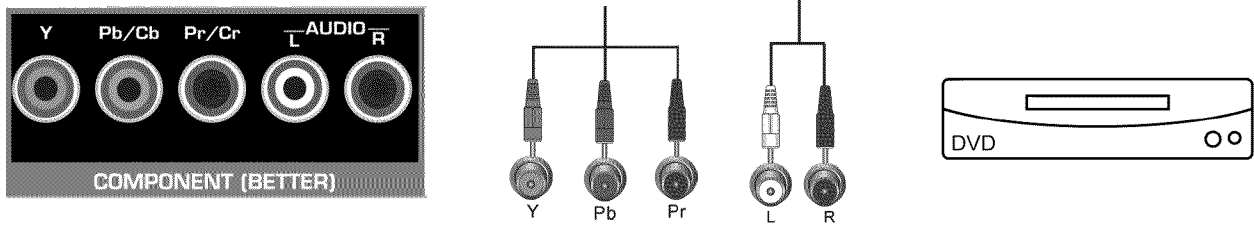

1. Turn off the power to your HDTV and DVD player.
2. Connect the component cable (green, blue, and red) from your DVD player to the **COMPONENT** jacks on your HDTV.
3. Connect the audio cables (white and red) from your DVD player to the **COMPONENT L and R AUDIO** jacks on your HDTV.
4. Turn on the power to your HDTV and DVD player.
5. Select **COMP** using the **INPUT** button on the remote control or side of the TV.

### Using Composite (AV) Video (Good)

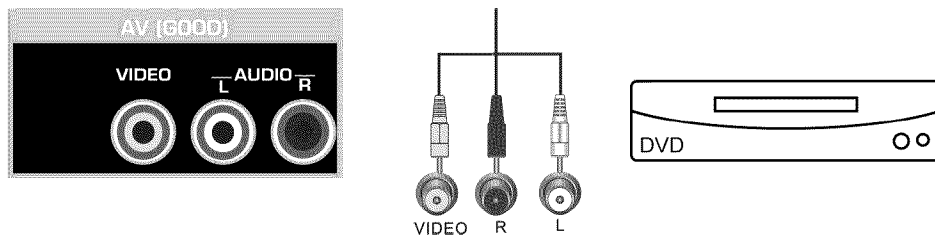

1. Turn off the power to your HDTV and DVD player.
2. Connect the Video cable (yellow) from your DVD player to the **AV** jack on your HDTV.
3. Connect the audio cables (white and red) on your DVD player to the **AV L and R AUDIO** jacks on your HDTV.
4. Turn on the power to your HDTV and DVD Player.
5. Select **AV** using the **INPUT** button on the remote control or side of the TV.

## Connecting Coaxial (RF)

### Using Your Antenna or Digital Cable for Standard or Digital TV

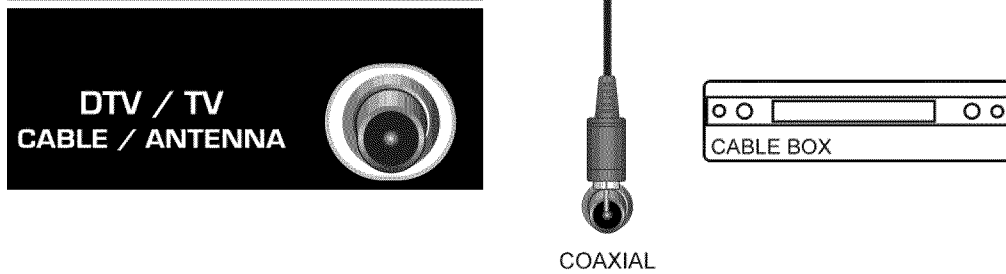

1. Turn off the power to your HDTV.
2. Connect the coaxial (RF) connector from your antenna or cable to the **DTV/TV CABLE/ANTENNA** connector on your HDTV.
3. Turn on the power to your HDTV.
4. Select **TV** using the **INPUT** button on the remote control or side of the TV.
5. Search for new channels. See *Auto Channel Scan* on page 40 for more information on scanning for channels.

## Connecting Your VCR or Video Camera

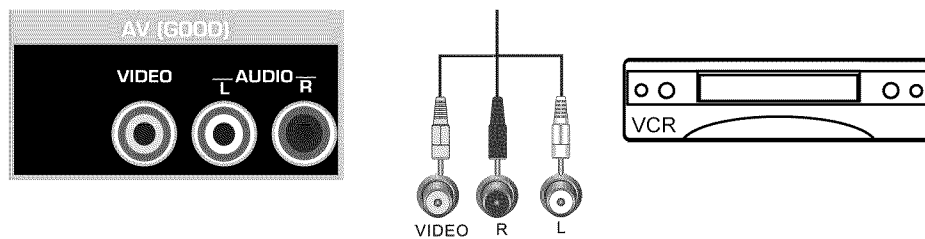

**Note:** Refer to your VCR or Video Camera user manual for more information about the video output requirements of the product.

1. Turn off the power to your HDTV and VCR or video camera.
2. Connect the yellow AV cable from your VCR or video camera to the **AV** jack on your HDTV.
3. Connect the audio cables on your VCR or video camera to the corresponding **L** and **R AUDIO** jacks on your HDTV.
4. Turn on the power to your HDTV and VCR or video camera.
5. Select **AV** using the **INPUT** button on the remote control or side of the TV.



## Connecting a Home Theater System

### Using RCA

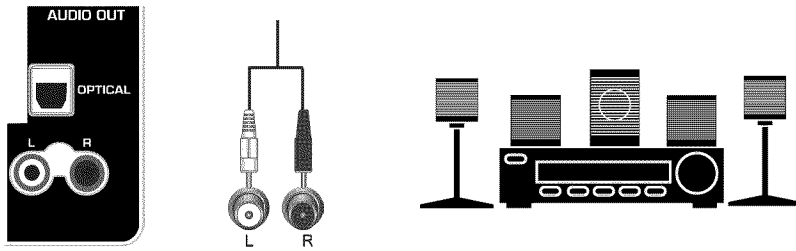

1. Turn off the power to the HDTV and Receiver/Amp.
2. Using an audio cable (white and red connectors), connect the cable to the audio input connectors on the Receiver/Amp and connect the other end to the **AUDIO OUT** audio connectors on the back of the HDTV.
3. Turn on the power to the HDTV and Receiver/Amp.
4. Press the **MENU** button on the remote control to open the On-Screen Display (OSD) menu.
5. Press **▼** on the remote control to highlight the Audio menu, and then press **OK** to select.
6. Press **▼** on the remote control to select **TV SPEAKERS**.
7. Press **▶** on the remote control to select **OFF** so the sound from the HDTV will be routed through your Receiver/Amp system.

#### Notes:

- Refer to your Receiver/Amp user manual to select the corresponding audio input.
- The audio output is not amplified and cannot be connected directly to external speakers.

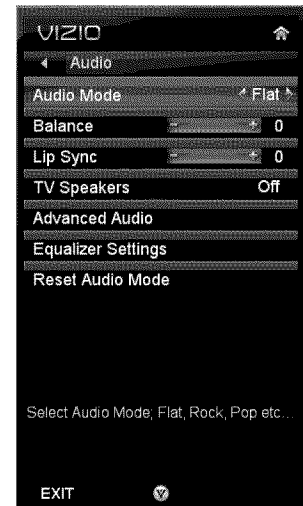

### Using Optical (S/PDIF)

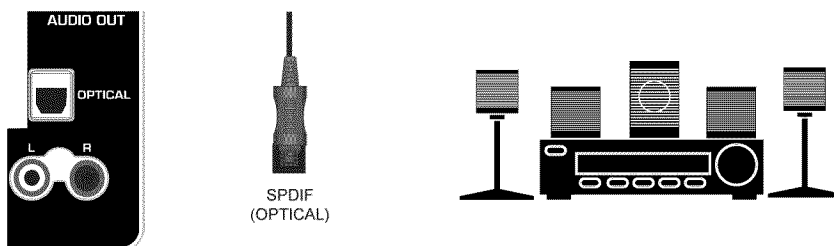

If your sound system has a S/PDIF (optical) digital audio input you can connect it from your sound system to the **OPTICAL** digital audio out on your HDTV. This is active when receiving audio with the programs being viewed no matter what input is being used.

1. Connect one end of the optical cable to optical connectors on the home theater and the other end to the **OPTICAL** jack on your HDTV.
2. Turn on the power to your HDTV and home theater.
3. Change the input on your home theater to optical. See your home theater user manual for more information.

## Connecting a Computer Using RGB (VGA)

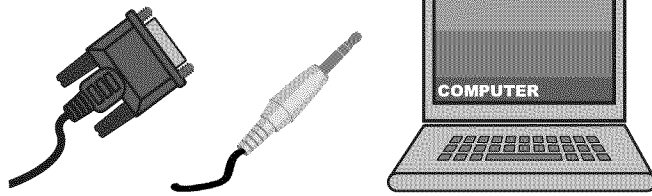
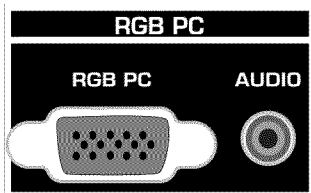

1. Set computer to a resolution supported by your HDTV (see *Preset PC Resolutions* on page 70). If your computer supports it, we recommend 1920x1080.
2. Turn off the power to your HDTV and computer.
3. Connect the RGB (VGA) cable from your computer to the **RGB PC** jack on of your HDTV.
4. Connect the 1/8-inch audio cable from your computer to the **RGB PC Audio** jack on your HDTV. This step is optional and only needed if you want to transmit audio from the computer through the TV.
5. Turn on the power to your HDTV and computer.
6. Select **RGB** (VGA) using the **INPUT** button on the remote control or side of the TV.

**Note:** Refer to your PC computer user manual for more information about the video output requirements.

## Using HDMI

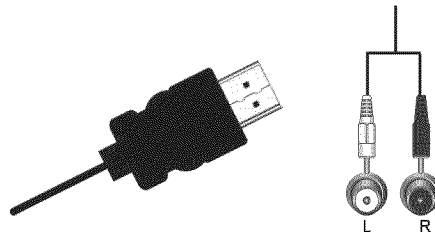
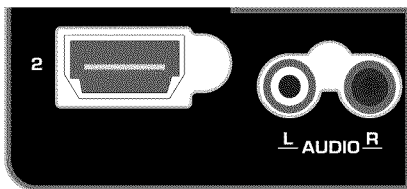

1. Turn off your HDTV and computer.
2. Connect a HDMI cable to the HDMI output of your computer and the other end to the **HDMI 3** jack on your HDTV.
3. Connect the audio cables (white and red) from the audio output jacks on the computer to the **HDMI 2 L** and **R AUDIO** jacks on your HDTV.
4. Turn on the power to your HDTV and your computer.
5. Select **HDMI-2** using the **INPUT** button on the remote control or side of the TV.

## Chapter 7 Viewing Pictures

Connect a USB flash drive to the USB port on your HDTV to view pictures.

- USB drives that are USB 2.0 and FAT or FAT32 are supported. The USB Port does not support external hard drives or USB hubs.
- If your USB drive is oversized and does not physically fit in the USB port, use a USB extension cable. Connect one end of the cable to your USB drive and the other end to the USB port.
- Supported file extensions include .jpg and .jpeg.

**Note:** Even the supported format files listed above may or may not play properly or completely, depending on the USB device, bit rate stream, and other content characteristics, as well as other factors.

### Viewing Pictures

1. Insert a USB device with digital content containing photos into the USB port on the side of your HDTV. If a USB device is already connected, press **MENU** on the remote control and select *Media*. A message will appear asking if you want to play multimedia content.
2. Press ◀ or ▶ to highlight **OK**, and then press **OK** to select it. The *Picture* folder will be displayed.
3. Press **OK** to select it. A menu will be displayed showing the folders and files that are on your USB device.
4. Press ◀ or ▶ to highlight the folder or file you want to play, and then press **OK** to select it. The file will play. See *Adjusting Photo Settings* on page 31 below to adjust various settings including setting up a slideshow and setting picture duration.
5. When finished, press **MEDIA** once to return to the previous screen or repeatedly to return to the main menu.

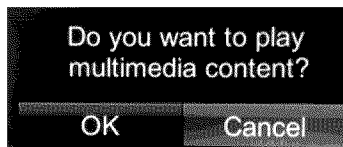

## Adjusting Photo Settings

When viewing pictures you can adjust various settings, including slideshow, picture duration, etc.

1. Insert a USB device containing pictures and select the folder or files that you want to play.
2. Press **MENU**. The Picture menu will be displayed.
3. Press **▲** or **▼** on the remote control to highlight a Picture menu option, and then press **◀** or **▶** to adjust the setting.
4. Press **MENU** once to close the menu.

### Slideshow Mode

Choose from **Shuffle**, **Single**, and **Sequence** to set the slideshow mode. Press **OK** to start and stop the slideshow.

- **Single** will display one picture selected from the thumbnails for the interval set in the *Duration* option and return to the thumbnails. If the *Repeat* option is set to **On**, the selected picture will be displayed until you press **EXIT**.
- **Sequence** will show your pictures in the order they are listed on your USB device until you stop the slideshow.
- **Shuffle** will show your pictures in random order until you stop the slideshow.

### Repeat

Choose from **On** or **Off** to repeat the slideshow.

### Sort By

You can choose to sort the pictures on the USB device by **Photo Date**, **File Date**, or alphabetically (**File A-Z**).

### Duration

Set the amount of time the picture will remain on the screen during the slideshow. Choose a time between 5 seconds and 32 seconds.

### Slideshow Effect

Choose from **Random**, **Dissolve**, **Wipe Right**, **Wipe Left**, **Wipe Up**, **Wipe Down**, **Box In**, or **Box Out** to set the transition type when changing from one picture to another during a slideshow.

### Thumbnail Size

Set the size of the preview pictures (thumbnails) in the menu. Choose from **Small**, **Medium**, or **Large**.

### Info

When set to **On**, information about the picture briefly appears on your HDTV.

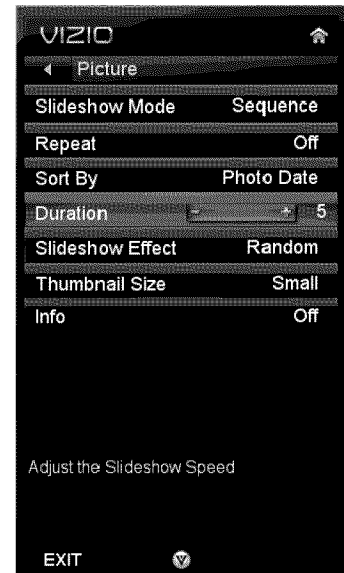

## Chapter 8 Adjusting Your HDTV Settings

### Using the On-screen Display (OSD)

The remote control or the control buttons on the side of the TV can control all the function settings. The *OSD* allows you to adjust contrast, brightness and other settings. The TV will save changes made to the settings, even if the TV is turned off.

The OSD consists of several menu options. The main menu options may vary depending on your selected input source.

**Note:** Some of the main menu options may have additional submenus, for example, the TV Rating submenu for Parental Controls.

1. Press **MENU**. The *OSD* opens.
2. Press **◀**, **▶**, **▲**, or **▼** on the remote control to select one of the menu options:
  - Input
  - Wide
  - CC
  - Sleep Timer
  - Picture
  - PIP
  - Settings
  - Media
  - Help
3. Press **OK** to select the option or feature you want to adjust.
4. After the menu option is displayed, press **▲** or **▼** on the remote control to select one of the items to adjust.
5. Press **OK** to select it, and then press **◀**, **▶**, **▲**, or **▼** to adjust the selection.
6. Press **BACK** once to return to the previous screen. To return to your program once adjustments have been completed, you can do one of the following:
  - a. Press the **EXIT** button on the remote control.

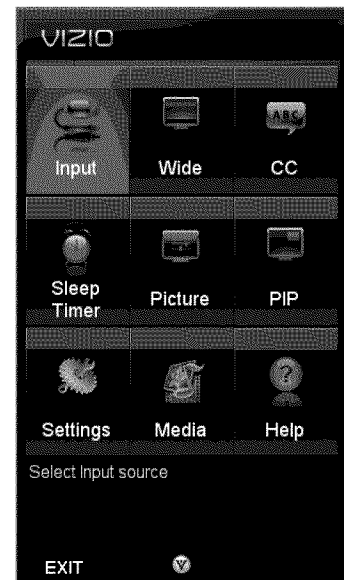

### Input Menu

Select the Input Source for your HDTV. Choose from *TV*, *AV*, *Comp*, *HDMI-1*, *HDMI-2*, *HDMI SIDE*, *RGB*, and *Media*.

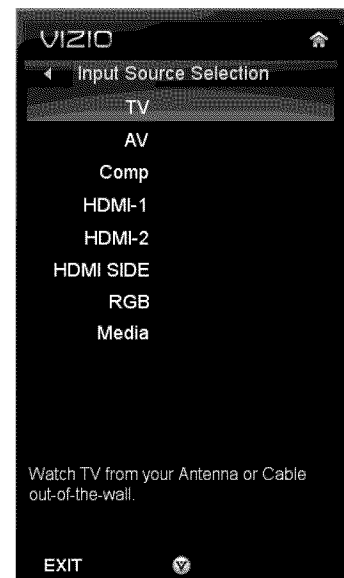

## Wide Menu

Select how the picture displays on the screen. As you select an option, you will see the screen adjusting to the different sizes. The options vary depending on the selected input and the TV program:

### Normal

The original 4:3 aspect ratio (1.33:1 source) is preserved, so black bars are added to the left and right of the display image. Standard TV broadcasts are displayed with a 4:3 Aspect Ratio. Movies in 4:3 Aspect Ratio may be referred to as pan-and-scan or full frame. These movies were originally filmed in 16:9 (widescreen), and then modified to fit a traditional TV screen (4:3).

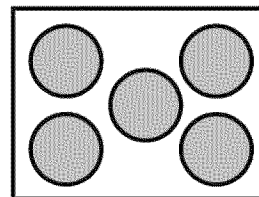

### Wide

Wide mode allows you to view the entire picture. This is recommended for HDMI and RGB (Computer) viewing so you can see the complete picture without the image overstretching beyond the viewing area. For 720p, 1080i, 1080p only.

### Zoom

Zoom mode will "zoom in" to the center of the image, allowing 4:3 images to be viewed in original aspect ratio without stretching the black bars. The top and the bottom of the image are cropped out, though.

### Panoramic

When watching a standard broadcast or full frame movie in this mode, the 4:3 Aspect Ratio (1.33:1 source) display image is stretched horizontally on the left and right sides to fill the TV screen. The center of the image is not stretched.

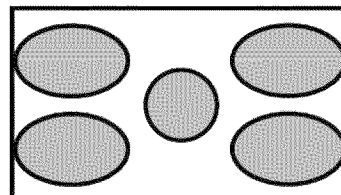

### Stretch

When watching a widescreen program (1.78:1 source) with black bars on the sides, the display image will stretch to fill the TV screen. People will appear wider than they really are. If you are watching a widescreen (1.85:1 or 2.35:1 source) program or movie, there will still be black bars at the top and bottom. This mode is available only when watching a widescreen program.

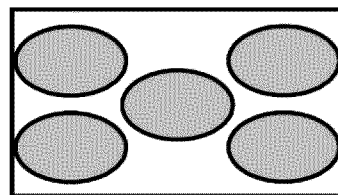

## CC (Closed Caption) Menu

Adjust closed caption options.

### Analog Closed Caption

The CC feature is available when watching regular analog TV. Select from **Off**, **CC1**, **CC2**, **CC3**, and **CC4**. Closed Caption for regular TV is usually **CC1** or **CC2**.

### Digital Closed Caption

The CC feature is available when watching digital TV. Select from **CC1**, **CC2**, **CC3**, **CC4**, or **CS1**, **CS2**, **CS3**, **CS4**, **CS5**, **CS6**, or **Off**.

### Digital CC Style

The Digital CC Style feature is available when watching digital TV.

- **Caption Style:** Select either **As Broadcaster** or **Custom**. If Custom is selected you can customize the way Closed Caption is displayed. The options available are:
  - **Text Size:** Make CC text larger or smaller.
  - **Color:** Choose a text color for CC display
  - **Opacity:** Make text more or less transparent.
  - **BG Color:** Choose a background color for CC text.
  - **BG Opacity:** Make the background for CC text more or less transparent.
  - **Window Color:** Choose a text frame color for CC text.
  - **Window Opacity:** Make the text frame for CC text more or less transparent.

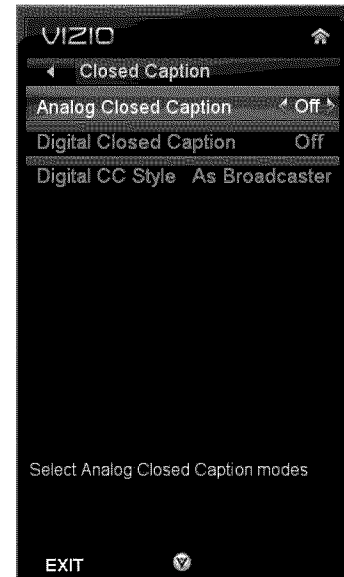

## Sleep Timer Menu

Select the timer to turn off the TV in **30**, **60**, **90**, **120** or **180** minutes.

## Picture Menu

Adjust picture options including brightness, contrast, and advanced picture settings.

### Picture Mode

Choose from **Standard**, **Movie**, **Game**, **Vivid**, **Football**, **Golf**, **Basketball**, or **Custom**. Each input (i.e. HDMI, COMP, etc) remembers the custom setting you created. Select **Custom** to manually adjust *Backlight*, *Brightness*, *Contrast*, *Color*, *Tint*, *Sharpness*, and to access the *More* menu where further adjustments can be made.

### Backlight

Adjust the brightness to affect the overall brilliance of the picture not the Brightness (black level) or Contrast (white level) of the picture.

### Brightness

Adjust black levels in the picture. If the brightness is too low you will not be able to see the detail in darker parts of the picture and if the brightness is too high the picture will look washed out.

**Note:** Brightness is only available when *Picture Mode* is set to **Custom**.



### Contrast

Adjust the white levels in the picture. If the contrast is too low the picture will look washed out and if the contrast is too high you will not be able to see any detail in the bright parts of a picture.

**Note:** Contrast is only available when *Picture Mode* is set to **Custom**.

### Color

Adjust the amount of color in the picture.

**Note:** Color is only available when *Picture Mode* is set to **Custom**.

### Tint

Adjust the hue of the picture. The easiest way to set tint is to look at flesh tones and adjust for a realistic appearance. In most cases, the default middle position is correct. If people's faces look too orange try reducing the level of color first.

**Note:** Tint is only available when *Picture Mode* is set to **Custom**.

### Sharpness

Adjust the sharpness of the edges of elements in the picture. It does not produce detail that otherwise does not exist. This adjustment is helpful when viewing Standard Definition sources.

**Note:** Sharpness is only available when *Picture Mode* is set to **Custom**.

### More

Select **More** to adjust advanced options for fine tuning the picture.

**Note:** The *More* menu is only available when *Picture Mode* is set to **Custom**.

#### Size & Position

To select the options in the Size & Position sub-menu, press **OK**. A new menu will be displayed showing the following Size & Position settings:

- **Horiz. Position**  
Adjust the horizontal position of the picture.
- **Vertical Position**  
Adjust the vertical position of the picture.
- **Horizontal Size**  
Adjust the horizontal size of the picture.
- **Vertical Size**  
Adjust the vertical size of the picture.

**Note:** The Size & Position function is only available in HDMI, Component, or RGB modes.

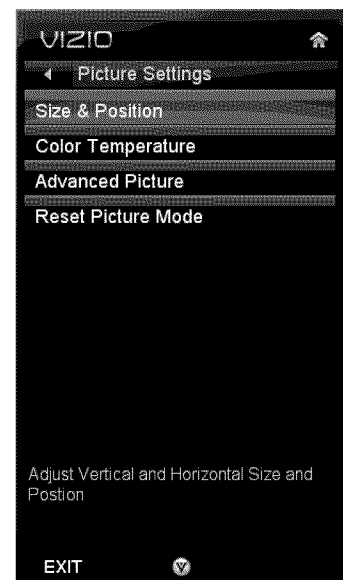



## Color Temperature

Color Temperature is the “warmness” or “coolness” of the white areas of the picture. Choose from **Custom**, **Cool**, **Normal**, or **Computer**. **Normal** is the setting for television broadcasting. **Custom** allows you to set a preset calibrated for a white point to suit individual preferences. **Cool** produces a blue-hued image. **Computer** sets the white point at the established setting for a computer display (9300K). Each preset may also be adjusted for a customized setting.

## Advanced Picture

To select the options in the Advanced Picture sub-menu, press **OK**. A new menu will be displayed showing the advanced functions available for fine tuning of the picture.

- **Smooth Motion Effect**

The Smooth Motion™ Effect option activates Motion Estimation/Motion Compensation (ME/MC), which suppresses motion judder, or “stuttering” of the image when the camera pans across a scene, or there is horizontal motion in the scene. Choose from **Off**, **Low**, **Middle**, or **High**.

- **Real Cinema Mode**

The Real Cinema Mode option allows selection of the type of compensation used for the Smooth Motion™ Effect option. Choose from **Off**, **Precision** and **Smooth**.

- **Noise Reduction**

This feature diminishes picture artifacts caused by the digitizing of image motion content that may be present in the picture. Choose from **Off**, **Low**, **Medium**, or **High**.

- **MPEG NR**

Reduces white areas between color boundaries. Choose from **Off**, **Low**, **Medium** or **Strong**.

- **Color Enhancement**

This feature increases the picture reproduction performance of the picture by reducing oversaturation of certain colors and improving flesh tones. Choose from **Off**, **Normal**, **Rich Color**, **Grn/Flesh**, and **Grn/Blue**.

- **Adaptive Luma**

Large areas of brightness in the picture will result in a higher Average Picture Level (APL) and the overall picture will look too light. This feature will lower the APL to counteract this effect. Choose from **Off**, **Low**, **Medium**, **Strong**, or **Extend**.

- **Film Mode**

Choose from **Off** or **Auto**. When set to **Off** it will stay at 60 fps. When set to **Auto**, the TV will detect the cadence (for example at 24 frames/second for film, or normal video at 60 fps).

- **Backlight Control**

Set this feature to **OFF**, **DCR**, or **OPC**. **DCR** (Dynamic Contrast Ratio) improves the black level performance and increases contrast ratio. **OPC** (Optimum Power Control) Reduces power consumption while maintaining the same picture brightness.

- **Ambient Light Sensor**

Choose **Off**, **Low**, **Medium**, or **High**. When set to **Low**, **Medium**, or **High**, your HDTV will automatically adjust to light changes in the room.

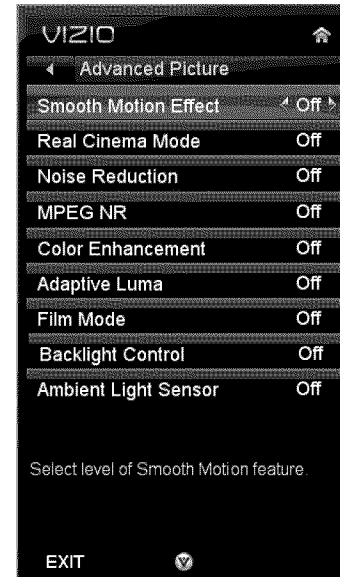

### Reset Picture Mode

Return all Picture settings to factory default. A screen will come up to confirm your selection or to cancel it. Press ◀ or ▶ to make the selection, and then press **OK** to accept it.

**Note:** Only settings under the Picture will be reset.

### PIP Menu

Your TV features PIP mode so you can watch two pictures at the same time. One picture is displayed as the full screen (main screen) and the other picture is displayed in a small window (sub screen).

**Note:** PIP is only available when the *Rating Enable* option in *Parental Controls* is set to **Off**.

### PIP Mode

Select from **Off**, **PIP** (Picture-inside-picture) or **POP** (Picture-outside-picture). In **PIP** mode a smaller sub-screen is displayed on top of the main screen. In **POP** mode the main screen and sub-screen are of equal size and are positioned side-by-side.

### Source

Select the input source for the sub-screen. The input sources available will vary according to which input is used for the main screen.

“✓” – Indicates which inputs are available for PIP and POP modes.

SUB MAIN	SUB				
	TV	AV (Composite)	Component	HDMI-1 HDMI-2 HDMI SIDE	RGB (Computer)
TV			✓	✓	✓
AV (Composite)			✓	✓	✓
Component	✓	✓		✓	
HDMI-1	✓	✓	✓		✓
HDMI-2	✓	✓	✓		✓
HDMI Side	✓	✓	✓		✓
RGB (Computer)	✓	✓		✓	

### Position

Select where you want the PIP screen positioned over the main screen. Choose from **Top Left**, **Top Right**, **Bottom Left**, and **Bottom Right**.

### Size

Set the size of the PIP window. Choose from **Small**, **Medium** or **Large**.

### Audio

Select which source will play the audio. Choose from the **Main** screen or the **PIP** (sub) screen.

## Settings Menu

Adjust various options including audio settings, scanning for channels, parental controls, date and time, and more.

### Audio Menu

Adjust audio options including balance, equalizer, and advanced audio settings.

#### Audio Mode

Choose from Flat, Rock, Pop, Classic or Jazz.

#### Balance

Adjust the sound to the left or the right.

#### Lip Sync

Lip Sync is designed to adjust the audio of the program being viewed so that it matches the movement of the lips of someone talking on the screen.

#### TV Speakers

Turn the internal speakers On or Off. You may want to turn the internal speakers off when listening to the audio through your Home Theater System.

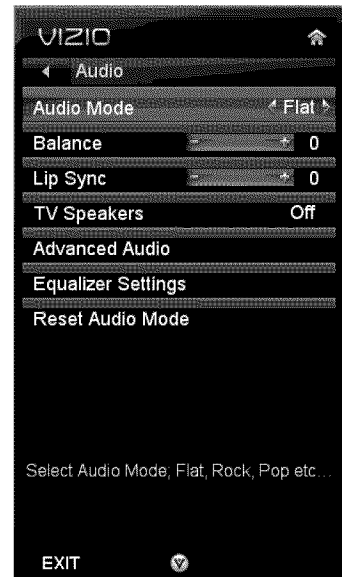
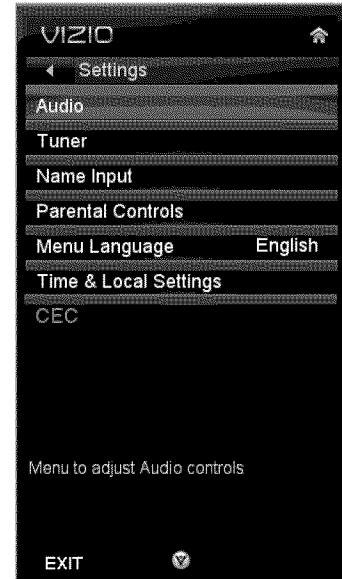

### Advanced Audio

To select the options in the Advanced Audio sub-menu, press **OK**. A new menu will be displayed showing the advanced functions available for fine tuning of the audio.

- **SRS TruSurround HD**

When watching TV or a movie, TruSurround HD™ creates an immersive surround sound experience from only two speakers and provides rich bass, clear dialog and high frequency detail.

- **SRS TruVolume**

When the programming switches to a commercial or when changing from channel to channel, volume fluctuations occur. When turned ON, TruVolume™ provides the listener with a comfortable and consistent volume level.

- **Digital Audio Out**

This option allows selection of the type of processing for the S/PDIF (Optical connector) when used with a Receiver/Amplifier/Home Theater system. Select to choose from OFF, Dolby Digital or PCM.

- **Analog Audio Out**

This option sets the volume control properties when using the RCA (white and red) connectors as audio line out to connect a Receiver/Amplifier/Home Theater system. Choose from Fixed or Variable. When set to Variable, volume from the external speakers will change according to the volume setting on the TV. If it is set to Fixed, the volume can only be changed by the settings on the external stereo system.

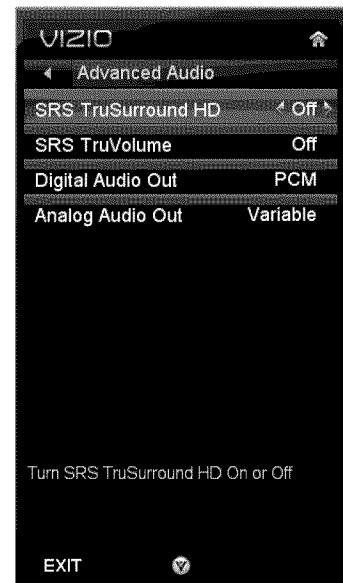

### Equalizer Settings

To select the options in the Equalizer Settings sub-menu, press **OK**. A new menu will be displayed showing the available equalizer functions. Press **◀** or **▶** to select *Basic* or *Advanced*.

- **EQ Mode (Basic)**

Adjust Bass and Treble.

- **EQ Mode (Advanced)**

Adjust volumes of different frequencies.

Starting from lowest to the highest, they are 120 Hz, 500Hz, 1.5 kHz, 5 kHz and 10 kHz.

1. Press **◀** or **▶** to select the frequency to be adjusted.
2. Use **▲** or **▼** to adjust the selected frequency to your preference. Values above 0 will boost the frequency and values below 0 will attenuate the frequency.

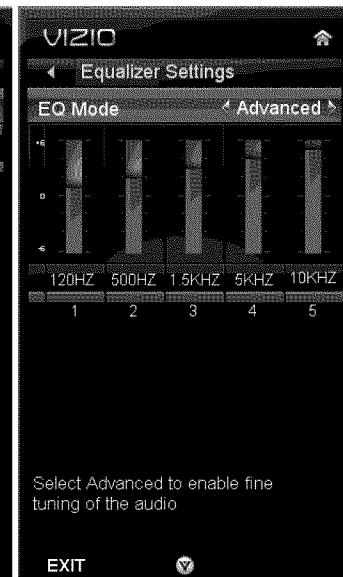
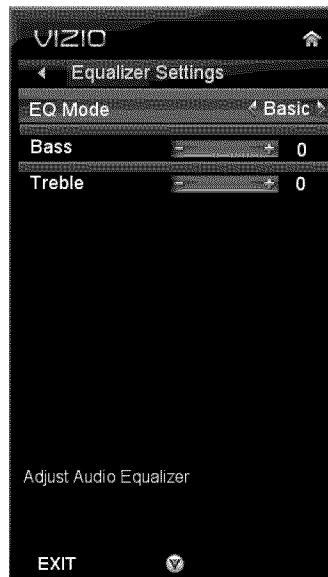

**Note:** The Equalizer adjustment will only be available when SRS TSHD is set to Off.

### Reset Audio Mode

Return all Audio settings to factory default. A screen will come up to confirm your selection or to cancel it. Press ◀ or ▶ to make the selection, and then press OK to accept it.

**Note:** Only settings under the Audio menu will be reset.

## Tuner

**Note:** The tuner option can only be selected when your HDTV is in TV input mode.

### Tuner Mode

Select Cable or Antenna depending upon which you have attached to the DTV / TV Input.

### Auto Channel Scan

Automatically search for TV channels that are available in your area. Be sure to first select the correct tuner mode above. The TV will search for analog and digital channels. When the search is done, press **OK** to begin watching your programs.

### Partial Channel Search

If you believe channels are missed from the auto search, you can do a partial channel search to look for channel in a certain channel range again. Select to scan for Analog, Digital, or both Analog/Digital channels, then press ▼ to highlight the “From” and “To” selection. Press ▶ to select the range of channel numbers you want to start searching in. Press **OK** to start channel search.

### Add Analog Channel

If your are in fringe/marginal reception areas or you want to receive local broadcasts where *Auto Channel Search* may not pick up the signals you can manually add channels. Press **OK** and a new menu will open. Enter the channel number, press ▼ to select *Add Channel*, and then press **OK** to add the channel.

### Skip Channel

After the TV has stored all of the available digital channels in memory you will find that some channels are too weak to watch comfortably or they may be channels you do not want to see. Press **OK** to select the channel to be skipped when using the CH▲ or CH▼ button. An X will appear in channels you have selected to skip. You will still be able to select this channel using the number buttons on the remote control.

### Analog MTS

This feature allows you to select the different languages the broadcaster is transmitting the audio with the program you are watching. This signal is usually Spanish. Choose from **Mono**, **Stereo**, or **SAP**.

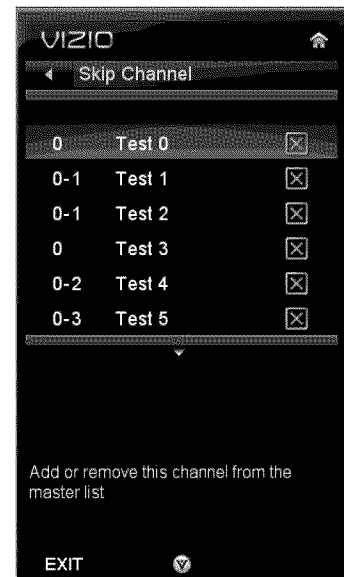
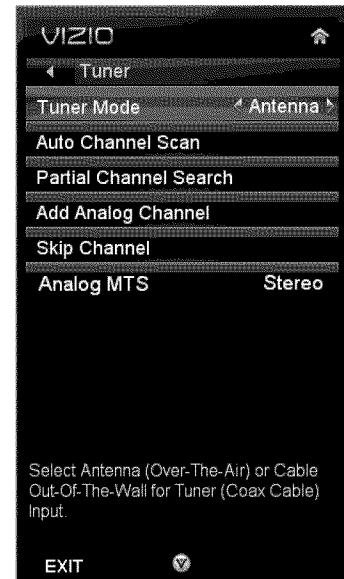

## Name Input

This feature makes it easier for you to recognize the devices you have connected to your HDTV when you press **INPUT**. For example, if you have a Blu-Ray DVD player connected to the HDMI-1 input, you can have the input label read *HDMI-1 BluRay* instead of just *HDMI-1*. You can select from 10 preset labels.

### To use one of the 10 preset labels:

1. Select *Input Source*, and then press **OK** to show the list of inputs.
2. Press **▼** to select the input label you want to change, and then press **OK**.
3. Press **▼** to select *Input Labels*, and then press **OK** to show the list of 10 preset labels.
4. Press **▼** to select the new input label name, and then press **OK**.



## Parental Controls

If you want to restrict certain channel and program viewing, you can do this by turning on the Parental Control. Selected programs, movies and channels can then be made available only after an authorized password has been entered and accepted by the TV.

**Note: The Parental Controls are divided into LOCK and UNLOCK menus. To activate or lock parental controls, use the LOCK menu. To deactivate or unlock parental controls, use the UNLOCK menu.**

### Navigating Lock and Unlock Menus

To access or navigate the LOCK menu, you must use the **Channel Up/Down** and **INPUT** buttons on the side of the TV. **The remote control buttons do not control the LOCK menu.**

To access or navigate the UNLOCK menu, you can use the **Arrow** and **OK** buttons on the remote. Enter your PIN when prompted.

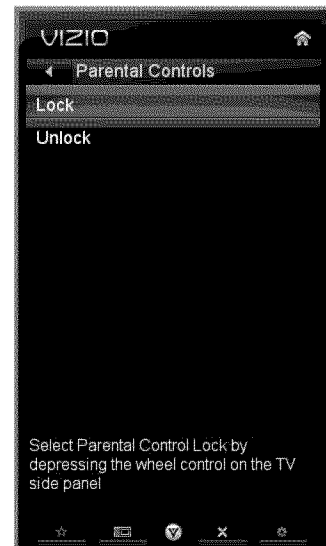

## Lock and Unlock Menu Functions

### Rating Enable

Select **ON** or **OFF**. If set to **OFF**, you will not be able to set the US TV, US Movie, Canadian English, or Canadian French Ratings.

### Channel Locks

Block individual channels from being displayed.

### USA-TV

**Note:** When Rating Enable is **OFF**, the USA-TV Rating adjustments are not available.

- TV-Y** – All children
- TV-Y7** – Older children
- TV-G** – General audience
- TV-PG** – Guidance suggested
- TV-14** – Strongly cautioned
- TV-MA** – Mature audience

You can also customize the TV ratings for the following content:

- A** – All sub-ratings
- FV** – Fantasy violence
- D** – Sexual dialog
- L** – Adult language
- S** – Sexual situations
- V** – Violence



### USA-Movie

**Note:** When Rating Enable is **OFF**, USA-Movie Rating adjustments are not available.

- G** – General audience
- PG** – Parental guidance suggested
- PG-13** – Recommended for children 13 years of age or older
- R** – Mature audience
- NC-17** – No one under 17 years of age
- X** – No one under 17 years of age



### CAN-English

**Note:** When Rating Enable is **OFF**, Canadian English Rating adjustments are not available.

- C** – Children
- C8+** – Children 8 years or older
- G** – General Programming, suitable for all audiences
- PG** – Parental guidance
- 14+** – Viewers 14 years or older
- 18+** – Adult programming

### CAN-French

**Note:** When Rating Enable is **OFF**, Canadian French Rating adjustments are not available.

- G** – General audience
- 8 ans+** – General – not recommended for young children
- 13 ans+** – Not suitable for children under 13 years of age
- 16 ans+** – Not suitable for under 16 years of age
- 18 ans+** – Adults only

### **Alt Rating Region**

This setting is not used. It is reserved for future rating systems.

### **Block Unrated TV**

Block programming that does not have a rating.

### **Change PIN (UNLOCK Menu Only)**

Enter a new, 4-digit password using the number buttons on the remote control. Enter it a second time to confirm you entered it correctly.

**Note:** Make sure you write down and store the new password in a secure place. The *Reset Locks* feature does NOT reset the password.

### **RESET LOCKS (UNLOCK Menu Only)**

Return all Parental Control lock settings to factory default. A screen will come up to confirm your selection or to cancel it. Press ◀ or ▶ to make the selection, and then press **OK** to accept it.

## **Menu Language**

Select to change the language of the menu. The default is **English**. You can also select **French** or **Spanish**.

## **Time & Local Settings**

### **Time Zone**

Setting the correct Time Zone for your area will ensure that the correct time is shown after pressing the **GUIDE** button on the remote control.

### **Daylight Saving**

Setting the daylight saving time for your area will ensure that the correct time is shown after pressing the **GUIDE** button on the remote control.



## CEC

Consumer Electronics Control allows you to control other devices using your HDTV remote control when those devices are connected via HDMI. For example, if a CEC-supported Blu-ray DVD player is connected to your HDTV through HDMI-2 and that player is powered on, your HDTV will automatically change to the HDMI-2 input. Similarly, if your HDTV is powered on first and you change the input to HDMI-2, your Blu-ray player will automatically power on.

Also, you can control your CEC-supported device using the transport keys on your HDTV remote control (e.g. Play, Stop, Prev, etc.). When you press one of the buttons on your HDTV, the action will occur on your device.

Contact your devices' user manual or manufacturer to check whether your device supports CEC.

### CEC Function

Turn CEC On or Off. When set to Off, your HDTV will not send or receive any CEC commands.

### Device Discovery

Register device with TV. Before CEC will work, perform a Device Discovery to see if there are any CEC supported devices connected to your HDTV.

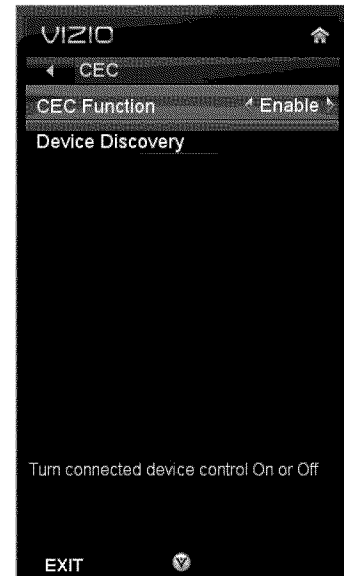

## Media Menu

When viewing pictures you can adjust various settings, including slideshow, picture duration, etc.

1. Insert a USB device containing pictures and select the folder or files that you want to play.
2. Press **MENU**. The Picture menu will be displayed.
3. Press **▲** or **▼** on the remote control to highlight a Picture menu option, and then press **◀** or **▶** to adjust the setting.
4. Press **MENU** once to close the menu.

### Slideshow Mode

Choose from **Shuffle**, **Single**, and **Sequence** to set the slideshow mode. Press **OK** to begin the slideshow. Press **EXIT** to stop the slideshow.

- **Single** will display one picture selected from the thumbnails for the interval set in the *Duration* option and return to the thumbnails. If the *Repeat* option is set to **On**, the selected picture will be displayed until you press **EXIT**.
- **Sequence** will show your pictures in the order they are listed on your USB device until you stop the slideshow.
- **Shuffle** will show your pictures in random order until you stop the slideshow.

### Repeat

Choose from **On** or **Off** to repeat the slideshow.

### Sort By

You can choose to sort the pictures on the USB device by **Photo Date**, **File Date**, or alphabetically (**File A-Z**).

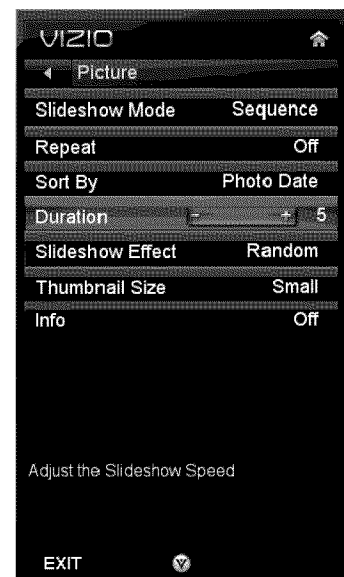

### Duration

Set the amount of time the picture will remain on the screen during the slideshow. Choose a time between 5 seconds and 32 seconds.

### Slideshow Effect

Choose from **Random**, **Dissolve**, **Wipe Right**, **Wipe Left**, **Wipe Up**, **Wipe Down**, **Box In**, or **Box Out** to set the transition type when changing from one picture to another during a slideshow.

### Thumbnail Size

Set the size of the preview pictures (thumbnails) in the menu. Choose from **Small**, **Medium**, or **Large**.

### Info

When set to **On**, information about the picture briefly appears on your HDTV.

## Help Menu

### System Info

Display the technical information including model name, version and revision of firmware, source type, and resolution.

### Reset TV Settings

Return all Picture and Audio settings to factory default. A screen will come up to confirm your selection or to cancel it. Press Left or Right Navigation buttons to make the selection, and then press **OK** to accept it.

**Note:** This does **NOT** reset the Parental Control Password.

### Clear Memory (Factory Default)

Use this function to reset the TV to the default factory settings. The screen will display a message to confirm that you want to reset the values to factory settings. Press ◀ or ▶ to make the selection, and then press **OK** to accept it.

**Note:** This does **NOT** reset the Parental Control Password.

### Start Setup Wizard

Use this function to return to the Initial Setup menu. Use this function if you want to have a guided setup when you move your TV.

**Note:** Previously scanned channels will be removed.



## Chapter 9 Programming the VIZIO Universal Remote Control

Program your E470VL and E551VL remote control to work with other devices.

### Using a Cable or Satellite Box Remote

Your VIZIO remote uses codes 000, 047, 050, 067, 329, 331 and 339 to work your HDTV. To use a Cable or Satellite remote to work the HDTV, refer to your Cable or Satellite remote user guide for more information on how to program the remote.

If your Cable or Satellite remote uses a 5-digit code (like most Direct TV units), first try 11758 and then, if that does not work, 10178. If your Cable or Satellite remote uses a 4-digit code, try 1758 and then 0178 as an alternative. If your Cable or Satellite remote uses a 3-digit code (Echostar or Dish Network for example), use code 627.

**Note:** Some buttons may not function as expected on your Cable or Satellite remote. Typically power, volume and mute will work.

### Programming other devices

Your remote control is programmable and supports up to three different devices. Listed below are the steps for programming your DVD player, Home Theater System, and a Cable or Satellite box. After you find your codes, write them in the table provided.

#### Programming your Blu-Ray or DVD Player

1. Turn on the DVD player.
2. Press and release the **DVD** button on your VIZIO universal remote control.
3. Press and hold the **SET** button until the LED flashes twice.
4. Find the programming code for your DVD player in the code list below and enter it using the number buttons. If the code is accepted, the LED flashes twice after the last digit is entered. If the LED does not flash twice, repeat Steps 2 through 4 with the next code listed.
5. Point the remote control at the DVD player and press **POWER**. The DVD player will turn off. If the DVD player does not turn off, repeat Steps 2 through 4 with the next code listed for the component and manufacturer.

#### Notes:

- If the codes do not work or your brand is not listed, see *Searching for Device Codes* on page 48.
- Sometimes a code listed will only include limited functions. Try other codes that may include more functionality.

#### Programming your Home Theater System

1. Turn on the Home Theater System.
2. Press and release the **AUDIO** button on your VIZIO universal remote control.
3. Press and hold the **SET** button until the LED flashes twice.
4. Find the programming code for your Home Theater System and enter it using the number buttons. If the code is accepted, the LED flashes twice after the last digit is entered. If the LED does not flash twice, repeat Steps 2 through 4 with the next code listed.
5. Point the remote control at the Home Theater System and press **POWER**. The Home Theater System will turn off. If the Home Theater System does not turn off, repeat Steps 2 through 4 with the next code listed for the component and manufacturer.

#### Notes:

- If the codes do not work or your brand is not listed, see *Searching for Device Codes* on page 48.
- Sometimes a code listed will only include limited functions. Try other codes that may include more functionality.

## Programming your Cable or Satellite Set-Top Box

1. Turn on the Cable or Satellite Set-Top Box.
2. Press and release the **CABLE** button on your VIZIO universal remote control.
3. Press and hold the **SET** button until the LED flashes twice.
4. Find the programming code for your Cable or Satellite Set-Top Box and enter it using the number buttons. If the code is accepted, the LED flashes twice after the last digit is entered. If the LED does not flash twice, repeat Steps 2 through 4 with the next code listed.
5. Point the remote control at the Cable or Satellite Set-Top Box and press **POWER**. The Cable or Satellite Set-Top Box will turn off. If the Cable or Satellite Set-Top Box does not turn off, repeat Steps 2 through 4 with the next code listed for the component and manufacturer.

My Codes	
DVD Player	
Home Theater	
Cable Box	
Satellite Box	
VCR	
Other	
Other	
Other	

### Notes:

- If the codes do not work or your brand is not listed, see *Searching for Device Codes* on page 48
- Sometimes a code listed will only include limited functions. Try other codes that may include more functionality.

## Searching for Device Codes

If you cannot find the manufacturer in the list or the program code does not work, you can use the remote control to search for the correct device code.

1. Turn on the device.
2. Press the matching device button on your VIZIO universal remote control.
3. Press and hold **SET** until the LED flashes twice.
4. Press **9 9 1**. The LED flashes twice.
5. Point the remote control at the device and then press and hold **POWER** until the device turns off.

## Reset Remote Control to Factory Settings

1. Press and hold **SET** until the LED flashes twice.
2. Press **9 1 9 1 9**. The LED flashes twice.

## Remote Control Codes

### Television Codes

#### (Including TV/DVD, TV/VCR, and TV/DVD/VCR)

3M 1655	Chun Yun 0706, 1687, 1756, 1834, 2230	Emerson 1864, 0154, 0451, 0236, 0463, 0180, 0178, 0171, 1661, 0623, 1394, 1913, 1929, 1944, 1963, 0002, 0479, 0593, 1479, 0675, 1268, 2212, 0821	Helios 0865
Admiral 0093, 0463	Citizen 0060, 0030, 0092, 1669, 1671, 1672, 1935, 0695	Emprex 1422, 1546, 1765	Hello Kitty 0451
Advent 0761, 0783, 0815, 0817, 0842	Clarion 0180	Envision 0030, 0813, 1365, 1589, 2014, 2087	Heran 1826, 1852, 2305, 2356
Aiko 0092	Coby 1538, 1634, 2017, 2306, 2315, 2338, 2340, 2343, 2344, 2345, 2347, 2348, 2350, 2495, 2535, 2536, 2537, 2538, 2540	Epson 0833, 0840, 1122	Herosonic 1826
Akai 0812, 1675, 0702, 0030, 0672, 1207, 1935, 2232, 0143, 0695, 2439	Colt 0072	ESA 0812, 0171, 1944, 1963, 1268, 0821	Hewlett Packard 1642, 1494, 1502
Albatron 0700, 0843	Commercial Solutions 1447, 0047	Esonic 2221, 2229, 2234	HiPlus 1420, 1435, 2113, 2224, 2225, 2226, 2230, 2235
America Action 0180, 0278	Contec 0180	Fisher 0154	Hisense 0748, 1314, 1660, 2098, 2183, 2355, 2419
Anam 0180	Craig 0180	Frigidaire 1597, 1826, 2231	Hitachi 1643, 1145, 0145, 1445, 1904, 0000
AOOC 0030, 1365, 1589, 1590, 2014, 2087, 2402	Crosley 0000, 0054	Fujimaru 1687	HP 1642, 1494, 1502
Aomni 1623	Crown 0180	Fujitsu 0809, 0683, 0853	Humax 1501
Apex Digital 0748, 0879, 0765, 0767, 0890, 1217, 2397	Curtis 2352, 2466, 2660	Funai 0000, 0180, 0171, 1271, 1904, 1963, 1268	Hyundai 0849
Astar 1531, 1548, 1738	Curtis Mathes 0047, 0054, 0154, 0451, 0093, 0060, 0702, 0030, 0145, 0166, 1661, 1147, 1347	Futuretech 0180	I-Inc 1746
Asus 2175	CXC 0180	Gateway 1755, 1756	iLo 1286, 1603, 1684, 1990, 1472
Audiovox 0451, 0180, 0092, 0623, 0802, 0846, 0875, 1284, 1937, 1951, 1952, 0278, 1071, 1121, 1122	Daewoo 0154, 0451, 0092, 1661, 0623, 0661, 0672	GE 1447, 0047, 0051, 0451, 0178, 1347, 1922, 2359, 0240, 1060	Infinity 0054
AUO 1591	Dell 1264, 1080, 1178, 1403, 1863	GFM 0171, 1963, 2167, 1268	InFocus 2024, 2199
Aventura 0171	Delta 1369	Gibraltar 0017, 0030	Initial 1603, 1990, 1472
Axion 1937, 1071	Denon 0145	Gibson 1597, 1826, 1834, 2305	Insignia 1423, 1564, 0171, 1204, 1517, 1641, 1660, 1710, 1780, 1892, 1963, 2002, 2049, 2088, 2417, 1013, 1268, 2255, 2620
Bell & Howell 0154	Diamond Vision 1996, 1609	Go Video 0886, 1823, 1831	Inteq 0017
BenQ 1032, 1715, 1853	Digisonic 1826	Go Vision 1071	iRIS 2189
Boxlight 0893	Digital Lifestyles 1765, 1822	GoldStar 0178, 0030	JBL 0054
Bradford 0180	Digital Projection Inc. 1750	Goodmans 0360, 2274	JCB 0000
Brandt Plus 1851	DirecTV 1501	Grundig 0683	Jensen 0761, 0815, 0817, 1299
Brilliant 1007	Disney 2152, 2356	Grunpy 0180	JVC 0463, 0053, 0650, 0731, 1253, 1601, 1774, 1923, 2271, 1067, 2472
Broksonic 0236, 0463, 1929, 1935, 1938, 0002, 0479, 1479, 0695, 0868	Dream Vision 1297	Haier 1034, 1748, 1749, 1753, 2309, 2099, 2500	KDS 1498, 1687
byd:sign 1309	Dumont 0017	Hallmark 0178	KEC 0180
Candle 0030	Durabrand 0463, 0180, 0178, 0171, 1034	Hanns.G 1783	Kenwood 0030
Canon 1396	Dynex 1463, 1780, 1785, 1810, 2049, 2184, 2255, 2388	Hannspree 1348, 1351, 1745, 1783, 1826	KLH 0765, 0767
Carnivale 0030	Electroband 0000	Harley Davidson 0000, 1904	Kolin 1610, 1755, 0150, 1240, 1837
Carver 0054	Electrograph 1755, 1623	Harman/Kardon 0054	Konka 0748, 1831
Celebrity 0000	Electrohome 0463, 1670, 1672, 1607	Harsper 1206	KTV 0180, 0030
Celera 0765	Element 1687, 2183	Harvard 0180	
Changhong 0765		Havermy 0093	
Chimei 1837, 1852, 2072			

LG 1423, 0017, 1265, 0178,  
 0700, 0856, 1178, 1768,  
 1934, 1993, 2358, 2424,  
 0480, 1037, 2485  
 Lloyd's 1904, 0000  
 Loewe 0136  
 LXI 0047, 0054, 0154, 0156,  
 0178  
 MAG 1498, 1687  
 Magnasonic 1913, 0593  
 Magnavox 1454, 1866, 0054,  
 0051, 0030, 0706, 0802,  
 1012, 1198, 1254, 1365,  
 1525, 1904, 1913, 1931,  
 1944, 1963, 1990, 2372,  
 0000, 0593, 1781, 1268,  
 1472, 2229, 2632, 0821  
 Magnin 0240  
 Marantz 1454, 0054, 0030,  
 0704, 0855, 1154, 1398,  
 2445, 2447  
 Matsushita 0250, 0650  
 Maxent 1755, 1714, 1757  
 Megapower 0700  
 Megatron 0178, 0145  
 Memorex 0154, 0463, 0150,  
 0178, 1670, 1892, 1924,  
 0162, 1037, 1162, 1262,  
 1607  
 MGA 0150, 0178, 0030,  
 0240  
 Midland 0047, 0017, 0051  
 Mintek 1603, 1990, 1472  
 Mitsubishi 1250, 0093, 0150,  
 0178, 0836, 0868, 1522,  
 2010  
 Monivision 0700, 0843  
 Motorola 0093  
 MTC 0060, 0030  
 Multitech 0180  
 NAD 0156, 0178, 0866,  
 1156  
 NEC 0030, 0497, 0704,  
 0882, 1398, 1546, 1704,  
 1797, 1852, 2026, 2144  
 NetTV 1755  
 NewSonic 1826  
 Nexus Electronics 2183  
 Nikko 0178, 0030, 0092  
 Niko 1581, 1618  
 Norcent 0748, 0824, 1365,  
 1589, 1590, 1591, 2110  
 Norwood Micro 1286, 1303  
 NTC 0092  
 NuVision 1657, 2158  
 Olevia 1610, 1144, 1240,  
 1331  
 Onwa 0180  
 Optimus 0250, 0154, 0166,  
 0650, 1913, 1924, 0162,  
 0593, 1162, 1262  
 Optoma 0887, 1348, 1622,  
 2161  
 Optonica 0093  
 Orion 0236, 0463, 1463,  
 1929, 0002, 0479, 1479  
 Panasonic 1480, 0250,  
 1457, 0051, 0650, 1271,  
 1291, 1410, 1924, 1941,  
 1946, 1947, 0162, 1162,  
 1262, 1490, 1362, 1462  
 PARK 2104, 2194, 2202  
 Penney 0047, 0156, 0051,  
 0060, 0178, 0030, 1347,  
 0240  
 Petters 1523  
 Philco 0054, 0030, 0171,  
 1271, 1394, 1963  
 Philips 1454, 1866, 0054,  
 0690, 1154, 1744, 1850,  
 1867, 1961, 2227, 2372,  
 2374, 1260  
 Pilot 0030  
 Pioneer 1457, 0166, 0679,  
 0866, 1260, 1398  
 Polaroid 1523, 0765, 2425,  
 2121, 2120, 2119, 2063,  
 2002, 1992, 1769, 1767,  
 1766, 1687, 1538, 1498,  
 1314, 1286, 1276, 0865,  
 1013, 2110, 2140, 1482  
 Polyvision 0889, 1144  
 Portland 0451, 0092, 1661  
 Prima 0761, 0783, 0815,  
 0817, 1785  
 Princeton 0700  
 Prism 0051  
 Projectiondesign 1750  
 Proscan 1447, 0047, 0030,  
 1347, 1922, 2147, 2256,  
 2450  
 Proton 0178, 1546, 1834,  
 1874  
 Proview 1498, 1687  
 Proxima 1896  
 Pulsar 0017  
 Puneet 1546  
 Quasar 0250, 0051, 0650,  
 1924, 0162, 1162  
 Radio Shack 0047, 0154,  
 0180, 0178, 0030, 1904,  
 0000, 1037  
 RCA 1547, 1447, 0047,  
 0051, 0093, 0090, 0679,  
 1047, 1147, 1247, 1347,  
 1781, 1922, 1953, 2002,  
 2187, 2247, 2434, 0240,  
 1060, 1013, 2392, 1132  
 Realistic 0154, 0180,  
 0178, 0030  
 Relon 1826  
 RevolutionHD 1623  
 Runco 0017, 0030, 0497,  
 0603, 1398, 1629, 2444  
 Sampo 1755, 0030, 1597,  
 1618, 2238  
 Samsung 0812, 0060,  
 0702, 0178, 0030, 0587,  
 0650, 0766, 0814, 1060,  
 1618, 1632, 1959, 2051,  
 1014  
 Sansui 0463, 0171, 1409,  
 1670, 1892, 1904, 1929,  
 1935, 0000, 0479, 1479,  
 0695, 1607  
 Sanyo 0054, 0154, 0088,  
 0799, 0842, 0893, 1142,  
 2115, 2236, 2237, 2238,  
 2448, 2452, 0240  
 Sceptre 0878, 1217, 1360,  
 1599  
 Scotch 0178  
 Scott 0236, 0180, 0178,  
 1711  
 Sears 0047, 0054, 0154,  
 0156, 0178, 0171, 1007,  
 1904, 0000  
 Seleco 1297, 1351  
 Sharp 0818, 0093, 0491,  
 0688, 0851, 1602, 2360,  
 2561, 0630  
 Sheng Chia 0093  
 Sherwood 1399  
 SIM2 Multimedia 1297  
 Sole 1623, 2075, 2076  
 Sony 0810, 0000, 0834,  
 1685, 1904, 1925, 2054,  
 1232  
 Soundesign 0180, 0178  
 Sova 1952, 1122  
 SOYO 1520, 1546,  
 1746, 1826, 1828,  
 1829, 1830, 1831,  
 1832, 1834  
 Spectroniq 1498, 1687  
 Squareview 0171  
 SSS 0180  
 Starlite 0180  
 Studio Experience  
 0843  
 SunBrite 1420, 1435,  
 2337  
 SuperScan 0093,  
 0864, 1944, 0821  
 Supreme 0000  
 SVA 0748, 0587, 0865,  
 0870, 0871, 0872,  
 1963  
 Sylvania 1864, 0054,  
 0030, 0171, 0587,  
 1271, 1314, 1394,  
 1886, 1913, 1931,  
 1944, 1963, 1781,  
 0675, 1268, 2194,  
 2212, 0821  
 Symphonic 0180,  
 0171, 1904, 1913,  
 1944, 0000, 0593,  
 0821  
 Synco 1755, 1826  
 Syntax 1610, 1144,  
 1240, 1331  
 Tandy 0093  
 Tatung 1156, 1254,  
 1286, 1687, 1719,  
 1756, 1839, 1857  
 Technics 0250, 0051  
 Techview 0847, 2004  
 Techwood 0051  
 Teco 0053, 0092,  
 1687, 1834, 1838,  
 2114  
 Teknika 0054, 0180,  
 0150, 0060, 0092  
 Telefunken 0702  
 Thomas 1904, 0000  
 TMK 0178  
 TNCi 0017

Toshiba 1524, 0154, 0156, 1256, 1265, 0060, 2233, 2006, 1945, 1936, 1935, 1704, 1656, 1635, 1369, 1356, 1156, 0845, 0832, 0650, 1145, 0695, 1606, 2165, 1045  
 Trutech 1723, 2066, 2264  
 TVS 0463  
 US Logic 1286, 1303  
 UTI Technology 2244  
 Vector Research 0030  
 Venturer 1865, 2195  
 VEOS 1007  
 Victor 0053  
 Vidikron 0054, 1398, 1629  
 Vidtech 0178  
 Viore 1207, 1684, 1811, 2104, 2352, 2154, 2300, 2580  
 Vision 1826, 2305  
 Vistron 2142  
 Vito 1852, 2365, 2375, 2376, 2377, 2378, 2379, 2380, 2381  
 Vizio 1758, 0864, 0885, 1756, 2116  
 Wards 0054, 0178, 0030, 0866, 1156  
 Waycon 0156  
 Westinghouse 1712, 1755, 0451, 0885, 0889, 0890, 1282, 1300, 1577, 1597, 1826, 1834, 2293, 2305, 2513  
 White Westinghouse 0463, 1661, 0623  
 Wyse 1365  
 Yamaha 0030, 0769, 0833, 0839  
 Zenith 0000, 1423, 0047, 0017, 0463, 1265, 0178, 0030, 1145, 0145, 0092, 1661, 1904, 1929, 0479, 1479  
 Zinwell 2116, 2281

## Cable Box Codes

### (Including Cable / PVR Boxes)

Amino 1602, 1822  
 Bright House 1376, 1877  
 Cable One 1376, 1877  
 Cablevision 1376, 1877, 1006  
 Charter 1376, 1877, 2187  
 Cisco 1877, 0877, 1982  
 CNS 2350  
 Comcast 1376, 1877, 1982, 2576  
 Cox 1376, 1877  
 Digeo 1187, 2187  
 Director 0476  
 General Instrument 0476  
 Homecast 2301  
 i3 Micro 1602  
 Insight 1376, 1877  
 Jerrold 0476  
 Knology 1877  
 Mediacom 1376, 1877  
 Motorola 1376, 0476, 1187, 1982  
 Myrio 1602, 1822  
 Pace 1376, 1877, 1982  
 Panasonic 1982  
 Pioneer 1877, 0877  
 Prime 2340  
 Rogers 1877  
 Scientific Atlanta 1877, 0877  
 Sejin 1602  
 Shaw 1376  
 Sony 1006  
 Suddenlink 1376, 1877  
 Thomson 1982  
 Time Warner 1376, 1877, 2187  
 Tivo 2576  
 WideOpenWest 1877

## Converters

### (Including Digital-to-Analog and HDTV)

Access HD 2185  
 Airlink 101 2491  
 Alpha Digital 2185  
 AMTC 2185  
 Apex Digital 2478  
 Artec 2490  
 CASTi 2305  
 Channel Master 2365  
 Coby 2667  
 Coship 2487  
 Daewoo 2338  
 Daytek 2305  
 Digital Stream 2303  
 Dish Network 0775, 2470  
 Echostar 2470  
 GE 2360, 2450  
 Goodmind 2450  
 Gridlink 2348  
 Insignia 1415  
 Lasonic 2348  
 Magnavox 1563  
 Memorex 2486  
 MicroGEM 2489  
 Motorola 1982  
 Pace 1982  
 Philco 1563  
 RCA 2325, 2454  
 Samsung 2592  
 Sansonic 2348  
 Sunkey 2695  
 Sylvania 1563  
 Thomson 1982  
 Tivax 2185  
 Ventura 2454  
 Venturer 2454  
 Winegard 2454  
 Zenith 1415  
 Zentech 2491  
 Zinwell 2488

## Decoders

### (Including Digital-to-Analog and HDTV)

DirecTV 0392  
 Dish Network 0775  
 Epson 1563  
 LG 1414, 1415  
 Panasonic 1120, 1190, 1490  
 Samsung 1190, 1276, 1490  
 Sylvania 1563  
 Sony 1006  
 Tivo 0739  
 Zenith 1856

## IPTV

Motorola 1376, 0476  
 ADB 2254  
 Amino 1481, 1615, 1673, 2482  
 AT&T 0858  
 Chunghwa 1917  
 Cisco 2345, 2517  
 Motorola 0858, 2378  
 Scientific Atlanta 0858, 2345, 2517  
 SetaBox 1917  
 Verizon 2378

## Satellite Receiver Codes

### (Including Sat / PVR Boxes)

Amino 1615  
 Bell ExpressVu 0775, 1170  
 Coolsat 2147  
 Crossdigital 1109  
 DirecTV 1377, 0392, 0566, 0639, 1639, 1142, 0247, 0749, 1749, 1856, 1076, 1109, 1414, 1442, 1443, 1444, 1609, 0739, 0740  
 Dish Network System 0775, 1505, 1170, 1775  
 Dishpro 0775, 1505, 1775  
 Echostar 0775, 1505, 1170, 1775

Expressvu 0775, 1775  
 Fortec Star 1948  
 GE 0566  
 General Instrument 0869  
 GOI 0775, 1775  
 HTS 0775, 1775  
 Hughes Network 1142, 0749, 1749, 1442, 1443, 1444, 0740  
 Jerrold 0869  
 JVC 0775, 1170, 1775  
 LG 1414  
 Mitsubishi 0749  
 Motorola 0869  
 Next Level 0869  
 Panasonic 0247, 0701  
 Pansat 1807  
 Philips 1142, 0749, 1749, 1076, 1442  
 Proscan 0392, 0566  
 RadioShack 0869  
 RCA 0392, 0566, 0855, 0143  
 Samsung 1377, 1276, 1109, 1442, 1609  
 Sonicview 2373, 2374  
 Sony 0639, 1639  
 Star Choice 0869  
 Tivo 1142, 1442, 1443, 1444, 0740  
 Toshiba 0749, 1749, 0790  
 Viewsat 1994  
 Voom 0869  
 Zenith 1856

**PVR Codes**

Amino 1673  
 ABS 1972  
 Alienware 1972  
 CyberPower 1972  
 Dell 1972  
 DirecTV 0739, 0740  
 Gateway 1972  
 Go Video 0614  
 Hewlett Packard 1972  
 Howard Computers 1972  
 HP 1972  
 Hughes Network Systems 0740  
 Humax 0739, 1797, 1988

Hush 1972  
 iBUYPOWER 1972  
 Linksys 1972  
 Media Center PC 1972  
 Microsoft 1972  
 Mind 1972  
 Niveus Media 1972  
 Northgate 1972  
 Panasonic 0614, 0616, 1807, 1777  
 Philips 0739, 0618, 1818  
 Pioneer 1803  
 RCA 0880  
 ReplayTV 0614, 0616  
 Sharp 1893  
 Sonic Blue 0614, 0616  
 Sony 0636, 1886, 1972  
 Stack9 1972  
 Sylvania 0000  
 Systemax 1972  
 Tagar Systems 1972  
 Tivo 0739, 0618, 0636, 0740  
 Toshiba 1008, 1972, 1988, 1996  
 Touch 1972  
 Viewsonic 1972  
 Voodoo 1972  
 ZT Group 1972

**Blu-Ray DVD Codes**

Denon 2258  
 Insignia 0675, 2428, 2596  
 Integra 1769, 2147  
 JVC 2365  
 LG 0741, 1602  
 Magnavox 0675  
 Marantz 2414  
 Microsoft 2083  
 NAD 2572  
 Olevia 2331  
 Onkyo 1769, 2147  
 Oppo 2545, 2546, 2547  
 Panasonic 1641, 2518  
 Philips 2084, 2434  
 Pioneer 0142, 2442  
 RCA 1769  
 Samsung 0199, 0298  
 Sharp 2250, 2561  
 Sony 1516, 2504

Sylvania 0675, 2194  
 Toshiba 1769, 1515, 2705  
 Viore 2553  
 Vizio 2563  
 Xbox 2083  
 Yamaha 2298

**DVD/VCR Player Codes**

Accurian 0000, 0675  
 Allegro 0869  
 Apex Digital 1061  
 Broksonic 0695  
 CineVision 0869  
 Daewoo 0869  
 Emerson 1593, 0675  
 Funai 1593, 0675  
 GFM 1593, 0675  
 Go Video 0744, 0715, 0741, 0869, 1044, 1075  
 GoldStar 0741  
 Hitachi 0000, 0664  
 JVC 1707, 0867, 1164, 1550, 1602  
 LG 0741  
 LiteOn 1656  
 Magnavox 0000, 1593, 0675  
 Memorex 0695  
 Panasonic 1762  
 Philips 0675, 1267  
 Pioneer 1460  
 Polaroid 1061  
 Presidian 0000, 1593, 0675  
 RCA 0060, 0522, 0822  
 Rio 2002  
 Samsung 0820, 1044, 1075, 2489  
 Sansui 0695  
 Sanyo 0104, 0670, 0873  
 Sharp 0848, 1893, 0630  
 Sonic Blue 2002  
 Sony 1702, 1896, 0864, 1033, 1070, 1431  
 Sylvania 0000, 0593, 1593, 0675  
 Symphonic 0000, 1593, 0675  
 Toshiba 0503, 1854  
 Zenith 0741, 0869

**DVD Player Codes**

Accurian 0675, 0675  
 Aiwa 0641, 1912  
 Akai 0143, 0695, 0770, 1975, 2439  
 Alco 0790  
 Allegro 0869  
 Amphion Media Works 2001, 2016  
 AMW 2001, 2016  
 Anam 1913  
 Apex Digital 0672, 0755, 0794, 0796, 0797, 1004, 1020, 1056, 1061, 1100, 1833, 1915, 1937  
 Arrgo 1023  
 Audio Authority 2555  
 Audiovox 0790, 1041, 1071, 1121, 1122  
 Axion 1071  
 B & K 0662  
 BBK 1224  
 Bel Canto Design 1571  
 Blue Parade 0571  
 Bose 1895, 2023  
 Boston Acoustics 1856  
 Broksonic 0695, 0868  
 California Audio Labs 0490  
 Cambridge Sound Works 1916  
 Cinea 0831  
 CineVision 0869  
 Citizen 0695, 2116  
 Classic 1917  
 Coby 0778, 0852, 1086, 1107, 1165, 1177, 1351, 1628, 1923, 2495, 2535, 2536, 2537, 2538, 2540  
 Craig 0831  
 Criterion 2007  
 Curtis 2660  
 Curtis Mathes 1087  
 CyberHome 0816, 1023, 1024, 1129, 1502



Daewoo 0784, 0869, 1169, 1172, 1918	Koss 1980	Presidian 0675, 1738	Urban Concepts 0503
Denon 0490, 0634, 1634, 2258, 2270	Lennox 1127, 1938	Proceed 0672	Venturer 0790, 2195
Diamond Vision 1609	LG 0591, 0741, 0869, 1602, 1906, 2002, 2485, 2568	Proscan 0522, 2450	Viore 2154, 2300, 2553, 2580
DigitalMax 1738	Liquid Video 1980	ProVision 0778	Vizio 1064, 1226, 2563
Disney 0675, 1270, 2356	LiteOn 1058, 1656, 1738	RCA 0522, 0571, 1769, 0790, 0822, 1013, 1132, 1913, 1965, 1974, 2213, 2392	Westinghouse 2513
Durabrand 1023, 1127	Logitech 2639	Regent 1938	Xbox 0522, 2083
DVD2000 0521	Magnavox 0503, 0539, 0646, 0675, 0821, 1177, 1268, 1354, 1472, 1506, 1914, 1976, 2229, 2632	Rio 0869, 2002	Yamaha 0490, 0539, 0646, 0545, 0497, 0817, 1840, 2298, 2558
Dynex 2255, 2388	Marantz 0539, 2414	Rotel 0623	Zenith 0503, 0591, 0741, 0869, 1906
Electrohome 1607, 1729, 2116	McIntosh 1273	Saba 1977	
Emerson 0591, 0675, 0821, 1268, 2212	Memorex 0695, 0831, 1270, 1607, 2213	Sampo 0752	<b>Amplifier / Receiver / Tuner Codes</b>
Enterprise 0591	Messiah Entertainment 2396	Samsung 0490, 0573, 0199, 0298, 0820, 1044, 1075, 1470, 1932, 1979, 2069, 2329, 2369, 2489, 2556	Adcom 1100
ESA 0821, 1268	Microsoft 0522, 2083	Sansui 0695, 1607	Aiwa 1405, 1388, 1641, 2298
Fisher 0670, 1919	Mintek 1472	Sanyo 0670, 0695, 0873, 1919, 1967	Akai 1512
Funai 0675, 1268	Mitsubishi 1521, 0521	Schmartz 2367	Alco 1390
Gateway 1077	NAD 0741, 2572	Schneider 0646	AMC 1077
GE 0522, 0815	NexxTech 1830	Sharp 1893, 0630, 0675, 0752, 1256, 2250, 2561	Amphion Media Works 1563, 1615
GFM 0675, 1268	Norcent 1107, 1830, 1923	Sherwood 0633, 0770, 1043, 1077, 1889	AMW 1563, 1615
Go Video 0744, 0715, 0741, 0869, 1044, 1075, 1970	Nova 1923	Sherwood Newcastle 1077	Anam 1609, 1074
Go Vision 1071	Nyko 2340	Shinsonic 0533, 1931	Anthem 2220
GoldStar 0741, 0869	Olevia 2331	Sonic Blue 0869, 1970, 2002	Apex Digital 1257, 1430, 1774
Goodmans 2274	Onkyo 0503, 1769, 0627, 1924, 1985, 2147	Sony 1702, 1896, 1633, 0533, 0864, 0772, 1033, 1070, 1431, 1516, 1536, 1824, 1903, 1904, 1934, 1981, 2020, 2132, 2504	Arcam 1189
Grundig 0539	Oppo 0575, 1224, 1525, 2185, 2545, 2546, 2547	Sova 1122	Audiotronic 1189
Haier 2099, 2500	Oritron 1980	Superscan 0821	Audiovox 1390, 1627
Harman/Kardon 0582, 0702, 1229	Panasonic 0490, 0503, 2967, 2518, 2017, 1990, 1925, 1909, 1908, 1907, 1762, 1641, 1579, 1490, 1462, 1362, 0703, 0632, 0458	Sylvania 0675, 0821, 1268, 2194, 2212	B & K 0820
Helios 2080, 2192	Philco 0675	Symphonic 0675, 0821	Bose 1229, 0639, 1253, 1629, 1841, 1933
Hello Kitty 0831	Philips 0503, 0539, 2056, 2084, 0646, 2531, 2526, 2434, 1914, 1911, 1846, 1506, 1354, 1340, 1267, 1260, 0675	Teac 0790, 1984	Boston Acoustics 1840, 1847, 2162, 2232
Hitachi 0573, 0664, 1919	PianoDisc 1024	Technics 0490, 0703	Brix 1602
Hiteker 0672	Pioneer 0525, 0571, 0142, 0631, 0632, 1460, 1512, 1531, 1571, 1902, 1965, 2442	Terapin 1031	Cambridge Soundworks 1370, 2297
Humax 1500, 1588	Polaroid 1013, 1020, 1061, 1086, 1482, 1998, 2110, 2140	Theta Digital 0571	Cary Audio Design 1879
iLo 1348, 1472	Polk Audio 0539	Tivo 1503, 1512	Carver 1189
Initial 1472, 1931	Portland 0770	Toshiba 0503, 1769, 0695, 1045, 1154, 1503, 1510, 1515, 1588, 1606, 1608, 1854, 2006, 2165, 2277, 2705	Classic 1352
Insignia 0675, 1013, 1268, 1712, 1830, 2095, 2150, 2255, 2428, 2596, 2620		Trutech 2264	Coby 1389, 2127
Integra 0571, 1769, 0627, 1634, 1924, 2147			Cox Cable 1517
iSymphony 1792			Criterion 1420
JBL 0702, 1926			Curtis 1596
JVC 0558, 0623, 0867, 1164, 1275, 1550, 1602, 1863, 1901, 1940, 2365, 2472			
Kawasaki 0790			
Kenwood 0490, 0534			
KLH 0790, 1020, 1149, 1939			
Konka 0711			

- Daewoo 1250  
 Delphi 1414, 1846  
 Denon 2134, 2857, 1360, 1142, 2230, 2263, 2279, 2861, 2862  
 DirecTV 1517  
 Dish Network 1517  
 Electrohome 2026  
 Emerson 1659  
 Fisher 1801  
 Flextronics 1879  
 Gateway 1517  
 Go Video 1532  
 GPX 2319  
 Halcro 1934  
 Harman/Kardon 0892  
 Harman/Kardon 0891, 1304, 1306, 2241, 2443  
 Hitachi 1801  
 iHome 2435  
 iLive 2013  
 Initial 1426  
 Insignia 1030, 1077, 1751, 1893, 2126, 2169, 2175, 2472, 2474, 2545  
 Integra 1298, 1320, 1805, 2989, 2993  
 iSymphony 2018, 2258, 2442  
 Jamo 2160  
 JBL 1306  
 JVC 1374, 1495, 1534, 1560, 1643, 1676, 1811, 1871, 1894, 2040, 2161, 2239, 2299, 2331, 2456  
 Kenwood 1313, 1570, 1569, 1770  
 KLH 1390, 1412, 1428  
 Koss 1366, 1497  
 Krell 1837, 2463  
 Lasonic 1798  
 Lenoxx 1437  
 LG 1293, 2197, 2284  
 Liquid Video 1497  
 Logitech 2217  
 Left Coast 0892  
 Magnavox 1189, 1269, 1514  
 Marantz 0892, 1189, 1269, 1289, 1892, 2114, 2117, 2118, 2138  
 Mark Levinson 2405  
 McIntosh 1289  
 Memorex 1596  
 Micromega 1189  
 Mitsubishi 1393  
 Myryad 1189  
 NAD 1989, 1995, 2457  
 Nakamichi 1313  
 NexxTech 1751  
 Norcent 1389, 1751  
 Nova 1389  
 Onkyo 0842, 1298, 1320, 1531, 1805, 2259, 2451, 2989, 2993  
 Optimus 1023, 1074  
 Oritron 1366, 1497  
 Panasonic 1308, 1518, 1275, 1288, 1316, 1548, 1633, 1763, 1764, 1807, 2221, 2452, 2549, 2967, 2968  
 Parasound 1934, 2245  
 Philips 0892, 1189, 1269, 0891, 1266, 1538, 1831, 2029, 2311, 2459, 2461  
 Pioneer 1023, 1384, 1459, 1935  
 Polaroid 1508  
 Polk Audio 0892, 1289, 1414, 1988, 2115, 2242, 2244, 2270  
 Primare 1851, 2479  
 Proscan 1254  
 RCA 1023, 1609, 1254, 1074, 1390, 1459, 1511, 2041  
 Regent 1437  
 Rio 1869  
 Rotel 2003  
 Saba 1519  
 Samsung 1295, 1304, 1500, 1868  
 Sangean 1888, 2165, 2296  
 Sanyo 1251, 1469, 1801  
 Sharp 1286  
 Sherwood 1077, 1517, 1653, 1905, 2169  
 Sherwood Newcastle 2169  
 Shinsonic 1426  
 Sirius 1602, 1627, 1770, 1811, 1987, 1988, 2124  
 Sonic Blue 1532, 1869  
 Sony 1759, 1058, 1441, 1258, 1622, 2522, 2320, 2216, 2172, 1858, 1822, 1758, 1658, 1558, 1547, 1529, 1406  
 Stereophonics 1023  
 Sunfire 1313, 1521, 1931  
 Super Atlas 1517  
 Teac 1074, 1390, 1528, 2261, 2363  
 Technics 1308, 1518  
 Thorens 1189  
 Thule Audio 1851  
 Toshiba 1788  
 Venturer 1390  
 Vizio 1517  
 XACT 2124  
 XM 1406, 1414, 1846  
 Yamaha 0176, 0376, 1176, 1276, 1331, 1375, 1376, 1476, 1815, 2061, 2455, 2467, 2469, 2471  
 Zenith 1293  
 ZVOX 2332
- Game Console Codes**
- Audio Authority 2555  
 Logitech 2639  
 Messiah Entertainment 2396  
 Microsoft 0522, 2083  
 Nyko 2340  
 Schmartz 2367  
 Sony 0533, 0772  
 Xbox 0522, 2083
- Audio Accessory Codes (Including CD Players and Soundbars)**
- Accurian 1106  
 Acoustic Research 2226  
 Aiwa 0157  
 Altec Lansing 0607, 1056, 2251  
 Apple 1115  
 Arcam 0157  
 ASI 2454  
 B&W 2441  
 Bryston 2368  
 Burmester 0420  
 California Audio Labs 0029, 0303  
 Cambridge Audio 1731  
 Carver 0157, 0179  
 Classe 2046  
 Creative 2288  
 D-Link 1522  
 Denon 0003, 0034, 2502, 2815  
 DKK 0000  
 DLO 1155  
 DMX Electronics 0157  
 Fisher 0179  
 Garrard 0393, 0420  
 Genexxa 0032  
 GPX 2113  
 Griffin 1891  
 Harman/Kardon 0157  
 Hitachi 0032  
 iDeck 1106  
 iHome 2152  
 iLive 2113  
 Integra 0101  
 JVC 0072, 1294  
 Kenwood 0626, 0028, 0190  
 KLH 1318, 1372, 1373, 1711  
 Klipsch 2553  
 Krell 0157, 2464  
 Linn 0157  
 Logitech 2182  
 Magnavox 0157, 0038  
 Marantz 0626, 0029, 0157, 0038, 0180, 0435  
 Mark Levinson 1484  
 McIntosh 0256, 0290, 0660, 1703  
 MCS 0029  
 Memorex 2119  
 Miro 0000  
 Mission 0157  
 Monitor Audio 1106  
 MTC0420  
 Myryad 0157  
 NAD 2096  
 Netgear 1785  
 NSM 0157

Nyko 2231  
 Onkyo 1327, 0101  
 Optimus 0000, 0032, 0087, 0179, 0420, 0468  
 Panasonic 0029, 0303, 0388, 0752  
 Parasound 0420  
 Philips 0626, 0157, 0274  
 Pioneer 1062, 0032, 1087, 0468, 2327  
 Polk Audio 0157, 2228  
 Primare 2480  
 Proceed 0420  
 Proton 0157  
 QED 0157  
 Quad 0157  
 Quasar 0029  
 RCA 1062, 0032, 0053, 0179, 0420, 0468  
 Realistic 0179, 0180, 0420  
 Rotel 0157, 0420, 2046  
 Roku 1828  
 SAE 0157  
 Sansui 0157  
 Sanyo 0087, 0179  
 Sharp 0180  
 Sherwood 0180, 1950  
 Sonic Frontiers 0157  
 Sony 0490, 0000, 0100, 1364, 0185  
 SSI 1522  
 TAG McLaren 0157  
 Tascam 0420  
 Teac 0180, 0378, 0393, 0420  
 Technics 0029, 0303  
 Tivoli Audio 1553, 2158  
 Victor 0072  
 Vizio 2454  
 Wards 0157, 0053  
 Yamaha 0490, 0036, 1292, 1797, 2021, 2116, 2458

**Video Accessory Codes**

Access HD 2185  
 ADB 2254  
 Airlink 101 2491  
 Alpha Digital 2185  
 Amino 1481, 1615, 1673, 2482

AMTC 2185  
 Apex Digital 2478  
 Artec 2490  
 AT&T 0858  
 CASTi 2305  
 Channel Master 2365  
 Chunghwa 1917  
 Cisco 2345, 2517  
 Coby 2667  
 Coship 2487  
 Daewoo 2338  
 Daytek 2305  
 Digital Stream 2303  
 Dish Network 2470  
 Echostar 2470  
 Epson 1563  
 GE 2360, 2450  
 Goodmind 2450  
 Gridlink 2348  
 Insignia 1415  
 KoolConnect 1481  
 Lasonic 2348  
 LG 1415  
 Magnavox 1563  
 Memorex 2486  
 MicroGEM 2489  
 Motorola 0858, 2378  
 Panasonic 1120  
 Philco 1563  
 RCA 2325, 2454  
 Samsung 1190, 1490, 2592  
 Sansonic 2348  
 Scientific Atlanta 0858, 2345, 2517  
 SetaBox 1917  
 Sunkey 2695  
 SureWest 1481  
 Sylvania 1563  
 Tivax 2185  
 Ventura 2454  
 Venturer 2454  
 Verizon 2378  
 Winegard 2454  
 Zenith 1415  
 Zentech 2491  
 Zinwell 2488

**VCR Codes**

ABS 1972  
 Accurian 0000  
 Admiral 0048, 0209, 0020, 0479  
 Adventura 0000  
 Aiko 0278  
 Aiwa 0037, 0000, 0307  
 Akai 0041, 0061, 0106  
 Alienware 1972  
 Allegro 0039  
 America Action 0278  
 American High 0035  
 Asha 0240  
 Audiovox 0037, 0278  
 Beaumark 0240  
 Bell & Howell 0104  
 Broksonic 0184, 0121, 0209, 0002, 0479, 1479  
 Calix 0037  
 Canon 0035  
 Capehart 0020  
 Carver 0081  
 CCE 0072, 0278  
 Citizen 0037, 0278  
 Colt 0072  
 Craig 0037, 0047, 0240, 0072, 0271  
 Crosley 0081, 0000  
 Curtis Mathes 0060, 0035, 0162, 0240, 0041, 0278, 0760  
 Cybernex 0240  
 CyberPower 1972  
 Daewoo 0045, 0278, 0020, 0561  
 Daytron 0020  
 Dell 1972  
 Denon 0042  
 DIRECTV 0739, 0740  
 Durabrand 0039, 0038  
 Dynatech 0000  
 Electrohome 0037, 0043  
 Electrophonic 0037  
 Emerex 0032  
 Emerson 0037, 0184, 0000, 0121, 0043, 0209, 0002, 0278, 0061, 0208, 0479, 0561, 0593, 1479, 1593

Fisher 0047, 0104  
 Fuji 0035, 0033  
 Funai 0000, 0593, 1593  
 Garrard 0000  
 Gateway 1972  
 GE 0060, 0035, 0240, 0202, 0760, 0761, 1060  
 GFM 1593  
 Go Video 0240, 0432, 0526, 0614  
 GoldStar 0037, 0038, 0480  
 Harley Davidson 0000  
 Harman/Kardon 0081, 0038  
 Harwood 0072  
 Headquarter 0046  
 Hewlett Packard 1972  
 HI-Q 0047  
 Hitachi 0000, 0042, 0041, 0105  
 Howard Computers 1972  
 HP 1972  
 Hughes Network Systems 0042, 0740  
 Humax 0739, 1797, 1988  
 Hush 1972  
 iBUYPOWER 1972  
 Instant Replay 0035  
 Jensen 0041  
 JVC 0067, 0041, 0008, 1067, 1707  
 KEC 0037, 0278  
 Kenwood 0067, 0041, 0038  
 KLH 0072  
 Kodak 0035, 0037  
 LG 0480, 1037, 1720  
 Linksys 1972  
 Lloyd's 0000, 0208  
 Logik 0072  
 LXI 0037  
 Magnasonic 0593  
 Magnavox 0035, 0039, 0081, 0000, 0149, 0563, 0593, 1593, 1781  
 Magnin 0240

Marantz 0035, 0081, 0062	Pulsar 0039	Teknika 0035, 0037, 0000
Marta 0037	Quarter 0046	Thomas 0000
Matsushita 0035, 0162, 1162	Quartz 0046	Tivo 0739, 0618, 0636, 0740, 1996
Media Center PC 1972	Quasar 0035, 0162, 1162	TMK 0240, 0208
MEI 0035	RadioShack 0000, 1037	Toshiba 0045, 0043, 0209, 0041, 1008, 1145, 1972, 1988, 1996
Memorex 0035, 0162, 0037, 0048, 0039, 0047, 0240, 0000, 0104, 0209, 0046, 0307, 0479, 1037, 1162, 1262	Radix 0037	Unitech 0240
MGA 0240, 0043, 0061	Randex 0037	Vector 0045
MGN Technology 0240	RCA 0060, 0240, 0042, 0149, 0105, 0106, 0202, 0760, 0761, 0880, 1060	Vector Research 0038
Microsoft 1972	Realistic 0035, 0037, 0048, 0047, 0000, 0104, 0046, 0062	Video Concepts 0045, 0061
Mind 1972	ReplayTV 0614, 0616	Videomagic 0037
Minolta 0042, 0105	Ricavision 1972	Videosonic 0240
Mitsubishi 0067, 0043, 0061	Runco 0039	Viewsonic 1972
Motorola 0035, 0048	Samsung 0240, 0045, 1014	Voodoo 1972
MTC 0240, 0000	Sanky 0048, 0039	Wards 0060, 0035, 0048, 0047, 0081, 0240, 0000, 0042, 0072, 0149, 0062, 0760
Multitech 0000, 0072	Sansui 0000, 0067, 0209, 0041, 0271, 0479, 1479	White Westinghouse 0209, 0072
NEC 0104, 0067, 0041, 0038	Sanyo 0047, 0240, 0104, 0046	XR-1000 0035, 0000, 0072
Nikko 0037	Sceptre 0104	Yamaha 0038
Niveus Media 1972	Scott 0184, 0045, 0121, 0043	Zenith 0037, 0039, 0033, 0000, 0209, 0479, 1139, 1479
Noblex 0240	Sears 0035, 0037, 0047, 0000, 0042, 0104, 0046, 0105	ZT Group 1972
Northgate 1972	Sharp 0048, 0062, 0848, 1893	
Olympus 0035	Shintom 0072	
Optimus 1062, 0162, 0037, 0048, 0104, 0432, 0593, 1048, 1162, 1262	Shogun 0240	
Optonica 0062	Singer 0072	
Orion 0184, 0209, 0002, 0479, 1479	Sonic Blue 0614, 0616	
Panasonic 1062, 0035, 0162, 0614, 0616, 1162, 1262, 1807, 1777	Sony 1232, 0032, 0035, 0033, 0000, 0636, 1032, 1702, 1886, 1896, 1972	
Penney 0035, 0037, 0240, 0042, 0038	Stack9 1972	
Pentax 0042, 0105	STS 0042	
Philco 0035	Sylvania 0035, 0081, 0000, 0043, 0593, 1593, 1781	
Philips 0739, 0035, 0081, 0062, 0618, 1081, 1181, 1818	Symphonic 0000, 0593, 1593	
Pilot 0037	Systemax 1972	
Pioneer 0067, 1803	Totevision 0037, 0240	
Polk Audio 0081	Touch 1972	
Portland 0278, 0020	Tagar Systems 1972	
Presidian 1593	Tashiko 0037	
Profitronic 0240	Tatung 0041	
Proscan 0060, 0202, 0760, 0761, 1060	Teac 0000, 0041	
Protec 0072	Technics 0035, 0162	

## Chapter 10 Maintenance and Troubleshooting

### Cleaning the TV and Remote Control

1. Remove the power adapter cable from the TV.
2. Use a soft cloth moistened with diluted neutral cleaner to clean the TV and remote control. VIZIO recommends using an HDTV cleaning solution which can be purchased at any major retailer.
3. Wring liquid out of the cloth before cleaning to prevent water from penetrating into the housing.
4. Wipe the TV and remote control with a dry cloth after cleaning.

**Important:**

- Do not use volatile solvent (such as toluene, rosin and alcohol). Such chemicals may damage the housing, screen glass, and remote control, and cause labeling to peel.
- The screen glass is very fragile. Do not scrape it with any sharp object.
- Do not press or tap the screen to avoid cracking.

### Troubleshooting Guide

If the TV fails or the performance changes dramatically, check the following troubleshooting guide for possible solutions. Remember to check the peripherals to pinpoint the source of the failure. If the display still fails to perform as expected, contact the VIZIO for assistance by calling 1-877-MYVIZIO (877-698-4946) or e-mail us at [techsupport@vizio.com](mailto:techsupport@vizio.com).

General TV Problems	Solution
Receive the error message "No Signal."	<ul style="list-style-type: none"> <li>• Press the INPUT button on the remote control to select a different input source.</li> <li>• If you are using cable connected directly to the TV or an antenna, scan for channels from the Tuner menu in the OSD.</li> <li>• Press the TV button on the top of the remote to return to the TV mode.</li> </ul>
No power.	<ul style="list-style-type: none"> <li>• Make sure the power button is ON (VIZIO logo glows white).</li> <li>• Make sure the AC power cord is securely connected to the AC socket.</li> <li>• Plug another electrical device to the power outlet to verify that the outlet is working.</li> </ul>
No sound.	<ul style="list-style-type: none"> <li>• Press Volume + (Up) on the remote control.</li> <li>• Press MUTE on the remote control to make sure that MUTE is not ON.</li> <li>• Check your audio settings. The audio may be set to SAP, or the speakers are set to off.</li> <li>• Check the audio connections of external devices that may be connected to the HDTV.</li> <li>• If you are using an antenna, the signal strength of the channel may be low. Make sure your antenna is connected securely to the TV and move the antenna around the room or close to a window.</li> </ul>
If the screen is black.	<ul style="list-style-type: none"> <li>• Make sure the power button is ON (VIZIO Logo glows white).</li> <li>• Press the INPUT button on the remote control to select a different input source.</li> <li>• Check the connections of external devices that may be connected to the HDTV.</li> <li>• Press the TV button on the top of the remote to return to the TV mode.</li> </ul>

General TV Problems	Solution
Power is ON but there is no image on the screen.	<ul style="list-style-type: none"> <li>• Make sure all cables attached to the HDTV are connected to the correct output on the external device.</li> <li>• Adjust brightness, contrast or backlight.</li> <li>• Press the INPUT button on the remote control to select a different input source.</li> <li>• Press the TV button on the top of the remote to return to the TV mode.</li> </ul>
Wrong or abnormal colors appear.	<ul style="list-style-type: none"> <li>• Check Color and Tint settings in Picture Menu.</li> <li>• Reset Picture settings.</li> <li>• Check the video cables to make sure they are securely connected.</li> <li>• If you are using an antenna, the signal strength of the channel may be low. Make sure your antenna is connected securely to the TV and move the antenna around the room or close to a window.</li> </ul>
Control buttons do not work.	<ul style="list-style-type: none"> <li>• Press only one button at a time.</li> <li>• Press the TV button on the top of the remote to return to the TV mode.</li> </ul>
Remote control does not work.	<ul style="list-style-type: none"> <li>• Point the remote control directly at the remote sensor on your TV.</li> <li>• Remove any obstacles between the remote control and the remote sensor.</li> <li>• Replace dead batteries with new ones.</li> <li>• Press the TV button on the top of the remote to return to the TV mode.</li> </ul>
There appear to be image quality issues.	<ul style="list-style-type: none"> <li>• If you are using an antenna, the signal strength of the channel may be low. Make sure your antenna is connected securely to the TV and move the antenna around the room or close to a window.</li> <li>• For best image quality, view HD wide-screen programs where possible.</li> <li>• If HD content is not available view "Standard Definition" from a digital source.</li> <li>• Standard, analog TV will always be noticeably inferior to HD because your digital flat panel TV has video that is many times better than old TV so you will see interference and deficiencies you did not know you had.</li> </ul>
You cannot see a picture.	<ul style="list-style-type: none"> <li>• Make sure the power button is ON (VIZIO logo glows white).</li> <li>• Make sure the AC power cord is securely connected to the AC socket.</li> <li>• Press the INPUT button on the remote control to select a different input source.</li> <li>• Press the TV button on the top of the remote to return to the TV mode.</li> <li>• Check the connections of external devices that may be connected to the HDTV.</li> <li>• If your HDTV is connected to a computer, press any button on your keyboard to "wake" your computer.</li> <li>• If you are using an antenna, the signal strength of the channel may be low. Make sure your antenna is connected securely to the TV and move the antenna around the room or close to a window.</li> </ul>
You see a distorted picture or hear unusual sound.	<ul style="list-style-type: none"> <li>• You may be getting interference from electrical appliances, cars, motorcycles, or fluorescent lights. If you have not mounted it on the wall, try moving your HDTV to another location to see if this is the cause of the problem.</li> </ul>
The picture has abnormal patterns.	<ul style="list-style-type: none"> <li>• Check the connections of external devices that may be connected to the HDTV.</li> <li>• Make sure the specifications of external devices meet the specifications of your HDTV (like resolution).</li> <li>• If you are using an antenna, the signal strength of the channel may be low. Make sure your antenna is connected securely to the TV and move the antenna around the room or close to a window.</li> </ul>

General TV Problems	Solution
The display image does not cover the entire screen.	<ul style="list-style-type: none"> <li>• If you are in RGB mode (Computer), make sure that H-Size and V-Position in the On Screen Display (OSD) are set correctly.</li> <li>• If you are using TV, AV1, AV2 or Component with 480i input, press the WIDE button on the remote control to scroll through various screen modes.</li> </ul>
You can see a picture but you cannot hear sound.	<ul style="list-style-type: none"> <li>• Press Volume + (Up) on the remote control.</li> <li>• Press MUTE on the remote control to make sure that MUTE is not ON.</li> <li>• Check your audio settings. The audio may be set to SAP, or the speakers are set to off.</li> <li>• Check the audio connections of external devices that may be connected to the HDTV.</li> </ul>
The TV has pixels (dots) that are always dark or colored.	<ul style="list-style-type: none"> <li>• Your HDTV is manufactured using an extremely high level of precision technology, however, sometimes some pixels of your HDTV may not display. Pixel defects within industry specifications are inherent to this type of product and do not constitute a defective product.</li> </ul>
You see “noise” or “trash” on the screen.	<ul style="list-style-type: none"> <li>• When your HDTV’s digital capabilities exceed a digital broadcast signal, the signal is up-converted (increased) to match your TV’s display capabilities. Up-converting can cause noise or trash.</li> <li>• If you are using an antenna, the signal strength of the channel may be low. Make sure your antenna is connected securely to the TV and move the antenna around the room or close to a window.</li> </ul>
You switch to a different input and the volume changes.	<ul style="list-style-type: none"> <li>• The TV remembers the volume level from the last time you adjusted it. If the sound level is higher or lower from another source, then the volume will change.</li> </ul>
You switch to a different input and the screen size changes.	<ul style="list-style-type: none"> <li>• The TV remembers the viewing mode from the last time you used a particular input (AV-1, AV-2, Component, HDMI and TV).</li> </ul>
Tips for High-Definition Users.	<ul style="list-style-type: none"> <li>• Your HDTV is an ideal platform for viewing High Definition Content.</li> <li>• Best image quality will be achieved by HDMI. The next best is Component, followed by Composite.</li> <li>• Due to variances in broadcast practices, it is possible some image distortions can occur.</li> </ul>
Tips for Letterbox Content Users.	<ul style="list-style-type: none"> <li>• Some Letterboxed (or “Widescreen”) versions of DVD movies are formatted for standard 4:3 Televisions. Your HDTV has the ability to expand this content so the entire screen is filled at the expense of image accuracy. To use this function, press ZOOM on the remote control to cycle among the options.</li> </ul>

Media Viewer Problems	Solution
USB device is not recognized.	<ul style="list-style-type: none"> <li>• Make sure the device is correctly inserted.</li> <li>• Make sure the device is FAT or FAT32</li> <li>• Make sure it contains the supported files.</li> </ul>
Image or sound is interrupted or distorted.	<ul style="list-style-type: none"> <li>• Make sure the device is correctly inserted.</li> <li>• Make sure that the file complies with the supported format, bit rate and/or profile. Also check the file for damage.</li> <li>• Some files that comply with the supported format may not play back or display properly.</li> </ul>
Slideshow doesn’t start.	<ul style="list-style-type: none"> <li>• Make sure the viewer isn’t in pause, rotation, or zoom mode.</li> </ul>

## Telephone & Technical Support

Products are often returned due to a technical problem rather than a defective product that may result in unnecessary shipping charges billed to you. Our trained support personnel can often resolve the problem over the phone. For more information on warranty service or repair, after the warranty period, contact our Support Department at the number below.

Customer support and quality service are integral parts of VIZIO's commitment to service excellence. For technical assistance contact our VIZIO Technical Support Department via email or phone.

Email: [techsupport@VIZIO.com](mailto:techsupport@VIZIO.com)

(877) 698-4946 Fax: (949) 585-9563

Hours of operation: Monday - Friday: 6 am to 9 pm

Saturday – Sunday: 8 am to 4 pm

Have your VIZIO model number, serial number, and date of purchase available before you call.

**VIZIO**

Address:

39 Tesla

Irvine, CA 92618, USA

Telephone: (888) 849-4623 (949) 428-2525 Fax: (949) 585-9514

Web: [www.VIZIO.com](http://www.VIZIO.com)

## Compliance

Caution: Always use a power cable that is properly grounded. Use the AC cords listed below for each area.

**USA:** UL

**Canada:** CSA

**Germany:** VDE

**UK:** BASE/BS

**Japan:** Electric Appliance Control Act

## FCC Class B Radio Interference Statement

NOTE: This equipment has been tested and found to comply with the limits for a Class B digital device, pursuant to Part 15 of the FCC Rules. These limits are designed to provide reasonable protection against harmful interference in a residential installation. This equipment generates, uses and can radiate radio frequency energy, and if not installed and used in accordance with the instructions, may cause harmful interference to radio communications. However, there is no guarantee that interference will not occur in a particular installation. If this equipment does cause harmful interference to radio or television reception, which can be determined by turning the equipment off and on, the user is encouraged to try to correct the interference by one or more of the following measures:

1. Reorient or relocate the receiving antenna.
2. Increase the separation between the equipment and receiver.
3. Connect the equipment into an outlet on a circuit different from that to which the receiver is connected.
4. Consult the dealer or an experienced radio/TV technician for help.

Notice:

1. The changes or modifications not expressly approved by the party responsible for compliance could void the user's authority to operate the equipment.
2. Shielded interface cables and AC AC/DC power adapter, if any, must be used in order to comply with the emission limits.
3. The manufacturer is not responsible for any radio or TV interference caused by unauthorized modification to this equipment. It is the responsibilities of the user to correct such interference.



## Chapter 11 Specifications

Product specifications may change without notice or obligation.

### E421VL Specifications

E421VL	Specifications	
Panel	42.02" Diagonal, 16:9 Aspect Ratio	
Resolution	1920 x 1080 pixels	
Pixel (Dot) Pitch	0.4845mm (H) x 0.4845mm (H)	
Display Compatibility	1080P (FHDTV)	
Colors	1.06 billion @ 10 bit	
Brightness cd/m2 (typical)	500nits	
Contrast	Dynamic Contrast Ratio: 100,000:1	
Response Time	5ms (typical)	
Viewing Angle	178° (horizontal/vertical)	
Inputs	3 x HDMI with HDCP (1 with L/R audio inputs) 1 x RF (F connector for internal tuner) 1x Composite Video and Stereo Audio 1x Component YPbPr plus Stereo Audio 1x Computer RGB plus Stereo Audio 1x USB (side)	
Outputs	1x 5.1 S/PDIF Optical Digital Audio, 1x Stereo Audio	
Features	MEMC, 1080P FHDTV, 120Hz PANEL, 10-BIT VIDEO PROCESSING, MTS STEREO DECODER, HDMI v1.3, 3D COMB FILTER, DIGITAL AUDIO AMPLIFIER, DYNAMIC CONTRAST RATIO TECHNOLOGY, ZERO BRIGHT PIXEL GUARANTEE, HD GAME PORT, DIGITAL AUDIO AMPLIFIER, NOISE REDUCTION, DOLBY DIGITAL FOR ATSC/QAM, SIGNAL COMPATIBILITY: 480I(SDTV), 480P(EDTV), 720P(HDTV), 1080I(HDTV), 1080P(FHDTV), CHANNEL SKIP/ADD, FAVORITE CHANNEL, VIDEO/INPUT NAMING CAPABILITY, CLOSED CAPTION, PARENTAL CONTROL/V-CHIP 2.0, PROGRAMMABLE TIMER, PIP/POP, SRS TSHD, SRS TruVolume, VESA MOUNT COMPATIBLE, MULTIMEDIA.	
Special Features	<ul style="list-style-type: none"> <li>• 120Hz panel W/O scanning backlight</li> <li>• Multimedia(JPEG)</li> <li>• HDMI CEC</li> <li>• Ambient light sensor</li> <li>• 1080 FHDTV</li> <li>• HDMI v1.3</li> <li>• DYNAMIC CONTRAST RATIO TECHNOLOGY</li> <li>• DOLBY DIGITAL FOR ATSC/QAM</li> </ul>	<ul style="list-style-type: none"> <li>• 480I(SDTV), 480P(EDTV), 720P(HDTV), 1080I(HDTV), 1080P (FHDTV)</li> <li>• CHANNEL SKIP VIDEO/INPUT NAMING CAPABILITY</li> <li>• CLOSED CAPTION</li> <li>• PARENTAL CONTROL/V-CHIP 2.0</li> <li>• PROGRAMMABLE TIMER</li> <li>• SRS TSHD</li> <li>• SRS TruVolume</li> <li>• DETACHABLE BASE</li> </ul>
Speakers	2xBuilt-in, 10W Speakers	
Panel Life	50,000 hours to half the original brightness	

Power	
Input	IEC Connector for direct power line connection
Voltage Range	100~240Vac at 50/60Hz
Power Consumption	111W (Avg), 0.37W standby
Environmental Conditions	
Operating	Temperature: 5°C~35°C, Relative Humidity: 20~80%, Altitude: 0~14,000 ft
Non-Operating	Temperature: -20°C~50°C, Relative Humidity: 10~70%, Altitude: 0~40,000 ft
Dimensions	40.26" W x 27.48" H x 8.99" D with stand; 40.26" W x 25.91" H x 3.51" D without stand 1023 x 698 x 228.4 mm with stand; 1023x 658 x 89.3 mm without stand
Net Weight	32.85 lbs with stand; 31.09 lbs without stand 14.9 kg with stand; 14.1 kg without stand
Gross Weight	42.99 lbs; 19.50 kg
Certifications	CSA, CSA-US, FCC Class B
Compliances	Energy Star 4.0. ATSC Spec A/65, EIA/CEA-766-A

## E470VL Specifications

E470VL	Specifications
Panel	46.96" Diagonal, 16:9 Aspect Ratio
Resolution	1920 x 1080 pixels
Pixel (Dot) Pitch	0.5415mm (H) x 0.5415mm (V)
Display Compatibility	1080P (FHDTV)
Colors	1.06 Billion @ 10 bit color depth
Brightness cd/m2 (typical)	500nits
Contrast	Dynamic Contrast Ratio: 100,000:1
Response Time	5ms (typical)
Viewing Angle	178° (horizontal/vertical)
Inputs	3 x HDMI with HDCP (1 with L/R audio inputs) 1 x RF (F connector for internal tuner) 1x Composite Video and Stereo Audio 1x Component YPbPr plus Stereo Audio 1x Computer RGB plus Stereo Audio 1x USB (side)
Outputs	1x 5.1 S/PDIF Optical Digital Audio, 1x Stereo Audio
Features	MEMC, 1080P FHDTV, 120Hz PANEL, 10-BIT VIDEO PROCESSING, MTS STEREO DECODER, HDMI v1.3, 3D COMB FILTER, DIGITAL AUDIO AMPLIFIER, DYNAMIC CONTRAST RATIO TECHNOLOGY, ZERO BRIGHT PIXEL GUARRANTEE, HD GAME PORT, DIGITAL AUDIO AMPLIFIER, NOISE REDUCTION, DOLBY DIGITAL FOR ATSC/QAM, SIGNAL COMPATIBILITY: 480I(SDTV), 480P(EDTV), 720P(HDTV), 1080I(HDTV), 1080P(FHDTV), CHANNEL SKIP/ADD, FAVORITE CHANNEL, VIDEO/INPUT NAMING CAPABILITY, CLOSED CAPTION, PARENTAL CONTROL/V-CHIP 2.0,

	PROGRAMMABLE TIMER, PIP/POP, SRS TSHD, SRS TruVolume, VESA MOUNT COMPATIBLE, MULTIMEDIA.	
Special Features	<ul style="list-style-type: none"> <li>• 120Hz panel W/O scanning backlight</li> <li>• Multimedia(JPEG)</li> <li>• HDMI CEC</li> <li>• Ambient light sensor</li> <li>• 1080 FHDTV</li> <li>• HDMI v1.3</li> <li>• DYNAMIC CONTRAST RATIO TECHNOLOGY</li> <li>• DOLBY DIGITAL FOR ATSC/QAM</li> </ul>	<ul style="list-style-type: none"> <li>• 480I(SDTV), 480P(EDTV), 720P(HDTV), 1080I(HDTV), 1080P (FHDTV)</li> <li>• CHANNEL SKIP VIDEO/INPUT NAMING CAPABILITY</li> <li>• CLOSED CAPTION</li> <li>• PARENTAL CONTROL/V-CHIP 2.0</li> <li>• PROGRAMMABLE TIMER</li> <li>• SRS TSHD</li> <li>• SRS TruVolume</li> <li>• DETACHABLE BASE</li> </ul>
Speakers	2xBuilt-in, 10W Speakers	
Panel Life	50,000 hours to half the original brightness	
<b>Power</b>		
Input	IEC Connector for direct power line connection	
Voltage Range	100~240Vac at 50/60Hz	
Power Consumption	134W (Avg), 0.37W standby	
<b>Environmental Conditions</b>		
Operating	Temperature: 5°C~35°C, Relative Humidity: 20~80%, Altitude: 0~14,000 ft	
Non-Operating	Temperature: -20°C~50°C, Relative Humidity: 10~70%, Altitude: 0~40,000 ft	
Dimensions	44.65" W x 29.99" H x 10.43" D with stand; 44.65" W x 28.44" H x 3.66" D without stand 1134 x 761.8 x 265 mm with stand; 1134 x 722.4 x 93.1 mm without stand	
Net Weight	44.75 lbs with stand; 39.68 lbs without stand; 20.3 kg with stand; 18 kg without stand	
Gross Weight	58.86 lbs; 26.7 kg	
Certifications	CSA, CSA-US, FCC Class B	
Compliances	Energy Star 4.0. ATSC Spec A/65, EIA/CEA-766-A	

## E551VL Specifications

E551VL	Specifications
Panel	54.64" Diagonal, 16:9 Aspect Ratio
Resolution	1920 x 1080 pixels
Pixel (Dot) Pitch	0.630 mm (H) x 0.630 mm (V)
Display Compatibility	1080P (FHDTV)
Colors	1.06 Billion @ 10 bit color depth
Brightness cd/m2 (typical)	500nits
Contrast	Dynamic Contrast Ratio: 100,000:1
Response Time	5ms (typical)
Viewing Angle	178° (horizontal/vertical)

Inputs	3 x HDMI with HDCP (1 with L/R audio inputs) 1 x RF (F connector for internal tuner) 1x Composite Video and Stereo Audio 1x Component YPbPr plus Stereo Audio 1x Computer RGB plus Stereo Audio 1x USB (side)
Outputs	1x 5.1 S/PDIF Optical Digital Audio, 1x Stereo Audio
Features	MEMC, 1080P FHDTV, 120Hz PANEL, 10-BIT VIDEO PROCESSING, MTS STEREO DECODER, HDMI v1.3, 3D COMB FILTER, DIGITAL AUDIO AMPLIFIER, DYNAMIC CONTRAST RATIO TECHNOLOGY, ZERO BRIGHT PIXEL GUARANTEE, HD GAME PORT, DIGITAL AUDIO AMPLIFIER, NOISE REDUCTION, DOLBY DIGITAL FOR ATSC/QAM, SIGNAL COMPATIBILITY: 480I(SDTV), 480P(EDTV), 720P(HDTV), 1080I(HDTV), 1080P(FHDTV), CHANNEL SKIP/ADD, FAVORITE CHANNEL, VIDEO/INPUT NAMING CAPABILITY, CLOSED CAPTION, PARENTAL CONTROL/V-CHIP 2.0, PROGRAMMABLE TIMER, PIP/POP, SRS TSHD, SRS TruVolume, VESA MOUNT COMPATIBLE, MULTIMEDIA.
Special Features	<ul style="list-style-type: none"> <li>• 120Hz panel W/O scanning backlight</li> <li>• Multimedia(JPEG)</li> <li>• HDMI CEC</li> <li>• Ambient light sensor</li> <li>• 1080 FHDTV</li> <li>• HDMI v1.3</li> <li>• DYNAMIC CONTRAST RATIO TECHNOLOGY</li> <li>• DOLBY DIGITAL FOR ATSC/QAM</li> </ul>
	<ul style="list-style-type: none"> <li>• 480I(SDTV), 480P(EDTV), 720P(HDTV), 1080I(HDTV), 1080P (FHDTV)</li> <li>• CHANNEL SKIP VIDEO/INPUT NAMING CAPABILITY</li> <li>• CLOSED CAPTION</li> <li>• PARENTAL CONTROL/V-CHIP 2.0</li> <li>• PROGRAMMABLE TIMER</li> <li>• SRS TSHD</li> <li>• SRS TruVolume</li> </ul>
Speakers	2xBuilt-in, 15W Speakers
Panel Life	50,000 hours to half the original brightness
<b>Power</b>	
Input	IEC Connector for direct power line connection
Voltage Range	100~240Vac at 50/60Hz
Power Consumption	155W (Avg), 0.37W standby
<b>Environmental Conditions</b>	
Operating	Temperature: 5°C~35°C, Relative Humidity: 20~80%, Altitude: 0~14,000 ft
Non-Operating	Temperature: -20°C~50°C, Relative Humidity: 10~70%, Altitude: 0~40,000 ft
Dimensions	52.13" W x 34.44" H x 13.15" D with stand; 52.13" W x 32.56" H x 4.95" D without stand 1324 x 875 x 334 mm with stand; 1324 x 827 x 125.7 mm without stand
Net Weight	78.71 lbs with stand; 67.68 lbs without stand 35.7 kg with stand; 30.7 kg without stand
Gross Weight	95.9 lbs; 43.5 kg
Certifications	CSA, CSA-US, FCC Class B
Compliances	Energy Star 4.0. ATSC Spec A/65, EIA/CEA-766-A

## Preset PC Resolutions

If connecting to a PC through the RGB PC input, set the TV timing mode to VESA 1920x1080 at 60Hz for best picture quality (refer to the graphic card's user guide for questions on how to set this timing mode). See the table below for the factory preset resolutions.

Mode No.	Resolution	Refresh Rate (Hz)	Horizontal Frequency (KHz)	Vertical Frequency (Hz)	Horizontal Sync Polarity (TTL)	Vertical Sync Polarity (TTL)	Pixel Rate (MHz)	Remark
1	640 x 480	60	31.469	59.941	N	N	25.175	Windows
2	640 x 480	75	37.500	75.000	N	N	31.500	Windows
3	800 x 600	60	37.879	60.317	P	P	40.000	Windows
4	800 x 600	72	48.077	72.188	P	P	50.000	Windows
5	800 x 600	75	46.875	75.000	P	P	49.500	Windows
6	1024 x 768	60	48.363	60.004	N	N	65.000	Windows
7	1024 x 768	70	56.476	70.069	N	N	75.000	Windows
8	1024 x 768	75	60.023	75.029	P	P	78.750	Windows
9	720 x 400	70	31.469	70.087	N	P	28.322	DOS
10	Ⓢ1920 x 1080	60	66.587	59.934	P	N	138.50	Windows

Note: P: positive, N: negative, Ⓢ: Primary mode

## Resolution through RGB Input

If your PC supports VESA Reduce Blanking timing via the VGA card drive program (usually offered by the VGA Card Manufacturer), your TV set is equipped to have the 1920x1080 resolution display through this connection using the following timing 138.5MHz. The following parameters are often the values required by the software or programs to set up the display:

Parameters	Horizontal Values (Pixels)	Vertical Values (Lines)
Address	1920	1080
Front Porch	48	3
Sync Width	32	5
Back Porch	80	23
Total	2080	1111
Frequency	66.587 KHz	59.934 Hz
Sync Polarity	P	N
Pixel Rate (MHz)	138.5	
Refresh Rate (Hz)	60	

## Warranty

### ONE-YEAR LIMITED WARRANTY ON PARTS AND LABOR

*(Covers units purchased as new in United States and Puerto Rico Only)*

VIZIO provides a warranty to the original purchaser of its products against defects in materials and workmanship for a period of one year of non-commercial usage and ninety (90) days of commercial use. If a VIZIO product is defective within the warranty period, VIZIO will either repair or replace the unit at its sole option and discretion.

To obtain warranty service, contact VIZIO Technical Support via email: [TechSupport@VIZIO.com](mailto:TechSupport@VIZIO.com) or via phone at 877 MY VIZIO (877.698.4946) from 6:00AM to 9:00PM Monday through Friday and 8:00AM to 4:00PM Saturday and Sunday, Pacific Time, or visit [www.VIZIO.com](http://www.VIZIO.com). Proof of purchase in the form of a purchase receipt or copy thereof is required.

#### Parts and Labor

There will be no charge for parts or labor during the warranty period. Replacement parts and units may be new or recertified at VIZIO's option and sole discretion. Replacement parts and units are warranted for the remaining portion of the original warranty or for ninety (90) days from warranty service or replacement, whichever is later.

#### Types of Service

Units 30" or larger will usually be serviced in-home. In-home service requires complete and easy access to the unit and does not include de-installation or re-installation of the product. However, in some cases, it may be necessary to send the unit to a VIZIO service center. VIZIO will cover the transportation charges to and from the same customer location.

Units less than 30" must be sent to a VIZIO service center. VIZIO is not responsible for transportation costs to the service center, but VIZIO will cover return shipping to the customer. **PRE-AUTHORIZATION IS REQUIRED BEFORE SENDING ANY UNIT IN FOR SERVICE.**

Any returns to VIZIO's service centers must utilize either the original carton box and shipping material or a replacement box and material provided by VIZIO. VIZIO technical support will provide instructions for packing and shipping the unit to the VIZIO service center.

#### Limitations and Exclusions

VIZIO's one-year limited warranty only covers defects in materials and workmanship. Items not covered include but are not limited to cosmetic damage, normal wear and tear, misuse, signal issues, power surges, and damages from shipping, acts of God, any sort of customer misuse, installation, customer modifications, adjustments, and set-up issues. Units with unreadable or removed serial numbers, "image burn-in", and routine maintenance are not covered. This warranty does not cover products sold "AS IS", "FACTORY RECERTIFIED", or by a non-authorized reseller.

THERE ARE NO EXPRESS WARRANTIES OTHER THAN THOSE LISTED OR DESCRIBED ABOVE. ANY IMPLIED WARRANTIES, INCLUDING ANY IMPLIED WARRANTY OF MERCHANTABILITY AND FITNESS FOR A PARTICULAR PURPOSE, SHALL BE LIMITED IN DURATION TO THE PERIOD OF TIME SET FORTH ABOVE. VIZIO'S TOTAL LIABILITY FOR ANY AND ALL LOSSES AND DAMAGES RESULTING FROM ANY CAUSE WHATSOEVER SHALL IN NO EVENT EXCEED THE PURCHASE PRICE OF THE DISPLAY. VIZIO SHALL NOT BE RESPONSIBLE FOR LOSS OF USE, COMMERCIAL LOSS, LOST REVENUE OR LOST PROFITS, OR OTHER INCIDENTAL OR CONSEQUENTIAL DAMAGES. SOME STATES DO NOT ALLOW LIMITATIONS ON HOW LONG AN IMPLIED WARRANTY LASTS OR THE EXCLUSION OF INCIDENTAL OR CONSEQUENTIAL DAMAGES, SO THE ABOVE LIMITATIONS OR EXCLUSIONS MAY NOT APPLY TO YOU. THIS WARRANTY GIVES YOU SPECIFIC LEGAL RIGHTS, AND YOU MAY ALSO HAVE OTHER RIGHTS, WHICH VARY FROM STATE TO STATE. THIS WARRANTY IS SUBJECT TO CHANGE WITHOUT NOTICE. CHECK [www.VIZIO.com](http://www.VIZIO.com) FOR THE MOST CURRENT VERSION.

#### Personal Data

If your VIZIO product is capable of storing personal data and other information, **ALL CONTENTS AND INFORMATION WILL BE DELETED IN THE COURSE OF SOME IN-HOME AND ALL SHIP-IN WARRANTY SERVICE.** If this occurs, your product will be restored to you configured **as originally purchased.** You will be **responsible for restoring all applicable data and passwords.** Recovery and reinstallation of user data is not covered under this Limited Warranty. **In order to protect your personal information, VIZIO recommends that you always clear all personal information from the unit before it is serviced, regardless of the servicer.**

#### ZERO BRIGHT PIXEL DEFECT GUARANTEE

This policy covers "zero bright pixel" defects for the duration of the limited "ONE YEAR WARRANTY" on select new product purchases. To determine if this guarantee applies to your product, refer to the "DETAILS" tab of the model's product information page ([www.VIZIO.com](http://www.VIZIO.com)) or look for the "zero bright pixel" guarantee on the box.

# Index

16:9 .....	33	Controls	
4:3 .....	33	Front Panel .....	14
Accessories .....	9	Side Panel .....	14
Adjustments		Daylight Savings setting .....	43
Advanced .....	32	DTV Transition .....	5
Volume .....	14	DVD Player	
Advanced Adjustments .....	32	Connecting .....	25
Ambient Light Sensor .....	36	DVI	
Antenna .....	22	Cable Box .....	23
Aspect Ratio .....	33	DVD Player .....	25
Audio Menu		Satellite Box .....	23
Advanced Audio .....	39	EPG .....	21
Analog Audio Out .....	39	Equalizer Settings .....	39
Audio Mode .....	38	Getting Started .....	19
Balance .....	38	Grounding .....	4
Digital Audio Out .....	39	GUIDE Button .....	21
Equalizer adjustments .....	39	HDMI .....	22
Lip Sync .....	38	Help Menu	
Reset Audio Mode .....	40	Reset All Settings .....	45
SRS TruSurroundHD .....	39	Setup Wizard .....	45
SRS TruVolume .....	39	System Info .....	45
TV Speakers .....	38	Help Menu .....	45
AV connector .....	22	Home Theater	
Bass .....	39	Connecting .....	28
Blackbars .....	33	Horizontal/Vertical Position adjustments .....	35
Blocking Channels .....	41	Input Source	
Brightness .....	34	Choosing .....	20
Cable Box		Inputs	
Connecting .....	23	Antenna .....	4
CC Closed Caption .....	34	Connectors .....	22
CEC .....	44	Maintenance of TV .....	62
Cleaning .....	62	Media Menu	
Coaxial connection		Duration .....	31, 45
Satellite box .....	27	Info .....	31, 45
Coaxial Connection		Repeat .....	31, 44
Cable TV .....	27	Slideshow .....	31, 44
Color .....	35	Slideshow Effect .....	31, 45
Component Connector .....	22	Sort By .....	31, 44
Composite Connector .....	22	Thumbnail Size .....	31, 45
Computer		Menu Language .....	43
Connecting .....	29	Name Input .....	41
Preset Resolutions .....	70	OSD .....	32
Resolution through RGB .....	70	CC Menu .....	34
Connecting		Help Menu .....	45
Computer .....	29	Input Menu .....	32
RGB .....	29	Photo Menu .....	44
VGA .....	29	Picture Menu .....	34
Connecting Equipment		PIP Menu .....	37
Cable .....	23	Settings Menu .....	38
DVD .....	25	Sleep Timer Menu .....	34
Home Theater .....	28	Wide Menu .....	33
Rear Panel Connections .....	15	Parental Controls	
Satellite Box .....	23	Alt Rating Region .....	43
Sound system .....	28	Block Unrated TV .....	43
Stereo .....	28	Canadian English Rating .....	42
VCR .....	27	Canadian French Rating .....	43
Video Camera .....	27	Change the Password .....	43
Contents .....	9	Channel Block .....	41
Contrast .....	35	Rating Enable .....	41

Reset Locks .....	43	All TV Settings.....	45
USA Movie Rating .....	42	Audio Settings .....	40
USA TV Rating .....	42	Factory Default .....	45
Parental Controls .....	41	Picture Settings .....	37
Password .....	43	RGB .....	22
Photo Menu .....	44	Safety Instructions.....	2
Photos		Satellite Box	
Adjusting Settings .....	31	Connecting .....	23
Viewing .....	30	Search for channels .....	40
Picture		Setting Up .....	10
Reset Picture Mode.....	37	Settings Menu	
Picture Menu .....	34	Audio .....	38, 41
Adaptive Luma .....	36	CEC .....	44
Ambient Light Sensor.....	36	Menu Language .....	43
Backlight .....	34	Parental Controls Menu .....	41
Backlight Control.....	36	Time & Local Settings .....	43
Brightness .....	34	Setup Wizard.....	19
Color .....	35	Sharpness .....	35
Color Enhancement .....	36	Skip Channel .....	40
Color Temperature .....	36	Slideshow	
Contrast .....	35	Duration .....	31, 45
Film Mode .....	36	Effect.....	31, 45
MPEG NR .....	36	Mode .....	31, 44
Noise Reduction.....	36	Repeat .....	31, 44
Picture Mode .....	34	Specifications .....	66
Real Cinema .....	36	Stereo	
Sharpness.....	35	Connecting .....	28
Smooth Motion .....	36	Surround Sound.....	39
Tint.....	35	System Information .....	45
Pictures		Technical Support .....	65
Adjusting Settings .....	31	Time Zone setting .....	43
Create Slideshow.....	31, 44	Tint.....	35
Info .....	31, 45	Treble.....	39
Sort .....	31, 44	Troubleshooting .....	62
Thumbnail Size .....	31, 45	Tuner Menu	
Viewing .....	30	Analog MTS .....	40
PIP .....	37	Auto Search .....	40
Audio .....	37	Skip Channel.....	40
Mode .....	37	Tuner Mode.....	40
Position .....	37	TV Menu .....	32
Size .....	37	Partial Channel Search .....	40
Source.....	37	USB Port .....	30
Remote		VCR	
Programming Cable Box .....	47	Connecting .....	27
Programming DVD Player.....	46	Video Camera	
Programming Home Theater System.....	46	Connecting .....	27
Programming Satellite Box.....	47	Wall mounting .....	13
Remote Control.....	16	Warranty .....	71
Batteries .....	16	Watching TV	
Buttons .....	17, 18	Getting your Programs .....	20
Precautions .....	16	Program Information .....	21
Range .....	16	Wide.....	33
Reset		Wizard.....	45



# VIZIO

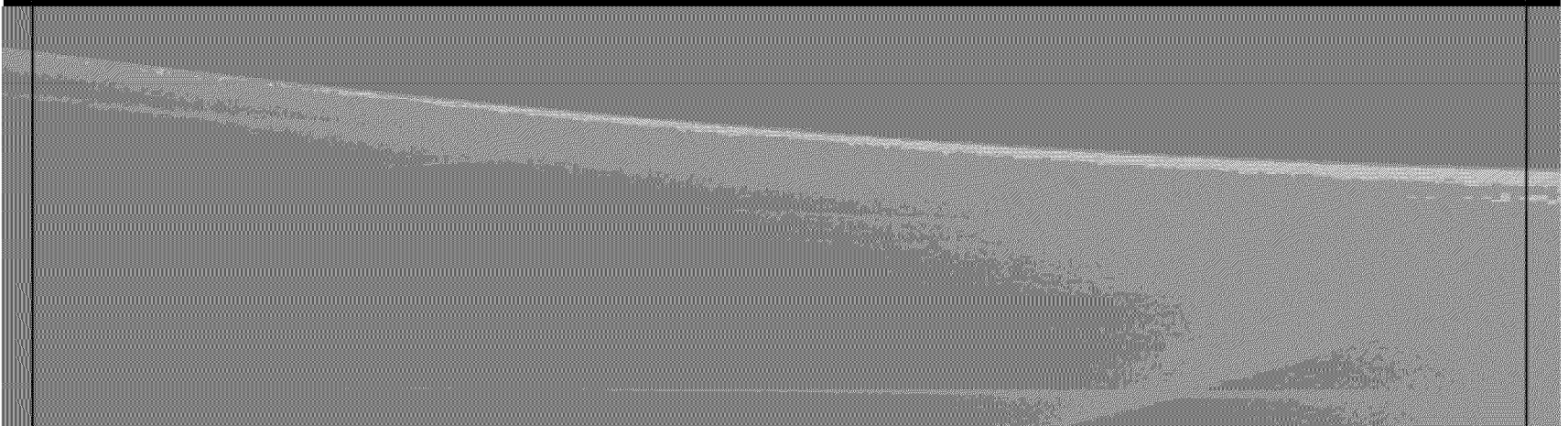

TRADEMARKS SHOWN ARE THE PROPERTY OF THEIR RESPECTIVE OWNERS. IMAGES USED ARE FOR ILLUSTRATION PURPOSES ONLY. VIZIO, THE V LOGO, WHERE VISION MEETS VALUE AND OTHER VIZIO TRADEMARKS ARE THE INTELLECTUAL PROPERTY OF VIZIO INC. PRODUCT FEATURES AND SPECIFICATIONS ARE SUBJECT TO CHANGE WITHOUT NOTICE. © 2010 VIZIO INC. ALL RIGHTS RESERVED.

[www.VIZIO.com](http://www.VIZIO.com)

