

HW-D600  
HW-D650S

# AV Receiver System user manual

imagine the possibilities

Thank you for purchasing this Samsung product.  
To receive more complete service,  
please register your product at  
[www.samsung.com/register](http://www.samsung.com/register)

**SAMSUNG**

# Safety Information

## Safety Warnings

TO REDUCE THE RISK OF ELECTRIC SHOCK, DO NOT REMOVE THE COVER(OR BACK). NO USER-SERVICEABLE PARTS ARE INSIDE.  
REFER SERVICING TO QUALIFIED SERVICE PERSONNEL.



This symbol indicates "dangerous voltage" inside the product that presents a risk of electric shock or personal injury.



This symbol indicates important instructions accompanying the product.

### WARNING

- To reduce the risk of fire or electric shock, do not expose this appliance to rain or moisture.
- To prevent injury, this apparatus must be securely attached to the floor/wall in accordance with the installation instructions.

### CAUTION

- Apparatus shall not be exposed to dripping or splashing and no objects filled with liquids, such as vases, shall be placed on the apparatus.
- The Mains plug is used as a disconnect device and shall stay readily operable at any time.

This product satisfies FCC regulations when shielded cables and connectors are used to connect the unit to other equipment. To prevent electromagnetic interference with electric appliances, such as radios and televisions, use shielded cables and connectors for connections.

### FCC NOTE (FOR U.S.A):

This equipment has been tested and found to comply with the limits for a Class B digital device, pursuant to Part 15 of the FCC Rules. These limits are designed to provide reasonable protection against harmful interference in a residential installation.

This equipment generates, uses and can radiate radio frequency energy and, if not installed and used in accordance with the instructions, may cause harmful interference to radio communications. However, there is no guarantee that interference will not occur in a particular installation.

If this equipment does cause harmful interference to radio or television reception, which can be determined by turning the equipment off and on, the user is encouraged to try to correct the interference by one or more of the following measures:

- Reorient or relocate the receiving antenna.
- Increase the separation between the equipment and receiver.
- Connect the equipment into an outlet on a circuit different from that to which the receiver is connected.
- Consult the dealer or an experienced radio/TV technician for help.

Caution : FCC regulations state that any unauthorized changes or modifications to this equipment may void the user's authority to operate it.

### License

- Manufactured under license from Dolby Laboratories. Dolby, Pro Logic and the double-D symbol are trademarks of Dolby Laboratories.
- Manufactured under license under U.S. Patent #'s: 5,451,942; 5,956,674; 5,974,380; 5,978,762; 6,226,616; 6,487,535; 7,212,872; 7,333,929; 7,392,195; 7,272,567 & other U.S. and worldwide patents issued & pending. DTS and the Symbol are registered trademarks, & DTS-HD, DTS-HD Master Audio | Essential, and the DTS logos are trademarks of DTS, Inc. Product includes software. © DTS, Inc. All Rights Reserved.

## Important Safety Instructions

This device complies with part 15 of the FCC Rules.

Operation is subject to the following two conditions: (1) This device may not cause harmful interference, and (2) this device must accept any interference received, including interference that may cause undesired operation.

### IMPORTANT NOTE:

#### FCC Radiation Exposure Statement

This equipment complies with FCC radiation exposure limits set forth an uncontrolled environment.

This equipment should be installed and operated with minimum distance 7.9 inches between the radiator and your body. This transmitter must not be co-located or operating in conjunction with any other antenna or transmitter.

#### Canadian Department of Communications Radio Interference Regulations

This digital apparatus (Wireless Internet Radio) does not exceed the Class B limits for radio-noise emissions from digital apparatus as set out in the Radio Interference Regulations of the Canadian Department of Communications.

Read these operating instructions carefully before using the unit. Follow all the safety instructions listed below. Keep these operating instructions handy for future reference.

- 1) Read these instructions.
- 2) Keep these Instructions.
- 3) Heed all warnings.
- 4) Follow all instructions.
- 5) Do not use this apparatus near water.
- 6) Clean only with dry cloth.
- 7) Do not block any ventilation openings. Install in accordance with the manufacturer's instructions.
- 8) Do not install near any heat sources such as radiators, heat registers, stoves, or other apparatus (including amplifiers) that produce heat.
- 9) Do not defeat the safety purpose of the polarized or grounding-type plug. A polarized plug has two blades with one wider than the other. A grounding type plug has two blades and a third grounding prong. The wide blade or the third prong are provided for your safety. If the provided plug does not fit into your outlet, consult an electrician for replacement of the obsolete outlet.
- 10) Protect the power cord from being walked on or pinched particularly at plugs, convenience receptacles, and the point where they exit from the apparatus.
- 11) Only use attachment/accessories specified by the manufacturer.
- 12) Use only with the cart, stand, tripod, bracket, or table specified by the manufacturer, or sold with the apparatus. When a cart is used, use caution when moving the cart/apparatus combination to avoid injury from tip-over.
- 13) Unplug this apparatus during lightning storms or when unused for long periods of time.
- 14) Refer all servicing to qualified service personnel. Servicing is required when the apparatus has been damaged in any way, such as power-supply cord or plug is damaged, liquid has been spilled or objects have fallen into the apparatus, the apparatus has been exposed to rain or moisture, does not operate normally, or has been dropped.



# Safety Information

## Precautions

- Ensure that the AC power supply in your house complies with specifications listed on the identification sticker located on the back of your product.
- Install your product horizontally, on a suitable base (furniture), with enough space around it for ventilation (7.5~10cm / 20~25 inches).
- Do not place the product on amplifiers or other equipment which may become hot. Make sure the ventilation slots are not covered.
- Do not stack anything on top of the product.
- To disconnect the product completely from the power supply, remove its plug from the wall outlet.
  - If you leave the product unused for a long period of time, disconnect the plug from the wall outlet.
- During thunderstorms, disconnect the AC plug from the wall outlet. Voltage spikes caused by lightning could damage the product.
- Do not expose the product to direct sunlight or other heat sources. This could cause the product to overheat and malfunction.
- Protect the product from moisture, excess heat, and equipment creating strong magnetic or electric fields (i.e. speakers.).
- Disconnect the power cable from the AC supply if the product malfunctions.
- Your product is not intended for industrial use. It is for personal use only.
- Condensation may occur if you store your product in cold temperatures. If transporting the product during the winter, wait approximately 2 hours until the product has reached room temperature before using.
- The batteries used with this product contain chemicals that are harmful to the environment. Do not dispose of batteries in the general household trash.

# Contents

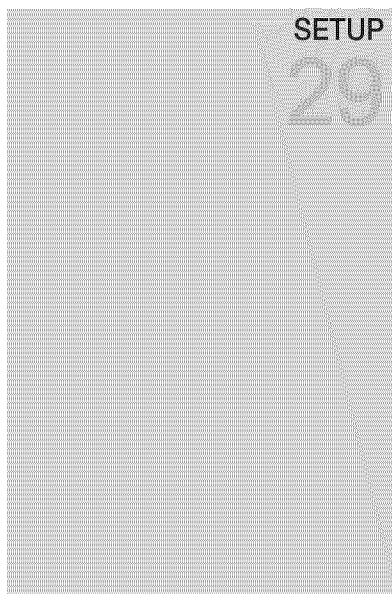
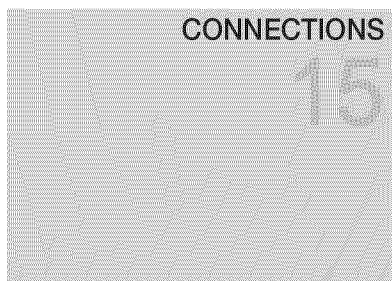

2	Safety Warnings
3	Important Safety Instructions
4	Precautions
7	Key features of your new AV Receiver
8	Accessories
9	Description
9	Front Panel
10	Display
11	Rear Panel
12	Remote Control
15	Speaker Positioning
17	Connecting the Speakers
19	Connecting External Devices/your TV via HDMI
20	HDMI Function
21	Connecting to your TV
22	Connecting a DVD or BD(Blu-ray) Player
23	Connecting a Cable, Satellite or Set-top Box
24	Connecting a CD Player
25	Connecting Using the External Amplifier
26	Connecting an iPod
28	Connecting the FM Antenna
28	Connecting AUX Components
29	Before Using the AV Receiver
29	Home Menu
30	Selecting Digital/HDMI/Analog
31	Setup Menu Tree
34	Audio Setup
34	Selecting a Source Device And Connection Jack (Digital Audio In)
34	Setting the Speaker Size
36	Connection Setting For Surround Back
37	Setting the Speaker Listening Distance
38	Setting the Speaker Level
39	Setting the Test Tone
40	Setting Dolby Pro Logic Mode
40	Surround Setup
40	Setting Dolby Pro Logic IIx
41	Setting NEO:6 Mode
41	Setting EX/ES Mode
42	Other Settings
42	Audio Sync
42	Tone Control
43	MP3 Enhancer
43	Smart Volume
44	Auto Calibration Setup
45	DRC Setup
45	Dual Mono Setup
46	HDMI Setup

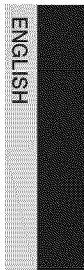

# Contents

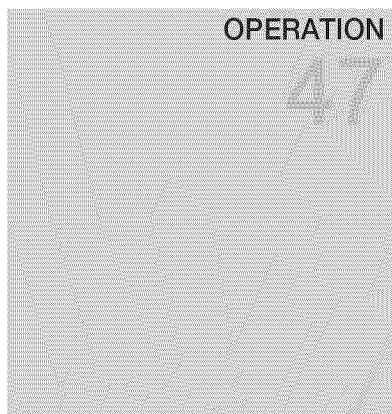

- 47 Using the Surround Modes
- 47 Using the AUDIO EFFECT Button On the Front of the Main Unit
- 48 Using the S.DIRECT Button
- 49 Using the SUBWOOFER button
- 49 Listening to the Radio
  - 50 To Listen in Mono/Stereo
  - 50 Presetting Radio Stations
- 51 Using an iPod
  - 51 Listening to Music (iPod audio function)
  - 51 Watching a Movie (iPod video function)
- 52 Convenient Functions
  - 52 Sleep Timer Function
  - 53 Mute Function
  - 53 Adjust the Display
  - 53 Reset Function
  - 54 Using Headphones
  - 54 Software Upgrade



- 55 Operating your TV with the Remote Control
- 56 Operating your DVD or BD Player with the Remote Control



- 57 Troubleshooting
- 58 Product Protection Function
- 58 Auto Calibration Error List
- 59 Specifications

- Figures and illustrations in this User Manual are provided for reference only and may differ from actual product appearance.

# Getting Started

## Key features of your new AV Receiver

### Product Features

#### Digital AV Receiver

This product is a pure digital AV receiver that performs digital signal processing to minimize signal distortion and loss.

#### Dolby Digital

Effective audio encoding/decoding technology that provides a vivid surround sound in up to 5.1 channels.

#### Dolby Pro Logic IIx

Dolby Pro Logic IIx is a new technology that provides discrete 7.1 channels out of 2 channel or multi channel sources. It also provides Music, Movie and Game modes.

Dolby Pro Logic IIx is an improved surround system that is optimized to a 7.1 CH multimedia system, enabling you to maximize your entertainment experience.

#### Dolby Pro Logic IIz

Dolby Pro Logic IIz adds front height channels to surround sound, creating a 7.1 playback system for video games, home music, and movies; bringing enhanced spatial effects and enveloping sound.

#### Dolby Digital EX

Adds a surround back channel for more spacious sound compared to regular 5.1 channel Dolby Digital.

#### Dolby Digital Plus

Dolby Digital Plus is the next-generation audio technology for all high-definition programming and media.

#### Dolby True-HD

Dolby True-HD is Dolby's next-generation lossless technology developed for high-definition disc-based media.

#### DTS 96/24

DTS 96/24 encodes standard 16 bit/44.1 kHz sound to 24 bit/96kHz and applies it to a 5.1 CH sound track.



#### DTS (Digital Theater Systems)

DTS provides a discrete 5.1 CH digital audio signal for both music and movie contents and uses less compression than Dolby Digital for richer sound.

#### DTS-HD (Master Audio, High Resolution) (Digital Theater Systems - High Definition)

DTS-HD Audio provides the highest quality multi-channel sound possible.

It delivers sound quality that matches the clear and vivid images of high-definition video.

#### DTS NEO:6

Provides a full range of 6 channels by converting a digital PCM or analog stereo signal using DTS digital matrix decoding.

# Getting Started

## DTS-ES (Extended Surround)

The DTS-ES (Extended Surround) system is a new multi digital signal format that was developed by Digital Theater Systems Inc.



Supporting full compatibility with the conventional DTS digital surround sound format, the DTS-ES (Extended Surround) system improves the surround signal for a 360-degree surround effect. DTS-ES adds an additional rear center surround channel for 6.1 channel sound.

## iPod

You can enjoy music files by connecting your iPod/iPhone to the AV Receiver with the supplied iPod dock.



## SFE (Sound Field Effect) Using 32bit Audio Digital Signal Processing

Provides more realistic surround sound with normal stereo audio sources.

## Anynet+ (HDMI-CEC) Function

Anynet+ is a function that can be used to operate this AV Receiver with a Samsung TV remote control, by connecting the receiver to a SAMSUNG TV using an HDMI Cable. (This function is available only in connection with Samsung TV and DVD player supporting Anynet+(HDMI-CEC).)

## Accessories

Check the box for the supplied accessories listed below.

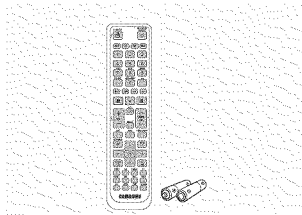

Remote Control (AH59-02370A)/  
Batteries (AAA size) (4301-000116)

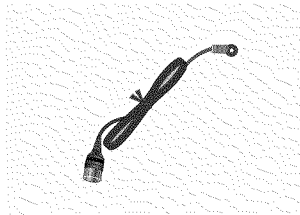

FM antenna (AH42-00017A)

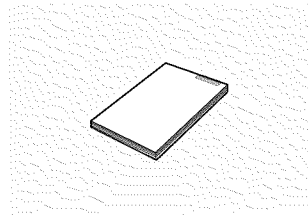

User's manual (AH68-02354X)

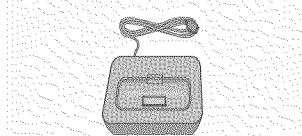

iPod Dock (AH96-00051A)

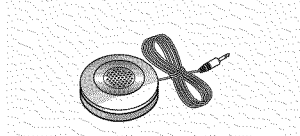

ASC microphone (AH30-00099A)

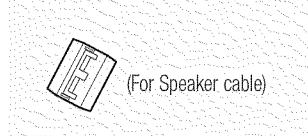

(For Speaker cable)

Toroidal Ferrite Core (3301-000144)



## Description

## Front Panel

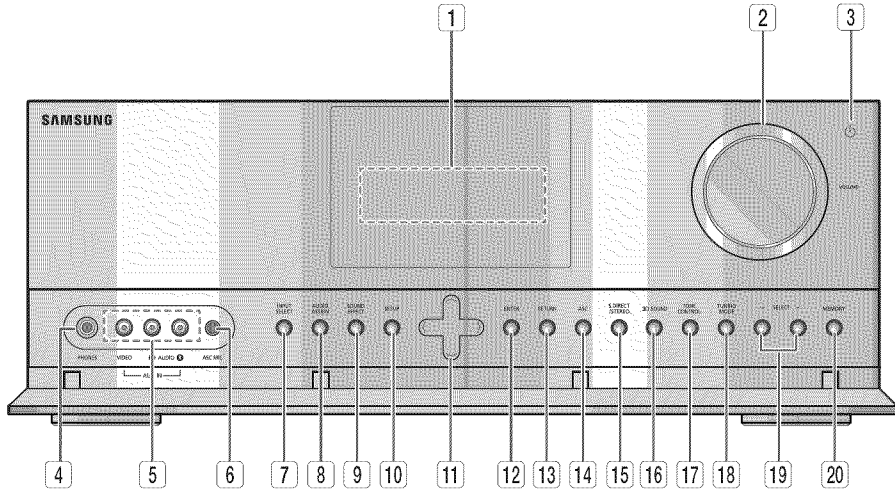

- |           |                                                  |                                                                                                                                                 |
|-----------|--------------------------------------------------|-------------------------------------------------------------------------------------------------------------------------------------------------|
| <b>1</b>  | <b>DISPLAY</b>                                   | Displays the speaker/audio input status, listening mode, etc.                                                                                   |
| <b>2</b>  | <b>VOLUME CONTROL</b>                            | Adjusts the volume level.                                                                                                                       |
| <b>3</b>  | <b>POWER BUTTON (⏻)</b>                          | Turns the receiver on/off.                                                                                                                      |
| <b>4</b>  | <b>PHONES JACK</b>                               | Used to connect a set of headphones.                                                                                                            |
| <b>5</b>  | <b>AUX IN JACKS</b>                              | Auxiliary AV input terminals used to connect a camcorder, portable DVD player or gaming device.                                                 |
| <b>6</b>  | <b>ASC MIC JACK</b>                              | Used to connect the ASC MIC for setting up Auto calibration.                                                                                    |
| <b>7</b>  | <b>INPUT SELECT BUTTON</b>                       | Used to select a source.<br>FM → TV → BD/DVD → SAT → GAME → AUX → CD → IPOD AUDIO → IPOD VIDEO                                                  |
| <b>8</b>  | <b>AUDIO ASSIGN BUTTON</b>                       | Toggles to select an input mode for the selected source.                                                                                        |
| <b>9</b>  | <b>SOUND EFFECT BUTTON</b>                       | Toggles to select a surround sound mode.                                                                                                        |
| <b>10</b> | <b>SETUP BUTTON</b>                              | Displays the SETUP menu.                                                                                                                        |
| <b>11</b> | <b>UP(↑), DOWN(↓), LEFT(←), RIGHT(→) BUTTONS</b> | Used to move the cursor up, down, left or right.<br>Also used to select detailed options in the SOUND EFFECT mode and to change the tone level. |
| <b>12</b> | <b>ENTER BUTTON</b>                              | Used to select an item in the SETUP menu.                                                                                                       |

# Getting Started

<b>13</b>	<b>RETURN BUTTON</b>	Return to the previous menu.
<b>14</b>	<b>ASC BUTTON</b>	Used to select the auto calibration mode.
<b>15</b>	<b>S.DIRECT / STEREO BUTTON</b>	Used to select the S.DIRECT or STEREO mode. (Output the original signal as it is without applying the sound field effect or any other sound effect.)
<b>16</b>	<b>3D SOUND BUTTON</b>	Press to apply 3D Sound effect.
<b>17</b>	<b>TONE CONTROL BUTTON</b>	Used to set the bass, treble level and tone to on/off.
<b>18</b>	<b>TUNING MODE BUTTON</b>	Used to select the Manual or Preset mode for FM radio.
<b>19</b>	<b>SELECT BUTTON</b>	Used to change the radio frequency.
<b>20</b>	<b>MEMORY BUTTON</b>	Used to set a preset radio frequency.

## Display

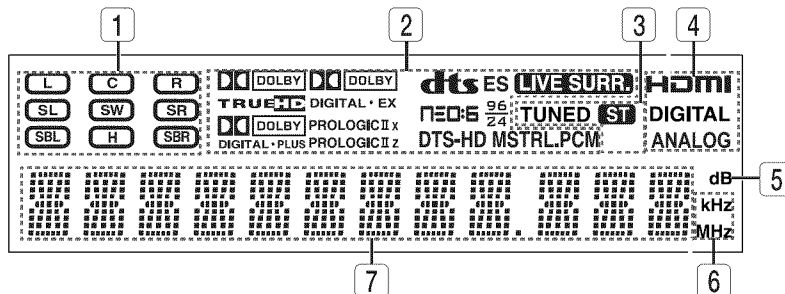

<b>1</b>	<b>SPEAKER INDICATORS</b>	Displays sound producing speakers.
<b>2</b>	<b>LISTENING MODE INDICATORS</b>	Displays the current listening mode and audio source.
<b>3</b>	<b>TUNING INDICATORS</b>	Displays the status of the current radio broadcast.
<b>4</b>	<b>AUDIO INPUT INDICATORS</b>	Displays the audio input signal type of the currently connected external audio source.
<b>5</b>	<b>SPEAKER LEVEL INDICATOR</b>	Displays the speaker level.
<b>6</b>	<b>RADIO FREQUENCY INDICATORS</b>	Displays the current radio frequency range.
<b>7</b>	<b>MESSAGE DISPLAY</b>	Informs you of the status of the receiver.

## Rear Panel

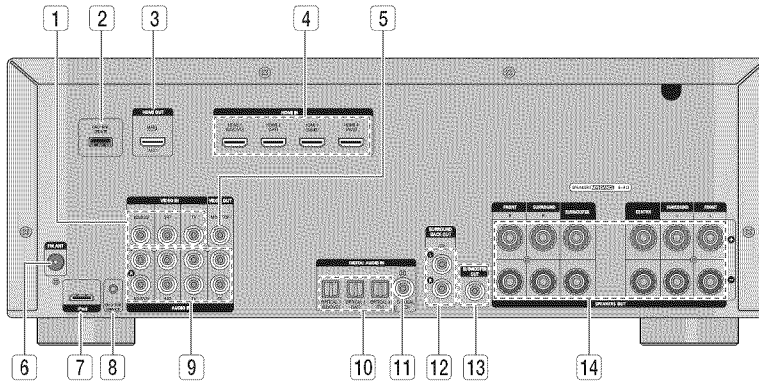

- |           |                                            |                                                                              |
|-----------|--------------------------------------------|------------------------------------------------------------------------------|
| <b>1</b>  | <b>VIDEO IN JACKS</b>                      | Receives the video signal from a video player (BD/DVD, SAT, TV).             |
| <b>2</b>  | <b>USB PORT</b>                            | Can be only used for firmware upgrades.                                      |
| <b>3</b>  | <b>HDMI OUT JACK</b>                       | Outputs digital video and audio signals simultaneously using an HDMI cable.  |
| <b>4</b>  | <b>HDMI IN JACKS</b>                       | Receives digital video and audio signals simultaneously using an HDMI cable. |
| <b>5</b>  | <b>VIDEO OUT JACK</b>                      | Outputs the video signal to a monitors (TV, Projector etc).                  |
| <b>6</b>  | <b>FM ANTENNA JACK</b>                     | Connect the FM antenna.                                                      |
| <b>7</b>  | <b>iPod JACK</b>                           | Receives the audio/video signal from an iPod.                                |
| <b>8</b>  | <b>ONLY FOR SERVICE JACK</b>               | Used for the service repair.                                                 |
| <b>9</b>  | <b>AUDIO IN JACKS</b>                      | Receives the audio signal from a video player (BD/DVD, SAT, TV).             |
| <b>10</b> | <b>OPTICAL IN JACKS (DIGITAL AUDIO IN)</b> | Receives the digital optical audio signal.                                   |
| <b>11</b> | <b>COAXIAL IN JACK (DIGITAL AUDIO IN)</b>  | Receives the digital coaxial audio signal.                                   |
| <b>12</b> | <b>SURROUND BACK OUT JACKS</b>             | Outputs the "Surround Back" analog signal to the external amplifier.         |
| <b>13</b> | <b>SUBWOOFER AUDIO OUT JACK</b>            | Connect the subwoofers. (Active subwoofer only)                              |
| <b>14</b> | <b>SPEAKERS OUT TERMINALS</b>              | Speaker connection terminals.                                                |

# Getting Started

## Remote Control

### Tour of the Remote Control

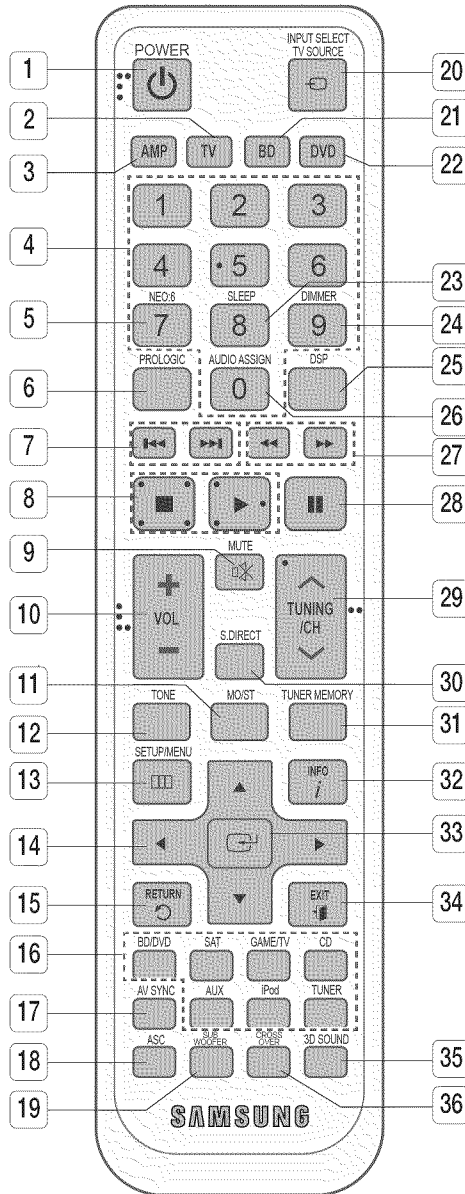

<b>1</b>	<b>POWER BUTTON</b>	Turns the receiver on/off.
<b>2</b>	<b>TV BUTTON</b>	To change to TV mode, press the TV button.
<b>3</b>	<b>AMP BUTTON</b>	To change to AMP mode, press the AMP button.
<b>4</b>	<b>NUMBER BUTTONS</b>	Used to select a TV channel.
<b>5</b>	<b>NEO : 6 BUTTON</b>	Select the desired NEO:6 mode.
<b>6</b>	<b>PROLOGIC BUTTON</b>	Select the desired Dolby Pro Logic audio mode.
<b>7</b>	<b>SKIP BUTTONS</b>	Press to skip backwards or forwards on a connected DVD/BD player or iPod.
<b>8</b>	<b>STOP/PLAY BUTTON</b>	Press to stop/start playback on a connected DVD/BD player or iPod.
<b>9</b>	<b>MUTE BUTTON</b>	Mutes the sound of a connected device.
<b>10</b>	<b>VOLUME CONTROL BUTTONS</b>	Adjusts the volume of the selected device.
<b>11</b>	<b>MO/ST BUTTON</b>	Select MONO or STEREO for radio broadcasts.
<b>12</b>	<b>TONE BUTTON</b>	You can adjust the bass and treble level.
<b>13</b>	<b>SETUP/MENU BUTTON</b>	Displays the SETUP menu.
<b>14</b>	<b>UP/DOWN/LEFT/RIGHT BUTTONS</b>	Used to navigate the menus.
<b>15</b>	<b>RETURN BUTTON</b>	Used to return to the previous menu from the SETUP menu.
<b>16</b>	<b>FUNCTION SELECTOR BUTTONS</b>	Used to select an input source.
<b>17</b>	<b>AV SYNC BUTTON</b>	Used to select the Audio Delay Mode.
<b>18</b>	<b>ASC BUTTON</b>	Used to set the Auto Sound Calibration function.
<b>19</b>	<b>SUBWOOFER BUTTON</b>	Used to select the Subwoofer.
<b>20</b>	<b>INPUT SELECT, TV SOURCE BUTTON</b>	Toggles to find and select an input source. Press to select a connected TV's video source.
<b>21</b>	<b>BD BUTTON</b>	To change to BD mode, press the BD button.
<b>22</b>	<b>DVD BUTTON</b>	To change to DVD mode, press the DVD button.
<b>23</b>	<b>SLEEP BUTTON</b>	Used to set the Sleep Timer.
<b>24</b>	<b>DIMMER BUTTON</b>	Adjusts the brightness of the display.
<b>25</b>	<b>DSP BUTTON</b>	Used to select the SFE mode.
<b>26</b>	<b>AUDIO ASSIGN BUTTON</b>	Toggles to select an input mode for the selected source.

# Getting Started

27	SEARCH BUTTON	Press to search backwards or forwards.
28	PAUSE BUTTON	Pauses playback on a connected device.
29	TUNING/CHANNEL BUTTONS	Used to change the radio broadcasting frequency or TV channel.
30	S.DIRECT BUTTON	Press to select S.DIRECT mode.
31	TUNER MEMORY BUTTON	Used to set a preset radio frequency.
32	INFO BUTTON	Display information on the connected device currently being used.
33	ENTER BUTTON	Used to select an item in the SETUP menu.
34	EXIT BUTTON	Exits the SETUP menu.
35	3D SOUND BUTTON	Press to apply 3D Sound effect.
36	CROSS OVER BUTTON	Press to adjust the crossover frequency.

## Installing batteries in the Remote Control

### NOTE

Follow these precautions to avoid leaking or cracking cells:

- Place batteries in the remote control so they match the polarity : (+) to (+) and (-) to (-).
- Assuming typical AVR usage, the batteries last for about one year.
- Use the correct type of batteries. Batteries that look similar may differ in voltage.
- Always replace both batteries at the same time.
- Do not expose the batteries to heat or a flame.

\* Battery size: AAA

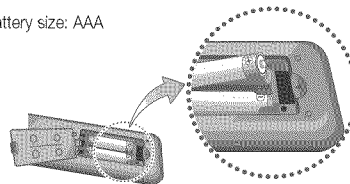

## Operation Range of the Remote Control

The remote control can be used up to approximately 23 feet/7 meters in a straight line. It can also be operated at a horizontal angle of up to 30° from the remote control sensor.

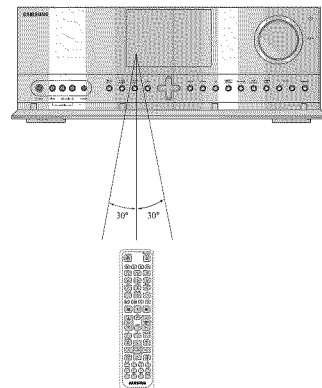

# Connections

This section involves various methods of connecting the AV receiver to other external components. Before moving or installing the product, be sure to turn off the power and disconnect the power cord.

## Speaker Positioning

\* Speakers are provided with model HW-D650S only. Model HW-D600 does not come with speakers.

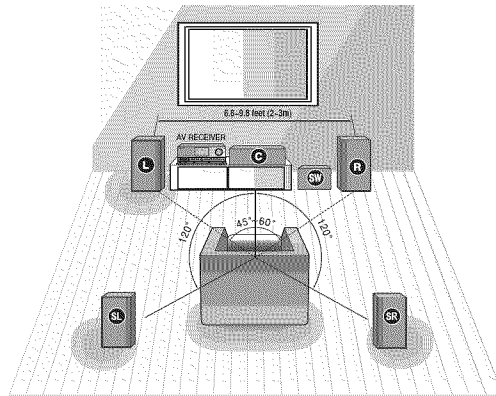

### Position of AV Receiver

Place the AV Receiver on a dedicated stand or rack.

### Subwoofer **SW**

The position of the subwoofer is not so critical. Place it anywhere you like.

### Front Speakers **L R**

Place these speakers in front of your listening position, facing inwards (about 45°) toward you.

Place the speakers so that their tweeters will be at the same height as your ears.

Align the front face of the front speakers with the front face of the center speaker or place them slightly in front of the center speaker.

### Center Speaker **C**

It is best to install it at the same height as the front speakers.

You can also install it directly over or under the TV.

### Surround Speakers **SL SR**

Place these speakers behind your listening position.

If there isn't enough room, place these speakers so they face each other.

Place them about 2 to 3 feet (60 to 90cm) above your ears, facing slightly downward.

Unlike the front and center speakers, the surround speakers are used to handle mainly sound effects and sound will not come from them all the time.

# Connections

## Surround Back Speakers **SBL** **SBR** (Option)

If you are using two rear center speakers, place them behind the listening position. Place the surround back speaker about 2.3-3.3 feet (70 cm to 1 m).

## Front Height Speakers **FHL** **FHR** (Option)

When using Dolby Pro Logic IIz, place the Surround Back Speakers on the FHL, FHR position above the front L and front R speakers at least 3.3 feet(1 m) above each one.

### NOTE

- When you attach the speakers to the wall, make sure to fasten them tightly so they do not fall off.

## Speaker Configuration

For the best surround-sound experience, you should connect five speakers and a subwoofer. The following table shows which channels you should use based on the number of speakers you have.

2 speakers	3 speakers	4 speakers	5 speakers	7 speakers (DPL IIx) (Option)	7 speakers (DPL IIz) (Option)
<b>L</b>	<b>L</b>	<b>L</b>	<b>L</b>	<b>L</b>	<b>L</b>
<b>R</b>	<b>R</b>	<b>R</b>	<b>R</b>	<b>R</b>	<b>R</b>
	<b>C</b>		<b>C</b>	<b>C</b>	<b>C</b>
		<b>SL</b>	<b>SL</b>	<b>SL</b>	<b>SL</b>
		<b>SR</b>	<b>SR</b>	<b>SR</b>	<b>SR</b>
				<b>SBL</b>	<b>FHL</b>
				<b>SBR</b>	<b>FHR</b>

### NOTE

- If you place a speaker near your TV set, screen color may be distorted because of the magnetic field generated by the speaker. If this occurs, place the speaker away from your TV set.
- If you have an external stereo Amplifier and two Speakers and connect them, you can constitute 7 speaker configuration.
- Also if you have an external active subwoofer, you can connect it.



## Connecting the Speakers

### Connecting Speaker Wire

1. Loosen the knob by turning counterclockwise.
2. Insert the bare part of the wire into the hole in the side of each terminal.
3. Tighten the knob by turning clockwise to secure the wire.

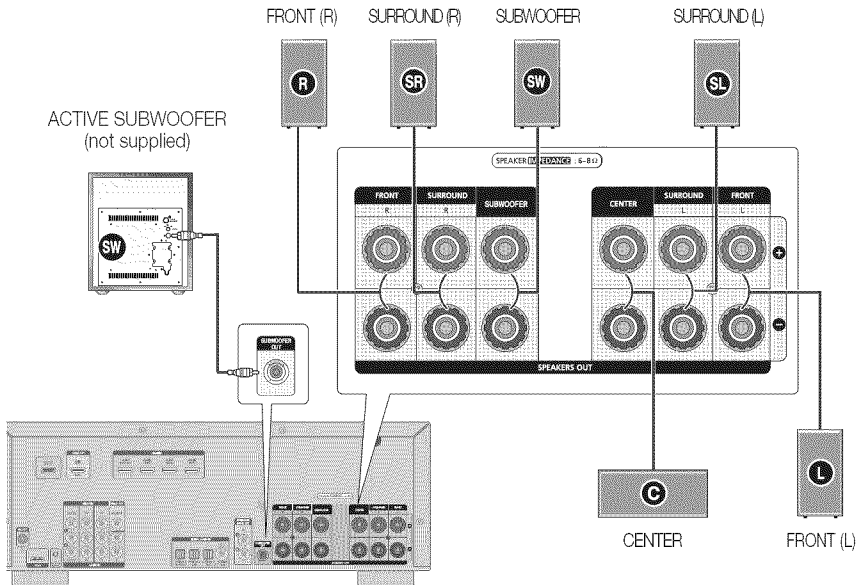
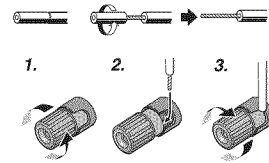

Model HW-D600	
AV Receiver	HW-D600
Model HW-D650S	
AV Receiver	HW-D600
FRONT SPEAKER	PS-FC560S
CENTER SPEAKER	PS-CC560S
SURROUND SPEAKER	PS-RC560S
SUBWOOFER SPEAKER	PS-WC560S

# Connections

## NOTE

- Speakers are provided with model HW-D650S only. Model HW-D600 does not come with speakers. Contact a Samsung Electronics retailer for purchasing.
- Keep the subwoofer speaker out of reach of children to prevent them from inserting their hands or objects into the duct (hole).
- Never touch speaker terminals while the power is on. Doing so could result in electric shock.
- Make sure the polarities (+ and -) are correct.
- If you want to use a active subwoofer speaker (not supplied), connect a subwoofer speaker into the SUBWOOFER OUT terminal in the rear panel.
- By using an external amplifier, you can connect the surround back speakers (SBL/SBR) or front height speakers(FHL/FHR) to improve your system up to a 7.1 channel system.

## Attaching the Toroidal Ferrite Core to the Speaker Cable

1. Open the toroidal ferrite cores by pulling the lock lever.
2. Arrange all the speaker cables that are connected to the unit and make a loop.
  - Attach the ferrite core as close as possible to the unit.
3. Place the toroidal ferrite core on the looped speaker cable as shown, and then press it closed until you hear a click.

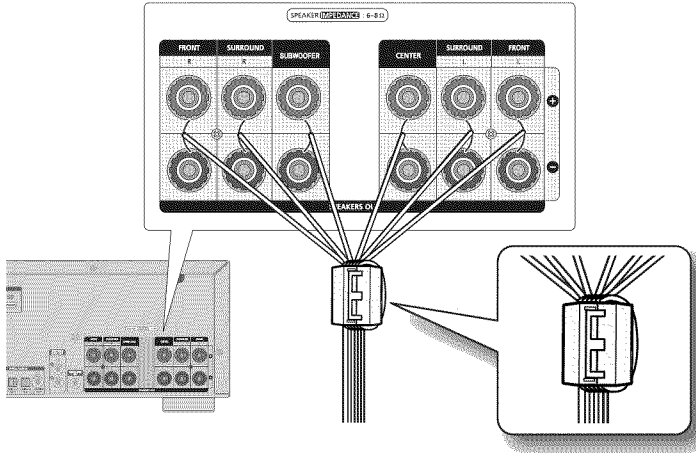

## Connecting External Devices/your TV via HDMI

HDMI is a digital standard interface for connection to such devices as a TV, projector, DVD player, Blu-ray player, set-top box and more.

HDMI removes any loss of signal from analog conversion, enabling you to enjoy video and audio sound quality as it was originally created in the digital source.

By connecting through the HDMI(High-Definition Multimedia Interface) interface, you can play back digital video and audio.

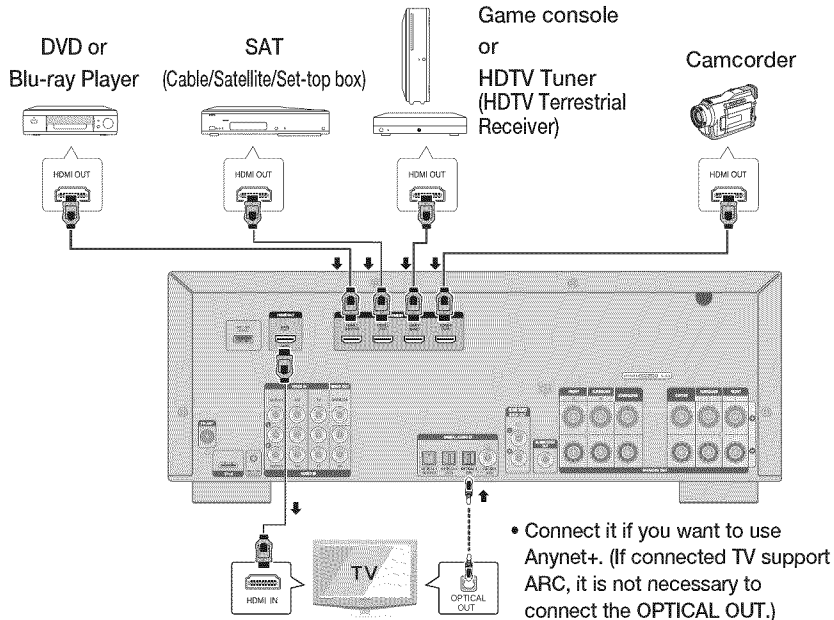

### High-bandwidth Digital Content Protection System (HDCP) support

To play digital contents through the HDMI connection, both the connected external device and TV must support High-bandwidth Digital Content Protection System (HDCP). This product supports HDCP.

Compatibility with a TV Supporting HDMI	
A TV with an HDMI jack.	Video/Audio
A TV with a DVI-D jack (TV supporting HDCP)	Video
A TV with a DVI-D jack (TV not supporting HDCP)	-

#### NOTE

- Audio from SACD discs will not be heard with this connection. To play a DVD disc whose copyright is protected by CPPM, use a player supporting CPPM.
- The quality of the audio output through the HDMI jack (sampling frequency and bit rate) may be limited by the performance of the connected device.
- Since HDMI connection supports both video and audio, you don't have to connect an additional audio cable.

### Using Anynet+ (HDMI-CEC)

Anynet+ is a function that enables you to control other Samsung Devices with your Samsung TV's remote control. Anynet+ can be used by connecting this AV Receiver to a SAMSUNG TV using an HDMI Cable. This is only available with SAMSUNG TVs and SAMSUNG AV Products that support Anynet+.

1. Connect the AV receiver to a Samsung TV with an HDMI cable. (See page 19)
2. Set the Anynet+ function on your TV.  
(See the TV instructions manual for more information.)
  - You can operate the volume on the AV receiver by using Volume buttons on the TV remote control.

### To Turn on Anynet+

1. Press the **SETUP/MENU** button on the remote control.
  - Each time the button is pressed, the mode switches between **INPUT** and **SETUP OFF**.
2. Press the **▲▼** buttons to select **OPTION**, and then press the **ENTER** button.
3. Press the **▲▼** buttons to select **HDMI SETUP**, and then press the **ENTER** button.
4. Press the **▲▼** buttons to select **HDMI ANYNET+**, and then press the **ENTER** button.
5. Press the **▲▼** buttons to set **ANYNET+** to **ON**, and then press the **ENTER** button.

### To exit setup mode

- Press the **SETUP/MENU** or **EXIT** button on the remote control.  
**SETUP OFF** appears on the display and Setup Mode is exited.



#### NOTE

- If you use an HDMI cable to connect a Samsung TV to your AV Receiver, you can operate the AV receiver using the TV's remote control. This function is available only in connection with Samsung TV and DVD player supporting Anynet+ (HDMI-CEC).
- Please check your TV for the **ANYNET+** logo. If your TV has an **ANYNET+** logo, then it supports the Anynet+ function.
- When you are making Anynet+ connection, do not connect more than two AV receivers (Anynet+ installed). Otherwise, it can cause a malfunction.

## Connecting to your TV

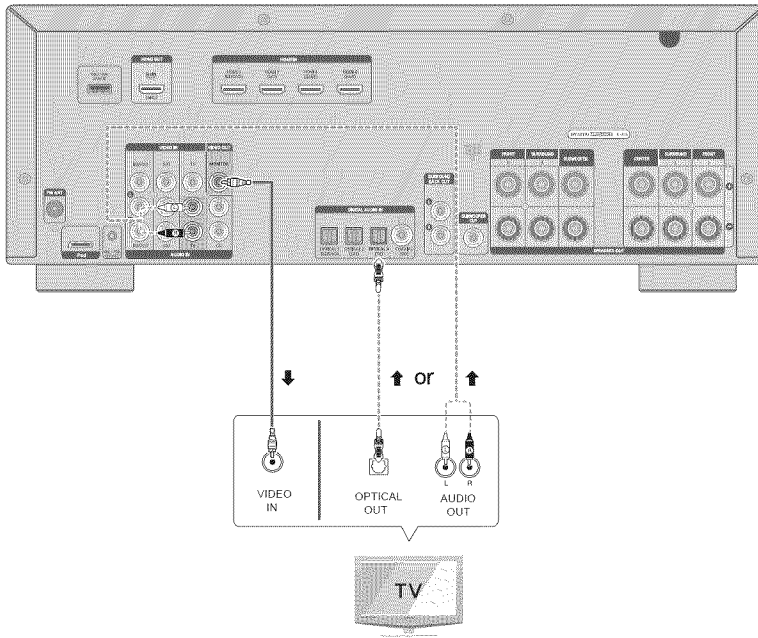

### Video Connection

Connect the Video cable (not supplied) from the VIDEO OUT (MONITOR) jack on the back of your AV Receiver to the Video Input jack on your TV.

### Audio Connection

Connect the Digital Input (OPTICAL 3) on your AV Receiver to the Digital Output of the TV.

OR

Connect AUDIO IN (TV) on your AV Receiver to the Audio Out of the TV.

# Connections

## Connecting a DVD or BD(Blu-ray) Player

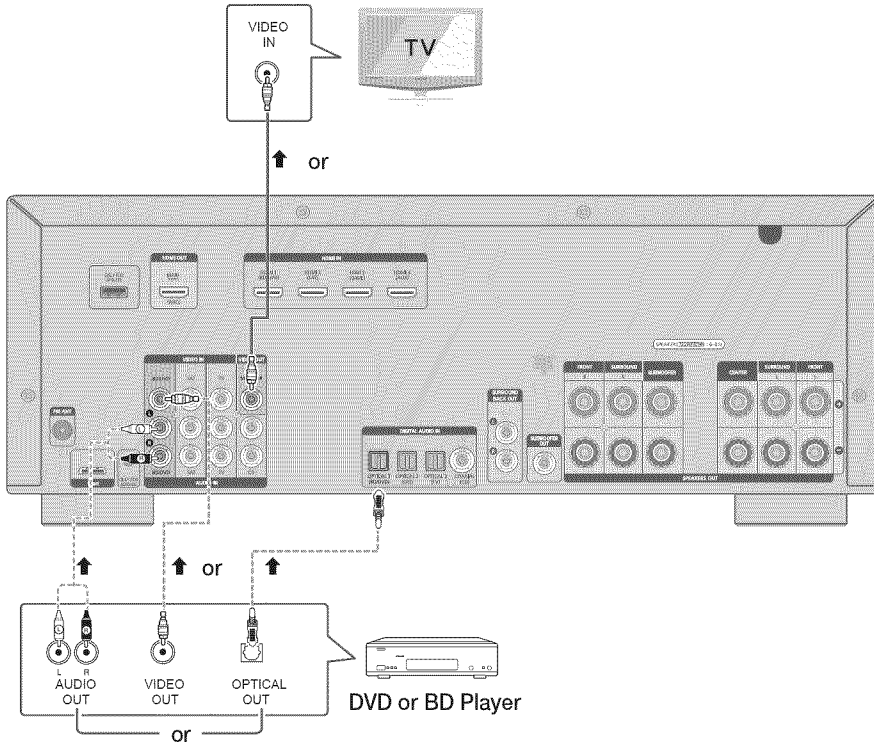

### Video Connection

Connect a Video cable (not supplied) from the VIDEO IN (BD/DVD) jack on the back of your AV Receiver to the Video Output jack on your DVD/BD player.

### Audio Connection

Connect the Digital Input (OPTICAL 1) on your AV Receiver to the Digital Output of the DVD/BD player.

**OR**

Connect AUDIO IN (BD/DVD) on your AV Receiver to the Audio Out of the DVD/BD player.

## Connecting a Cable, Satellite or Set-top Box

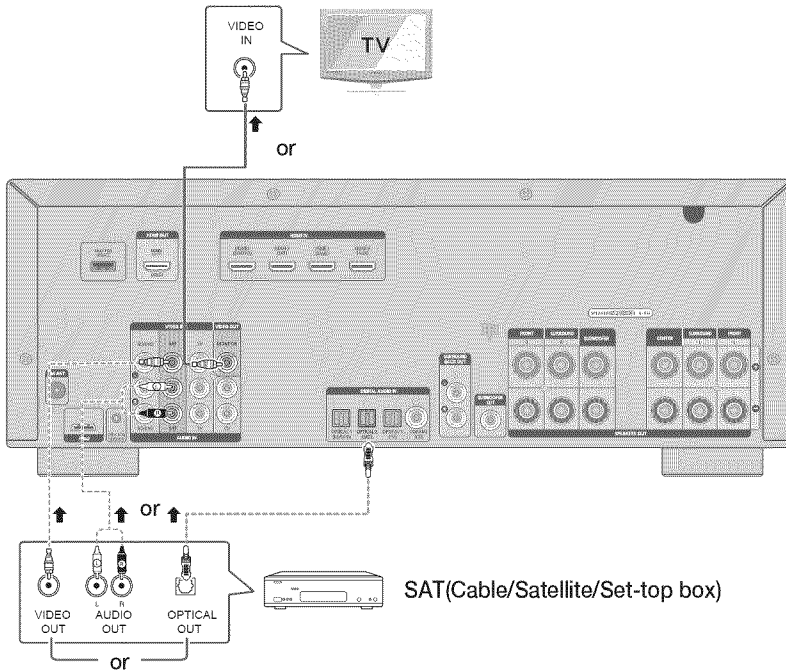

### Video Connection

Connect a Video cable (not supplied) from the VIDEO IN (SAT) jack on the back of your AV Receiver to the Video Output jack on your SAT.

### Audio Connection

Connect the Digital Input (OPTICAL 2) on your AV Receiver to the Digital Output of the SAT.

OR

Connect AUDIO IN (SAT) on your AV Receiver to the Audio Out of the SAT.

### NOTE

- ※ Disconnect the power plug from the outlet if you will not use this unit for a long period of time.
- ※ If the cable/set-top box has only one audio output jack, connect it to either the right or left audio input jack of the main unit. Connect the audio cable's red plug to the red jack and white cable to the white jack.

# Connections

## Connecting a CD Player

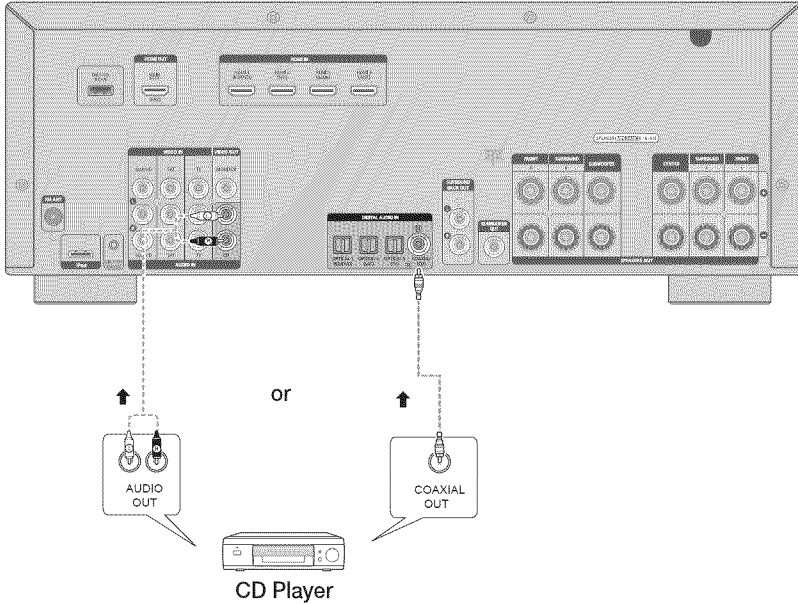

### Audio Connection

Connect the Digital Input (COAXIAL) on your AV Receiver to the Digital Output of the CD Player.

**OR**

Connect AUDIO IN (CD) on your AV Receiver to the Audio Out of the CD player.

#### **NOTE**

- Connect the audio cable's red plug to the red jack and white cable to the white jack.
- If the CD player has only one audio output jack, connect it to either the right or left audio input jack of the main unit.



## Connecting Using the External Amplifier

By factory default, the AV receiver is designed as 5.1 CH surround sound system. However, it can be extended to 7.1CH surround sound system in combination with a separate amplifier and additional speakers as shown below:

- Use an RCA audio cable to connect the AV receiver's SURROUND BACK OUT L/R jacks to an analog audio input on your external amplifier for SURROUND BACK or FRONT HEIGHT.
- Connect your SURROUND BACK Speakers or Front HEIGHT Speakers to the speaker terminals on your external amplifier.
- 7.1 channel settings using an external amplifier.

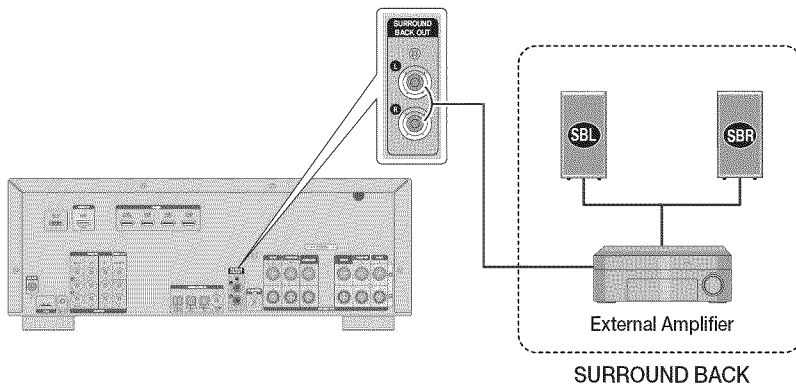
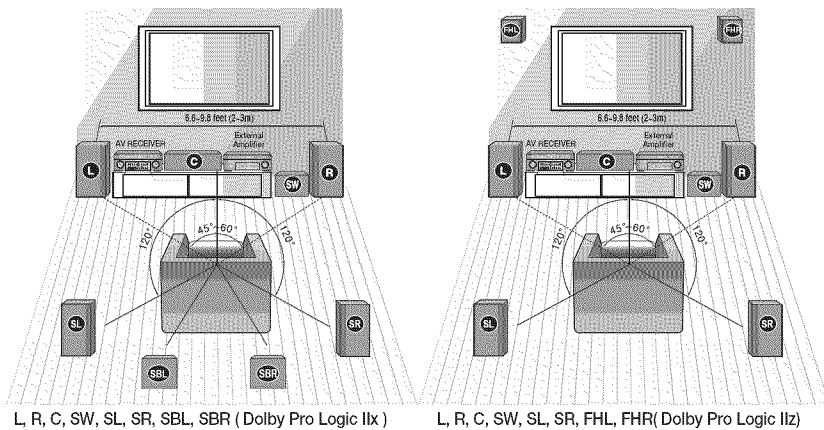

### NOTE

- Surround Back Out only outputs analog signal.
- AV Receiver's SURROUND BACK OUT provides the Volume Control.
- The external amplifier with volume control and without volume control can be used.
- When you use the external amplifier with volume control, external amplifier's volume should be adjusted to a suitable position.
- The volume control for the 7.1 channel can be controlled in this AV receiver.

# Connections

## Connecting an iPod

You can listen to audio from an iPod through the main unit. For iPod operation with your receiver, see this page and pages 51 ~ 52.

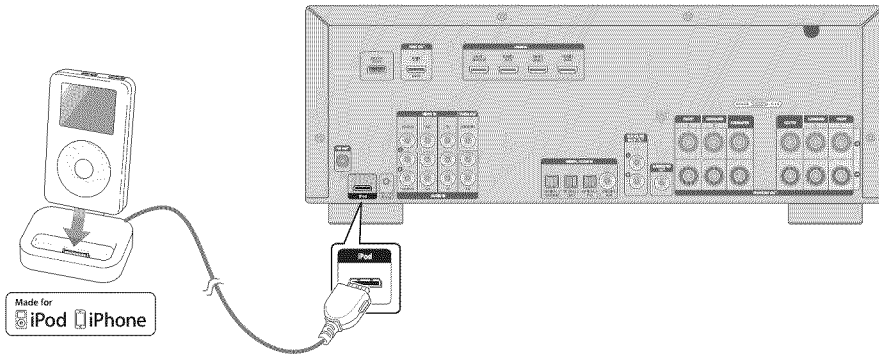

1. Connect the iPod dock connector to the iPod jack on your receiver.
2. Place the iPod in the Dock.
  - If you want to play a movie stored in your iPod player, you should set the player's **TV Out** option to **On** before inserting it into the dock. See pages 51 ~ 52.
3. Press the **iPod** button on the remote control.
  - You can also use the **INPUT SELECT** on the main unit.  
The mode switches as follows :  
**FM → TV → BD/DVD → SAT → GAME → AUX → CD → IPOD AUDIO → IPOD VIDEO**

### NOTE

- You must have the VIDEO (Monitor or TV) output connected to your TV to view iPod video. See page 21.
- Adjust the volume to a moderate level before you connect your iPod and AV Receiver.
- When the unit is powered on and you connect an iPod, the unit will charge your iPod's battery.
- Make sure to connect the dock connector so that the label "**SAMSUNG**" faces upward.

## Disconnecting an iPod

Follow the steps below to prevent damage to an iPod and data when disconnecting from your AV receiver.

1. Use the **INPUT SELECT** on the main unit to switch to a mode other than **IPOD AUDIO** or **IPOD VIDEO**.

OR

1. Turn off the AV Receiver.
2. Disconnect the iPod player from the iPod dock, or remove the iPod dock connector from the AV receiver.

## iPod/iPhone Models You Can Use with This Product

- iPod touch (3rd generation)
- iPod touch (2nd generation)
- iPod touch (1st generation)
- iPod classic
- iPod with video
- iPod with dock connector
- iPod with Click Wheel
- iPod nano (5th generation)
- iPod nano (4th generation)
- iPod nano (3rd generation)
- iPod nano (2nd generation)
- iPod nano (1st generation)
- iPhone 4
- iPhone 3GS
- iPhone 3G
- iPhone



### NOTE

- “Made for iPod” means that an electronic accessory has been designed to connect specifically to iPods and has been certified by the developer to meet Apple performance standards.
- “Made for iPhone” means that an electronic accessory has been designed to connect specifically to iPhones and has been certified by the developer to meet Apple performance standards.
- Apple is not responsible for the operation of this device or its compliance with safety and regulatory standards.

**iPod** is a trademark of Apple Inc., registered in the U.S. and other countries.

**iPhone** is a trademark of Apple Inc.

# Connections

## Connecting the FM Antenna

1. Connect the FM antenna supplied to the FM ANTENNA terminal as a temporary measure.
2. Slowly move the antenna wire around until you find a location where reception is good, then fasten it to a wall or other rigid surface.

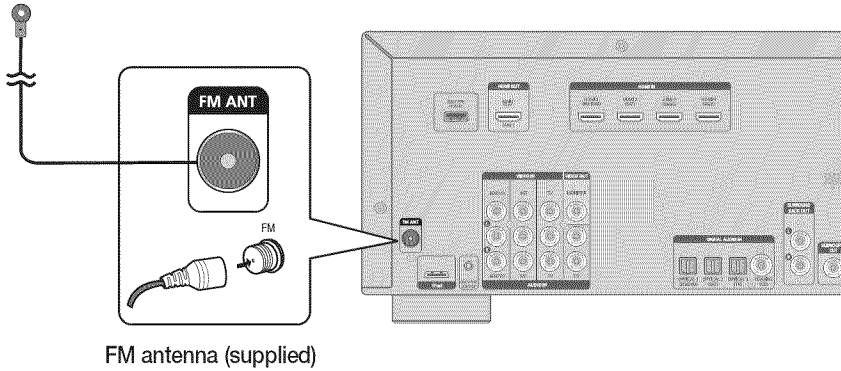

### NOTE

- Do not place the antenna cable close to the power cord. Keep it as far away as possible.
- If you experience poor FM reception, use an external antenna.

## Connecting AUX Components

You can connect external devices you use for a short time (camcorder, game console, mobile equipment, etc.) to the front of this unit for convenience.

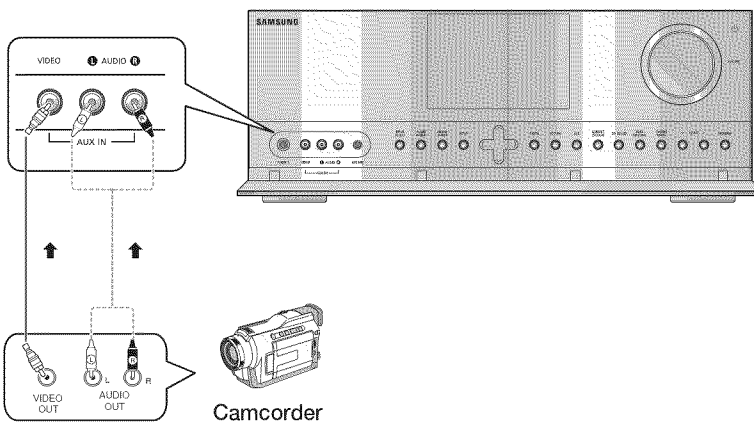

# Setup

For your convenience, you can set this AV receiver's features for the best use.

## Before Using the AV Receiver

### Turning On/Off

Connect the power plug to the outlet.  
This unit will set to Standby mode.

Press the **POWER** button on the main unit for 2 seconds.

- This unit will be turned on.
- You can also turn the unit on/off by pressing the **POWER** button on the remote control.

### Remote Control Functions

You can operate your AMP (this AV receiver)/ TV and BD(Samsung only)/DVD player with this remote control. See pages 55 ~ 56 for more details.

### To Select a Function

#### Method 1

Press the **INPUT SELECT** button on the remote control.

- Each time you press this button, **FM** → **TV** → **BD/DVD** → **SAT** → **GAME** → **AUX** → **CD** → **IPOD AUDIO** → **IPOD VIDEO** will be selected in turn.

#### Method 2

Press the **BD/DVD**, **SAT**, **GAME/TV**, **CD**, **iPod** or **TUNER** button.

- You can directly select the desired function.

## Home Menu

Use the HDMI cable to connect between main unit and monitor. Press **SETUP/MENU** to display the "INPUT" message on the display screen. You will see the OSD menu in a few seconds.

#### NOTE

- The OSD menu will be displayed only if you use the HDMI cable for the connection.
- For using the OSD menus, refer to using the menus on the display screen.
- The OSD (On Screen Display) may change in this product after you upgrade the software version.

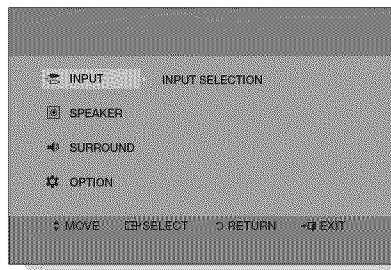

# Setup

## Selecting Digital/HDMI/Analog

You can listen to sound of analog, HDMI, optical input using this unit.

1. Press the **INPUT SELECT** button on the remote control to select a desired function (BD/DVD, SAT, TV, CD, AUX). See page 29.
2. Press the **AUDIO ASSIGN** button on the remote control to select the audio input source of the external device you have connected.
  - Each time you press this button, the input mode changes as follows:

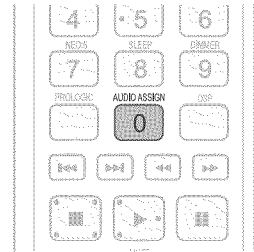

### • For BD/DVD function

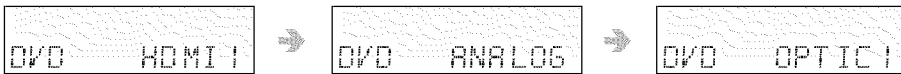

### • For SAT function



### • For TV function



### • For CD function



### • For AUX function



### NOTE

- You can also change the input mode by pressing the **AUDIO ASSIGN** button on the front of your AV Receiver.
- You can enjoy Dolby Digital or DTS if you connect the digital audio output jack of an external audio component to the optical or coaxial digital audio input jack on the main unit.
- For the TV function, the TV ARC menu will be displayed only if an ARC-compliant TV is connected.

## Setup Menu Tree

Here's a quick look at how the setup menus are organized on your AV Receiver.

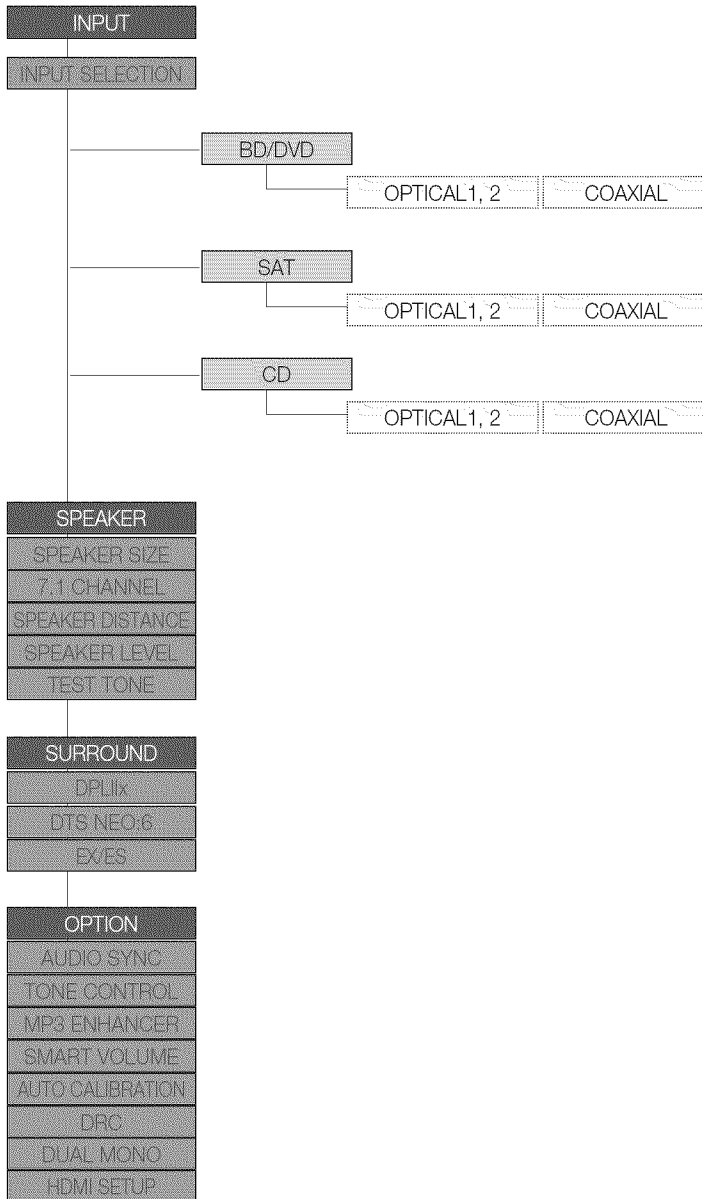

# Setup

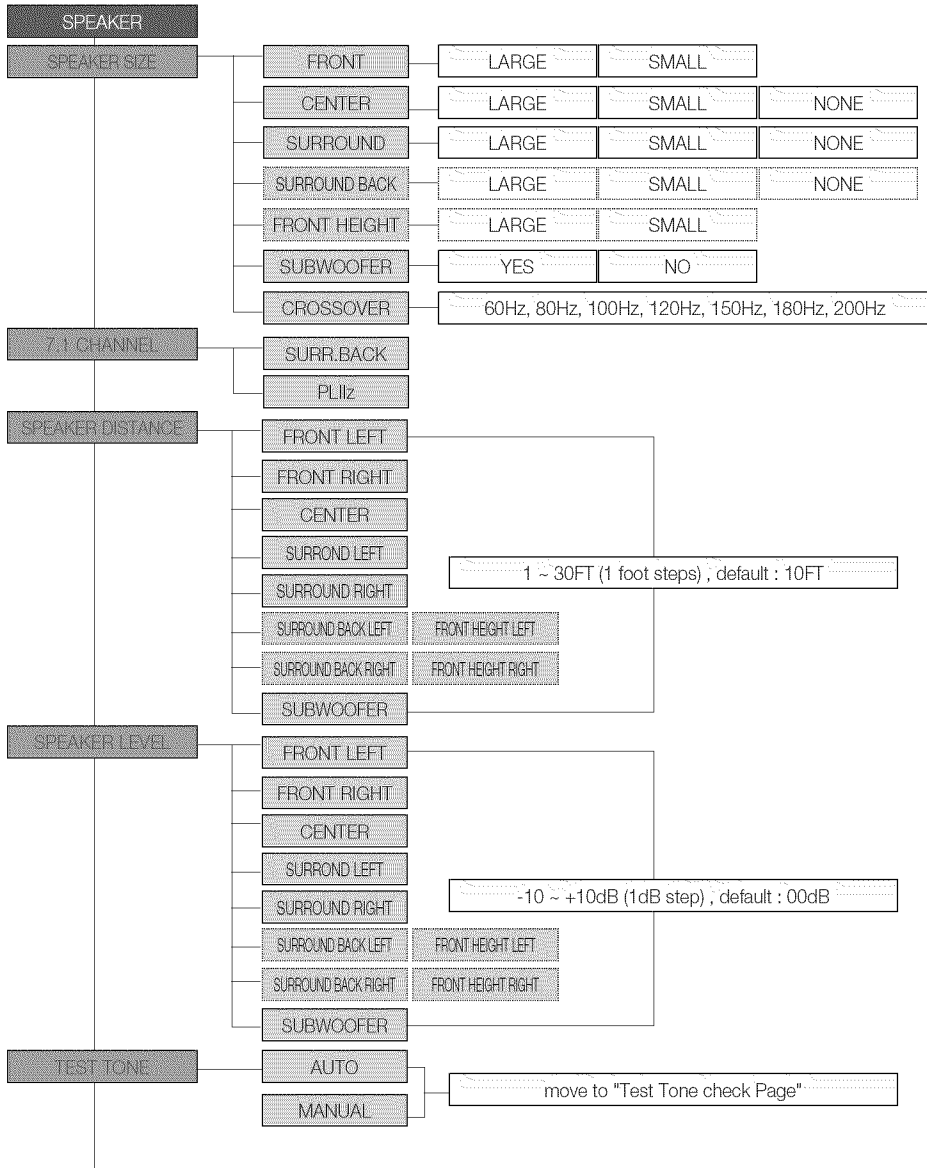

## NOTE

- If Dolby Pro Logic IIz is set to On, the Surround Back speaker (SBL/SBR) is changed to the Front Height Speaker (FHL/FHR).



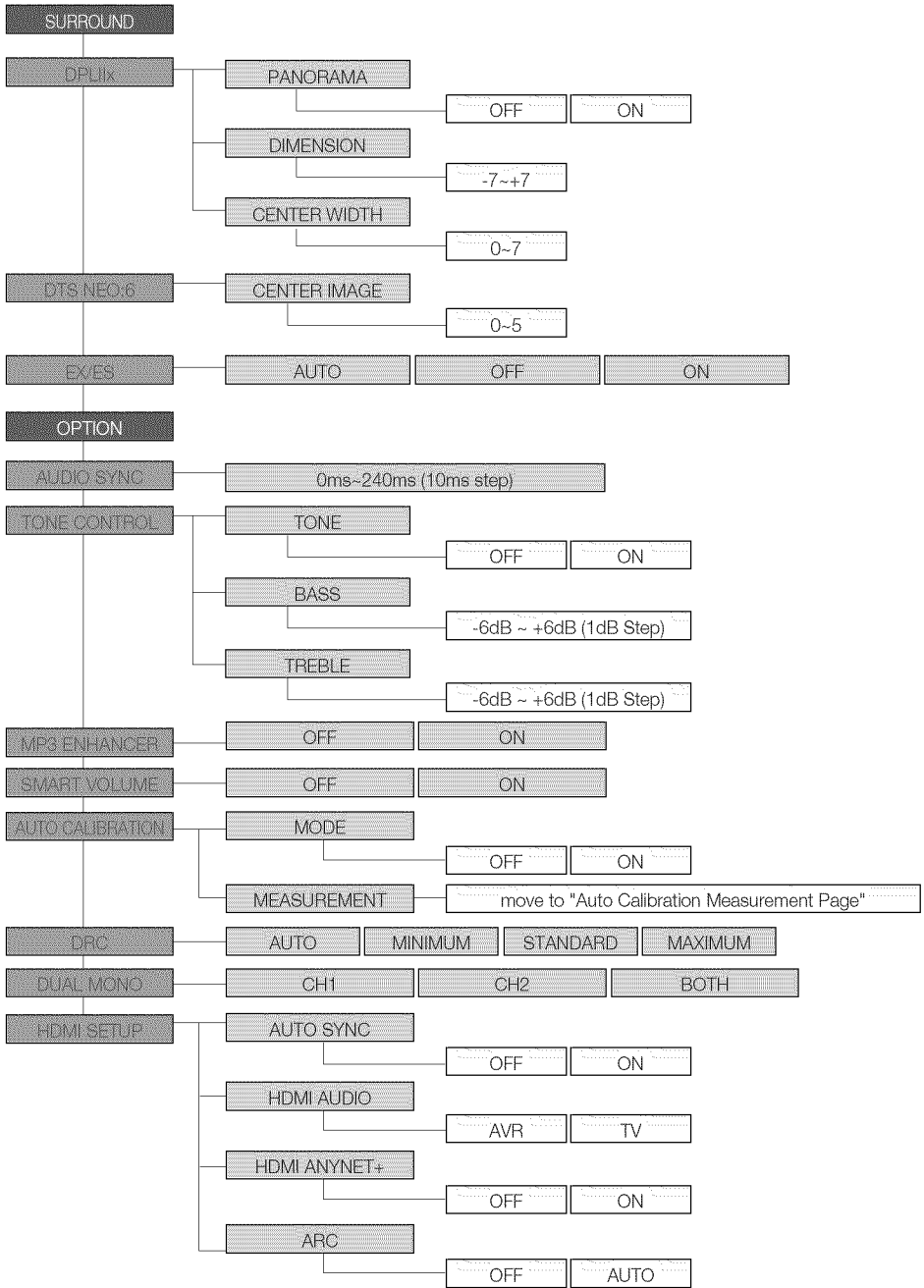

# Setup

## Audio Setup

### Selecting a Source Device And Connection Jack (Digital Audio In)

Select the external devices you have connected to the receiver.

1. Press the **SETUP/MENU** button on the remote control.
  - Each time the button is pressed, the mode switches between **INPUT** and **SETUP OFF**.
2. Press the **ENTER** button to select **INPUT**.
3. Press the **ENTER** button to select **INPUT SELECTION**.
4. Press the **▲▼** buttons to select a desired jack.
  - Devices switch as follows; BD/DVD, SAT, CD

#### NOTE

- You can also use the **SETUP**, **▲**, **▼**, **ENTER**, **RETURN** buttons on the front of your AV Receiver.

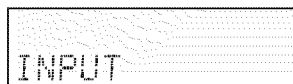

INPUT



INPUT SELECT



BD/DVD OPT 1

### Setting the Speaker Size

Signal outputs and frequency response from the speaker will be adjusted according to your speaker configuration and whether certain speakers are used or not.

1. Press the **SETUP/MENU** button on the remote control.
  - Each time the button is pressed, the mode switches between **INPUT** and **SETUP OFF**.
2. Press the **▲▼** buttons to select **SPEAKER**, and then press the **ENTER** button.
3. Press the **▲▼** buttons to select **SPK SIZE**, and then press the **ENTER** button.
4. Press the **▲▼** buttons to select the speaker you want, and then press the **ENTER** button.
  - Each time you press the **▲▼** buttons, FRONT → CENTER → SURR → SBACK(DPLI|x) / FRONTH(DPLI|z) → SUBW → CROVR will be selected in turn.
5. Press the **▲▼** buttons to set the mode (LARGE, SMALL etc.) for the selected speaker.
6. Repeat steps 2-5 to set the mode for each speaker.



SPEAKER

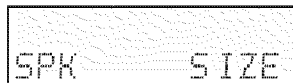

SPK SIZE

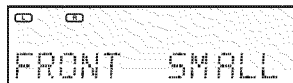

FRONT SMALL

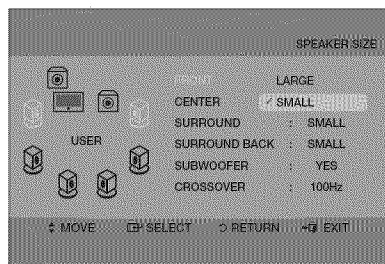

- To exit setup mode -

- Press the **SETUP/MENU** or **EXIT** button on the remote control.  
**SETUP OFF** appears on the display and Setup Mode is exited.

## Setting the Speaker

SPEAKER	Possible Settings	Default Setting
FRONT (Front)	LARGE, SMALL	SMALL
CENTER (Center)	LARGE, SMALL, NONE	SMALL
SURR (Surround)	LARGE, SMALL, NONE	SMALL
SBACK (Surround Back)	LARGE, SMALL, NONE	NONE
FRONTH (Front Height)	LARGE, SMALL	SMALL
SUBW (Subwoofer)	YES, NO	YES
CROVR (Crossover Frequency)	60, 80, 100, 120, 150, 180, 200(Hz)	100Hz

- **LARGE** : Select when using large speakers. You can listen to full range sound.
- **SMALL** : Select this when using small speakers.
- **NONE** : Select when no speaker is used.
- **YES (subwoofer)** : Select when using the subwoofer speaker.
- **NO (subwoofer)** : Select when not using the subwoofer speaker.
- **CROVR** : Select the crossover frequency for the best bass response in your speakers.

### NOTE

- You can also use the **SETUP**, **▲**, **▼**, **ENTER**, **RETURN** buttons on the front of your AV Receiver.
- When the Front speaker is only set to **LARGE**, you can select **LARGE** of other speakers.
- When the Surround speaker is set to **LARGE**, you can select **LARGE** of **SBACK** (Surround Back) speaker.
- When the 7.1 CHANNEL is set to **PLIIz**, you can not select **NONE** of surround speaker and front height speaker.
- You can also change the crossover frequency by using the **CROSS OVER**, **<**, **>** buttons on the remote control.

# Setup

## Connection Setting For Surround Back

Settings for the surround back speaker differ depending on the connection method and installation site of the speaker to be connected. You must configure the 7.1 CHANNEL settings according to the connected speaker before you listen to music properly.

1. Press the **SETUP/MENU** button on the remote control.
  - Each time the button is pressed, the mode switches between **INPUT** and **SETUP OFF**.
2. Press the **▲▼** buttons to select **SPEAKER**, and then press the **ENTER** button.
3. Press the **▲▼** buttons to select **7.1 CHANNEL**, and then press the **ENTER** button.
4. Press the **▲▼** to select a proper setting for the surround back speaker.
  - **SURR.BACK** : Select this if you want to install the surround back speaker in the default settings. With this setting, you can enable the Dolby Pro Logic IIx mode.
  - **PLIIz** : Select this if you want to install the surround back speaker in the top front corner. With this setting, you can enable the Dolby Pro Logic IIz mode.

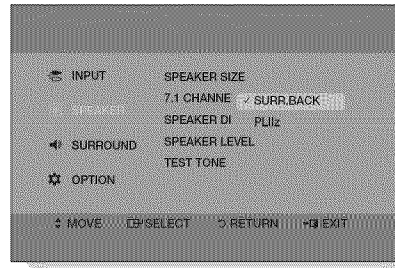

### NOTE

- Depending on the 7.1 CHANNEL settings, the surround back speaker or front height speaker menus may not be activated or may differ in the speaker menu: **SPEAKER SIZE**, **SPEAKER LEVEL**, **SPEAKER DISTANCE**.
- Depending on your setting, you may not use different features simultaneously. If you set **SURR-BACK**, for instance, you cannot use the following feature: **PLIIz**.

## Setting the Speaker Listening Distance

If the speakers cannot be placed at equal distances from the listening position, you can adjust the delay time of the audio signals from the center and surround speakers.

- Press the **SETUP/MENU** button on the remote control.
  - Each time the button is pressed, the mode switches between **INPUT** and **SETUP OFF**.
- Press the **▲▼** buttons to select **SPEAKER**, and then press the **ENTER** button.
- Press the **▲▼** buttons to select **SPK DISTANCE**, and then press the **ENTER** button.
- Press the **▲▼** buttons to select the speaker you want.
  - Each time you press the **▲▼** buttons, **F.L → F.R → CEN → S.L → S.R → SBL → SBR → S.W** will be selected in turn.
- Press the **◀▶** buttons to set the Speaker Distance.
  - For the **FRONT LEFT, FRONT RIGHT, CENTER, SURR. LEFT, SURR. RIGHT, SURRBACK.LEFT, SURRBACK.RIGHT** and **SUBWOOFER** Speakers, you can set the distance from the speaker to listening position between 1ft ~ 30ft (0.3~9.0m) in intervals of 1ft (0.3m).

SPEAKER



SPK DISTANCE



F.L 1FT0.3M

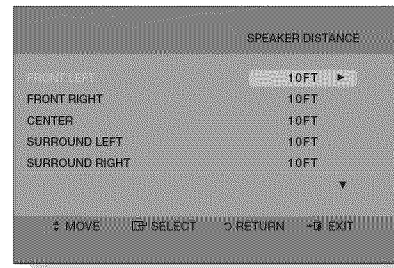

### - Setting Speaker Distance -

Set the distance from the speaker to listening position in intervals of 1ft(0.3m).

- F.L (front left) : 1ft ~ 30ft
- F.R (front right) : 1ft ~ 30ft
- S.L (surround left) : 1ft ~ 30ft
- S.R (surround right) : 1ft ~ 30ft
- CEN (center) : 1ft ~ 30ft
- SW (subwoofer) : 1ft ~ 30ft
- SBL (surround back left) : 1ft ~ 30ft
- SBR (surround back right) : 1ft ~ 30ft
- FHL (front height left) : 1ft ~ 30ft
- FHR (front height right) : 1ft ~ 30ft

### NOTE

- If the listening position is beyond the range of the speaker distance setup, set the speaker distance to the maximum.
- If Dolby Pro Logic IIz is set to On, the Surround Back speaker (SBL/SBR) is changed to the Front Height Speaker (FHL/FHR).

# Setup

## Setting the Speaker Level

You can set the balance and level of speakers.

1. Press the **SETUP/MENU** button on the remote control.
  - Each time the button is pressed, the mode switches between **INPUT** and **SETUP OFF**.
2. Press the **▲ ▼** buttons to select **SPEAKER**, and then press the **ENTER** button.
3. Press the **▲ ▼** buttons to select **SPK LEVEL**, and then press the **ENTER** button.
4. Press the **▲ ▼** buttons to select the speaker you want.
  - Each time you press this button, F.L → F.R → CEN → S.L → S.R → SBL → SBR → S.W will be selected in turn.
5. Press the **◀ ▶** buttons to set the Speaker Level mode.
  - You can adjust it from -10 to +10dB in 1 step increments.
  - The sound gets quieter at -10dB and louder at +10dB.

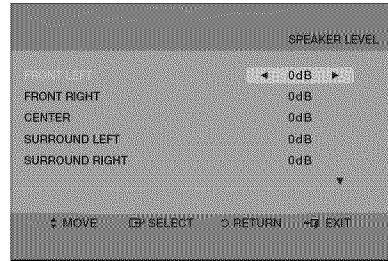
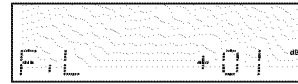
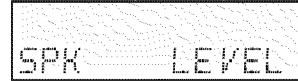

### - Setting Speaker Level -

- F.L (front left) : -10 ~ +10dB
- F.R (front right) : -10 ~ +10dB
- S.L (surround left) : -10 ~ +10dB
- S.R (surround right) : -10 ~ +10dB
- CEN (center) : -10 ~ +10dB
- SW (subwoofer) : -10 ~ +10dB
- SBL (surround back left) : -10 ~ +10dB
- SBR (surround back right) : -10 ~ +10dB
- FHL (front height left) : -10 ~ +10dB
- FHR (front height right) : -10 ~ +10dB

### NOTE

- If Dolby Pro Logic IIz is set to On, the Surround Back speaker (SBL/SBR) is changed to the Front Height Speaker (FHL/FHR).
- You can also change the subwoofer level by using the **SUBWOOFER**, **<**, **>** buttons on the remote control.

## Setting the Test Tone

Use the test tone to check the speaker connection status or level.

- Press the **SETUP/MENU** button on the remote control.
  - Each time the button is pressed, the mode switches between **INPUT** and **SETUP OFF**.
- Press the **▲▼** buttons to select **SPEAKER**, and then press the **ENTER** button.
- Press the **▲▼** buttons to select **TEST TONE**, and then press the **ENTER** button.
- Press the **▲▼** buttons to select the option you want, and then press the **ENTER** button.
  - AUTO** : Test signal will be automatically output as follows:  
F.L → CEN → S.W → F.R → S.R → S.L.  
- During test tone output, press the **▲▼** buttons to adjust the speaker output level from -10 to +10 dB by 1 step.
  - MANUAL** : Enables you to adjust the output level of the speaker manually.
    - Press the **ENTER** button to select the speaker you want.  
Each time you press the **ENTER** button, F.L → CEN → S.W → F.R → S.R → S.L will be selected in turn.
    - Press the **▲▼** buttons to set the Test Tone mode you want.  
You can adjust the speaker output level from -10 to +10dB by 1 step.  
The sound gets quieter at -10dB and louder at +10dB.

SPEAKER



TEST TONE



TONE AUTO

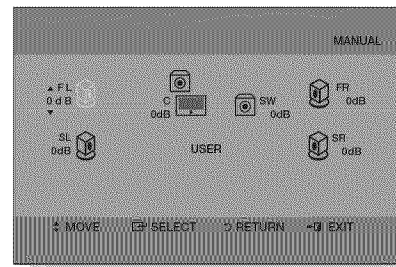

### - Test Tone Output -

- F.L (front left) : -10 ~ +10dB
- F.R (front right) : -10 ~ +10dB
- S L (surround left) : -10 ~ +10dB
- S.R (surround right) : -10 ~ +10dB
- CEN (center) : -10 ~ +10dB
- S.W (subwoofer) : -10 ~ +10dB
- SBL (surround back left) : -10 ~ +10dB
- SBR (surround back right) : -10 ~ +10dB

### - To stop test tone -

- Press the **SETUP/MENU** button once.  
**SETUP OFF** appears on the display and test tone stops.

### NOTE

- In the Dolby Pro Logic IIx mode, test signal will be automatically output as follows :  
F.L → CEN → S.W → F.R → S.R → SBR → SBL → S.L.
- In the Dolby Pro Logic IIz mode, test signal will be automatically output as follows :  
F.L → FHL → CEN → S.W → FHR → F.R → S.R → S.L.

# Setup

## Setting Dolby Pro Logic Mode

This mode provides up to 7.1 channel sound from 2 channel sources, or provides 7.1 channel sound from 5.1 channel sources for music or movie mode.

Press the **PROLOGIC** button on the remote control.

- **MOVIE** : Adds realism to the movie soundtrack.
- **MUSIC** : Provides up to 7.1 channel surround sound for digital, analog or existing stereo sources.
- **GAME** : Enhances the excitement of the game's sound.
- **MATRIX** : You will hear up to 7.1 channel surround sound.
- **PL (Pro Logic)** : You will experience a surround effect with 5.1 channel surround sound.
- **OFF** : Output the original signal as it is without applying the sound field effect or any other sound effect.

## Surround Setup

### Setting Dolby Pro Logic IIx

This function works only in Dolby Pro Logic IIx MUSIC mode.

1. Press the **SETUP/MENU** button on the remote control.
  - Each time the button is pressed, the mode switches between **INPUT** and **SETUP OFF**.
2. Press the **▲▼** buttons to select **SURROUND**, and then press the **ENTER** button.
3. Press the **▲▼** buttons to select **DPLIIx**, and then press the **ENTER** button.
4. Press the **▲▼** buttons to select the option you want, and then press the **ENTER** button.
  - **PANORAMA** : Press the **▲▼** buttons to select ON or OFF. (This mode extends the front stereo image to include the surround speakers for an exciting "wraparound" effect with side wall imaging.)
  - **DIMENSION** : Press the **◀▶** buttons to set from -7 to 7. (Incrementally adjusts the sound field (DSP) from the front or surround.)
  - **C- WIDTH** : Press the **◀▶** buttons to set from 0 to 7. (This sets the width of the center sound image. The higher the setting, the less sound comes from the center speaker.)



SURROUND



DPLIIx

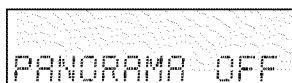

PANORAMA OFF

#### NOTE

- PANORAMA, DIMENSION and CENTER WIDTH settings are enabled only if the Dolby Pro Logic Mode is set to MUSIC.
- You cannot use Dolby Pro Logic IIx mode for multi channel signals such as Dolby Digital, Dolly Digital +, Dolby true HD, DTS, DTS-HD Master Audio.
- Pro Logic works only for PCM audio signals with sampling frequencies of 32KHz, 44KHz or 48KHz.
- When Dolby Pro Logic IIz is set ON, Dolby Pro Logic IIx can not be used.



## Setting NEO:6 Mode

You can play back 2 channel sound over 5.1 or 7.1 channels when enjoying music or a movie.

1. Press the **SETUP/MENU** button on the remote control.
  - Each time the button is pressed, the mode switches between **INPUT** and **SETUP OFF**.
2. Press the **▲▼** buttons to select **SURROUND**, and then press the **ENTER** button.
3. Press the **▲▼** buttons to select **DTS NEO:6**, and then press the **ENTER** button.
4. Press the **ENTER** buttons to set the C-IMAGE mode you want. Press the **◀▶** buttons to set the **C-IMAGE** from 0 to 5. This parameter adjusts the center image through the front and center speakers. "5" is the wider.

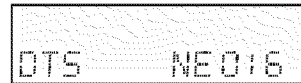

### Using NEO:6 Mode

Press the **NEO:6** button on the remote control.

- **MUSIC** : When listening to music, you can experience sound effects as if you are listening to the actual performance.
- **CINEMA** : Adds realism to the movie soundtrack.
- **OFF** : Output the original signal as it is without applying the sound field effect or any other sound effect.

#### NOTE

- NEO:6 works only for 2-ch audio signals with sampling frequencies of 32KHz, 44KHz or 48KHz.

## Setting EX/ES Mode

When surround back speakers are connected, you can listen to 7.1 multi-channel sound using the built-in Dolby Digital Surround EX or DTS ES decoder. This function works when a Dolby Digital or DTS source (such as a DVD player) is input, and does not work with L.PCM and Dolby Digital 2 channel sources.

1. Press the **SETUP/MENU** button on the remote control.
  - Each time the button is pressed, the mode switches between **INPUT** and **SETUP OFF**.
2. Press the **▲▼** buttons to select **SURROUND**, and then press the **ENTER** button.
3. Press the **▲▼** buttons to select **EX/ES**, and then press the **ENTER** button.
4. Press the **▲▼** buttons to set the EX/ES mode you want.
  - **AUTO** : If the unit receives an audio signal that it can recognize, it will select an optimal decoder for playback in 7.1 channels. If the amplifier does not recognize the audio signal, it will not play in 7.1 channel automatically.
  - **OFF** : Dolby Digital Surround EX / DTS ES decoder will not be used for playback.
  - **ON** : Dolby Digital or DTS signal will be played in 7.1 channel using Dolby Digital Surround EX / DTS ES decoder.

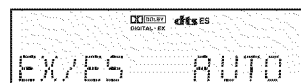
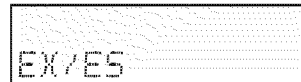

#### NOTE

- You cannot use DTS-ES without surround back speakers connected.

### Audio Sync

Video may look slower than the audio if it is connected to a digital TV. If this occurs, adjust the audio delay time to match the video.

1. Press the **SETUP/MENU** button on the remote control.
  - Each time the button is pressed, the mode switches between **INPUT** and **SETUP OFF**.
2. Press the **▲▼** buttons to select **OPTION**, and then press the **ENTER** button.
3. Press the **▲▼** buttons to select **AUDIO SYNC**, and then press the **ENTER** button.
4. Press the **◀▶** buttons to set the AUDIO SYNC Delay Time.
  - You can adjust it from 0 to 240MS in 10MS steps.

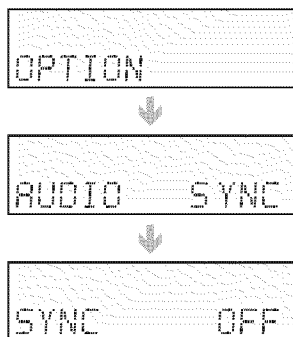

### Tone Control

This will enable you to adjust the bass and treble level.

1. Press the **SETUP/MENU** button on the remote control.
  - Each time the button is pressed, the mode switches between **INPUT** and **SETUP OFF**.
2. Press the **▲▼** buttons to select **OPTION**, and then press the **ENTER** button.
3. Press the **▲▼** buttons to select **TONE CONTROL**, and then press the **ENTER** button.
4. Press the **▲▼** buttons to select **TONE**, and then press the **ENTER** button.
5. Press the **▲▼** buttons to select ON or OFF you want, and then press the **ENTER** button.
  - If it is set to **TONE OFF**, the Tone Control function will be disabled.
6. Press the **▲▼** buttons to set the Tone Control mode you want.
  - **BASS & TREBLE** : Press the **◀▶** buttons to set from -6 to 6.
  - Each time you press this button, **TONE** → **BASS** → **TREBLE** will be selected in turn.
  - You can adjust it from -6 to +6dB by 1 step.
  - The sound gets quieter at -6dB and louder at +6dB.

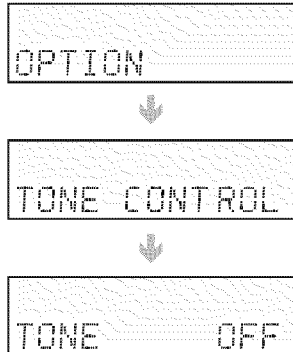

#### NOTE

- The Tone Control function can be applied to the front channels only.

## MP3 Enhancer

This also helps enhance your sound experience (ex. mp3 music). Use this if you want to hear better sound from a low quality mp3 source.

1. Press the **SETUP/MENU** button on the remote control.
  - Each time the button is pressed, the mode switches between **INPUT** and **SETUP OFF**.
2. Press the **▲▼** buttons to select **OPTION**, and then press the **ENTER** button.
3. Press the **▲▼** buttons to select **MP3 ENHANCER**, and then press the **ENTER** button.
4. Press the **▲▼** buttons to select **ON** or **OFF**.

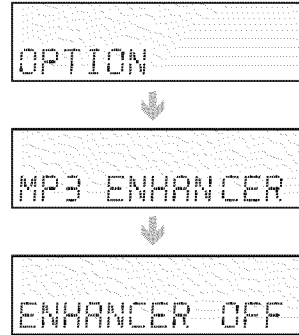

## Smart Volume

This will regulate and stabilize the volume level against a drastic volume change when changing channels or during a scene transition.

1. Press the **SETUP/MENU** button on the remote control.
  - Each time the button is pressed, the mode switches between **INPUT** and **SETUP OFF**.
2. Press the **▲▼** buttons to select **OPTION**, and then press the **ENTER** button.
3. Press the **▲▼** buttons to select **SMART VOLUME**, and then press the **ENTER** button.
4. Press the **▲▼** buttons to select **ON** or **OFF**.

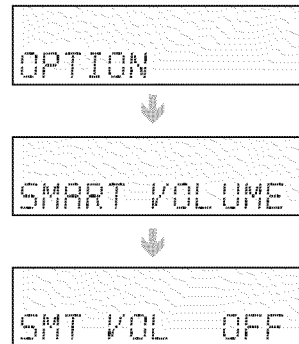

# Setup

## Auto Calibration Setup

By setting the calibration just once when you relocate or install the unit, you can have the unit automatically recognize the distance between speakers, levels between channels, and frequency characteristics to create a 5.1-channel sound field optimized for your environment.

### - Before Setting -

1. Plug the ASC microphone into the **ASC MIC** jack.
2. Place the ASC microphone at the listening position.
3. Press the **ASC** button on the front panel, and then press the **ENTER** button.

1. Press the **SETUP/MENU** button on the remote control.
  - Each time the button is pressed, the mode switches between **INPUT** and **SETUP OFF**.
2. Press the **▲▼** buttons to select **OPTION**, and then press the **ENTER** button.
3. Press the **▲▼** buttons to select **AUTO CALIBRATION**, and then press the **ENTER** button.
4. Press the **▲▼** buttons to select **MEASUREMENT**, and then press the **ENTER** button.
  - To create the optimal 5.1 channel sound field, the selections are in the following sequence:  
**L → C → R → SR → SBR → SBL → SL → SW**
  - **MODE ON** : The auto calibration mode is set to on.
  - **MODE OFF**: The auto calibration mode is set to off.

OPTION

CALIBRATION

MEASUREMENT

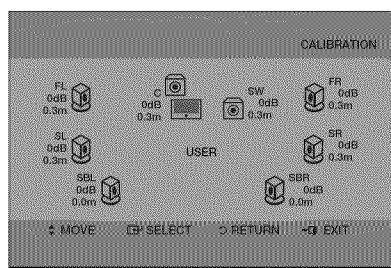

### To cancel the Auto Calibration setup.

This will be automatically reverted if you press the **RETURN** button.

- If auto calibration error occurs, see "Auto Calibration Error List" on page 58.

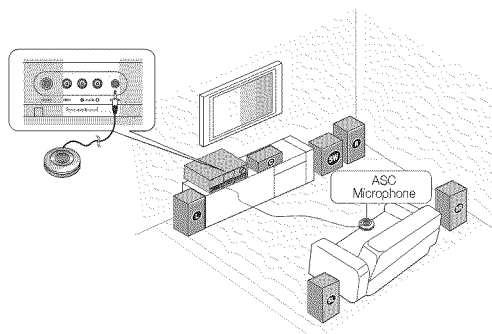

### NOTE

- Setting the calibration takes about 3 minutes.
- Because the volume level of the tone is fixed during the Auto Calibration setup, you cannot adjust the volume using the volume control.
- If the ASC microphone is disconnected during the Auto Calibration setup, the setup will be canceled.
- You can also press the **ASC** button on the remote control to use this function.
- If Dolby Pro Logic IIz is set to ON, the selection are in the following sequence :  
FL → CEN → FR → SR → FHR → FHL → SL → SW.

## DRC Setup

You can use this function to enjoy Dolby Digital sound when watching movies at low volume at night. DRC compresses the audio to make the loudest sounds quieter and the quietest sounds louder.

1. Press the **SETUP/MENU** button on the remote control.
  - Each time the button is pressed, the mode switches between **INPUT** and **SETUP OFF**.
2. Press the **▲▼** buttons to select **OPTION**, and then press the **ENTER** button.
3. Press the **▲▼** buttons to select **DRC**, and then press the **ENTER** button.
4. Press the **▲▼** buttons to set the DRC you want.
  - **AUTO** : The Dynamic Range Control will be set automatically based on the information provided by the Dolby TrueHD Soundtrack.
  - **MIN** : Sets DRC effect to minimum.
  - **STD** : Sets DRC effect to standard.
  - **MAX** : Sets DRC effect to maximum.

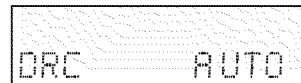
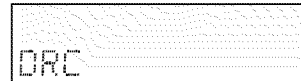
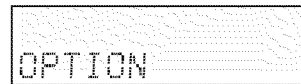

## Dual Mono Setup

Dual mono programs have two independent mono channels.

You can use this function when dual mono programs are played.

When you use this function, select audio channels CH1, CH2 or both Channel.

1. Press the **SETUP/MENU** button on the remote control.
  - Each time the button is pressed, the mode switches between **INPUT** and **SETUP OFF**.
2. Press the **▲▼** buttons to select **OPTION**, and then press the **ENTER** button.
3. Press the **▲▼** buttons to select **DUAL MONO**, and then press the **ENTER** button.
4. Press the **▲▼** buttons to select the DUAL MONO option you want.
  - **CH1** : Channel 1 is heard only.
  - **CH2** : Channel 2 is heard only.
  - **BOTH** : Both channels are heard from front speakers.

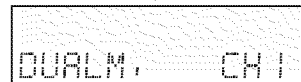
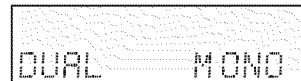

# Setup

## HDMI Setup

Use this if you want to receive audio from HDMI connected external devices.

1. Press the **SETUP/MENU** button on the remote control.
  - Each time the button is pressed, the mode switches between **INPUT** and **SETUP OFF**.
2. Press the **▲▼** buttons to select **OPTION**, and then press the **ENTER** button.
3. Press the **▲▼** buttons to select **HDMI SETUP**, and then press the **ENTER** button.
4. Press the **▲▼** buttons to set the HDMI Setup mode you want, and then press the **ENTER** button.
5. Press the **▲▼** buttons to set you want.
  - **AUTO SYNC** : ON, OFF  
The AV receiver can be set to automatically correct any delay between the video and the audio, based on the data from the connected TV.
    - ON : HDMI Sync is enabled.
    - OFF : HDMI Sync is disabled.
  - **HDMI AUDIO** : AVR(Audio Video Receiver), TV  
This preference determines whether audio received at the HDMI IN is output by the HDMI OUT. If you want to listen to audio from an HDMI connected external device through your HDMI connected TV's speakers, set it to TV. Otherwise, leave it on AVR to listen to audio from the AV receiver.
    - AVR : HDMI audio is not output
    - TV : HDMI audio is output
  - **HDMI ANYNET+** : ON, OFF  
Anynet+ is a function that enables you to control other Samsung Devices with your Samsung TV's remote control.
    - ON : Anynet+ is enabled.
    - OFF : Anynet+ is disabled.
  - **ARC** : AUTO , OFF  
If you use the HDMI cable to connect between HDMI IN of an Audio Return Channel-compliant TV and HDMI OUT (ARC) of the main unit, you can listen to the TV sound through the main unit connected speaker without the further connection.
    - AUTO : The audio signal from the TV can be sent to the HDMI OUT of the main unit.
    - OFF : Turn TV ARC function off.

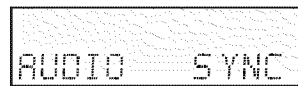

### NOTE

- HDMI Audio is enabled only if both the HDMI INPUT and HDMI OUT are connected properly and working normally.
- HDMI Sync function works only if your HDMI compatible TV supports this function.
- If HDMI ANYNET+ is set to OFF, TV ARC will be set to OFF accordingly that cannot switch to AUTO.
- The ARC function will be active only via the HDMI OUT terminal.

## Using the Surround Modes

### Using the AUDIO EFFECT Button On the Front of the Main Unit

#### Selecting the DPLIIx mode

1. Press the **AUDIO EFFECT** button to select **DPLIIx** mode.
  - Each time you press this button, **PROLOGIC II x** → **ΠΕΟ:6** → **LIVE SURR.** → **3D SOUND** will be selected in turn.
2. Press the **<**, **>** button.
  - Each time you press the **<**, **>** button, **MUSIC** → **GAME** → **MATRIX** → **PL** → **PL OFF** → **MOVIE** will be selected in turn.
  - If you turn Dolby Pro Logic IIz on, **HEIGHT** → **PL OFF** will be selected in turn.
  - You can also select the **DPLIIx** mode by pressing the **PROLOGIC** button on the remote control.

#### Selecting the NEO:6 mode

1. Press the **AUDIO EFFECT** button briefly to select **NEO:6** mode.
  - Each time you press this button, **PROLOGIC II x** → **ΠΕΟ:6** → **LIVE SURR.** → **3D SOUND** will be selected in turn.
2. Press the **<**, **>** button.
  - Each time you press the **<**, **>** button, **MUSIC** → **CINEMA** → **OFF** will be selected in turn.
  - You can also select the **NEO:6** mode by pressing the **NEO : 6** button on the remote control.

#### Selecting the DSP mode

1. Press the **AUDIO EFFECT** button to select **DSP** mode.
  - Each time you press this button, **PROLOGIC II x** → **ΠΕΟ:6** → **LIVE SURR.** → **3D SOUND** will be selected in turn.
2. Press the **<**, **>** button.
  - Each time you press the **<**, **>** button, **STEREO** → **HALL 1** → **HALL 2** → **J.CLUB** → **CHURCH** → **ROCK** → **CLASSIC** → **LIVE** → **GAME** → **MOVIE** → **CONCERT** → **STADIUM** will be selected in turn.
  - You can also select the **DSP** mode by pressing the **DSP** button on the remote control.

#### Selecting the 3D SOUND mode

1. Press the **AUDIO EFFECT** button to select **3D SOUND** mode.
  - Each time you press this button, **PROLOGIC II x** → **ΠΕΟ:6** → **LIVE SURR.** → **3D SOUND** will be selected in turn.
2. Press the **<**, **>** button.
  - Each time you press the **<**, **>** button, **3D SOUND ON** → **3D SOUND OFF** will be selected in turn.
  - You can also select the **3D SOUND** mode by pressing the **3D SOUND** button on the remote control.

#### NOTE

- The 3D sound effect will not be available for Dolby TrueHD, Dolby Digital Plus, DTS-HD Master Audio and DTS-HD High Resolution Audio.
- You cannot use Dolby Pro Logic IIx mode for Analog multi channel signals, LPCM multi channel signals from HDMI, Dolby TrueHD, Dolby Digital Plus, DTS-HD Master Audio and DTS-HD High Resolution Audio.
- Pro Logic works with the audio signals with sampling frequencies of 32KHz, 44KHz or 48KHz.
- The 3D sound effect will not be available for FM.

# Operation

## Using the S.DIRECT Button

Output the original signal as it is without applying the sound field effect or any other sound effect.

Press the **S.DIRECT** button.

### NOTE

- The screen will display "DIRECT" instead of "S.DIRECT".

### Input Signal and Surround Chart

o = active, – = inactive

Input Signal	Surround Mode	Output Channel					Display Information	
		L/R	C	SL SR	SBL SBR	SUBW	Signal Format	Channel Status
Dolby Digital	Dolby Digital	o	o	o	–	o	Digital + Dolby Digital	L, C, R, SL, SR, SW
Dolby Digital EX	Dolby Digital EX	o	o	o	o	o	Digital +Dolby Digital EX	L, C, R, SL, SR, SBL, SBR, SW
	Dolby Digital + ProLogic IIX	o	o	o	o	o	Digital + Dolby Digital + ProLogic IIX	L, C, R, SL, SR, SBL, SBR, SW
	Dolby Digital + ProLogic IIZ	o	o	o	o (Height)	o	Digital + Dolby Digital + ProLogic IIZ	L, C, R, SL, SR, H, SW
Dolby Digital Plus	Dolby Digital Plus	o	o	o	o	o	Digital + Dolby Digital Plus	L, C, R, SL, SR, SBL, SBR, SW
Dolby TrueHD	Dolby TrueHD	o	o	o	o	o	Dolby TrueHD	L, C, R, SL, SR, SBL, SBR, SW
DTS (5.1-ch)	DTS Surround	o	o	o	–	o	DTS	L, C, R, SL, SR, SW
DTS-ES	DTS Digital + ProLogic IIX	o	o	o	o	o	DTS + ProLogic IIX	L, C, R, SL, SR, SBL, SBR, SW
	DTS Digital + ProLogic IIZ	o	o	o	o (Height)	o	DTS + ProLogic IIZ	L, C, R, SL, SR, SBL, SBR, SW
	DTS ES	o	o	o	o	o	DTS ES	L, C, R, SL, SR, SBL, SBR, SW
DTS 96/24	DTS 96/24	o	o	o	–	o	DTS 96/24	L, C, R, SL, SR, SW
	DTS-HD	o	o	o	o	o	DTS-HD MSTR	L, C, R, SL, SR, SBL, SBR, SW
DTS-HD	DTS-HD Master Audio	o	o	o	o	o	DTS-HD	L, C, R, SL, SR, SBL, SBR, SW
	DTS-HD High Resolution	o	o	o	o	o	DTS-HD	L, C, R, SL, SR, SBL, SBR, SW
LPCM Multi-Channel	Multi-Channel	o	o	o	o	o	Digital + LPCM	L, C, R, SL, SR, SBL, SBR, SW
	Multi-Channel	o	o	o	o (Height)	o	Digital + LPCM	L, C, R, SL, SR, H, SW
2-ch PCM	Stereo	o	–	–	–	o	Digital + LPCM	L, R, SW
	ProLogic IIX	o	o	o	o	o	Digital + LPCM + Dolby Digital + ProLogic IIX	L, C, R, SL, SR, SBL, SBR, SW
	ProLogic IIZ	o	o	o	o (Height)	o	Digital + LPCM + Dolby Digital + ProLogic IIZ	L, C, R, SL, SR, H, SW
	NEO:6	o	o	o	o	o	Digital + LPCM + DTS + NEO:6	L, C, R, SL, SR, SBL, SBR, SW
	SFE	o	o	o	o	o	Digital + LPCM + LIVE SURR	L, C, R, SL, SR, SBL, SBR, SW
Analog 2-ch	Stereo	o	–	–	–	o	Analog	L, R, SW
	ProLogic IIX	o	o	o	o	o	Analog + Dolby Digital + ProLogic IIX	L, C, R, SL, SR, SBL, SBR, SW
	ProLogic IIZ	o	o	o	o (Height)	o	Analog + Dolby Digital + ProLogic IIZ	L, C, R, SL, SR, H, SW
	NEO:6	o	o	o	o	o	Analog + DTS NEO:6	L, C, R, SL, SR, SBL, SBR, SW
	SFE	o	o	o	o	o	Analog + LIVE SURR	L, C, R, SL, SR, SBL, SBR, SW

- **L/R** : front speaker (left/right)
- **C** : center speaker
- **SL/SR** : surround speaker (left/right)
- **SBL/SBR** : surround back speaker (left/right)
- **H = FHL/FHR** : front height speaker (left/right)
- **SW** : subwoofer
- **LIVE SURR** : LIVE SURROUND



### NOTE

- Channel status displays are dependent on the speaker configuration.
- SFE mode works with 2-ch signals.
- If Dolby Pro Logic IIz is set to On, the Surround Back speaker(SBL/SBR) is changed to the Front Height Speaker(FHL/FHR), Dolby true HD, Dolby plus, DTS-HD Audio ,SFE and NEO:6 will be output 5.1 channel.
- ProLogic IIx and ProLogic IIz works only audio signals with sampling frequencies of 32KHz, 44KHz or 48KHz.

## Using the SUBWOOFER button

You can set the subwoofer Level.

1. Press the **SUBWOOFER** button.
2. Press the ◀ ▶ buttons to select Subwoofer LEVEL under the Display with S.W. (The display disappears automatically.)

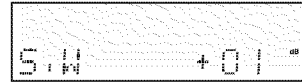

### - Setting the Subwoofer Level-

- SW (Subwoofer) : -10 ~ +10dB

## Listening to the Radio

You can listen to the radio by using either automatic or manual tuning.

1. Press the **INPUT SELECT** button on the remote control to select **FM**.
2. Select a frequency (radio broadcast).
  - Preset tuning :  
Press the ◀▶ buttons on the remote control to select the preset frequency.
  - Manual tuning 1 (Automatic tuning):  
Press and hold the **TUNING/CH** ( √ , ∧ ) buttons on the remote control to automatically tune in a frequency.
  - Manual tuning 2 :  
Press the **TUNING/CH** ( √ , ∧ ) buttons on the remote control to increase or decrease the frequency step by step.

### NOTE

- You can also use the **SELECT** ( √ , ∧ ) button on the main unit to change the radio frequency.

# Operation

## To Listen in Mono/Stereo

Press the **MO/ST** button on the remote control.

- Each time you press this button, **STEREO** or **MONO** will be selected in turn.
- If you select **MONO** in an area with weak reception, it will help to reduce noise.
- This function works only with the remote control.

## Presetting Radio Stations

You can preset up to 15 FM stations.

E.g.: Setting station FM 89.10 in preset 2.

1. Press the **INPUT SELECT** button on the remote control to select **FM**.
2. Press the **TUNING/CH** (  $\nabla$ ,  $\blacktriangle$  ) buttons on the remote control to select 89.10.
  - Refer to step 2 above to tune in automatically and manually.
3. Press the **TUNER MEMORY** button on the main unit.
  - You can also use the **TUNER MEMORY** button on the remote control.
  - Tuner number will blink on the display.
4. Press the **TUNING/CH** (  $\nabla$ ,  $\blacktriangle$  ) buttons on the remote control to select preset 2.
  - You can select from presets 1 to 15.
5. Press the **TUNER MEMORY** button on the main unit.
  - Tuner number will disappear and station 89.10 will be saved in preset 2.
6. To preset other stations, repeat steps 2 to 5.

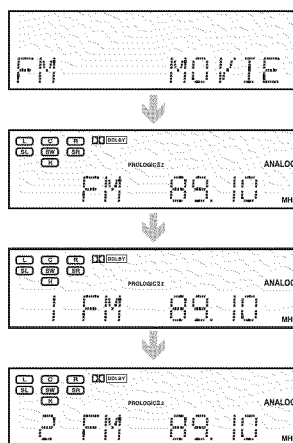

### To Listen to Preset Station

- Press the **TUNING MODE** button to select **PRESET** and press the **SELECT** (  $\nabla$ ,  $\blacktriangle$  ) buttons.

## Using an iPod

You can enjoy playback of your iPod using the supplied remote control.

### Listening to Music (iPod audio function)

You can play music files stored in the iPod player by connecting it to the AV receiver.

1. Connect the iPod dock connector to the iPod jack on the AV Receiver.
2. Place the iPod in the dock.
  - Your iPod is automatically turned on.
3. Press the **INPUT SELECT** button on the remote control to select **IPOD AUDIO** mode.
4. Press the **PLAY** button on the remote control to play.
  - The AV receiver starts playing from the first track of the iPod player.
5. You can use the remote control to control simple playback functions such as the **PLAY**, **PAUSE**, **STOP**, **SKIP (◀◀, ▶▶)** buttons.

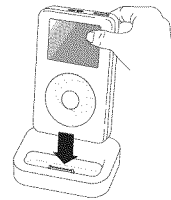

#### NOTE

- See page 27 for compatible iPods.
- Compatibility depends on the software version of your iPod.
- You can also select iPod by pressing the **iPod** button on the remote control.

### Watching a Movie (iPod video function)

You can play video files stored in the iPod player on a TV by connecting it to the AV receiver.

1. Connect the iPod dock connector to the iPod jack on the AV receiver.
2. In the iPod screen, move to **Videos > Settings** and set the **TV Out** option to **On**.
3. Place the iPod in the dock.
4. Press the **INPUT SELECT** button on the remote control to select **IPOD VIDEO** mode.
5. Set the AV IN option of the TV connected to the AV receiver to **COMPOSITE**.

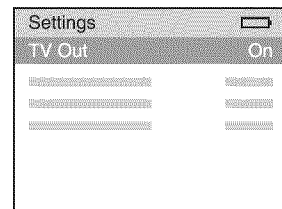

<iPod Screen>

Follow the iPod onscreen guide through the following steps.

6. Press the **▲, ▼** buttons on the remote control to select **Videos** and press the **ENTER** button.
7. Press the **▲, ▼** buttons on the remote control to select **Movies** and press the **ENTER** button.

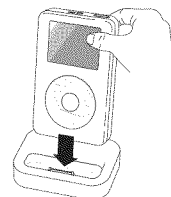

# Operation

- Press the ▲, ▼ buttons to select the file to play and press the **ENTER** button.
  - The iPod's video files will be played on the TV screen.
- You can use the remote control to control simple playback functions such as the **PLAY, PAUSE, STOP, SKIP (◀▶)** buttons.
  - If you press the **PREV** button after the playback, the player will move to the start screen of the current file.
  - Press the **STOP** button to stop playing and return to the list screen.
  - Press the **RETURN** button to return to the previous menu.



<iPod Screen>

## NOTE

- Before you can play the video files in the iPod player, you must connect the Audio/Video terminals of the TV to the receiver using the Composite (A/V) cable.
- See page 27 for compatible iPods.  
Compatibility depends on the software version of your iPod.
- When the current file is played to the end, the next file will not be played automatically.  
To play the next file, select a file to play in the list screen of the iPod player.
- No other screen than the playback one will appear on the TV screen. Check other screens on the iPod player.

## Convenient Functions

### Sleep Timer Function

You can set the time that this unit will shut itself off.

Press the **SLEEP** button.

- SLEEP** : OFF → 10M → 20M → 30M → 60M → 90M → 120M → 150M will be selected in turn.

#### To check sleep timer

Press the **SLEEP** button.

- The remaining time before this unit will shut itself off is shown on the display.
- Pressing the button again changes the sleep time from what you set previously.

#### To cancel sleep timer

- Press the **SLEEP** button until **SLEEP OFF** appears on the display.

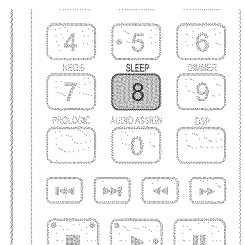

## Mute Function

This function is useful when answering a doorbell or telephone call.

Press the **MUTE** button.

- MUTE appears on the display.

### To output sound again

Press the **MUTE** button again or press the Volume button.

- MUTE will disappear and sound will output.

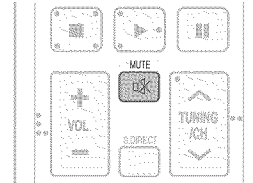

## Adjust the Display

You can adjust the brightness of the display.

Press the **DIMMER** button.

- Each time you press this button, the brightness changes as follows :  
Dark → Bright.

### NOTE

- SLEEP, Mute and the Adjust Display functions can only be operated with the remote control.

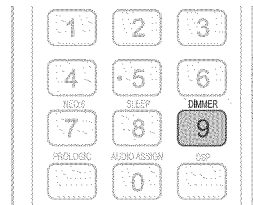

## Reset Function

### When the Power is on,

1. Press the **MUTE** button.
  - MUTE appears on the display.
2. Press the **2** button five times and then press the **ENTER** button.
  - **INITIAL : NO** appears on the display.
3. Press the **◀ ▶** buttons to select **YES**.
  - The unit will turn off after 5 seconds.

### When the Power is Off,

1. Press and hold the **TUNER MEMORY** button on the front of your AV Receiver for longer than 5 seconds.
  - **POWER LED** will blink one time.

### NOTE

- Using the RESET function will erase all stored settings.
- Do not use this unless necessary.

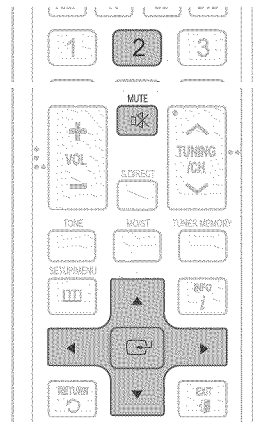

# Operation

## Using Headphones

Use headphones (not supplied) for private listening pleasure.

Connect the headphones to the headphone (PHONES) jack and listen to music.

### NOTE

- Do not turn the volume up too high when you use headphones as it may damage your hearing.

## Software Upgrade

Samsung may offer upgrades for AV Receiver's firmware in the future.

Please visit [Samsung.com](http://Samsung.com) or contact the Samsung call center at 1-800-SAMSUNG (726-7864) to receive information about downloading upgrades and using a USB drive. Upgrades will be possible by connecting a USB drive to the USB port located on your AV Receiver.

### NOTE

- Insert a USB drive containing the firmware upgrade into the USB port on the back of the main unit.
- Please be careful to not disconnect the power or remove the USB drive while upgrades are being applied. The main unit will turn off automatically after completing the firmware upgrade. When software is upgraded, settings you have made will return to their default (factory) settings. We recommend you write down your settings so that you can easily reset them after the upgrade.
- If you failed software upgrade, it is strongly recommended whole USB data format to FAT16 and retry software upgrade.
- The NTFS USB File System can not be supported.
- Depending on the manufacturer, the USB may not be supported.

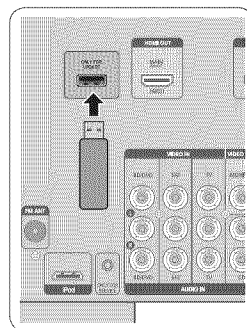

## Operating your TV with the Remote Control

1. Press the **POWER** button to turn on the TV.
2. Press the **TV** button to set the remote to TV mode.
3. Point the remote control toward the TV.
4. While holding down the **POWER** button, enter the code corresponding to your brand of TV.
  - If there is more than one code listed for your TV in the table, enter one at a time to determine which code works.
  - If the code matches the TV's code, the TV will be turned off.
5. If TV is turned on or off when you press the **POWER** button of the remote control, the setting is completed.
  - You can use the TV **POWER**, **VOLUME**, **CHANNEL**, **MENU** and **Numeric** buttons (0-9).



### NOTE

- The remote control may not work on some brands of TVs. Also, some operations may not be possible depending on your brand of TV.
- The remote control will work with Samsung TVs by default.

## TV Brand Code List

Brand	Code	Brand	Code	Brand	Code
Admiral (M.Wards)	56, 57, 58	Hitachi	15, 18, 50, 53, 59	Realistic	03, 19
A Mark	01, 15	Inkel	45	Sampo	40
Anam	01, 02, 03, 04, 05, 06, 07, 08, 09, 10, 11, 12, 13, 14	JC Penny	56, 59, 67, 86	Samsung	00, 15, 16, 17, 40, 43, 46, 47, 48, 49, 59, 60, 98
AOC	01, 18, 40, 48	JVC	70	Sanyo	19, 61, 55
Bell & Howell (M.Wards)	57, 58, 81	KTV	59, 61, 87, 88	Scott	03, 40, 90, 61
Brocsonic	59, 60	KEC	03, 15, 40	Sears	15, 18, 19
Candle	18	KMC	15	Sharp	15, 57, 54
Cetronic	03	LG (Goldstar)	01, 15, 16, 17, 37, 38, 39, 40, 41, 42, 43, 44	Signature 2000 (M.Wards)	57, 58
Citizen	03, 18, 25	Luxman	18	Sony	50, 51, 52, 53, 55
Cinema	97	LXI (Sears)	19, 54, 56, 59, 60, 62, 53, 65, 71	Soundesign	03, 40
Classic	03	Magnavox	15, 17, 18, 48, 54, 59, 60, 62, 72, 89	Spectricon	01
Concerto	18	Marantz	40, 54	SSS	18
Contec	46	Matsui	54	Sylvania	18, 40, 48, 54, 59, 60, 62
Coronado	15	MGA	18, 40	Symphonic	61, 95, 36
Craig	03, 05, 61, 82, 83, 84	Mitsubishi/ MGA	18, 40, 59, 60, 75	Tatung	05
Croslex	62	MTC	18	Techwood	18
Crown	03	NEC	18, 19, 20, 40, 59, 60	Teknika	03, 15, 18, 25
Curtis Mates	59, 61, 63	Nikei	03	TMK	18, 40
CXC	03	Onking	03	Toshiba	19, 57, 93, 71
Daewoo	02, 03, 04, 15, 16, 17, 18, 19, 20, 21, 22, 23, 24, 25, 26, 27, 28, 29, 30, 32, 34, 35, 39, 48, 59, 90	Onwa	03	Vidtech	18
Daytron	40	Panasonic	06, 07, 08, 09, 54, 65, 57, 73, 74	Videch	59, 60, 99
Dynasty	03	Penney	18	Wards	15, 17, 18, 40, 48, 54, 60, 94
Emerson	03, 15, 40, 49, 59, 61, 64, 82, 83, 84, 85	Philco	03, 15, 17, 18, 48, 54, 59, 62, 69, 90	Yamaha	18
Fisher	19, 65	Philips	15, 17, 18, 40, 48, 54, 62, 72	York	40
Funai	03	Pioneer	63, 66, 80, 31	Yupiteru	03
Futuretech	03	Portland	15, 18, 53	Zenith	58, 79
General Electric (GE)	06, 40, 56, 59, 65, 67, 68	Proton	40	Zonda	01
Hall Mark	40	Quasar	06, 66, 67	Dongyang	03, 54
		Radio Shack	17, 48, 56, 60, 51, 75		
		RCA/Proscan	18, 59, 67, 76, 77, 78, 32, 33, 94		

# Miscellaneous

## Operating your DVD or BD Player with the Remote Control

1. Press the **POWER** button to turn on the DVD (BD) player.
2. Press the **BD/DVD** button on the remote control to set the remote to DVD (BD) mode.
3. Point the remote control toward the DVD (BD).
4. While holding down **POWER** button, enter the code corresponding to your brand of DVD (BD).
  - If there is more than one code listed for your DVD (BD) in the table, enter one at a time to determine which code works.
  - If the code matches the DVD (BD)'s code, the DVD (BD) will be turned off.
5. If DVD (BD) is turned on or off when you press the **POWER** button of the remote controller, the setting is completed.
  - You can use DVD (BD) **POWER**, **PLAY**, **PAUSE**, **STOP**, **SKIP**, **MENU** and Numeric buttons (0~9).



### NOTE

- The remote control may not work on some brands of DVD.  
Also, some operations may not be possible depending on your brand of DVD.
- The remote control will work with Samsung DVD (BD) by default.

## DVD Brand Code List

Brand	Code Number	Brand	Code Number	Brand	Code Number
DENON	003, 032	ONKYO	004, 014	TOSHIBA	004, 018
DOONoon	019	OPTIMUS	011	YAMAHA	009, 033
DMTECH	017	PANASONIC	021	ZENITH	004, 024
FISHER	002	PROSCAN	006	TAEGWANG	026
GE	006	PHILIPS	004, 023	PS2	028
HARMAN/KARDON	012	PIONEER	007, 011, 022, 025	X-BOX	029
JVC	010, 013	RCA	006	APEX	030
KENWOOD	008	SAMSUNG	000, 027	Marantz	031
LG	001	SANYO	002		
MAGNAVOX	004	SONY	015, 020		
mitsubishi	005, 016	THETA DIGITAL	011		

## BD Player Brand Code List

Brand	Code Number
SAMSUNG	000, 001, 002, 003, 004



### NOTE

- The remote control will control Samsung BD players only.



# Other Information

## Troubleshooting

Before requesting service, please check the following.

Symptom	Check	Remedy
The unit will not turn on.	<ul style="list-style-type: none"> <li>Is the power cord plugged into the outlet?</li> </ul>	<ul style="list-style-type: none"> <li>Connect the power plug to the outlet.</li> </ul>
A function does not work when the button is pressed.	<ul style="list-style-type: none"> <li>Is there static electricity in the air?</li> </ul>	<ul style="list-style-type: none"> <li>Disconnect the power plug and connect it again.</li> </ul>
Sound is not produced.	<ul style="list-style-type: none"> <li>Are the speakers and external components connected properly?</li> <li>Is the Mute function on?</li> <li>Is the volume set to minimum?</li> <li>Is the Speaker Size set incorrectly to NONE?</li> </ul>	<ul style="list-style-type: none"> <li>Connect them correctly.</li> <li>Press the <b>MUTE</b> button to cancel the function.</li> <li>Adjust the volume.</li> <li>Refer to pages 35 to select LARGE, SMALL or YES.</li> </ul>
Picture does not appear on a TV when the function is selected.	<ul style="list-style-type: none"> <li>Is the external component connected properly?</li> </ul>	<ul style="list-style-type: none"> <li>Connect it correctly.</li> </ul>
Remote controller does not work.	<ul style="list-style-type: none"> <li>Are the batteries drained?</li> <li>Is the distance between remote control and main unit too great?</li> </ul>	<ul style="list-style-type: none"> <li>Replace with new batteries.</li> <li>Operate at close distance.</li> </ul>
The sound from the left/right channels is reversed.	<ul style="list-style-type: none"> <li>Are the left/right speaker or left/right input/output cables connected properly?</li> </ul>	<ul style="list-style-type: none"> <li>Check the left/right channel and connect it/them correctly.</li> </ul>
Can't receive radio broadcasts.	<ul style="list-style-type: none"> <li>Is FM antenna connected properly?</li> </ul>	<ul style="list-style-type: none"> <li>Connect the antenna correctly.</li> <li>If the input strength of antenna signal is weak, install the FM antenna in a place with good reception.</li> </ul>
There is no sound from surround speakers.	<ul style="list-style-type: none"> <li>Are the surround speakers connected properly?</li> <li>Is SURR (surround) incorrectly set to NONE in the Speaker Size?</li> <li>Is surround mode set to stereo?</li> </ul>	<ul style="list-style-type: none"> <li>Refer to page 17 to connect them properly.</li> <li>Refer to page 35 to select LARGE or SMALL.</li> <li>Refer to pages 47 ~ 49 to select proper Surround Mode.</li> </ul>
There is no sound from surround back speakers	<ul style="list-style-type: none"> <li>Are the surround back speakers connected properly?</li> <li>Is SBACK (Surround Back) set to NONE in the Speaker Size?</li> <li>Is Surround Mode set to EX/ES?</li> </ul>	<ul style="list-style-type: none"> <li>Refer to page 17 to connect them properly.</li> <li>Refer to page 35 to select LARGE or SMALL.</li> <li>Refer to page 41 to set Surround Mode to EX/ES.</li> </ul>
Can't select EX/ES mode.	<ul style="list-style-type: none"> <li>Is SBACK (Surround Back) set to NONE in the Speaker Size?</li> <li>Is the input signal selected properly?</li> </ul>	<ul style="list-style-type: none"> <li>Refer to page 35 to select LARGE or SMALL.</li> <li>Use a 7.1 channel external component.</li> </ul>

## Other Information

Symptom	Check	Remedy
Can't select Dolby Pro Logic IIx mode.	<ul style="list-style-type: none"> <li>Is the input signal selected properly?</li> </ul>	<ul style="list-style-type: none"> <li>Only 2 channel signal can select Dolby Pro Logic IIx mode. (ex:Dolby Digital, PCM, 2 channel analog input signal.)</li> </ul>
Can't select NEO:6 mode.	<ul style="list-style-type: none"> <li>Is the input signal selected properly?</li> </ul>	<ul style="list-style-type: none"> <li>Use PCM and Analog input signal.</li> </ul>
There is no sound when playing a DTS encoded DVD.	<ul style="list-style-type: none"> <li>Is Digital input selected?</li> </ul>	<ul style="list-style-type: none"> <li>Check whether the DVD player is properly connected and refer to page 30 to select the digital input.</li> </ul>

### Product Protection Function

#### Heat protection

- The protection function will come on if the main unit or power transformer overheats.

"PROTECTION" will appear in the display .

This function will come on :

- If speaker terminal is shorted
- If speaker cable is shorted

If there is no problem when you turn the unit on again after turning it off, PROTECTION mark will disappear on the display and the unit will work properly.

### Auto Calibration Error List

Error No.	Auto Calibration Error Message on OSD
E02 NO MIC	Connect the calibration microphone.
E03 NOISY	Keep quiet during the measurement.
E04 MIC LEVEL	The speaker are too close to the microphone. Install all speakers and the calibration microphone at the proper location.
E05 NO FRONT	Connect the front speaker correctly.
E07 LEVEL OVR	Install all speakers and the calibration microphone at the proper location.
E08 DIST OVR	Some speakers are too far from calibration microphone. Install all speakers and the calibration microphone at the proper location.
E13 TIME OVR	Unplug and re-plug the power cable. Then, perform the measurement again.
E14 CODE ERR	Unplug and re-plug the power cable. Then, perform the measurement again.

## Specifications

GENERAL	Power supply	120V, 60 Hz	
	Standby power consumption	0.9W	
	Power consumption	Main unit	75W
		Subwoofer	35W
	Weight	13.67 lbs	
	Dimensions (W x H x D)	16.9 x 6.5 x 14.2 inches	
	Operating temperature range	41°F~+95°F	
	Operating humidity range	10%~75%	
FM TUNER	Frequency response	87.5~108.0MHz	
	Usable sensitivity	12dBf	
	S/N ratio	MONO/STEREO 55/55dB	
	Distortion	MONO/STEREO 0.3/0.8%	
	Stereo separation	30dB	
	Tuner output level	1kHz, 75kHz Dev	
AMPLIFIER	Rated output	20Hz~20kHz/THD = 0.9%	
	Front speaker (left+right)	6 Ω 100W/CH	
	Center speaker	6 Ω 100W/CH	
	Surround speaker (left+right)	6 Ω 100W/CH	
	Subwoofer speaker	6 Ω 100W/CH	
	Input sensitivity/impedance	450mV/47kΩ	
	S/N ratio (analog input)	80dB	
	Separation (1kHz)	60dB	
FREQUENCY RESPONSE	Analog input	20Hz~20kHz(±3dB)	
	Digital input/96kHz PCM	20Hz ~44kHz(±3dB)	
HDMI	Input	Compatible 1080p	
	Output	Compatible 1080p	
VIDEO OUTPUT	TV format	NTSC/PAL	
	Input level/impedance	1Vp-p/75 Ω	
	Output level/impedance	1Vp-p/75 Ω	
	Video frequency response	5Hz to 10kHz(-3dB)	
	S/N Ratio	60dB	

\* S/N Ratio, Distortion, Separation and Usable sensitivity are based on measurement using AES (Audio Engineering Society) guidelines.

- Samsung Electronics Co., Ltd reserves the right to change the specifications without notice.
- Weight and dimensions are approximate.
- Design and specifications are subject to change without prior notice.

# SAMSUNG AV receiver

## LIMITED WARRANTY TO ORIGINAL PURCHASER

This SAMSUNG brand product, as supplied and distributed by Samsung Electronics America, Inc. (SAMSUNG) and delivered new, in the original carton to the original consumer purchaser, is warranted by SAMSUNG against manufacturing defects in materials and workmanship for a limited warranty period of:

**One (1) Year Parts and Labor\***  
(\*90 days Parts and Labor for Commercial Use)

This limited warranty begins on the original date of purchase, and is valid only on products purchased and used in the United States. To receive warranty service, the purchaser must contact SAMSUNG for problem determination and service procedures. Warranty service can only be performed by a SAMSUNG authorized service center. The original dated bill of sale must be presented upon request as proof of purchase to SAMSUNG or SAMSUNG's authorized service center. Transportation of the product to and from the service center is the responsibility of the purchaser.

SAMSUNG will repair or replace this product, at our option and at no charge as stipulated herein, with new or reconditioned parts or products if found to be defective during the limited warranty period specified above. All replaced parts and products become the property of SAMSUNG and must be returned to SAMSUNG. Replacement parts and products assume the remaining original warranty, or ninety (90) days, whichever is longer.

SAMSUNG's obligations with respect to software products distributed by SAMSUNG under the SAMSUNG brand name are set forth in the applicable end user license agreement. Non-SAMSUNG hardware and software products, if provided, are on an "AS IS" basis. Non-SAMSUNG manufacturers, suppliers, publishers, and service providers may provide their own warranties.

This limited warranty covers manufacturing defects in materials and workmanship encountered in normal, and except to the extent otherwise expressly provided for in this statement, noncommercial use of this product, and shall not apply to the following, including, but not limited to: damage which occurs in shipment; delivery and installation; applications and uses for which this product was not intended; altered product or serial numbers; cosmetic damage or exterior finish; accidents, abuse, neglect, fire, water, lightning or other acts of nature; use of products, equipment, systems, utilities, services, parts, supplies, accessories, applications, installations, repairs, external wiring or connectors not supplied and authorized by SAMSUNG, or which damage this product or result in service problems; incorrect electrical line voltage, fluctuations and surges; customer adjustments and failure to follow operating instructions, cleaning, maintenance and environmental instructions that are covered and prescribed in the instruction book; product removal or reinstallation; reception problems and distortion related to noise, echo, interference or other signal transmission and delivery problems. SAMSUNG does not warrant uninterrupted or error-free operation of the product.

THERE ARE NO EXPRESS WARRANTIES OTHER THAN THOSE LISTED AND DESCRIBED ABOVE, AND NO WARRANTIES WHETHER EXPRESS OR IMPLIED, INCLUDING, BUT NOT LIMITED TO, ANY IMPLIED WARRANTIES OF MERCHANTABILITY OR FITNESS FOR A PARTICULAR PURPOSE, SHALL APPLY AFTER THE EXPRESS WARRANTY PERIODS STATED ABOVE, AND NO OTHER EXPRESS WARRANTY OR GUARANTY GIVEN BY ANY PERSON, FIRM OR CORPORATION WITH RESPECT TO THIS PRODUCT SHALL BE BINDING ON SAMSUNG. SAMSUNG SHALL NOT BE LIABLE FOR LOSS OF REVENUE OR PROFITS, FAILURE TO REALIZE SAVINGS OR OTHER BENEFITS, OR ANY OTHER SPECIAL, INCIDENTAL OR CONSEQUENTIAL DAMAGES CAUSED BY THE USE, MISUSE OR INABILITY TO USE THIS PRODUCT, REGARDLESS OF THE LEGAL THEORY ON WHICH THE CLAIM IS BASED, AND EVEN IF SAMSUNG HAS BEEN ADVISED OF THE POSSIBILITY OF SUCH DAMAGES. NOR SHALL RECOVERY OF ANY KIND AGAINST SAMSUNG BE GREATER IN AMOUNT THAN THE PURCHASE PRICE OF THE PRODUCT SOLD BY SAMSUNG AND CAUSING THE ALLEGED DAMAGE. WITHOUT LIMITING THE FOREGOING, PURCHASER ASSUMES ALL RISK AND LIABILITY FOR LOSS, DAMAGE OR INJURY TO PURCHASER AND PURCHASER'S PROPERTY AND TO OTHERS AND THEIR PROPERTY ARISING OUT OF THE USE, MISUSE OR INABILITY TO USE THIS PRODUCT SOLD BY SAMSUNG NOT CAUSED DIRECTLY BY THE NEGLIGENCE OF SAMSUNG. THIS LIMITED WARRANTY SHALL NOT EXTEND TO ANYONE OTHER THAN THE ORIGINAL PURCHASER OF THIS PRODUCT, IS NONTRANSFERABLE AND STATES YOUR EXCLUSIVE REMEDY.

Some states do not allow limitations on how long an implied warranty lasts, or the exclusion or limitation of incidental or consequential damages, so the above limitations or exclusions may not apply to you. This warranty gives you specific legal rights, and you may also have other rights which vary from state to state.

To obtain warranty hardware service, please contact SAMSUNG at:

Samsung Electronics America, Inc.  
105 Challenger Road Ridgefield Park, NJ07660-0511  
1-800-SAMSUNG(726-7864) and [www.samsung.com](http://www.samsung.com)

## Contact SAMSUNG WORLD WIDE

If you have any questions or comments relating to Samsung products, please contact the SAMSUNG customer care center.

Area	Contact Center ☎	Web Site
<b>■ North America</b>		
Canada	1-800-SAMSUNG (726-7864)	www.samsung.com
Mexico	01-800-SAMSUNG (726-7864)	www.samsung.com
U.S.A	1-800-SAMSUNG (726-7864)	www.samsung.com
<b>■ Latin America</b>		
Argentina	0800-333-3733	www.samsung.com
Brazil	0800-124-421 / 4004-0000	www.samsung.com
Chile	800-SAMSUNG (726-7864)	www.samsung.com
Colombia	01-8000112112	www.samsung.com
Costa Rica	0-800-507-7267	www.samsung.com
Dominica	1-800-751-2676	www.samsung.com
Ecuador	1-800-10-7267	www.samsung.com
El Salvador	800-6225	www.samsung.com
Guatemala	1-800-299-0013	www.samsung.com
Honduras	800-7919267	www.samsung.com
Jamaica	1-800-234-7267	www.samsung.com
Nicaragua	00-1800-5077267	www.samsung.com
Panama	800-7267	www.samsung.com
Peru	0-800-777-08	www.samsung.com
Puerto Rico	1-800-682-3180	www.samsung.com
Trinidad & Tobago	1-800-SAMSUNG (726-7864)	www.samsung.com
Venezuela	0-800-100-5303	www.samsung.com
<b>■ Europe</b>		
Albania	42 27 5755	-
Austria	0810 - SAMSUNG (7267864, € 0.07/min)	www.samsung.com
Belgium	02-201-24-18	www.samsung.com/ be (Dutch) www.samsung.com/ be_fr (French)
Bosnia	05 133 1999	-
Bulgaria	07001 33 11	www.samsung.com
Croatia	062 SAMSUNG (062 726 7864)	www.samsung.com
Czech	800-SAMSUNG (800-726786) Samsung Zrt., česká organizační složka, Oasis Florenc, Soko- lovská394/17, 180 00, Praha 8	www.samsung.com
Denmark	70 70 19 70	www.samsung.com
Finland	030 - 6227 515	www.samsung.com
France	01 48 63 00 00	www.samsung.com
Germany	01805 - SAMSUNG (726-7864 € 0,14/Min)	www.samsung.com
Hungary	06-90-SAMSUNG (726-7864)	www.samsung.com
Italy	800-SAMSUNG (726-7864)	www.samsung.com
Kosovo	+381 0113216899	-
Luxemburg	261 03 710	www.samsung.com
Macedonia	023 207 777	-
Montenegro	020 405 888	-
Netherlands	0900-SAMSUNG (0900-7267864) (€ 0,10/Min)	www.samsung.com
Norway	815-56 480	www.samsung.com
Poland	0 801 1SAMSUNG (172678) / 022-607-93-33	www.samsung.com
Portugal	80820-SAMSUNG (726-7864)	www.samsung.com
Rumania	1. 08010 REȘEAUA (72678) - doar din rețeaua Romtelecom, tarif local 2. 021.206.01.10 - din orice rețea, tarif normal	www.samsung.com

Area	Contact Center ☎	Web Site
Serbia	0700 Samsung (0700 726 7864)	www.samsung.com
Slovakia	0800-SAMSUNG (726-7864)	www.samsung.com
Spain	902-1-SAMSUNG (902 172 678)	www.samsung.com
Sweden	0771 726 7864 (SAMSUNG)	www.samsung.com
Switzerland	0848-SAMSUNG (7267864, CHF 0.08/min)	www.samsung.com/ch www.samsung.com/ ch_fr(French)
U.K	0330 SAMSUNG (7267864)	www.samsung.com
Eire	0818 717100	www.samsung.com
Lithuania	8-800-77777	www.samsung.com
Latvia	8000-7267	www.samsung.com
Estonia	800-7267	www.samsung.com
<b>■ CIS</b>		
Russia	8-800-555-55-55	www.samsung.com
Georgia	8-800-555-555	-
Armenia	0-800-05-555	-
Azerbaijan	088-55-55-555	-
Kazakhstan	8-10-800-500-55-500 (GSM: 7799)	www.samsung.com
Uzbekistan	8-10-800-500-55-500	www.samsung.com
Kyrgyzstan	00-800-500-55-500	www.samsung.com
Tadjikistan	8-10-800-500-55-500	www.samsung.com
Ukraine	0-800-502-000	www.samsung.ua www.samsung.com/ ua_ru
Belarus	810-800-500-55-500	-
Moldova	00-800-500-55-500	-
<b>■ Asia Pacific</b>		
Australia	1300 362 603	www.samsung.com
New Zealand	0800 SAMSUNG (0800 726 786)	www.samsung.com
China	400-810-5858 / 010-6475 1880	www.samsung.com
Hong Kong	(852) 3698 4698	www.samsung.com/hk www.samsung.com/ hk_en/
India	3030 8282 / 1800 110011 / 1800 3000 8282 / 1800 266 8282	www.samsung.com
Indonesia	0800-112-8888 / 021-5699-7777	www.samsung.com
Japan	0120-327-527	www.samsung.com
Malaysia	1800-88-9999	www.samsung.com
Philippines	1-800-10-SAMSUNG(726-7864) / 1-800-3-SAMSUNG(726-7864) / 1-800-8-SAMSUNG(726-7864) / 02-5806777	www.samsung.com
Singapore	1800-SAMSUNG (726-7864)	www.samsung.com
Thailand	1800-29-3232 / 02-689-3232	www.samsung.com
Taiwan	0800-329-999	www.samsung.com
Vietnam	1 800 588 889	www.samsung.com
<b>■ Middle East</b>		
Bahrain	8000-4726	www.samsung.com
Egypt	08000-726786	www.samsung.com
Jordan	800-22273	www.samsung.com
Morocco	080 100 2255	www.samsung.com
Oman	800-SAMSUNG (726-7864)	www.samsung.com
Saudi Arabia	9200-21230	www.samsung.com
Turkey	444 77 11	www.samsung.com
U.A.E	800-SAMSUNG (726-7864)	www.samsung.com
<b>■ Africa</b>		
Nigeria	0800-SAMSUNG (726-7864)	www.samsung.com
South Africa	0860-SAMSUNG (726-7864)	www.samsung.com



QUESTIONS OR COMMENTS?

COUNTRY	CALL	OR VISIT US ONLINE AT	WRITE
IN THE US	1-800-SAMSUNG (7267864)	<a href="http://www.samsung.com/us">www.samsung.com/us</a>	Samsung Electronics America, Inc. 85 Challenger Road Ridgefield Park, NJ 07660-2112

Code No. AH68-02354V