



# REFRIGERATOR

RB195ZABB RB195ZASW

RB195ZASH RB195ZAVQ

RB215ZABB RB215ZASW

RB215ZASH RB215ZAVQ

## OWNER'S MANUAL

In the U.S. for questions about features,  
operation/performance, parts, accessories or service, call:

**1-800-726-7864 (1-800-SAMSUNG)**

[www.samsung.com](http://www.samsung.com)

Register your product at [www.samsung.com/global/register](http://www.samsung.com/global/register)

DA99-00926D REV(0.0)

# FEATURES

## High-energy efficiency with twin cooling system

- Optimized power consumption with twin cooling system.

## Humidity controlled drawers

- This is suitable for storing dry or wrapped food (e.g. fresh salads, vegetables and fruit).

## Fridge at the top, drawer-type freezer at the bottom

- The highly ergonomic humidity controlled drawers are placed at the waist height for frequent use.
- The drawer-type freezer minimizes temperature variations and stores food cleanly and conveniently.

## Digital temperature control display

- The display shows all functions of the appliance, allowing easy control.
- Fridge and freezer temperatures can be adjusted separately.

## Super Freeze

- Speeds up the freezing process in the freezer.

## Super Cool

- Speeds up the cooling process in the fridge.

## Door alarm

- When the refrigerator door is left open for more than two minutes, a musical alarm is automatically triggered. This feature helps you save electricity and preserve stored foods as a reminder to close the door.

## Automatic defrosting in fridge/freezer

These operating instructions cover various models. The characteristics of your appliance may differ slightly from those described in this manual.

# CONTENTS

FEATURES .....	2
WARNINGS / SAFETY PRECAUTIONS .....	3
INSTALLING THE FRIDGE / FREEZER .....	5
PREPARING THE FRIDGE / FREEZER .....	6
VIEW OF YOUR FRIDGE / FREEZER .....	6
USING THE CONTROL FEATURES .....	7
CONTROLLING THE FREEZER AND FRIDGE TEMPERATURES .....	8
STORING FOOD IN THE FRIDGE OR FREEZER .....	9
ICE STORAGE BIN .....	10
REMOVING AND CLEANING ACCESSORIES .....	11
REPLACING INTERIOR LIGHTS .....	12
INSTALLATION OF THE WATER LINE .....	13
REVERSING THE DOOR SWING .....	14
PROBLEMS AND SOLUTIONS .....	19
USAGE PRECAUTIONS .....	19

# WARNINGS / SAFETY PRECAUTIONS

To avoid any risk of personal injury, material damage or incorrect use of the appliance, be sure to observe the following safety precautions. (After reading these owner's instructions, please keep them in a safe place for reference.) Remember to hand them over to any subsequent owner.



## Warning

Indicates that a danger of death or serious injury exists.



## Caution

Indicates that a risk of personal injury or material damage exists.



## Warning

### Warning

**Do not plug several appliances into the same socket.**

- This could cause overheating and the risk of fire.

**Keep the power plug away from the rear of the fridge/freezer.**

- A damaged power plug may cause fire due to overheating.

**Do not directly spray water inside or outside the fridge/freezer.**

- There is a risk of fire or electric shock.

**Do not spray inflammable gas near the fridge/freezer.**

- There is a risk of explosion or fire.

**Do not bend the power cord excessively or place heavy articles on it.**

- This constitutes a fire hazard. If the power cord is damaged, have it replaced immediately by the manufacturer or its service agent.

**Do not insert the power plug with wet hands.**

- You may receive an electric shock.

**Do not put a container filled with liquid on top of the appliance.**

- If the water spills on to any electrical parts, it may lead to fire or electric shock.

**Do not install the fridge/freezer in a damp place, where it may come into contact with water.**

- Incorrect insulation of the electrical parts may cause an electric shock or fire.

**Do not store volatile and inflammable substances in the refrigerator.**

- The storage of benzene, thinner, alcohol, ether, LP gas or other such substances may cause an explosion.

**Do not disassemble, repair or alter the appliance.**

- It may cause fire or abnormal operation, which may lead to injury.

**Pull the power plug out of the socket before replacing the interior light in the refrigerator.**

- Otherwise, there is a risk of electric shock.

**Be sure to ground the appliance.**

- Otherwise, it may cause material damage or electric shock.

**If you wish to dispose of the fridge/freezer, throw it away after removing the door or its seals.**

- In this way, it is not possible for a child to remain trapped inside it.
- Keep ventilation openings in the appliance enclosure or mounting structure clear of obstruction.
- Do not use mechanical devices or any other means to accelerate the defrosting process, other than those recommended by the manufacturer.
- Do not damage the refrigerant circuit.
- Do not use electrical appliances inside the fridge/freezer, unless they are of a type recommended by the manufacturer.

**The appliance must be positioned so that the plug is accessible after installation.**

**The gases in the insulation material required special disposal procedure.**

### Service warranty section

- Any changes or modifications performed by a 3rd party on a finished product is not covered under Samsung warranty service

### Safety Caution section

- Samsung does not recommend 3rd party modification, therefore Samsung is not responsible for safety issues that result from 3rd party modifications.

# WARNINGS / SAFETY PRECAUTIONS



## Caution

### **Do not store too much food in the appliance.**

- When you open the door, an item may fall out and cause personal injury or material damage.

### **Do not put bottles or any kinds of glass in the freezer.**

- The container may break and cause personal injury.

### **If the wall socket is loose, do not insert the power plug.**

- It could be cause electric shock or fire.

### **Do not disconnect the power cord by pulling on it.**

- You may disconnect a wire and cause a short circuit.

### **Do not store articles on top of the appliance.**

- When you open or close the door, the articles may fall and cause personal injury or material damage.

### **Do not store pharmaceutical products, scientific materials or other temperature-sensitive products in the refrigerator.**

- Products that require strict temperature controls must not be stored in the refrigerator.

### **Do not let a child hang from the door.**

### **Do not allow children to climb, stand or hang on the shelves in the refrigerator.**

- They could damage the refrigerator and seriously injure themselves.

### **Allow an adequate space and install the fridge/freezer on a firm, level floor.**

- If the appliance is not level, there may be unusual noises and poor cooling.
- Wait for at least one hour before plugging the appliance in.

### **Clean the fridge/freezer.**

- Wipe and clean the appliance inside and outside with a damp cloth and dry completely.

### **Plug the fridge/freezer into a wall socket used exclusively by this appliance.**

- This appliance must be properly grounded.

### **Do not store pharmaceutical products, scientific materials or other temperature-sensitive products in the refrigerator.**

- Products that require strict temperature controls must not be stored in the refrigerator.

### **Do not touch any containers or food in the freezer with wet hands.**

- It may cause frostbite.

### **Remove any foreign matter or dust from the power plug pins.**

- Otherwise there is a risk of fire.

### **Do not insert your hand into the bottom area of the appliance.**

- Any sharp edges may cause personal injury.

### **After unplugging the appliance, wait for at least five minutes before plugging it in again to the wall socket.**

- Abnormal operation of the freezer may cause material damage.

### **If the appliance is not to be used for a long period of time, pull out the power plug.**

- Any deterioration in the insulation may cause fire.

### **Do not let children touch or play with the control panel on the front of the appliance.**

- Do not stand or lean on the base panel, pull-out parts, doors etc..
- Repairs and maintenance of the appliance should only be performed by a qualified technician. Incorrect repairs by an unqualified person are a potential source of danger that may have critical consequences for the user of the appliance.
- Never put ice cubes or ice pops straight from the freezer into your mouth. (The low temperature may cause "freezer burns".)

### **Do not place the equipment directly under the sunlight, etc.**

### **The refrigerator must be grounded.**

- You must ground the refrigerator to prevent any power leakages or electric shocks caused by current leakage from the refrigerator.

### **Never use gas pipes, telephone lines or other potential lightning rods as ground.**

- Improper use of the ground plug can result in a risk of electric shock. If it is necessary to use an extension cord, use only a 3-wire extension cord that has a 3-blade ground plug and a 3-slot receptacle that will accept the plug on the appliance. The marked rating of the extension cord should be AC 115V~120V, 10A, or more. If a grounding adapter is used, make sure the receptacle box is fully grounded.

# INSTALLING THE FRIDGE / FREEZER

- 1** Allow adequate space and install the fridge/freezer on a firm, level floor.
- If the appliance is not level, there may be unusual noises and poor cooling.
  - Wait for at least one hour before plugging the appliance in.

- 2** Clean the fridge/freezer.
- Wipe and clean the appliance inside and outside with a damp cloth and dry completely.

- 3** Plug the fridge/freezer into a wall socket used exclusively by this appliance.
- This appliance must be properly grounded.

- 4** Place the food in the fridge/freezer.
- It is recommended that you wait for the appliance to cool for 2-3 hours before storing food in it.



## Warning

### Use of a grounded socket exclusively for the appliance:

- If you are using a socket with a grounded terminal, you do not require a separate grounding connection.

### Use of a non-grounded socket:

- Connect the "grounding wire" to the copper plate and bury it at a depth of at least 10 inches in the ground.

### The appliance must be positioned so that the plug is accessible after installation.

When installing the refrigerator, you should provide a clearance of at least 2 inches at the back, top and 1 inch from the sides of the refrigerator.

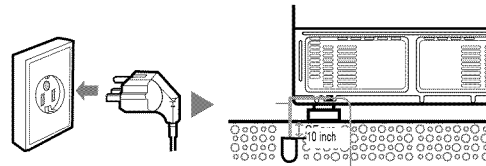

### Change of the door direction is possible.

- If you want to change the door direction, call 1-800-SAMSUNG.

### Note

If you want to connect the refrigerator to your water supply, call 1-800-SAMSUNG.



## LEVELLING

If the front of the appliance is slightly higher than the rear, the door can be opened and closed easier.

- 1** The appliance tilts down to the left.
- Turn the left adjusting leg in the direction of the arrow with a flat head screwdriver until the appliance is level.

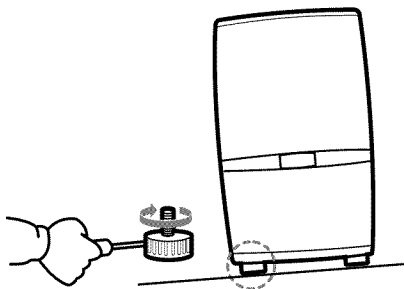

- 2** The appliance tilts down to the right.
- Turn the right adjusting leg in the direction of the arrow with a flat head screwdriver until the appliance is level.

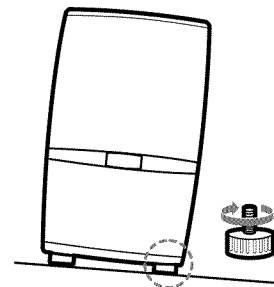

# PREPARING THE FRIDGE / FREEZER

To prepare your appliance for use and check that it is running correctly, take the following steps.

**1** Install all shelves and compartments removed during transport and place them in the correct position.

**2** You are advised to clean the appliance and accessories before switching the appliance on for the first time to remove any dust that accumulated during packing and shipping.

**3** Switch on the appliance for approximately 2 hours before loading it with frozen food for the first time. Do not load with frozen food until the freezer temperature is at least 0°F. If you want to store frozen food as soon as possible, set the temperature control to the coldest temperature (-14°F) and let the appliance operate for one hour. The appliance is preset for normal operation. We recommend temperatures of 38°F in the fridge and -2°F in the freezer.

**4** The interior light of the appliance will light up when the door is open. This interior light will go out when the door is closed.

**5** Your appliance is operated by a compressor which switches “on and off” to maintain the internal temperature. When the compressor is new, it requires running for a period of up to five months. During this period, it may be slightly noisy. This is quite normal and does not represent a fault.

**6** Store food once the temperature in the refrigerator is sufficiently low. It takes a few hours after starting the refrigerator to reach the proper temperature. If the appliance does not operate correctly, check the electricity supply. If the problem persists, contact your dealer.

# VIEW OF YOUR FRIDGE / FREEZER

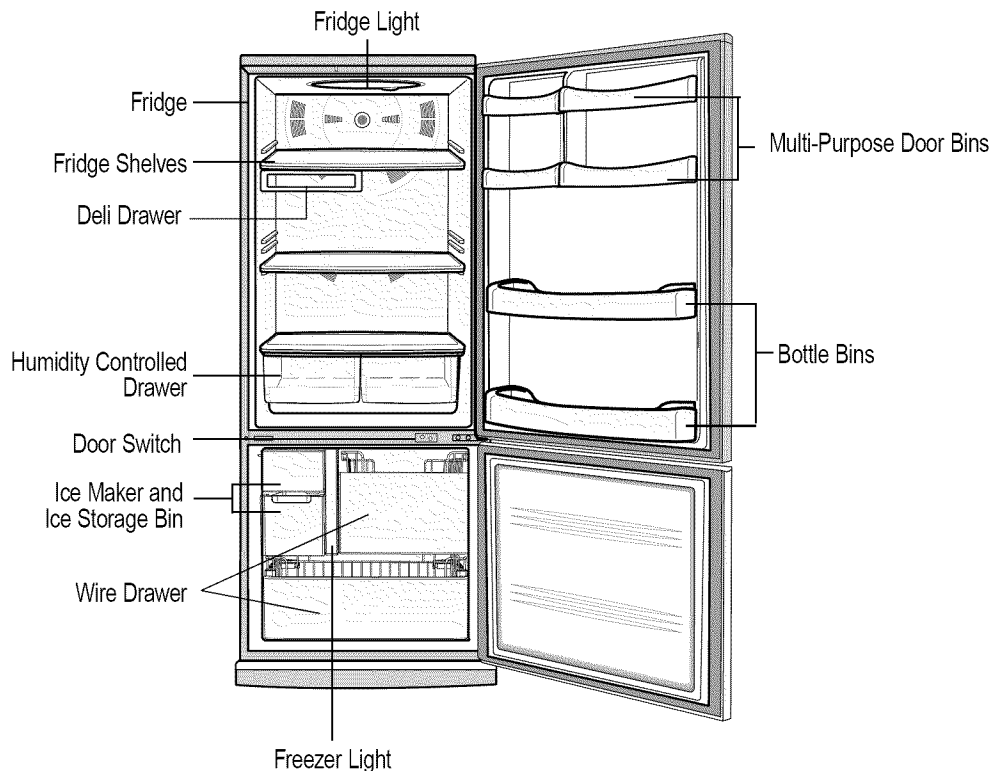

# USING THE CONTROL FEATURES

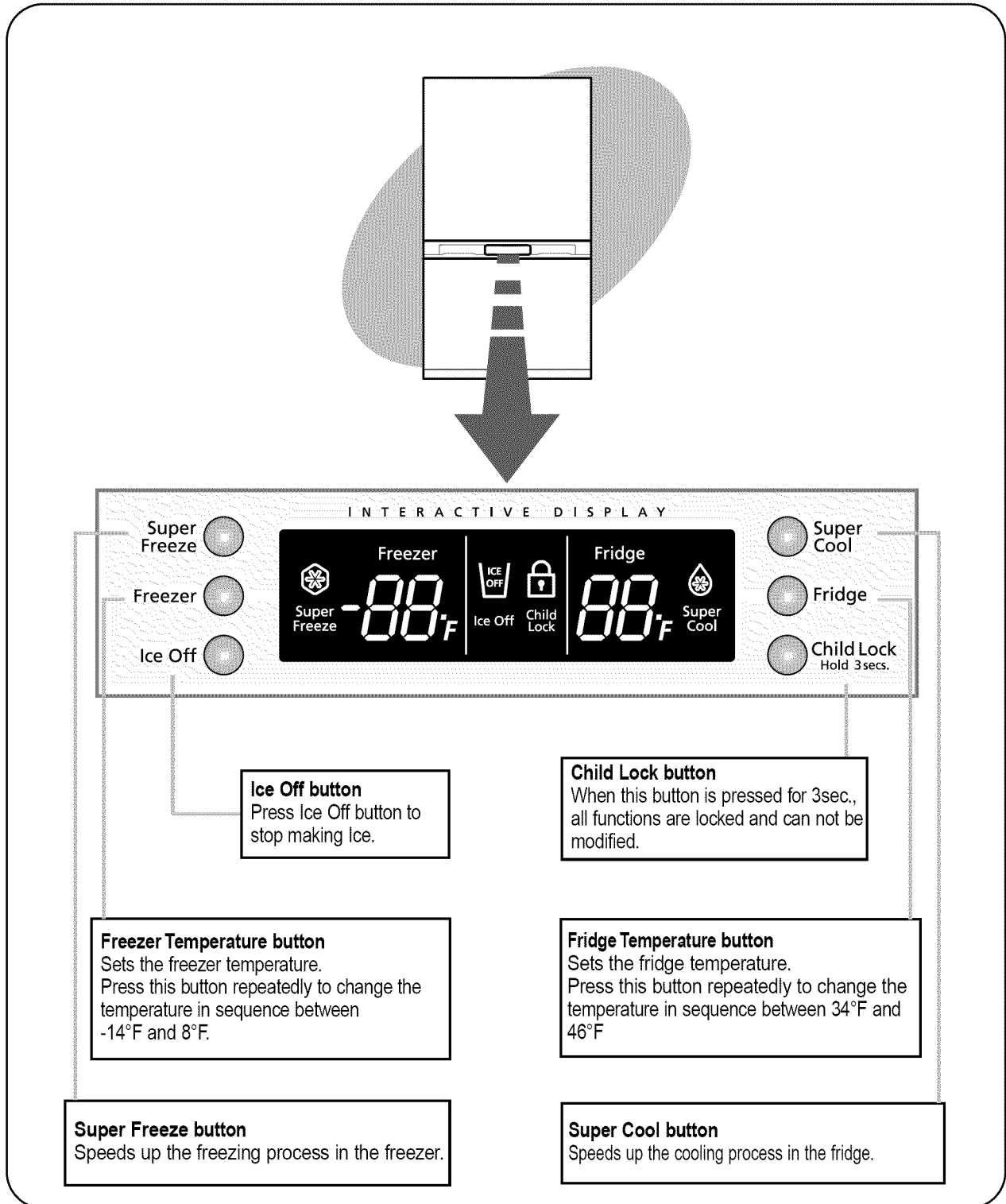

# CONTROLLING THE FREEZER AND FRIDGE TEMPERATURES

## Freezer

- The freezer can be set to a temperature between -14°F and 8°F.
- Press the **Freezer** button **repeatedly** until the desired temperature is shown in the temperature display.
- The temperature display changes in sequence between -14°F and 8°F. When the display reaches -14°F, it returns to 8°F.
- After five seconds, the display reverts to the average freezer temperature, which changes as the freezer reaches the new temperature.

## Fridge

- The fridge can be set to a temperature between 34°F and 46°F.
- Press the **Fridge** button **repeatedly** until the desired temperature is shown in the temperature display.
- The temperature display changes in sequence and reverts to the average temperature in the same way as the freezer.



### Temperature Display

Displays the current and selected freezer temperatures.

### Freezer Display

Indicates that you are setting the freezer temperature or have opened the freezer door.

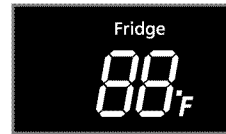

### Temperature Display

Displays the current and selected fridge temperatures.

### Fridge Display

Indicates that you are setting the fridge temperature or have opened the fridge door.



## INDICATORS

### Super Freeze



- This light goes on when you press the Super Freeze button.
- Press this button to quickly return the freezer to its set temperature.
- This feature is useful if the freezer door has been left open for a long time.
- Press this button again to cancel the Super Freeze mode.
- Press this button to make ice quicker.

### Super Cool



- This light goes on when you press the Super Cool button.
- Press this button to quickly return the fridge to its set temperature.
- This feature is useful if the fridge door has been left open for a long time.
- Press this button again to cancel the Super Cool mode.

### Temperature display

- The temperatures displayed for the freezer and fridge are the actual temperatures of each compartment.
- There may be a slight difference between the set temperature and the actual temperature.

### Ice Off



- Press Ice off button to stop making ice.
- If you don't want to make ice, press the Ice Off button. The "Ice Off" indicator will turn on and ice making is stopped.



# STORING FOOD IN THE FRIDGE OR FREEZER

When storing food in the appliance, follow the recommendations below.

- Allow warm food and beverages to cool down before storing them in the appliance.
- Ensure that food is well-wrapped or covered before it is stored. This will prevent food from dehydrating, deteriorating in color or losing flavor and will help maintain freshness. Fruits and vegetables do not need to be wrapped, provided that they are stored in the fridge vegetable drawers.
- Avoid wrapping the food with paper as it may cause odors. We recommend plastic wrap or foil.
- Never let any oil or grease come into contact with the plastic fittings or door seals, as these materials easily become porous.
- Never store any explosive substances inside the appliance. High-proof alcohol should only be stored upright in tightly sealed containers.
- Please keep the space between the shelf and the rear wall of the enclosed space of the cabinet a 1/2 inch apart for air circulation.

## A. Fridge

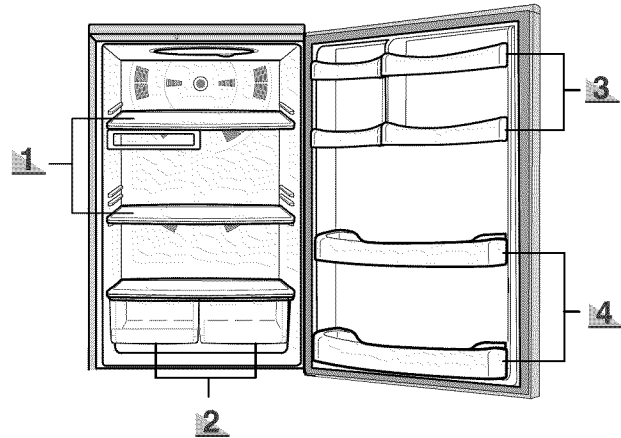

1

### Transparent, unbreakable shelves

- Place food in storage containers and lay the items out at suitable intervals.
- The storage shelf is made from an unbreakable, transparent material, so that you can safely use it .

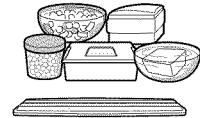

2

### Humidity controlled drawers

- Fruit and Vegetables can be stored in these compartments.
- The drawers can be removed if you need more space to store fruit and vegetables.
- To maintain high humidity, slide the humidity control lever to the "HIGH" side.

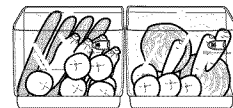

3

### Multi-purpose door guard and egg bin

- The fridge is the warmest in the front, at the top and in the door.
- You can store small packaged foods, like milk, yogurt and beverages here.

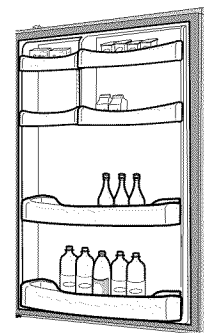

4

### Bottle door guard

- You can store small bottles, cartons of beer, milk and juice in the upper area and large bottles and gallon cartons in the lower area.

# STORING FOOD IN THE FRIDGE OR FREEZER

## Freezer drawer

- You can store packed frozen foods, like ice cream and bacon.
- You can store meat and fish or dried foods divided into suitably sized portions.
- Can be used to store meat and dry foods. Stored food should be wrapped securely using foil or other suitable wrapping materials or containers.



## Note

### Wrapping food

Pack the food in suitably sized portions for your household.

Vegetable and fruit portions should be no heavier than 2 pounds, while meat portions can be up to 5.5 lbs.

Smaller portions freeze quickly and the quality is better maintained when defrosting and preparing the food.

It is important to seal food in airtight bags or containers before freezing to prevent it from losing its taste or dehydrating. Wrap the food, then press out any air and seal it airtight.

### Suitable wrapping materials:

Plastic bags, cling-film, aluminium foil and freezer containers.

### Unsuitable wrapping materials:

Wrapping paper, wax paper, cellophane, bin bags or used carrier bags.

These can cause odors.

### Suitable sealing materials:

Rubber bands, plastic clips, string, freezer tape or similar.

Plastic film and bags may be heat-sealed using a special sealing iron or press.

**Before placing a package in the freezer, it should be clearly labelled with the contents and the date of freezing.**

## B. Freezer

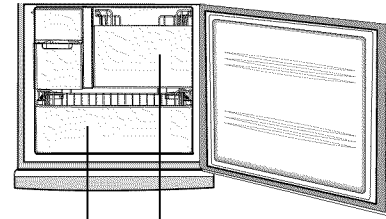

Upper freezer drawer

Lower freezer drawer



## Danger of explosion

## Warning

- Glass bottles containing liquids that can freeze should never be stored in the freezer as the glass will explode.

# ICE MAKER

The ice maker will produce 8 cubes per cycle – approximately 100~130 cubes in a 24-hour period, depending on freezer compartment temperature, room temperature, number of door openings and other use conditions.

Throw away the first few batches of ice to allow the water line to clear.

Be sure nothing interferes with the sweep of the feeler arm.

When the bin fills to the level of the feeler arm, the icemaker will stop producing ice.

After the icemaker has been turned on again, there will be a time delay before the icemaker resumes operations.

It is normal for several cubes to be joined together.

If ice is not used frequently, old ice cubes will become cloudy, taste stale and shrink. So if you don't want to make ice, press the Ice Off button.

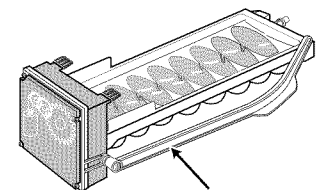

Feeler Arm



## Note

- The refrigerator can only use ice makers which are made by Samsung Electronics.
- The ice-maker can only be installed by Samsung or its service agent.

# REMOVING AND CLEANING ACCESSORIES

Before cleaning the appliance, you must always switch it off and unplug it from the wall socket.

Do not use a steam cleaner. Hot steam could mar the surface of the appliance or the electrical components, with a risk of electric shock.

**1**

## Ice storage bin

- Place a hand in the lower groove, then pull the ice storage bin forward.
- Remove the ice storage bin and rinse it in water and then dry completely.

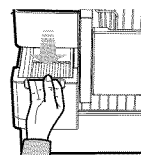

**2**

## Humidity controlled drawers

- Pull the high-humidity salad drawer out as far as it will go, then remove it by lifting it slightly up and pulling it towards you.
- Wipe it with a damp cloth and then dry completely.

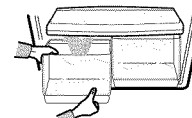

**3**

## Door bins

- Hold the door bin in both hands, then remove it by lifting it up slightly and pulling it towards you.
- Wash it in water and then dry completely.

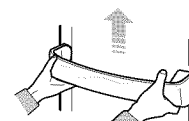

**4**

## Freezer drawers

- Holding the freezer drawer in both hands, pull it out as far as it will go, then remove it by lifting it up slightly and pulling it towards you.
- Wipe it with a damp cloth and dry completely.

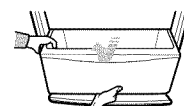

**5**

## Transparent, unbreakable shelves

- Remove the shelf, clean it using water and detergent and then dry it completely.
- When replacing the shelves, do not mix up the top, middle and bottom shelves.

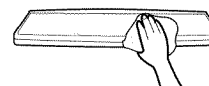

**6**

## Rubber seal

- Clean the rubber seals with a damp cloth and detergent. Use a wooden skewer wrapped in a small cloth to clean in the grooves.

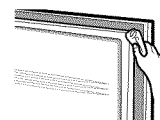

# REPLACING INTERIOR LIGHTS



## FRIDGE LIGHT BULB



**Warning** Always unplug the appliance from the power supply first before replacing the fridge light. Otherwise, there is the danger of electric shock.

- 1** Unscrew the cover with a Philips-head screwdriver.
- 2** - Incandescent light
  - Turn the interior light to remove and replace it with a new one.
  - 30 watt light bulb with E17 base socket
- 3** Screw the cover back on.

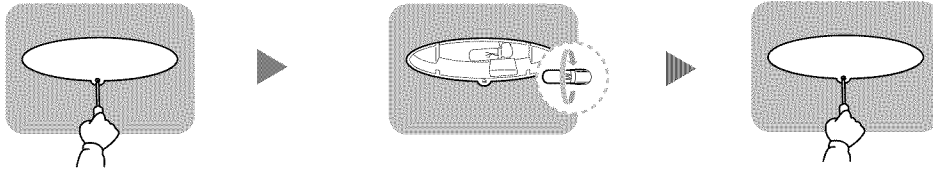

## FREEZER LIGHT BULB

- 1** Raise the hanging sill under the light bulb cover upward by pressing on it and pulling it towards you.
- 2** After removing the light bulb, replace it with a new bulb by turning it in the direction of the arrow.
  - The new bulb's watt and voltage must be the same as stated on the type plate.
  - 15 watt light bulb with E17 base socket
- 3** Insert the lower hanging sill after fitting the upper part of the light bulb cover.



### Note

Replacement bulbs for both the freezer and refrigerator are available at retail outlets such as Wal-mart, The Home Depot and Lowe's.  
Use replacement bulb size E17, maximum 30 watt in refrigerator or 15 watt in freezer.

# INSTALLATION OF THE WATER DISPENSER LINE



## Before You Install the water line

- This water line installation is not warranted by the refrigerator or icemaker manufacturer. Follow these instructions carefully to minimize the risk of expensive water damage.
- Banging pipes (water banging in the pipes) in house plumbing can cause damage to refrigerator parts and lead to water leakage or flooding. Call a qualified plumber to correct the problem before installing the water supply line to the refrigerator.
- To prevent burns and product damage, do not hook up the water line to the hot water line.
- Do not install the icemaker tubing in areas where temperatures fall below freezing.
- When using any electrical device (such as a power drill) during installation, be sure the device is insulated or wired in a manner to prevent electric shock.
- All installations must be in accordance with local plumbing code requirements.



### NOTE

- Water line Kit and water filter are not covered by Samsung Warranty and manufacturer (or dealer, installer) of them should be responsible for the defect and all the loss caused by water filter & water line kit.
- Filter should be replaced according to manufacturer (or dealer)'s instruction.
- To order additional water filters, please contact the manufacturer (or dealer) of the filter.



## Connecting to water supply line

- Shut off the main water supply line and turn the Ice maker to the off position.
- Locate the nearest cold drinking water line.
- Follow the instructions in the ice maker installation kit.
- After connecting the water supply with water filter, turn on water supply and flush 4 or more gallons into a bucket to clear the water filter.

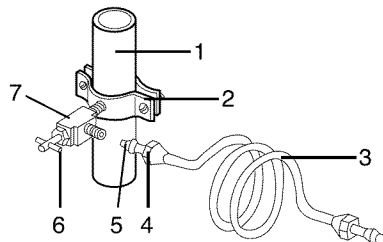

1. Cold Water line
2. Pipe Clamp.
3. Copper (or Plastic) line
4. Compression Nut
5. Compression Sleeve
6. Shut Off Valve
7. Packing Nut.



## Connect the water line to the refrigerator

- Slip the compression nut through the plastic tube.
- After inserting the compression nut into plastic tube, tighten the compression nut onto 1/4" compression fitting (union).



### NOTE

- Do not overtighten the compression nut.

- Slip the compression ferrule and nut on copper (or plastic) tubing as shown.
- After inserting the sleeve, tighten the compression nut onto the compression fitting (union).
- Turn water on and check for any leakage.

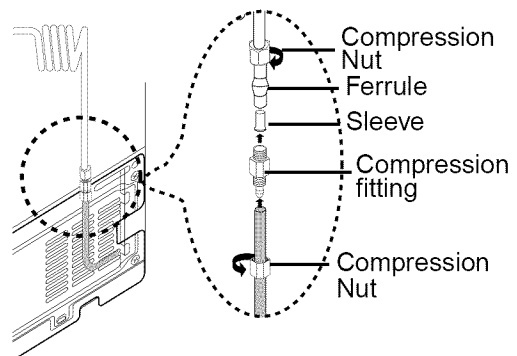

### NOTE

- You can purchase the necessary parts through retail outlets such as Wal-nart, The Home Depot and Lowe's
- Waterline must be connected to drinkable water only
- Compression fitting and nut will be given inside of ice bucket.

# REVERSING THE DOOR SWING

Read these instructions completely and carefully

## - IMPORTANT NOTES



### Warning

Unplug the refrigerator from its electrical outlet.  
Empty all door guards / racks.

1. If you want to change the door direction, call 1-800-SAMSUNG.
2. Read the instructions carefully before starting.
3. Handle parts carefully to avoid scratching paint.
4. Set screws down by their related parts to avoid using them in the wrong places.
5. Provide a non-scratching work surface for the doors. (ex : blanket)
6. During door reversing, refrigerator should not be stained with oil.

## - TOOLS YOU WILL NEED

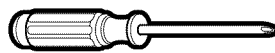

Philips head screwdriver



7/16" inch wrench

## - ADDITIONAL PARTS

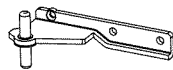

Middle hinge



Screw

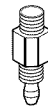

Compression Fitting



Compression Nut

## - DISASSEMBLY OF THE FRIDGE DOOR

1. After removing the screw, disassemble the Upper Right Hinge Cover.

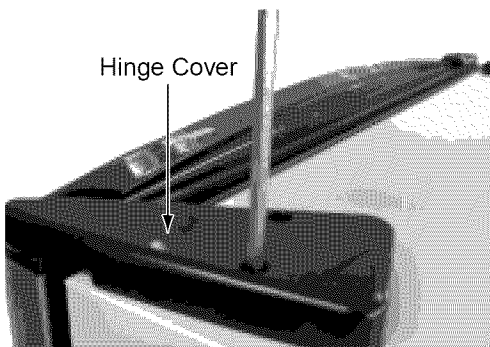

2. Disconnect electric wire on the top of the refrigerator.

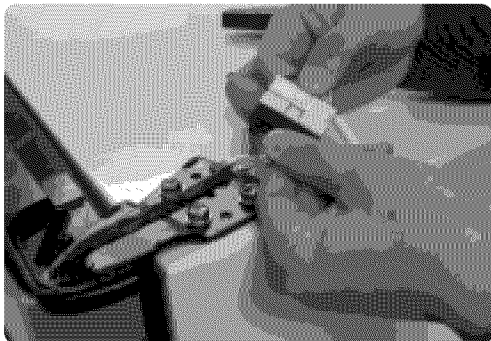

3. With the 7/16 inch wrench, remove the four bolts that hold the top of the refrigerator.



4. Separate Hinge from electric wire as shown below.



## REVERSING THE DOOR SWING

Read these instructions completely and carefully

5. Disassemble the fridge door by lifting it upward.  
Be careful not to drop and scratch the fridge door.

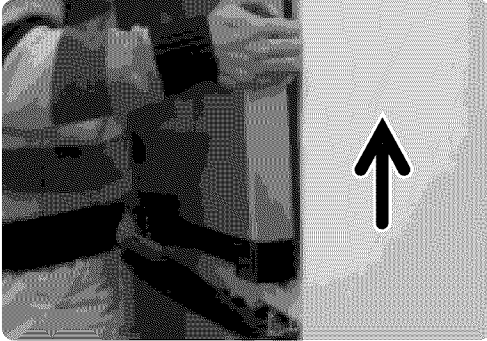

### - DISASSEMBLY OF THE FREEZER DOOR

6. After removing the screw and two bolts, disassemble Middle Hinge.

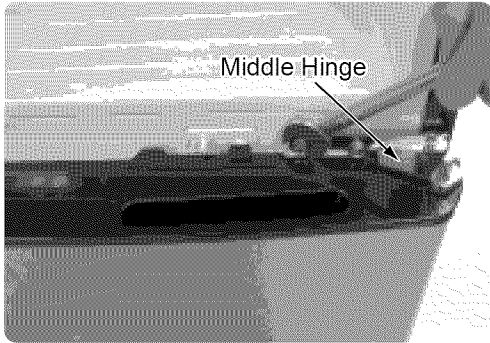

7. Disassemble the Freezer Door by lifting it upward.  
Be careful not to drop and scratch the Freezer door.

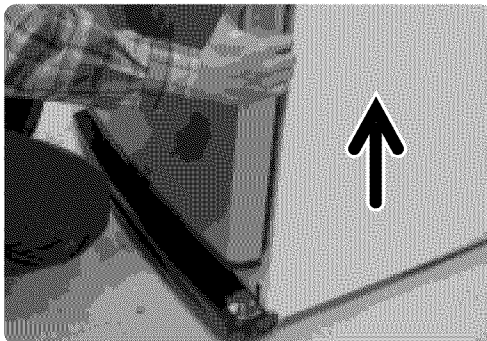

### - ASSEMBLY OF THE FREEZER DOOR

8. After removing the screw, disassemble the Hinge Cover(left) and the Hinge(right).

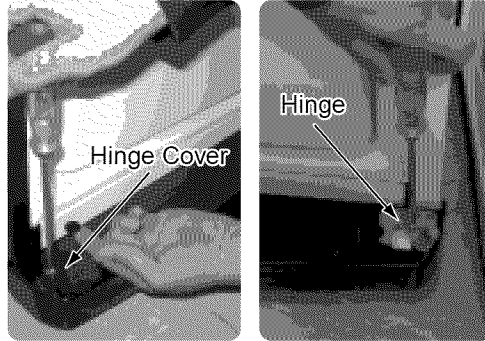

9. Move the hardware found on the right side of the cabinet to the left and vice-versa.

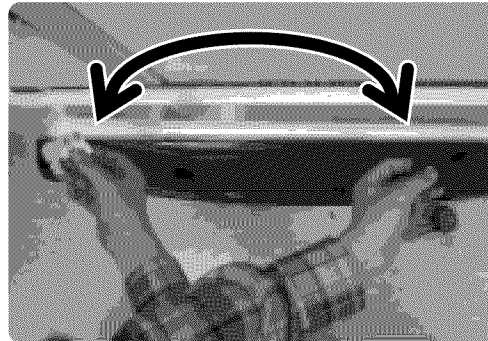

10. After removing the left and right side screws, disassemble the Grommet, Door Stopper and Middle Stopper from the bottom right of the freezer-door.

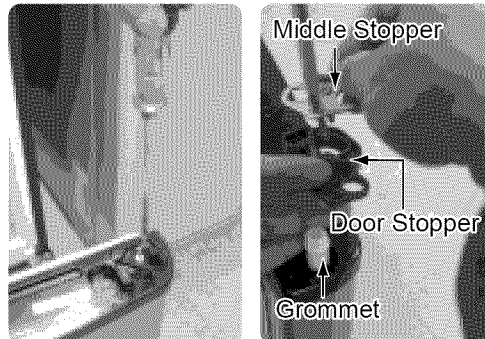

# REVERSING THE DOOR SWING

Read these instructions completely and carefully

11. Move the hardware found on the right side of the door to the left and vice-versa.

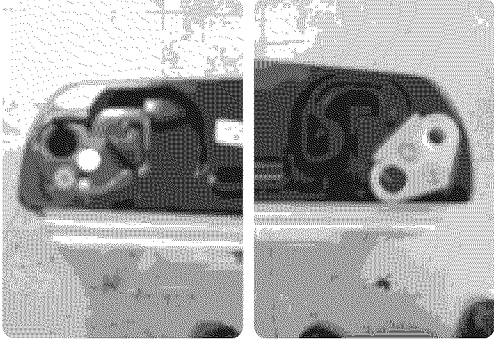

12. Disassemble the switch by gently prying from the corner. Be careful not to scratch.

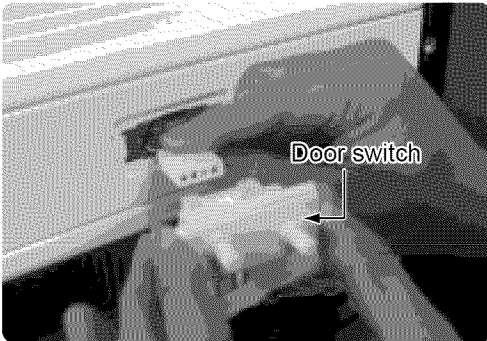

13. Disassemble the Door Cap, Sleeve and the screws.

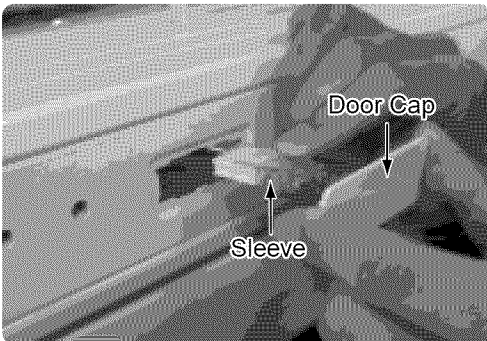

14. Re-install parts in their opposing sides. Assemble the Door S/W as it is. (Make sure not to insert it upside down)

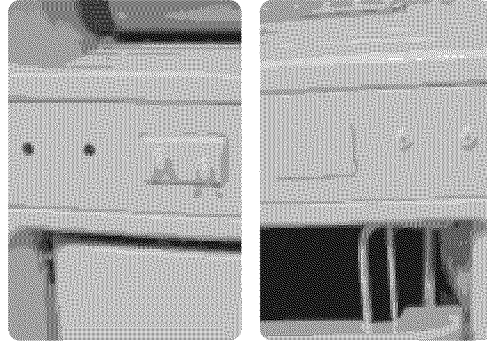

15. Assemble Freezer Door by fitting the lower hinge into the hinge grommet hole. Be sure to grease the washer.

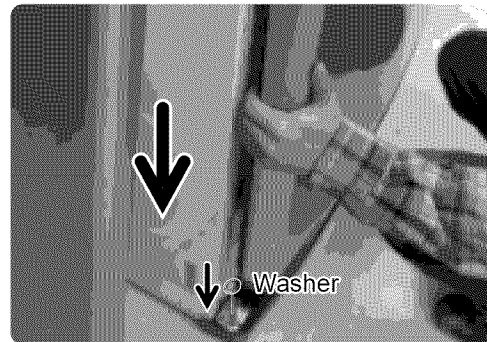

16. Fix the Alternate Middle Hinge into the door hole.

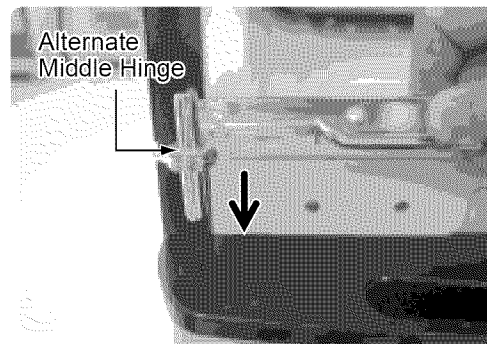



# REVERSING THE DOOR SWING

Read these instructions completely and carefully

17. Reinstall the middle hinge on the left side of the cabinet. (Use the left hinge supplied in Refrigerator bottle bin) Don't forget to insert washer with grease.

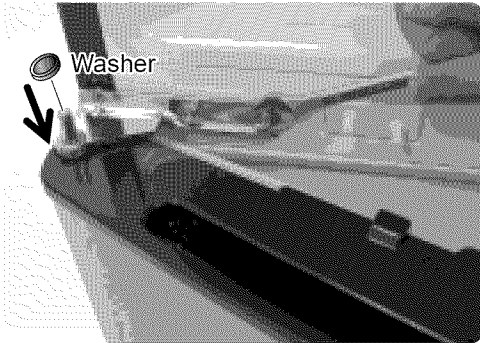

18. Confirm opening and closing of the door.



## - ASSEMBLY OF THE FRIDGE DOOR

19. After removing the screws, disassemble the Door Stopper and Grommet.

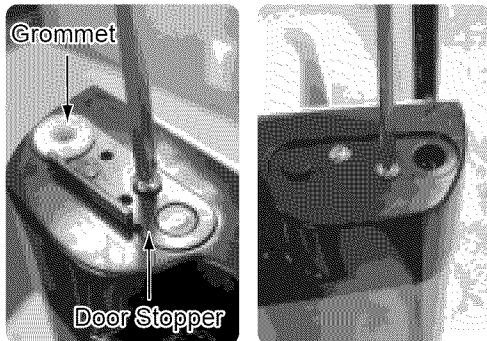

20. Move the hardware from left side of door to the right side and vice-versa.

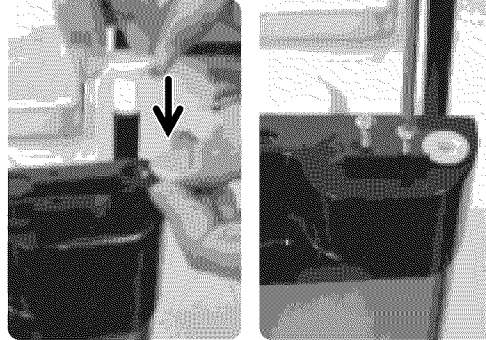

21. Fit the fridge door into the middle hinge.

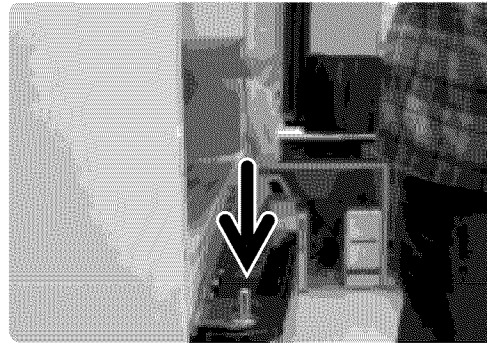

22. After removing the screw, disassemble the Cabinet Hinge Cover. And disassemble the Door Hinge Cover using adequate tools.(Refer to the below picture)



## REVERSING THE DOOR SWING

Read these instructions completely and carefully

23. Place the Wire boot taken from the left connector on the right connector.



24. Re-install parts in their opposing sides. Electric wires must be sealed in covers.

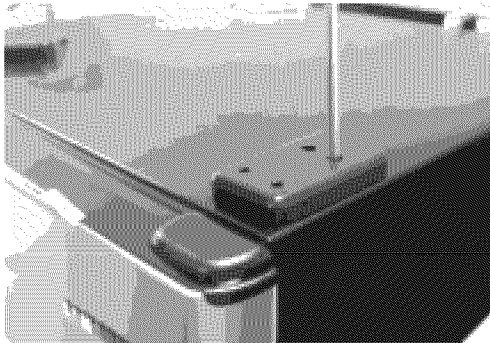

25. After securing the top hinge with the screws, connect the electric wire.

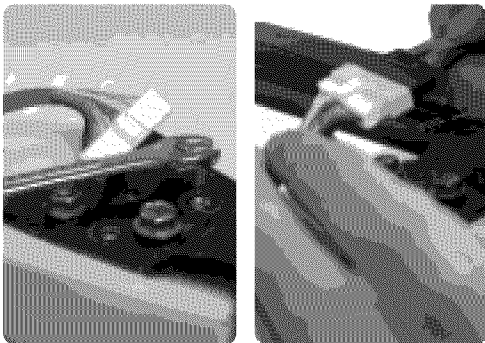

26. Assemble the Cover Hinge with the screws.

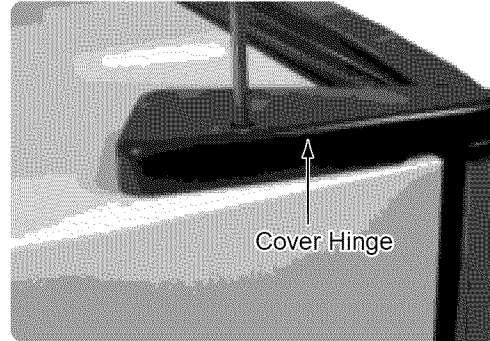

27. Finally, confirm opening and closing of the fridge door.

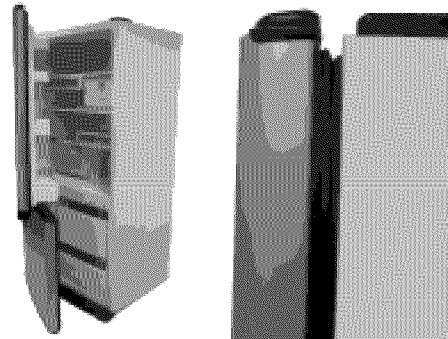

28. Make any necessary adjustments to insure proper sealing of the doors.

# PROBLEMS AND SOLUTIONS

## The appliance is not operating at all or the temperature is too high

- Check that the power plug is correctly connected.
- Is the temperature control on the front panel correctly set?
- Does the sun shine on the appliance or are there heat sources nearby?
- Is the back of the appliance too close to the wall?

## The food in the fridge is frozen

- Is the temperature control on the front panel set to the coldest temperature 34°F?
- Is the surrounding temperature too low?
- Did you put food with a high water content in the fridge?

## There are unusual noises

- Check that the appliance is installed on a stable, leveled floor.
- Is the back of the appliance too close to the wall?
- Have any foreign objects fallen behind or under the appliance?
- Is the noise coming from the compressor in the appliance? Call 1-800-SAMSUNG
- A ticking sound may be heard inside the appliance; this is normal. This sound occurs when the various accessories contract or expand.

## The front corners and sides of the appliance are warm and condensation starts to form

- Heat-proof pipes are installed in the front corners of the appliance to prevent condensation from forming. When the surrounding temperature rises, this may not always be effective. However, this is not abnormal.
- In very humid weather, condensation may form on the outer surface of the appliance when moisture in the air comes into contact with the cool surface of the appliance.

## You can hear a liquid bubbling in the appliance

- Please note that this noise is caused by the refrigerant circuit and is not a problem.

## There is a bad smell inside the appliance

- Do not wrap food with paper.
- Store foods covered and clean the cold inlet.

## There is a layer of frost on the surface of stored food.

- Space the food out as much as possible to improve ventilation.
- Is the door fully closed?

## Condensation forms on the inside wall of the appliance and around vegetables

- Food with a high water content is stored uncovered with a high humidity level or the door has been left open for a long time.
- Store the food with a cover or in sealed containers.

# USAGE PRECAUTIONS

## Store food with a high water content at the front of a refrigerator shelf.



### Power Saving Tips

- Install the appliance in a cool, dry room with adequate ventilation. Ensure that it is not exposed to direct sunlight and never put it near a direct source of heat (radiator, for example).
- Never block any vents or grilles on the appliance.
- Allow warm food to cool down before placing it in the appliance.
- Put frozen food in the refrigerator to thaw. You can then use the low temperatures of the frozen products to cool food in the refrigerator.
- Defrost the freezer when ice builds up. A thick coat of ice will impair the transfer of cold to the frozen products, thereby increasing power consumption.
- Do not keep the door of the appliance open for too long when putting food in or taking food out. The shorter time the door is opened, the less ice will form in the freezer.
- When freezing food or storing it in the freezer, place the food directly on the freezer elements in the top container.

## Do not store hot food in the appliance until it has cooled.

- If you store cold food, you save on electricity and improve refrigeration.

**SAMSUNG REFRIGERATOR  
(18 Cubic Feet and Larger Capacity)**

**LIMITED WARRANTY TO ORIGINAL PURCHASER**

This SAMSUNG brand product, as supplied and distributed by Samsung Electronics America, Inc. (SAMSUNG) and delivered new, in the original carton to the original consumer purchaser, is warranted by SAMSUNG against manufacturing defects in materials and workmanship for a limited warranty period of:

**One (1) Year Parts and Labor on Refrigerator  
Five (5) Years Parts and Labor on Sealed Refrigeration System Only\***  
(\*Compressor, evaporator, condenser, drier, connecting tubing)

This limited warranty begins on the original date of purchase, and is valid only on products purchased and used in the United States. To receive warranty service, the purchaser must contact SAMSUNG for problem determination and service procedures. Warranty service can only be performed by a SAMSUNG authorized service center. The original dated bill of sale must be presented upon request as proof of purchase to SAMSUNG or SAMSUNG's authorized service center.

SAMSUNG will repair or replace any part found to be defective, at our option and at no charge as stipulated herein, with new or reconditioned parts during the limited warranty period specified above. All replaced parts and products become the property of SAMSUNG and must be returned to SAMSUNG. Replacement parts and products assume the remaining original warranty, or ninety (90) days, whichever is longer.

In-home service will be provided during the warranty labor period subject to availability within the contiguous United States. In-home service is not available in all areas. To receive in-home service, the product must be unobstructed and accessible from floor level to service personnel. If during in-home service repair cannot be completed, it may be necessary to remove, repair and return the product. If in-home service is unavailable, SAMSUNG may elect, at our option, to provide for transportation of our choice to and from a SAMSUNG authorized service center. Otherwise, transportation to and from the SAMSUNG authorized service center is the responsibility of the purchaser.

This limited warranty covers manufacturing defects in materials and workmanship encountered in normal, noncommercial use of this product, and shall not apply to the following, including, but not limited to: damage which occurs in shipment; delivery and installation; applications and uses for which this product was not intended; altered product or serial numbers; cosmetic damage or exterior finish; accidents, abuse, neglect, fire, water, lightning or other acts of nature; use of products, equipment, systems, utilities, services, parts, supplies, accessories, applications, installations, repairs, external plumbing and leaks, external wiring, circuit breakers, fuses or connectors not supplied and authorized by SAMSUNG, or which damage this product or result in service problems; incorrect electrical line voltage, fluctuations and surges; customer adjustments and failure to follow operating instructions, cleaning, maintenance and environmental instructions that are covered and prescribed in the instruction book; loss of food due to spoilage; consumable items including filters and light bulbs.

THERE ARE NO EXPRESS WARRANTIES OTHER THAN THOSE LISTED AND DESCRIBED ABOVE, AND NO WARRANTIES WHETHER EXPRESS OR IMPLIED, INCLUDING, BUT NOT LIMITED TO, ANY IMPLIED WARRANTIES OF MERCHANTABILITY OR FITNESS FOR A PARTICULAR PURPOSE, SHALL APPLY AFTER THE EXPRESS WARRANTY PERIODS STATED ABOVE, AND NO OTHER EXPRESS WARRANTY OR GUARANTY GIVEN BY ANY PERSON, FIRM OR CORPORATION WITH RESPECT TO THIS PRODUCT SHALL BE BINDING ON SAMSUNG. SAMSUNG SHALL NOT BE LIABLE FOR LOSS OF REVENUE OR PROFITS, FAILURE TO REALIZE SAVINGS OR OTHER BENEFITS, OR ANY OTHER SPECIAL, INCIDENTAL OR CONSEQUENTIAL DAMAGES CAUSED BY THE USE, MISUSE OR INABILITY TO USE THIS PRODUCT, REGARDLESS OF THE LEGAL THEORY ON WHICH THE CLAIM IS BASED, AND EVEN IF SAMSUNG HAS BEEN ADVISED OF THE POSSIBILITY OF SUCH DAMAGES. NOR SHALL RECOVERY OF ANY KIND AGAINST SAMSUNG BE GREATER IN AMOUNT THAN THE PURCHASE PRICE OF THE PRODUCT SOLD BY SAMSUNG AND CAUSING THE ALLEGED DAMAGE. WITHOUT LIMITING THE FOREGOING, PURCHASER ASSUMES ALL RISK AND LIABILITY FOR LOSS, DAMAGE OR INJURY TO PURCHASER AND PURCHASER'S PROPERTY AND TO OTHERS AND THEIR PROPERTY ARISING OUT OF THE USE, MISUSE OR INABILITY TO USE THIS PRODUCT SOLD BY SAMSUNG NOT CAUSED DIRECTLY BY THE NEGLIGENCE OF SAMSUNG. THIS LIMITED WARRANTY SHALL NOT EXTEND TO ANYONE OTHER THAN THE ORIGINAL PURCHASER OF THIS PRODUCT, IS NONTRANSFERABLE AND STATES YOUR EXCLUSIVE REMEDY.

Some states do not allow limitations on how long an implied warranty lasts, or the exclusion or limitation of incidental or consequential damages, so the above limitations or exclusions may not apply to you. This warranty gives you specific legal rights, and you may also have other rights, which vary from state to state.

To obtain warranty service, please contact SAMSUNG at:

**SAMSUNG CUSTOMER CARE CENTER**  
400 Valley Road, Suite 201, Mt. Arlington, NJ 07856  
**1-800-SAMSUNG (1-800-726-7864) and [www.samsung.com](http://www.samsung.com)**

061002

# MEMO



**SAMSUNG**

# MEMO

**SAMSUNG**

# MEMO

**SAMSUNG**

ADDRESS : SAMSUNG ELECTRONICS AMERICA, INC.  
SERVICE DIVISION  
400 VALLEY ROAD, SUITE 201, MT. ARLINGTON, NJ 07856  
1-800-SAMSUNG(1-800-726-7864)

