



3D DLP® HOME-CINEMA TELEVISION

MODELS

740 Series

840 Series

WD-82CB1

BASIC OWNER'S GUIDE

This manual provides basic connection, setup, and operating instructions. For use of additional features of this television, please visit our website at www.Mitsubishi-tv.com to view or download a supplemental Owner's Guide. Follow the Support link to the Product Documents page.

- For questions:
 - Visit our website at www.mitsubishi-tv.com.
 - E-mail us at TVsupport@mevsa.com.
 - Call Consumer Relations at 800-332-2119 for operational or connection assistance.
- For information on **System Reset**, please see the back cover.
- To order replacement or additional remote controls, visit our website at www.mitsuparts.com or call 800-553-7278.



	CAUTION RISK OF ELECTRIC SHOCK DO NOT OPEN	
CAUTION: TO REDUCE THE RISK OF ELECTRIC SHOCK, DO NOT REMOVE COVER (OR BACK). NO USER SERVICEABLE PARTS INSIDE. REFER SERVICING TO QUALIFIED SERVICE PERSONNEL.		

 The lightning flash with arrowhead symbol within an equilateral triangle is intended to alert the user of the presence of uninsulated “dangerous voltage” within the product’s enclosure that may be of sufficient magnitude to constitute a risk of electric shock to persons.

 The exclamation point within an equilateral triangle is intended to alert the user to the presence of important operating and maintenance (servicing) instructions in the literature accompanying the product.

MAINS DISCONNECTION: The mains plug is used as the disconnect device. The mains plug shall remain readily operable.

WARNING: To reduce the risk of fire or electric shock, do not expose this apparatus to rain or moisture.

This apparatus shall not be exposed to dripping or splashing and no objects filled with liquids, such as vases, shall be placed on the apparatus.

Cet appareil ne doit pas être exposé à des gouttes ou à des éclaboussures et aucun objet rempli d’un liquide, comme un vase, ne doit être placé sur l’appareil.

WARNING: This product contains chemicals known to the State of California to cause cancer and/or birth defects or other reproductive harm.

TV WEIGHT: This TV is heavy. Exercise extreme care when lifting or moving it. Lift or move the TV with a minimum of two adults. To prevent damage to the TV, avoid jarring or moving it while it is turned on. Always power off your TV, unplug the power cord, and disconnect all cables before moving it.

Stand Requirement

CAUTION: Use these Mitsubishi TV models only with the Mitsubishi stand model shown here. Other stands can result in instability and possibly cause injury.

TV Model	Stand Model
WD-73740, WD-73840,	MB-S73A

Mitsubishi does not design, manufacture or sell matching bases for 82-inch and 92-inch model televisions. When selecting a stand, base, or other furniture to support the TV, please make sure it is designed with the appropriate dimensions for stability and to support the TV’s weight plus the weight of any additional equipment you plan to store.

Custom cabinet installation must allow for proper air circulation around the television.

For assistance call 1(800) 332-2119

FCC Declaration of Conformity

Product: Projection Television Receiver
 Models: WD-73740, WD-82740
 WD-73840, WD-82840, WD-92840
 WD-82CB1
 Responsible Party: Mitsubishi Electric Visual Solutions
 America, Inc.
 9351 Jeronimo Road
 Irvine, CA 92618-1904
 Telephone: 1 (800) 332-2119

This device complies with Part 15 of the FCC Rules. Operation is subject to the following two conditions:

- (1) This device may not cause harmful interference, and
- (2) This device must accept any interference received, including interference that may cause undesired operation.

Note: This equipment has been tested and found to comply with the limits for a Class B digital device, pursuant to part 15 of the FCC Rules. These limits are designed to provide reasonable protection against harmful interference in a residential installation. This equipment generates, uses and can radiate radio frequency energy and, if not installed and used in accordance with the instructions, may cause harmful interference to radio communications. However, there is no guarantee that interference will not occur in a particular installation. If this equipment does cause harmful interference to radio or television reception, which can be determined by turning the equipment off and on, the user is encouraged to try to correct the interference by one or more of the following measures:

- Reorient or relocate the receiving antenna.
- Increase the separation between the equipment and the receiver.
- Connect the equipment into an outlet on a circuit different from that to which the receiver is connected.
- Consult the dealer or an experienced radio/TV technician for help.

Changes or modifications not expressly approved by Mitsubishi could cause harmful interference and would void the user’s authority to operate this equipment.

Canadian Notice

For Model WD-82CB1
 This Class B digital apparatus complies with Canadian ICES-003.
 Cet appareil numérique de la classe B est conforme à la norme NMB-003 du Canada.

Note: Features and specifications described in this owner’s guide are subject to change without notice.

Contents

Important Safety Instructions	4
<hr/>	
1 Basic Setup and Operation	
Package Contents	5
Installing the Remote Control Batteries	5
TV Overview	5
Before You Begin	5
Remote Control	6
Setting Up and Using TV Inputs	7
Basic TV Operation	9
TV Menus	11
<hr/>	
2 TV Connections	
Before You Begin	12
Connection Types and Audio/Video Quality	12
Input and Output Jacks	13
Connection Diagrams	13
<hr/>	
3 TV Features	
StreamTV™ Internet	17
3D Video	20
Wireless Audio Playback (840 Series)	22
Sound Projector (840 Series)	23
<hr/>	
Appendices	
Appendix A: Auto Input Sensing	26
Appendix B: Lamp-Cartridge Replacement	27
Appendix C: Troubleshooting	29
Mitsubishi TV Software	32
Warranty	36
MEVSA Internet Applications Policy	39

TV Software

- Do not attempt to update the software of this TV with software or USB drives not provided by or authorized by Mitsubishi Electric Visual Solutions America, Inc. Non-authorized software may damage the TV and will not be covered by the warranty.
- Automatic software updates will be downloaded over the internet to the TV if StreamTV is set up and connected to the internet. In Canada, WD-82CB1 users can receive automatic software updates although StreamTV services will be unavailable.

Cleaning Recommendations

Normally, light dusting with a dry, non-scratching duster will keep your TV clean. If cleaning beyond this is needed, please use the following guidelines:

First, turn off the TV and unplug the power cord from the power outlet.

Occasionally clean dust build-up from the air-intake grilles on the back and sides of the TV. Clean using a vacuum cleaner with a brush attachment.

Top and Sides of the TV

- Gently wipe down your TV with a soft, non-abrasive cloth such as cotton flannel, microfiber, or a clean cloth diaper, lightly moistened with water. Dry with a second dry, soft, non-abrasive cloth.

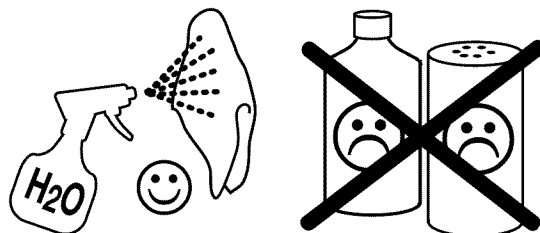

- For oily dirt, add a few drops of mild liquid detergent, such as dishwashing detergent, to the water used to moisten the cloth. Rinse with a second cloth moistened only with water. Dry with a third dry, soft, non-abrasive cloth.

Screen

- Follow the instructions for the top and sides, wiping gently in an up and down motion.
- Clean the entire screen evenly, not just sections of the screen.
- Do not allow liquid to drip down the screen, as some liquid may enter the TV through the gap between the screen and screen frame.
- You may purchase Mitsubishi Screen Cleaner, part number CLEANER-VSS, by calling 1 (800) 553-7278.

General Cleaning Precautions

- DO NOT allow liquid to enter the TV through the ventilation slots or any crevice.
- DO NOT use any strong or abrasive cleaners, as these can scratch the surfaces.
- DO NOT use any cleaners containing ammonia, bleach, alcohol, benzene, or thinners, as these can dull the surfaces.
- DO NOT spray liquids or cleaners directly on the TV's surfaces.
- DO NOT scrub or rub the TV harshly. Wipe it gently.

Important Safety Instructions

Please read the following safeguards for your TV and retain for future reference. Always follow all warnings and instructions marked on the television.

- 1) Read these instructions.
- 2) Keep these instructions.
- 3) Heed all warnings.
- 4) Follow all instructions.
- 5) Do not use this apparatus near water.
- 6) Clean only with dry cloth.
- 7) Do not block any ventilation openings. Install in accordance with the manufacturer's instructions.
- 8) Do not install near any heat sources such as radiators, heat registers, stoves, or other apparatus (including amplifiers) that produce heat.
- 9) Do not defeat the safety purpose of the polarized or grounding-type plug. A polarized plug has two blades with one wider than the other. A grounding type plug has two blades and a third grounding prong. The wide blade or the third prong are provided for your safety. If the provided plug does not fit into your outlet, consult an electrician for replacement of the obsolete outlet.
- 10) Protect the power cord from being walked on or pinched particularly at plugs, convenience receptacles, and the point where they exit from the apparatus.
- 11) Only use attachments/accessories specified by the manufacturer.
- 12) Use only with the cart, stand, tripod, bracket, or table specified by the manufacturer, or sold with the apparatus. When a cart is used, use caution when moving the cart/apparatus combination to avoid injury from tip-over.
- 13) Unplug this apparatus during lightning storms or when unused for long periods of time.
- 14) Refer all servicing to qualified service personnel. Servicing is required when the apparatus has been damaged in any way, such as power-supply cord or plug is damaged, liquid has been spilled or objects have fallen into the apparatus, the apparatus has been exposed to rain or moisture, does not operate normally, or has been dropped.



EXAMPLE OF ANTENNA GROUNDING

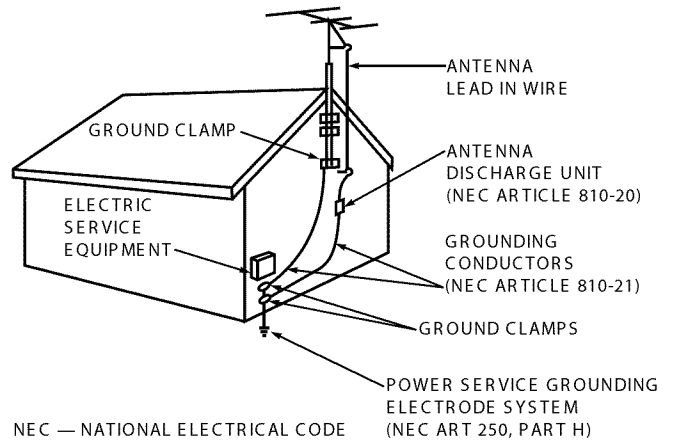

NEC — NATIONAL ELECTRICAL CODE

Outdoor Antenna Grounding

If an outside antenna or cable system is connected to the TV, be sure the antenna or cable system is grounded so as to provide some protection against voltage surges and built-up static charges.

Replacement Parts

When replacement parts are required, be sure the service technician has used replacement parts specified by the manufacturer or have the same characteristics as the original part. Unauthorized substitutions may result in fire, electric shock or other hazards.

NOTE TO CATV SYSTEM INSTALLER: THIS REMINDER IS PROVIDED TO CALL THE CATV SYSTEM INSTALLER'S ATTENTION TO ARTICLE 820-40 OF THE NEC THAT PROVIDES GUIDELINES FOR THE PROPER GROUNDING AND, IN PARTICULAR, SPECIFIES THAT THE CABLE GROUND SHALL BE CONNECTED TO THE GROUNDING SYSTEM OF THE BUILDING, AS CLOSE TO THE POINT OF CABLE ENTRY AS PRACTICAL.

Lamp Replacement

For lamp-replacement instructions, see Appendix B.

To Order a Replacement Lamp Under Warranty
Call (800) 553-7278. Please have model number, serial number, and TV purchase date available.

To Purchase a Replacement Lamp After Warranty
Visit our website at www.mitsuparts.com or call (800) 553-7278. Order new lamp part number **915B455011**.

Children and TV Viewing

The American Academy of Pediatrics discourages television viewing for children younger than two years of age.

For assistance call 1(800) 332-2119

1 Basic Setup and Operation

Package Contents

Please take a moment to review the following list of items to ensure that you have received everything.

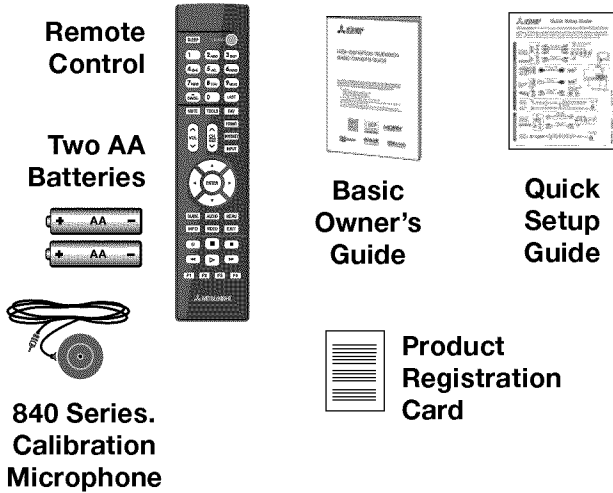

TV Overview

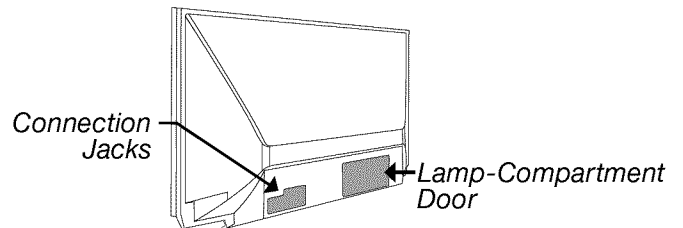
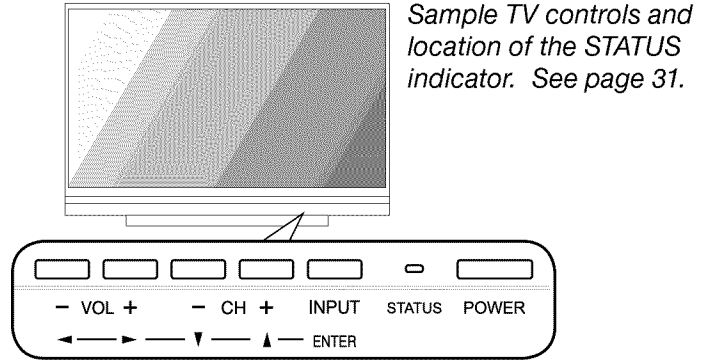

Installing the Remote Control Batteries

1. Remove the remote control's back cover by gently pressing in the tab and lifting off the cover.
2. Load the batteries, making sure the polarities (+) and (-) are correct. For best results, insert the negative (-) end first.
3. Snap the cover back in place.

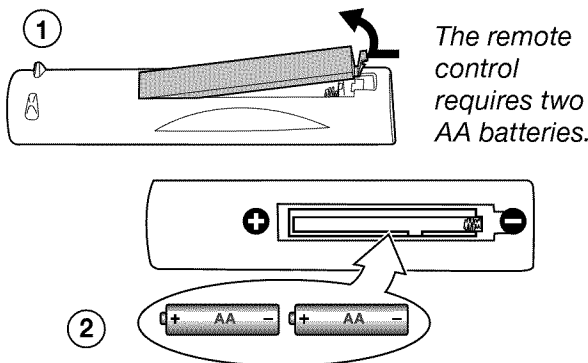

TV Control Panel

Buttons on the control panel duplicate some keys on the remote control.

To display the main menu, press **INPUT** and **VOL+** simultaneously for about 10 seconds. Press and hold **INPUT** and **VOL+** for 10 seconds to clear the menu.

System Reset

If the TV fails to respond to the remote control, the control-panel buttons, or will not power on/off, perform System Reset. Press and hold the **POWER** button on the control panel for ten seconds.

Before You Begin

1. Review the important safety, installation, and operating information at the beginning of this book.
2. Choose a location for your TV.
 - See the stand requirements on page 2.
 - Allow at least four inches of space on all sides of the TV to help prevent overheating. Overheating may cause premature failure of the TV.
 - Avoid locations where light may reflect off the screen.
3. Install the batteries in the remote control.
4. Plug the TV into an AC power outlet.

Remote Control

Aim the remote control at the TV screen. The TV can detect control signals over the entire screen area.

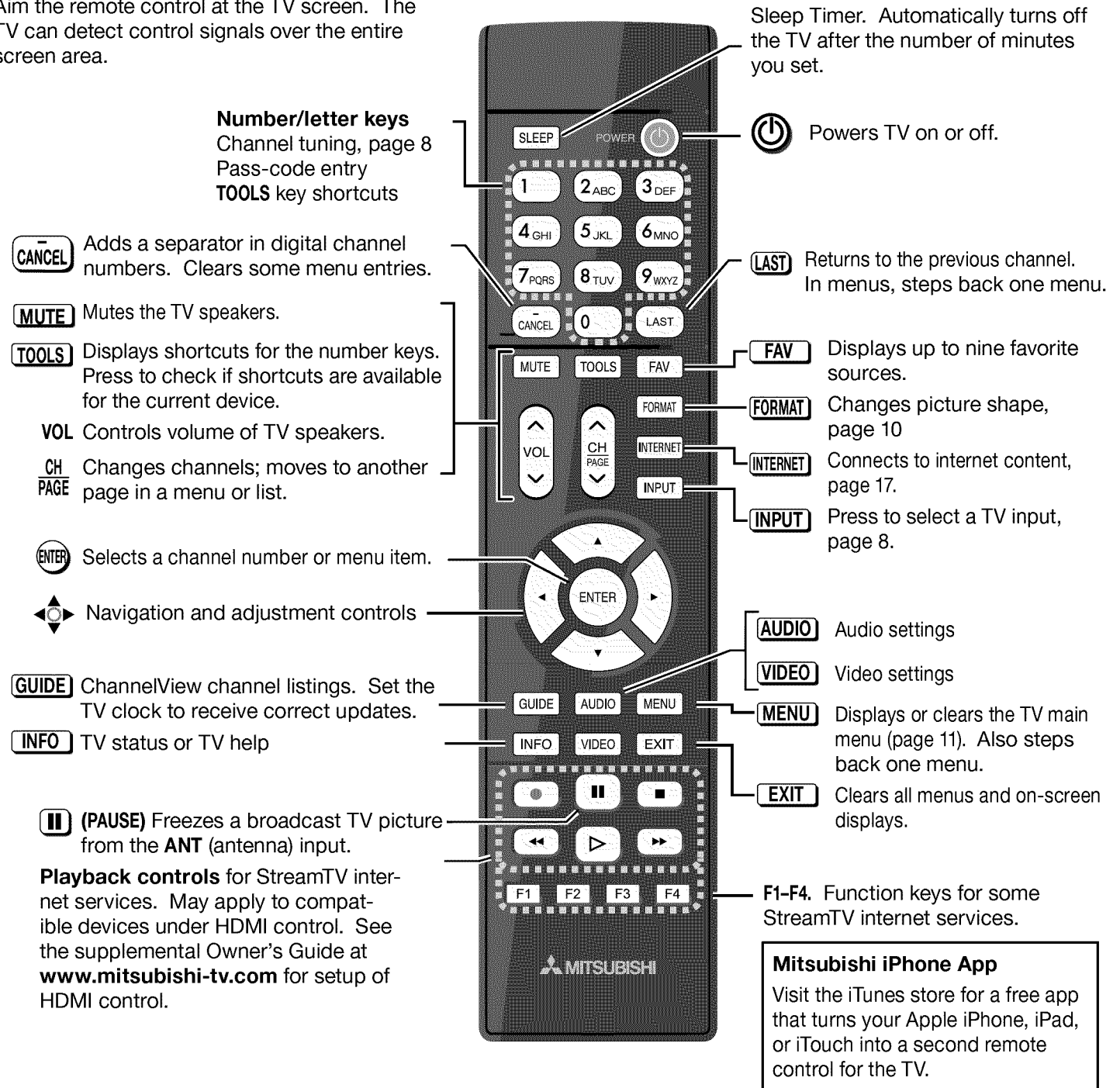

The TOOLS Key and Menu

Press the **TOOLS** key to see the **Tools** menu. Press number keys to activate shortcuts. Your **Tools** menu may differ from the sample, depending on your setup.

- Shortcuts specific to the current device are in the third column.
- Shortcuts may be available for a CEC-enabled device. See the supplemental Owner's Guide at www.mitsubishi-tv.com.

Picture shortcuts

Sound shortcuts

Device-Specific Shortcuts

Availability varies, depending on equipment features and setup.

PICTURE	SOUND	TV
1 Bright	2 Sub woofer	3 CC
4 Natural	5 Surround	6
7 3D	8 Night	9

3 CC. Turns closed captions on/off (**ANT** and **Y** composite inputs only)

Sample Tools menu, 840 series

First-Time Power-On

1. Install batteries in the remote control. See page 5.

2. Aim the emitter (bulb) end of the remote control at the TV and press the **POWER** key . Wait for the **Welcome** screen.

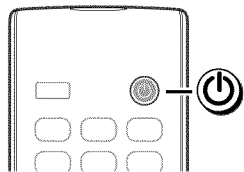

3. If you wish to change the menu language to **Español**, press **▼** then **ENTER**.

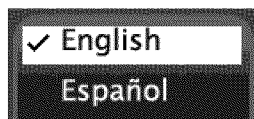

4. Press **▶** to move to the energy-mode selections. Select **Home**.



5. Press **▶** to highlight **EXIT**. Press **ENTER** to clear the menu.



Welcome Screen Energy Options

- Mitsubishi recommends the **Home** setting, which produces a picture suitable for home viewing and uses less power.
- The **Retail** setting looks best under the bright lighting often found in commercial settings. In this mode, the TV uses more power than when in the **Home** setting.

This table compares energy choices offered in the **Welcome** screen.

	Home	Retail
Picture Mode	Bright	Brilliant
Lamp Energy	Standard	Bright

- Use the **Picture > Video** menu to change the Picture Mode.
- Use the **Setup > Energy** menu to change **Lamp Energy**.

Setting Up and Using TV Inputs

The ANT (Antenna) Input

If using an antenna or direct cable service (no cable box), connect the incoming coaxial cable to the TV's **ANT** input. Refer to page 15.

You must perform a channel scan to enable reception of digital channels. If you skip this step, the TV can receive only analog channels. The channel scan will search for high-definition and standard-definition channels available in your area. **Note:** Direct cable service will not include scrambled or premium channels.

Memorizing Channels with Channel Scan

1. Power on the TV.
2. Press **MENU** and open the **Setup > Channel** menu.



Start channel memorization from the **Setup > Channel** menu.

3. Press **▼** to enter the menu.

4. Highlight **Ant Air** if connected to an over-the-air antenna. Highlight **Ant Cable** for service over direct cable (no cable box). Press **ENTER** to add a check.



5. Select the scan type.
 - For first-time setup, highlight **All channels**.
 - To scan for channels not already in memory, highlight **Add only new channels**. Press **ENTER** to add a check.



6. Highlight **Scan** and press **ENTER**. Channel memorization may take up to 15 minutes to complete.



To stop channel memorization before completion, press CANCEL.

At any time after Channel Scan,

- Use the **Setup > Channel > Edit** menu to add or delete individual channels from memory.
- Repeat the **All channels** scan if you reposition the antenna or move the TV to a new geographic area with a different channel line-up.

Setting Up and Using TV Inputs, continued

Setting Up Inputs with Auto Input Sensing

Connection information starts on page 12. Learn more about Auto Input Sensing on page 26.

1. Power on the TV.
2. Power on the devices to ensure detection.
3. Connect one device to the TV, making note of the TV input jack.

The TV will display the **New Device Found** screen if the connection type is detectable.

4. Highlight the device type in the on-screen list and press **ENTER**. The name you select here will appear in the **Input Selection** menu.

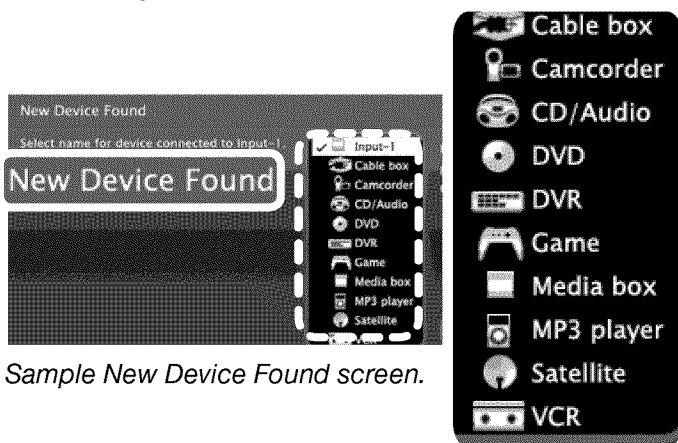

Sample New Device Found screen.

5. Press **EXIT** to close the **New Device Found** screen.
6. Repeat the preceding steps for each additional device you want to add.

Selecting an Input to Watch

1. Press **INPUT**.
2. Press **◀ ▶** and **▼** to highlight an input icon.

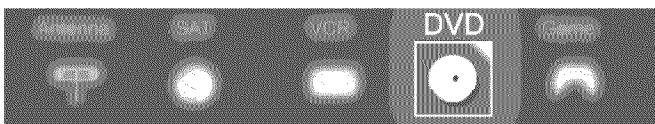
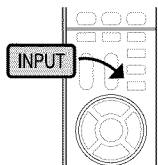

Sample Input Selection menu, DVD input selected

3. Press **ENTER** to switch to the input.

Note: In most cases, to see a named icon for a connected device (as in the samples), you must first assign a name either

- When the device is first connected and the **New Device Found** menu offers a choice of names.
- By using the **Inputs > Name** menu to assign or change a name at any time after the TV has detected the connection.

More About the Input Selection Menu

- To assign helpful names to the icons, see the **Inputs > Name** menu.
- To remove unwanted Antenna, **Bluetooth**®, or HDMI device icons from the **Input Selection** menu, see the **Inputs > Name** menu.
- To rearrange the icons, use the **Inputs > Order** menu.

Detailed information on using these menus is in the supplemental Owner's Guide at www.mitsubishi-tv.com.

Watching Broadcast TV

TV Connected to an Antenna or Direct Cable Service (no cable box)

Note: Perform channel memorization to enable reception of digital channels. See page 7.

1. Press **INPUT** to display the **Input Selection** menu.
2. Highlight the antenna or cable icon and press **ENTER**.

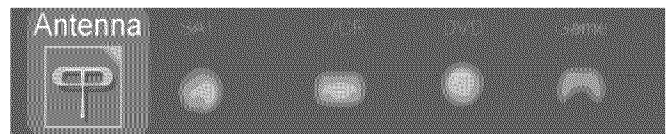

Sample Input Selection menu, antenna input selected

3. To tune to a channel from the **ANT** input, use any of these methods.
 - Enter the channel number using the number keys on the remote control and press **ENTER**. For a two-part digital channel, such as 3-1, press **3 CANCEL 1 ENTER**.
 - Press **CH** to change channels one channel at a time.
 - Press and hold **CH** to speed through channels.
 - Press **LAST** to return to the previous channel.
 - Use the Fav (Favorites) feature to tune to up to nine favorite channels. See the supplemental Owner's Guide at .
 - Press **GUIDE** to display ChannelView channel listings. Highlight a channel number, then press **ENTER** to tune.
 - Set up ChannelView custom channel banks and use the **CH** key to tune within predefined groups of channels.

Basic TV Operation

Audio Controls

Controlling Sound Volume

Press **VOL** to adjust the sound level of the TV speakers.

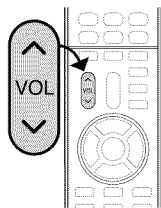

Changing Audio Settings (TV Speakers Only)

1. Press **AUDIO**.
2. Press **▼** to display the name of the adjustment you want.
3. Press **▶** to change.

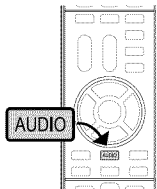

Using an External Sound System

To switch from the internal TV speakers to an external sound system:

1. Press **AUDIO**.
2. Press **▼** to display the **TV Speakers** option.
3. Press **▶** to select either **On** (to hear sound from the TV speakers) or **Off** (to hear sound from an external sound system).

See page 16 for suggestions on connecting your sound system to the TV.

Disconnecting an A/V Receiver

When you disconnect an A/V receiver, change the **TV Speakers** setting to **On** to hear sound from the TV speakers. Use the **Sound > Audio > TV Speakers** menu.

HDMI Control (CEC-Enabled HDMI A/V Receiver)

The TV's remote control may control some functions of the A/V receiver. See the supplemental Owner's Guide at www.mitsubishi-tv.com.

Picture Settings

To get the best picture under different viewing conditions, set the Picture Mode first before changing other video settings.

1. Press **VIDEO**.
2. Press **▼** until the **Picture Mode** option displays.

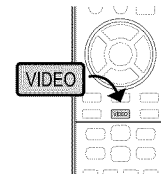

3. Press **▶** to make one of these selections:

Name	When to Use
Brilliant	Under very bright lighting
Game	With gaming consoles (inputs named Game or PC only)
Bright	For most daytime viewing
Natural	For most nighttime viewing

4. Press **▼** to display the name of another adjustment.
5. Press **◀▶** to make the adjustment.
6. Wait a few seconds and the display will clear.

More picture adjustments can be found in these menus:

- **Picture > Video**
- **Picture > Picture Plus**
- **Picture > 3D Mode**
- **Picture > Perfect** (840 Series only)

Basic TV Operation, continued

The FORMAT Key and Picture Shape

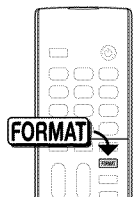

Press the **FORMAT** key to cycle through picture shapes for the current image. The TV will remember the format you last used on each input.

For more on TV formats and signal types, see the supplemental Owner's Guide at www.mitsubishi-tv.com.

Important

Black bars at the edges of the screen are common in HD pictures. Black bars are not a defect of the TV.

- Broadcasters add black bars to fill the 16:9 screen area while preserving the original aspect ratio of older material not created for modern HD TVs.
- Your cable box, satellite receiver, or other device may also have controls for altering the shape of the broadcast picture. If your device offers output in native format, try using it with the TV picture formats.

Sample Uses of the FORMAT Key

You can use the **FORMAT** key to display the image as originally intended or to reduce or eliminate black areas at the edges.

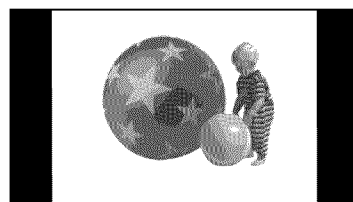

High-definition signal with squarish 4:3 image embedded. The image is narrower than the 16:9 screen; unused areas at the sides are filled with black.

Press
FORMAT →

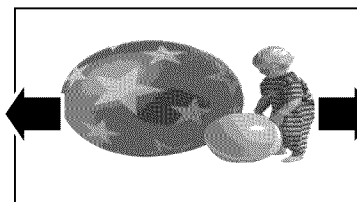

Wide Expand mode stretches the picture sideways to fill the screen.

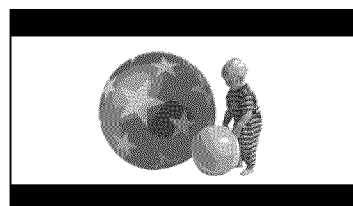

Standard 2.35:1 anamorphic DVD image; unused areas at the top and bottom are filled with black (letterbox effect).

Press
FORMAT →

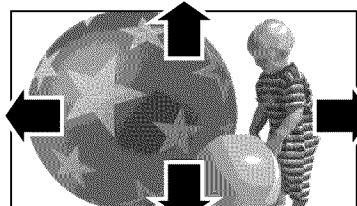

Zoom mode. The picture fills the screen. All four edges are cropped in this mode.

More TV Features

See the supplemental Owner's Guide at www.mitsubishi-tv.com for more on these and other topics.

- Parental controls (**Lock** menu). Requires first setting a pass code.
- TV Clock (**Setup > Clock** menu). Set the TV Clock if you plan to use the TV Timer, ChannelView channel listings, or the TV's **Lock by Time** feature.
- ChannelView channel listings. Press the **GUIDE** key to view. See the supplemental Owner's Guide to create custom collections of channels.
- Changing input names in the **Input Selection** menu (**Inputs > Name** menu)
- HDMI control of other A/V devices (CEC)
- Using the TV with a computer
- **840 Series.** Using the TV speakers for center channel sound for your external surround sound system.
- **840 Series.** Adding external rear speakers to complement the TV's surround sound effect
- **840 Series.** Using an external subwoofer

TV Menus



Picture

Video	Basic picture settings
Picture+	Specialized picture controls
Reset	Reset of sound and picture adjustments for the current input
Perfect	840 Series. Fine-tuning of color settings
Advanced	Highly customized picture adjustments for each input. Mitsubishi recommends these adjustments be made only by a trained professional installer.
3D Mode	Setup for 3D viewing. See page 20.



Sound

Audio	Basic audio settings 840 Series. Also includes subwoofer and center-channel controls.
Global	840 Series. Settings for the AVR/REAR OUTPUT jack.
Auto SP	840 Series. Sound Projector settings. See page 23.
SoundPro	



Captions

Settings for closed captions



Setup

Language	Menu language
Clock	Set the TV clock to use the TV Timer, to use ChannelView listings, or to lock the TV by time.
Timer	Setup for the TV Timer. The Timer tells the TV to power on automatically at a time you set. Set the TV clock before using the TV Timer.
Channel	Setup for a channel scan on the ANT input; addition to or deletion of channels from TV memory
Energy	Controls for TV energy usage
Network	Setup for internet connectivity. See page 17.

Press **MENU** on the remote control to open the main menu. Find detailed descriptions of all menus in the supplemental Owner's Guide at www.mitsubishi-tv.com.

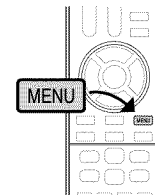

Inputs

Name	Name assignments for TV inputs
HDMI Control	Setup for HDMI Control (CEC) of external devices
Order	Setup of icons in the Input Selection menu
StreamTV	740 or 840 Series (U.S. only). Account deactivation; clears your personal data from the TV.
Demo	Demonstrations of selected TV features
Update	Instructions for updating TV software.



Lock

Parental	740 or 840 Series (U.S. only). Controls to limit TV use by content ratings (composite video and antenna inputs only)
Time	Setup to lock the TV by time of day. Set the TV clock before using this menu.
Channel	Setup to lock specific channels (antenna input only)
Panel	Control-panel lock
Other	740 or 840 Series (U.S. only). Controls to limit TV use based on rating systems that may come into effect in the future (digital channels on the antenna input only)

2 TV Connections

Before You Begin

Auto Input Sensing

The TV's Auto Input Sensing feature automatically recognizes many connections and prompts you to identify the type of device connected. See pages 8 and 26 for more on Auto Input Sensing.

Connection Types

Use the connection types available on your input devices that will give the best video quality. For example, choose HDMI over component video; choose component video over composite video.

Picture Quality

For best picture quality, route signals directly from the source device to the TV.

Surround Sound

The TV accepts PCM stereo or Dolby Digital 5.1 over the **ANT** and HDMI inputs and passes the audio out on the **DIGITAL AUDIO OUTPUT** jack.

IMPORTANT

Accessories such as cables, adapters, splitters, or combiners required for TV connections are not supplied with the TV. These items are available at most electronics stores.

Connection Types and Audio/Video Quality

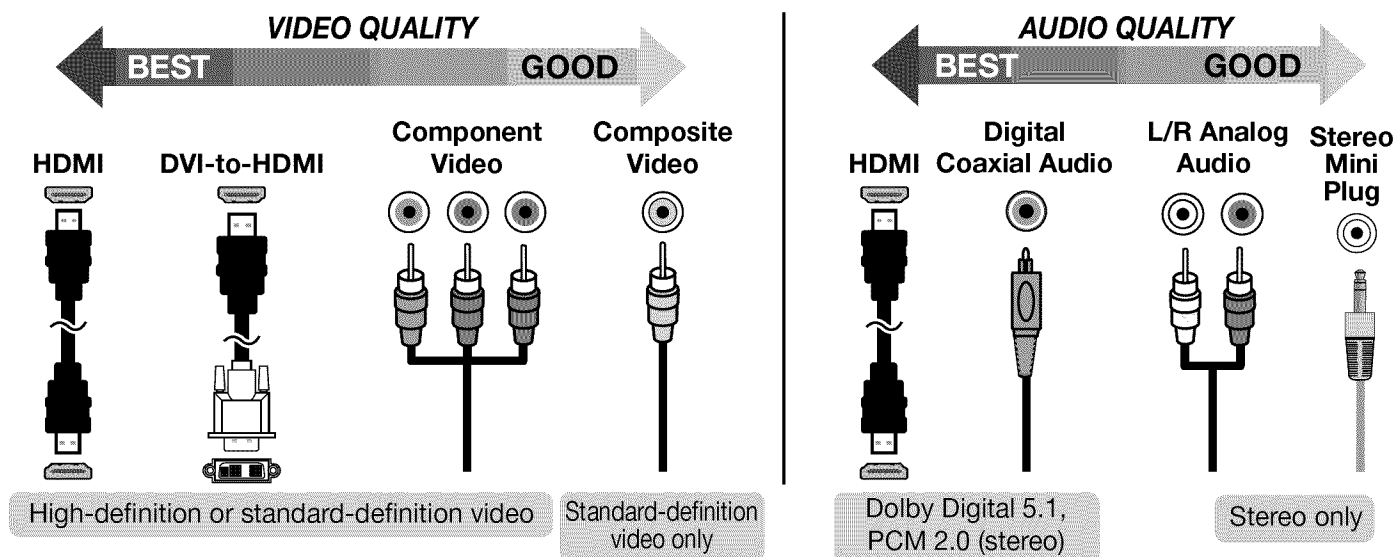

HDMI Cable Categories

HDMI cables are available as Standard and High-Speed types.

- High-Speed HDMI Cables.** Blu-ray players, newer DVD players, video games, 3D content, and set-top boxes require High-Speed HDMI cables, suitable for clock frequencies up to 340 MHz or data rates of up to 10.2 gigabits per second. Use high-speed cables for 1080p HD signals carrying extended color encodings (i.e., 30 or more bits, also called Deep Color). High-Speed HDMI cables are also suitable for standard HDTV signals.
- Standard HDMI Cables.** Standard HDMI cables may be unmarked. They are suitable for standard HDTV 720p, 1080i, and 1080p signals with 8-bit color depth. Use Standard HDMI cables for clock frequencies up to 74.25 MHz or data rates of up to 2.23 gigabits per second.

Input and Output Jacks

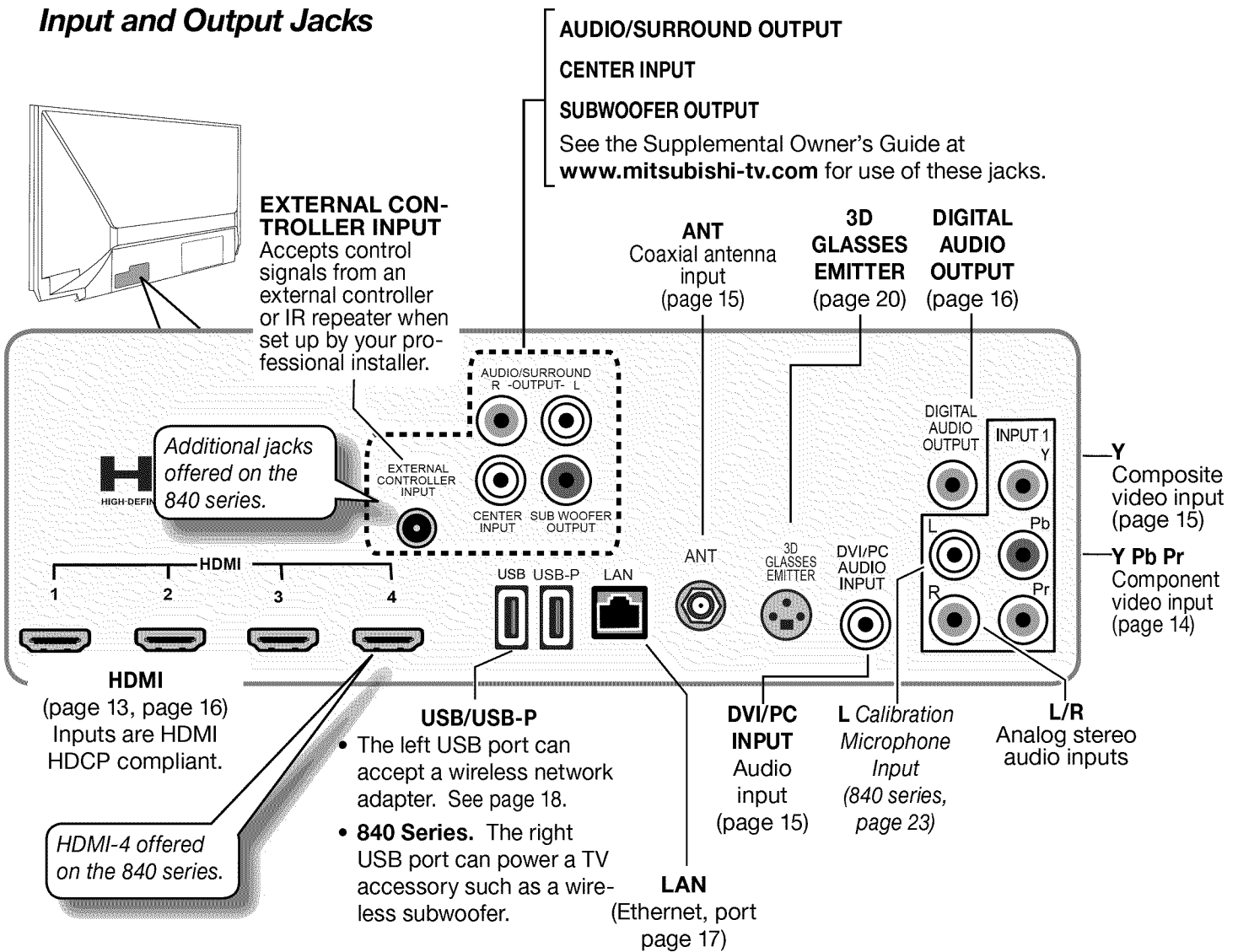

Connection Diagrams

HDMI Device

Examples: HDTV Cable Box, Satellite Receiver, or DVD/Blu-ray Player

Required: HDMI cable.

Connect an HDMI cable from the TV to the device's HDMI output. HDMI-connectable devices provide video and audio through a single cable.

Mitsubishi recommends using high-speed HDMI cables to connect newer devices incorporating HDMI technology. See "HDMI Cable Categories" on the opposite page for more on HDMI cable types.

Note:

- This connection carries high-definition video, 3D video, and Dolby Digital 5.1 audio signals.
- This connection supports copy protection (HDCP).

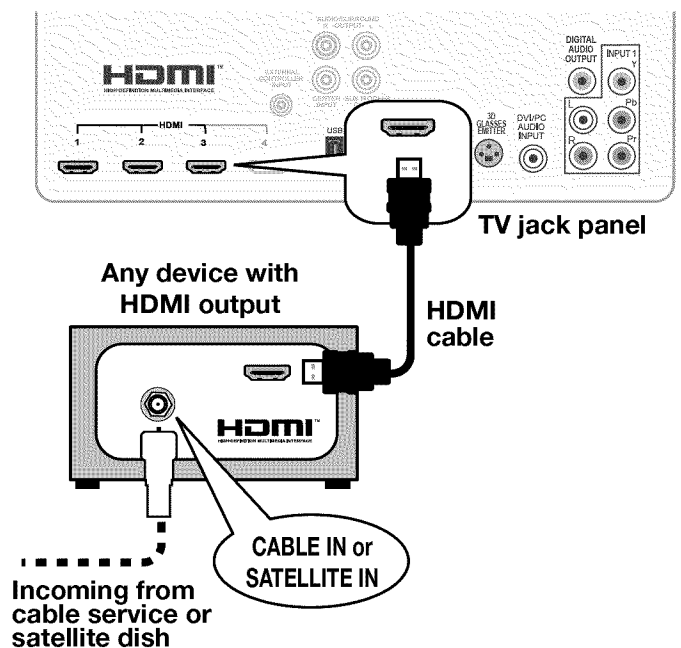

Y Pb Pr Component Video Device

Examples: HDTV Cable Box, Satellite Receiver, or DVD/Blu-ray Player

If your source device has an HDMI output, use the connections for an HDMI device described on the previous page instead of component video.

Required:

- Component video cables
- RCA-type analog audio cables

Note:

- This connection carries high-definition video signals.
- To hear digital surround sound from an A/V receiver, connect the digital audio output from the device directly to your digital A/V receiver.

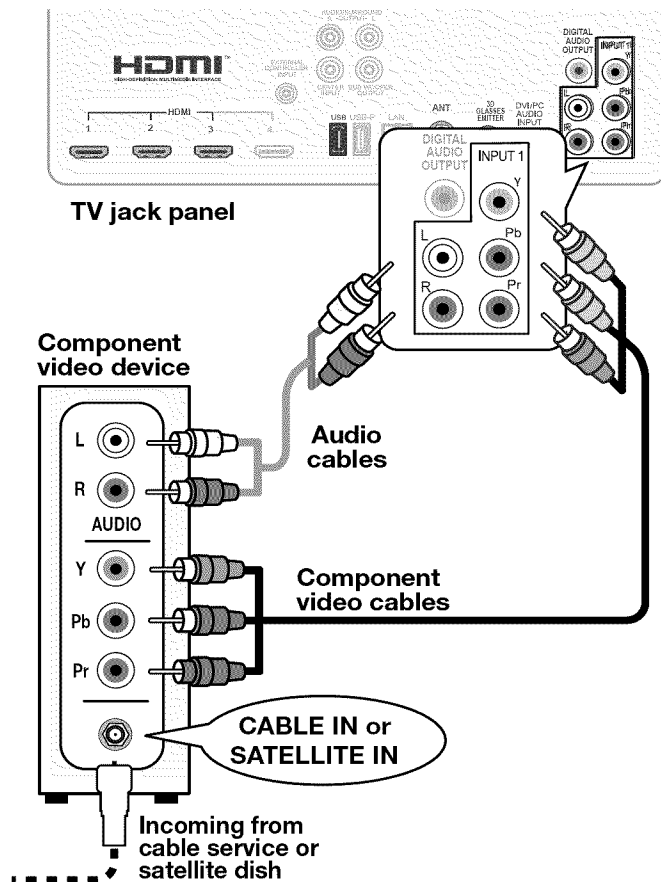

VCR or DVD Recorder to an Antenna or Wall Outlet Cable

Required:

- Video cables
 - Component video cables (red/blue/green)
 - or
 - Composite video cable (usually yellow)
- RCA-type analog audio cables
- Two-way RF splitter
- Two coaxial cables

Note:

- Use composite video only if component video or HDMI are unavailable. A composite video connection cannot carry high-definition video signals.
- If your recording device has an analog-only tuner, you must use a digital converter box to enable recording of digital broadcasts.

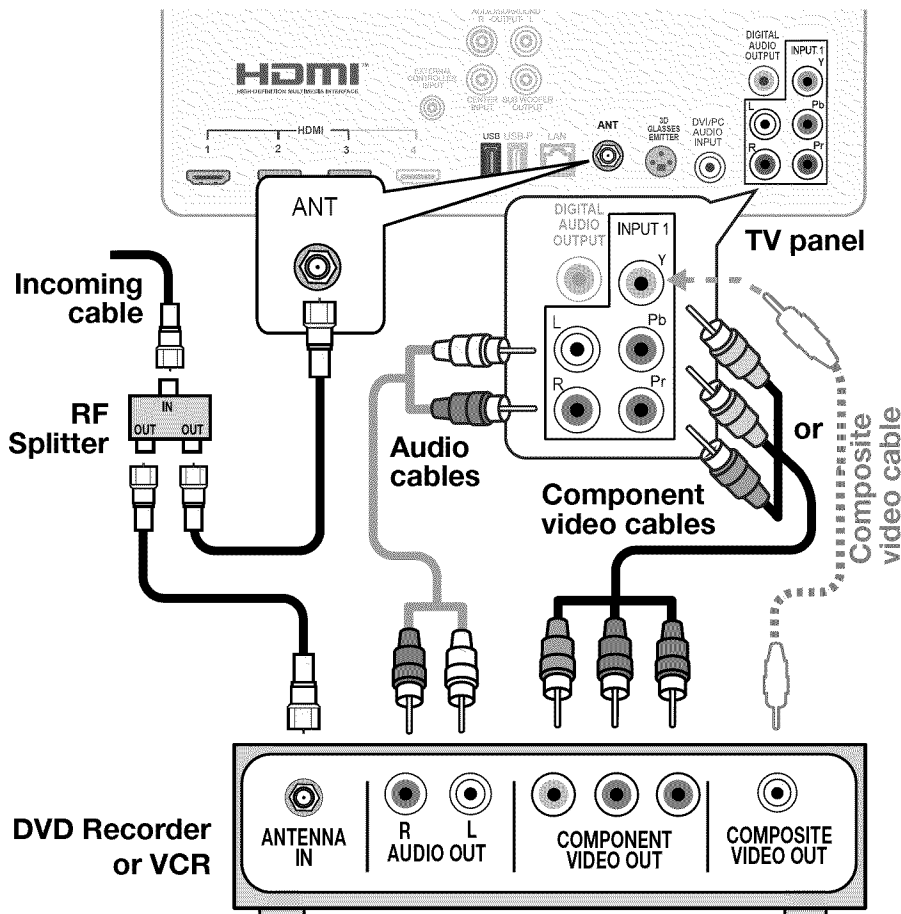

DVI Video Device

Examples: Computer or Older A/V Device

Note:

- This connection can carry high-definition video signals.
- The HDMI connection supports copy protection (HDCP).

Connect a DVI device (digital only) to one of the TV's HDMI input jacks.

Required:

- Audio cable with stereo mini-plug
- DVI-to-HDMI cable or DVI/HDMI adapter and HDMI cable

Some devices require a connection using an analog output first in order to view on-screen menus and to select DVI as the output. Please review your equipment instructions for DVI connectivity and compatibility.

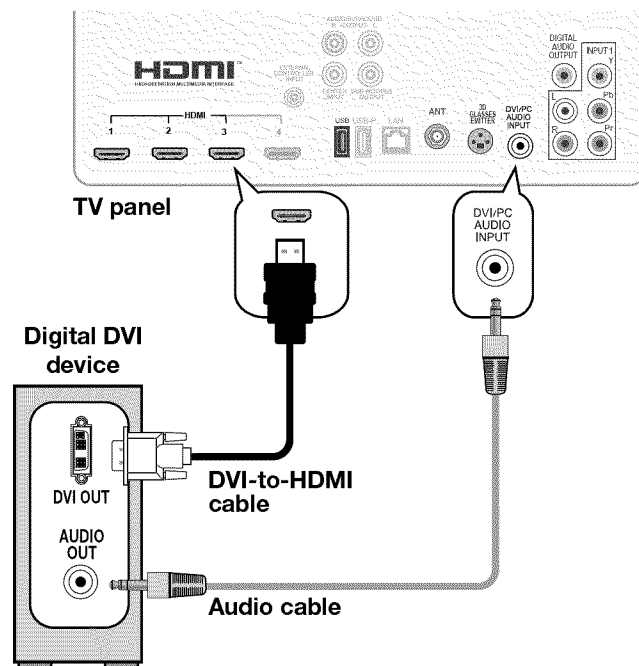

Antenna or Cable TV Service

Connect the incoming cable to the TV's ANT input. Reception over direct cable (no box) is limited to non-scrambled analog and digital channels.

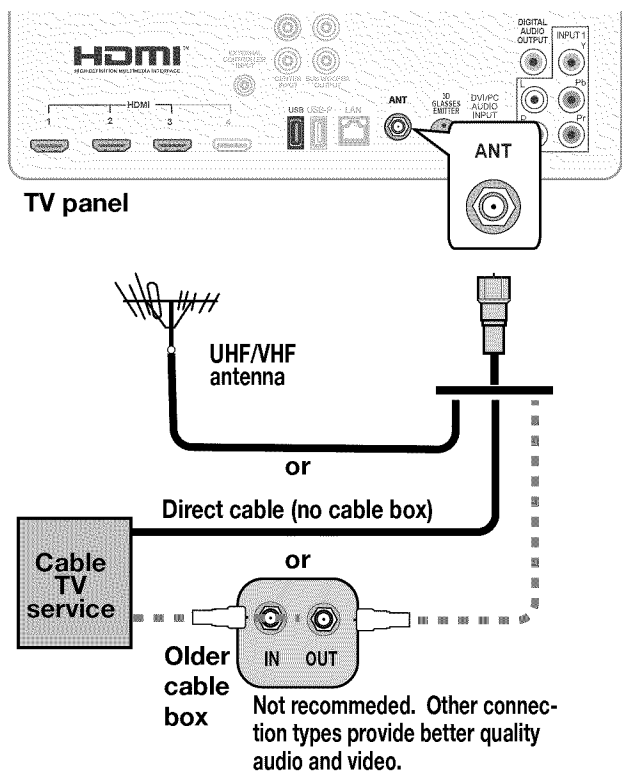

Composite Video Device

VCR or other device with composite video output

Note: This connection does not support high-definition video signals.

Required:

- Composite video cable (usually yellow)
- RCA-type analog audio cables

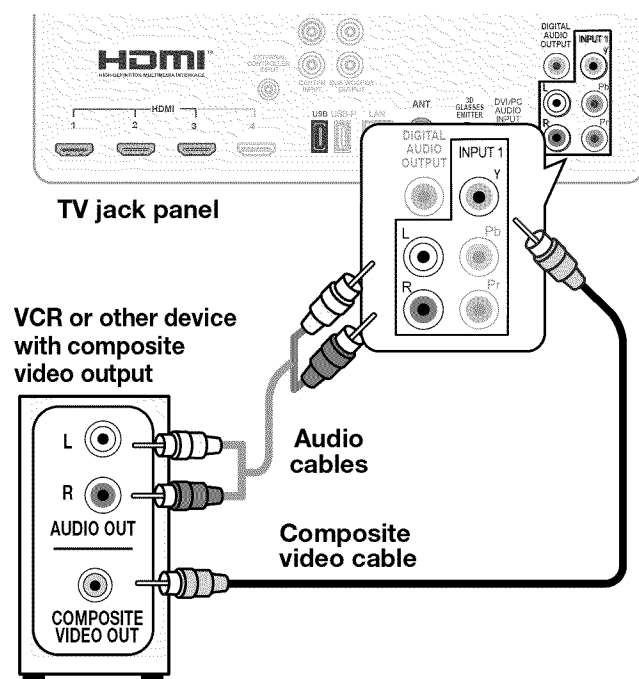

A/V Receiver

Most setups require either a digital audio cable or analog stereo audio cables. To send audio from TV channels received on the **ANT** input or devices connected directly to the TV, you must use one of the connections shown below.

The TV makes all incoming audio available as an output:

- Analog incoming audio is available as output in digital stereo format on the **DIGITAL AUDIO OUTPUT** jack. **840 Series.** Analog incoming audio is also available as analog stereo on the **AUDIO/SURROUND OUTPUT** jacks.
- Digital incoming audio is available as digital audio on the **DIGITAL AUDIO OUTPUT** jack. **840 Series.** Digital incoming audio is also available as analog output on the **AUDIO/SURROUND OUTPUT** jacks.

See page 9 for tips on using an external sound system.

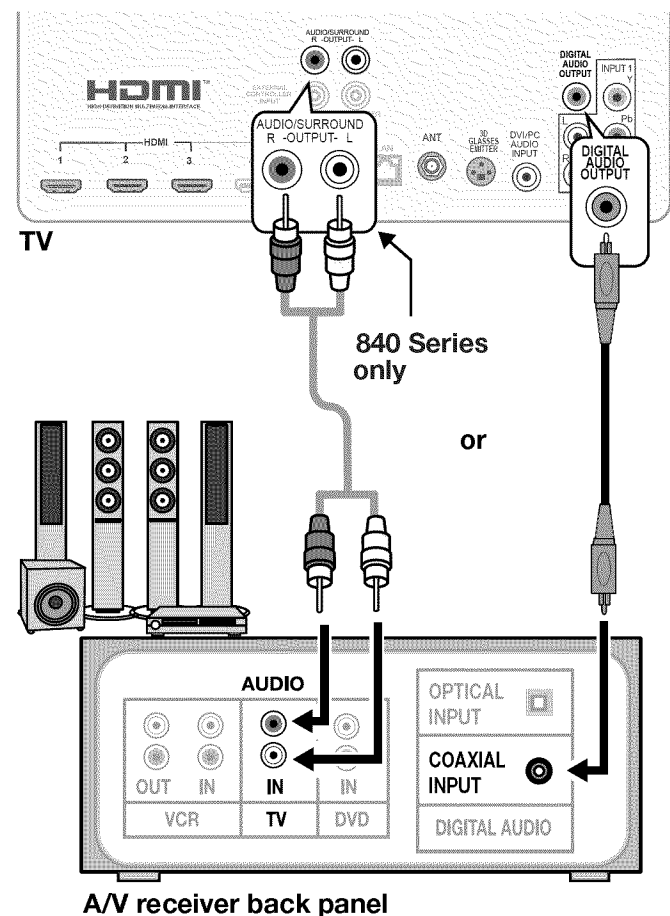

A/V Receiver with HDMI Output

Required: One HDMI cable

This option allows you to view and hear content from devices connected to an A/V receiver. The A/V receiver can send audio and video to the TV over a single HDMI cable.

You can add an optional audio connection from the TV's audio output. The optional audio connection allows you to hear, through the A/V receiver, devices connected to the TV only, e.g., an antenna on the **ANT** input.

See page 9 for tips on using an external sound system.

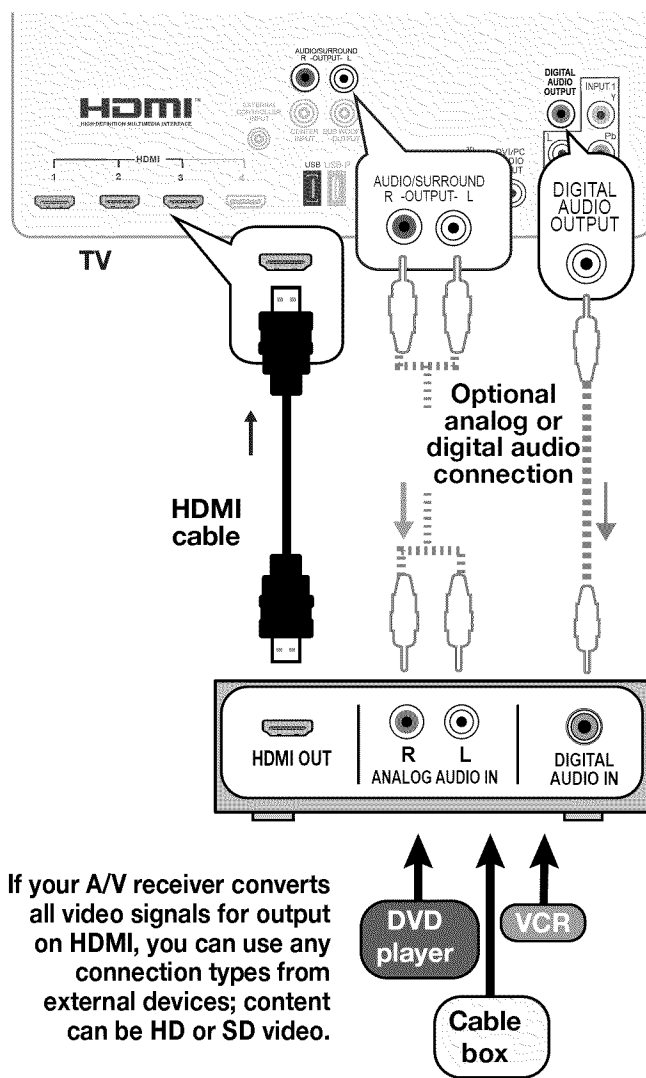

If your A/V receiver converts all video signals for output on HDMI, you can use any connection types from external devices; content can be HD or SD video.

Note: On rare occasions, an HDMI signal may be copy-restricted and cannot be output from the TV as a digital signal. To hear these copy-protected signals through the A/V receiver, use the connection for an analog A/V receiver.

- Check the A/V receiver's Owner's Guide for information on use of the digital input and switching between digital sound and analog stereo sound from the TV.

StreamTV™ Internet

About StreamTV

740 and 840 Series, U.S. only

Internet services let you access many popular on-line applications providing both free and paid content.

Required for StreamTV internet media:

- Broadband internet service (at least 2 Mbps for SD, 4 Mbps for HD, and 8 Mbps for 1080p HDX)
- Category-5 Ethernet cable **or** a wireless router transmitting to an AzureWave AW-NU231 USB wireless adapter.
- Computer access to the websites of content providers when initial account activation is required for service.
- A credit card to cover the cost of paid content.

WD-82CB1 (Canada)

StreamTV internet services are unavailable in Canada. Canadian users can, however, receive software updates and use the iPhone remote control app noted on page 6. Follow the instructions on these pages to connect the TV to your home internet network.

Home Network Setup

Before using StreamTV internet media, you must connect the TV to the internet using either an Ethernet cable or a wireless connection as described here.

Note: **840 Series.** Make sure the TV is on any input other than *Bluetooth®*. Press the **INPUT** key to change.

Wired Ethernet Connection

DHCP (automatic)

1. Connect the TV to your network router with a Category-5 Ethernet cable (not supplied).

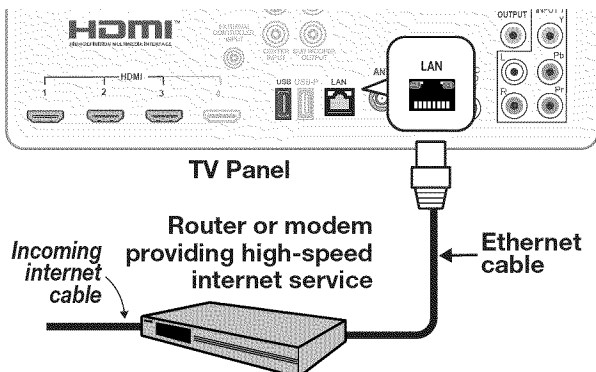

2. Open the **Setup > Network** menu to review settings.

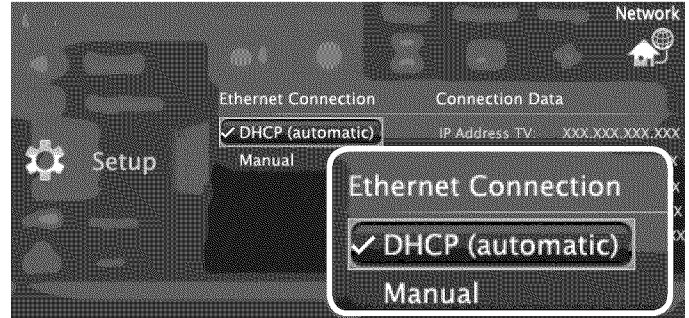

Setup > Network, DHCP connection

3. Press **EXIT** to clear the menu.

Manual

Note: Manual setup is available only for a wired connection.

1. Connect the TV to your network router with a Category-5 Ethernet cable (not supplied).
2. In the **Setup > Network** menu, highlight **Manual** and press **ENTER**.
3. Press **▶** to move to the **Connection Data** area.
4. Input the connection data.
5. After entering connection data, press **ENTER** to connect.
6. Change any of the following if needed:
 - Default Gateway
 - DNS
 - Subnet Mask

StreamTV™ Internet, continued

Wireless Connection

The TV requires an AzureWave AW-NU231 USB wireless adapter to communicate with your IEEE 802.11n-compliant wireless network router. The adapter is available from your Mitsubishi dealer or go to www.mitsubishi-tv.com and follow the Accessories link.

1. Disconnect the Ethernet cable if present.
2. Connect the wireless adapter to the TV's USB port.

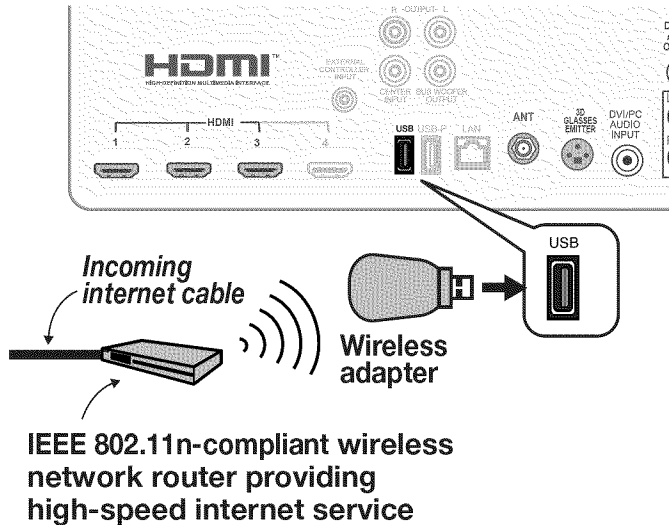

Connect the USB adapter to the USB port on the back of the TV. **840 Series.** Use the left USB port.

3. Open the **Setup > Network** menu. After a few moments, detected networks will appear listed on the screen in order of signal strength.



Setup > Network menu, wireless connection

4. Highlight the desired network and press **ENTER** to connect. A check will appear next to the connected

network. Press **CH/PAGE** to see more networks if the list fills more than one screen.

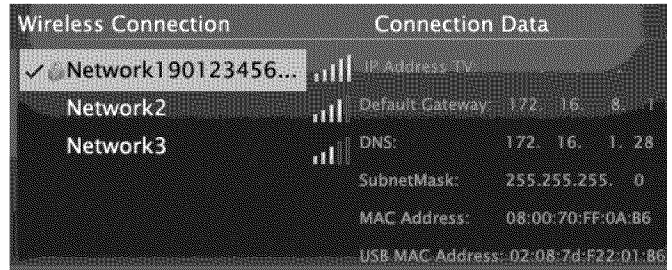

Setup > Network menu after connecting. The active network is checked and connection data displays.

5. If connecting to a secure network, enter the network key or password when prompted. Special remote control keys you may need:

Key	Use for
1	Digit 1 and special characters !@#\$%^*_+ = . SPACE ?
CANCEL	<ul style="list-style-type: none"> • Clears the password box of an old entry from a prior session. • Deletes one character during password entry.
▲ ▼	Toggle between upper and lower case

6. Press **ENTER** to connect.

Using StreamTV Internet Media

1. **840 Series.** After establishing internet connectivity as described in "Home Network Setup," page 17, switch the TV to any input other than *Bluetooth*®.
2. Press the **INTERNET** key to display services.
3. Press **ENTER** to launch an application.

Troubleshooting

If You Are Unable to Connect to the Internet

- Check all power and data connections.
- If you can reach the internet with a computer or other device on the same internet service used by the TV, consult the router or modem owner's guide for reset instructions.
- If you cannot reach the internet, contact your service provider. You may be asked for network information such as the TV's IP address. Go to the **Setup > Network** menu to see connection data.

For Further Assistance

If you are having trouble connecting your TV or accessing internet applications, contact Mitsubishi Customer Care at 1 (800) 332-2119.

StreamTV™ Internet, continued

VUDU (740 and 840 Series, U.S. only)

Internet services provided by VUDU™ Apps let you access many popular on-line applications. In addition to free content, VUDU's movie service lets you buy and rent movies through the TV. Visit www.VUDU.com to learn more about available movie titles, prices, and services offered.

Note: From time to time you may notice changes to the internet interface as new features are added.

Getting Started with VUDU Movies

1. After establishing internet connectivity as described in "Home Network Setup," page 17, switch the TV to any input other than *Bluetooth*®.
2. Press the **INTERNET** key to display services from VUDU Apps.
3. Select the VUDU movie service.
4. Browse the VUDU movie catalog and offerings.
5. When you are ready to rent or buy a movie, you will be prompted to activate your VUDU account. Follow the on-screen instructions and use a com-

puter to go to www.VUDU.com/activation. A credit card is required for activation.

Once your account is activated, you can rent and buy movies using only the TV and the TV's remote control.

If you are having difficulty with your VUDU account, contact VUDU Customer Care at www.VUDU.com/support.

Other VUDU Support

Reset your VUDU account password	Using a computer, go to www.VUDU.com (reset requires access to e-mail).
Reset your parental controls pass code	Call VUDU Customer Care at 1-888-554-VUDU (8838).

For a list of routers and switches recommended for use with VUDU services, see the **Support > FAQ** section at VUDU.com.

Using VUDU Apps and VUDU Movies

Navigate VUDU's menus with the keys on the TV's remote control. Browse the movie catalog, watch movie previews, set parental controls, and rent or buy movies.

- Key functions vary according to context and may change with newer versions of VUDU.
- Some VUDU screens include instructions identifying available key functions.

CANCEL. Usually acts like the backspace key during text entry.

ENTER. Confirms a selection.



- Directional navigation
- In VUDU Apps, press ▲▼ to display more applications.

GUIDE. In some contexts, returns to the VUDU home menu.

INFO. In VUDU's movie service, displays more options for the current selection if available.

F1. Displays a VUDU help menu if available.

F2. Displays the VUDU system menu if available.

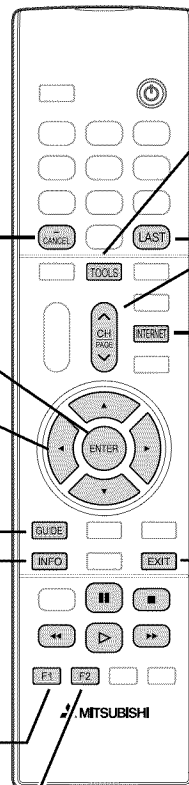

TOOLS. Use the **Tools** menu to perform A/V reset while in VUDU movies or some VUDU Apps.

LAST. Goes to a previous screen.

CH/PAGE. Jumps to the previous or next page of menu items.

INTERNET. Displays the VUDU Apps internet menu. Switch the TV to any input other than *Bluetooth*® before connecting to the internet.

EXIT. Closes the current screen and goes to a home screen.

Playback keys.

3D Video

To display 3D content, your Mitsubishi TV requires:

- Active-shutter 3D glasses compatible with any one of the following:
 - The TV's internal emitters
 - A matching external synchronization emitter connected to the TV's back panel
 - DLP link

Glasses compatible with the TV's internal emitters are:

- XPAND model 3DG-X103 IR glasses made for Mitsubishi 3D TVs
- XPAND model X103 Universal IR glasses

For more information, visit the 3D TV page at www.mitsubishi-tv.com.

- A compatible 3D source device connected to the TV via HDMI or StreamTV internet and outputting a 3D signal in one of these formats:
 - Frame Packing 1080p/24-Hz or 720p/60-Hz
 - Top-Bottom 1080p/24-Hz or 720p/60-Hz
 - Side-by-Side format, 1080p, 24/30/60-Hz; 720p, 60-Hz
 - Checkerboard format, 1080p, 60-Hz; (lower resolutions may be supported but will not fill the screen)

Off

- Turns off 3D images; displays 3D content as 2D (you may see two images).
- Restores normal TV adjustment options when viewing an ordinary 2D signal.

Automatic

- Switches the TV to 3D mode and selects the correct 3D format when the TV detects a 3D signal from an HDMI 1.4a-compliant device.
- Automatically switches the TV out of 3D mode when receiving a normal 2D signal.

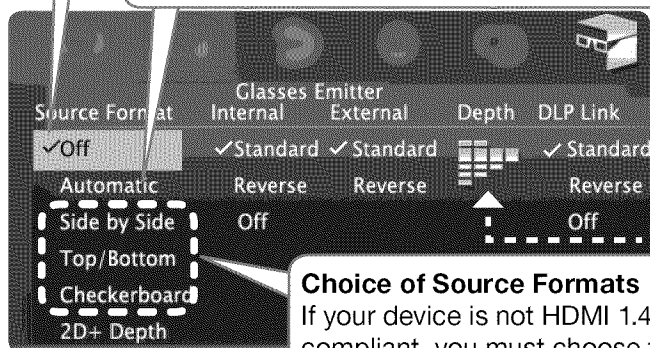

Use the Picture > 3D Mode menu to enable 3D video.

Choice of Source Formats
If your device is not HDMI 1.4a compliant, you must choose the correct setting from this list.

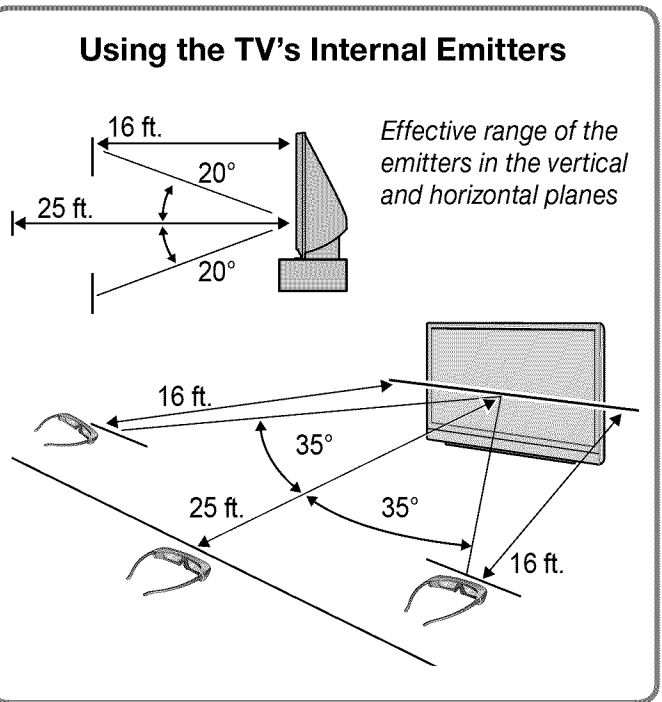

Initial Setup

1. If your 3D glasses came with a synchronization emitter, connect the unit to the **3D GLASSES EMITTER** jack. Place the emitter at the front of the TV where there is a clear path to the glasses.

Note: No emitter is required if using the TV's internal emitters or DLP Link.

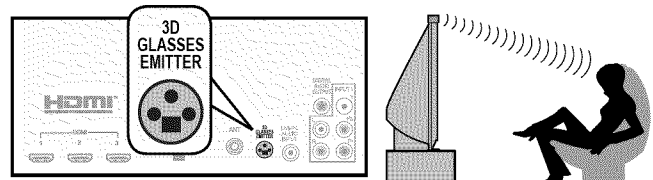

Connecting an external emitter

2. Power on the TV and the source device.
3. Connect the source device to the TV's HDMI input.
4. When the **New Device Found** screen displays, name the input.
5. Press **EXIT** to close the **New Device Found** screen.

Depth

Adjusts the simulated 3D effect applied to a 2D image. Available only when **Source Format** is set to **2D+ Depth**.

3D Video, continued

Watching 3D Video

Active 3D glasses are required. All glasses in use at the same time must use the same control type. Halogen lights, fluorescent lights, or direct sunlight can interfere with operation of the glasses.

1. Switch the TV to the 3D video device. Press **INPUT** then highlight the icon for the 3D video device. Press **ENTER**.

Note: Before watching 3D images from an internet source, it is important to establish the internet connection first before enabling 3D mode.

2. Press **MENU** and select the **Picture > 3D Mode** menu.
3. For **Source Format**, select **Automatic** and press **ENTER**. Press **EXIT** to close the menu.
 - If the image looks correct, the device is HDMI 1.4a compliant; always keep the setting at **Automatic** for this device.
 - For non-compliant 3D sources, open the **Picture > 3D Mode** menu and select a source format based on how the picture looks:

Side by Side

Two images, screen split vertically

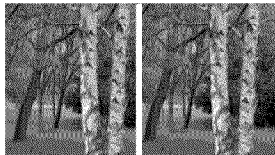

Top/Bottom

Two images, screen split horizontally

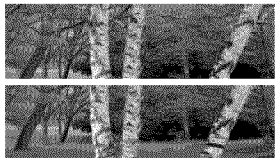

Checkerboard

Blurry double image (always required for checkerboard signals)

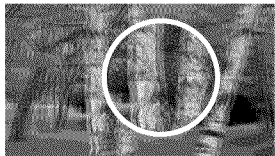

4. Press **EXIT** to close the menu.
5. If the image does not appear correct (e.g., objects appear to be moving in instead of out), open the **Picture > 3D Mode** menu. Highlight the **Reverse** setting for the current control type and press **ENTER** to add a check.
6. When finished watching 3D video:
 - If your 3D video device is HDMI 1.4a compliant, keep the setting on **Automatic**.
 - If you manually selected a source format in the **Picture > 3D** menu, open the menu again and select **Automatic** or **Off**.

Other Options in the 3D Menu

Glasses Control Off Settings	The Off settings disable output from the selected emitter. <ul style="list-style-type: none"> • Use Off to prevent IR interference when using an external emitter. • Use Off for DLP Link if you are not using DLP Link glasses.
2D+ Depth	When selected, generates a simulated 3D image from an ordinary 2D image. Adjust the effect using the Depth setting. Requires use of active-shutter 3D glasses.

Notes on Using 3D Video Settings

3D signals and 3D settings affect some TV functions. Switch to a non-3D source to regain full TV operation.

If **Source Format** is set to **Automatic** or one of the named 3D formats **OR Source Format** is set to **Off** and the 3D video source is HDMI 1.4a compliant (picture may still appear as 2D), the following limitations apply:

- Picture adjustments are limited. To make picture adjustments while watching normal 2D images from the device, temporarily set **Source Format** to **Off** to make the full range of adjustments accessible.
- While receiving a 3D signal,
 - The **FORMAT** key is disabled.
 - The **INTERNET** key is disabled.

3D Safety Requirements

- 3D Glasses are NOT designed as sunglasses or safety glasses and do not provide protection. 3D glasses should be worn only when viewing 3D material.
- Do not wear the wireless glasses in any situations that require unimpaired visual perception.
- Children under the age of 5 should not view 3D programming.

Under normal conditions, 3D viewing is safe for your movies or games. Some people may experience discomfort, however. To minimize the potential for experiencing visual problems or any adverse symptoms:

- Read and follow any and all safety warnings that accompany your 3D glasses or 3D source devices.
- Maintain a distance of no less than 2 to 2.5 times the screen height measurement away from the display. Viewing from too short a distance can strain your eyes.
- Take regular breaks, at least 5 minutes after every hour of 3D viewing.

If you experience any of the following symptoms, discontinue 3D viewing until the symptoms go away:

- nausea, dizziness, or queasiness,
- headache, or eyestrain,

3D Video, continued

- blurry vision,
- double vision that lasts longer than a few seconds,

Do not engage in any potentially hazardous activity (for example, driving a vehicle) until your symptoms have completely gone away. If symptoms persist, discontinue use and do not resume 3D viewing without discussing your symptoms with a physician.

Do not use the glasses where loss of balance or limiting your field of vision may be dangerous to you.

Do not use near staircases, ledges or balconies. You may risk falling during or after use.

Epilepsy

WARNING! IF YOU OR ANY MEMBER OF YOUR FAMILY HAS A HISTORY OF EPILEPSY, CONSULT A PHYSICIAN BEFORE USING 3D VIDEO OR GAME PRODUCTS.

A small percentage of the population may experience epileptic seizures when viewing certain types of TV images or video games that contain flashing patterns of light.

The following people should consult a physician before viewing 3D Games or Video:

- Anyone with a history of epilepsy, or who has a family member with a history of epilepsy
- Anyone who has ever experienced epileptic seizures or sensory disturbances triggered by flashing light effects.

WARNING! SOME LIGHT PATTERNS MAY INDUCE SEIZURES IN PERSONS WITH NO PRIOR HISTORY OF EPILEPSY. DISCONTINUE 3D VIEWING IF YOU EXPERIENCE ANY OF THE FOLLOWING SYMPTOMS:

- Involuntary movements, eye or muscle twitching
- Muscle cramps
- Nausea, dizziness, or queasiness
- Convulsions
- Disorientation, confusion, or loss of awareness of your surroundings

Notice Concerning Format Compatibility

The Mitsubishi TVs will support the mandatory HDMI 1.4a 3D signals intended for the United States. Specifically, the TVs will support the 3D signals known as Frame Packing 1080p/24Hz and 720p/60Hz (primarily from Blu-ray players and gaming consoles), Side-by-Side in 1080i/60Hz, 1080p/24Hz/30Hz/60Hz and 720p/60Hz, Top/Bottom in 1080p/24Hz and 720p/60Hz, and Checkerboard 1080p/60Hz. However, there may be some 3D sources that are not compatible with the TVs. In all cases: (1) 3D sources must connect to the TVs using the HDMI inputs or via StreamTV™ Internet Media; and (2) Active Shutter 3D glasses that match the TV's internal synchronization emitter, or Active Shutter 3D glasses with their own external matching synchronization emitter connected to the rear of the TV or DLP Link Active Shutter 3D glasses are required in order to view 3D content.

Wireless Audio Playback (840 Series)

The TV's built-in speaker array can play audio from a handheld device using *Bluetooth*® A2DP (stereo audio) wireless technology.

Pairing the TV with an Audio Playback Device

1. Turn on the wireless device you wish to use for playback.
2. Press **INPUT** to display the **Input Selection** menu.
3. Highlight the **Bluetooth** icon and press **ENTER**.
4. Pair your device with the TV and then connect. Some devices pair and connect automatically, while others require you to enter the TV pass code displayed.
5. Use keys on the TV's remote control to control playback. Not all keys work for all devices.

Resetting Bluetooth Pairing or Connection

Perform this reset if the audio device does not connect properly to the TV.

1. If the audio device has been previously paired with the TV, delete the TV from the device's paired list.
2. Go to the TV's **Inputs > Name** menu and highlight the **Bluetooth** icon. Press **ENTER** to select **Off**.
3. Press **EXIT**.
4. Go to the **Inputs > Name** menu and highlight the **Bluetooth** icon. Press **ENTER** to select **On**.
5. Press **EXIT**.

Tips for Wireless Playback

- Selecting the **Bluetooth** icon at a later time will connect the TV again to the paired device.
- If the paired device is not available, the TV will accept pairing from a different device.
- Once connection is lost, the TV will power off after five minutes without receiving a signal.
- To clear a paired device, turn off the **Bluetooth** icon (**Inputs > Name** menu) or pair the TV with a different device.
- To remove the **Bluetooth** icon from the **Input Selection** menu, turn off the icon in the **Inputs > Name** menu.

Sound Projector (840 Series)

Sound Projector Technology

The TV's built-in speaker array can be adjusted to reflect sound off the room walls to create a surround sound effect. Setup can be performed either manually or automatically.

- To create the surround sound effect, the room walls must reflect sound and not be covered with sound-absorbent material.
- Repeat the setup procedure if you reconfigure the room's walls or furnishings.

Before You Begin

Positioning the TV

- Center the seating area in front of the TV and at least six feet away from it.
- Arrangements that give good results:

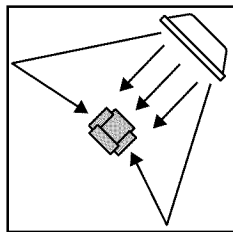
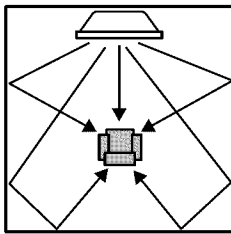

- If the room is an odd shape, locate the TV to take best advantage of wall reflections.

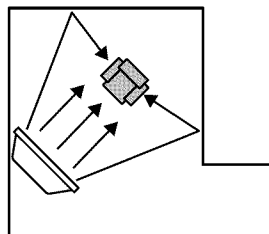
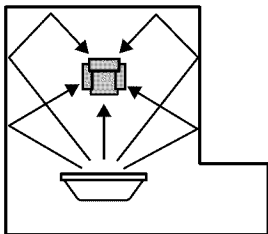

- Avoid locations that may distort sound reflections.

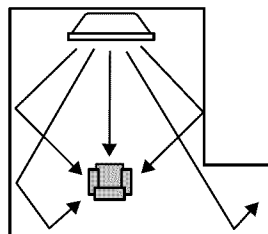
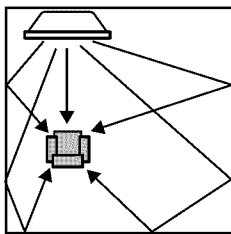

Connecting the TV

To hear digital surround sound, the TV must be connected to a digital surround sound source. The TV can receive digital surround sound from:

- Any HDMI jack
- The **ANT** input (from some digital broadcasts)

Other stereo connections will provide Dolby Pro Logic surround sound.

Microphone Placement for Auto Setup

- Make sure there are no large obstacles between the TV and microphone.
- Place the microphone
 - On a flat, level surface at least six feet away from the front of the TV.
 - On a tripod or on the backrest of your seating.
 - At the same height your ears would be when watching TV. The height must be within 3 vertical feet of the height of the TV's speaker array.
 - Centered in front of the TV, not off to the side.

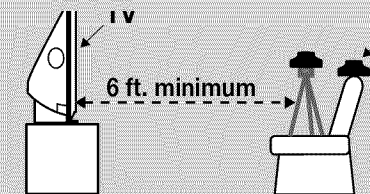

Microphone

Set the microphone on a level surface at ear height at least six feet from the TV. Use a seat backrest or tripod so as to pick up sound from all directions.

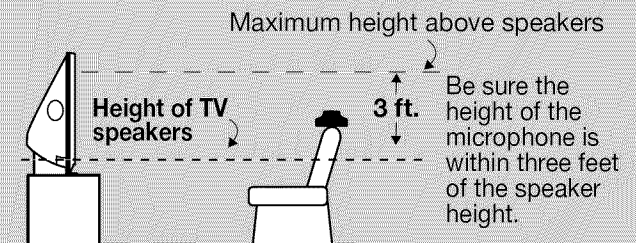

Maximum height above speakers

Height of TV speakers

3 ft.

Be sure the height of the microphone is within three feet of the speaker height.

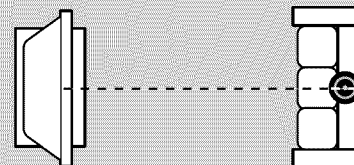

Microphone

Center the microphone in front of the TV.

Sound Projector, continued

Auto Setup

Auto setup uses a calibration microphone to optimize Sound Projector performance for most room conditions.

Initial Preparation

1. Position and connect the TV as described under “Before You Begin” on the previous page.
2. Power on the TV and external subwoofer, if any.
3. Plug the microphone cable into the TV’s **INPUT 1** left (white) audio jack.

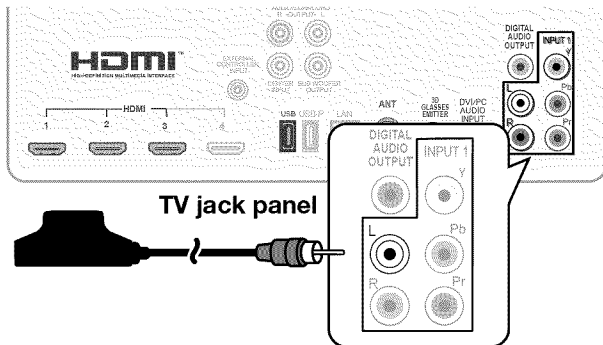



Connect microphone to the right (red) audio input jack.

4. Place the microphone as described in the guidelines on the previous page.

Start Auto Setup

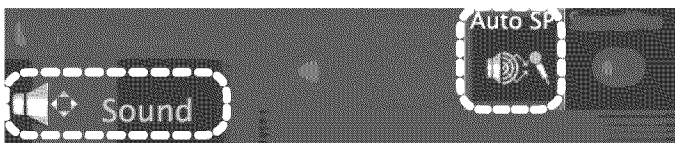
5. Press **MENU** and go to **Sound > AutoSP**.



6. Highlight **START** and press **ENTER**. 
7. Quietly exit the room right away. The calibration sequence will start in a few seconds and may be loud. It is important to leave the room as your presence will interfere with the calibration process.
8. Wait for completion of setup before returning to the room.
9. Play some sample audio material to check the sound quality.

Note: Do not perform manual adjustments after running Auto setup, as this will erase all settings defined during Auto setup.

10. Store the microphone out of direct sunlight and away from heat.

For assistance call 1(800) 332-2119

Basic Manual Setup

Note: If you have already performed Auto setup, do not make manual adjustments. Doing so will erase all settings created during Auto setup.

1. Press **MENU** and go to **Sound > SoundPro**.

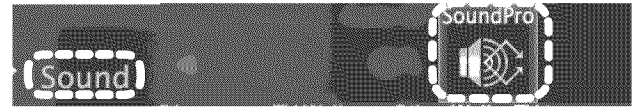

2. Enter the room dimensions and layout information requested in the screen. To change measurements, press **▲▼** or enter numbers on the remote control’s keypad.

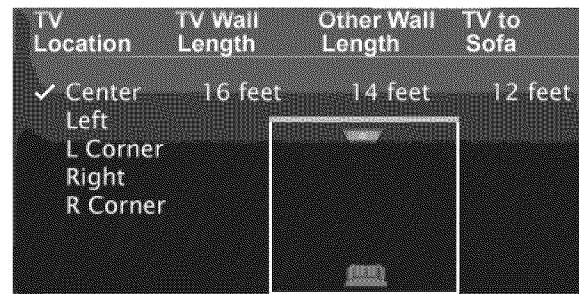

3. Press **EXIT** to exit and save settings.
4. Play some sample audio to check sound quality. If further adjustment is needed, use the **Custom** menu as described next.

Custom Menu

Use the **Custom** menu after defining the room layout.

For a room with large areas of curtains that might affect sound reflection, do the following:

- a. Open the curtains fully to improve sound reflection.
- b. Set angles by performing the procedure in “Adjusting Beam Angles.”
- c. Close the curtains.
- d. Set levels by performing the procedure in “Adjusting Levels.”

Sound Projector, continued

- From the **Sound > SoundPro** menu go to the **CUSTOM** menu.

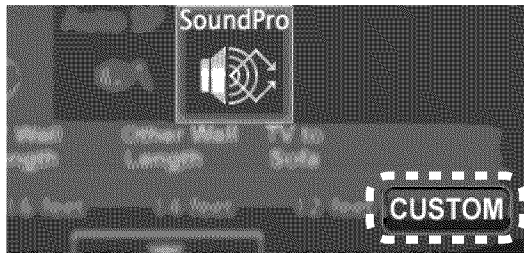

- Position yourself in your usual viewing location. Remain in this position, looking at the TV, while making the following adjustments.
- Adjusting Beam Angles**
 - Adjust **Center Beam Angle** until sound is about equal in both ears.
 - Adjust **Left Beam Angle** to maximize sound heard from the front left side.
 - Adjust **Right Beam Angle** to maximize sound heard from the front right side.
 - Adjust **Left Surround Beam Angle** to where the sound seems to come from the left rear side. If this cannot be achieved, make the setting the same as that for Left Beam Angle.
 - Adjust **Right Surround Beam Angle** to where the sound seems to come from the right rear side. If this cannot be achieved, make the setting the same as that for Right Beam Angle.
- Adjusting Levels**
 - Adjust **Center Level** to the mid level.
 - Adjust the following levels one at a time so that each one sounds about the same as the center level:
 - Left Level**
 - Right Level**
 - Left Surround Level**
 - Right Surround Level**
 - Check all sound levels by quickly switching between them using **▲ ▼**.
 - Readjust individual levels in small increments and recheck as above until all sound levels seem about the same.
- Adjusting an External Subwoofer**

Note: Set **Sound > Global > Subwoofer** to **On** to make this adjustment available.

 - Play sample video or music containing low-frequency bass sound.
 - Press **AUDIO**. Use **▲ ▼** to display the **Subwoofer** option.
 - Press **◀ ▶** to adjust the subwoofer volume.

Making Adjustments in the Custom Menu

- Press **▲ ▼** to select an audio beam; colors of the adjusters correspond to audio beams in the on-screen diagram.
- Press **◀ ▶** to redirect the audio beam or change the sound level.

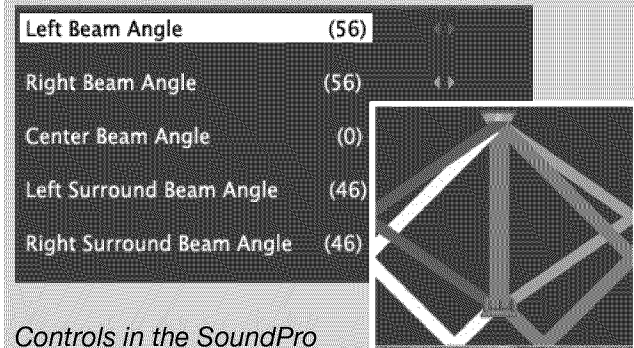

Controls in the **SoundPro > Custom** menu adjust the direction and focus of the TV's sound output.

At extreme beam angles, adjustment may be limited and the image on screen may not accurately represent the sound beams.



Adjust the volume level of individual audio beams using sliders in the **SoundPro > Custom** menu.

Resetting Angle and Level Values in the Custom Menu

Follow these steps to return settings to the default values.

- Press **EXIT** to clear all menus.
- Press **MENU**. Go to the **Sound > SoundPro** menu and press **ENTER**.
- Change any setting (e.g., **TV Location**).
- Press **EXIT** to clear all menus.
- Press **MENU**. Go to the **Sound > SoundPro** menu and press **ENTER**.
- Enter the correct values for the room layout.
- Return to the **CUSTOM** menu to adjust angles and levels.

Appendix A: Auto Input Sensing

About Auto Input Sensing

This TV's Easy Connect™ Auto Input Sensing feature detects the following connections automatically:

- Analog video jacks
- HDMI inputs (when powered on)

Auto Input Sensing for Most Devices

When you first connect a device, the TV will:

- Detect the connected device and automatically switch to it.
- Prompt you to identify the device type.
- Repeat these steps for other newly detected devices.

When You First Connect a Device

- **Most Device Types.** Select the device type from the on-screen list. The device type you select here will appear as an icon in the **Input Selection** menu.
- **A/V Receiver.** For an HDMI-equipped A/V receiver, select **AVR** from the list of device types if the A/V receiver is not recognized automatically.
- **HDMI CEC Devices Compatible with the TV's HDMI Control Feature.** Compatible CEC-enabled HDMI devices are often recognized automatically by the TV. HDMI Control may allow you to control some functions of a CEC-enabled device. See the supplemental Owner's Guide at www.mitsubishi-tv.com.

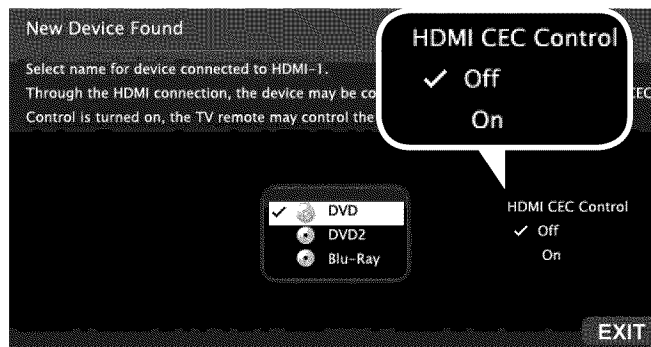

New Device Found screen for a device with HDMI control enabled. Select **On** if you want to enable the TV's HDMI control of the device. In some cases, as in the example, you will also be prompted to select a device name.

Tips on Auto Sensing

- Choose a different name for each input.
- The antenna input (**ANT**) and *Bluetooth*® are never auto-detected. You can remove the unused icons from the **Input Selection** menu in the **Inputs > Name** menu.
- Change the device type displayed in the **Input Selection** menu by using the **Inputs > Name** menu.
- Some HDMI devices can automatically tell the TV what name to use in the **Input Selection** menu and you will be unable to change the name.
- The TV is unable to detect a new connection if the current input is *Bluetooth*® or internet. Switch to a different input before connecting.

Reactivating Auto Input Sensing for an HDMI Input

After you disconnect an HDMI device, Auto Input Sensing is temporarily disabled and the disconnected device still appears in the **Input Selection** menu.

Perform these steps:

1. Power off the device.
2. Disconnect the HDMI cable.
3. Press **MENU** on the TV remote control to enter the TV main menu.
4. Go to **Inputs > Name**.
5. Highlight the HDMI input name and press **ENTER** to select **Delete**.
6. Press **EXIT** to clear the menus.

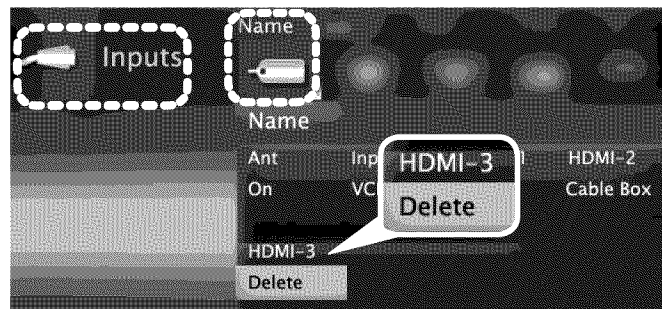

Inputs > Name menu with **Delete** selected for HDMI-3.

7. Connect the new device and the **New Device Found** screen will display.

Appendix B: Lamp-Cartridge Replacement

CAUTION: If the television is on, press **POWER** to turn it off. Unplug the television and allow it to cool for at least one hour before attempting to replace the lamp cartridge.

Lamp

The light source for this television is a lamp, which is part of a lamp cartridge assembly. The life of the lamp can vary, based on the lamp itself, the air temperature around the TV while it is operating, the selected lamp mode, and your viewing patterns. Warmer air or poor ventilation shorten the lamp life, as does setting **Lamp Energy** to **Bright** and turning the television on and off frequently.

Mitsubishi warrants the lamp for one (1) year from the date of original TV purchase at retail.

The lamp cartridge assembly is designed to be replaced by the TV owner. The cost of labor for a service technician to replace the lamp is not covered by the warranty.

Ordering a New Lamp

To Receive a Replacement Lamp Cartridge Assembly Under Warranty

- Visit our website at www.mitsuparts.com.
- Call (800) 553-7278. Please have model number, serial number, and TV purchase date available.

To Purchase a Replacement Lamp Cartridge Assembly After Warranty

Visit our website at www.mitsuparts.com or call (800) 553-7278. Order the following:

Lamp Part Number 915B455011

Lamp-Substitution Alert

MEVSA recommends that you use only genuine Replacement Lamp Assemblies purchased directly from Mitsubishi or a Mitsubishi Authorized Dealer or Mitsubishi Authorized Service Center. MEVSA advises that replacement lamps obtained separately from the Lamp Cartridge and/or Lamp Assemblies obtained from unauthorized sellers may be incorrect for your television, may not fit or perform properly and may even damage your television. MEVSA can not be responsible for the performance, reliability or safety of any replacement lamps that are obtained from unauthorized sources.

WARNING

- Do not remove the lamp cartridge immediately after turning off the television. You may get burned because the lamp is very hot. Allow the television to cool for at least one hour before replacing the lamp cartridge.
- Do not remove the lamp cartridge except when replacing it. Careless treatment can result in injury or fire.
- Do not touch the lamp glass element. It may be very hot and break, causing injuries or burns.
- Be sure not to insert any metal or flammable object into the lamp cartridge opening, as it may cause fire or electrical shock. If a foreign object is inserted into the opening, unplug the AC cord of the TV and contact your dealer for service.
- Install the lamp cartridge securely. Failure to do so may cause a fire.
- Do not touch the lamp glass elements. Oils from your fingers may cause premature lamp failure.

 = MERCURY

THE LAMP INSIDE THIS PRODUCT CONTAINS MERCURY AND MUST BE RECYCLED OR DISPOSED OF ACCORDING TO LOCAL, STATE OR FEDERAL LAWS. For disposal or recycling information, please contact your local authorities or the Electronic Industries Alliance at www.eiae.org



CAUTION



BURN DANGER! HOT SURFACES INSIDE!
Touch lamp cartridge handle only. Do not touch lamp or lamp cartridge housing. Keep lamp cartridge horizontal during removal. Do not tilt as glass may come out and cause injury. Replace lamp cartridge only with the same part number 915B455011.

WARNING

THE ACCESS PANEL IS PROVIDED WITH AN INTERLOCK TO REDUCE THE RISK OF EXCESSIVE ULTRAVIOLET RADIATION. DO NOT DEFEAT ITS PURPOSE OR ATTEMPT TO SERVICE WITHOUT REMOVING PANEL COMPLETELY.

Appendix B: Lamp-Cartridge Replacement, continued

Replacement Procedure

Removing the Old Lamp Cartridge

1. Turn off TV power and unplug the TV. Allow the lamp to cool for at least one hour before proceeding.
2. After the lamp has cooled, remove the cover of the lamp compartment, located on the back of the TV. Refer to figures 1 and 2. Use a #2 (medium) Phillips screwdriver to loosen the screws securing the cover. Keep the screws and cover for re-installation.
3. With a medium Phillips screwdriver, loosen the screw securing the lamp cartridge until it disengage from the mating threads. This is a captive screw and cannot be separated from the lamp cartridge.
4. Fully open the bag supplied with the replacement lamp and set the opened bag aside.
5. Gently grasp the handle of the lamp cartridge and pull the old cartridge straight out. See figure 3.

CAUTION: Do not tilt or rotate the cartridge, as small glass fragments may fall out.

6. Without tilting or putting down the lamp cartridge, insert it into the opened bag. Close the bag while being careful not to let any glass particles fall out.

Installing the New Lamp Cartridge

1. **Do not touch** the glass parts of the new lamp cartridge. Insert the new cartridge into the TV in the same orientation as the old cartridge. Push on the cartridge housing until it is fully seated.
2. Gently tighten the lamp screw with the screwdriver. **AVOID OVERTIGHTENING!**
3. Replace the plastic cover and retaining screws.
4. **WASH YOUR HANDS THOROUGHLY, AS THIS LAMP CONTAINS MERCURY.**

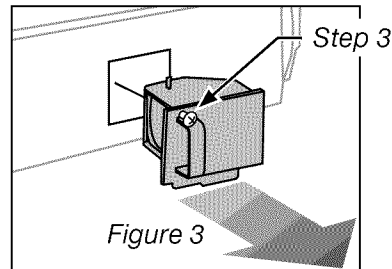
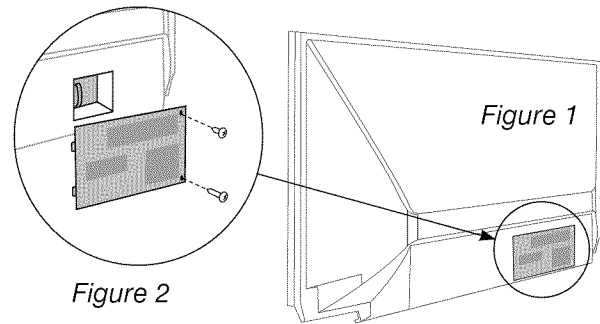

Use only replacement lamp part number 915B455011.

Disposal of the Old Lamp Cartridge

Contact your local authorities or the Electronic Industries Alliance at www.eiae.org for lamp-disposal or recycling instructions. Do not dispose of the old lamp with common trash.

Appendix C: Troubleshooting

TV Reset Comparison Guide

You can resolve many common TV problems using the reset functions described in the following table.

IMPORTANT

Before you change sound or picture settings: If picture or sound settings seem wrong for a broadcast channel (a channel from the **ANT** input, a cable box, or satellite receiver), first check other channels from the same input before changing settings. If most other

channels from the same input seem correct, there is likely a problem with the broadcast rather than with the TV. Use care in this case, as changes you make to fix problems on individual channels also affect all other channels on the same input.

Additional troubleshooting tips are in the supplemental Owner's Guide at www.mitsubishi-tv.com.

Reset Name	When to Use	How to Use	Resulting Action
Format	If the picture shape seems incorrect, use the FORMAT key to change the picture shape.	Press FORMAT to cycle through the picture shapes available for the signal.	The last-used format for the signal type will be recalled on the input. Note: Also check the aspect ratio feature on your cable box or satellite receiver as this may be altering the picture.
840 Series. PerfectColor™/ PerfectTint™ Reset (for the single current input)	When the color intensities seem out of balance, use the PerfectColor/PerfectTint reset to reset the color balances to the original factory settings. Both PerfectColor and PerfectTint are reset at the same time.	<ol style="list-style-type: none"> 1. While viewing the input to reset, press MENU and go to Picture > Perfect. 2. Press ENTER to display the PerfectColor adjustment screen. 3. Press CANCEL to reset the colors. 	All PerfectColor/PerfectTint sliders are reset to the original center position. The PerfectColor/PerfectTint settings for other inputs remain unchanged.
A/V Memory Reset (for the single current input)	When audio and/or video settings for a single input seem incorrect, use A/V Memory Reset to return the input to the original factory settings.	<ol style="list-style-type: none"> 1. While viewing the input to reset, press MENU and go to Picture > Reset. 2. Press ▼ to highlight Reset. 3. Press ENTER again to reset. 	Most Audio and Video settings for the individual input are reset except for the global settings for audio Balance, Listen To, Language, and Advanced.
A/V Reset (for all inputs)	To reset audio and video adjustments for all inputs to the original factory settings.	While viewing the TV, press the control-panel buttons INPUT and VOLUME DOWN at the same time for at least two seconds.	Most Audio and Video settings are returned to the original factory settings, including global settings not affected by Picture > Reset . Settings under Picture > Advanced are unaffected.
Channel Memorization	To erase and re-memorize channels on the ANT input.	<ol style="list-style-type: none"> 1. Press MENU and go to Setup > Channel. 2. Highlight the reception mode, e.g. Ant Air, and press ENTER. 3. Highlight All Channels and press ENTER. 4. Highlight Scan. 5. Press ENTER to start channel memorization. 	All previously memorized channels for the antenna input are erased and a new set of memorized channels is created. All channel information in the FAV menu, ChannelView, and Channel Lock is deleted. To add or delete individual channels, use the Setup > Channel > Edit menu.
Lock Menu Pass Code	To change your Lock menu pass code	Press the 9 and LAST keys simultaneously to temporarily unlock the TV. See the supplemental Owner's Guide at www.mitsubishi-tv.com for more.	

Appendix C: Troubleshooting, continued

Reset Name	When to Use	How to Use	Resulting Action
Control-Panel Lock Release	To re-enable the control-panel buttons after activation of the Control-Panel Lock	Press and hold the INPUT button on the control panel for ten seconds. If the TV is powered off, you can now press the POWER button to turn it on.	Allows the control panel to be unlocked if the remote control is misplaced.
System Reset	If the TV does not turn on or off, does not respond to the remote control or control-panel buttons, or has audio but no video.	Press and hold the POWER button on the control panel for ten seconds.	The TV will turn off. The green LED will flash quickly for about one minute. The changes you made most recently, before using SYSTEM RESET , may be lost.
TV Reset IMPORTANT: Use this reset only if other troubleshooting has been unsuccessful.	To reset all consumer-accessible settings and all memories to the original factory defaults. Use TV Reset if the TV can respond to controls but TV behavior is abnormal. CAUTION: All owner-performed setups and adjustments will be erased.	<ol style="list-style-type: none"> 1. While viewing the TV, press MENU to display the TV main menu. 2. With the main menu displayed, press number keys 1 2 3 to display the Reset menu. 3. READ THE ON-SCREEN WARNING AND INSTRUCTIONS. <ul style="list-style-type: none"> • If you do not wish to use this reset, press EXIT or MENU to back out. • If you wish to continue, press ENTER to erase all memories and settings. 	The TV will start the initialization process and then turn off. The front green LED will start flashing. All memory and settings outlined in this Owner's Guide will need to be set again.

Service and Customer Support

Service

If you are unable to correct a problem with your TV, consult Mitsubishi Consumer Relations at 1 (800) 332-2119.

- DO NOT adjust any controls other than those described in this Owner's Guide and the on-line supplemental Owner's Guide.
- DO NOT remove the protective back cover of your TV.

Customer Support

- To order replacement or additional remote controls, visit our website at www.mitsuparts.com or call 1 (800) 553-7278.
- For questions:
 - Call Consumer Relations at 1 (800) 332-2119.
 - E-mail: TVsupport@mevsa.com
 - Website: www.mitsubishi-tv.com

For assistance call 1(800) 332-2119

Appendix C: Troubleshooting, continued

Common Picture Problems

Symptom	Remarks
1. Picture does not look like a high-definition picture.	<p>Compare the picture to the TV's test picture (Picture > Picture+ menu) to check if the source signal is supplying a lesser-quality image.</p> <p>Not all signals are high-definition signals. To receive high-definition programming from your cable or satellite provider, you must subscribe to the provider's high-definition service. Some over-the-air broadcasts are in high-definition and can be received with a high-quality antenna suited to your location.</p>
2. TV has sound but no picture.	<ul style="list-style-type: none"> Press MENU on the remote control. If the menu displays, then there is a problem with the incoming signal. Check that all video inputs are plugged in firmly to the correct input jacks. Press and hold the POWER button on the control panel for ten seconds to perform System Reset.
3. A color program appears as a black and white image, or the colors are dim, or the screen is black.	<ul style="list-style-type: none"> If using component video, check that the red, green, and blue input cables are correctly connected to the red, green, and blue component video jacks. If using composite video, check that the incoming cable is connected to the TV's green Y/VIDEO jack. 840 Series. The PerfectColor color balance has been incorrectly set. Reset the PerfectColor balance.
4. Picture from an HDMI input is noisy (poor quality).	<ul style="list-style-type: none"> Compare the picture to the TV's test picture (Picture > Picture+ menu) to check the source of the noise. Upgrade a standard (unmarked) HDMI cable to a high-speed HDMI cable.

Front-Panel STATUS Light

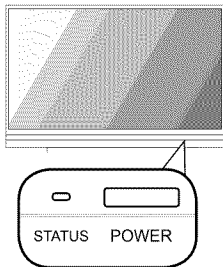

Key

- Off
- Steady On
- ◐ Slow Blinking
- ⊙ Fast Blinking

LED Color	TV Condition
Green ●	TV is powered on. Normal operation.
Green ◐	TV powered off, auto-on TV Timer is set. Normal operation. TV can be turned on at any time.
Green ⊙	TV just powered off and lamp is cooling. Sixty seconds after turning off TV, LED will start to blink. TV can be turned back on before blinking starts or after blinking stops, but not while the indicator is blinking. Normal operation.
Yellow ●	TV is too hot. The TV will display a warning message and shut off if it overheats. <ul style="list-style-type: none"> Ambient room temperature may be too high. Turn off the TV and let the room temperature drop. Clear blocked air vents. Ensure at least a four-inch clearance on all sides of the TV.
Yellow ◐	Lamp access door is not secure or no lamp installed. TV will not operate until lamp access door is secured. See Appendix B.
Red ●	Lamp failure. Replace the lamp. See Appendix B.
Red/ Yellow ◐	TV may require service. <ul style="list-style-type: none"> Hold power button on front panel for 10 seconds to reset TV. If LED continues to flash red and yellow after reset, unplug the TV from the AC power source. Wait one minute and then plug the set back in. If LED continues to flash red and yellow, go to www.mitsubishi-tv.com or call 1-800-332-2119 to receive Authorized Service Center information. You may be asked to count how many times the LED flashes each color to aid in troubleshooting.

Mitsubishi TV Software

END-USER LICENSE AGREEMENT FOR EMBEDDED SOFTWARE

IMPORTANT – READ CAREFULLY: This License Agreement is a legal agreement between you (either an individual or an entity) and Mitsubishi Electric Visual Solutions America, Inc. (MEVSA) for all software pre installed and/or provided along with this television (“Software”). By utilizing this television and Software, you agree to be bound by the terms of this License Agreement.

The Software is protected by United States copyright laws and international treaty provisions, as well as other intellectual property laws and treaties. The Software is licensed, not sold.

1. **LICENSE GRANT.** MEVSA grants you a non-exclusive, non-transferable, limited right and license to use one copy of the Software only with the Mitsubishi television model that included this owner’s guide and owned by you.

2. **RIGHTS AND LIMITATIONS.**

Software Not for Resale. You may not resell or otherwise transfer for value the Software, except in conjunction with a sale of the TV that Software has been pre installed.

Prohibition on Reverse Engineering, Decompilation and Disassembly. The Software contains trade secrets or other proprietary material in its human perceivable form and to protect them, you may not reverse engineer, decompile, or disassemble, or otherwise reduce the Software to any human perceivable form, except to the extent that the foregoing restriction is expressly prohibited by applicable law.

Separation of Components. The Software is licensed as a single product. Its component parts may not be separated for use on more than one TV.

No Rental. You may not rent, lease, lend, or sublicense the Software.

Trademarks. This License Agreement does not grant you any rights to any trademarks of MEVSA.

Updates. MEVSA may elect, but shall be under no obligation, to provide you with customer support and/or software upgrades, enhancements, or modifications to the Software. Depending on the Mitsubishi TV model and internet access capability, MEVSA may directly, or indirectly via third parties, update or change such Software, in whole or in part, at any time and without notice to you.

3. **VIOLATIONS.** You understand that any use, copying or transfer of the Software, except as permitted pursuant to this License, may subject you to serious criminal and civil penalties including damages and an award to MEVSA of attorneys’ fees in connection with any violation of this License. You further understand that you may be held legally responsible for any copyright infringement or other violation of intellectual property rights that is caused, encouraged, or induced by your failure to abide by the terms of the License. This license is effective until terminated, and will terminate immediately without notice from MEVSA or judicial resolution if you fail to comply with any provision of this License.

4. **COPYRIGHT.** All title and intellectual property rights in and to the Software (including but not limited to any images, photographs, animations, video, audio, music, text, and “applets” incorporated into the Software), and any accompanying printed materials are owned by or licensed to MEVSA. All title and intellectual property rights in and to the content which may be accessed through use of the Software is the property of the respective content owner and may be protected by applicable copyright or other intellectual property laws and treaties. This License Agreement grants you no rights to use such content, except that you own the media on which the Software is recorded, but MEVSA and its licensors retain ownership of the Software itself. All rights not expressly granted are reserved by MEVSA.

5. **EXPORT RESTRICTIONS.** MEVSA is licensing the Software for use within the United States. You agree that you will not export or re-export the Software. You specifically agree not to export or re-export the Software: (i) to any country to which the U.S. has embargoed or restricted the export of goods or services, which currently include, but are not necessarily limited to Cuba, Iran, Iraq, Libya, North Korea, Sudan, and Syria, or to any national of any such country, wherever located, who intends to transmit or transport the Software back to such country; (ii) to any person or entity who you know or have reason to know will utilize the Software in the design, development, or production of nuclear, chemical, or biological weapons; or (iii) to any person or entity who has been prohibited from participating in U.S. export transactions by any federal agency of the U.S. government. You warrant and represent that neither the BXA nor any other U.S. federal agency has suspended, revoked, or denied your export privileges.

6. **DISCLAIMER OF WARRANTY. EXCEPT AS OTHERWISE PROVIDED IN THIS LICENSE OR IN THE LIMITED WARRANTY APPLICABLE TO THE TV, MEVSA MAKES NO OTHER WARRANTIES OF ANY KIND WHATSOEVER REGARDING THE SOFTWARE AND HEREBY EXPRESSLY DISCLAIMS ALL WARRANTIES OF ANY KIND WHATSOEVER, EXPRESS OR IMPLIED, WITH RESPECT TO THE SOFTWARE. ALL IMPLIED WARRANTIES, INCLUDING, WITHOUT LIMITATION, THE IMPLIED WARRANTIES OF MERCHANTABILITY AND FITNESS FOR A PARTICULAR PURPOSE ARE HEREBY EXPRESSLY DISCLAIMED BY MEVSA. IN NO EVENT SHALL MEVSA BE LIABLE TO YOU OR ANY THIRD PARTIES, IN CONTRACT, IN TORT OR OTHERWISE, FOR ANY DIRECT, INDIRECT, SPECIAL, INCIDENTAL OR CONSEQUENTIAL DAMAGES OF ANY KIND OR NATURE. BECAUSE SOME JURISDICTIONS DO NOT ALLOW THE EXCLUSION OR LIMITATION OF IMPLIED WARRANTIES, THE ABOVE LIMITATION MAY NOT APPLY TO YOU.**

7. **LIMITATION OF LIABILITY. MEVSA SHALL NOT, UNDER ANY CIRCUMSTANCES BE LIABLE TO YOU OR ANY THIRD PARTIES FOR ANY DAMAGES OF ANY NATURE, WHETHER INDIRECT, SPECIAL, INCIDENTAL, CONSEQUENTIAL OR OTHERWISE, INCLUDING, BUT NOT LIMITED TO, ANY CLAIMS FOR LOST PROFITS, LOSS OF GOOD WILL OR EXPENDITURES MADE OR COMMITTED FOR IN RELIANCE ON THE CONTINUATION OF THIS LICENSE. YOU AGREE THAT NEITHER MEVSA’S BREACH OF THIS LICENSE NOR ITS FAILURE TO REPAIR A DEFECT, ERROR OR BUG SHALL CONSTITUTE A FAILURE OF THE ESSENTIAL PURPOSE OF THIS LICENSE. BECAUSE SOME JURISDICTIONS DO NOT ALLOW THE EXCLUSION OR LIMITATION OF LIABILITY FOR CONSEQUENTIAL OR INCIDENTAL DAMAGES, THE ABOVE LIMITATIONS MAY NOT APPLY TO YOU. MEVSA’S liability to you for direct damages for any cause whatsoever and regardless of the form of the action, will be limited to the money paid by you for the TV (based on fair market value of the TV) that caused the damages.**

8. **GENERAL.** This License Agreement will be governed by the laws of the State of California.

GNU General Public License

Version 2, June 1991

Copyright (C) 1989, 1991

Free Software Foundation, Inc.

675 Mass Ave, Cambridge, MA 02139, USA

Everyone is permitted to copy and distribute verbatim copies of this license document, but changing it is not allowed.

Preamble

The licenses for most software are designed to take away your freedom to share and change it. By contrast, the GNU General Public License is intended to guarantee your freedom to share and change free software--to make sure the software is free for all its users. This General Public License applies to most of the Free Software Foundation's software and to any other program whose authors commit to using it. (Some other Free Software Foundation software is covered by the GNU Library General Public License instead.) You can apply it to your programs, too.

When we speak of free software, we are referring to freedom, not price. Our General Public Licenses are designed to make sure that you have the freedom to distribute copies of free software (and charge for this service if you wish), that you receive source code or can get it if you want it, that you can change the software or use pieces of it in new free programs; and that you know you can do these things.

To protect your rights, we need to make restrictions that forbid anyone to deny you these rights or to ask you to surrender the rights. These restrictions translate to certain responsibilities for you if you distribute copies of the software, or if you modify it.

For example, if you distribute copies of such a program, whether gratis or for a fee, you must give the recipients all the rights that you have. You must make sure that they, too, receive or can get the source code. And you must show them these terms so they know their rights.

We protect your rights with two steps: (1) copyright the software, and (2) offer you this license which gives you legal permission to copy, distribute and/or modify the software.

Also, for each author's protection and ours, we want to make certain that everyone understands that there is no warranty for this free software. If the software is modified by someone else and passed on, we want its recipients to know that what they have is not the original, so that any problems introduced by others will not reflect on the original authors' reputations.

Finally, any free program is threatened constantly by software patents. We wish to avoid the danger that redistributors of a free program will individually obtain patent licenses, in effect making the program proprietary. To prevent this, we have made it clear that any patent must be licensed for everyone's free use or not licensed at all.

The precise terms and conditions for copying, distribution and modification follow.

GNU GENERAL PUBLIC LICENSE

TERMS AND CONDITIONS FOR COPYING, DISTRIBUTION AND MODIFICATION

0. This License applies to any program or other work which contains a notice placed by the copyright holder saying it may be distributed under the terms of this General Public License. The "Program", below, refers to any such program or work, and a "work based on the Program" means either the Program or any derivative work under copyright law; that is to say, a work containing the Program or a portion of it, either verbatim or with modifications and/or translated into another language. (Hereinafter, translation is included without limitation in the term "modification".) Each licensee is addressed as "you".

Activities other than copying, distribution and modification are not covered by this License; they are outside its scope. The act of running the Program is not restricted, and the output from the Program is covered only if its contents constitute a work based on the Program (independent of having been made by running the Program). Whether that is true depends on what the Program does.

1. You may copy and distribute verbatim copies of the Program's source code as you receive it, in any medium, provided that you conspicuously and appropriately publish on each copy an appropriate copyright notice and disclaimer of warranty; keep intact all the notices that refer to this License and to the absence of any warranty; and give any other recipients of the Program a copy of this License along with the Program.

You may charge a fee for the physical act of transferring a copy, and you may at your option offer warranty protection in exchange for a fee.

2. You may modify your copy or copies of the Program or any portion of it, thus forming a work based on the Program, and copy and distribute such modifications or work under the terms of Section 1 above, provided that you also meet all of these conditions:

- You must cause the modified files to carry prominent notices stating that you changed the files and the date of any change.
- You must cause any work that you distribute or publish, that in whole or in part contains or is derived from the Program or any part thereof, to be licensed as a whole at no charge to all third parties under the terms of this License.
- If the modified program normally reads commands interactively when run, you must cause it, when started running for such interactive use in the most ordinary way, to print or display an announcement including an appropriate copyright notice and a notice that there is no warranty (or else, saying that you provide a warranty) and that users may redistribute the program under these conditions, and telling the user how to view a copy of this License. (Exception: if the Program itself is interactive but does not normally print such an announcement, your work based on the Program is not required to print an announcement.)

These requirements apply to the modified work as a whole. If identifiable sections of that work are not derived from the Program, and can be reasonably considered independent and separate works in themselves, then this License, and its terms, do not apply to those sections when you distribute them as separate works. But when you distribute the same sections as part of a whole which is a work based on the Program, the distribution of the whole must be on the terms of this License, whose permissions for other licensees extend to the entire whole, and thus to each and every part regardless of who wrote it.

Thus, it is not the intent of this section to claim rights or contest your rights to work written entirely by you; rather, the intent is to exercise the right to control the distribution of derivative or collective works based on the Program.

In addition, mere aggregation of another work not based on the Program with the Program (or with a work based on the Program) on a volume of a storage or distribution medium does not bring the other work under the scope of this License.

3. You may copy and distribute the Program (or a work based on it, under Section 2) in object code or executable form under the terms of Sections 1 and 2 above provided that you also do one of the following:

- Accompany it with the complete corresponding machine-readable source code, which must be distributed under the terms of Sections 1 and 2 above on a medium customarily used for software interchange; or,
- Accompany it with a written offer, valid for at least three years, to give any third party, for a charge no more than your cost of physically performing source distribution, a complete machine-readable copy of the corresponding source code, to be distributed under the terms of Sections 1 and 2 above on a medium customarily used for software interchange; or,
- Accompany it with the information you received as to the offer to distribute corresponding source code. (This alternative is allowed only for noncommercial distribution and only if you received the program in object code or executable form with such an offer, in accord with Subsection b above.)

The source code for a work means the preferred form of the work for making modifications to it. For an executable work, complete source code means all the source code for all modules it contains, plus any associated interface definition files, plus the scripts used to control compilation and installation of the executable. However, as a special exception, the source code distributed need not include anything that is normally distributed (in either source or binary form) with the major components (compiler, kernel, and so on) of the operating system on which the executable runs, unless that component itself accompanies the executable.

If distribution of executable or object code is made by offering access to copy from a designated place, then offering equivalent access to copy the source code from the same place counts as distribution of the source code, even though third parties are not compelled to copy the source along with the object code.

4. You may not copy, modify, sublicense, or distribute the Program except as expressly provided under this License. Any attempt otherwise to copy, modify, sublicense or distribute the Program is void, and will automatically terminate your rights under this License. However, parties who have received copies, or rights, from you under this License will not have their licenses terminated so long as such parties remain in full compliance.

5. You are not required to accept this License, since you have not signed it. However, nothing else grants you permission to modify or distribute the Program or its derivative works. These actions are prohibited by law if you do not accept this License. Therefore, by modifying or distributing the Program (or any work based on the Program), you indicate your acceptance of this License to do so, and all its terms and conditions for copying, distributing or modifying the Program or works based on it.

6. Each time you redistribute the Program (or any work based on the Program), the recipient automatically receives a license from the original licensor to copy, distribute or modify the Program subject to these terms and conditions. You may not impose any further restrictions on the recipients' exercise of the rights granted herein. You are not responsible for enforcing compliance by third parties to this License.

7. If, as a consequence of a court judgment or allegation of patent infringement or for any other reason (not limited to patent issues), conditions are imposed on you (whether by court order, agreement or otherwise) that contradict the conditions of this License, they do not excuse you from the conditions of this License. If you cannot distribute so as to satisfy simultaneously your obligations under this License and any other pertinent obligations, then as a consequence you may not distribute the Program at all. For example, if a patent license would not permit royalty-free redistribution of the Program by all those who receive copies directly or indirectly through you, then the only way you could satisfy both it and this License would be to refrain entirely from distribution of the Program.

If any portion of this section is held invalid or unenforceable under any particular circumstance, the balance of the section is intended to apply and the section as a whole is intended to apply in other circumstances.

It is not the purpose of this section to induce you to infringe any patents or other property right claims or to contest validity of any such claims; this section has the sole purpose of protecting the integrity of the free software distribution system, which is implemented by public license practices. Many people have made generous contributions to the wide range of software distributed through that system in reliance on consistent application of that system; it is up to the author/donor to decide if he or she is willing to distribute software through any other system and a licensee cannot impose that choice.

This section is intended to make thoroughly clear what is believed to be a consequence of the rest of this License.

8. If the distribution and/or use of the Program is restricted in certain countries either by patents or by copyrighted interfaces, the original copyright holder who places the Program under this License may add an explicit geographical distribution limitation excluding those countries, so that distribution is permitted only in or among countries not thus excluded. In such case, this License incorporates the limitation as if written in the body of this License.

9. The Free Software Foundation may publish revised and/or new versions of the General Public License from time to time. Such new versions will be similar in spirit to the present version, but may differ in detail to address new problems or concerns.

Each version is given a distinguishing version number. If the Program specifies a version number of this License which applies to it and "any later version", you have the option of following the terms and conditions either of that version or of any later version published by the Free Software Foundation. If the Program does not specify a version number of this License, you may choose any version ever published by the Free Software Foundation.

If you are interested in obtaining open source code for this product, please contact Mitsubishi at 1 (800) 332-2119. A nominal handling and mailing charge may apply.

For assistance call 1(800) 332-2119

10. If you wish to incorporate parts of the Program into other free programs whose distribution conditions are different, write to the author to ask for permission. For software which is copyrighted by the Free Software Foundation, write to the Free Software Foundation; we sometimes make exceptions for this. Our decision will be guided by the two goals of preserving the free status of all derivatives of our free software and of promoting the sharing and reuse of software generally.

NO WARRANTY

11. BECAUSE THE PROGRAM IS LICENSED FREE OF CHARGE, THERE IS NO WARRANTY FOR THE PROGRAM, TO THE EXTENT PERMITTED BY APPLICABLE LAW. EXCEPT WHEN OTHERWISE STATED IN WRITING THE COPYRIGHT HOLDERS AND/OR OTHER PARTIES PROVIDE THE PROGRAM "AS IS" WITHOUT WARRANTY OF ANY KIND, EITHER EXPRESSED OR IMPLIED, INCLUDING, BUT NOT LIMITED TO, THE IMPLIED WARRANTIES OF MERCHANTABILITY AND FITNESS FOR A PARTICULAR PURPOSE. THE ENTIRE RISK AS TO THE QUALITY AND PERFORMANCE OF THE PROGRAM IS WITH YOU. SHOULD THE PROGRAM PROVE DEFECTIVE, YOU ASSUME THE COST OF ALL NECESSARY SERVICING, REPAIR OR CORRECTION.

12. IN NO EVENT UNLESS REQUIRED BY APPLICABLE LAW OR AGREED TO IN WRITING WILL ANY COPYRIGHT HOLDER, OR ANY OTHER PARTY WHO MAY MODIFY AND/OR REDISTRIBUTE THE PROGRAM AS PERMITTED ABOVE, BE LIABLE TO YOU FOR DAMAGES, INCLUDING ANY GENERAL, SPECIAL, INCIDENTAL OR CONSEQUENTIAL DAMAGES ARISING OUT OF THE USE OR INABILITY TO USE THE PROGRAM (INCLUDING BUT NOT LIMITED TO LOSS OF DATA OR DATA BEING RENDERED INACCURATE OR LOSSES SUSTAINED BY YOU OR THIRD PARTIES OR A FAILURE OF THE PROGRAM TO OPERATE WITH ANY OTHER PROGRAMS), EVEN IF SUCH HOLDER OR OTHER PARTY HAS BEEN ADVISED OF THE POSSIBILITY OF SUCH DAMAGES.

GNU GENERAL PUBLIC LICENSE

Version 3, 29 June 2007

Copyright © 2007 Free Software Foundation, Inc. <<http://fsf.org/>>

Everyone is permitted to copy and distribute verbatim copies of this license document, but changing it is not allowed.

Preamble

The GNU General Public License is a free, copyleft license for software and other kinds of works.

The licenses for most software and other practical works are designed to take away your freedom to share and change the works. By contrast, the GNU General Public License is intended to guarantee your freedom to share and change all versions of a program—to make sure it remains free software for all its users. We, the Free Software Foundation, use the GNU General Public License for most of our software; it applies also to any other work released this way by its authors. You can apply it to your programs, too.

When we speak of free software, we are referring to freedom, not price. Our General Public Licenses are designed to make sure that you have the freedom to distribute copies of free software (and charge for them if you wish), that you receive source code or can get it if you want it, that you can change the software or use pieces of it in new free programs, and that you know you can do these things.

To protect your rights, we need to prevent others from denying you these rights or asking you to surrender the rights. Therefore, you have certain responsibilities if you distribute copies of the software, or if you modify it: responsibilities to respect the freedom of others.

For example, if you distribute copies of such a program, whether gratis or for a fee, you must pass on to the recipients the same freedoms that you received. You must make sure that they, too, receive or can get the source code. And you must show them these terms so they know their rights.

Developers that use the GNU GPL protect your rights with two steps: (1) assert copyright on the software, and (2) offer you this License giving you legal permission to copy, distribute and/or modify it.

For the developers' and authors' protection, the GPL clearly explains that there is no warranty for this free software. For both users' and authors' sake, the GPL requires that modified versions be marked as changed, so that their problems will not be attributed erroneously to authors of previous versions.

Some devices are designed to deny users access to install or run modified versions of the software inside them, although the manufacturer can do so. This is fundamentally incompatible with the aim of protecting users' freedom to change the software. The systematic pattern of such abuse occurs in the area of products for individuals to use, which is precisely where it is most unacceptable. Therefore, we have designed this version of the GPL to prohibit the practice for those products. If such problems arise substantially in other domains, we stand ready to extend this provision to those domains in future versions of the GPL, as needed to protect the freedom of users. Finally, every program is threatened constantly by software patents. States should not allow patents to restrict development and use of software on general-purpose computers, but in those that do, we wish to avoid the special danger that patents applied to a free program could make it effectively proprietary. To prevent this, the GPL assures that patents cannot be used to render the program non-free.

The precise terms and conditions for copying, distribution and modification follow.

TERMS AND CONDITIONS

0. Definitions.

"This License" refers to version 3 of the GNU General Public License.

"Copyright" also means copyright-like laws that apply to other kinds of works, such as semiconductor masks.

"The Program" refers to any copyrightable work licensed under this License. Each licensee is addressed as "you", "Licensees" and "recipients" may be individuals or organizations.

To "modify" a work means to copy from or adapt all or part of the work in a fashion requiring copyright permission, other than the making of an exact copy. The resulting work is called a "modified version" of the earlier work or a work "based on" the earlier work.

A "covered work" means either the unmodified Program or a work based on the Program.

To "propagate" a work means to do anything with it that, without permission, would make you directly or secondarily liable for infringement under applicable copyright law, except executing it on a computer or modifying a private copy. Propagation includes copying, distribution (with or without modification), making available to the public, and in some countries other activities as well.

To "convey" a work means any kind of propagation that enables other parties to make or receive copies. Mere interaction with a user through a computer network, with no transfer of a copy, is not conveying.

An interactive user interface displays "Appropriate Legal Notices" to the extent that it includes a convenient and prominently visible feature that (1) displays an appropriate copyright notice, and (2) tells the user that there is no warranty for the work (except to the extent that warranties are provided), that licensees may convey the work under this License, and how to view a copy of this License. If the interface presents a list of user commands or options, such as a menu, a prominent item in the list meets this criterion.

1. Source Code.

The "source code" for a work means the preferred form of the work for making modifications to it. "Object code" means any non-source form of a work.

A "Standard Interface" means an interface that either is an official standard defined by a recognized standards body, or, in the case of interfaces specified for a particular programming language, one that is widely used among developers working in that language.

The "System Libraries" of an executable work include anything, other than the work as a whole, that (a) is included in the normal form of packaging a Major Component, but which is not part of that Major Component, and (b) serves only to enable use of the work with that Major Component, or to implement a Standard Interface for which an implementation is available to the public in source code form. A "Major Component", in this context, means a major essential component (kernel, window system, and so on) of the specific operating system (if any) on which the executable work runs, or a compiler used to produce the work, or an object code interpreter used to run it. The "Corresponding Source" for a work in object code form means all the source code needed to generate, install, and for an executable work run the object code and to modify the work, including scripts to control those activities. However, it does not include the work's System Libraries, or general-purpose tools or generally available free programs which are used unmodified in performing those activities but which are not part of the work. For example, Corresponding Source includes interface definition files associated with source files for the work, and the source code for shared libraries and dynamically linked subprograms that the work is specifically designed to require, such as by intimate data communication or control flow between those subprograms and other parts of the work.

The Corresponding Source need not include anything that users can regenerate automatically from other parts of the Corresponding Source.

The Corresponding Source for a work in source code form is that same work.

2. Basic Permissions.

All rights granted under this License are granted for the term of copyright on the Program, and are irrevocable provided the stated conditions are met. This License explicitly affirms your unlimited permission to run the unmodified Program. The output from running a covered work is covered by this License only if the output, given its content, constitutes a covered work. This License acknowledges your rights of fair use or other equivalent, as provided by copyright law.

You may make, run and propagate covered works that you do not convey, without conditions so long as your license otherwise remains in force. You may convey covered works to others for the sole purpose of having them make modifications exclusively for you, or provide you with facilities for running those works, provided that you comply with the terms of this License in conveying all material for which you do not control copyright. Those thus making or running the covered works for you must do so exclusively on your behalf, under your direction and control, on terms that prohibit them from making any copies of your copyrighted material outside their relationship with you.

Conveying under any other circumstances is permitted solely under the conditions stated below. Sublicensing is not allowed; section 10 makes it unnecessary.

3. Protecting Users' Legal Rights From Anti-Circumvention Law.

No covered work shall be deemed part of an effective technological measure under any applicable law fulfilling obligations under article 11 of the WIPO copyright treaty adopted on 20 December 1996, or similar laws prohibiting or restricting circumvention of such measures.

When you convey a covered work, you waive any legal power to forbid circumvention of technological measures to the extent such circumvention is effected by exercising rights under this License with respect to the covered work, and you disclaim any intention to limit operation or modification of the work as a means of enforcing, against the work's users, your or third parties' legal rights to forbid circumvention of technological measures.

4. Conveying Verbatim Copies.

You may convey verbatim copies of the Program's source code as you receive it, in any medium, provided that you conspicuously and appropriately publish on each copy an appropriate copyright notice; keep intact all notices stating that this License and any non-permissive terms added in accord with section 7 apply to the code; keep intact all notices of the absence of any warranty; and give all recipients a copy of this License along with the Program.

You may charge any price or no price for each copy that you convey, and you may offer support or warranty protection for a fee.

5. Conveying Modified Source Versions.

You may convey a work based on the Program, or the modifications to produce it from the Program, in the form of source code under the terms of section 4, provided that you also meet all of these conditions:

a) The work must carry prominent notices stating that you modified it, and giving a relevant date.

b) The work must carry prominent notices stating that it is released under this License and any conditions added under section 7. This requirement modifies the requirement in section 4 to "keep intact all notices".

c) You must license the entire work, as a whole, under this License to anyone who comes into possession of a copy. This License will therefore apply, along with any applicable section 7 additional terms, to the whole of the work, and all its parts, regardless of how they are packaged. This License gives no permission to license the work in any other way, but it does not invalidate such permission if you have separately received it.

d) If the work has interactive user interfaces, each must display Appropriate Legal Notices; however, if the Program has interactive interfaces that do not display Appropriate Legal Notices, your work need not make them do so.

A compilation of a covered work with other separate and independent works, which are not by their nature extensions of the covered work, and which are not combined with it such as to form a larger program, in or on a volume of a storage or distribution medium, is called an "aggregate" if the compilation and its resulting copyright are not used to limit the access or legal rights of the compilation's users beyond what the individual works permit. Inclusion of a covered work in an aggregate does not cause this License to apply to the other parts of the aggregate.

6. Conveying Non-Source Forms.

You may convey a covered work in object code form under the terms of sections 4 and 5, provided that you also convey the machine-readable Corresponding Source under the terms of this License, in one of these ways:

a) Convey the object code in, or embodied in, a physical product (including a physical distribution medium), accompanied by the Corresponding Source fixed on a durable physical medium customarily used for software interchange.

b) Convey the object code in, or embodied in, a physical product (including a physical distribution medium), accompanied by a written offer, valid for at least three years and valid for as long as you offer spare parts or customer support for that product model, to give anyone who possesses the object code either (1) a copy of the Corresponding Source for all the software in the product that is covered by this License, on a durable physical medium customarily used for software interchange, for a price no more than your reasonable cost of physically performing this conveying of source, or (2) access to copy the Corresponding Source from a network server at no charge.

c) Convey individual copies of the object code with a copy of the written offer to provide the Corresponding Source. This alternative is allowed only occasionally and noncommercially, and only if you received the object code with such an offer, in accord with subsection 6b.

d) Convey the object code by offering access from a designated place (gratis or for a charge), and offer equivalent access to the Corresponding Source in the same way through the same place at no further charge. You need not require recipients to copy the Corresponding Source along with the object code. If the place to copy the object code is a network server, the Corresponding Source may be on a different server (operated by you or a third party) that supports equivalent copying facilities, provided you maintain clear directions next to the object code saying where to find the Corresponding Source. Regardless of what server hosts the Corresponding Source, you

For assistance call 1(800) 332-2119

remain obligated to ensure that it is available for as long as needed to satisfy these requirements.

e) Convey the object code using peer-to-peer transmission, provided you inform other peers where the object code and Corresponding Source of the work are being offered to the general public at no charge under subsection 6d.

A separable portion of the object code, whose source code is excluded from the Corresponding Source as a System Library, need not be included in conveying the object code work.

A "User Product" is either (1) a "consumer product", which means any tangible personal property which is normally used for personal, family, or household purposes, or (2) anything designed or sold for incorporation into a dwelling. In determining whether a product is a consumer product, doubtful cases shall be resolved in favor of coverage. For a particular product received by a particular user, "normally used" refers to a typical or common use of that class of product, regardless of the status of the particular user or of the way in which the particular user actually uses, or expects or is expected to use, the product. A product is a consumer product regardless of whether the product has substantial commercial, industrial or non-consumer uses, unless such uses represent the only significant mode of use of the product.

"Installation Information" for a User Product means any methods, procedures, authorization keys, or other information required to install and execute modified versions of a covered work in that User Product from a modified version of its Corresponding Source. The information must suffice to ensure that the continued functioning of the modified object code is in no case prevented or interfered with solely because modification has been made.

If you convey an object code work under this section in, or with, or specifically for use in, a User Product, and the conveying occurs as part of a transaction in which the right of possession and use of the User Product is transferred to the recipient in perpetuity or for a fixed term (regardless of how the transaction is characterized), the Corresponding Source conveyed under this section must be accompanied by the Installation Information. But this requirement does not apply if neither you nor any third party retains the ability to install modified object code on the User Product (for example, the work has been installed in ROM).

The requirement to provide Installation Information does not include a requirement to continue to provide support service, warranty, or updates for a work that has been modified or installed by the recipient, or for the User Product in which it has been modified or installed. Access to a network may be denied when the modification itself materially and adversely affects the operation of the network or violates the rules and protocols for communication across the network.

Corresponding Source conveyed, and Installation Information provided, in accord with this section must be in a format that is publicly documented (and with an implementation available to the public in source code form), and must require no special password or key for unpacking, reading or copying.

7. Additional Terms.

"Additional permissions" are terms that supplement the terms of this License by making exceptions from one or more of its conditions. Additional permissions that are applicable to the entire Program shall be treated as though they were included in this License, to the extent that they are valid under applicable law. If additional permissions apply only to part of the Program, that part may be used separately under those permissions, but the entire Program remains governed by this License without regard to the additional permissions.

When you convey a copy of a covered work, you may at your option remove any additional permissions from that copy, or from any part of it. (Additional permissions may be written to require their own removal in certain cases when you modify the work.) You may place additional permissions on material, added by you to a covered work, for which you have or can give appropriate copyright permission.

Notwithstanding any other provision of this License, for material you add to a covered work, you may (if authorized by the copyright holders of that material) supplement the terms of this License with terms:

- Disclaiming warranty or limiting liability differently from the terms of sections 15 and 16 of this License; or
- Requiring preservation of specified reasonable legal notices or author attributions in that material or in the Appropriate Legal Notices displayed by works containing it; or
- Prohibiting misrepresentation of the origin of that material, or requiring that modified versions of such material be marked in reasonable ways as different from the original version; or
- Limiting the use for publicity purposes of names of licensors or authors of the material; or
- Declining to grant rights under trademark law for use of some trade names, trademarks, or service marks; or
- Requiring indemnification of licensors and authors of that material by anyone who conveys the material (or modified versions of it) with contractual assumptions of liability to the recipient, for any liability that these contractual assumptions directly impose on those licensors and authors.

All other non-permissive additional terms are considered "further restrictions" within the meaning of section 10. If the Program as you received it, or any part of it, contains a notice stating that it is governed by this License along with a term that is a further restriction, you may remove that term. If a license document contains a further restriction but permits relicensing or conveying under this License, you may add to a covered work material governed by the terms of that license document, provided that the further restriction does not survive such relicensing or conveying.

If you add terms to a covered work in accord with this section, you must place, in the relevant source files, a statement of the additional terms that apply to those files, or a notice indicating where to find the applicable terms.

Additional terms, permissive or non-permissive, may be stated in the form of a separately written license, or stated as exceptions; the above requirements apply either way.

8. Termination.

You may not propagate or modify a covered work except as expressly provided under this License. Any attempt otherwise to propagate or modify it is void, and will automatically terminate your rights under this License (including any patent licenses granted under the third paragraph of section 11).

However, if you cease all violation of this License, then your license from a particular copyright holder is reinstated (a) provisionally, unless and until the copyright holder explicitly and finally terminates your license, and (b) permanently, if the copyright holder fails to notify you of the violation by some reasonable means prior to 60 days after the cessation.

Moreover, your license from a particular copyright holder is reinstated permanently if the copyright holder notifies you of the violation by some reasonable means, this is the first time you have received notice of violation of this License (for any work) from that copyright holder, and you cure the violation prior to 30 days after your receipt of the notice.

Termination of your rights under this section does not terminate the licenses of parties who have received copies or rights from you under this License. If your rights have been terminated and not permanently reinstated, you do not qualify to receive new licenses for the same material under section 10.

9. Acceptance Not Required for Having Copies.

You are not required to accept this License in order to receive or run a copy of the Program. Ancillary propagation of a covered work occurring solely as a consequence of using peer-to-peer transmission to receive a copy likewise does not require acceptance. However, nothing other than this License grants you permission to propagate or modify any covered work. These actions infringe copyright if you do not accept this License. Therefore, by modifying or propagating a covered work, you indicate your acceptance of this License to do so.

10. Automatic Licensing of Downstream Recipients.

Each time you convey a covered work, the recipient automatically receives a license from the original licensors, to run, modify and propagate that work, subject to this License. You are not responsible for enforcing compliance by third parties with this License.

An "entity transaction" is a transaction transferring control of an organization, or substantially all assets of one, or subdividing an organization, or merging organizations. If propagation of a covered work results from an entity transaction, each party to that transaction who receives a copy of the work also receives whatever licenses to the work the party's predecessor in interest had or could give under the previous paragraph, plus a right to possession of the Corresponding Source of the work from the predecessor in interest, if the predecessor has it or can get it with reasonable efforts.

You may not impose any further restrictions on the exercise of the rights granted or affirmed under this License. For example, you may not impose a license fee, royalty, or other charge for exercise of rights granted under this License, and you may not initiate litigation (including a cross-claim or counterclaim in a lawsuit) alleging that any patent claim is infringed by making, using, selling, offering for sale, or importing the Program or any portion of it.

11. Patents.

A "contributor" is a copyright holder who authorizes use under this License of the Program or a work on which the Program is based. The work thus licensed is called the contributor's "contributor version".

A contributor's "essential patent claims" are all patent claims owned or controlled by the contributor, whether already acquired or hereafter acquired, that would be infringed by some manner, permitted by this License, of making, using, or selling its contributor version, but do not include claims that would be infringed only as a consequence of further modification of the contributor version. For purposes of this definition, "control" includes the right to grant patent sublicenses in a manner consistent with the requirements of this License.

Each contributor grants you a non-exclusive, worldwide, royalty-free patent license under the contributor's essential patent claims, to make, use, sell, offer for sale, import and otherwise run, modify and propagate the contents of its contributor version.

In the following three paragraphs, a "patent license" is any express agreement or commitment, however denominated, not to enforce a patent (such as an express permission to practice a patent or covenant not to sue for patent infringement). To "grant" such a patent license to a party means to make such an agreement or commitment not to enforce a patent against the party.

If you convey a covered work, knowingly relying on a patent license, and the Corresponding Source of the work is not available for anyone to copy, free of charge and under the terms of this License, through a publicly available network server or other readily accessible means, then you must either (1) cause the Corresponding Source to be so available, or (2) arrange to deprive yourself of the benefit of the patent license for this particular work, or (3) arrange, in a manner consistent with the requirements of this License, to extend the patent license to downstream recipients. "Knowingly relying" means you have actual knowledge that, but for the patent license, your conveying the covered work in a country, or your recipient's use of the covered work in a country, would infringe one or more identifiable patents in that country that you have reason to believe are valid.

If, pursuant to or in connection with a single transaction or arrangement, you convey, or propagate by procuring conveyance of, a covered work, and grant a patent license to some of the parties receiving the covered work authorizing them to use, propagate, modify or convey a specific copy of the covered work, then the patent license you grant is automatically extended to all recipients of the covered work and works based on it.

A patent license is "discriminatory" if it does not include within the scope of its coverage, prohibits the exercise of, or is conditioned on the non-exercise of one or more of the rights that are specifically granted under this License. You may not convey a covered work if you are a party to an arrangement with a third party that is in the business of distributing software, under which you make payment to the third party based on the extent of your activity of conveying the work, and under which the third party grants, to any of the parties who would receive the covered work from you, a discriminatory patent license (a) in connection with copies of the covered work conveyed by you (or copies made from those copies), or (b) primarily for and in connection with specific products or compilations that contain the covered work, unless you entered into that arrangement, or that patent license was granted, prior to 28 March 2007.

Nothing in this License shall be construed as excluding or limiting any implied license or other defenses to infringement that may otherwise be available to you under applicable patent law.

12. No Surrender of Others' Freedom.

If conditions are imposed on you (whether by court order, agreement or otherwise) that contradict the conditions of this License, they do not excuse you from the conditions of this License. If you cannot convey a covered work so as to satisfy simultaneously your obligations under this License and any other pertinent obligations, then as a consequence you may not convey it at all. For example, if you agree to terms that obligate you to collect a royalty for further conveying from those to whom you convey the Program, the only way you could satisfy both those terms and this License would be to refrain entirely from conveying the Program.

13. Use with the GNU Affero General Public License.

Notwithstanding any other provision of this License, you have permission to link or combine any covered work with a work licensed under version 3 of the GNU Affero General Public License into a single combined work, and to convey the resulting work. The terms of this License will continue to apply to the part which is the covered work, but the special requirements of the GNU Affero General Public License, section 13, concerning interaction through a network will apply to the combination as such.

14. Revised Versions of this License.

The Free Software Foundation may publish revised and/or new versions of the GNU General Public License from time to time. Such new versions will be similar in spirit to the present version, but may differ in detail to address new problems or concerns.

Each version is given a distinguishing version number. If the Program specifies that a certain numbered version of the GNU General Public License "or any later version" applies to it, you have the option of following the terms and conditions either of that numbered version or of any later version published by the Free Software Foundation. If the Program does not specify a version number of the GNU General Public License, you may choose any version ever published by the Free Software Foundation.

If the Program specifies that a proxy can decide which future versions of the GNU General Public License can be used, that proxy's public statement of acceptance of a version permanently authorizes you to choose that version for the Program.

Later license versions may give you additional or different permissions. However, no additional obligations are imposed on any author or copyright holder as a result of your choosing to follow a later version.

15. Disclaimer of Warranty.

THERE IS NO WARRANTY FOR THE PROGRAM, TO THE EXTENT PERMITTED BY APPLICABLE LAW. EXCEPT WHEN OTHERWISE STATED IN WRITING THE COPYRIGHT HOLDERS AND/OR OTHER PARTIES PROVIDE THE PROGRAM "AS IS" WITHOUT WARRANTY OF ANY KIND, EITHER EXPRESSED OR IMPLIED, INCLUDING, BUT NOT LIMITED TO, THE IMPLIED WARRANTIES OF MERCHANTABILITY AND FITNESS FOR A PARTICULAR PURPOSE. THE ENTIRE RISK AS TO THE QUALITY AND PERFORMANCE OF THE PROGRAM IS WITH YOU. SHOULD THE PROGRAM PROVE DEFECTIVE, YOU ASSUME THE COST OF ALL NECESSARY SERVICING, REPAIR OR CORRECTION.

16. Limitation of Liability.

IN NO EVENT UNLESS REQUIRED BY APPLICABLE LAW OR AGREED TO IN WRITING WILL ANY COPYRIGHT HOLDER, OR ANY OTHER PARTY WHO MODIFIES AND/OR CONVEYS THE PROGRAM AS PERMITTED ABOVE, BE LIABLE TO YOU FOR DAMAGES, INCLUDING ANY GENERAL, SPECIAL, INCIDENTAL OR CONSEQUENTIAL DAMAGES ARISING OUT OF THE USE OR INABILITY TO USE THE PROGRAM (INCLUDING BUT NOT LIMITED TO LOSS OF DATA OR DATA BEING RENDERED INACCURATE OR LOSSES SUSTAINED BY YOU OR THIRD PARTIES OR A FAILURE OF THE PROGRAM TO OPERATE WITH ANY OTHER PROGRAMS), EVEN IF SUCH HOLDER OR OTHER PARTY HAS BEEN ADVISED OF THE POSSIBILITY OF SUCH DAMAGES.

17. Interpretation of Sections 15 and 16.

If the disclaimer of warranty and limitation of liability provided above cannot be given local legal effect according to their terms, reviewing courts shall apply local law that most closely approximates an absolute waiver of all civil liability in connection with the Program, unless a warranty or assumption of liability accompanies a copy of the Program in return for a fee.

Mitsubishi Home-Cinema Television Limited Warranty

MITSUBISHI ELECTRIC VISUAL SOLUTIONS AMERICA, INC. ("MEVSA") warrants as follows to the original purchaser of this television from an authorized MITSUBISHI Audio/Video Dealer, should it prove defective by reason of against defects arising from improper workmanship and/or material:

a. Parts. The lenticular (i.e. front picture) screen is warranted against defects in materials and workmanship for a period of thirty (30) days from the date of the original purchase at retail. The lamp and all other parts (except any software incorporated into this television) are warranted for a period of one (1) year from the date of the original purchase at retail. We will repair or replace, at our option, any defective part without charge for the part. Parts used for replacement may be replaced with those of like kind and quality and may be new or remanufactured. Parts used for replacement are warranted for the remainder of the original warranty period.

b. Embedded Software. MEVSA warrants that all software developed by MEVSA and incorporated into this television set (the "Embedded Software") will perform in accordance with the functional description of Embedded Software in all material respects, but MEVSA does not warrant that the Embedded Software is error-free. The limited warranty contained in this section shall continue for a period of one (1) year from the date of the original purchase at retail. If, after prompt notice within the warranty period, MEVSA determines that the Embedded Software has failed to perform in accordance with such functional description in all material respects and if such failure is not due to accident, misuse, modification or misapplication of the Embedded Software, then MEVSA shall modify the nonconforming Embedded Software and make available the modified Embedded Software at no charge to you, which at MEVSA's sole discretion may be fulfilled by means of modification or replacement software contained on a replacement memory card or made available through download via the Internet or email for Customer installation. The foregoing shall be MEVSA's sole obligation to you under this limited warranty. All rights under this limited warranty on the Embedded Software also subject to your acceptance of and compliance with the terms of the Software License Agreement applicable to this television, and this limited warranty on the Embedded Software shall be null and void if the Embedded Software is modified or changed in any manner except as specifically authorized by MEVSA.

c. Labor. For thirty (30) days after the original purchase at retail, we will repair or replace, at our option, the lenticular screen if it proves defective. For certain items that are designed to be replaced by the consumer, including (but not limited to) some Embedded Software and Lamps, the consumer is solely responsible for any replacement labor. For all other parts, we will provide the labor for a warranty repair by an authorized MITSUBISHI service center without charge for one (1) year from the original date of purchase at retail.

d. Notice. To obtain warranty service, you must notify an authorized MITSUBISHI service center of any defect within the applicable warranty time period.

e. This DLP Projection Television uses a single DLP chip to create the screen image. This technology creates the image using small dots, or picture elements (pixels). Your DLP Projection TV is manufactured to a high level of performance and quality, in fact, 99.99% perfect in the number of properly functioning pixels. As in other display technology, sometimes a pixel is continuously active, inactive or the incorrect color. Our standard is clear; MEVSA warrants only that the percentage of properly functioning pixels will be not less than 99.99% of all pixels.

BEFORE REQUESTING SERVICE, please review the instruction booklet to insure proper installation and correct customer control adjustment. If the problem persists please arrange for warranty service.

1. TO OBTAIN WARRANTY SERVICE:

a. Contact your nearest authorized MITSUBISHI service center, whose name and address can be obtained from your MITSUBISHI dealer, by writing at the address provided below, calling MEVSA at the 800-332-2119, or by using the support feature of our website at www.Mitsubishi-tv.com.

b. Warranty service will be provided in your home or, if required, at an authorized service shop, provided that your television is located within the geographic territory customarily covered by an authorized MITSUBISHI service center. If not, you must either deliver your television to an authorized service location at your own expense, or pay for any travel and/or transportation costs the service center may charge to and from your home. Actual service labor will be provided without charge.

c. Proof of purchase date from an authorized MITSUBISHI dealer is required when requesting warranty service. Present your sales receipt or other document which establishes proof and date of purchase. THE RETURN OF THE OWNER REGISTRATION CARD IS NOT A CONDITION OF COVERAGE UNDER THIS LIMITED WARRANTY. However, please return the Owner Registration Card so that we can contact you should a question of safety arise which could affect you.

d. To obtain a replacement lamp, order the lamp directly from the MEVSA Parts Department at (800) 553-7278.

For assistance call 1(800) 332-2119

2. THIS LIMITED WARRANTY DOES NOT COVER:

- a. Up to .01% pixel outages (small dot picture elements that are dark or incorrectly illuminated).
- b. Damage to the lenticular screen or Fresnel lens, screen frame, cosmetic damage or to any other damage where such damage is caused by unauthorized modification, alteration, repairs to or service of the product by anyone other than an authorized MITSUBISHI service center; physical abuse to or misuse of the product (including any failure to carry out any maintenance as described in the Owner's Guide including air vent cleaning or any product damaged by excessive physical or electrical stress); any products that have had a serial number or any part thereof altered, defaced or removed; product use in any manner contrary to the Owner's Guide; freight damage; or any damage caused by acts of God or other factors beyond the reasonable control of MEVSA, such as power surge damage caused by electrical system or lightning. This limited warranty also excludes service calls where no defect in the product covered under this warranty is found, service calls related to unsatisfactory audio or visual reception or signal unless caused by a defect in the product that is covered under this limited warranty, all costs, expenses or any other damages arising from product installation, or set-ups, any adjustments of user controls (including contrast, brightness, color, tint, fine tuning, sharpness), other adjustment necessary to prepare the unit for display or use, connection with any external audio receiver, antenna, cable or satellite systems, or service of products purchased or serviced outside the U.S.A. Please consult the operating instructions contained in the Owner's Guide furnished with the product for information regarding user controls.

3. ANY EXPRESS WARRANTY NOT PROVIDED HEREIN, AND ANY REMEDY WHICH, BUT FOR THIS PROVISION, MIGHT ARISE BY IMPLICATION OR OPERATION OF LAW, IS HEREBY EXCLUDED AND DISCLAIMED. THE IMPLIED WARRANTIES OF MERCHANTABILITY AND OF FITNESS FOR ANY PARTICULAR PURPOSE ARE EXPRESSLY LIMITED TO A TERM OF ONE YEAR.

4. UNDER NO CIRCUMSTANCES SHALL MEVSA BE LIABLE TO PURCHASER OR ANY OTHER PERSON FOR ANY INCIDENTAL, SPECIAL OR CONSEQUENTIAL DAMAGES, WHETHER ARISING OUT OF BREACH OF WARRANTY, BREACH OF CONTRACT, OR OTHERWISE.

5. Some states do not allow limitations on how long an implied warranty lasts, or the exclusion or limitation of incidental, special, or consequential damages, so the above limitations or exclusions may not apply to you.

6. This limited warranty gives you specific legal rights, and you may also have other rights which vary from state to state.

7. In the event of any dispute under this limited warranty, jurisdiction and venue for resolving that dispute will be in the state where the television was purchased and the laws of such state will govern.

MITSUBISHI ELECTRIC VISUAL SOLUTIONS AMERICA, INC.
9351 Jeronimo Road
Irvine, CA 92618-1904

Mitsubishi Home-Cinema Television Limited Warranty (Canada only)

This limited warranty is valid only for products purchased, used and serviced in Canada. MITSUBISHI ELECTRIC VISUAL SOLUTIONS AMERICA, INC. ("MEVSA") warrants as follows to the original purchaser of this television from an authorized MITSUBISHI Audio/Video Dealer, should it prove defective by reason of against defects arising from improper workmanship and/or material:

a. Parts. The lenticular (i.e. front picture) screen is warranted against defects in materials and workmanship for a period of thirty (30) days from the date of the original purchase at retail. The lamp and all other parts (except any software incorporated into this television) are warranted for a period of one (1) year from the date of the original purchase at retail. We will repair or replace, at our option, any defective part without charge for the part. Parts used for replacement may be replaced with those of like kind and quality and may be new or remanufactured. Parts used for replacement are warranted for the remainder of the original warranty period.

b. Embedded Software. MEVSA warrants that all software developed by MEVSA and incorporated into this television set (the "Embedded Software") will perform in accordance with the functional description of Embedded Software in all material respects, but MEVSA does not warrant that the Embedded Software is error-free. The limited warranty contained in this section shall continue for a period of one (1) year from the date of the original purchase at retail. If, after prompt notice within the warranty period, MEVSA determines that the Embedded Software has failed to perform in accordance with such functional description in all material respects and if such failure is not due to accident, misuse, modification or misapplication of the Embedded Software, then MEVSA shall modify the nonconforming Embedded Software and make available the modified Embedded Software at no charge to you, which at MEVSA's sole discretion may be fulfilled by means of modification or replacement software contained on a replacement memory card or made available through download via the Internet or email

For assistance call 1(800) 332-2119

for Customer installation. The foregoing shall be MEVSA's sole obligation to you under this limited warranty. All rights under this limited warranty on the Embedded Software also subject to your acceptance of and compliance with the terms of the Software License Agreement applicable to this television, and this limited warranty on the Embedded Software shall be null and void if the Embedded Software is modified or changed in any manner except as specifically authorized by MEVSA.

c. Labor. For thirty (30) days after the original purchase at retail, we will repair or replace, at our option, the lenticular screen if it proves defective. For certain items that are designed to be replaced by the consumer, including (but not limited to) some Embedded Software and Lamps, the consumer is solely responsible for any replacement labor. For all other parts, we will provide the labor for a warranty repair by an authorized MITSUBISHI service center without charge for one (1) year from the original date of purchase at retail.

d. Notice. To obtain warranty service, you must notify an authorized MITSUBISHI service center of any defect within the applicable warranty time period.

e. This DLP Projection Television uses a single DLP chip to create the screen image. This technology creates the image using small dots, or picture elements (pixels). Your DLP Projection TV is manufactured to a high level of performance and quality, in fact, 99.99% perfect in the number of properly functioning pixels. As in other display technology, sometimes a pixel is continuously active, inactive or the incorrect color. Our standard is clear; MEVSA warrants only that the percentage of properly functioning pixels will be not less than 99.99% of all pixels.

BEFORE REQUESTING SERVICE, please review the instruction booklet to insure proper installation and correct customer control adjustment. If the problem persists please arrange for warranty service.

1. TO OBTAIN WARRANTY SERVICE:

a. Contact your nearest authorized MITSUBISHI service center, whose name and address can be obtained from your MITSUBISHI dealer or by calling MEVSA at 800-332-2119.

b. Warranty service will be provided in your home or, if required, at an authorized service shop, provided that your television is located within the geographic territory customarily covered by an authorized MITSUBISHI service center. If not, you must either deliver your television to an authorized service location at your own expense, or pay for any travel and/or transportation costs the service center may charge to and from your home. Actual service labor will be provided without charge.

c. Proof of purchase date from an authorized MITSUBISHI dealer is required when requesting warranty service. Present your sales receipt or other document which establishes proof and date of purchase. THE RETURN OF THE OWNER REGISTRATION CARD IS NOT A CONDITION OF COVERAGE UNDER THIS LIMITED WARRANTY. However, please return the Owner Registration Card so that we may contact you should a question of safety arise which could affect you.

2. THIS LIMITED WARRANTY DOES NOT COVER:

a. Up to .01% pixel outages (small dot picture elements that are dark or incorrectly illuminated).

b. Damage to the lenticular screen or Fresnel lens, screen frame, cosmetic damage or to any other damage where such damage is caused by unauthorized modification, alteration, repairs to or service of the product by anyone other than an authorized MITSUBISHI service center; physical abuse to or misuse of the product (including any failure to carry out any maintenance as described in the Owner's Guide including air vent cleaning or any product damaged by excessive physical or electrical stress); any products that have had a serial number or any part thereof altered, defaced or removed; product use in any manner contrary to the Owner's Guide; freight damage; or any damage caused by acts of God or other factors beyond the reasonable control of MEVSA, such as power surge damage caused by electrical system or lightning. This limited warranty also excludes service calls where no defect in the product covered under this warranty is found, service calls related to unsatisfactory audio or visual reception or signal unless caused by a defect in the product that is covered under this limited warranty, all costs, expenses or any other damages arising from product installation, or set-ups, any adjustments of user controls (including contrast, brightness, color, tint, fine tuning, sharpness), other adjustment necessary to prepare the unit for display or use, connection with any external audio receiver, antenna, cable or satellite systems, or service of products purchased or serviced outside Canada. Please consult the operating instructions contained in the Owner's Guide furnished with the product for information regarding user controls.

3. ANY EXPRESS WARRANTY NOT PROVIDED HEREIN, AND ANY REMEDY WHICH, BUT FOR THIS PROVISION, MIGHT ARISE BY IMPLICATION OR OPERATION OF LAW, IS HEREBY EXCLUDED AND DISCLAIMED. THE IMPLIED WARRANTIES OF MERCHANTABILITY AND OF FITNESS FOR ANY PARTICULAR PURPOSE ARE EXPRESSLY LIMITED TO A TERM OF ONE YEAR.

4. UNDER NO CIRCUMSTANCES SHALL MEVSA BE LIABLE TO PURCHASER OR ANY OTHER PERSON FOR ANY INCIDENTAL, SPECIAL OR CONSEQUENTIAL DAMAGES, WHETHER ARISING OUT OF BREACH OF WARRANTY, BREACH OF CONTRACT, OR OTHERWISE.

For assistance call 1(800) 332-2119

5. Some jurisdictions do not allow limitations on how long an implied warranty lasts, or the exclusion or limitation of incidental, special, or consequential damages, so the above limitations or exclusions may not apply to you.
6. This limited warranty gives you specific legal rights, and you may also have other rights which vary from province to province.

MITSUBISHI ELECTRIC VISUAL SOLUTIONS AMERICA, INC.
9351 Jeronimo Road
Irvine, CA 92618
www.Mitsubishi-tv.com

Mitsubishi Electric Visual Solutions America, Inc. (MEVSA) Internet Applications Policy

MEVSA Internet Applications affords the opportunity to access third party Internet product offerings or services ("Third Party Services") on certain Mitsubishi TVs. The Third Party Services accessible herein are provided as per our agreement with these third parties. These agreements are subject to change, interruption, suspension (including termination) at any time and for various reasons. MEVSA makes no warranties or representations that any particular Third Party Service will be accessible, available, function in any particular manner or function at all.

Internet Access Required for Third Party Services; Updates:

To use these Third Party Services, you must obtain high-speed/broadband access to the Internet (such as DSL, cable or T1 lines), either directly or through devices that access the Internet and pay any service fees associated with such access. In addition, you must provide all equipment necessary to make such connection to the Internet including a modem or other Internet access device. Each individual third party Internet product may require different minimum Internet connection speed. The usability and availability of a functional Mitsubishi television and its internet connected feature may highly be dependent and varied based on high-speed/broadband internet access, connection speed, bandwidth, other equipment(s), third party applications, firmware updates and other factors outside of MEVSA's control and/or responsibility which may also be independent of the actual operation of the television. It is further understood that Mitsubishi televisions are integrated with sophisticated technologies (software and hardware) which may exhibit delayed boot-up/shutdown time and/or interrupted services. You further understand that the Third Party Services specifications and functionality are constantly evolving and that we may directly, or indirectly via third parties, update or change the Third Party Services, in whole or in part, at any time and without notice to you. Such updates may be required for you to use certain aspects of the Third Party services or to continue to connect to the Third Party Services.

Availability of Content on Third Party Services:

MEVSA or said third parties providing Third Party Services reserve the right to delete data from their servers, or prevent access to their servers or to change data categories, product offerings or service levels for any reason that MEVSA or said third parties deem sufficient in their sole discretion at any time, without notice. MEVSA may also impose additional or different limits on the use of or access to certain Third Party Services, in any case and without notice or liability. Some or all of the data or functionality of the Third Party Services may require additional payment and/or subscription by you. However, in no event will you be charged for any Third Party Services unless those charges are made known to you in advance. MEVSA makes no warranties or representations of any kind as to the accuracy, currency, or completeness of any information contained on the data servers of such third party providers of any Third Party Services. Furthermore, we do not review, control, or endorse the content, products or services of Third Party Services or their data servers.

THIRD PARTY SERVICES ARE PROVIDED SERVICE "AS IS" AND "AS AVAILABLE," WITHOUT WARRANTY OF ANY KIND (INCLUDING ANY IMPLIED WARRANTY OF MERCHANTABILITY, NON-INFRINGEMENT, OR FITNESS FOR A PARTICULAR PURPOSE), TO THE MAXIMUM EXTENT PERMITTED BY LAW. USE OF THE THIRD PARTY SERVICES IS AT YOUR SOLE RISK. THIS MEANS, FOR EXAMPLE, THAT MEVSA DOES NOT GUARANTEE THAT THE THIRD PARTY SERVICES WILL ALWAYS WORK PROPERLY OR WORK AT ALL. THIS ALSO MEANS WE DO NOT GUARANTEE THAT THE THIRD PARTY SERVICES, CONTENT OR PRODUCTS WILL BE FREE FROM VIRUSES, HACKS, OR OTHER POTENTIALLY HARMFUL INTRUSIONS. PLEASE NOTE THAT SOME STATES DO NOT ALLOW SUCH WARRANTY LIMITATIONS, SO THESE LIMITATIONS MAY NOT APPLY TO YOU.

Third Party Services Content Disclaimer:

Certain Third Party Services may include materials from third parties or links to certain third party data servers. You acknowledge and agree that MEVSA is not responsible for examining or evaluating the content or accuracy of any Third Party Services, their data servers or related third-party materials. MEVSA does not warrant or endorse and does not assume and will not have any liability or responsibility for any third-party materials or web sites, or for any other materials, products, or services of third parties. Links to Third Party Services and any associated links to other data servers are provided solely as a convenience to you. To the extent provided, content types or descriptions of Third Party Services provided for convenience, and you acknowledge and agree that MEVSA does not guarantee their accuracy. You understand that by using any of the Third Party Services, you may encounter content that may be deemed offensive, indecent, or objectionable, which content may or may not be identified as having explicit language. Nevertheless, you agree to use the Third Party Services at your sole risk and that MEVSA shall have no liability to you for content that may be found to be offensive, indecent, or objectionable. You agree that you will not use any third-party materials in a manner that would infringe or violate the rights of any other party, and that MEVSA is not in any way responsible for any such use by you.



Website:
www.mitsubishi-tv.com

E-mail:
TVsupport@mevsa.com

**Call Consumer Relations for
operational or connection assistance at 800-332-2119**

**To order replacement or additional
remote controls or lamp cartridges,
Visit our website www.mitsuparts.com
or call 800-553-7278**

Trademark and License Information

LICENSOR’S SUPPLIERS DO NOT MAKE OR PASS ON TO END USER OR ANY OTHER THIRD PARTY, ANY EXPRESS, IMPLIED OR STATUTORY WARRANTY OR REPRESENTATION ON BEHALF OF SUCH SUPPLIERS, INCLUDING, BUT NOT LIMITED TO THE IMPLIED WARRANTIES OF NON-INFRINGEMENT, TITLE, MERCHANTABILITY OR FITNESS FOR A PARTICULAR PURPOSE.

 Manufactured under license from Cambridge Mechatronics Ltd.
Rapidfire and the 1... logo are trademarks of Cambridge Mechatronics Ltd

Apple, iPad, iPhone, iPod, iTunes, are trademarks of Apple Inc., registered in the U.S. and other countries.

The *Bluetooth*® word mark and logos are registered trademarks owned by Bluetooth SIG, Inc. and any use of such marks by Mitsubishi Electric is under license. Other trademarks and trade names are those of their respective owners.

 Manufactured under license from Real Sound Lab, SIA.
CONEQ is a trademark of Real Sound Lab, SIA.

Digital Light Processing® and DLP® are registered trademarks of Texas Instruments.

Manufactured under license from Dolby Laboratories. “Dolby,” “Pro Logic,” and the double-D symbol are trademarks of Dolby Laboratories.

HDMI®, the HDMI Logo, and High-Definition Multimedia Interface are trademarks or registered trademarks of HDMI Licensing LLC in the United States and other countries.

 Imaging Science Foundation Certified Calibration Controls

The software in this TV is based in part on the work of the Independent JPEG Group, copyright © 1991-1998, Thomas G. Lane, all rights reserved.

VUDU™ is a trademark of VUDU, Inc.

XPAND, X3D, X4D, X6D, their respective logos and other identifying marks of XPAND and X6D Ltd. are and shall remain the trade-marks and trade names and exclusive property of X6D Ltd.

“x.v.Color” and the “x.v.Color” logo are trademarks of Sony Corporation.

ChannelView™, DeepField™ Imager, Easy Connect™, EdgeEnhance™, Plush 1080p@ 5G, are trademarks of Mitsubishi Electric Visual Solutions America, Inc.

SYSTEM RESET

If the TV does not respond to the remote control, control-panel buttons, or will not power on/off, press and hold the **POWER** button on the control panel for ten seconds.

The TV will turn off. Power on the TV and the green LED will flash quickly for about one minute. Recent settings changes may be lost.

For Your Records

Record the model number, serial number, and purchase date of your TV. The model and serial numbers are on the back of the TV. Refer to this page when requesting assistance with the TV.

MODEL NUMBER _____
SERIAL NUMBER _____
PURCHASE DATE _____
RETAILER NAME _____
LOCATION _____