



RF4289HA

Refrigerator user manual

English

Imagine the possibilities



Thank you for purchasing a Samsung product.
To receive a more complete service,
please register your product at
www.samsung.com/register

Free Standing Appliance



Safety Information











SAFETY INFORMATION

Before using your new Samsung French Door Refrigerator, please read this manual thoroughly to ensure that you know how to operate the features and functions that your new appliance offers safely and efficiently.

This appliance is not intended for use by persons (including children) with reduced physical, sensory, or mental capabilities, or those who lack experience and knowledge, unless they have been given supervision or instruction concerning the use of the appliance by a person responsible for their safety.

Because the following instructions cover various models, the characteristics of your refrigerator may differ slightly from the refrigerator described in this manual. If you have any question, contact us at 1-800-SAMSUNG or find help and information online at www.samsung.com.

Important safety symbols and precautions:



 WARNING	Hazards or unsafe practices that may result in severe personal injury or death.
 CAUTION	Hazards or unsafe practices that may result in minor personal injury or property damage.
	Do NOT attempt.
	Do NOT disassemble.
	Do NOT touch.
	Follow directions carefully.
	Unplug the power plug from the wall socket.
	Make sure the refrigerator is grounded to prevent electric shock.
	Call the contact center for help.
	Note.

These warning signs are here to prevent injury to you and others.

Please follow them carefully.

After reading this section, keep it in a safe place for future reference.

SEVERE WARNING SIGNS FOR INSTALLATION

-  Do not install the refrigerator in a damp place or place where it may come in contact with water.
 - Deteriorated insulation of electrical parts may cause an electric shock or fire.
 - Do not place this refrigerator in direct sunlight or expose to the heat from stoves, room heaters or other appliance.
 - Do not plug several appliances into the same multiple power strip.
The refrigerator should always be plugged into its own individual electrical outlet which has a voltage rating that matches the voltage listed on the refrigerator's rating plate.
 - This provides the best performance and also prevents overloading house wiring circuits, which could cause a fire hazard from overheated wires.
 - If the wall socket is loose, do not insert the power plug.
 - There is a risk of electric shock of fire.
 - Do not use a cord that shows cracks or abrasion damage along its length or at either end.
 - Do not bend the power cord excessively or place heavy articles on it.
 - Never unplug your refrigerator by pulling on the power cord. Always grip plug firmly and pull straight out from the outlet.
 - Damage to the cord may cause a short-circuit, fire and/or electric shock.
 - Do not use aerosols near the refrigerator.
 - Aerosols used near the refrigerator may cause an explosion or fire.
-
-  • This refrigerator must be properly installed and located in accordance with the manual before it is used.
 - Connect the power plug in proper position with the cord hanging down.
 - If you connect the power plug upside down, the wire can get cut off and cause a fire or electric shock.

- When moving the refrigerator, be careful not to roll over or damage the power cord.
- This constitutes a fire hazard.
- Make sure that the power plug is not squashed or damaged by the back of the refrigerator.
- Keep the packing materials out of reach of children.
- There is a risk of death from suffocation if a child puts the packing materials on his or her head.
- The appliance must be positioned so that the plug is accessible after installation.
- You need to remove all the protective plastic film before you initially plug the product in.



- The refrigerator must be safely grounded
- Always make sure that you have grounded the refrigerator before attempting to investigate or repair any part of the appliance. Power leakages can cause severe electric shock.
- Never use gas pipes, telephone lines or other potential lightning attractors as an electrical ground.
- Improper use of the grounding plug can result in a risk of electric shock.

If it is necessary to use an extension cord, use only a 3-wire extension cord that has a 3-blade grounding plug and a 3-slot receptacle that will accept the plug on the appliance.

The marked rating of the extension cord should be AC115-120 V, 10 A, or more.

If a grounding adapter is used, make sure the receptacle box is fully grounded.



- If the power cord is damaged, have it replaced immediately by the manufacturer or its service agent.



CAUTION SIGNS FOR INSTALLATION

- Allow sufficient space to install the refrigerator on a flat surface.
- If your refrigerator is not level, the internal cooling system may not work correctly.
- Keep the ventilation space in the appliance enclosure or mounting structure clear of obstruction.
- Allow the appliance to stand for 2 hours after installation.



SEVERE WARNING SIGNS FOR USING



- Do not insert the power plug with wet hands.
- Do not store articles on the top of the appliance.
- When you open or close the door, the articles may fall and cause personal injury and/or material damage.
- Do not put a container filled with water on the refrigerator.
- If spilled, there is a risk of fire or electric shock.
- Children should be supervised to ensure that they do not play with the appliance.
- Do not let children hang on the door. A serious injury may occur.
- Do not let children enter inside of the refrigerator. There is a risk of children entrapment.
- Do not insert your hands into the bottom area under the appliance.
- Any sharp edges may cause personal injury.
- Do not let children step on a drawer's cover.
- The drawer may break and cause them to slip.
- Do not overfill the refrigerator with food.
- When you open the door, an item may fall out and cause personal injury or material damage.
- Do not touch the inside walls of the freezer or products stored in the freezer with wet hands.
- This may cause frostbite.
- Never put fingers or other objects into the water dispenser hole, ice chute, or ice maker bucket.
- It may cause personal injury or material damage.
- Do not spray flammable gas near the refrigerator.
- There is a risk of explosion or fire.
- Do not store volatile or flammable substances in the refrigerator.
- The storage of benzene, thinner, alcohol, ether, LP gas and other such products may cause explosions.
- Do not store pharmaceuticals products, scientific materials, or temperature sensitive products in the refrigerator.
- Products that require strict temperature controls must not be stored in the refrigerator.
- Do not place or use an electrical appliance inside the refrigerator, unless it is of a type recommended by the manufacturer.
- Do not use mechanical devices or any other means to accelerate the defrosting process, other than those recommended by the manufacturer.
- Do not damage the refrigerant circuit.



- Do not disassemble or repair the refrigerator by yourself.
- You run risk of causing a fire, malfunction and/or personal injury.
- When the interior or exterior LED lamp has gone out, please contact your service agents.



- Children should be supervised to ensure that they do not play with the appliance.
- Bottles should be stored tightly together so that they do not fall out.
- This product is intended only for the storage of food in a domestic environment.
- If a gas leak is detected, avoid any naked flames or potential sources of ignition and air the room in which the appliance is standing for several minutes.
- Use only the LED Lamps provided by manufacturer or service agents.



- If there are burning smells or smoke, pull out power plug immediately and contact your Samsung Electronics service center.
- If you experience difficulty when changing the light, contact a service agent.
- If the product is equipped with LED Lamps, do not disassemble the Lamp Cover and LED Lamp by yourself.
- Please contact your service agents.
- If any dust or water is in refrigerator, pull out the power plug and contact your Samsung Electronics service center.
- Otherwise there is a risk of fire.



CAUTION SIGNS FOR USING



- Do not re-freeze frozen foods that have thawed completely. Do not place carbonated or fizzy drinks in the freezer compartment. Do not put bottles or glass containers in the freezer.
- When the contents freeze, the glass may break and cause personal injury.



- Service warranty and Modification.
- Any changes or modifications performed by a 3rd party on this finished appliance are not covered under Samsung warranty service, nor can Samsung be responsible for safety issues that result from 3rd party modifications.

- Do not block air holes.
- If the air holes are blocked, especially with a plastic bag, the refrigerator can be over cooled. If this cooling period lasts too long, the water filter may break and cause water leakage.
- If the refrigerator is disconnected from the power supply, you should wait for at least five minutes before plugging it back.
- If you have a long vacation planned or the refrigerator is not to be used for a long period of time, you must empty the refrigerator and pull out the power plug.
- Letting the refrigerator run for a long time without using it can cause the insulation to deteriorate and may cause a fire.
- Wipe excess moisture from the inside and leave the doors open. Otherwise, odor and mold may develop.
- To get the best performance from the product:
- Do not place foods too close to the vents at the rear of the appliance as it can obstruct free air circulation in the refrigerator compartment.
- Wrap food up properly or place it in airtight containers before putting it into the refrigerator.
- Fill the water tank, ice tray, and water cubes only with potable water.



- If the product is flooded, make sure to contact your nearest service center.
- There is a risk of electric shock or fire.



CAUTION SIGNS FOR CLEANING



- Do not directly spray water on the inside or outside the refrigerator.
- There is a risk of fire or electric shock.



- Remove any foreign matter or dust from the power plug pins. Do not use a wet or damp cloth when cleaning the plug.
- Otherwise, there is a risk of fire or electric shock.



- Unplug the refrigerator before cleaning or making repairs.



SEVERE WARNING SIGNS FOR DISPOSAL



- Risk of child entrapment.
Before you throw away your old refrigerator or freezer:

- Take off the doors.
- Leave the shelves in place so that children can not easily climb inside.
- Please dispose of the packaging material from this product in an environmentally friendly manner.
- Leave the shelves in place so that children can not easily climb inside.

Ensure that none of the pipes on the back of the appliance are damaged prior to disposal.

- When disposing of this refrigerator, remove the door/door seals and door latch so that small children or animals cannot become trapped inside. Children should be supervised to ensure that they do not play with the appliance.
- Cyclopentane is used as in the insulation. The gases in the insulation material require a special disposal procedure. Please contact your local authorities in regard to the environmentally safe disposal of this product. Ensure that none of the pipes on the back of the refrigerator are damaged prior to disposal.

Contents

SETTING UP YOUR FRENCH DOOR REFRIGERATOR	06
OPERATING YOUR FRENCH DOOR REFRIGERATOR	13
TROUBLESHOOTING	79
WARRANTY	81

Setting up your French Door Refrigerator

GETTING READY TO INSTALL THE REFRIGERATOR

Congratulations on your purchase of the Samsung French Door Refrigerator.

We hope you enjoy the state-of-art features and efficiencies that this new appliance offers.

Selecting the best location for the refrigerator

- A location with easy access to the water supply.
- A location without direct exposure to sunlight.
- A location with a leveled floor.
- A location with enough space for the refrigerator doors to open easily.
- Allow sufficient space to the right, left, back and top for air circulation.
- Please ensure that appliance can be moved freely in the event of maintenance & service.

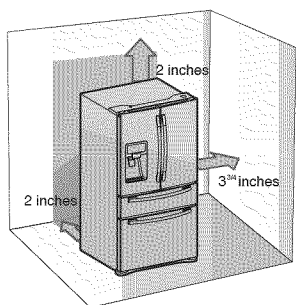

If the refrigerator does not have enough space, the internal cooling system may not work properly.

If your refrigerator has an ice maker, allow extra space at the back for the water line connections.

When you install the refrigerator next to a fixed wall, you need a minimum clearance of 3 3/4" (95mm) between the refrigerator and wall to allow the door to swing open.

First thing! Make sure that you can easily move your refrigerator to its final location by measuring doorways (both width and height), thresholds, ceilings, stairways, etc.

The following chart details the exact height and depth of this Samsung French Door Refrigerator.

Model	Depth "A"	Width "B"	Height "C"	Overall Height "D"	Depth "E"
RF4289HA	29 1/2" (749 mm)	35 7/8" (912 mm)	68 5/8" (1742 mm)	69 5/8" (1768 mm)	36 1/4" (922 mm)



- Allow clearance to the right, left, back and top when installing. This will help reduce power consumption and keep your energy bills lower.

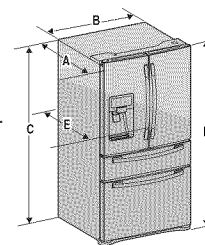

- Do not install the refrigerator where the temperature will go below 50°F (10°C).
- Do not locate the refrigerator where it may become wet.

When moving your refrigerator



To prevent floor damage, be sure the front adjusting legs are in the up position (above the floor).

Refer to 'Adjusting the doors' in the manual (on page 9).

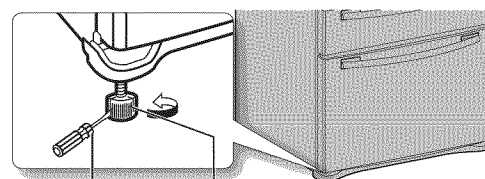

Flat-blade screw driver(-) Control Lever

FLOORING

For proper installation, this refrigerator must be placed on a leveled surface of hard material that is the same height as the rest of the flooring. This surface should be strong enough to support a fully loaded refrigerator, or approximately 359lbs (165kg).

To protect the finish of the flooring, cut a large section of the cardboard carton and place it under the refrigerator where you are working. When moving a refrigerator, you need to pull and push it straight forwards or back. Do not wiggle it from side to side.

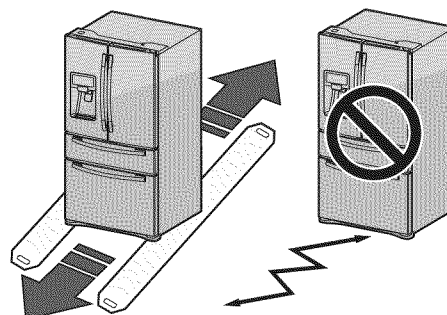

ACCESSORIES AND REQUIRED TOOLS

The following accessories are included with your refrigerator:

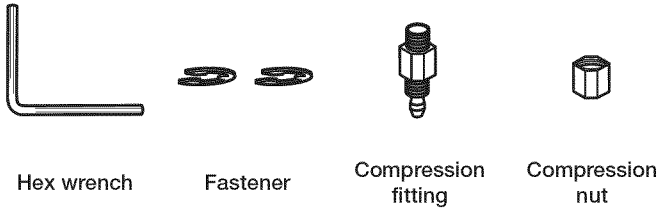

Hex wrench

Fastener

Compression fitting

Compression nut

Required Tools (Not provided)

You need the following tools to complete the installation of your refrigerator:

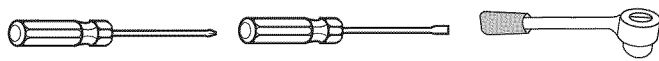

Philips screwdriver (+)

Flat-blade screwdriver (-)

Socket wrench (10mm)



Pliers



Allen wrench (3/16") (5mm)

REMOVING THE REFRIGERATOR DOORS

Some installations require door removal to transport the refrigerator to its final location. Do not remove the door/drawer if you don't need to. If you do not need to remove the refrigerator doors, go to Adjusting the Level on page 8. If you need to remove the doors, continue below. Before removing the door/drawer, make sure you read the following items:

WARNING Disconnect power to the refrigerator before removing the door or drawer.

- Be careful not to drop, damage or scratch the door/drawer while removing them.
- Be careful not to get injured while removing the door/drawer.

- Reattach the door/drawer properly to avoid:
 - Moisture from air leakage.
 - Uneven door alignment.
 - Wasting energy due to improper door seal.

Disassemble the refrigerator doors

WARNING Be careful not to drop and scratch the doors while removing the doors.

Disassemble the refrigerator doors

1. With the door opened, remove the cap top table (1) with a flat-blade screwdriver (-), and close the door. Remove the 3 screws holding down the top table (2) and turn it with several wires connected.

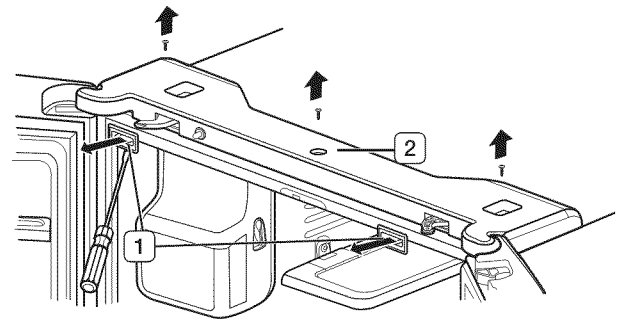

2. Disconnect one connector (3) on the right side door and one connector (4) on the left side door. Remove the water line (5) while pressing the dark gray color part (6) of the water line coupler.

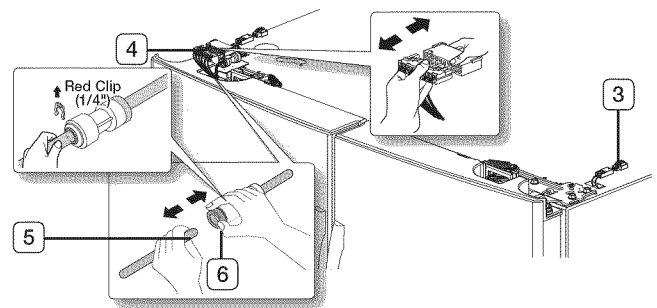

CAUTION If a red clip is on the coupler, it must be removed before removing the tube.

- Remove the 3 hex head bolts (**7**) attached to the upper left and right door hinges with a socket wrench (10mm).

Remove the ground screw (**8**) attached to the upper left and right door hinges with a philips screwdriver (+). Remove the upper left and right door hinges (**9**).

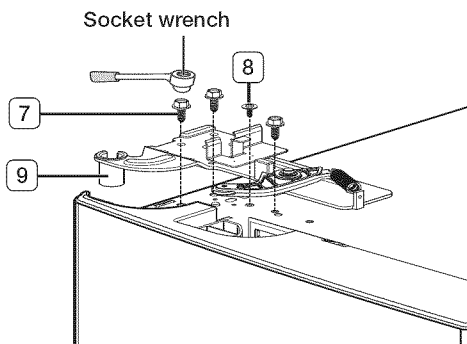

- Lift the door straight up to remove.

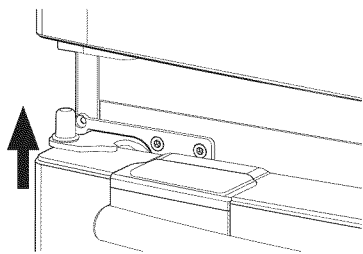

- Remove the screw (**10**) attached to the lower left and right door hinges with a philips screwdriver (+). Remove the 2 hex head bolts (**11**) attached to the lower left and right door hinges with an allen wrench (3/16"). Remove the lower left and right door hinges (**12**).

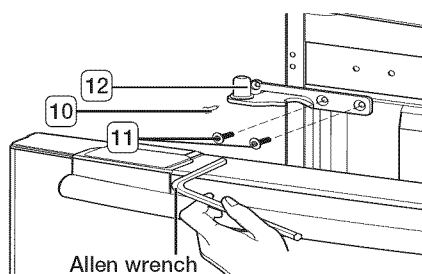

REATTACHING THE REFRIGERATOR DOORS

To reattach the fridge doors, assemble parts in reverse order.

DISASSEMBLE THE FLEX DOOR

- Take out the Flex Zone (**1**) by lifting it up.

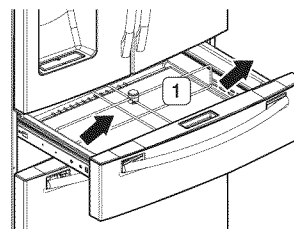

- Take off the cover (**2**) w/harness with a flat-blade screwdriver (-).

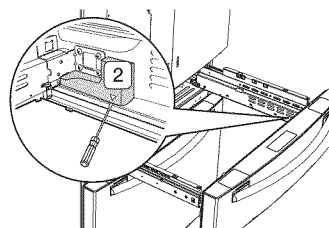

- Disconnect the housing connector.

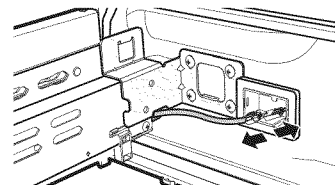

- Remove 2 hex head bolts from sides with a socket wrench (10mm).

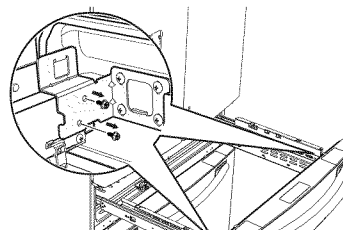

- Lift up the Flex door from the rails.

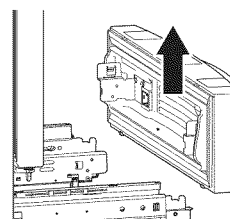

ASSEMBLE THE FLEX DOOR

To reattach the flex doors, assemble parts in reverse order.

DISASSEMBLE THE FREEZER DRAWER

1. Take out the upper drawer by lifting it up.

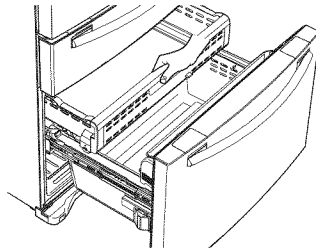

2. Remove the tilting pocket (1) by pulling both support guards (2) aside. And take out both support guards by pulling them aside.

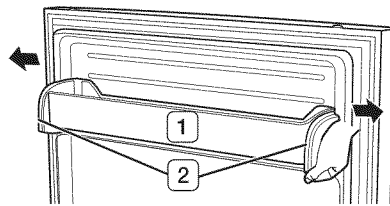

3. Take out the lower basket (3) by lifting the basket up from the rail system.

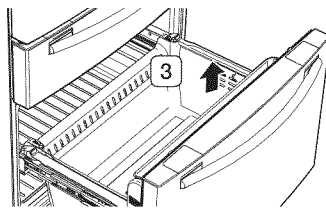

4. Remove 4 hex head bolts from both sides with a socket wrench (10mm).

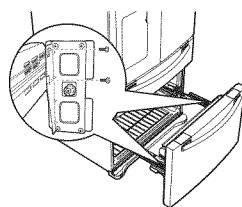

5. Lift up the freezer door from the rails.

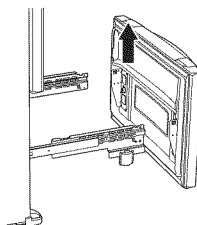

ASSEMBLE THE FREEZER DRAWER

To reattach the freezer drawer, assemble parts in reverse order.

ADJUSTING THE LEVEL

Make sure the refrigerator is level so that you can make final adjustments. Use a level to test if the refrigerator is level both side to side and back to front. If the refrigerator is not level, it will not be possible to get the doors perfectly even, which may cause moisture condensation and increased energy bills. Below is an example of how to level the refrigerator if the left side of the refrigerator is lower than the right side.

How to adjust the level

1. Disassemble the freezer drawer. (See to page 8)

2. Remove the two screws (1) attached to the cover leg front (2) with a Philips screwdriver (+).

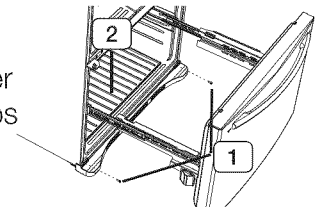

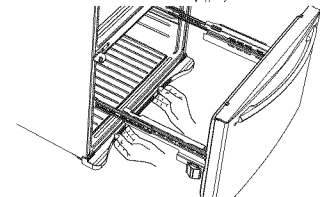

3. Remove the cover leg front (2) by lifting the bottom part of the cover leg front up and pulling it out.

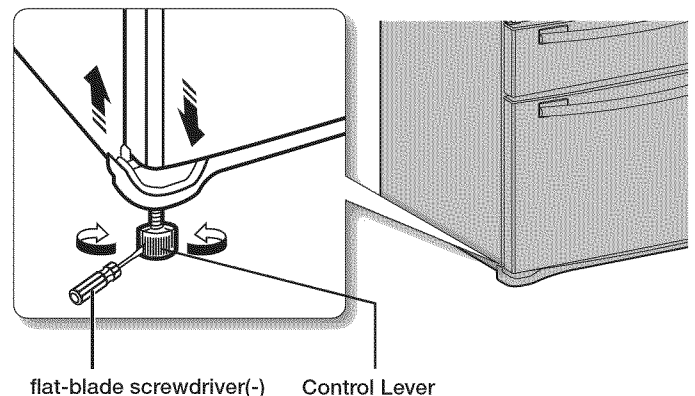

4. Insert a flat-blade screwdriver (-) into a notch on the left control lever, and turn it count clockwise to level the refrigerator. (You turn the lever clockwise to lower the refrigerator and counterclockwise to raise it.)





Both control levers must be touching the floor to avoid possible personal injury or property damage because of tipping.

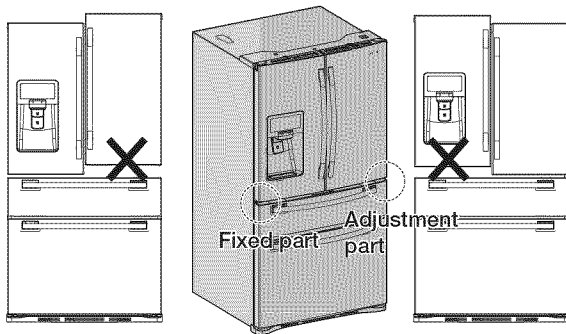

-  If the right side is lower, perform the same procedure, but with the right control lever.
-  It is difficult to remove the cover leg front from the refrigerator, so we do not recommend making small adjustments with the control lever. Instead, refer to the next page for the best way to make minor adjustments to the doors.

MAKING MINOR ADJUSTMENTS BETWEEN DOORS



Remember, a leveled refrigerator is necessary for getting the doors perfectly even. If you need help, review the previous section on leveling the refrigerator.

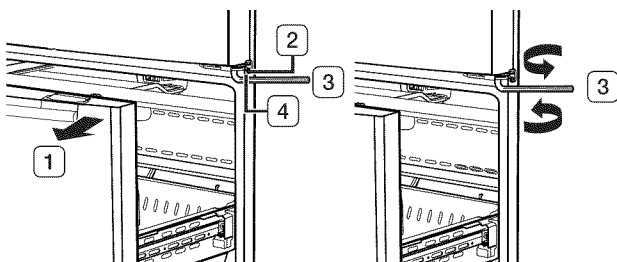

-  The left door is fixed. To make minor adjustments between doors, adjust only the right door.

1. Pull out the Flex Zone door (**1**) to expose the lower hinge (**2**).
2. Insert the supplied allen wrench (3/16") (**3**) into the shaft (**4**) of the lower hinge.
3. Please adjust the height by turning the hex wrench (**3**) clockwise () or counter-clockwise ().



-  When you turn the hex wrench counter-clockwise (), the door will move up.

1. After adjusting the doors, please insert the supplied fastener (**6**) using a pliers (**5**) in the gap between the hinge-grommet (**7**) and the lower hinge (**8**). The number of fastener you'll need to insert depends on the gap.

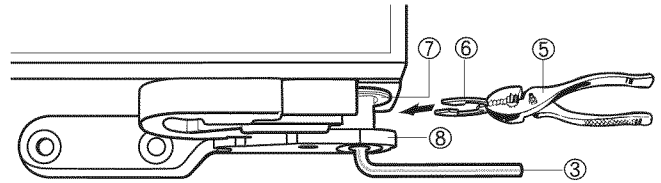

-  2 fastener are enclosed with the refrigerator. The thickness of each fastener is 0.04".

ADJUSTING THE FREEZER DRAWER LEVEL

Adjustment part

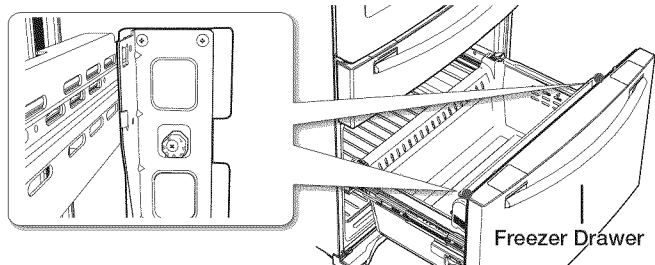

1. Locate the height-adjuster (**1**) in the freezer drawer. Unscrew the 8 Phillips screws (**2**) slightly to loosen the door.

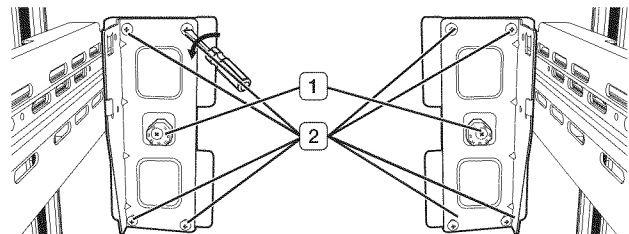

2. Loosen the controller screw (**3**) with a Phillips screwdriver(+).

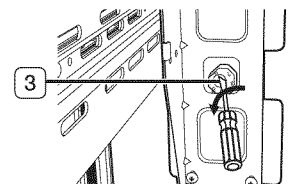

3. Find the best level to align the door slope.
 - After adjustment, tighten the controller screw (3) and then philips screws.

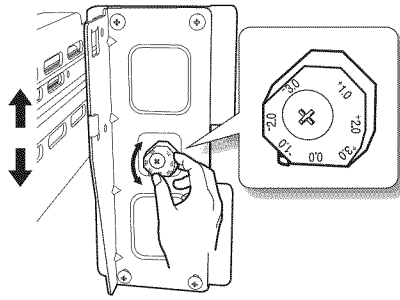

Example) The slope is about 0.08inch (2mm) as shown below.
 - Rotate the height adjuster to -2.0 to reduce the door slope.

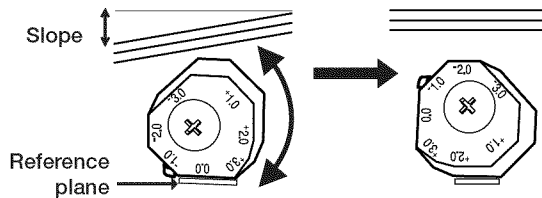

CHECKING THE WATER DISPENSER LINE

A water dispenser with a filter is one of the helpful features on your new refrigerator. To help promote better health, the water filter removes unwanted particles from your water. However, it does not sterilize or destroy microorganisms. You may need to purchase a water purifying system to do that.

In order for the ice maker to operate properly, a water pressure of 20~125 psi is required.

Under normal conditions, a 170 cc (5.75 oz.) cup can be filled in about 10 seconds.

If the refrigerator is installed in an area with low water pressure (below 20psi), you can install a booster pump to compensate for the low pressure.

After you have connected the water line, make sure the water storage tank inside the refrigerator is properly filled. To do this, press the water dispenser lever until the water runs from the water outlet.



Water line installation kits are available at extra cost from your dealer. We recommend using a water line installation kit that contains copper tubing and ¼" compression nut.

Connecting to the water supply line

1. First, shut off the main water supply.



2. Locate the nearest cold water drinking line and install the pipe clamp and shut off valve.

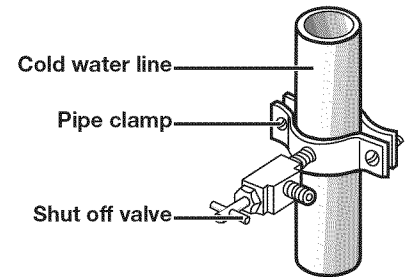

3. Connect the water line installation kit to shut off valve.

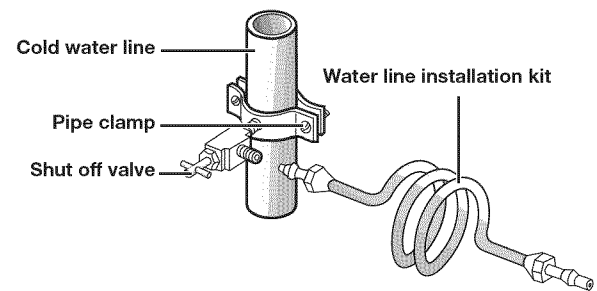

INSTALLING THE WATER LINE

Connecting the water supply line to the refrigerator.

There are several items that you need to purchase to complete this connection.

You may find these items sold as a kit at your local hardware store.

Use Copper Tubing	Use Plastic Tubing
<ul style="list-style-type: none"> • ¼" copper tubing • ¼" compression nut (2pc) • Ferrule (2pc) 	<ul style="list-style-type: none"> • ¼" plastic tubing → Molded end(Bulb) • ¼" compression nut (2pc)

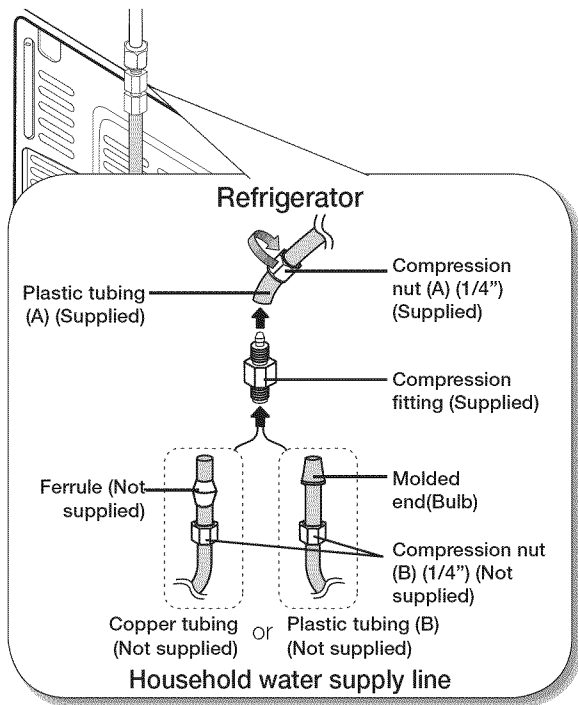

1. Slip the compression nut (**A**) through the supplied plastic tubing (**A**).
2. Tighten the compression nut (**A**) onto the 1/4" compression fitting.
 - If you are using copper tubing, slip the compression nut (**B**) (not supplied) and ferrule (not supplied) on copper tubing (not supplied) as shown.
 - If you are using plastic tubing (**B**), insert the molded end (Bulb) of the plastic tubing (**B**) into the compression fitting.

CAUTION  Do not use without the molded end(Bulb) of the plastic tubing (**B**).

3. Tighten the compression nut (**B**) onto the compression fitting.
Do not over-tighten the compression nut (**B**) .
4. Turn water on and check for any leakage. If you find water drops or leakage in the connection areas, turn off the main water supply.
Check the connections and, if necessary, tighten.
5. Flush 1 gallon of water through the filter before drinking or using the water from the refrigerator. (Flush approximately 6 minutes.)
To flush, press a large glass or cup against the water dispenser lever.
Fill the glass, empty it into the kitchen sink after it is filled, and then repeat.

6. After you turn on the refrigerator, let the ice maker make ice for 1 to 2 days.
Over that period of time, throw out the first 1 or 2 buckets of ice the freezer makes to ensure all impurities have been removed from the water line.



Only connect the water line to a drinkable water source.

If you have to repair or disassemble the water line, cut off 1/4" of the plastic tubing to make sure you get a snug, leak-free connection.

COMPLETING THE SET UP

Now that you have your new refrigerator installed in place, you are ready to set up and enjoy the features and functions of the appliance.

By completing the following steps, your refrigerator should be fully operational.

1. Make sure your refrigerator is in an appropriate location with reasonable clearance between it and the wall.
Refer to installation instructions in this manual.
2. Once the refrigerator is plugged in, make sure the interior light comes on when you open the doors.
3. Set the Temperature control to the coldest temperature and wait for an hour.
The freezer will get slightly chilled and the motor will run smoothly. Reset the refrigerator and freezer to the temperatures you want.
4. After you plug the refrigerator in, it will take a few hours to reach the appropriate temperature.
You can store food and drinks in the refrigerator after the temperature is sufficiently cool.

Operating your French Door Refrigerator

COMMON RESTRICTIONS AND PRECAUTIONS

1. English is a default language for the Display and languages not being supported may not displayed on the screen.
2. For the periodic updates of Weather or News, it may cause network traffics when the Display is not being used.
3. When there are softwares newly updated by Samsung, they will be automatically updated and it will be informed to the User.

DIGITAL PANEL

CPU	Marvel Aspen CPU(ARM)	OS	Linux 2.6.28
RAM	256MB	LCD	8" TFT-LCD(800*480)
ROM	512MB	NETWORKS	IEEE802.11 b/g

USING FIRST TIME

- When using the product first time after the installation, the following touch panel calibration screen appears on the Display Panel. According to the procedure appeared on the screen, tap on the center of the cross accurately. If the center is not properly pointed, the cross mark appears repeatedly.

After completing the touch screen calibration, its Home Screen will appear on the Display Panel. The touch panel calibration screen may appear again after the software update being completed.

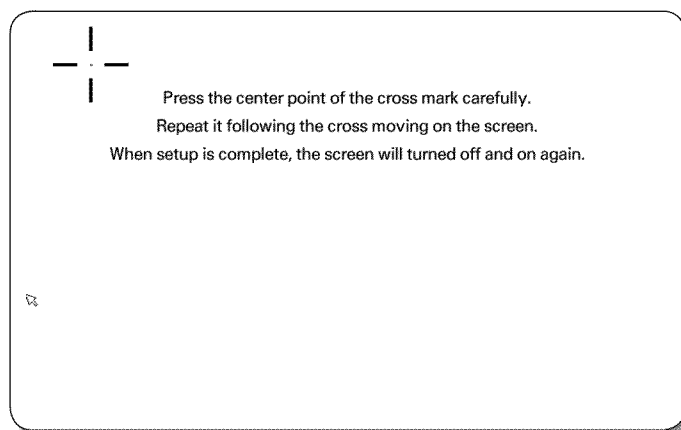

HOME SCREEN

- The Home screen is the starting point of setting all functions. Also, when the  icon is selected at all menus, it moves to the Home screen right away. On the center of the Home screen, the basic refrigerator information such as Time / Weather / Temperature / Dispenser Selection will show. The indicator icons at the left top of the Screen shows various information of the fridge and the bottom menus are the gates to each function.

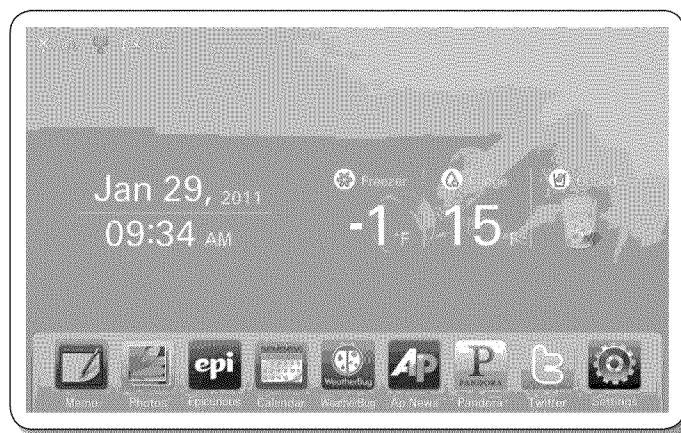

Indicator Icons (At the left-top of the Screen)

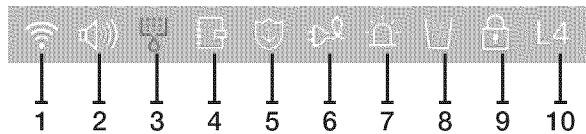

1. Network Signal Strength : 5 Level (off - 1 - 2 - 3 - 4)
2. Volume Level : 5 Level (off - 1 - 2 - 3 - 4)
3. Filter Status : 3 Level (blue - pink - red)
4. Schedule Alarm
5. S/W Update Notice
6. Energy Saver
7. Door Alarm
8. Ice Off
9. Dispenser Lock
10. Smart Grid-Level

Date/Time, Freezer/fridge temperature, Dispenser selection, Current weather (At the center of the Screen)

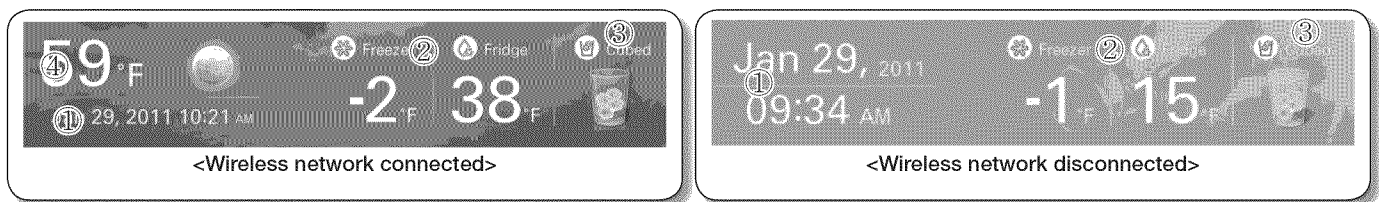

1. Date/Time : Indicates the current date and time.
2. Freezer/Fridge temperature : It shows the current freezer/fridge temperature. When the freezer/fridge temperature is pressed, the temperature setting screen will be displayed.
3. Dispenser : It shows the current status of the dispenser. When the current status of the dispenser is pressed, the ice type selection screen will be displayed.
4. Weather : indicates the current weather. The Home screen background image changes in 8 modes based on the current weather and time. (Clear, Cloudy, Snow, Rain) x (Day, Night)

Menu Description (At the bottom of the Screen)

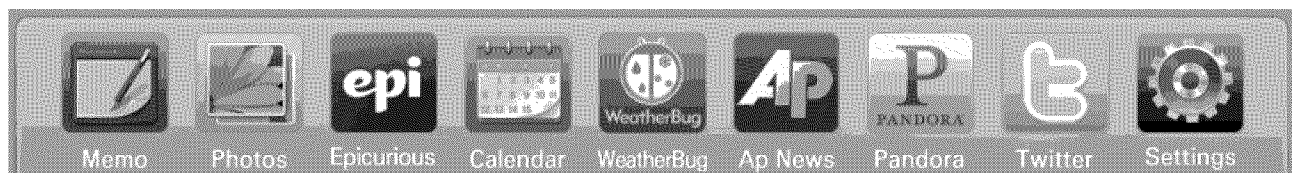





1. Memo : You can save or check necessary memos.
2. Photos : You can manage the stored photos, and can bring photos from the external devices such as memory cards or mobile phones and from the Internet.
3. Epicurious : It shows the food recipe.
4. Calendar : You can check your schedule stored in the Google Calendar.
5. WeatherBug : It shows the current weather and weather forecast.
6. AP News : It shows the internet news.
7. Pandora : It plays the Internet radio.
8. Twitter : It shows the twitter messages.
9. Settings : You can set the Various settings.

SETTING THE FREEZER/FRIDGE TEMPERATURE

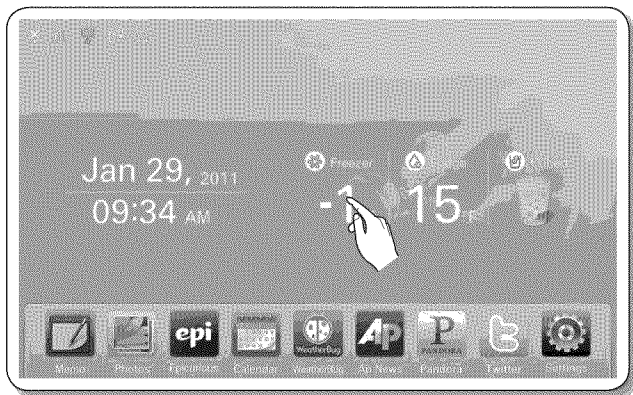
The temperature control allows you to set the freezer and the fridge temperatures. Use the following instructions to change and set these temperatures.

1. Touch the Freezer/Fridge temperature on the Home screen.



- When ice cream is stored at a temperature above 4°F (-16°C) in the freezer, it may melt.
-  : You can set the dispenser type. (Cubed/Crushed)
-  : You can move the home screen.
-  : You can move the preview screen.

2. Choose the desired freezer and/or fridge temperatures using the temperature buttons; then touch the Save button.

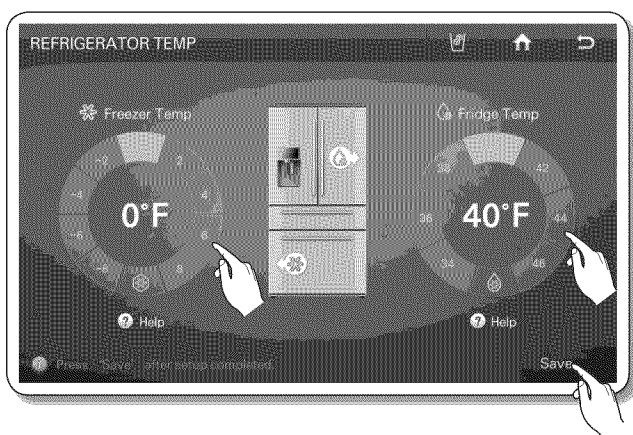

- Freezer : Fahrenheit : -8°F ~ 8°F(Default: -2 °F) Celsius : -22 °C ~ -14 °C(Default: -19 °C)
- Fridge : Fahrenheit : 34°F ~ 46°F(Default: 38°F), Celsius : 1°C ~ 7°C(Default: 3°C)

- The freezer or fridge temperature may change depending on the door opening/closing frequencies, the food quantity, the ambient temperature, etc.
- Temperatures vary at each food storage section in the freezer and refrigerator compartments.
- When the room temperature increases, there can be an “Abnormally High Temperature” pop-up. In this case, when the Freezer and the Fridge temperatures become normal, the pop-up will be automatically cancelled. But, when the pop-up is not cancelled after a long operation time, please contact your nearest repair center.

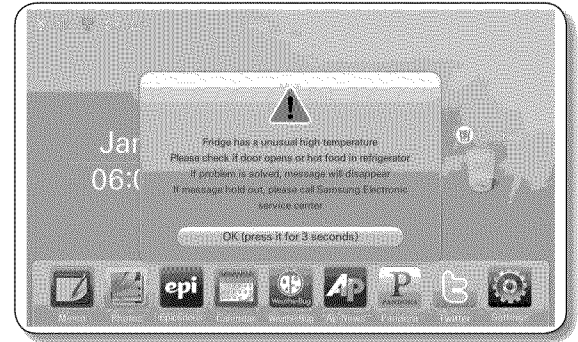



SETTING THE POWER FREEZE/POWER COOL

The Power Freeze and Power Cool functions can be used to quickly lower the temperature of the freezer and fridge compartments. Use the following instructions to activate these functions.

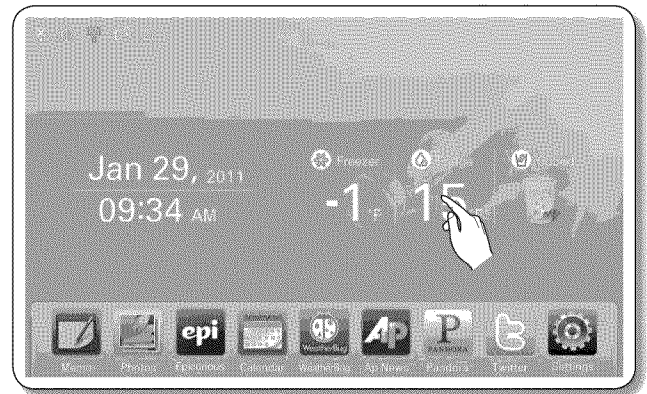
1. Touch the Freezer/Fridge temperature on the Home screen.



2. Touch the Power Freeze  and/or Power Cool  button(s); then touch the Save button.

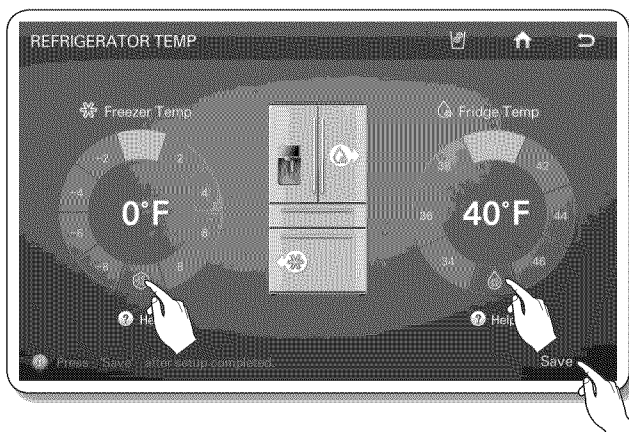

- To cancel the Power Freeze and the Power Cool, press the [Power Freeze] or the [Power Cool] button again or select a Temperature Setting button.
- Energy consumption increases during Power Freeze and/or Power Cool usage.
- When the question icon  is selected, its function description screen pops up. And, the [OK] button is selected on the popup screen, it goes back to the Temperature Display Screen.
- When you turn on Power Freeze/Power Cool, the refrigerator's compressor speeds up and is louder than during normal operation.

SETTING THE DISPENSER

You can select the ice type.

1. Touch the dispenser status on the Home screen.

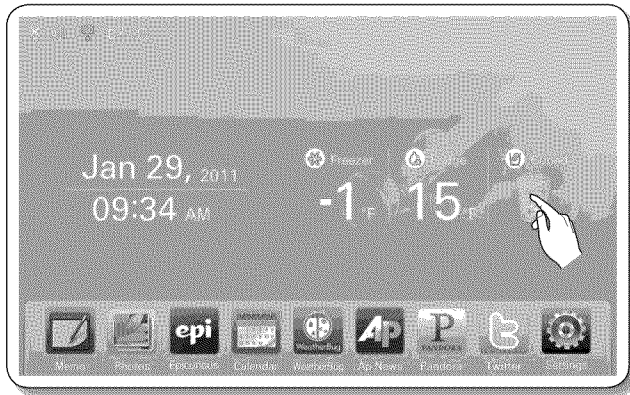

2. Touch the desired dispenser type; then touch the CLOSE button.

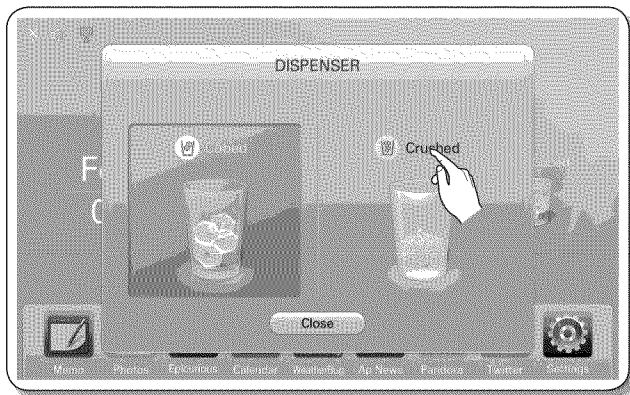

- Touch the Ice Off, if you don't want to make more ice.
- When the Ice Off is set, the Ice Off indicator icon () appears on the left top of the Home screen.
- We recommend you stop ice making if the following occur:
 - There is enough ice in the ice bucket.
 - You want to save water and energy.
 - Water is not being supplied to the refrigerator.
- If the ice maker function is ON, and the water line is not connected, there will be a water valve noise from back of the unit. Touch the Ice Off on the DISPENSER select box.

3. Place glass in dispenser to dispense selected ice or water.(refer to HOW TO USE THE DISPENSER)

DOOR OPEN ALARM

When the fridge / fridge door remains open over 2 minutes, a warning window pops up with alarm sounds. After the first alarming, it repeats every minute. And, it stops when closing both doors. If the Door Alarm OFF is selected on the Settings function, alarming does not occur.

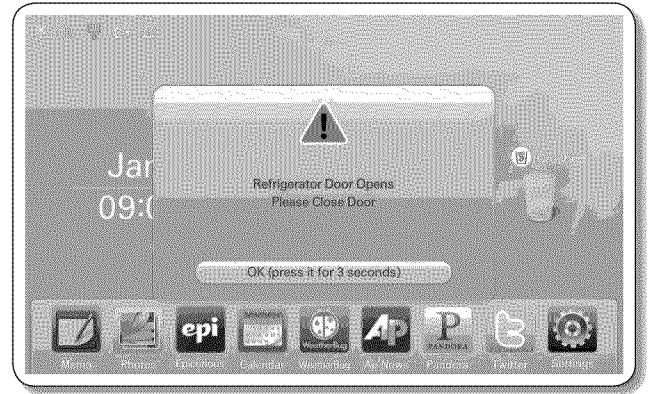

MEMO

This feature can be used to leave a memo for yourself or someone else.

How to leave a new memo.



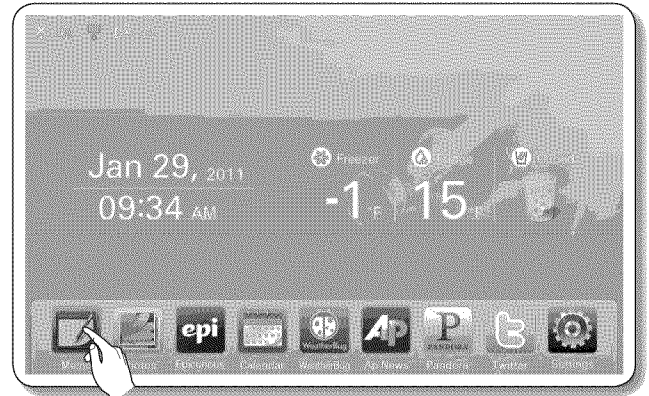

1. Touch the Memo button on the Home screen.

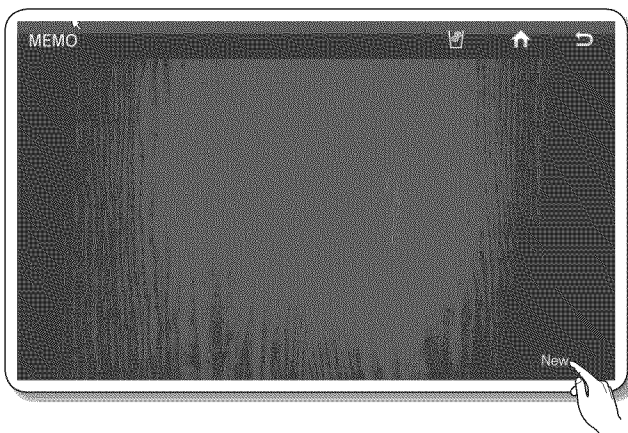

2. Touch the New button.



3. Select the messaging tools as needed by touching the buttons upper the message screen. Enter the message contents with the selected tools.

-  : Select to input a memo in pen mode.(your finger or a smooth-tip pen such as a style pen.)
-  : Select to input a memo in keyboard mode.
-  : Select to erase a memo.
-  : Select pen or erase thickness.
-  : Select pen color.

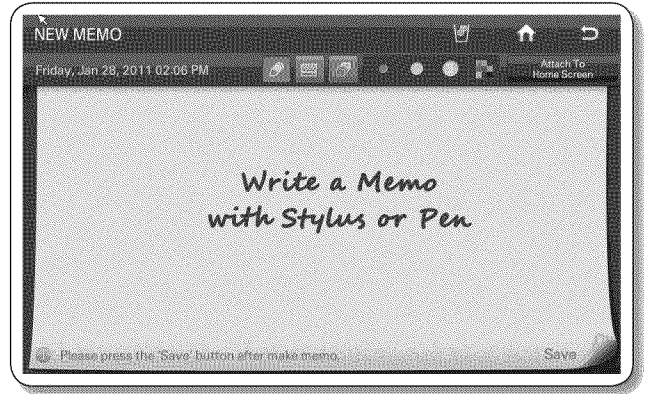

- Up to 80 memos can be saved.
- Press the Keyboard icon and touch on the location to write a memo. Then the keyboard pops up on the Display. The number of letters that can be input on the Keyboard are limited not to exceed the size of the memo.

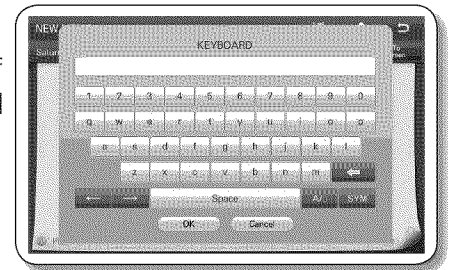

4. Touch the Save button after entering all the information.

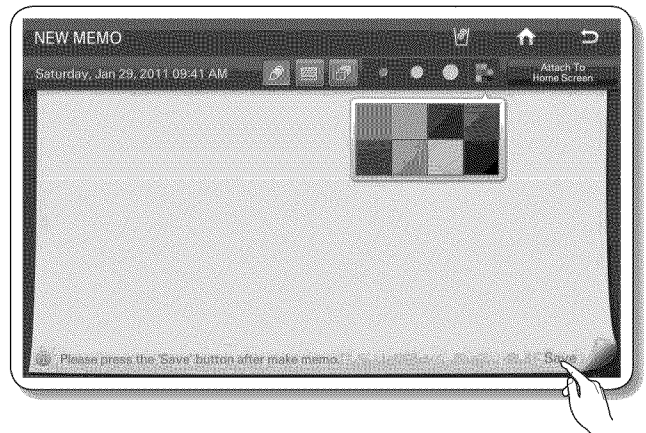

- When selecting the Attach to Home Screen button, the stored memo displays on the Home screen.

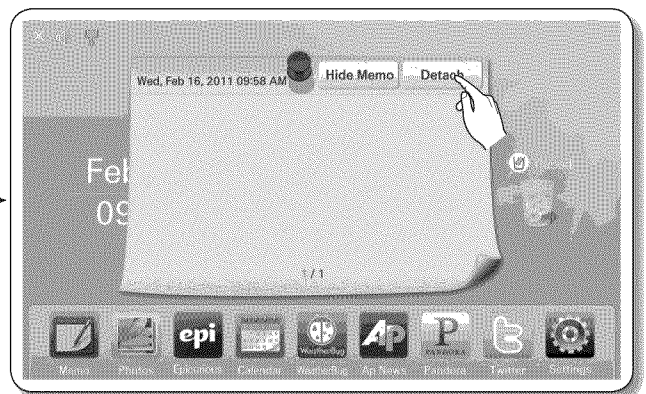
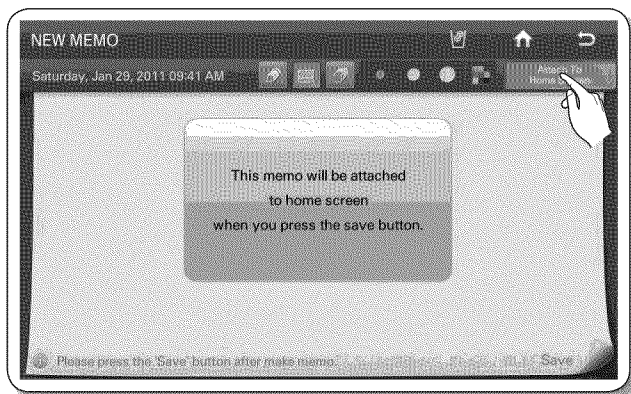

- The memo being displayed on the Home screen can be put away by touching the Detach button or can be temporarily hidden by touching the Hide Memo button.

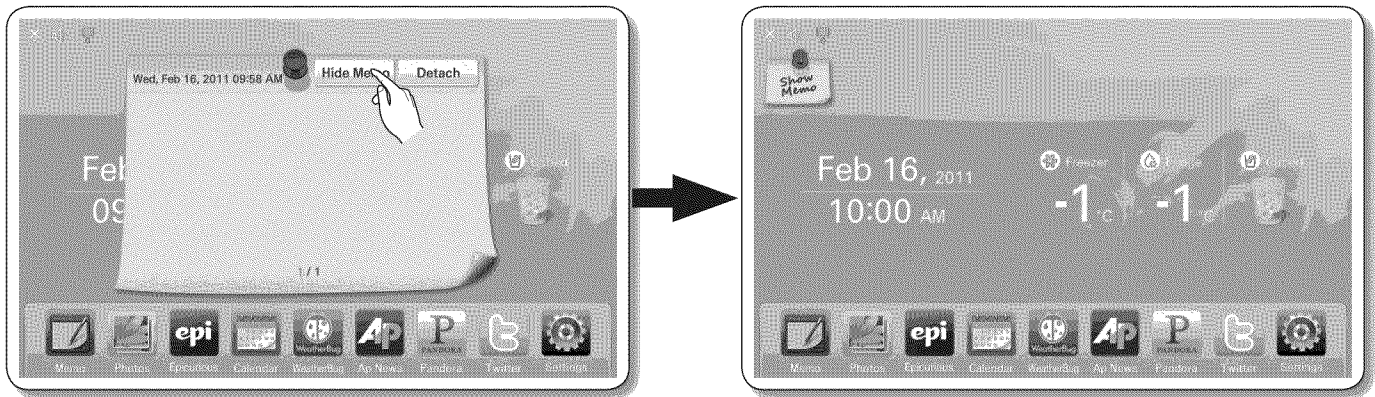

How to show the memo(s).

1. Touch the Memo button on the Home screen.

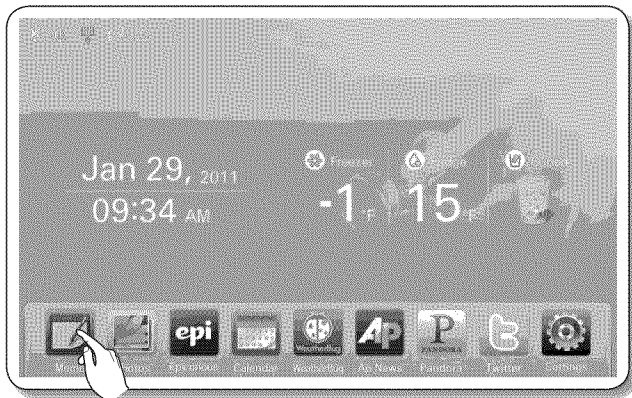

2. Choose the desired memo to show.

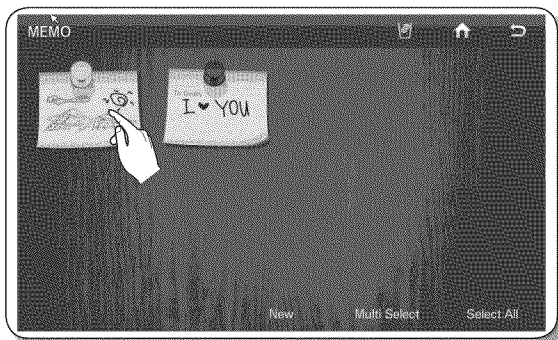

2. To see multiple memos, press the Multi Select button.

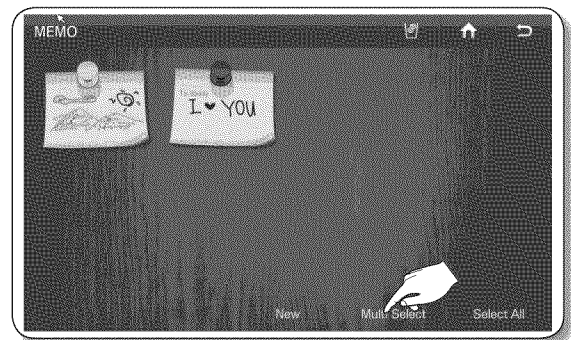

- When pressing the Select All button, the Multi Selection screen shows.
- When there are multiple pages with many memos, there will be page numbers on the bottom of the screen. And, when pressing the page number, the screen shifts to the related page.
- The menu being displayed on the main screen is indicated with the red tack.
- The written memos will show as thumbnails. The order of the written memos can be changed by drag and drop.

3. Check the saved memo.

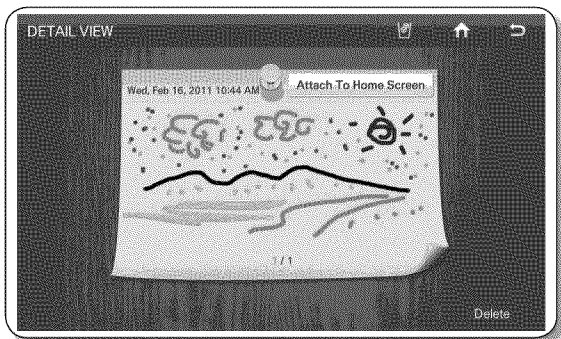

- In the Detail View screen, you can delete it or attach/detach it on the Home screen.

3. Choose the desired memos to show.



- When pressing the Select All button, all the memos on the current page will be selected and the Select All button will shift to the Unselect All button.
- To go out of the Multi Select screen, press the Cancel button.
- When the stored memos are many, there will be page numbers on the bottom of the screen. And, when pressing the page number, the screen shifts to the related page.

4. Touch the View Selected button.



5. Check the saved memo by using the < and > buttons.

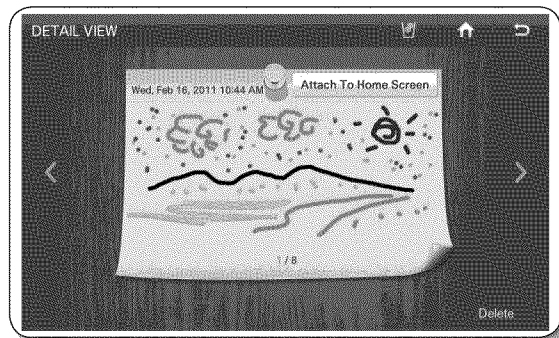

- In the Detail View screen, you can delete it or attach/detach it on the Home screen.

How to delete the memo(s).

1. Touch the Memo button on the Home screen.

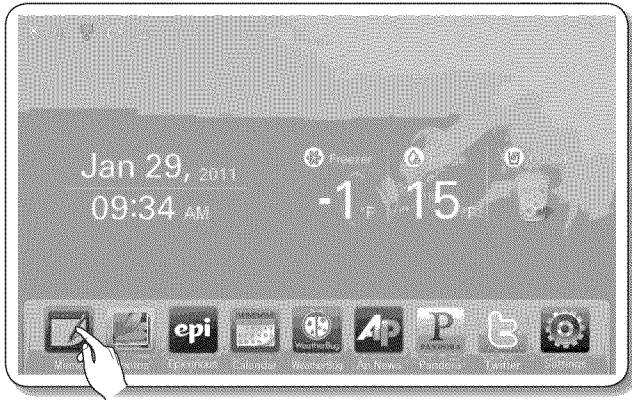

2. Choose the desired memo to delete.

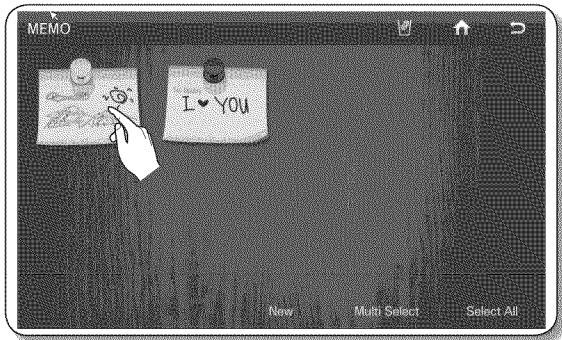

3. Touch the Delete button.

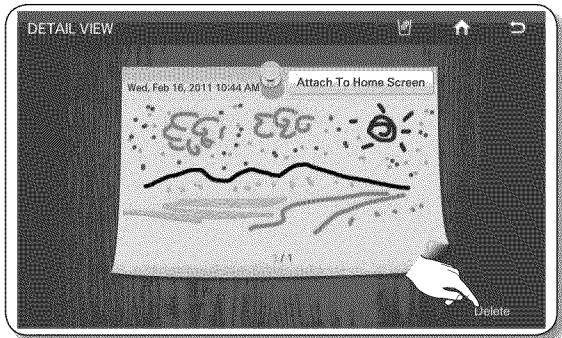

2. To delete multiple memos, press the Multi Select button.

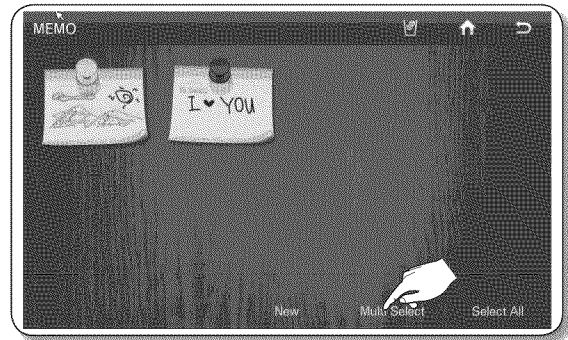

3. Choose the desired memos to delete.



4. Touch the Yes button.

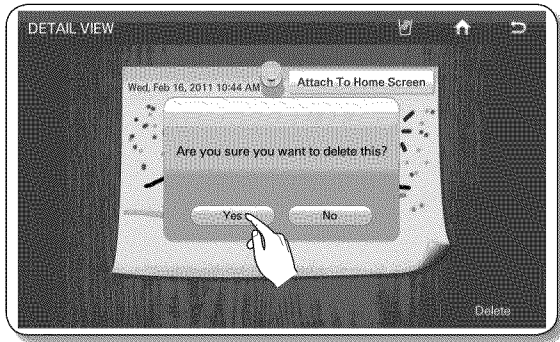

4. Touch the Delete button.

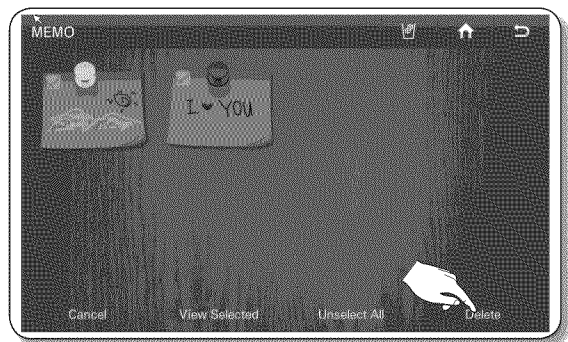

5. Touch the Yes button.

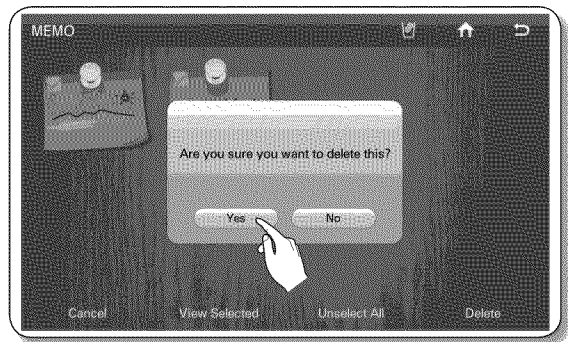

PHOTOS

Photos can be uploaded from a Memory card/DLNA device/Picasa Web Album into the My Album of this refrigerator.

How to Copy Photos from Memory Card to My Album

1. Pull out the cover over the card slot and move it to the side.
2. Insert the memory card (SD/SDHC/MMC/HS MMC) with images saved into the card slot. The "A SD/MMC card is connected" message appears on the screen.

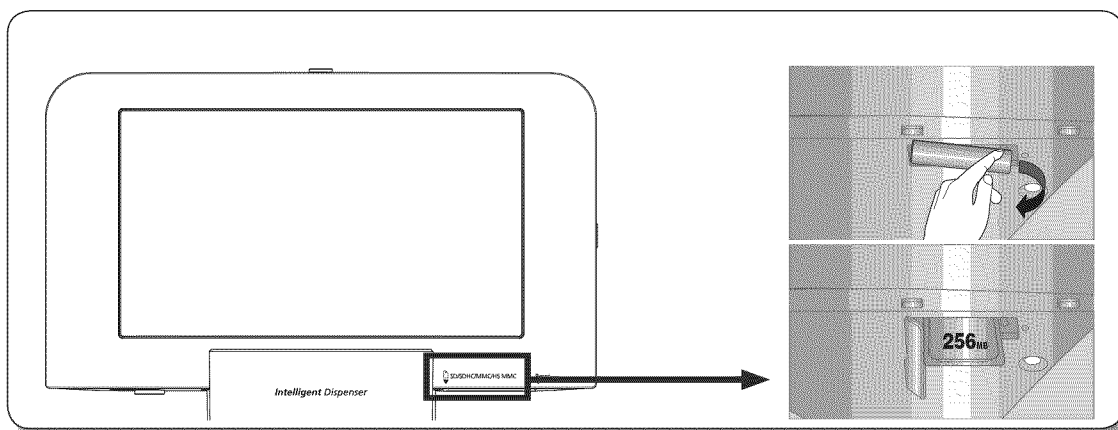



- The Memory slot is only for SD/SDHC/MMC/HS MMC type memory cards.
- It reads only JPEG(JPG) images.
- The Panel has a capacity of about 300 photos.
- When saving photos from a memory card to the panel, the photo size is automatically changed to 800 x 480 pixels, regardless of the original size.
- If there are many photos saved on the Memory card, it will take awhile for the preview function to load.
- If the Memory Card is removed while transferring images, the My Album only shows the images that have completed transfer. If not a single image has completely transferred, it returns to the photos screen.
- The saved images are fit to the screen size. Depending on the size of an image, there may be black bars on the top or sides.
- A Memory Card is not supplied with the refrigerator.
- Depending on the type of SD/SDHC/MMC/HS MMC memory cards, there may be some that are unreadable.

1. Touch the Photos button on the Home screen.

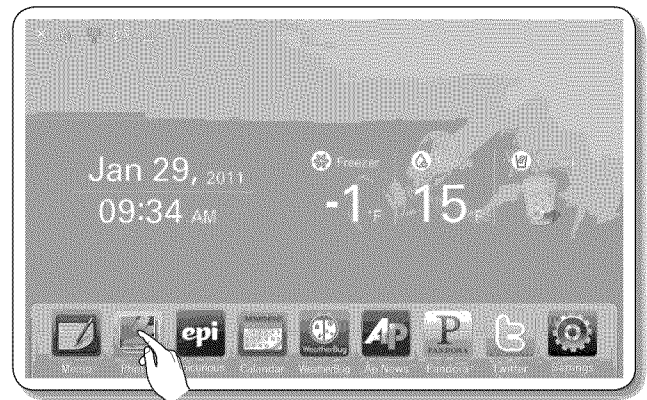

2. Touch the Memory Card on the photos list.

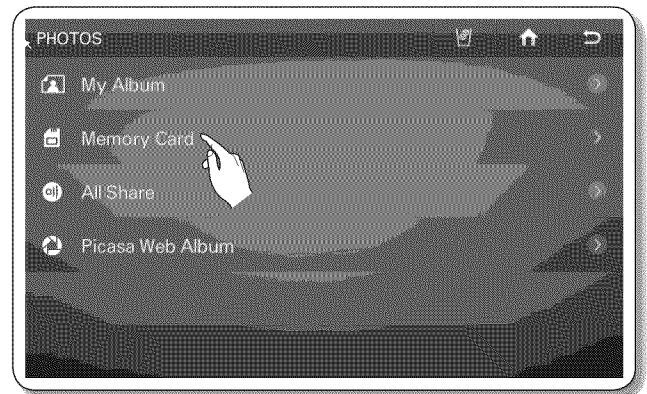

3. Choose the desired photo to save in the My Album.

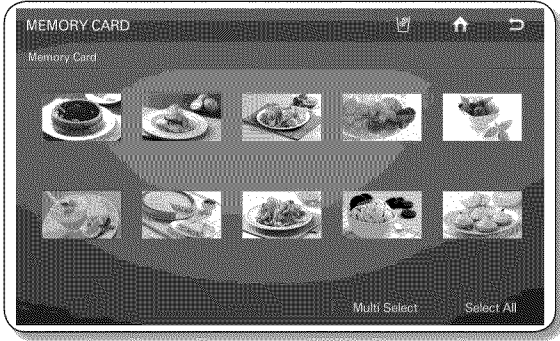

3. To store multiple photos, press the Multi Select button.

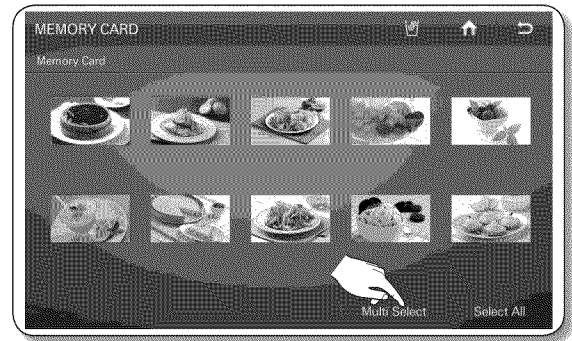

- When pressing the Select All button, the Multi Selection screen shows.
- When there are multiple pages with many photos, there will be page numbers on the bottom of the screen. And, when pressing the page number, the screen shifts to the related page.
- This function also applies to the <All Share> and <Picasa Web Album> functions.

- When there are folders in the Memory Card, the folder icons will appear on the screen.
- When you select the folder, you will see the photos stored in it.
- At the lower tree folders, you can move to its upper tree folder by selecting the '..' icon.

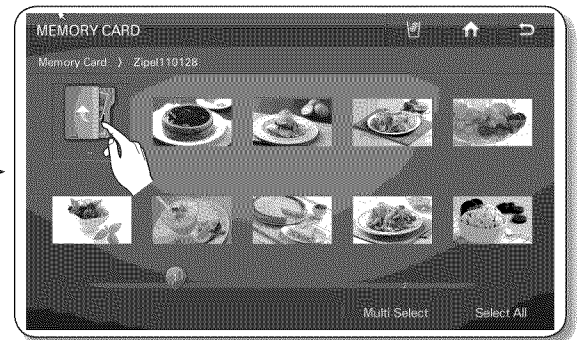
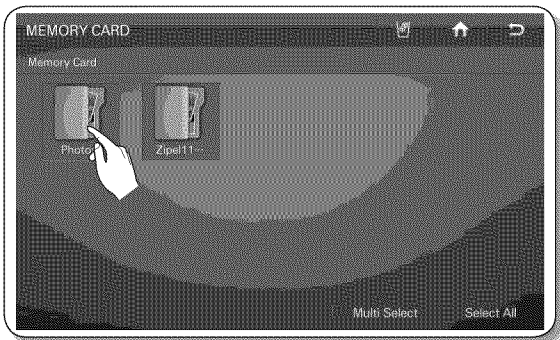

4. Touch the Save To My Album button.

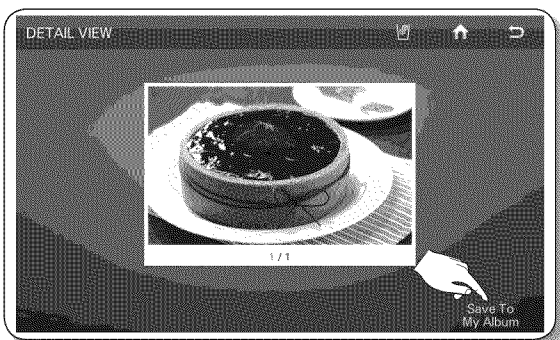

4. Choose the desired photos to save in the My Album.



- When the photo is selected, it will display its detail information.
- Larger photo sizes will take longer to upload.

- When pressing the Select All button, all the photos on the current page will be selected and the Select All button will shift to the Unselect All button.
- When you press the View Selected button, you will see its larger version.
- To go out of the Multi Select screen press the Cancel button.
- To delete the check mark on the selected photo, select the target photo again.
- When there are multiple pages with many photos, there will be page numbers on the bottom of the screen.
- When moving to other folders with photos selected, the selected photos will be automatically unselected.
- When selecting the folder name above the thumb-nail (Preview Photo), it moves to the related folder.
- This function also applies to the <All Share> and <Picasa Web Album> functions.

5. The " Save To My Album" appears on the screen while uploading photo from the Memory Card.



- Larger photo sizes will take longer to upload.

5. Touch the Save To My Album button.



6. The " Save To My Album" appears on the screen while uploading photos from the Memory Card.

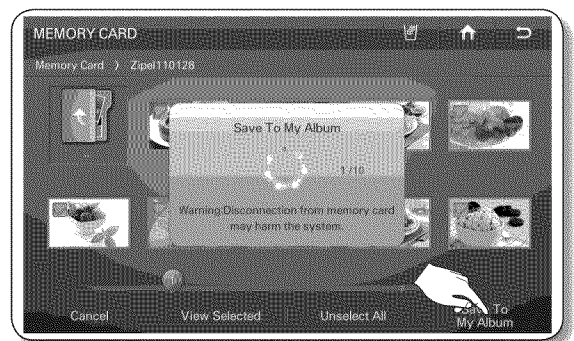

- Larger photo sizes will take longer to upload.

7. Take out the Memory Card from the slot.

How to store DLNA device photos to My Album

- This function is only available when the wireless network (Wi-Fi) is connected.

1. Touch the Photos button on the Home screen.

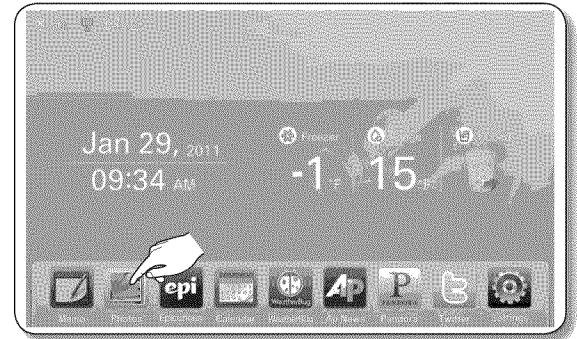

2. Touch the All Share on the photos list. At this time, the DLNA device to connect needs connecting to the same wireless AP as to the refrigerator.

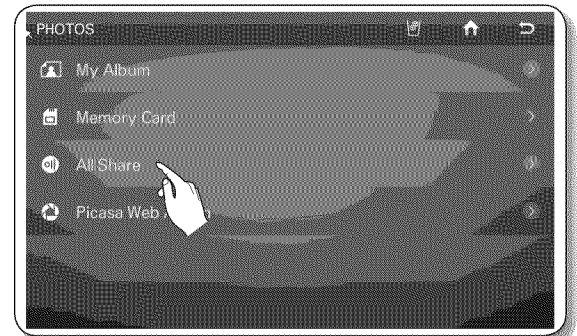

3. Choose the desired DLNA device to connect.
• If the DLNA device to connect does not show, press the Refresh button several times to detect it.

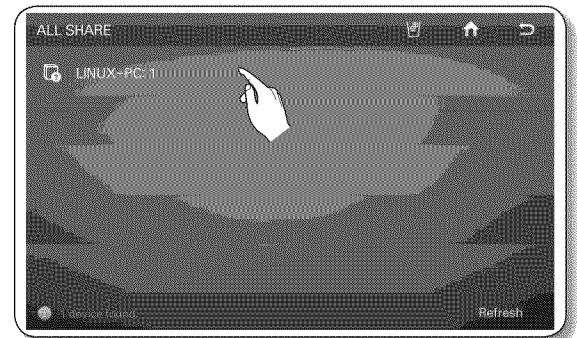

- The device to connect shall have the related function installed with the DLNA (Digital Living Network Alliance) certificate.
- The display supports upto 4096*4096 (16 mega) resolutions. When the number of pixels at either vertical or horizontal axis of a photo is more than 4,096 or its resolution is changed, the display may not support it.

4. Choose the desired folder.

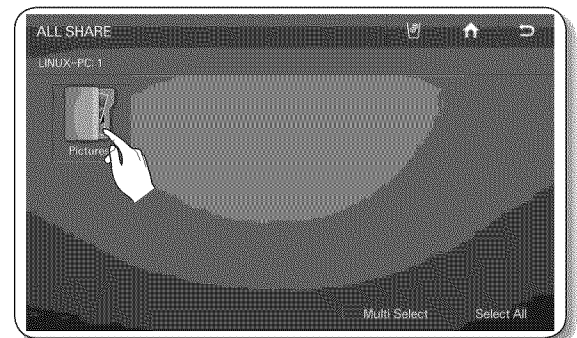

- At the lower tree folders, you can move to its upper tree folder by selecting the '..' icon.

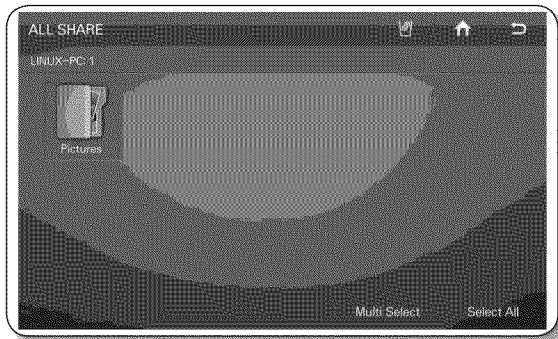

5. Choose the desired photo to save in the My Album.

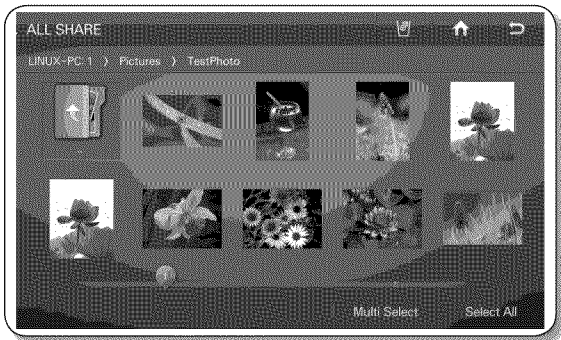

6. Touch the Save To My Album button.

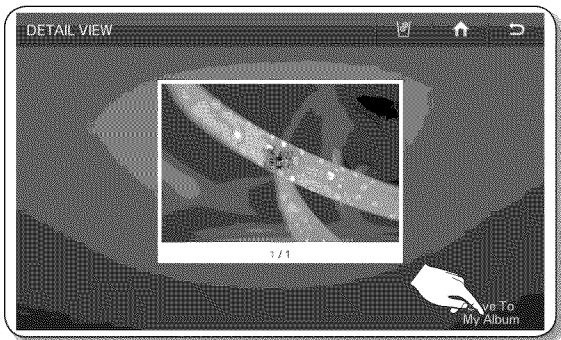

7. The "Save To My Album" appears on the screen while uploading photo from the DLNA device.

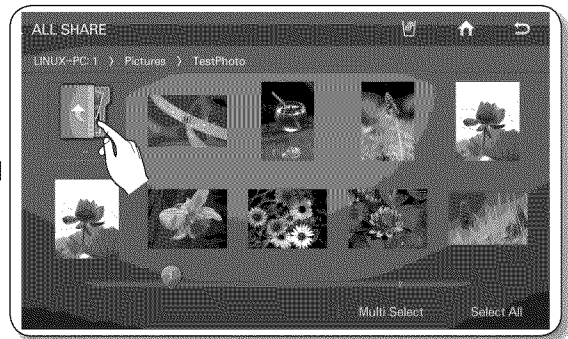

5. To store multiple photos, press the Multi Select button.

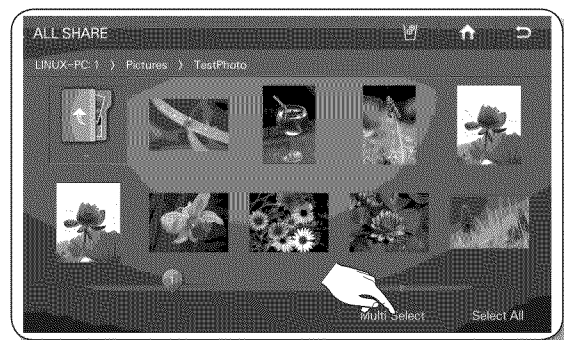

6. Choose the desired photos to save in the My Album.

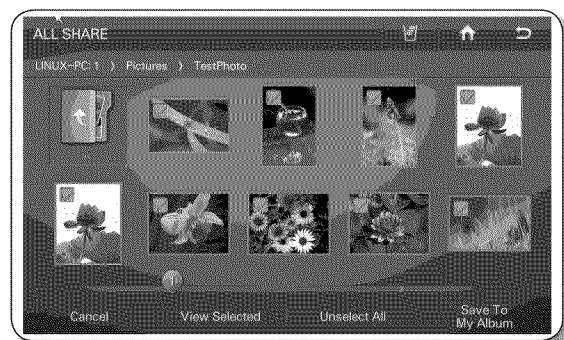

7. Touch the Save To My Album button.

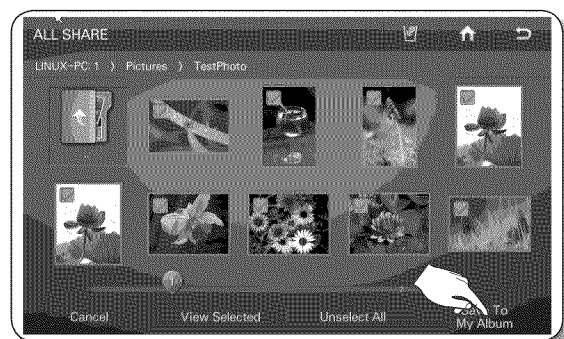

8. The " Save To My Album" appears on the screen while uploading photos from the DLNA device.

- Larger photo sizes will take longer to upload.
- The wireless network is used to transmit photos in the DLNA device. So, the transmission may not work properly depending on the network conditions.
- When the photo is selected, it will display its detail information.

How to save photos in the Picasa Web Album to My Album.

[Publicized Photos]

You can download and see the publicized photos from Google Picasa Web Album.

- This function is only available when the wireless network (Wi-Fi) is connected.

1. Touch the Photos button on the Home screen.

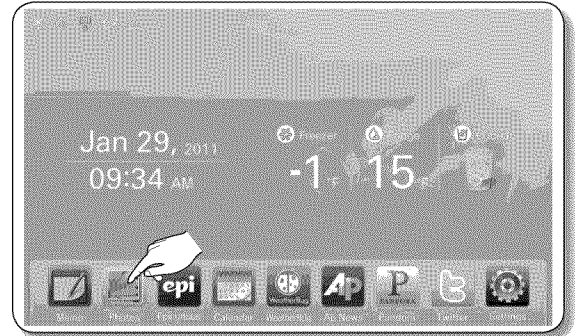

2. Touch the Picasa Web Album on the photos list.

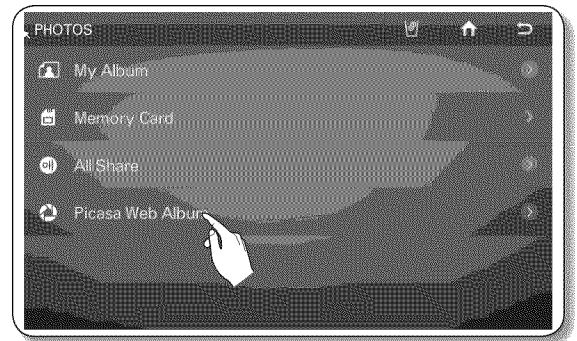

3. Choose the desired photo to save in the My Album.

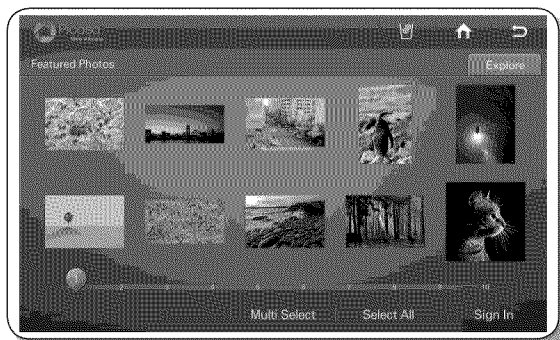

3. To store multiple photos, press the Multi Select button.

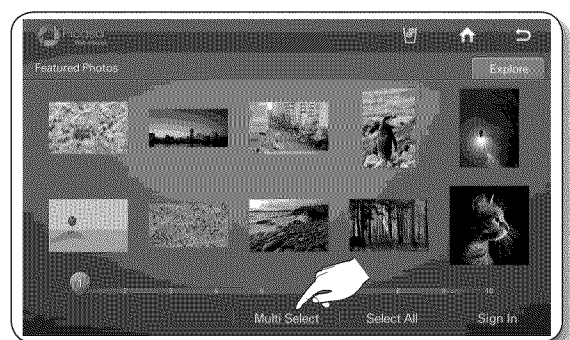

4. Touch the Save To My Album button.

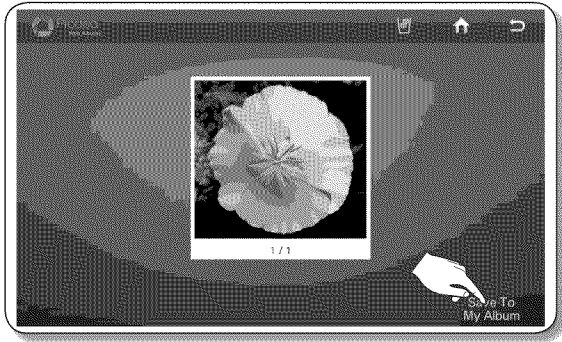

5. The "Save To My Album" appears on the screen while uploading photo from the Picasa Web Album.

4. Choose the desired photos to save in the My Album.

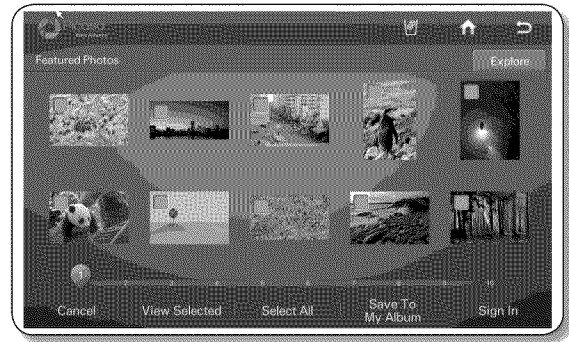

5. Touch the Save To My Album button.

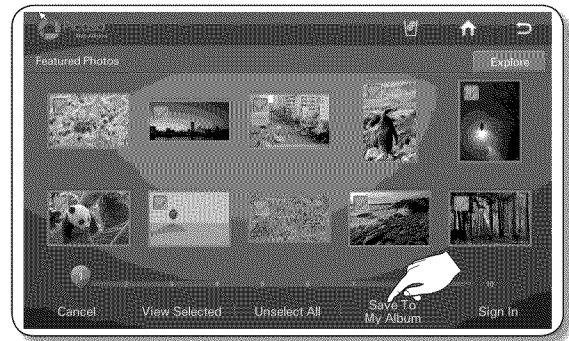

6. The " Save To My Album" appears on the screen while uploading photos from the Picasa Web Album.



- When the photo is selected, it will display its detail information.
- Larger photo sizes will take longer to upload.
- According to the status of the wireless network, you may not expect smooth transmission.

[Personalized Photos]

You can download and see the personalized photos from Google Picasa Web Album.



- This function is available only when the refrigerator is connected to the wireless network (Wi-Fi).
- To use this unction, it needs a Google account.

1. Touch the Photos button on the Home screen.

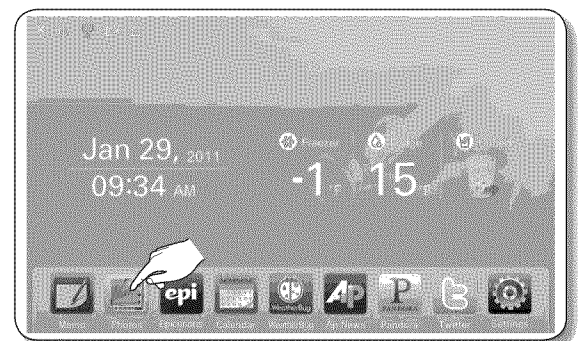

2. Touch the Picasa Web Album on the photos list.

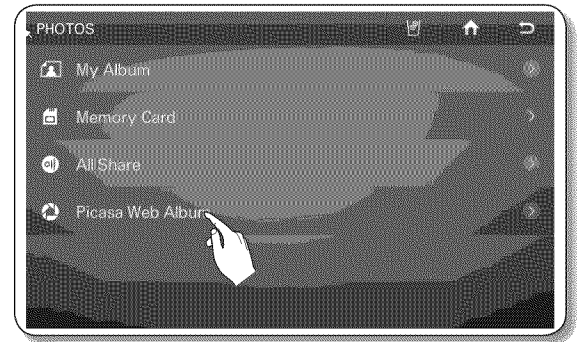

3. Touch the Sign In button.



- When you have an account with Google Picasa (<http://picasaweb.google.com>), you can see the uploaded photos in the Picasa by logging in with the account.

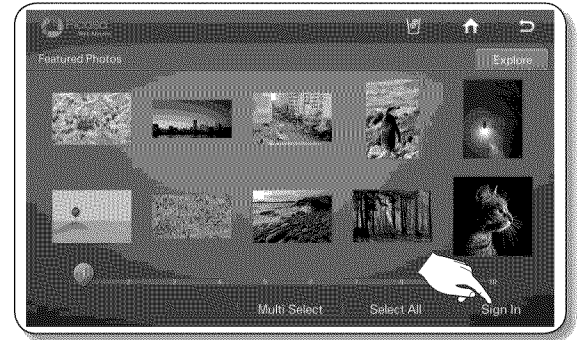

4. Choose the Email and Password input box: then enter the your Google account ID and password by using the screen keyboard.

5. Touch the Sign in button.

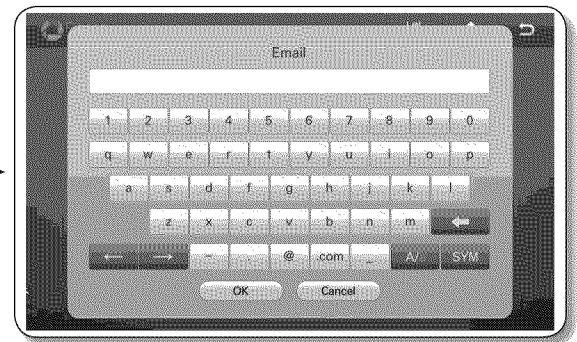
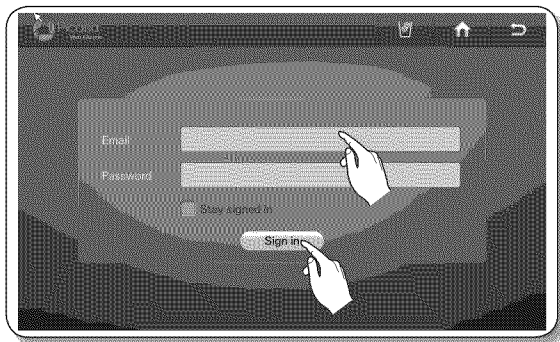

- When checking on the 'Stay signed in' box, the account will be stored for future log-in.

6. Select a web album having photos to store in My Album.

- If you touch the Sign Out button, it return to the Picasa publicized photos screen.
- If you choose the Explore tap on the right upper corner, the publicized photos screen will be displayed.

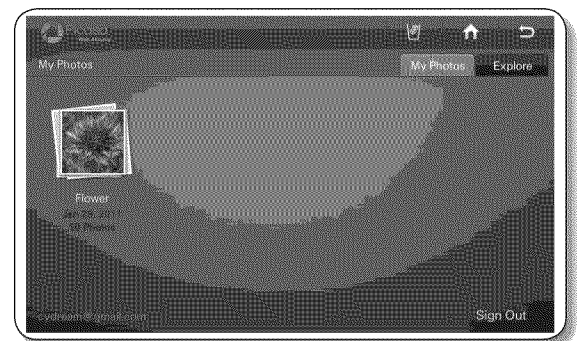

7. Choose the desired photo to save in the My Album.

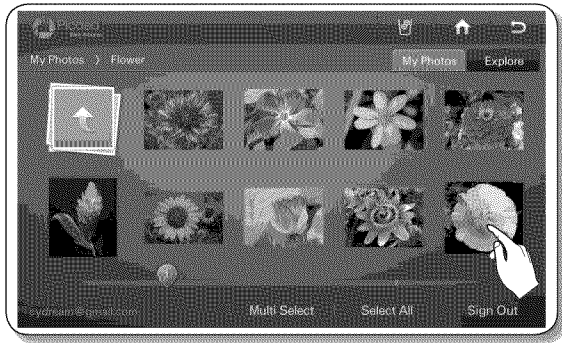

7. To store multiple photos, press the Multi Select button.

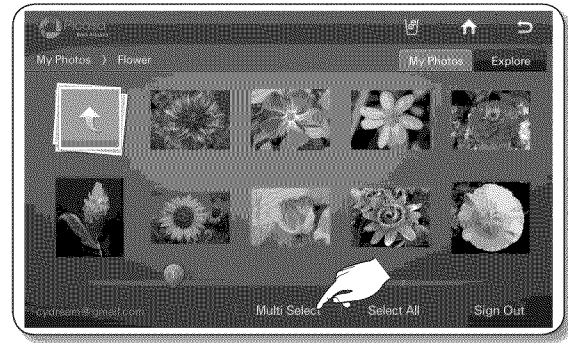

8. Touch the Save To My Album button.

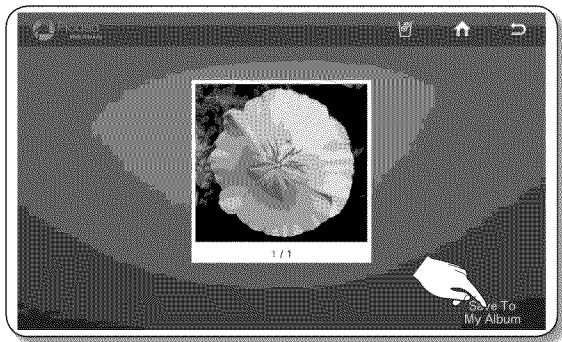

8. Choose the desired photos to save in the My Album.

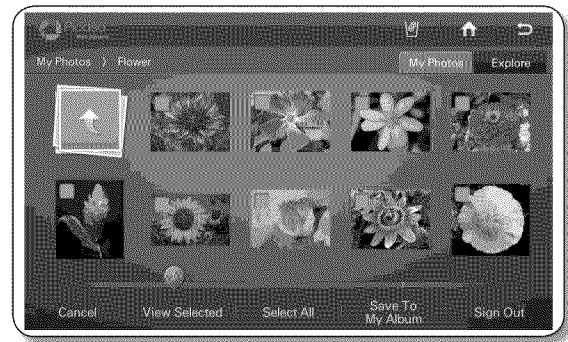

9. The "Save To My Album" appears on the screen while uploading photo from the Picasa Web Album.

9. Touch the Save To My Album button.

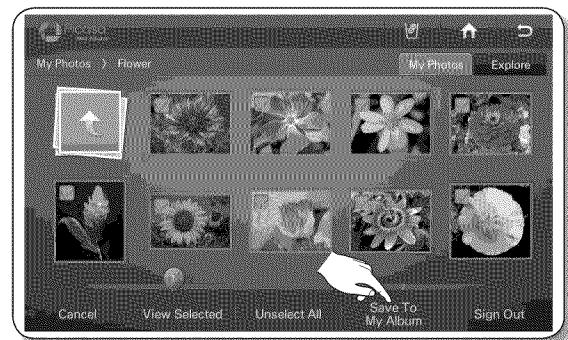

10. The "Save To My Album" appears on the screen while uploading photos from the Picasa Web Album.



- When the photo is selected, it will display its detail information.
- Larger photo sizes will take longer to upload.

How to set the slide show.

1. Touch the Photos button on the Home screen.

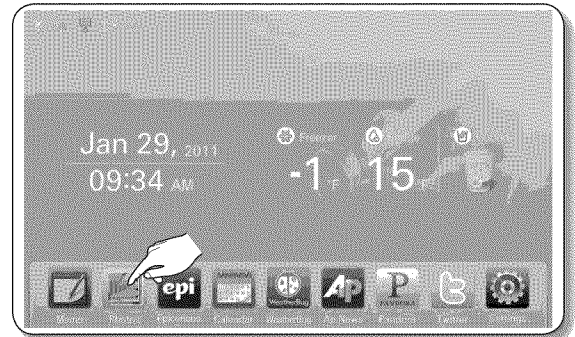

2. Touch the My Album on the photos list.

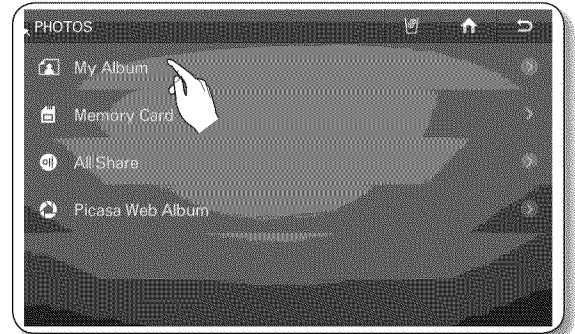

3. Touch the Multi Select button.

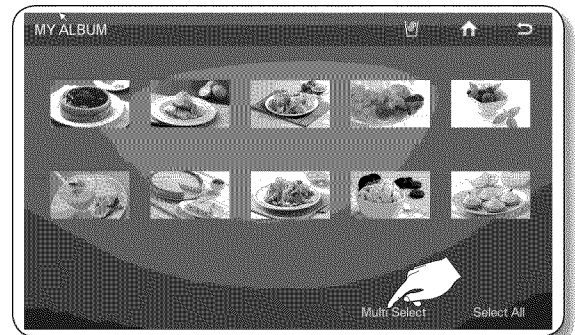

4. Choose the photos for slide show and touch the View Selected button. (Select more than two photos.)

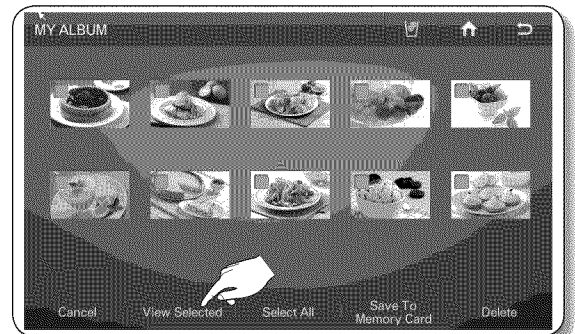

5. Touch the Slide Show button.

- Depending on the photo size (Width*Height), there could be blank bars on the top and sides of the image.
- When the photo is selected, it will display its detail information.



6. The slide show will start with selected photos and touch the screen to change the view option.

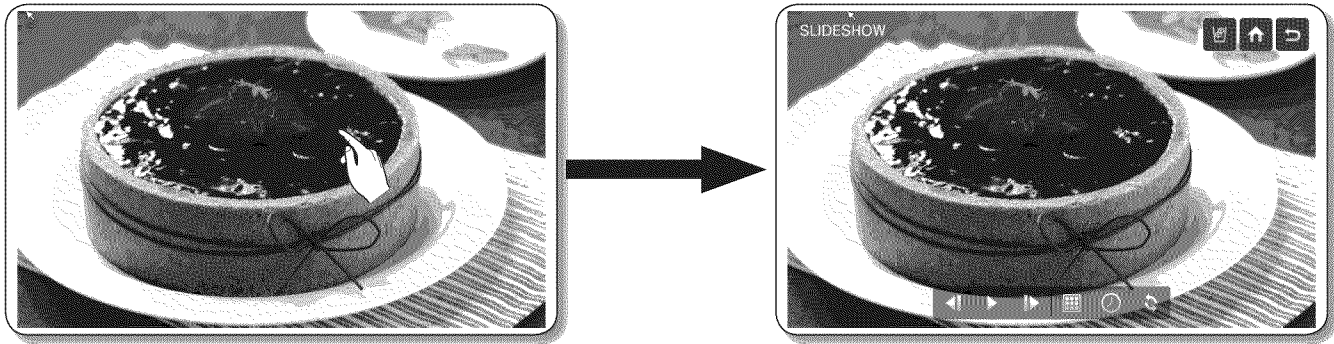

- With the selected photos, the slide show runs one time. And, when the slide show finishes, the view options will appear on the screen.
- By selecting the ◀ and ▶ buttons, you can move to the previous or next photo.
- When selecting the ↻ button, the slide show will run again.

7. To change the screen transition effect of the slide show, select  button.



8. Choose the desired slide show transition effects: then touch the OK button.

- You can preview the selected effect can on the left side of the screen.
- The Random effect runs the photos without order.

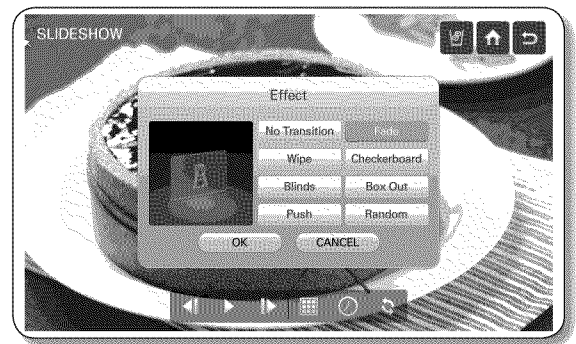

9. To change the screen transition time, select the  button.

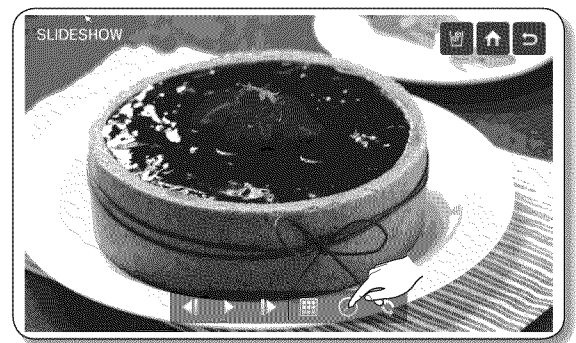

10. Use the - and + buttons to change the slide show transition speed: then touch the OK button.

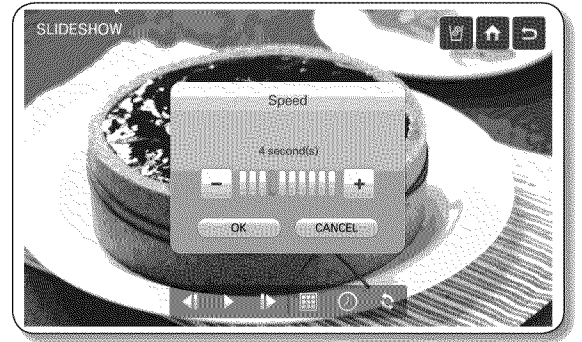

11. To change the slide show order of the photos, select the  button.



12. Choose the desired slide show order of the photos: then touch the OK button.

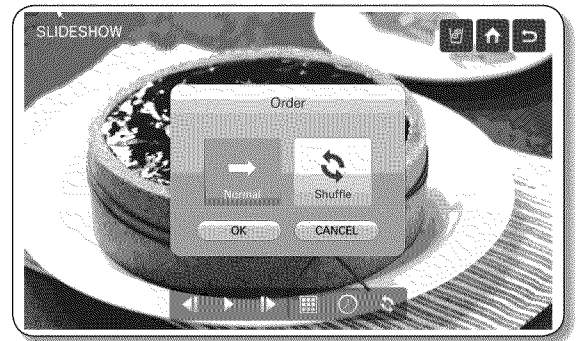

How to rotate the photo(s).

1. Touch the My Album on the photos list.

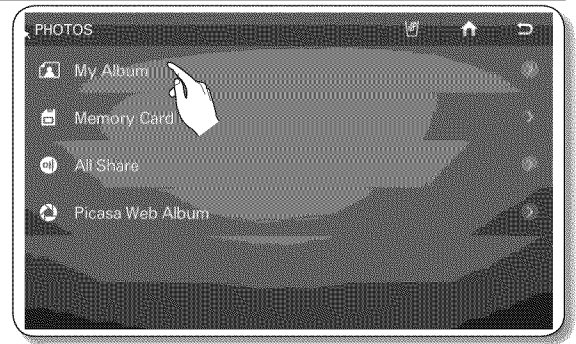

2. Choose the desired photo to rotate.

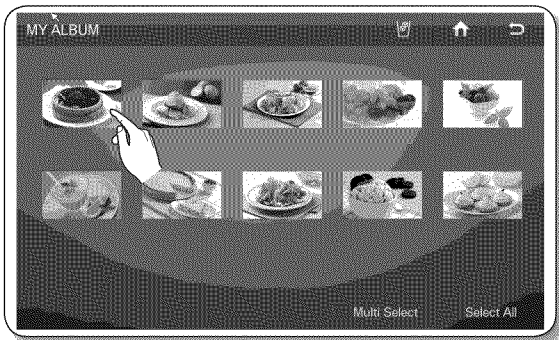

3. Choose the -90° Rotate or 90° Rotate button.

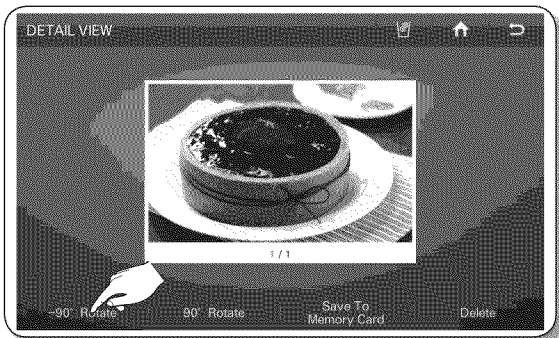

2. Press the Multi Select button to rotate multiple photos.

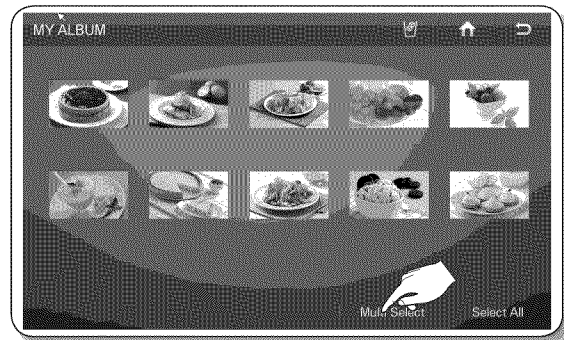

3. Choose the desired photos to rotate: then touch the View Selected button.

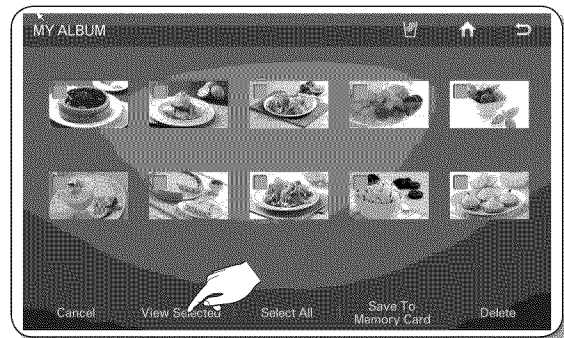

4. After selecting the photos to rotate with the < and > buttons, press the -90° Rotate or 90° Rotate button.



- The rotated photos will be automatically stored (replacing the original photos).

Save to memory card.

1. Touch the My Album on the photos list.

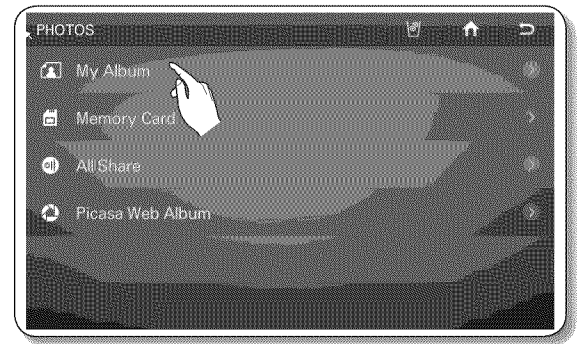

2. Choose the desired photo.

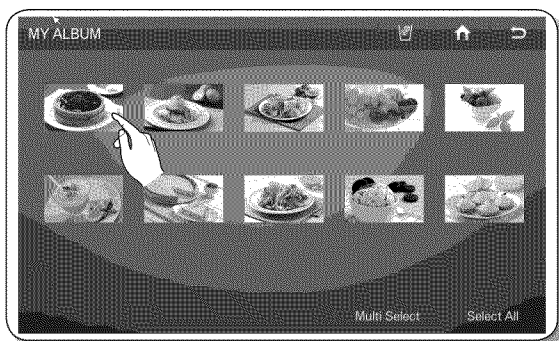

2. To save multiple photos, press the Multi Select button.

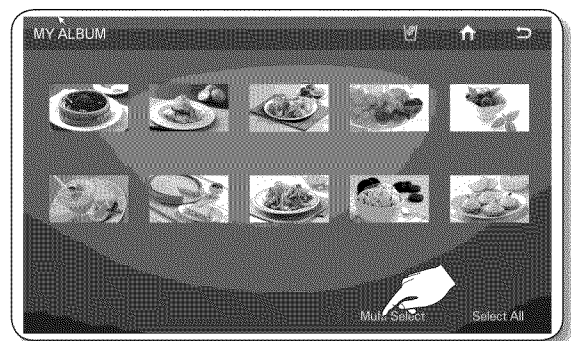

3. Touch the Save To Memory Card button.

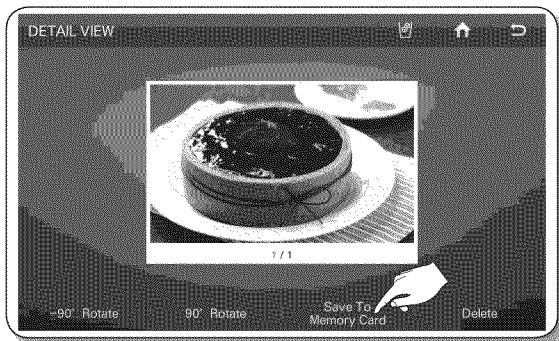

3. Choose the desired photos: then touch the Save To Memory Card button.

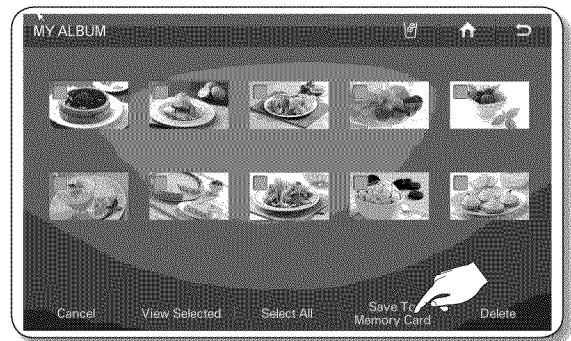

4. The "Save To Memory Card" appears on the screen while saving photos.



- A memory card needs to be inserted to save the photos in My Album to the memory card.

How to delete the photo(s).

1. Touch the My Album on the photos list.

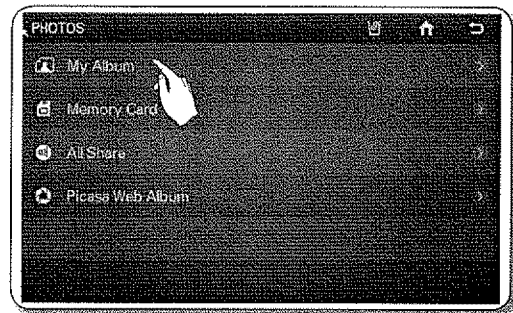

2. Choose the desired photo.

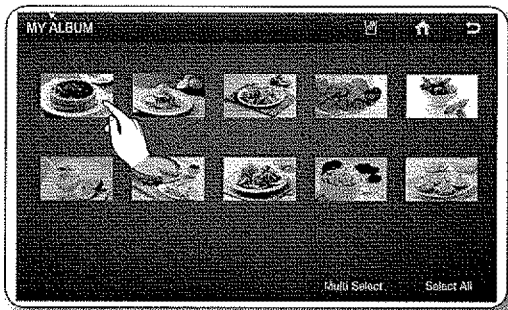

2. To delete multiple photos, press the Multi Select button.

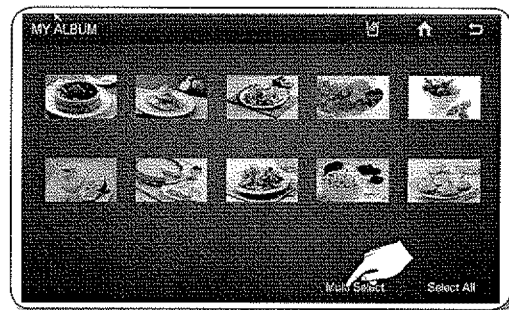

3. Touch the Delete button.

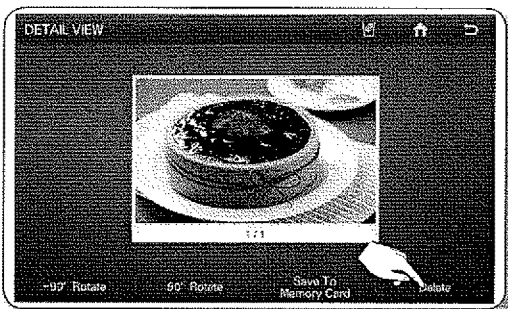

3. Choose the desired photos: then touch the Delete button.

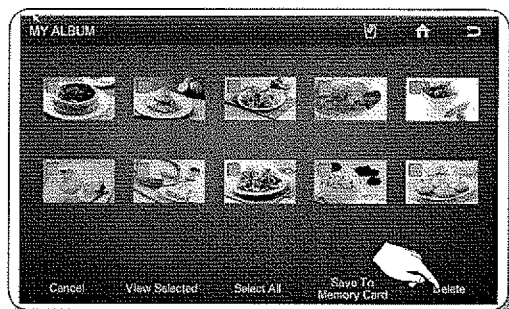

4. Touch the Yes button.

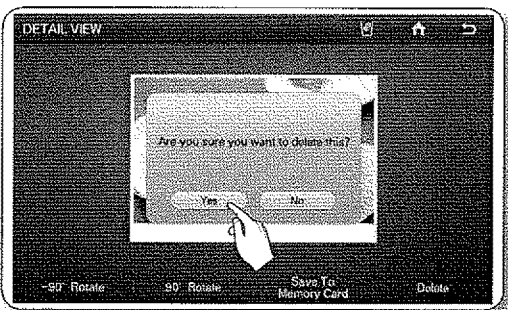

4. Touch the Yes button.

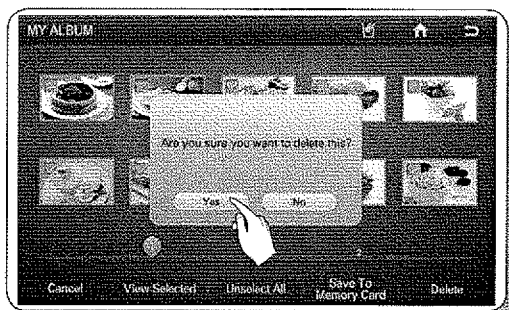

- There are 10 photos that have been pre-loaded by Samsung. These Photos explain product features and cannot be deleted.

EPICURIOS

With the Epicurious service, it is easy to find various recipes by ingredients or events.

- This function is only available when the refrigerator is connected to the wireless network (Wi-Fi).

How to use the Featured Recipes

1. Touch the Epicurious button on the Home screen.
 - There will be a 4-second commercial ad when entering the Epicurious.

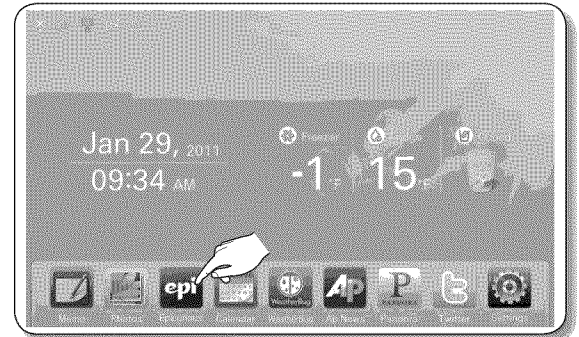

2. Touch the Featured Recipes on the epicurious list.



3. Choose the Featured Recipes category. The display screen will show the recommend food list.

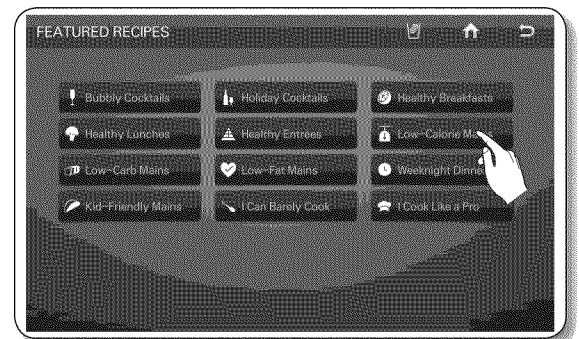

4. Choose the desired food. The display screen will show the detail information.

- The level of popularity is shown with the number of forks.
- **Newest** : Shows in the latest order.
- **Photo** : Shows in order of photo information.
- **Rating** : Shows in order of popularity.
- **A-Z** : Shows in the alphabet order.



- By selecting the Favorite button or the Shopping List button, you can make your favorite list or shopping list.

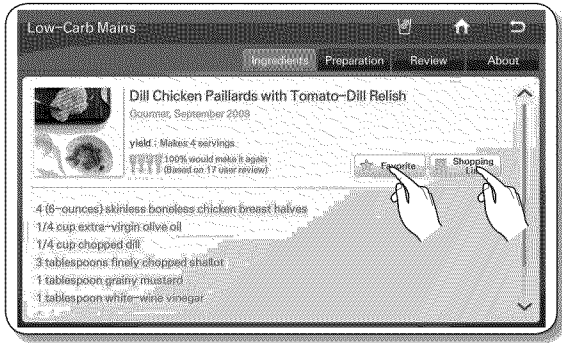

- When the Preparation tab is selected on the top of the page, its step-by-step recipe will show on the main page.

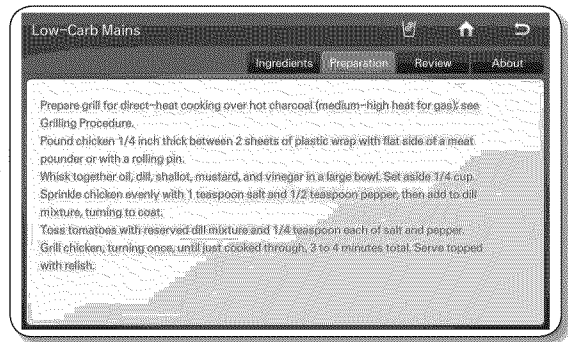
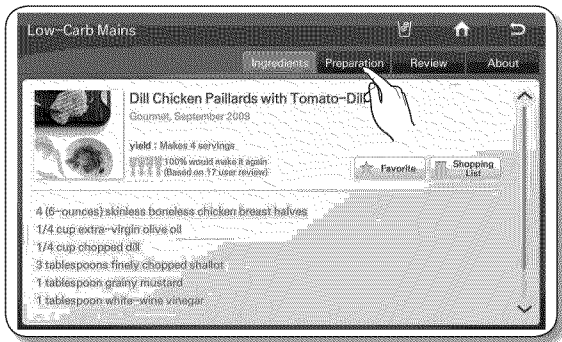

- When the Review tab is selected on the top of the page, you will see its review results that other people made.

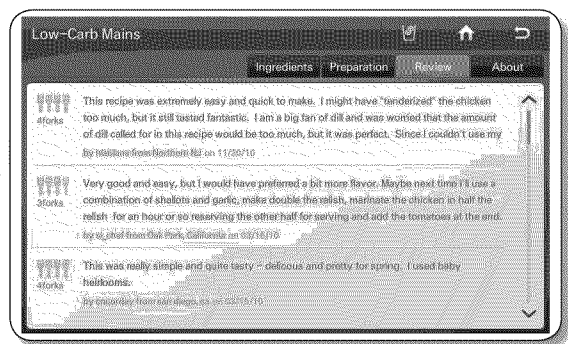
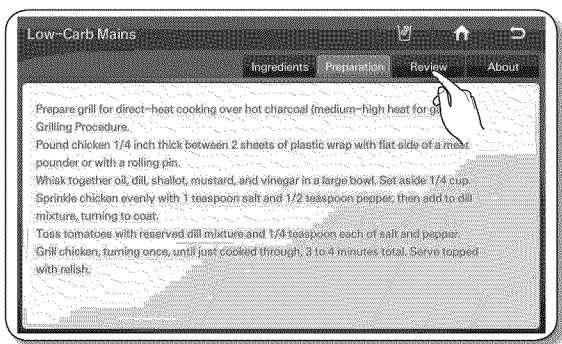

- When the About tab is selected on the top of the page, the author of the recipe will show.

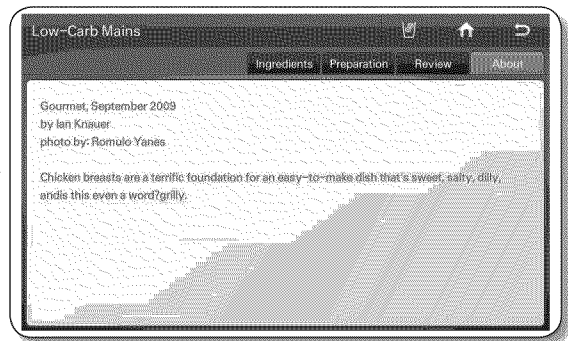
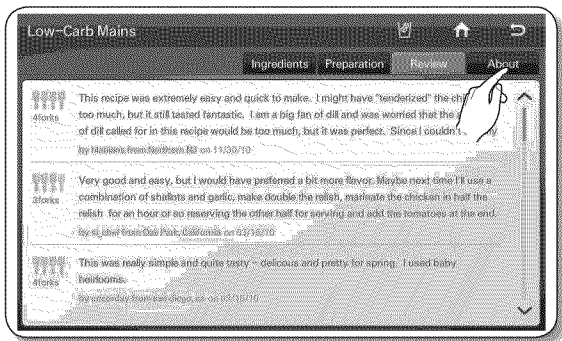

How to use the Recipe Search by Ingredient.

1. Touch the Recipe Search by Ingredient on the epicurious.com list.



2. Choose the Food and Drink button: then choose the Food/Drink type on the left of screen. And choose the ingredient being displayed with icons.
 - When selecting an ingredient being displayed with icons, the expected number of foods will show on the bottom of the page.
 - Multiple ingredient being displayed with icon can be selected.

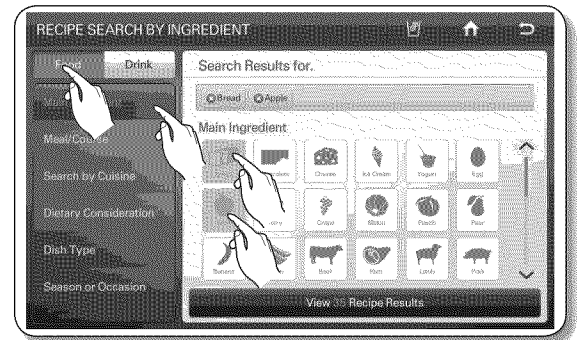

3. Touch the View Recipe Results button.



4. Choose the desired food. The display screen will show the detail information.
5. By selecting the Favorite button or the Shopping List button, you can make your favorite list or shopping list.



How to use the My Favorites.

1. Touch the My Favorites on the epicurious list.
 - Recipe Favorites can be stored up to 100 of them.



2. Choose the desired food.

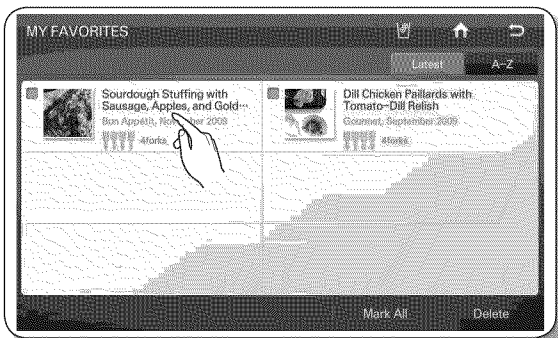

- When selecting the A-Z button, it will show the saved recipes in the alphabetical order.
- With the Delete button, you can delete saved recipes.

How to use the My Shopping List.

1. Touch the My Shopping List on the epicurious list.
 - It is possible to check the food list set as a shopping list and to get food ingredients to purchase.
 - The Recipe Shopping list can be set up to 100.



2. Choose the desired food(s).

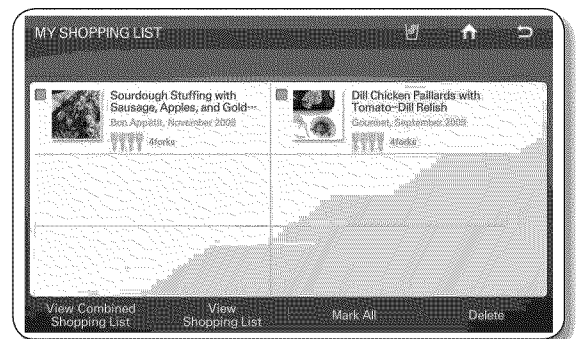

3. Touch the View Combined Shopping List button.



4. The display screen will show the entire ingredient list of selected foods.

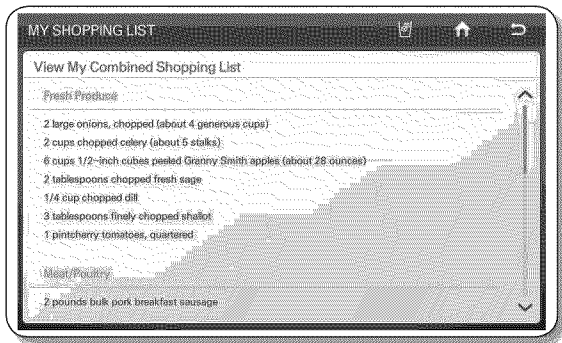

3. Touch the View Shopping List button.

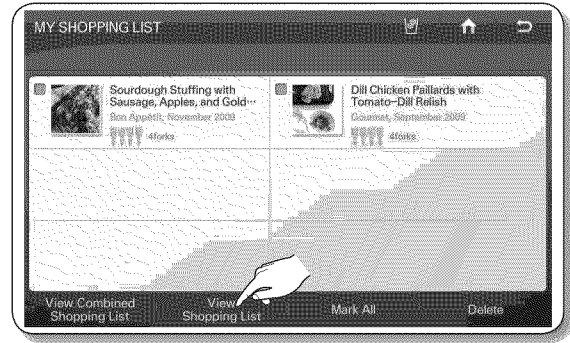

4. Choose the desired food on the left of screen. The display screen will show the ingredient list of selected food.

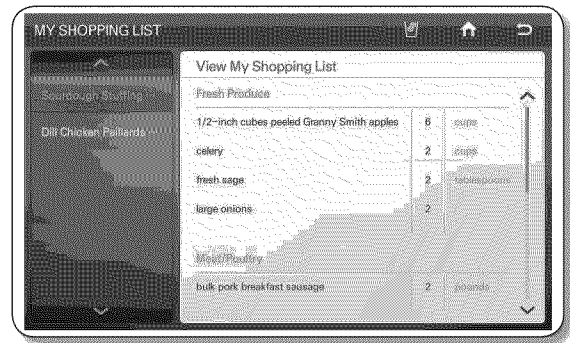

CALENDAR

You can see the calendar from Google Calendar.

- This function is only available when the refrigerator is connected to the wireless network (Wi-Fi).
- To use the Calendar, you need a Google account.
- The Calendar schedule supports from Jan 1970 to Dec 2037.

How to see the Google Calendar.

1. Touch the Calendar button on the Home screen.

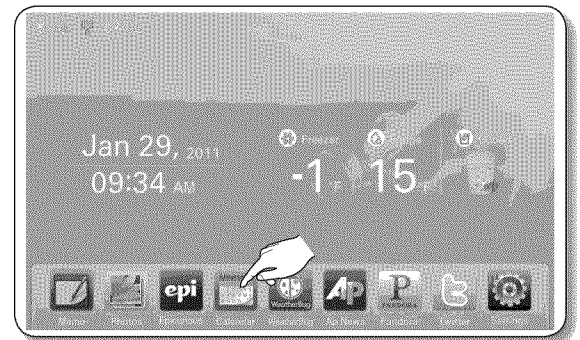

- Choose the Email and Password input box: then enter the Google account ID and password by using the screen keyboard.

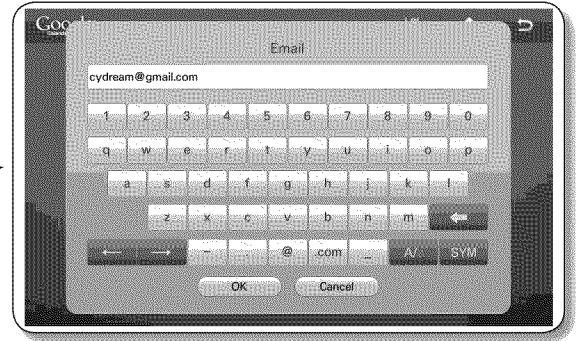
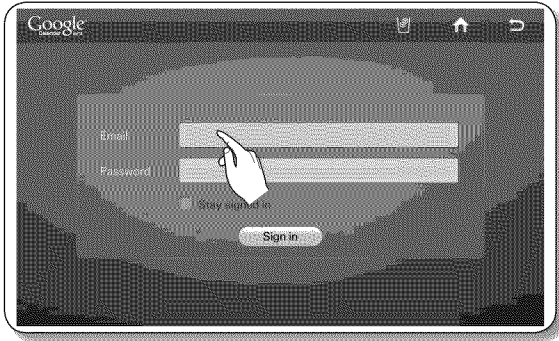

- Touch the Sign in button.
 - When checking on the 'Stay signed in' box, the account will be stored for future log-in.



- When you do not have a Google account, you can get one at <http://calendar.google.com>.
- In the Email section, enter the Google account ID such as UserID@gmail.com.

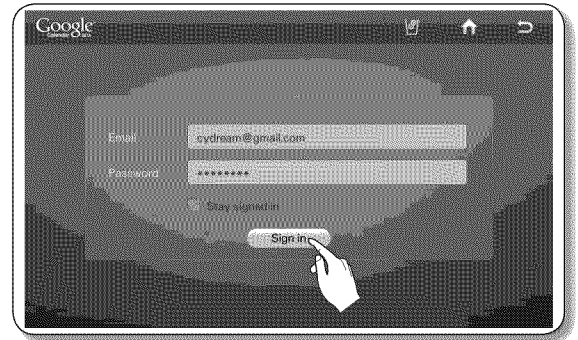

- To check the schedule, select the date to check. The display screen will show the daily schedule of selected day.



- The schedule made in the Google Calendar is not to be modified or erased through the screen.
- Each schedule is to appear in accordance with the display color of the related Calendar.
- The All-Day schedule is to be indicated in the circular button and schedules with a starting time is to be displayed in front of the content in the 24-hour notation.
- Choose the left / right direction arrows to check the Monthly Schedule.
- When there are more than 4 events within a day, it displays the increase by means of "+1 more".
- The schedule is to be updated every 30 minutes.

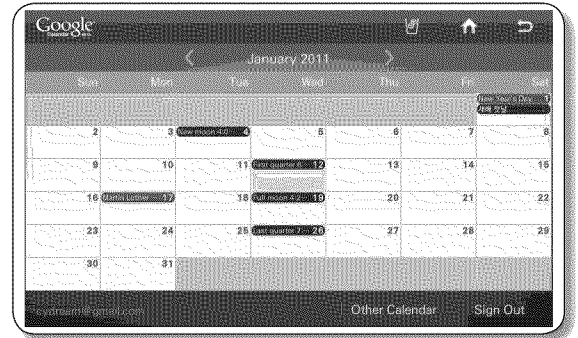

- Choose the schedule you want to check. The selected schedule will appear on the screen.

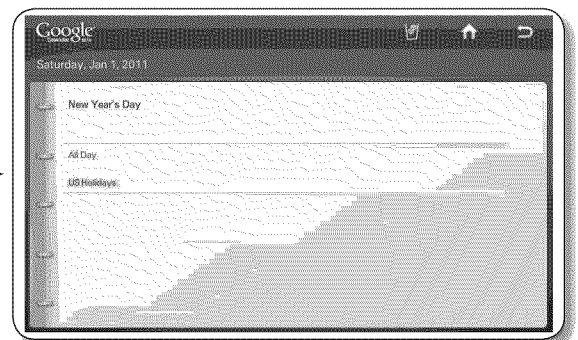
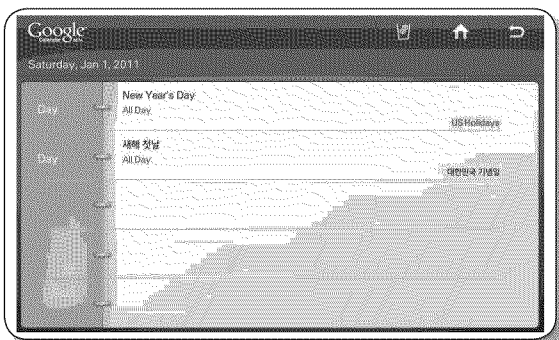

How to manage Shared Calendar

1. Choose the Other Calendar.

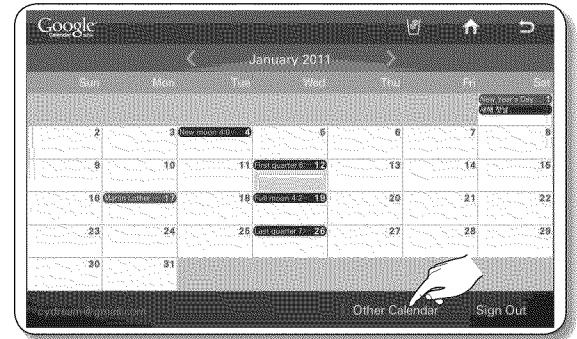

2. Choose the Show and Hide button.

- It is possible to set showing or hiding the schedules of a calendar in subscription on the Other Calendar List screen.
- Even if the Show / Hide setting is changed, there is no change in the subscription list and the Show / Hide setting on the Google Calendar Web.

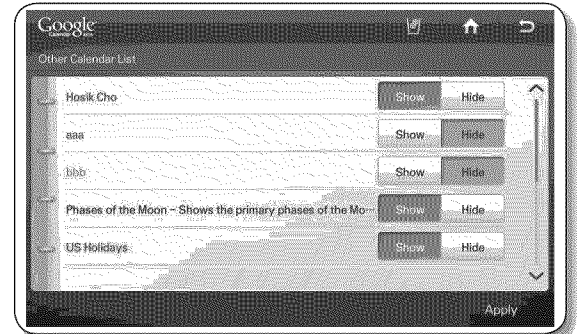

3. Touch the Apply button.

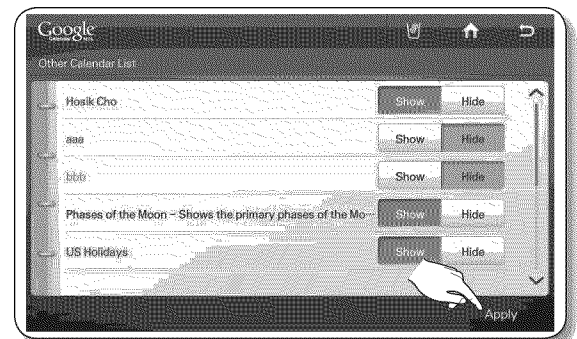

WEATHERBUG

The internet weather service provider will provide the weather information. It provides the current and weekly weather information by regions.



- This function is only available when the refrigerator is connected to the wireless network (Wi-Fi).

How to set Regions for Weather Service

1. Touch the WeatherBug button on the Home screen.
 - There will be a 4-second commercial ad when entering the WeatherBug.

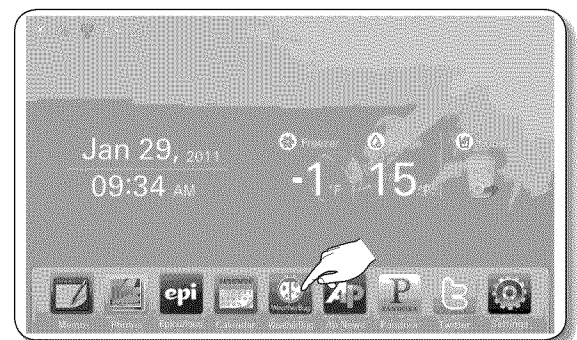

2. Touch the region search bar on the left top of the screen.

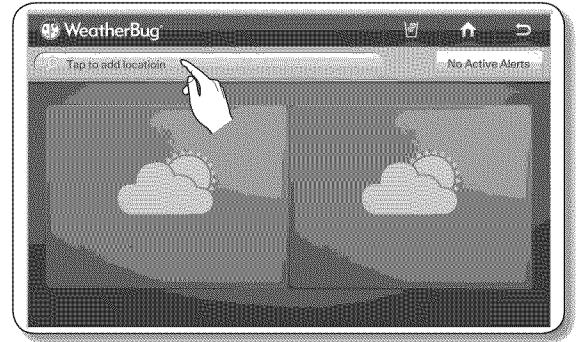

3. Touch the + button on the right upper corner of screen.

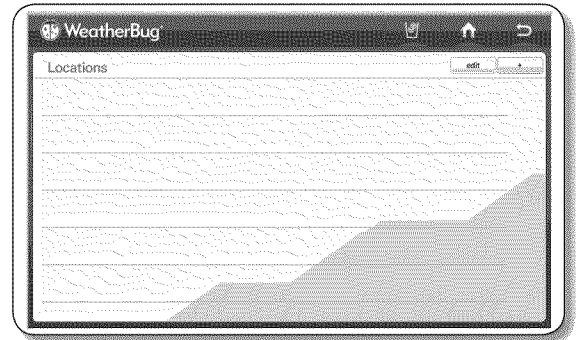

4. Enter the location name or zipcode(US Only) by using the screen keyboard : then thouch the OK button.

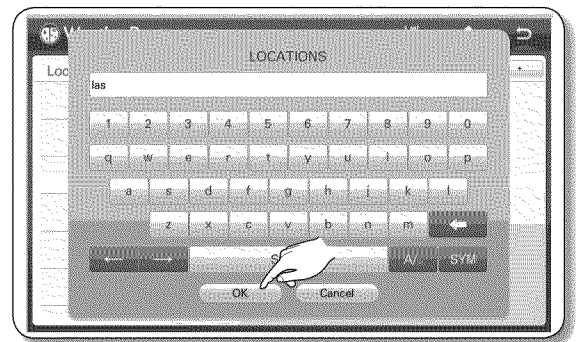

5. Choose the desired location name.

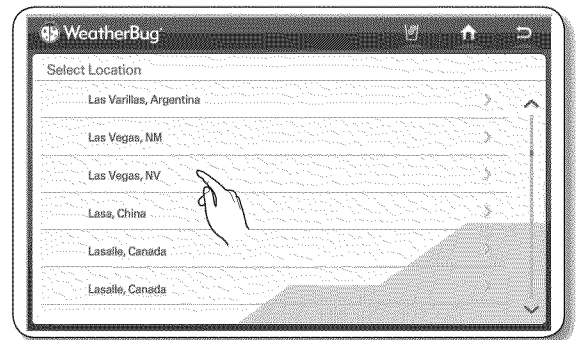

6. Choose the desired station name.

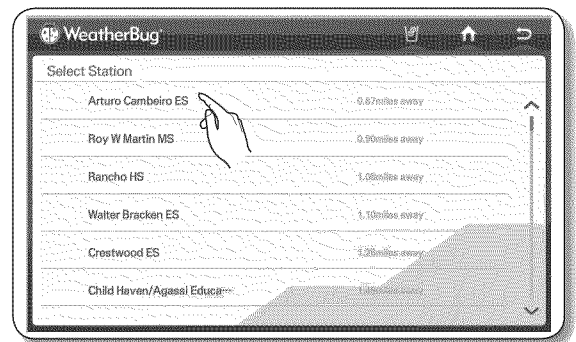

7. Touch the "☰" button on the right top of the screen.

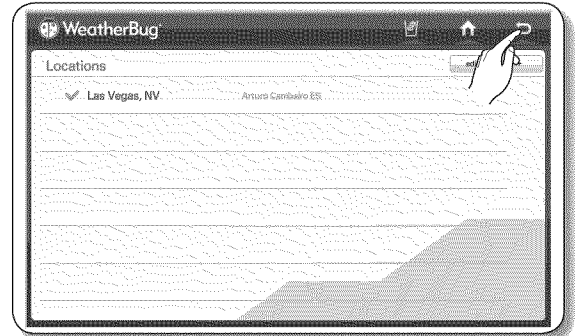

8. The display screen will show the location weather.

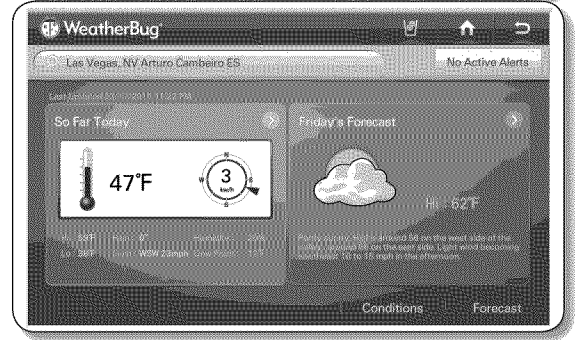

How to see the today weather.

1. Touch the WeatherBug button on the Home screen.

- There will be a 4-second commercial ad when entering the WeatherBug.

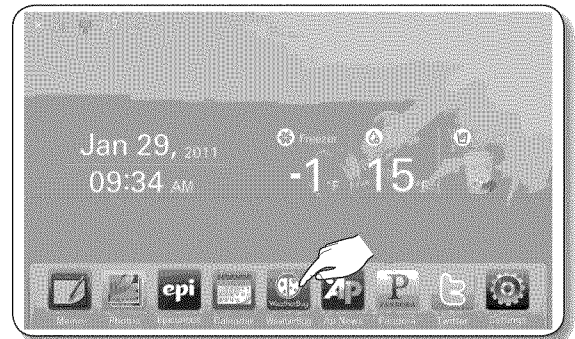

2. When the weather information is provided successfully through the internet, it will show the following screen.

- When selecting the Active Alerts, it will show weather alerts.

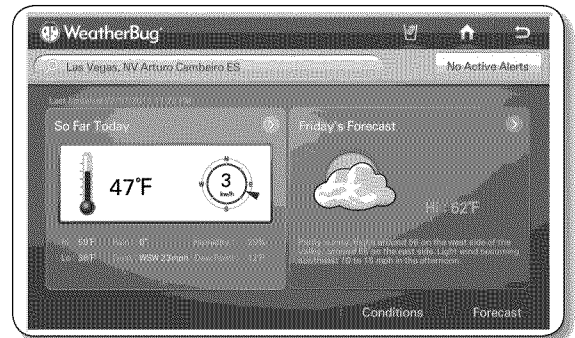

3. Touch the So Far Today. The display screen will show the detail current weather.

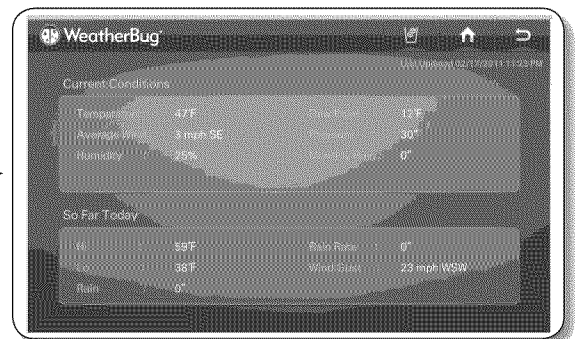
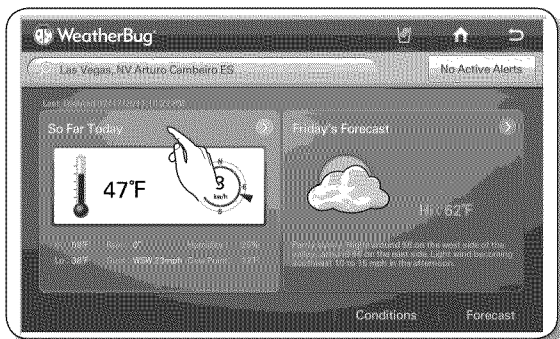

How to add Regions for Weather Service

1. Touch the region search bar on the left top of the screen.

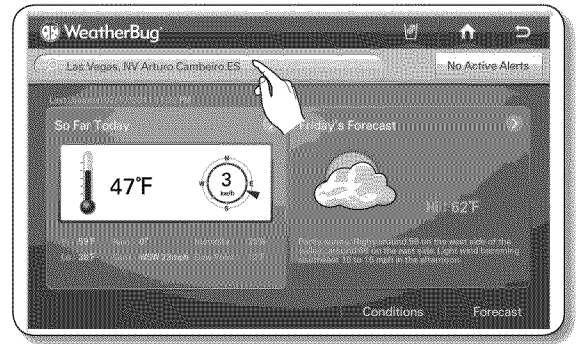

2. The current region information will show on the screen.

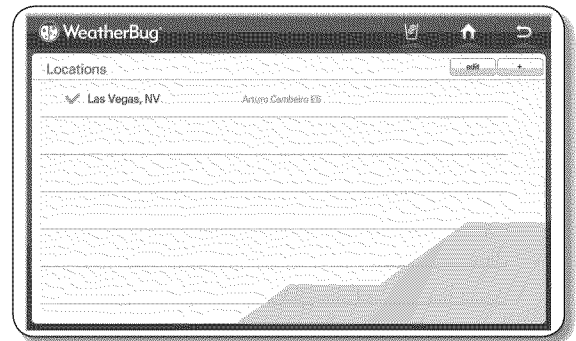

3. Touch the + button on the right upper corner of screen.

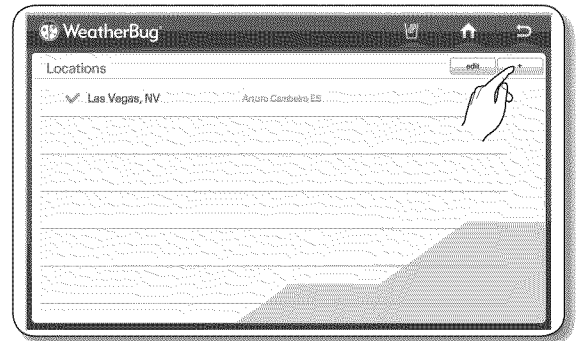

4. Enter the location name or zipcode(US Only) by using the screen keyboard.: then touch the OK button.

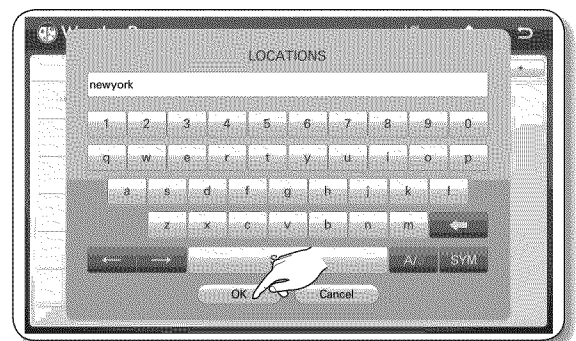

5. Choose the desired location name.

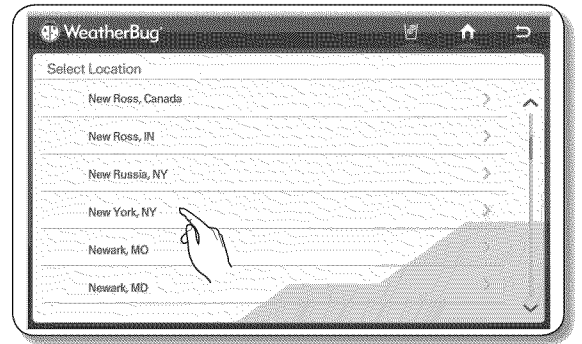

6. Choose the desired station name.

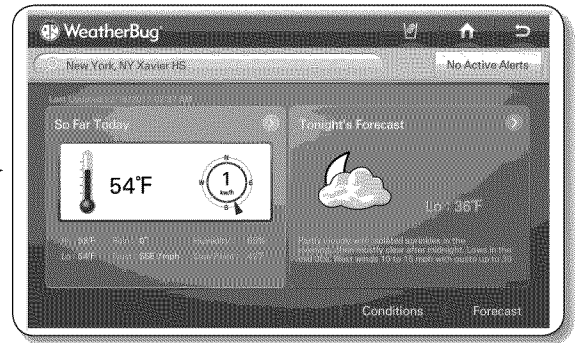
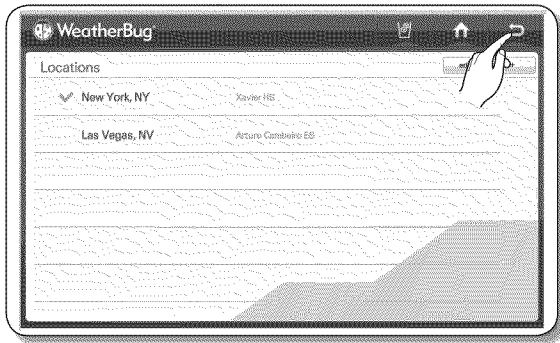

How to Select Regions for Weather Service

1. Touch the desired location name on the location list.

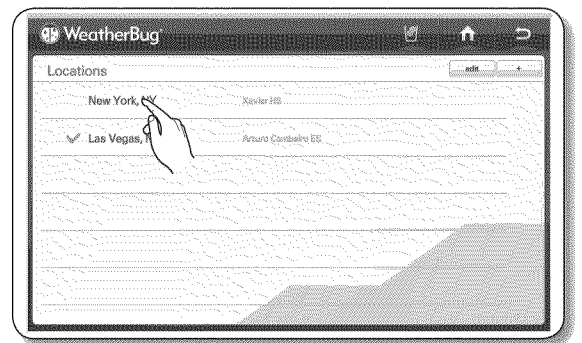

2. Choose the back (⏪) button on the right upper corner. The display screen will show the changed location weather.

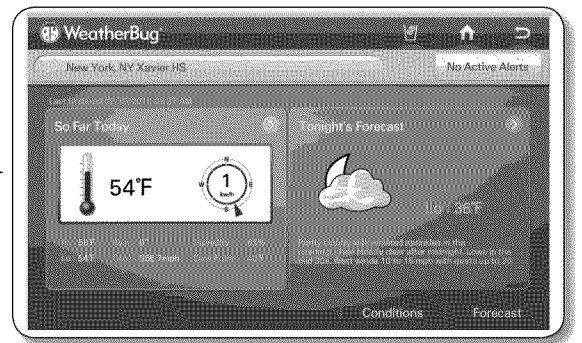
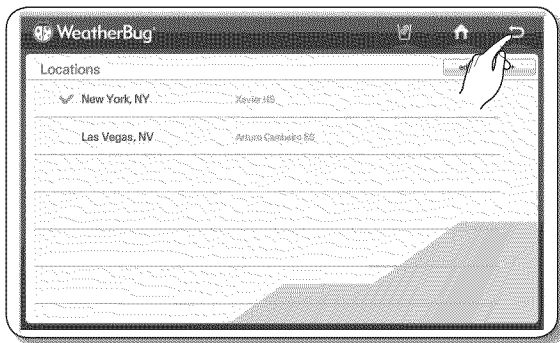

How to delete Regions for Weather Service

1. Touch the edit button on the right upper corner of screen.

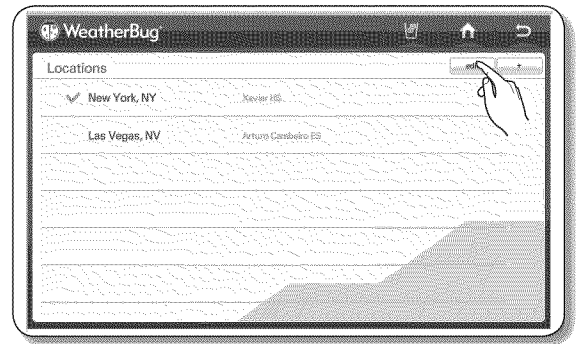

2. Choose the desired check box on the left of the location name: then touch the Delete button.

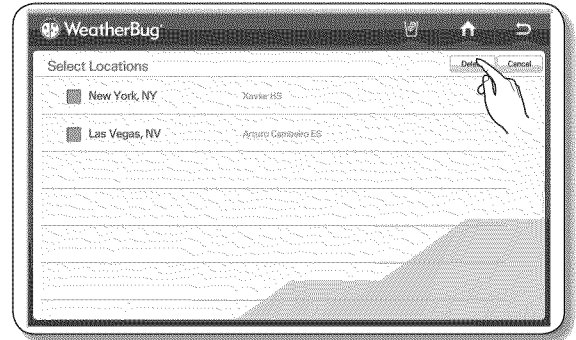

How to see the weather forecast.

1. Touch the Forecast button or Tonight's Forecast.

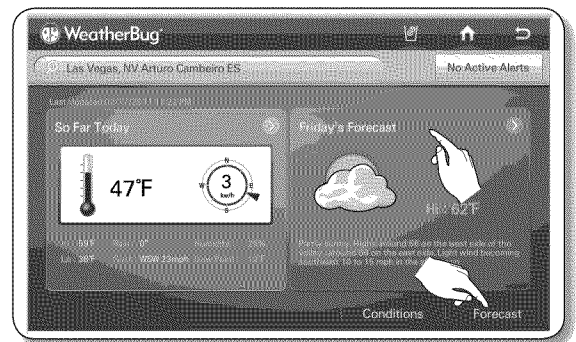

2. Choose the desired forecast on the forecast list. The display screen will show the detail forecast information.

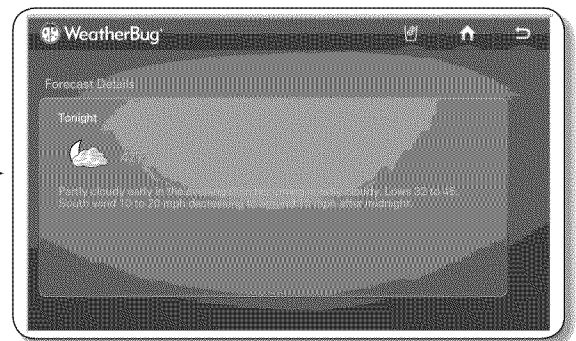
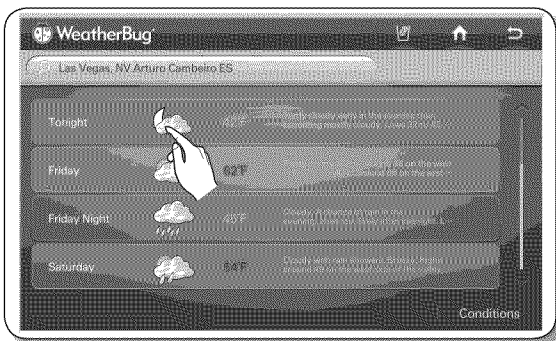

- It is the screen showing the 7-day weather forecast
- It shows the day, the Day / Night(US weather only), the weather condition icon, the temperature and the weather description.
- When selecting the Conditions button, it will move to the screen for the current weather information.

AP NEWS

The internet news service provider will provide the weather information.

- ✎ • This function is only available when the refrigerator is connected to the wireless network (Wi-Fi).

How to see the internet new.

1. Touch the Ap News button on the Home screen.

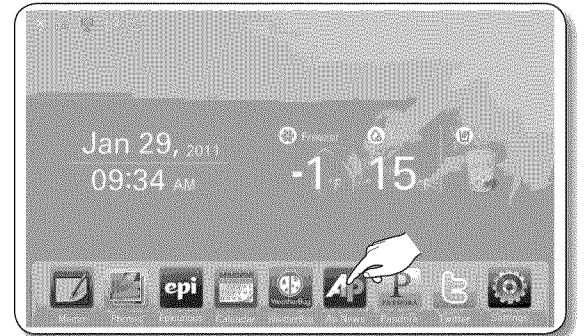

2. Choose the news category.

- When selecting the category on the left, the major news of each category will show.

- ✎ • 11 categories : AP, USAP, WorldAP, SportsAP, BusinessAP, TechnologyAP, EntertainmentAP, PoliticsAP, HealthAP, StrangeAP, ScienceAP



3. Choose the desired article.

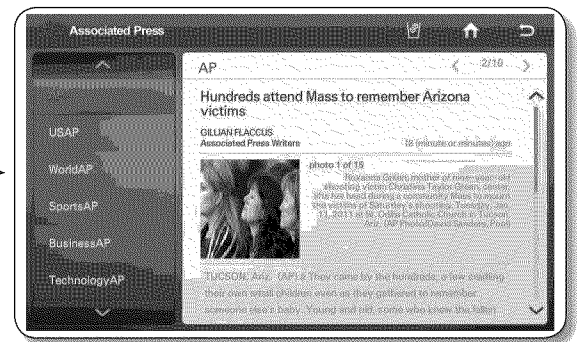
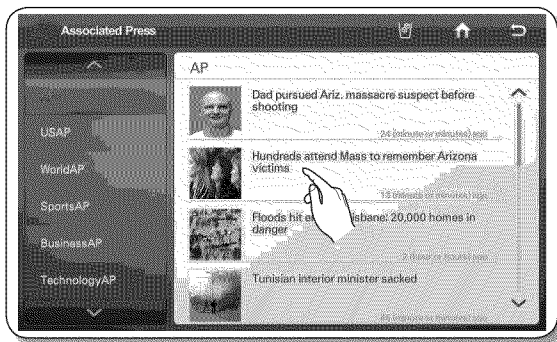

- ✎ • The news article on the preview page shows 2 lines out of the entire article.
To have a look at the detail news, visit the <http://www.ap.org> at your mobile phone or PC.

4. To see all the photos related to the article, select the main photo in the detail news article.

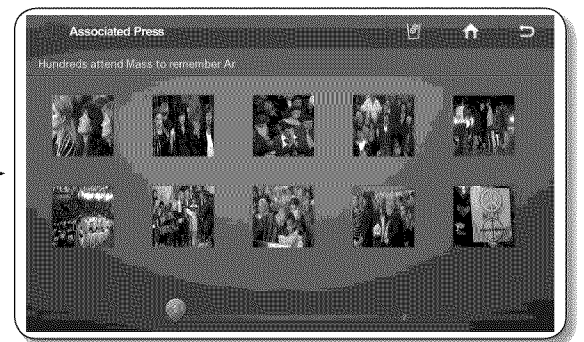

- With the ◀ and ▶ button, you can see other articles.

5. When there is a photo to see its exploded view, select the target photo.

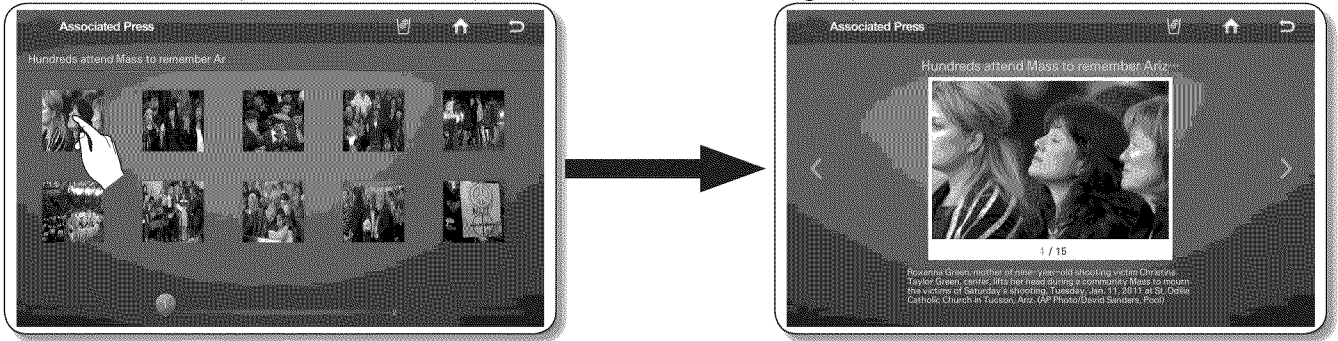

- With the ◀ and ▶ button, you can see other photos.

PANDORA



- This function is only available when the refrigerator is connected to the wireless network (Wi-Fi).
- Through the Pandora service, it is possible to enjoy your favorite songs free of charge.
- The song selection is based on the analysis data being collected by the Music Genome Project of the Pandora and my own selection can affect the next song selection by its feedback.

How to use the internet radio.

1. Touch the Pandora button on the Home screen.

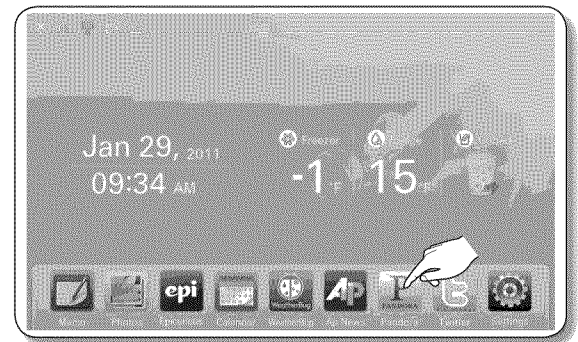

2. Touch the 'I'm new to Pandora' text and register it with the Activation Code being popped-up: then touch the Continue button.

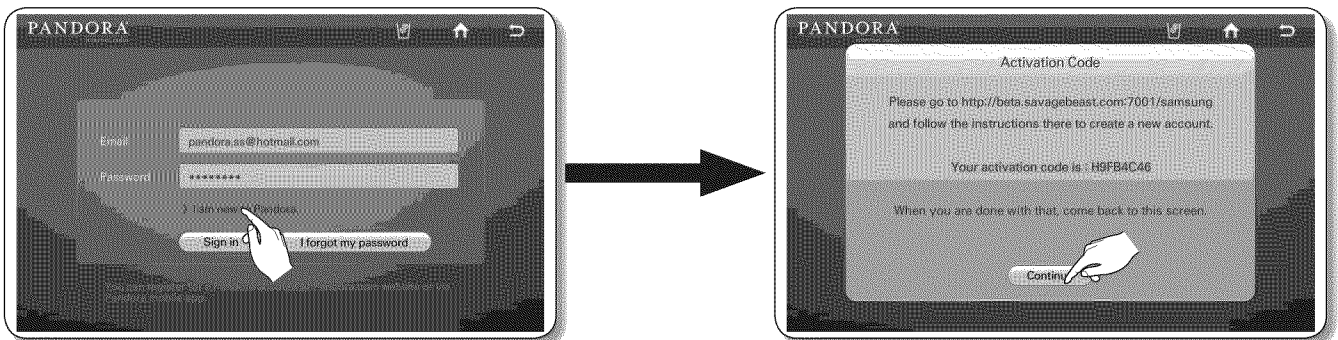

3. Choose the Email and Password input box: then enter the Pandora account ID and password by using the screen keyboard.
 - When you do not have a Pandora account, you can get one at <http://www.pandora.com>.
 - In the Email section, enter the Pandora account ID such as UserID@gmail.com.

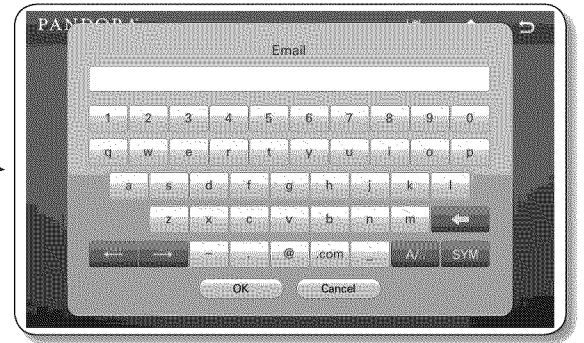
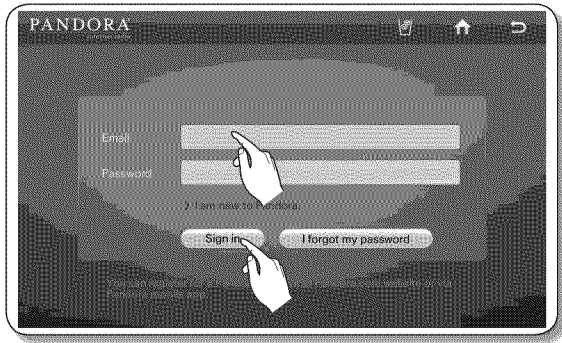

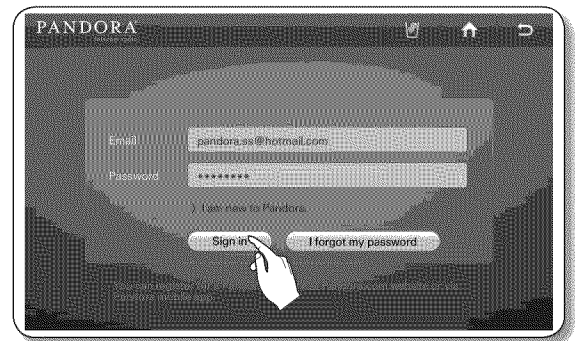

4. Touch the Sign in button.

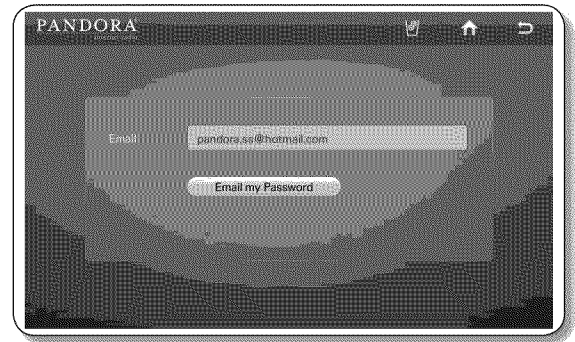

- 
 • When you forgot the password, press the I forgot my password button to get an email for your password setting to the email address registered.



5. Choose the desired station.

- 
 • It supports 100 of stations in maximum.
- 
 • Stations can be created at www.pandora.com or through mobile devices supporting the Pandora.
- 
 • If other stations are selected, it is possible to play the selected songs in those stations.

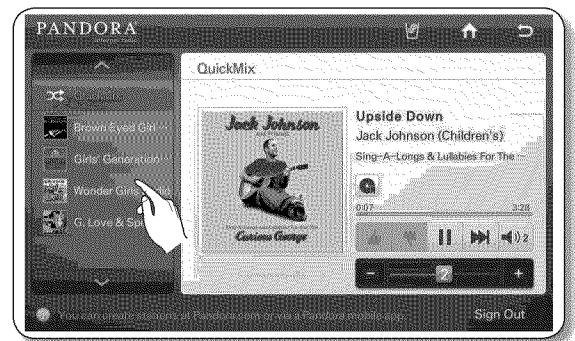

- When the Bookmark button (🔖) is touched while playing a song, it is to be added to the Song Bookmark List and its list can be viewed at the Pandora site.



- By bookmarking my favorite songs, it is possible to check the song list and to purchase various albums on the [Your Profile] page at www.pandora.com.



- When the song running fits your style, select the Thumb Up (👍) button.

Otherwise, select the Thumb Down (👎) button.



- When the Thumb Up button is selected, a play station will be formed with songs similar to the song selected.



- To put the current playing song on hold, press the hold (⏸) button.



- To play the next song, press the Next (⏭) button

- Unfortunately, our music licenses force us to limit the amount of songs you can skip in an hour.



- Touch the speaker (🔊) button, you can adjust its volume.



TWITTER

- ✍ This function is only available when the refrigerator is connected to the wireless network (Wi-Fi).
- ✍ You can't write a tweet while working on this function.

How to show the twitter.

1. Touch the Twitter button on the Home screen.

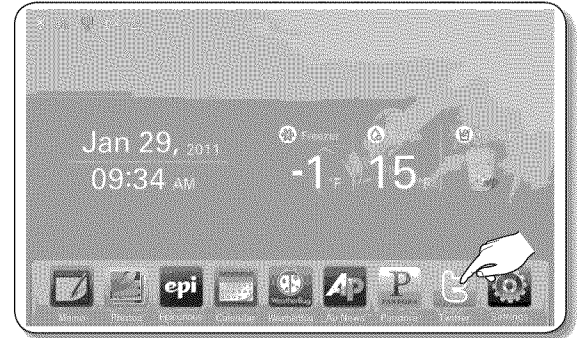

2. Choose the Email and Password input box: then enter the Twitter account ID and password by using the screen keyboard.

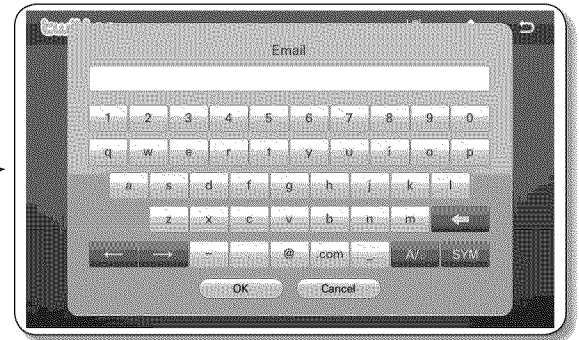
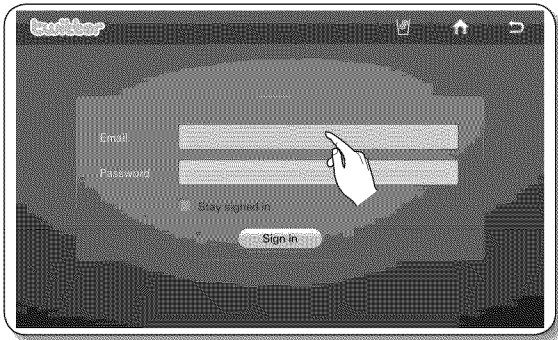

3. Touch the Sign in button.

- ✍ When you do not have a twitter account, you can get one at <http://twitter.com>.
- ✍ In the Email section, enter the Twitter account ID such as UserID@gmail.com.
- ✍ When the 'Stay signed in' check box is selected, it is not necessary to log in each time to enter into the Twitter menu.
- ✍ When the system time is not set exactly, the login may fail. After setting the current time correctly at the Settings → Time/Date, do a retry.

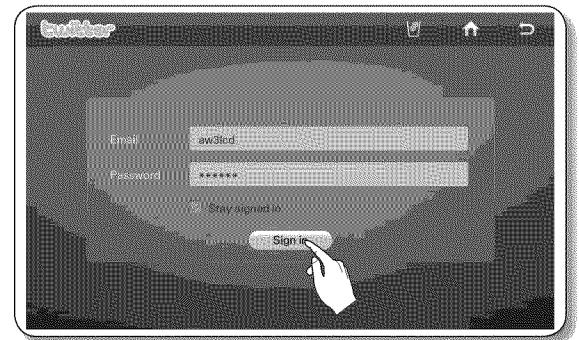

4. It is the screen showing the twitter list. In this page, user's following twitters up-to-date information including their photos, comment previews and listed dates.



5. Touch the twit on the twit list, you can see the detail information.
 - When selecting the List View on the Detail View screen, the screen changes to the Twit List.

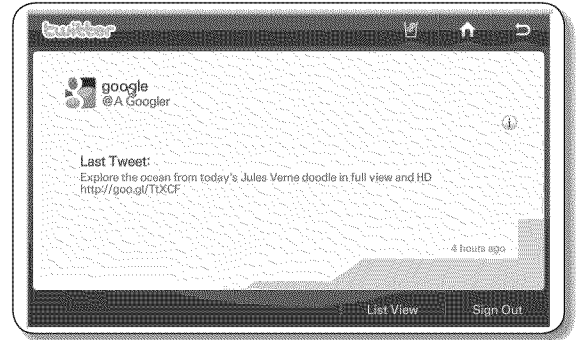

6. Touch the button, it will show the detail information of the follower/followee.

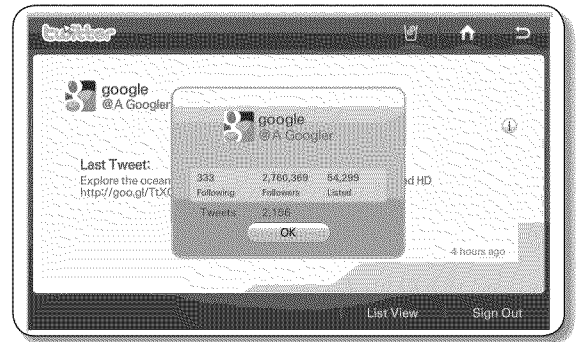

SCREENSAVER THEME

When there is no input for a time being, the selected items work as the Screensaver.

1. Touch the Settings button.
2. Touch the Screensaver Theme on the settings list.

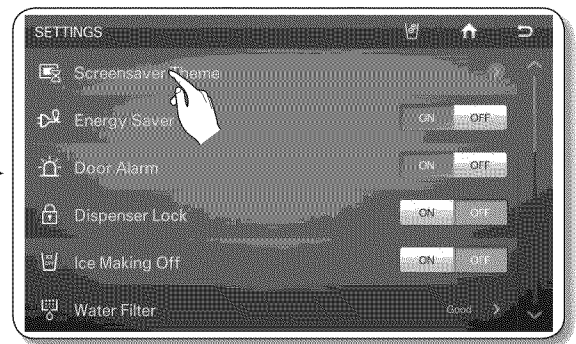
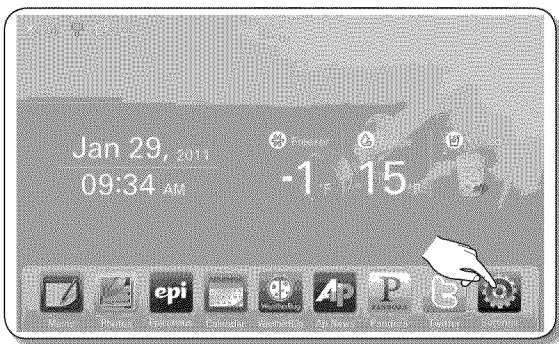

3. Choose item(s) to be used in the screensaver; then touch the Save button.



- The Clock and the Photos are default items, and they can not be unselected.
- It is possible that the set items does not show until their data is not ready.

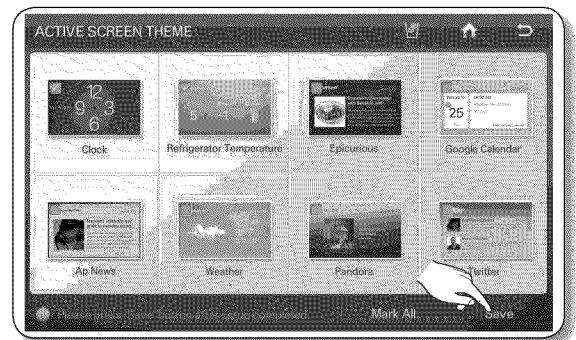

ENERGY SAVER

It turns on and off the Energy Saver function. When the Energy Saver is on, the power consumption decreases.

1. Select the Energy Saver ON or OFF buttons on the settings list.
 - The Energy Saver function is pre-set to ON in the factory.
 - If condensation or water drops appear on the doors, turn the Energy Saver mode off.



DOOR ALARM

It turns on and off the Door Alarm

1. Select the Door Alarm ON or OFF buttons on the settings list.
 - If the door alarm is set to ON, an alarm beeps if any door is left open for more than two minutes.
 - The beeping stops when you close the door. The door alarm function is pre-set to ON in the factory.

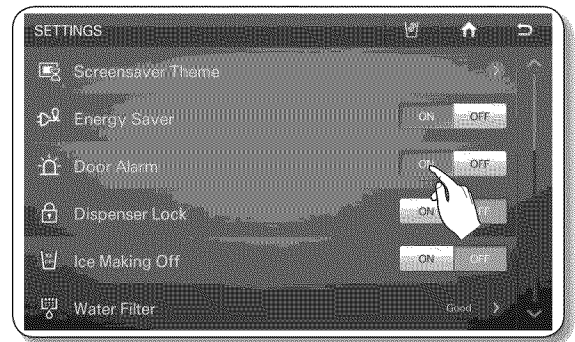

DISPENSER LOCK

When the Dispenser Lock function is activated, the dispenser will not work.

1. Select the Dispenser Lock ON or OFF buttons on the settings list.
 - If you select the Dispenser Lock ON button, Lock icon () will be show on the left upper corner of the Home screen.
 - When the Dispenser Lock is set, only the dispenser do not work.
- If you suddenly can not use the dispenser, check whether the Dispenser Lock function is on.



ICE MAKING OFF

1. Select the Ice Making Off ON or OFF buttons on the settings list
 - When the Ice Off is set, the Ice Off indicator icon () appears on the left top of the Home screen.



- We recommend you stop ice making if the following occur:
 - There is enough ice in the ice bucket.
 - You want to save water and energy.
 - Water is not being supplied to the refrigerator.
- If the ice maker function is ON, and the water line is not connected, there will be a water valve noise from back of the unit. Touch the Ice making Off ON button on the settings list.

WATER FILTER

The Water Filter status icon on the Home screen enables you to check the current status of the water filter. Use the following instructions to check and/or replace the water filter.

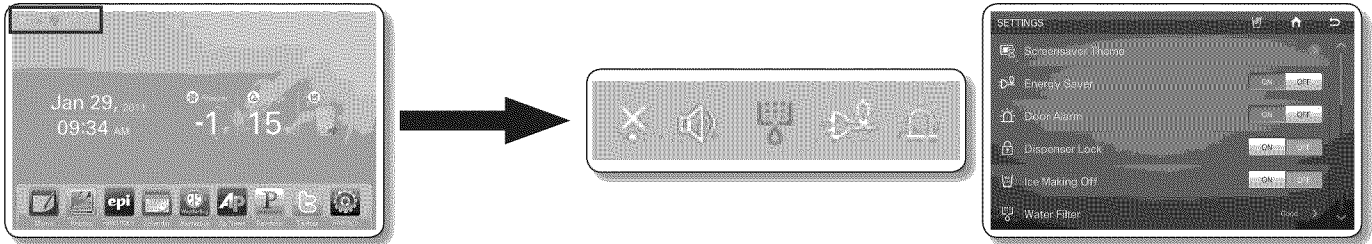

1. Check the water filter status on the settings list or indicator icons on the Home screen.

- Good(Blue) : The filter does not need replacement. It is normal.
- Order(Pink) : The filter needs replacement.
- Replace(Red) : The filter needs replacement immediately.

2. If the status reads “Order” or “Replace,” touch the water filter on the settings list to access the replacement instructions.

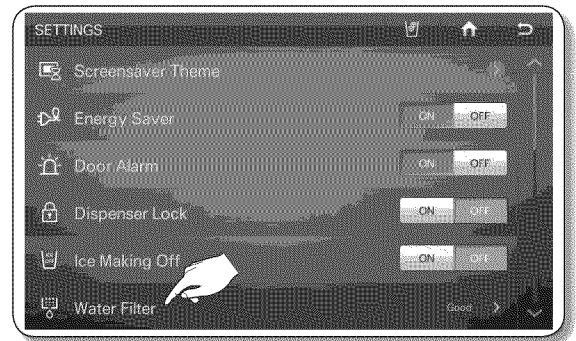

3. Touching the Next button will continue the instructions.

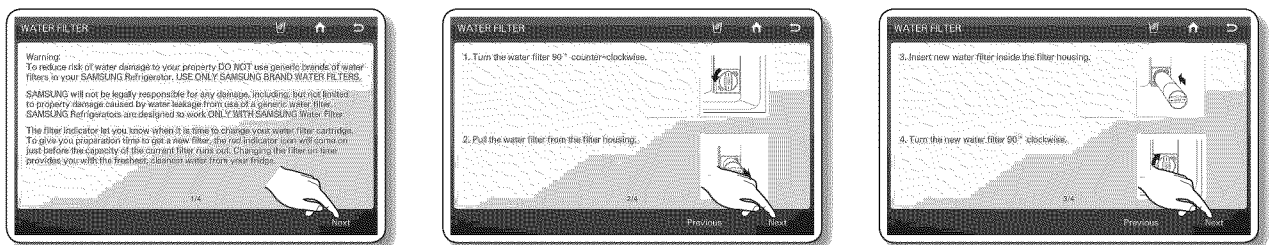

- Refer to the Water Filter replacement guide and replace the Water Filter.

- When the replacement is done, touch and hold the 'Reset the water filter' simultaneously for 3 or more seconds at the center of the screen.

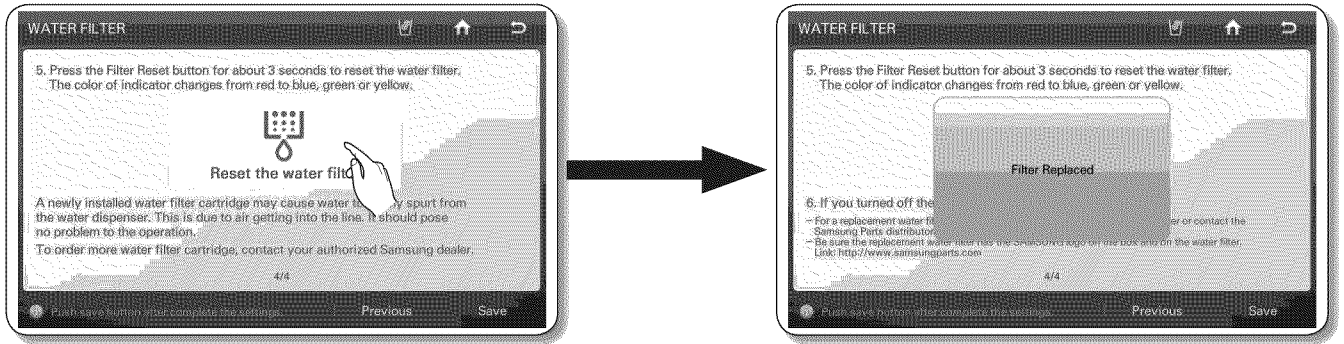

DO NOT use the water or ice dispenser without a water filter cartridge because the water line may become blocked or damage the dispenser.



- Be sure to flush the dispenser thoroughly to avoid possible water dripping from the dispenser. This means that there is still air in the line.
- For a replacement water filter, you can visit your local home improvement center or contact the Samsung Parts distributor. Be sure the replacement water filter has the SAMSUNG logo on the box and on the water filter. **Link : <http://www.samsungparts.com>**

DISPLAY

You can set the brightness of the LCD and running time of the Screensaver.

- Touch the  button in the right bottom corner of the settings list.
- Touch the Display on the settings list.

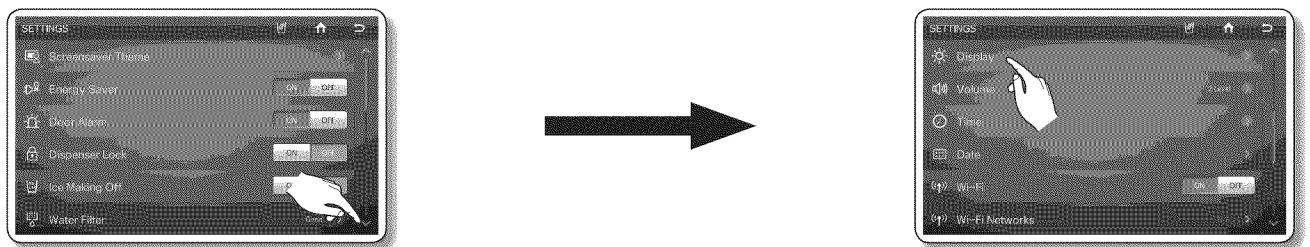

- Choose the desired Brightness level, Screensaver Running Time: then touch the Save button.



- After 60 seconds, the Screen Saver runs for the time you set, then the LCD panel turns off.

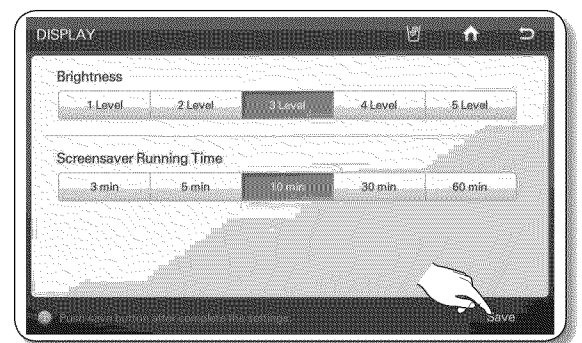

VOLUME

You can control the volume of the alert sounds.

1. Touch the  button in the right bottom corner of the settings list.
2. Touch the Volume on the settings list.

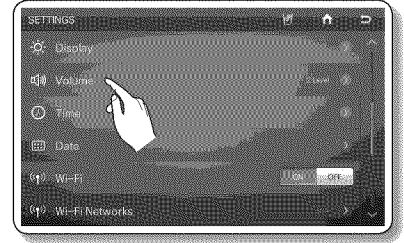
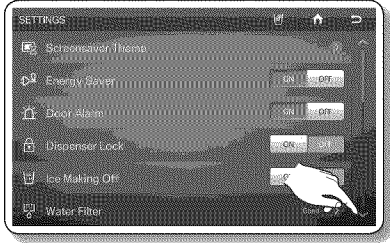

3. Select the volume sound level button to adjust the alert sound level.
4. Touch the Save button to set the new volume level.



- An alert sounds whenever a button is touched or a message window or menu list appears.

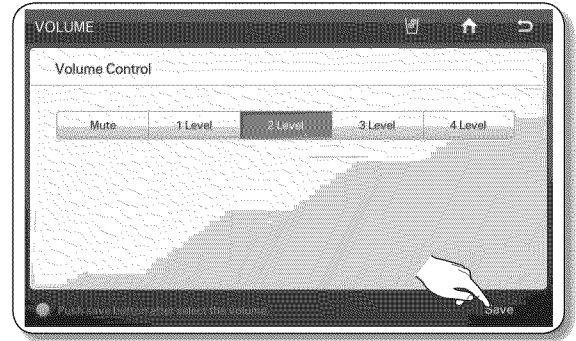



TIME SETTING

You can set the current time.

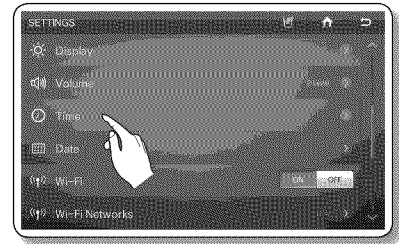
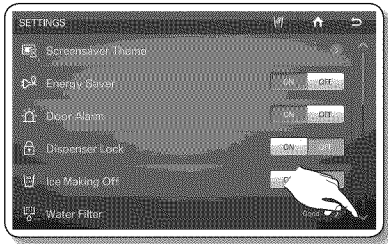
1. Touch the  button in the right bottom corner of the settings list.
2. Touch the Time on the settings list.



3. Use the  and  buttons to revise the time settings. :
 - If the current time is incorrect, you may not use the twitter.

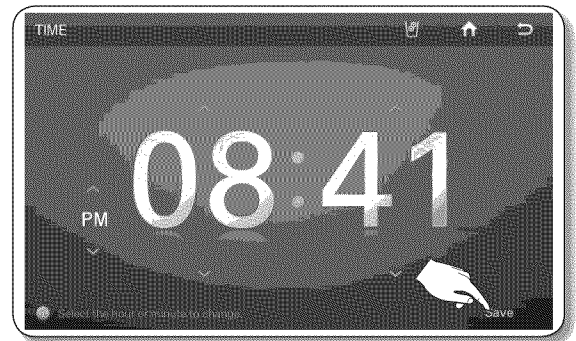



DATE SETTING

You can set the current date.

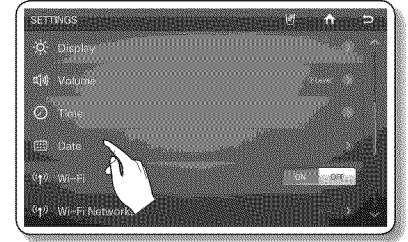
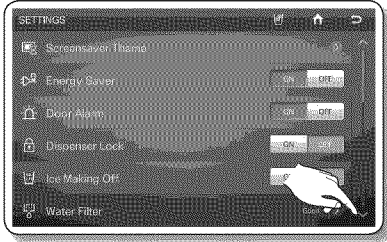
1. Touch the  button in the right bottom corner of the settings list.
2. Touch the Date on the settings list.



3. Use the  and  buttons to revise the month.
 4. Select the desired day: then touch the Save button.
- If the current date is incorrect, you may not use the twitter.

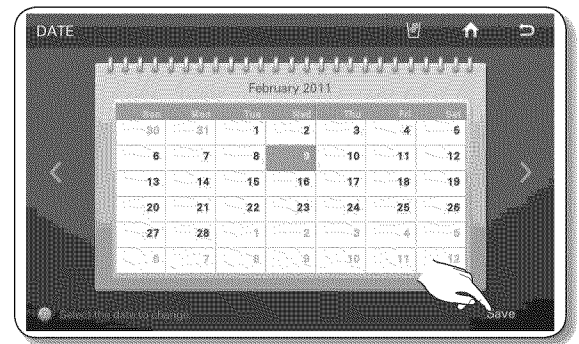

WI-FI ON OR OFF

It is to set turning on and off the wireless network.

1. Touch the  button in the right bottom corner of the settings list.
2. Select the Wi-Fi ON or OFF buttons on the settings list.

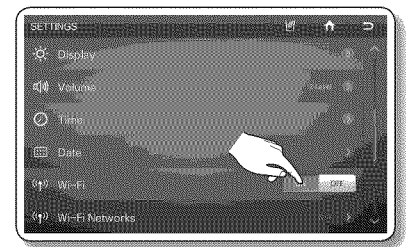
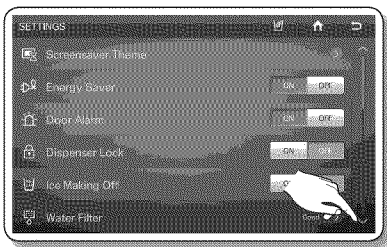

WI-FI NETWORKS



At the above Wi-Fi menu, when the wireless network turns on, it will search an wireless AP to do the network connection.

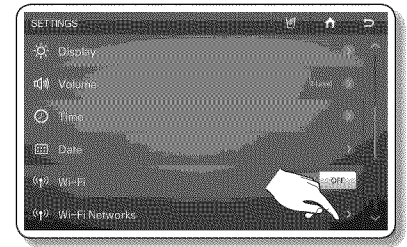
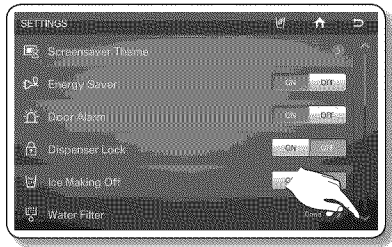

- Other than the router installed at your home, other routers installed at your neighbors or nearby offices can be detected while connecting to the wireless network. It is illegal to use other's router without permission and it will be subject to legal responsibilities. So, make a connection to the wireless router being permitted.

1. Touch the  button in the right bottom corner of the settings list.
2. Touch the Wi-Fi Networks on the settings list.



3. Choose the wireless AP you want to connect.
 -  : Locked with Security Code
 -  : Signal Strength
 - You can check the MAC address of the Fridge on the bottom of the Screen.



- Touch the Search button, When there is no AP showing on the screen, select the Search menu at the bottom.
- Based on the wireless AP type, it may not make a connection. (It is recommended to use a wireless AP supporting IEEE 802.11 b/g.)
- For the wireless router, please contact your internet provider or do the installation by yourself.
- When you can't remember the name of the wireless network system (SSID) or its security code, please refer to its user manual.
- All the wireless network systems can be interfered by radio frequency signals and they may affect the product performances.
- The radio frequency signals of the wireless network system can be affected by the radio frequency interference from other devices or any other obstacles. (concrete wall, metallic door or radio frequency signal emitting devices such as microwaves)
- Depending on the type & location of the wireless network system or the surrounding environments, the radio frequency reaching distance may differ and its quality may get affected.

4. When there is a security code set for the wireless network system, enter the security code and select the OK button.

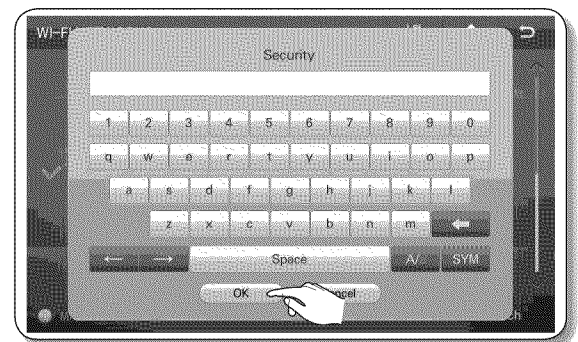

- When the IP Address button is selected after succeeding in the AP connection, it is possible to check the currently set IP address and the Gateway.

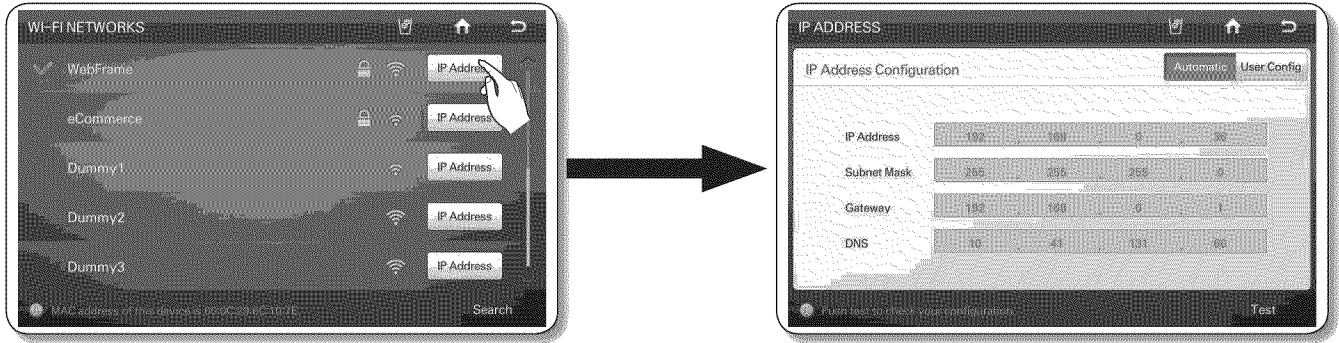

- When selecting the User Config button, the IP Address, Subnet Mask, Gateway and DNS buttons will be activated to be able to be selected for data input.

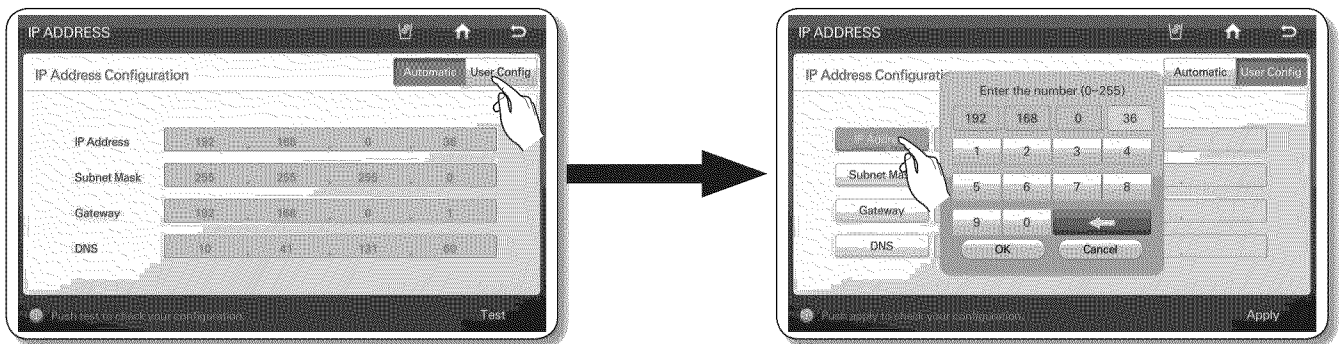

- After filling in all the above 4 items, select the Apply button.

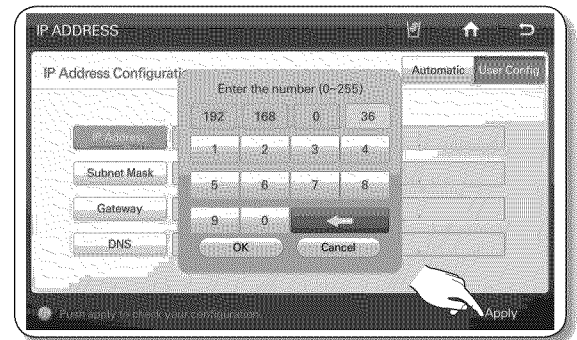

TEMPERATURE UNIT CONVERTER

It is to select the unit of the display temperature. The selected unit applies to the Freezer / Fridge set temperature and the temperature showing in the Weather.

- Touch the  button two times in the right bottom corner of the settings list.
- Select the Temperature Unit Converter °C or °F buttons on the settings list.

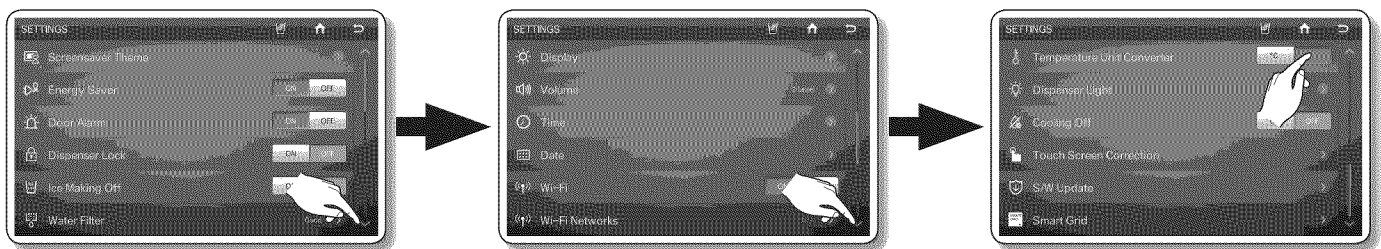

DISPENSER LIGHT

It is to set the operation of the dispenser lamp light.

1. Touch the  button two times in the right bottom corner of the settings list.
2. Touch the Dispenser Light on the settings list.

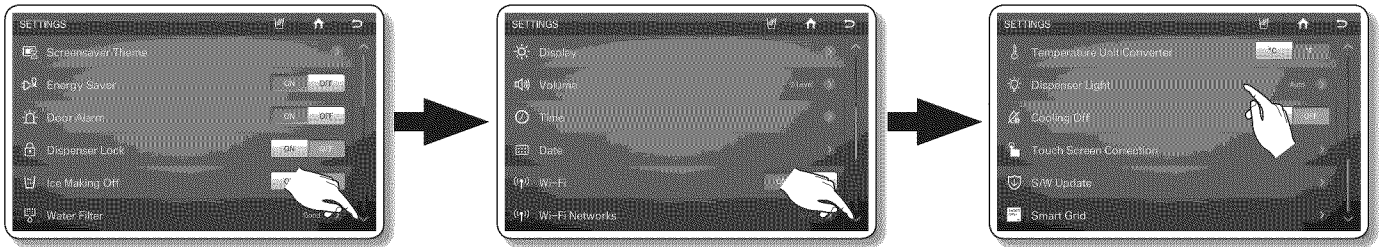

3. Select the desired dispenser light status: then touch the Save button.
 - On : Dispenser lamp always on.
 - Auto : Dispenser lamp lights up when using the dispenser. And, when the dispenser lever is released, the light goes off in 5 seconds.
 - Off : Dispenser lamp does not light up when using the dispenser.

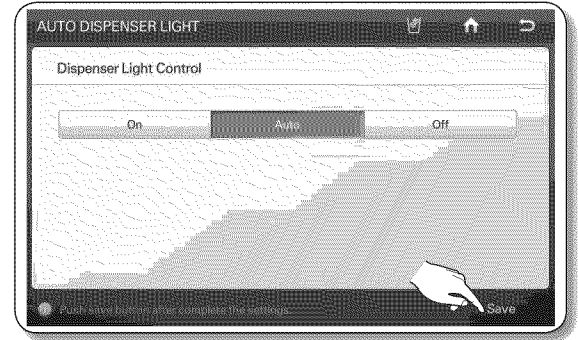

COOLING OFF

The cooling off function shuts off the cooling to the freezer and fridge compartments, but does not shut off the electrical power to the refrigerator. This is only used to demo refrigerator models on showroom floors.

1. Touch the  button two times in the right bottom corner of the settings list.

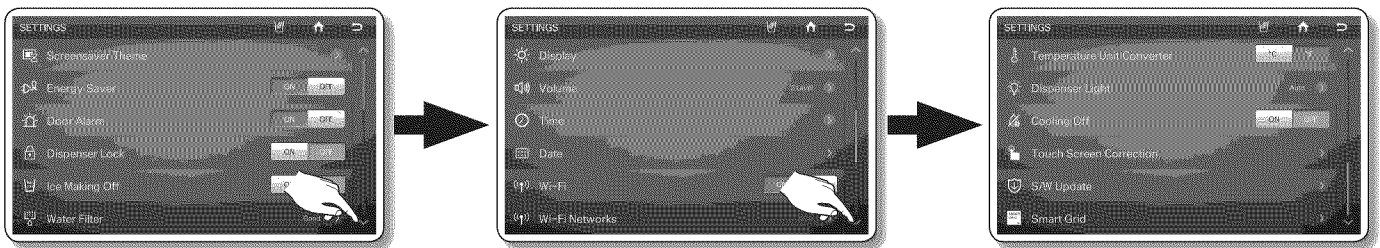

2. Select the Cooling Off ON or OFF buttons on the settings list.
 - If you choose the Cooling Off ON, the Home screen will show "OFF" on the freezer/fridge temperature and the refrigerator compressor functions will be deactivated. (The refrigerator and freezer do not get cold.)
3. If you choose the ON button, The following message window will be displayed to confirm.
4. Press the Yes button for more than 3 seconds.

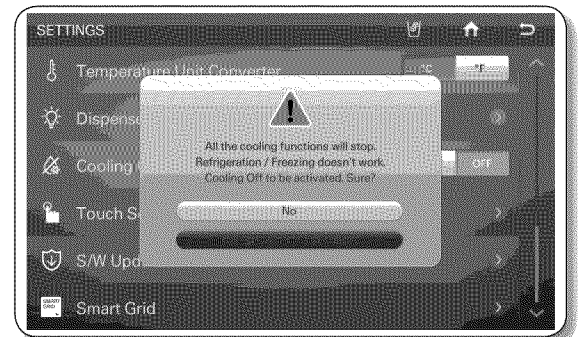
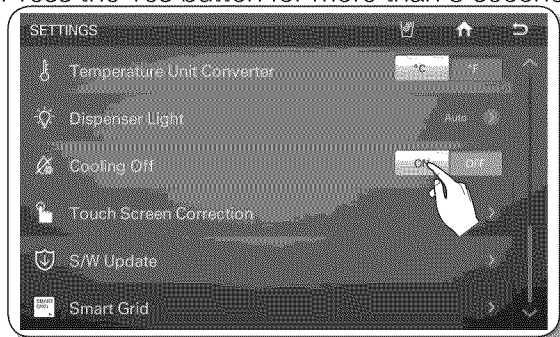

TOUCH SCREEN CORRECTION

The stylus touch point can be calibrated to best meet the user's needs. To adjust the stylus touch point on the touch screen:

1. Touch the  button two times in the right bottom corner of the settings list.
2. Touch the Touch Screen Correction on the settings list.

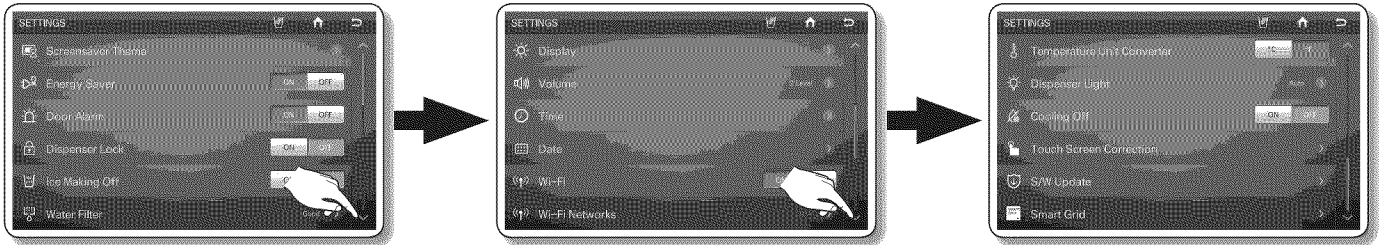

3. Touch the Yes button, and then a screen will appear with pointer instructions on the top.
4. Press down lightly on the center of the "+" mark. Repeat as the "+" mark moves on the screen.

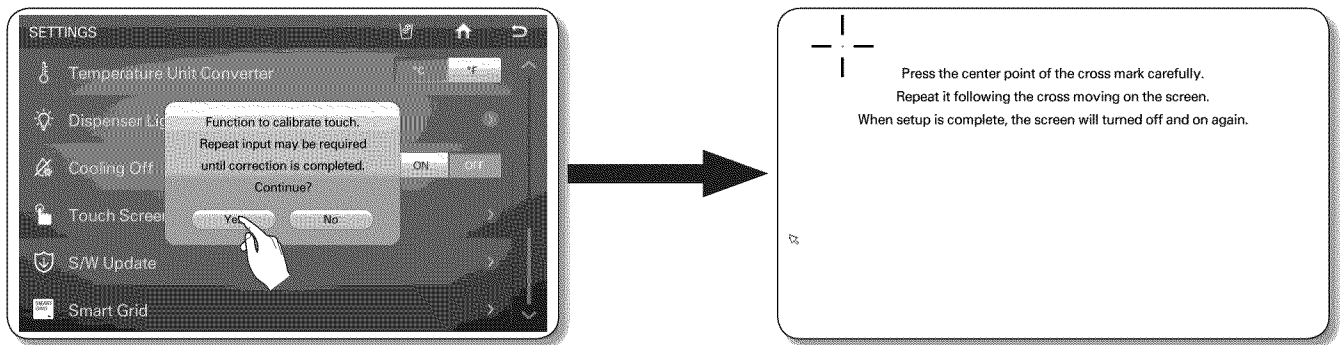

-  • If the center is not properly pointed, the cross mark appears repeatedly.

S/W UPDATE

It is the menu to check the current software version and to update it to the new software.

1. Touch the  button two times in the right bottom corner of the settings list.
2. Touch the S/W Update on the settings list.

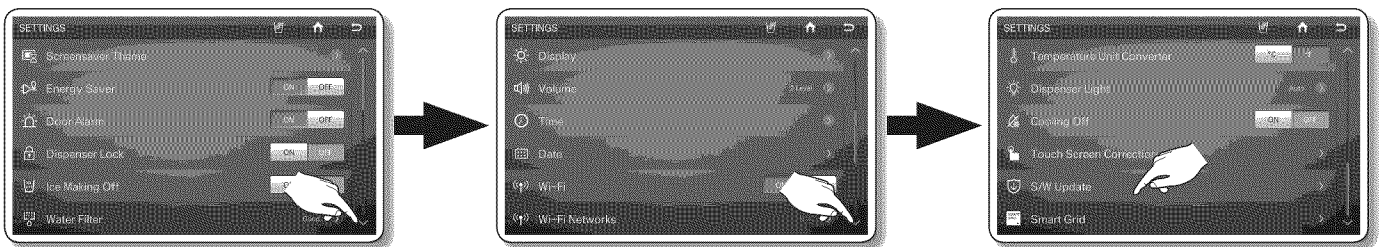

- The software update is offered as through the wireless network. When the updated software is offered through the wireless network, the Upgrade button is activated on the right bottom corner of the screen. And, when selecting the Upgrade button, it starts updating right away (it takes about 10 seconds). When the update is completed, it needs rebooting the system.
- Open Source License Notice - This product uses open source software. In the case of using open source software, Open Source Licenses are available on the product menu. Press [Legal Information] button to see the detail information.

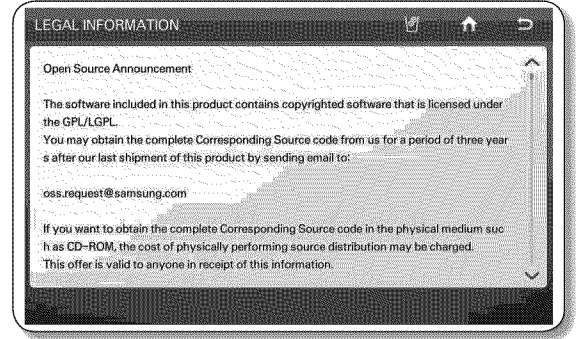
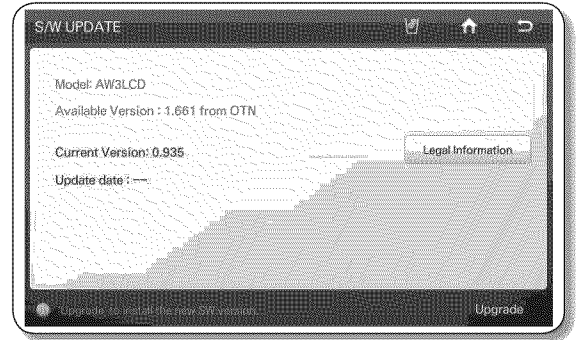

SMART GRID

Settings and information about the "Smart Grid features" can be found. If you want to use "Smart Grid feature", you need Smart Grid Modem.

How to see the Smart Grid Level

1. Touch the button  button two times in the right bottom corner of the settings list.
2. Select the Smart Grid on the settings list.

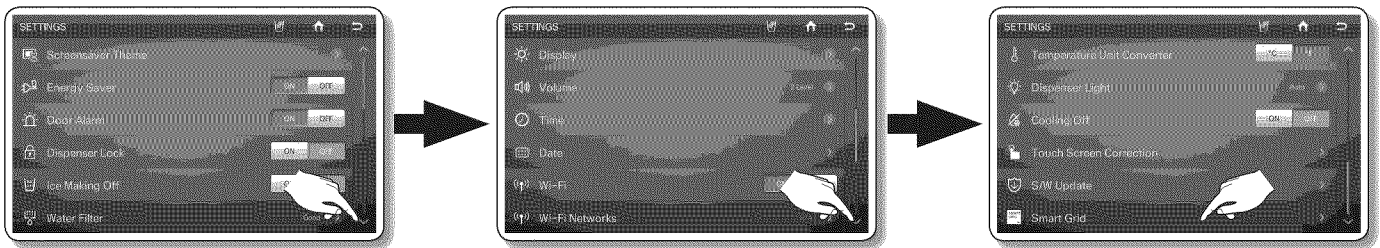

3. When Modem is connected, You can check the DR-Level received from electric utility companies. DR(Demand Response)-Level means the degree to manage customer consumption of electricity.

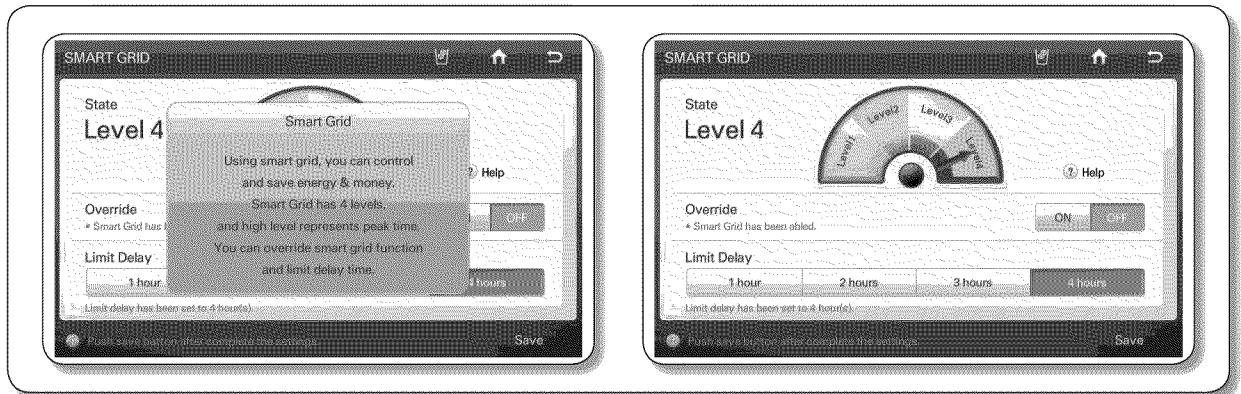

- If you touch each level text or Help button, you can see information about Smart Grid Function. Higher Level means higher peak time than lower levels.

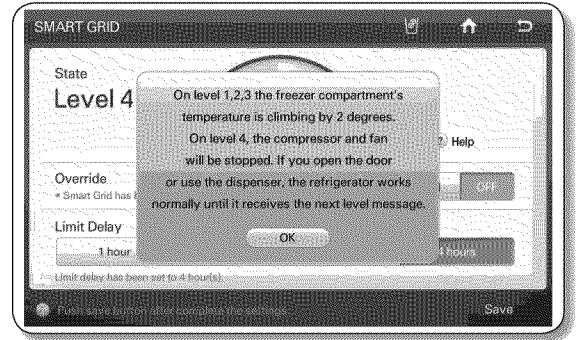

- If Modem is not connected, The message can be found.

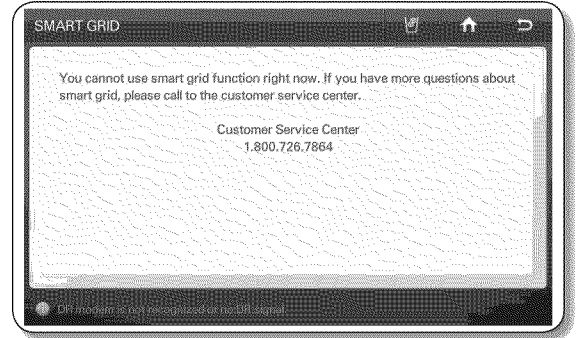
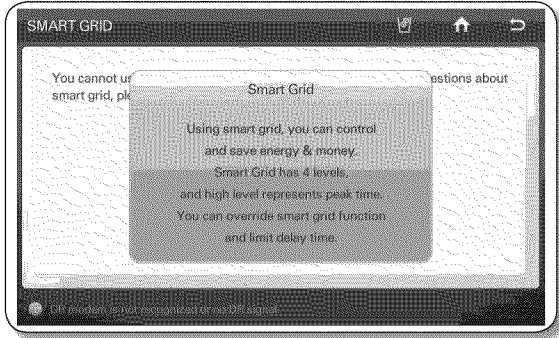

How to override the Smart Grid Control

- Touch the button  button two times in the right bottom corner of the settings list.
- Select the Smart Grid on the settings list.

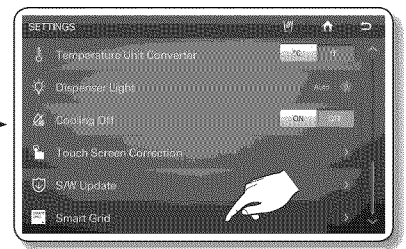
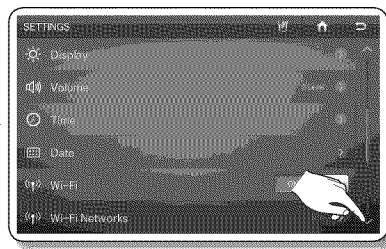
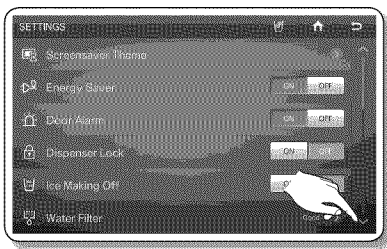

- If you want appliances to operate according to DR-Level(or Smart Grid), touch Override "Off" button. If you want appliances to operate irrespective of DR-Level(or Smart Grid), touch Override "On" button.



[Turn On Override]

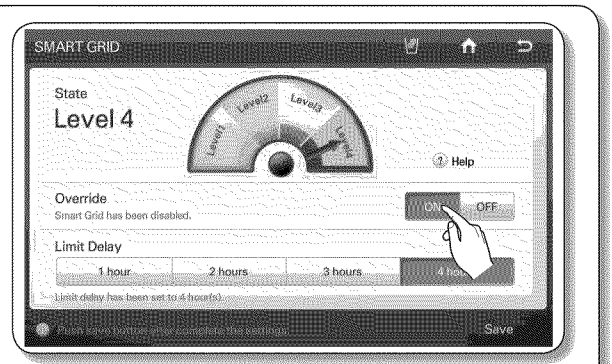

[Turn Off Override]

- You can select the Override time from 1 hour to 24hour After set time, Override function will be turned off and Smart Grid control will be started. When you select "Permanently", "Override" function will operate continuously until the "Override" function is turned off.

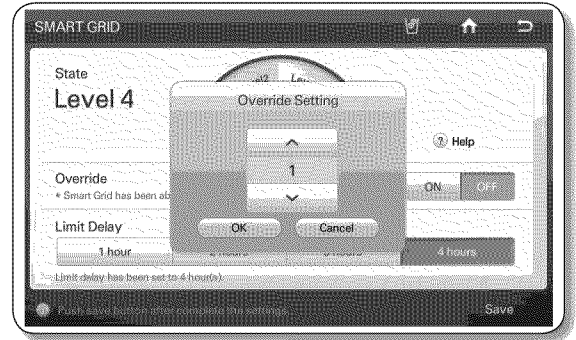

- Select the Save button.



- If "Permanently" does not turn off, "Override" function will operate continuously.
- If you think refrigerator temperature is higher, you need to use "Override" function.
- If you think there is not enough ice, you need to use "Override" function.

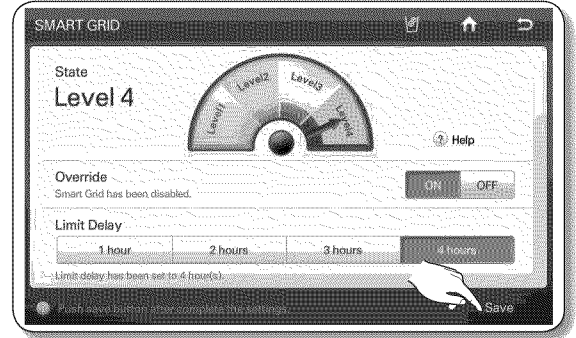

How to select limit delay time on Smart Grid

- Touch the button  button two times in the right bottom corner of the settings list.
- Select the Smart Grid on the settings list.

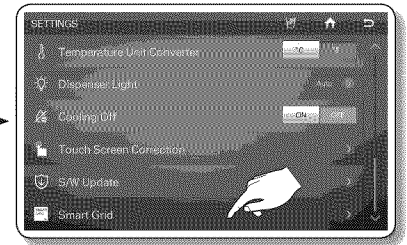
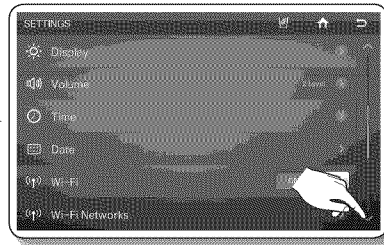
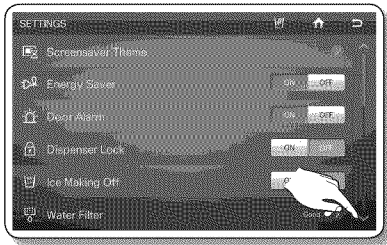

- Select "Limit Delay Time" from 1hr to 4hr "Limit Delay Time" means the max time during which Smart Grid control operates.

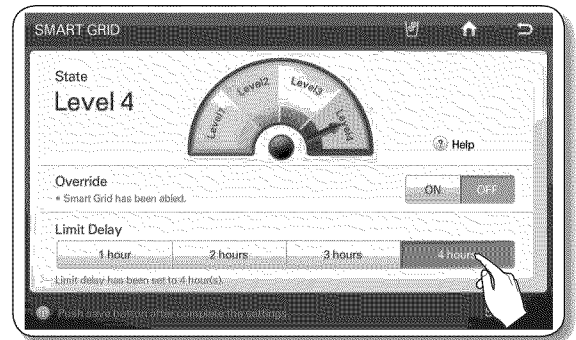

- Select the Save button.



- If you don't choose the "Limit Delay Time" Option, It will work with the "4-hour" option by default.

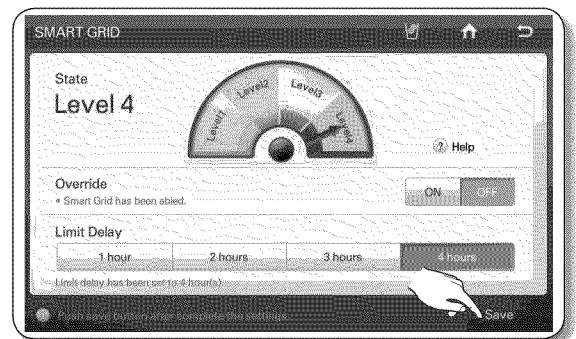

HOW TO USE THE DISPENSER

Touch the dispenser status on the Home screen to select the type of dispenser you want. Place your cup under the ice outlet and push gently against the dispenser lever.

Make sure the glass is in line with the dispenser to prevent the ice from bouncing out.

When Cubed Ice is selected after using the Crushed Ice feature, a small amount of residual crushed ice might be produced.

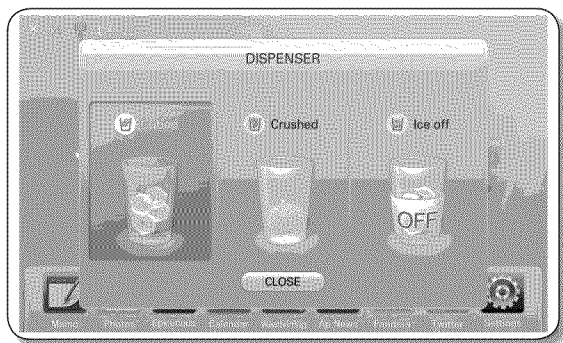

Please wait 2 seconds before removing the glass under the dispenser to prevent spills.

If the Refrigerator door opens, the Dispenser does not work.

- Water Dispenser Installation After installation, press the dispenser arm for at least 2 minutes to remove trapped air from the water line and to fill the water system.
- Do not pull the lever out. You could damage or break the lever's spring.
- To clean the ice bin/bucket, wash with a mild detergent, rinse well, and dry thoroughly it. Do not use harsh or abrasive cleaners or solvents.

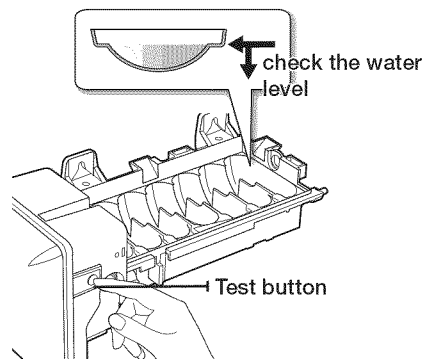

- In case ice doesn't come out, pull out the ice bucket and press the test button located on the right side of ice maker.

- Do not press the test button continuously when the tray is filled with ice or water. Water may overflow or ice may jam the bucket.
- Normal Use

To fill the ice bucket to maximum capacity after installation, follow these steps:

1. Allow your refrigerator to operate and cool down for 24 hours (or 1 full day).
 - Waiting 24 hours will allow your ice maker to cool properly.
2. Dispense 4 to 6 ice cubes into the glass.
3. After 8, and then 16 hours, dispense a full glass of ice.



- When you press the Test button, you will hear the refrigerator chime (ding-dong). When the chime sounds, release the Test button.

- The chime sounds automatically again to let you know the ice maker is working well.



If a power failure occurs, ice cubes may melt then freeze together when the power comes back on, causing the dispenser to be out of order.

To prevent this problem, after a power failure, pull out the ice bucket and discard the residual ice or water.



After you dump the ice from the ice bucket, you should press the dispenser lever once with the 'CUBED' or 'CRUSHED' function ON.

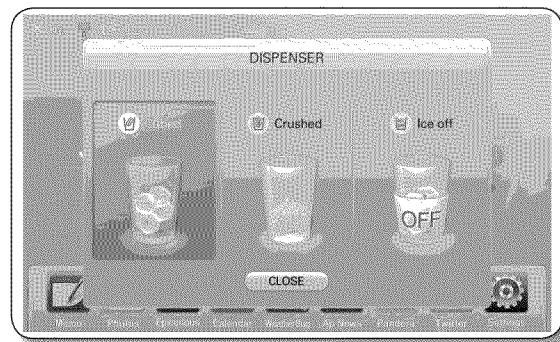

The ice maker will make new ice faster after you return the ice bucket in the refrigerator.



If you use all the ice at once, you must repeat Steps 2 and 3 on the previous page. However, only wait 8 hours before dispensing the first 4 to 6 ice cubes. This will replenish the ice cubes and ensure maximum ice production.

CHANGING THE WATER FILTER



To reduce risk of water damage to your property **DO NOT** use generic brands of water filters in your SAMSUNG Refrigerator. **USE ONLY SAMSUNG BRAND WATER FILTER.** SAMSUNG will not be legally responsible for any damage, including, but not limited to property damage caused by water leakage from use of a generic water filter. SAMSUNG Refrigerators are designed to work **ONLY WITH SAMSUNG** Water Filter.

The Water Filter status icon on the Home screen enables you to check the filter current status of the water filter.

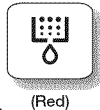

The Filter icon turns red to let you know when it is time to change your water filter cartridge. To give you time to get a new filter, the red icon comes on just before the capacity of the current filter runs out. Changing the filter on time provides you with the freshest, cleanest water from your refrigerator.

1. Shut off the water supply. Then, turn the water filter (**1**) about 1/4 turn, counter-clockwise.
2. Pull the water filter (**1**) from the case filter (**2**).

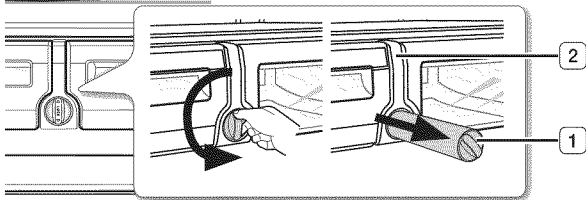

- To change the water filter more easily, shut off the water supply valve.

- Sometimes, it is hard to disassemble the water filter because impurities in the water cause it to stick. If you are having difficulties, grip the water filter firmly and pull it hard.
- When you pull the water filter, a little water can leak from the opening. This is normal. To minimize the water leaks, keep the filter cartridge horizontal when you pull it.
- To prevent overflow, empty the water tray filter (**3**) and dry around of case filter (**2**).

3. Insert the new filter into the filter case (**4**)
4. Push the filter, and then turn it clockwise until it locks.

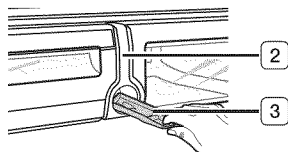

- If you are in trouble of inserting the water filter as high pressure of water, shut off the water supply valve.

- The locked symbol should be lined up with the indicator line.

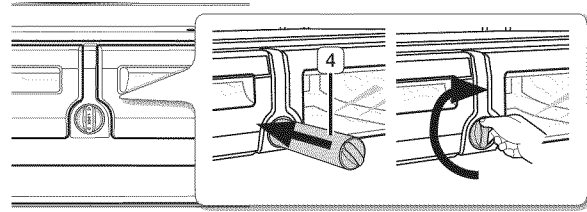

5. When the replacement is done, touch and hold the 'Reset the water filter' simultaneously for 3 or more seconds at the center of the screen. (Refer to page 56)

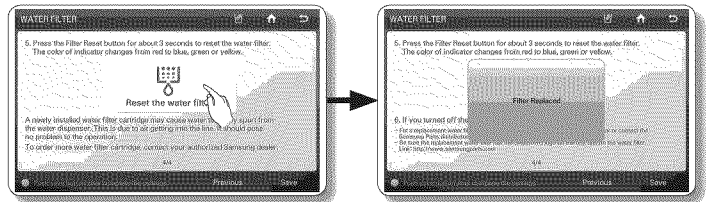
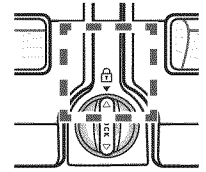

6. If you turned off the water supply, turn it back on.



For a replacement water filter, you can visit your local home Improvement center or contact the Samsung Parts distributor. Be sure the replacement water filter has the SAMSUNG logo on the box and on the water filter.

Link : <http://www.samsungparts.com>

Removing any residual matter inside the water supply line after installing the water filter.

1. Turn ON the main water supply and supply water from water supply line.
2. Run water through the dispenser until the water runs clear (approx. 6 to 7 minutes). This will clean the water supply system and remove air from the lines.
3. Additional flushing may be required in some households.
4. Open the Refrigerator door and make sure there are no water leaks coming from the water filter.

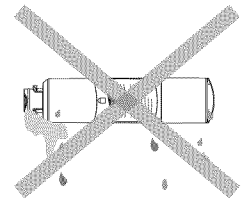

Be sure to flush the dispenser thoroughly, otherwise water may drip from the dispenser. This means that there is still air in the line.

Reverse Osmosis Water Supply

IMPORTANT : The pressure of the water supply coming out of a reverse osmosis system going to the water inlet valve of the refrigerator needs to be between 35 and 120 psi (241 and 827 kPa).

If a reverse osmosis water filtration system is connected to your cold water supply, the water pressure to the reverse osmosis system needs to be a minimum of 40 to 60 psi (276 to 414 kPa.)

If the water pressure to the reverse osmosis system is less than 40 to 60 psi (276 to 414 kPa):

- Check to see whether the sediment filter in the reverse osmosis system is blocked. Replace the filter if necessary.
- Allow the storage tank on the reverse osmosis system to refill after heavy usage.
- If your refrigerator has a water filter, it may further reduce the water pressure when used in conjunction with a reverse osmosis system. Remove the water filter.

If you have questions about your water pressure, call a licensed, qualified plumber.

USING THE TWO LEVER DISPENSER

Push the appropriate ice type button to select what you want dispensed.

Using the ice lever (1)

Push the Ice lever dispenser (1) gently with your glass. Ice will be released from the dispenser.

You can choose the ice type. (refer to SETTING THE DISPENSER)

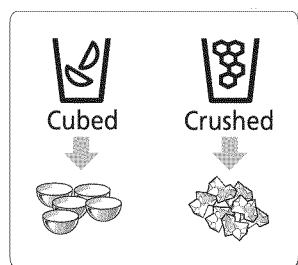

Using the Water lever (2)

Push the Water lever dispenser (2) gently with your glass. Water will be released from the dispenser.

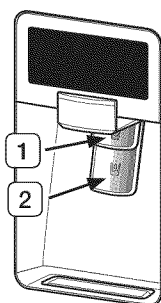

Even if you push the water and Ice lever simultaneously, the dispenser operates only the option you selected or pushed first.

Using the Ice & Water Dispenser together

To get Ice and water, push the Ice lever (1) first for ice, then move your glass down and press the water dispenser lever (2) for water.

USING THE ICE OFF FUNCTION

When you select the Ice Off mode, remove all ice cubes from the bucket. If you are not using the ice dispenser, the ice cubes may clump together.

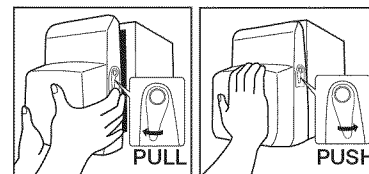

Pull the lock lever forward to remove the bucket.

Throw away the ice cubes or clumped ice.

Push the bucket back until you hear a click.



CAUTION

Use only the ice maker provided with the refrigerator. The water supply to this refrigerator must only be installed/connected by a suitably qualified person.

Connect to a potable water supply only.

To operate the ice maker properly, water pressure of 138 ~ 862Kpa is required.

If you have a long vacation or business trip and won't use the water or ice dispensers for a long time:

- Close the water valve. Otherwise, water leakage may occur.
- Remove all food.
- Unplug the refrigerator.
- Wipe excess moisture from inside and leave the doors open. Otherwise, odor and mold may develop.

Do not put your fingers, hands or any other unsuitable objects in the chute or ice-maker bucket.

- It may result in personal injury or material damage.

Never put your finger or any other objects in the dispenser opening.
 - It may cause injury.

Do not try to disassemble the ice maker.
 Do not wash or spray the ice bucket with water while it is in the refrigerator. Remove it to clean it.

Water clouding phenomenon

 All water provided to the refrigerator flows through the core filter which is an alkaline water filter. In the filtering process, the pressure of the water that has flowed out of the filter is increased, and the water becomes saturated with oxygen and nitrogen.

When this water flows out into the air, the pressure plummets and the oxygen and nitrogen get supersaturated, which results in gas bubbles.
 The water may temporarily look misty or cloudy due to these oxygen bubbles.
 After a few seconds, the water will look clear.

 Please wait 1 second before removing the cup after dispensing water to prevent spills.
 Do not pull out the lever dispenser after dispensing ice or water.
 It comes back automatically. Ice is made in cubes. When you select "Crushed", the ice maker grinds the ice cubes into crushed ice.

PARTS AND FEATURES

Use this page to become more familiar with the parts and features of the refrigerator.

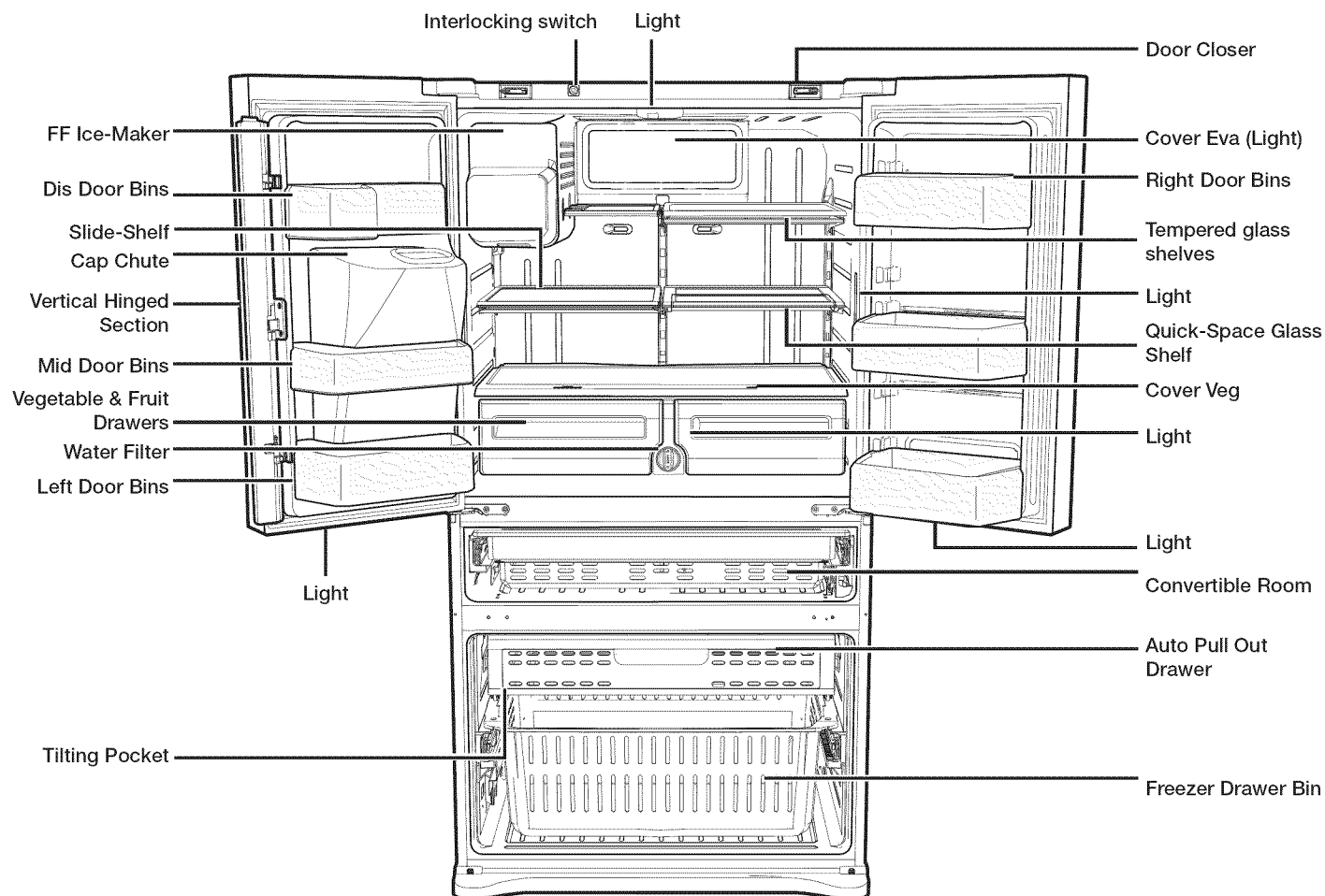

- When closing the door, make sure the Vertical Hinged Section is in the correct position to avoid scratching the other door.

If the Vertical Hinged Section is reversed, put it back to the right position and close the door.

Moisture may appear at times on the Vertical Hinged Section.

The door handle may become loose over time. If this happens, tighten the bolts found on the inside of the door.

If you close one door with a lot of force, the other door may open.

- When the door opens, the interlock switch automatically turns off the auger motor in the ice maker for safety reasons.

- When the interior or exterior LED lamp has gone out, please contact your service agents.

USING FLEX ZONE

The Flex Zone is a full-width drawer with an adjustable temperature control. You can use the Flex Zone for large party trays, deli items, wines, pizzas, beverages, or miscellaneous items. There is a temperature sensor which lets you adjust the amount of cold air allowed into the Zone. The control buttons are located on the cap door center.

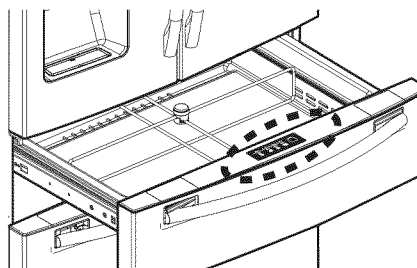

- Press the Temp button repeatedly until your desired mode is lit.
- Each time you press the Temp button, you change the mode in this order: Meat/Fish mode (29°F), Cold Drinks mode (33°F), Deli/Snack (37°F), Wine/Party Dishes (42°F) mode. Initially, the Cold Drinks mode is selected.

The refrigerator will adjust the temperature in the Flex Zone automatically to the temperature you selected.

- The Flex Zone Temp. Display may change depending on the number of items inside, where they are located, the ambient temperature, and how often the door is opened.

Temperature

You can select your Flex Zone temperature from Meat/Fish mode (29°F), Cold Drinks mode (33°F), Deli/Snack (37°F), or Wine/Party Dishes (42°F) mode.

Selection Button

- When "**Wine/Party Dishes**" is selected, the temperature of Flex Zone will be kept around 42°F (5°C). This feature helps keep food fresh for a long time.

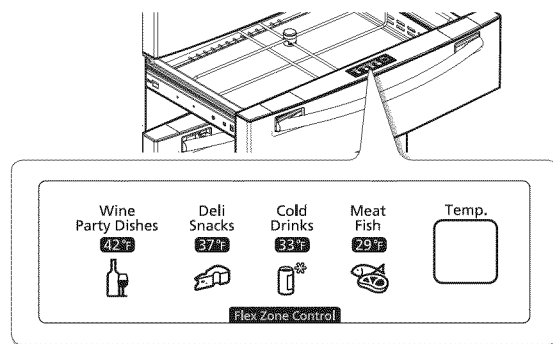

- When "**Deli/Snack**" is selected, the temperature of Flex Zone will be kept around 37°F (3°C). This feature helps keep food fresh for a longer time.
- When "**Cold Drink**" is selected, the temperature of Flex Zone will be kept around 33°F (1°C). This feature also helps keep drinks cold and refreshing.
- When "**Meat/Fish**" is selected, the temperature of Flex Zone will be kept around 29°F (-1°C). This feature also helps keep meat or fish fresh for a longer time.

Wine Party Dishes	Deli Snacks	Cold Drinks	Meat Fish
• wine	• pineapples	• bottled water	• steaks
• cocktails	• lemons	• juice	• cold cuts
• cakes	• biscuits	• soft drinks	• bacon
• cheeses	• potatoes	• beer	• chili dogs

- Fruit and vegetables may be damaged under the "Meat Fish" setting. Do not store lettuce or other leafy produce in the Flex Zone.



Do not store glass bottles in the Flex Zone under the "Cold Drinks" or "Meat/Fish" setting. If they are frozen, they can break and cause personal injury.

REMOVING THE REFRIGERATOR ACCESSORIES

1. Door Bins & Dairy Compartment

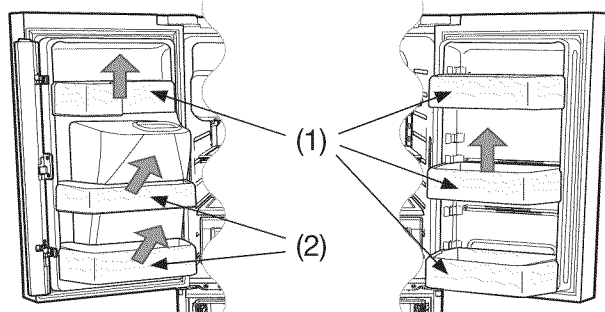

- **Door Bins (1)**
To remove - Simply lift the bin up and pull straight out.
To relocate - Slide it in above the desired location and push down until it stops.
- **Door Bins (2)**
To remove - Take the right side of the bin out by lifting it obliquely along the guide and then, take the left side out by pulling it from the door.
To relocate - Slide it into the original location and push down until it sticks.



Injury may occur if the door bins are not firmly assembled.

Do not allow children to play with bins. Sharp corners of the bins may cause injury.



Do not adjust a bin full of food. Remove the food first. Dust removal method - Remove the guard and wash in water.

2. Tempered Glass shelves

- **To remove**-Tilt up the front of the shelf in the direction shown (1) and lift it up vertically (2).
Pull the shelf out.
- **To relocate**-Tilt the front of the shelf up and guide the shelf hooks into the slots at a desired height. Then lower the front of the shelf so that the hooks can drop into the slots.

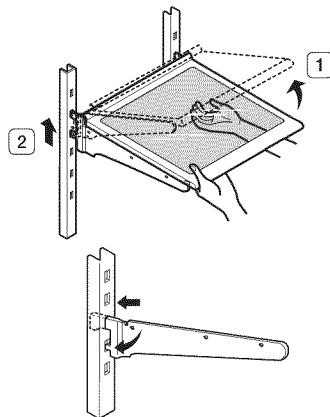

The Tempered Glass shelves are heavy. Use special care when removing them.

3. Vegetable & Fruit Drawers

- **To remove**-Pull the drawer out to full extension. Tilt up the front of the drawer and pull straight out.
- **To relocate**-Insert the drawer into the frame rails and push back into place.



The drawers need to be removed before the glass shelf above them can be lifted out.

4. Flex Zone

- **To remove the Flex Zone**-Pull the Flex door out to full extension. Lift the Flex Zone up, pulling it to your body with both hands.
- **To relocate the Flex Zone**-Open the Flex door to full extension. Tilt the front of the Flex Zone up, place the back of the Flex Zone onto the rails, and then lower the front until the whole Zone rests on the rails.

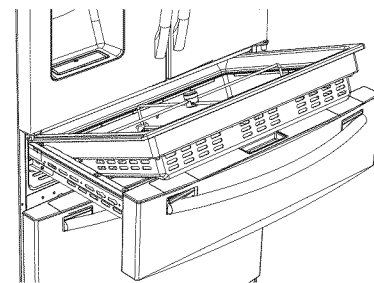

When the Flex Zone or LED lighting are not working, check the connectors [(1), (2) shown below] for cracks or leaks.

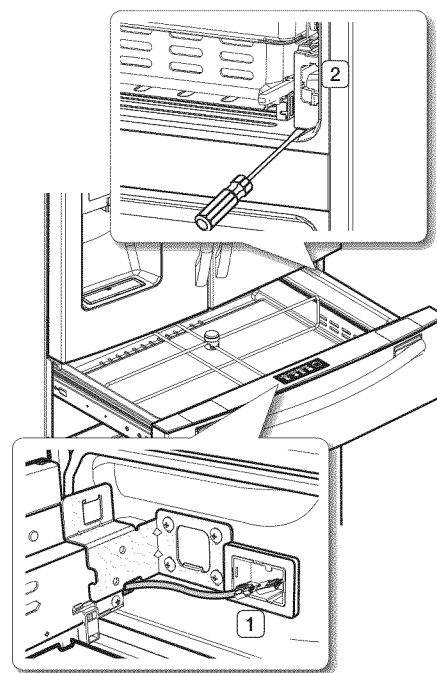

1. Refer to page 7 for disassembly instructions.
2. Open the cover housing with a flat-blade screwdriver.

USING THE DOORS

Ensure that the doors close all the way and are securely sealed.

When the refrigerator door is only partially open, it will automatically close.

But, the door will stay open when opened more than the auto close range and you must close it manually.

USING THE TILTING POCKET

The Tilting Pocket can be used to store up to a 16" pizza if you place it as shown in the illustration.

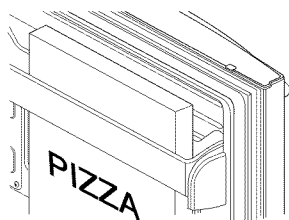

REMOVING THE FREEZER ACCESSORIES

1. Tilting Pocket

- **To remove**-Remove the tilting pocket (**1**) by pulling both support guards (**2**) aside. Take out both support guards by pulling them aside.
- **To replace**-Hook the ends of the tilting pocket (**1**) onto the support guards (**2**) and push down until they lock into place.

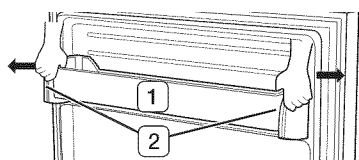

2. Super Extended Drawer

- **To remove**-Pull the drawer out to full extension. Tilt up the rear of the drawer and lift straight out.
- **To relocate**-Place the drawer onto the rails (**4**) by tilting it up. Lower the drawer into place until it is horizontal and slide the drawer (**3**) in.

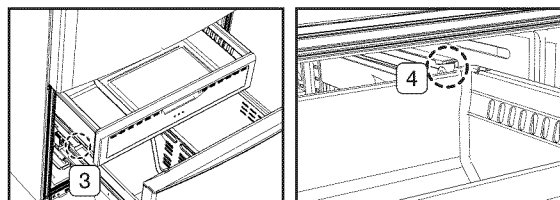

3. Freezer Drawer

- **To remove the freezer drawer**-Pull the freezer drawer out fully. Tilt up the rear of the bin and lift it out to remove.
- **To relocate the freezer drawer**-Place the bin into the rail assembly.



Do not allow babies or children go inside the freezer drawer. They could damage the refrigerator and seriously injure themselves.

Do not sit on the freezer door.

The door may break. Do not allow children to climb into the freezer drawer.



Do not remove the divider.



If trapped inside, children may become injury and suffocate to death.

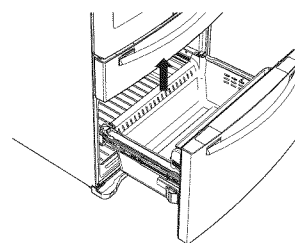

FOOD STORAGE TIPS

Foods	Refrigerator	Freezer	Storage Tips
DAIRY PRODUCTS			
Butter	2-3 Weeks	6-9 Months	Wrap or cover tightly.
Milk	1-2 Weeks	Not recommended	Check date code. Most milk and similar products are sold in date-coded cartons that indicate a products's peak freshness. Re-seal with cap or wrap tightly. Do not return unused prtions to orignal container.
Cream Cheese, cheese food, and cheese spread	2-4 Weeks	Not recommended	
Hard Cheese (un-opened)	3-4 Months	6 Months	
Hard Cheese (opened)	2 Months	Not recommended	
Cottage Cheese	10-15 Days	Not recommended	
Cream	7-10 Days	2 Months	Check date code. Most yogurt, creams, and similar products are sold in date-coded cartons that indicate a product's peak freshness. Re-seal or cover tightly. Do not return unused portions to original container.
Sour Cream	2 Weeks	Not recommended	
Cream Dips (opened)	1 Week	Not recommended	
Yogurt	10-14 Days	Not recommended	Check date code. Keep covered.
Frozen Yogurt	na	2 Months	
EGGS			
Eggs (uncooked)	3-4 Weeks	Not recommended	Check date code. Store eggs in coldest part of refrigerator and in their original container.
Eggs (cooked)	1 Week	Not recommended	Store in covered container
Leftover egg dishes	3-4 Days	Not recommended	Store in covered container
FRESH FRUITS			
Apples	1 Month	Not recommended	If storing in refrigerator, do not wash fruit before storing. Store in moisture resistant bags or containers. Wrap cut fruits. Some fruits darken when refrigerated.
Bananas	2-4 Days	Not recommended	
Peaches, Melons, Pears, Avocados	3-5 Days	Not recommended	
Berries and Cherries	2-3 Days	12 Months	
Apricots	3-5 Days	Not recommended	
Grapes	2-5 Days	na	
Pineapple (un-cut)	2-3 Days	Not recommended	
Pineapple (cut)	5-7 Days	6-12 Months	
Citrus	1-2 Weeks	Not recommended	Store uncovered.
Juice	6 Days	Not recommended	Check date code and re-seal in original container. Do not return unused portions to original container.
Frozen Juice	Thawing only	12 Months	Check date code. Do not re-freeze.

Foods	Refrigerator	Freezer	Storage Tips
FISH AND SHELLFISH			
Fish			
Fatty Fish (mackerel, trout, salmon)	1-2 Days	2-3 Months	Keep in original wrapper and store in coldest part of refrigerator. Package in vapor-proof and moisture proof wrap for freezer. Freeze at 0°F. Thaw in refrigerator or check date code. Freeze in original packaging.
Lean Fish (cod, flounder, etc)	1-2 Days	6 Months	
Frozen or Breaded	na	3 Months	
Shellfish			
Shrimp (uncooked)	1-2 Days	12 Months	To freeze, package in vapor-proof and moisture-proof container.
Crab	3-5 Days	10 Months	
Cooked Fish or Shellfish	2-3 Days	3 Months	
MEAT			
Fresh, Uncooked			
Chops	2-4 Days	6-12 Months	Check date code for use. Store in coldest part of refrigerator in original packaging. Package in moisture-proof and vapor-proof container for freezing. Recommended refrigerator temperature 33°F to 36°F and freezer temperature 0°F to 2°F
Ground	1 Day	3-4 Months	
Roast	2-4 Days	6-12 Months	
Bacon	1-2 Weeks	1-2 Months	
Sausage	1-2 Days	1-2 Months	
Steak	2-4 Days	6-9 Months	
Poultry	1 Day	12 Months	
Lunch meat	3-5 Days	1 Month	
Cooked			
Meat	2-3 Days	2-3 Months	Check date code for use. Store in coldest part of refrigerator in original packaging. Package in moisture-proof and vapor-proof container for freezing.
Poultry	2-3 Days	4-5 Months	
Ham	1-2 weeks	1-2 Months	

Sources:

American Meat Institute Foundation. 1994. Yellow pages: answers to predictable questions consumers ask about meat and poultry. American Meat Institute Food Marketing Institute. 1999. The food keeper. Food Marketing Institute, Washington, D.C. Freeland-Graves, J.H. and G.C. Peckham. 1996. Foundations of food preparation, 6th ed. Prentice-Hall, Inc. Englewood Cliffs, NJ. Hillers, V.N. 1993. Storing foods at home. Washington State University Cooperative Extension, Pullman, WA. Publ. EB 1205.

National Restaurant Association. 2001. Be cool-chill out! Refrigerate promptly. National Restaurant Association Education Foundation's International Food Safety Council, Washington, D.C. USDA. 1997. Basics for handling food safely. U.S. Department of Agriculture, Food Safety and Inspection Service, Washington, D.C.

CLEANING THE REFRIGERATOR

Caring for your Samsung French Door Refrigerator prolongs the life of your appliance and helps keep the refrigerator free of odor and germs.

Cleaning the Interior

Clean the inside walls and accessories with a mild detergent and then wipe dry with a soft cloth. You can remove the drawers and shelves for a more thorough cleaning. Just make sure to dry drawers and shelves before putting them back into place.

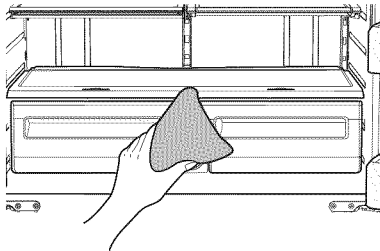

Cleaning the Exterior

Wipe the control panel and digital display with a damp, clean, soft cloth. Do not spray water directly on the surface of the refrigerator.

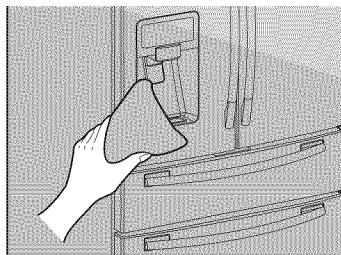

The doors, handles and cabinet surfaces should be cleaned with a mild detergent and then wiped dry with a soft cloth. To keep your appliance looking its best, polish the exterior once or twice a year.



Do not spray water directly or not use a wet or damp cloth.



Do not use benzene, thinner, or Clorox for cleaning. They may damage the surface of the appliance and may cause a fire.



Printed letters on the display may be erased if the stainless cleaner is applied directly to the area where the letters are printed.



Cleaning the Ice / Water Dispenser

Push down one end of the tray dispenser and remove it. Wipe the Ice / Water Dispenser with a clean and soft cloth.



When using the crushed ice selection from the dispenser some residual ice chips may start to collect in the ice chute. In order to prevent that residual ice from melting and running out of the chute you should clean out the residual ice when you see it start to collect in the ice chute.

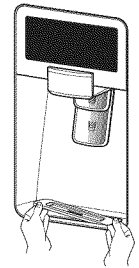

Cleaning the Rubber door seals

If the rubber door seals are dirty, the doors may not close properly, and the refrigerator will not operate efficiently. Keep the door seals free of dust or stain by cleaning the doors with a mild detergent and damp cloth. Wipe dry with a clean, soft cloth.

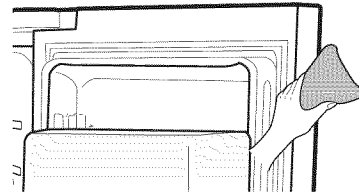

Do not clean the refrigerator with benzene, thinner, or car detergent due to risk of fire.

Cleaning the rear side of the refrigerator

To keep cords and exposed parts free of dust and dirt accumulation.

Vacuum the rear side of the appliance once or twice a year.

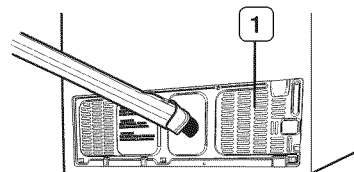

Do not remove the back cover (**1**). You could suffer an electric shock.

Troubleshooting

PROBLEM	SOLUTION
The refrigerator does not work at all or it does not chill sufficiently.	<ul style="list-style-type: none"> • Check that the power plug is properly connected. • Is the temperature control on the display panel set to the correct temperature? Try setting it to a lower temperature. • Is the refrigerator in direct sunlight or located too near a heat source? • Is the back of the refrigerator too close to the wall and therefore keeping air from circulating?
The food in the fridge is frozen.	<ul style="list-style-type: none"> • Is the temperature control on the display panel set to the correct temperature? Try setting it to a warmer temperature. • Is the temperature in the room very low? • Did you store the food with a high water content in the coldest part of the fridge?
You hear unusual noises or sounds.	<ul style="list-style-type: none"> • Check that the refrigerator is level and stable. • Is the back of the refrigerator too close to the wall and therefore keeping air from circulating? • Was anything dropped behind or under the refrigerator? • A “ticking” sound is heard from inside the refrigerator. This is normal and occurs because various accessories are contracting or expanding in relation to the temperature of the refrigerator interior.
The front corners of the appliance are hot and condensation is occurring.	<ul style="list-style-type: none"> • Some heat is normal as anti-condensators are installed in the front corners of the refrigerator to prevent condensation. • Is the refrigerator door ajar? Condensation can occur when you leave the door open for a long time.
Ice is not dispensing.	<ul style="list-style-type: none"> • Did you wait for 12 hours after installation of the water supply line before making ice? • Is the water line connected and the shut-off valve open? • Did you manually stop the ice making function? Make sure Ice Type is set to Cubed or Crushed. • Is there any ice blocked within the ice maker bucket? • Is the freezer temperature too warm? Try setting the freezer temperature lower.
You can hear water bubbling in the refrigerator.	<ul style="list-style-type: none"> • This is normal. The bubbling comes from the refrigerant coolant liquid circulating through the refrigerator.
There is a bad smell in the refrigerator.	<ul style="list-style-type: none"> • Has a food item spoiled? • Make sure that strong smelling food (for example, fish) is wrapped so that it is airtight. • Clean out your freezer periodically and throw away any spoiled or suspect food.
Frost forms on the walls of the freezer.	<ul style="list-style-type: none"> • Is the air vent blocked? Remove any obstructions so air can circulate freely. • Allow sufficient space between the foods stored for efficient air circulation. • Is the freezer door closed properly?
Water dispenser is not functioning.	<ul style="list-style-type: none"> • Is the water line connected and the shut-off valve open? • Has the water supply line tubing been crushed or kinked? Make sure the tubing is free and clear of any obstruction. • Is the water tank frozen because the refrigerator temperature is too low? Try selecting a warmer setting on the main display panel.
Display does not work!	<ul style="list-style-type: none"> • Press the Reset button over one second to reset the memory. With this, the user information is not to be reset.

PROBLEM	SOLUTION
Photos not showing with the memory card connected	<ul style="list-style-type: none"> • When the “A SD/MMC card is connected” messages do not show on the screen, check if the memory type is SD / SDHC / MMC / HS MMC. • Check if there are photos or images stored in the memory card. • Check if the images in the memory card are JPEG (JPG) types.
The LCD screen turns off frequently.	<ul style="list-style-type: none"> • It is a power-saving function and it is normal. • At the Settings-Display, the Screensaver Running Time can be set.
There is image sticking or an edge line left on the screen.	<ul style="list-style-type: none"> • The still screen can make a permanent damage on the LCD. So, when selecting a Screensaver, select as many themes as possible. <p>NOTE : Defects caused by this will not be covered by the factory warranty.</p>
The input point of the touch screen is not correct.	<ul style="list-style-type: none"> • Run the Touch Screen Calibration function at the Settings.
There is no wireless AP detected.	<ul style="list-style-type: none"> • Check if the power for the wireless AP is on. • Check if the wireless AP supports IEEE 802.11 b/g. • If the wireless AP is located away from the Fridge, move the wireless AP closer to the Fridge and check if it is detected. • Turn off and on the power of both the Wireless AP and the Fridge.
It is not able to connect to the wireless AP.	<ul style="list-style-type: none"> • Check if the wireless AP supports IEEE 802.11 b/g. • Check the status of the internet connection of the wireless AP. • Check if the current cost rate plan of the internet covers the wireless network connection, And, if so, please check how many connections are allowed. • When the device is processed with the MAC address certification and registration with the new internet provider, it can not be connected to the wireless network. In this case, please contact your internet provider and get supports for the wireless network connection with a device (Fridge) other than the device having the prior certification. (The MAC address of the Fridge can be found on the bottom of the screen showing the wireless AP after selecting the Settings - WiFi Networks.) • Turn off and on the power of both the Wireless AP and the Fridge.
Can't remember the password for the wireless AP connection.	<ul style="list-style-type: none"> • Refer to the wireless AP manual and reset the password again.
Functions using the wireless network (Wi-Fi) do not work.	<ul style="list-style-type: none"> • Functions using the wireless network (Wi-Fi) such as Epicurious, Calendar, WeatherBug, AP News, Pandora and Twitter can be used only with the households using the wireless network (Wi-Fi). • If there are any other devices connected to the wireless network, please check the connection status of the device. • Since it is a service based on the data from the information provider through the internet, the information updates can be delayed or cut depending on the status of the internet connection. • Turn off and on the power of both the Wireless AP and the Fridge.
Can't connect to the external devices being detected.	<ul style="list-style-type: none"> • When the network of the external device being detected is abnormally shut down (such as power off, out of the network range, etc), the network information will remain on the network list by the DLNA specifications. But, its connection is not available. • Select the Photos function - All Share and search the external devices again.

Warranty

WARRANTY ON SAMSUNG REFRIGERATOR

LIMITED WARRANTY TO ORIGINAL PURCHASER

This Samsung brand product, as supplied and distributed by Samsung Electronics America, Inc. (Samsung) and delivered new, in the original carton to the original consumer purchaser, is warranted by Samsung against manufacturing defects in materials and workmanship for a limited warranty period of:

One (1) year Parts and Labor on Refrigerator

Five (5) years Parts and Labor on sealed Refrigeration system only*

(*Compressor, evaporator, condenser, drier, connecting tubing)

This limited warranty begins on the original date of purchase, and is valid only on products purchased and used in the United States. To receive warranty service, the purchaser must contact Samsung for problem determination and service procedures. Warranty service can only be performed by a Samsung authorized service center. The original dated bill of sale must be presented upon request as proof of purchase to Samsung or Samsung authorized service center.

Samsung will repair or replace any part found to be defective, at our option and at no charge as stipulatedX herein, with new or reconditioned parts during the limited warranty period specified above. All replaced parts and products become the property of Samsung and must be returned to Samsung. Replacement parts and products assume the remaining original warranty, or ninety (90) days, whichever is longer.

In-home service will be provided during the warranty labor period subject to availability within the contiguous United States. In-home service is not available in all areas. To receive in-home service, the product must be unobstructed and accessible from floor level to service personnel. If during in-home service repair cannot be completed, it may be necessary to remove, repair and return the product. If in-home service is unavailable, Samsung may elect, at our option, to provide for transportation of our choice to and from a Samsung authorized service center. Otherwise, transportation to and from the Samsung authorized service center is the responsibility of the purchaser.

This limited warranty covers manufacturing defects in materials and workmanship encountered in normal, noncommercial use of this product, and shall not apply to the following, including, but not limited to: damage which occurs in shipment; delivery and installation; applications and uses for which this product was not intended; altered product or serial numbers; cosmetic damage or exterior finish; accidents, abuse, neglect, fire, water, lightning or other acts of nature; use of products, equipment, systems, utilities, services, parts, supplies, accessories, applications, installations, repairs, external plumbing and leaks, external wiring, circuit breakers, fuses or connectors not supplied and authorized by Samsung, or which damage this product or result in service problems; incorrect electrical line voltage, fluctuations and surges; customer adjustments and failure to follow operating instructions, cleaning, maintenance and environmental instructions that are covered and prescribed in the instruction book; loss of food due to spoilage; consumable items including filters and light.

THERE ARE NO EXPRESS WARRANTIES OTHER THAN THOSE LISTED AND DESCRIBED ABOVE, AND NO WARRANTIES WHETHER EXPRESS OR IMPLIED, INCLUDING, BUT NOT LIMITED TO, ANY IMPLIED WARRANTIES OF MERCHANTABILITY OR FITNESS FOR A PARTICULAR PURPOSE, SHALL APPLY AFTER THE EXPRESS WARRANTY PERIODS STATED ABOVE, AND NO OTHER EXPRESS WARRANTY OR GUARANTY GIVEN BY ANY PERSON, FIRM OR CORPORATION WITH RESPECT TO THIS PRODUCT SHALL BE BINDING ON SAMSUNG. SAMSUNG SHALL NOT BE LIABLE FOR LOSS OF REVENUE OR PROFITS, FAILURE TO REALIZE SAVINGS OR OTHER BENEFITS, OR ANY OTHER SPECIAL, INCIDENTAL OR CONSEQUENTIAL DAMAGES CAUSED BY THE USE, MISUSE OR INABILITY TO USE THIS PRODUCT, REGARDLESS OF THE LEGAL THEORY ON WHICH THE CLAIM IS BASED, AND EVEN IF SAMSUNG HAS BEEN ADVISED OF THE POSSIBILITY OF SUCH DAMAGES. NOR SHALL RECOVERY OF ANY KIND AGAINST SAMSUNG BE GREATER IN AMOUNT THAN THE PURCHASE PRICE OF THE PRODUCT SOLD BY SAMSUNG AND CAUSING THE ALLEGED DAMAGE. WITHOUT LIMITING THE FOREGOING, PURCHASER ASSUMES ALL RISK AND LIABILITY FOR LOSS, DAMAGE OR INJURY TO PURCHASER AND PURCHASER'S PROPERTY AND TO OTHERS AND THEIR PROPERTY ARISING OUT OF THE USE, MISUSE OR INABILITY TO USE THIS PRODUCT SOLD BY SAMSUNG NOT CAUSED DIRECTLY BY THE NEGLIGENCE OF SAMSUNG. THIS LIMITED WARRANTY SHALL NOT EXTEND TO ANYONE OTHER THAN THE ORIGINAL PURCHASER OF THIS PRODUCT, IS NONTRANSFERABLE AND STATES YOUR EXCLUSIVE REMEDY.

Some states do not allow limitations on how long an implied warranty lasts, or the exclusion or limitation of incidental or consequential damages, so the above limitations or exclusions may not apply to you. This warranty gives you specific legal rights, and you may also have other rights, which vary from state to state.

To obtain warranty service, please contact Samsung at:

SAMSUNG CUSTOMER CARE CENTER

Samsung Electronics America, Inc. 85 Challenger Road Ridgefield Park, NJ 07660

1-800-SAMSUNG (1-800-726-7864) and www.samsung.com

memo

memo

memo



QUESTIONS OR COMMENTS?

COUNTRY	CALL	OR VISIT US ONLINE AT	WRITE
U.S	800-SAMSUNG (800-726-7864)	www.samsung.com	Samsung Electronics America, Inc. 85 Challenger Road Ridgefield Park, NJ 07660
CANADA	800-SAMSUNG (800-726-7864)	www.samsung.com/ca	Samsung Electronics Canada Inc. Customer Service, 55 Standish Court Mississauga, Ontario L5R 4B2 Canada

 In an effort to promote recycling this user manual is printed on recycled paper.