



VIZIO

3D FULL ARRAY
LED LCD HDTV

XVT3D424SV / XVT3D474SV / XVT3D554SV

USER GUIDE



RealD 3D Certified.



SRS TruSurround HD and SRS TruVolume are trademarks of SRS Labs, Inc. TruSurround HD and TruVolume technologies are incorporated under license from SRS Labs, Inc.



Manufactured under license from Dolby Laboratories. Dolby and the double-D symbol are trademarks of Dolby Laboratories.



This product qualifies for ENERGY STAR in the “factory default” setting and this is the setting in which power savings will be achieved. Changing the factory default picture settings or enabling other features will increase power consumption that could exceed the limits necessary to qualify for ENERGY STAR rating.

TRADEMARKS SHOWN ARE THE PROPERTY OF THEIR RESPECTIVE OWNERS. IMAGES USED ARE FOR ILLUSTRATION PURPOSES ONLY. VIZIO, THE V LOGO, WHERE VISION MEETS VALUE, AND OTHER VIZIO TRADEMARKS ARE THE INTELLECTUAL PROPERTY OF VIZIO INC. PRODUCT FEATURES AND SPECIFICATIONS ARE SUBJECT TO CHANGE WITHOUT NOTICE. © 2010 VIZIO INC. ALL RIGHTS RESERVED.

Welcome!

Congratulations on your new VIZIO LED LCD 3D HDTV.

To get the most out of your new VIZIO product, read these instructions before using your product and retain them for future reference.

For assistance, call 1-877-MYVIZIO (1-877-849-4623), or contact us at www.VIZIO.com/support.

To purchase or inquire about accessories and installation services for your VIZIO product, visit our website at www.VIZIO.com or call toll free at 1-888-849-4623.

We recommend you register your VIZIO product at:

- www.VIZIO.com
- or
- Complete the enclosed registration card and mail it to:

VIZIO
39 Tesla
Irvine, CA 92618

For peace of mind and to protect your investment beyond the standard warranty, VIZIO offers on-site extended warranty service plans. These plans provide additional coverage during the standard warranty period. To purchase an extended warranty service plan, visit www.VIZIO.com.

Thanks again for choosing VIZIO. We are confident you will enjoy your new VIZIO TV.



When you see this symbol, please read the accompanying important warning.



When you see this symbol, please read the accompanying helpful tip.

My Product Information

Enter your product information here for easy reference:

Model Number: _____

Serial Number: _____

Date of Purchase: _____

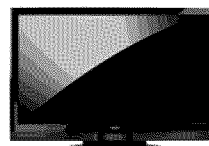

Important Safety Information for Viewing 3D Content



You may experience discomfort while watching 3D content. You may feel symptoms of eye strain, vision fatigue, color or depth distortion, motion sickness, nausea, dizziness, disorientation, or other discomforts. If you experience any of these symptoms, stop watching and take a break for at least thirty minutes before resuming. If the symptoms are severe or continue even after you have stopped watching 3D content, consult a doctor.



Take care to monitor children's watching of 3D content. Children (including teenagers) may be more at risk of experiencing discomfort while watching 3D content and less likely to report symptoms. Monitor children's 3D content viewing and watch for signs of discomfort.



Some viewers may be susceptible to epileptic seizures or strokes when viewing 3D images, even if those conditions have not been previously diagnosed. If you or anyone in your family has a history of seizures or strokes, or if you have any other reason to think you or someone under your supervision may be susceptible to epileptic seizures or strokes, consult a doctor before watching 3D content.



Even if you do not experience any of the above symptoms, take regular breaks from watching 3D content.

Important Safety Instructions

Your DTV is designed and manufactured to operate within defined design limits. Misuse may result in electric shock or fire. To prevent your DTV from being damaged, the following instructions should be observed for the installation, use, and maintenance of your DTV. Read the following safety instructions before operating your DTV. Keep these instructions in a safe place for future reference.

To reduce the risk of electric shock or component damage, switch off the power before connecting other components to your HDTV.

- Unplug the power cord before cleaning your HDTV. A damp cloth is sufficient for cleaning your HDTV. Do not use a liquid or a spray cleaner for cleaning your HDTV. Do not use abrasive cleaners.
- Always use the accessories recommended by the manufacturer to insure compatibility.
- When moving your HDTV from an area of low temperature to an area of high temperature, condensation may form in the housing. Wait before turning on your HDTV to avoid causing fire, electric shock, or component damage.
- Use only with the cart, stand, tripod, bracket, or table specified by manufacturer or sold with your HDTV. When a cart is used, use caution when moving the cart/HDTV combination to avoid injury from tip-over. Do not place your HDTV on an unstable cart, stand, or table. If your HDTV falls, it can injure a person and cause serious damage to your HDTV. Use only a cart or stand recommended by the manufacturer or sold with your HDTV.
- A distance of at least three feet should be maintained between your HDTV and any heat source, such as a radiator, heater, oven, amplifier etc. Do not install your HDTV close to smoke. Operating your HDTV close to smoke or moisture may cause fire or electric shock.
- Slots and openings in the back and bottom of the cabinet are provided for ventilation. To ensure reliable operation of your HDTV and to protect it from overheating, be sure these openings are not blocked or covered. Do not place your HDTV in a bookcase or cabinet unless proper ventilation is provided.
- Never push any object into the slots and openings on your HDTV cabinet. Do not place any objects on the top of your HDTV. Doing so could short circuit parts causing a fire or electric shock. Never spill liquids on your HDTV.
- Your HDTV should be operated only from the type of power source indicated on the label. If you are not sure of the type of power supplied to your home, consult your dealer or local power company.
- Do not apply pressure or throw objects at your HDTV. This may compromise the integrity of the display. The manufacturer's warranty does not cover user abuse or improper installations.
- The power cord must be replaced when using different voltage than the voltage specified. For more information, contact your dealer.
- Your HDTV is equipped with a three-pronged grounded plug (a plug with a third grounding pin). This plug will fit only into a grounded power outlet. This is a safety feature. If your outlet does not accommodate the three-pronged, have an electrician install the correct outlet, or use an adapter to ground your HDTV safely. Do not defeat the safety purpose of the grounded plug.
- When connected to a power outlet, power is always flowing into your HDTV. To totally disconnect power, unplug the power cord.
- The lightning flash with arrowhead symbol within an equilateral triangle is intended to alert the user to the presence of un-isolated, dangerous voltage within the inside of your HDTV that may

be of sufficient magnitude to constitute a risk of electric shock to persons.

- Do not overload power strips and extension cords. Overloading can result in fire or electric shock.
- The wall socket should be installed near your HDTV and easily accessible.
- Only power of the marked voltage can be used for your HDTV. Any other voltage than the specified voltage may cause fire or electric shock.
- Do not touch the power cord during lightning. To avoid electric shock, avoid handling the power cord during electrical storms.
- Unplug your HDTV during a lightning storm or when it will not be used for long period of time. This will protect your HDTV from damage due to power surges.
- Do not attempt to repair or service your HDTV yourself. Opening or removing the back cover may expose you to high voltages, electric shock, and other hazards. If repair is required, contact your dealer and refer all servicing to qualified service personnel.
- Keep your HDTV away from moisture. Do not expose your HDTV to rain or moisture. If water penetrates into your HDTV, unplug the power cord and contact your dealer. Continuous use in this case may result in fire or electric shock.
- Do not use your HDTV if any abnormality occurs. If any smoke or odor becomes apparent, unplug the power cord and contact your dealer immediately. Do not try to repair your HDTV yourself.
- Avoid using dropped or damaged appliances. If your HDTV is dropped and the housing is damaged, the internal components may function abnormally. Unplug the power cord immediately and contact your dealer for repair. Continued use of your HDTV may cause fire or electric shock.
- Do not install your HDTV in an area with heavy dust or high humidity. Operating your HDTV in environments with heavy dust or high humidity may cause fire or electric shock.
- Follow instructions for moving your HDTV. Ensure that the power cord and any other cables are unplugged before moving your HDTV.
- When unplugging your HDTV, hold the AC/DC power adapter, not the cord. Pulling on the power cord may damage the wires inside the cord and cause fire or electric shock. When your HDTV will not be used for an extended period of time, unplug the power cord.
- To reduce risk of electric shock, do not touch the connector with wet hands.
- Insert batteries in accordance with instructions. Incorrect polarities may cause the batteries to leak which can damage the remote control or injure the operator.
- If any of the following occurs, contact the dealer:
 - The power cord fails or frays.
 - Liquid sprays or any object drops into your HDTV.
 - Your HDTV is exposed to rain or other moisture.
 - Your HDTV is dropped or damaged in any way.
 - The performance of your HDTV changes substantially.

Television Antenna Connection Protection

If an outside antenna/satellite dish or cable system is to be connected to the TV, make sure that the antenna or cable system is electrically grounded to provide some protection against voltage surges and static charges.

Article 810 of the National Electrical Code, ANSI/NFPA 70, provides information with regard to proper grounding of the mast and supporting structure, grounding of the lead-in wire to an antenna discharge unit, size of the grounding conductors, location of antenna discharge unit, connection to grounding electrodes, and requirements of the grounding electrode.

Lightning Protection

For added protection of the TV during a lightning storm or when it is left unattended or unused for long periods of time, unplug the TV from the wall outlet and disconnect the antenna or cable system.

Power Lines

Do not locate the antenna near overhead light or power circuits, or where it could fall into such power lines or circuits. Remember, the screen of the coaxial cable is intended to be connected to earth in the building installation.

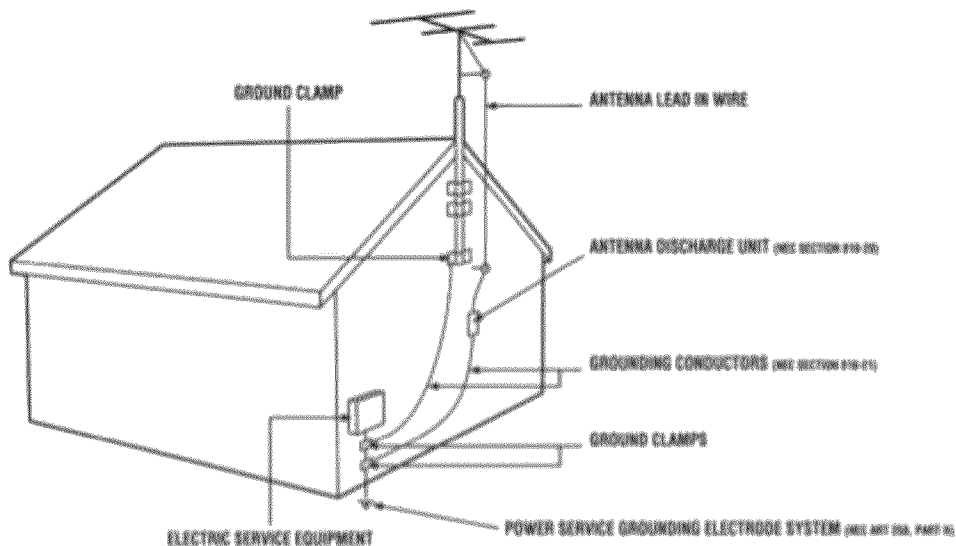

DTV Transition Advisory

The nationwide switch to digital television broadcasting will be complete on June 12, 2009, but your local television stations may switch sooner. After the switch, analog-only television sets that receive TV programming through an antenna will need a converter box to continue to receive over-the-air TV. Watch your local stations to find out when they will turn off their analog signal and switch to digital-only broadcasting. Analog-only TVs should continue to work as before to receive low power, Class A or translator television stations and with cable and satellite TV services, gaming consoles, VCRs, DVD players, and similar products.

For additional information, please contact the parties listed below, as appropriate:

FCC (US Federal Communications Commission)

Web: www.fcc.gov

Phone: 1-888-CALL-FCC (1-888-225-5322)

TTY: 1-888-TELL-FCC (1-888-835-5322)

Fax: 1-866-418-0232

E-mail: fccinfo@fcc.gov

NTIA (National Telecommunications and Information Administration)

Web: www.ntia.doc.gov

Phone: 1-888-DTV-2009 (1-888-388-2009)

List of US Television Stations: www.high-techproductions.com/usTVstations.htm

Note: Your TV comes with a built-in tuner capable of processing digital broadcasts. No extra converter box is needed.

Table of Contents

Chapter 1: Installing the TV	1
Installing the TV Stand	1
Installing the TV on a Wall.....	3
Chapter 2: Controls and Connections	4
Using the Jag Wheel Control.....	6
Using the Quick Menu	6
Remote Control Buttons	8
Replacing the Batteries	9
Activating the Bluetooth Remote Control	9
Using the Remote for Your Other Devices	10
Chapter 3: Completing the First-Time Setup	11
Chapter 4: Connecting Your Devices to the TV	14
Choosing the Correct Connection	15
Connecting Your Devices	16
Setting Up Your Network Connection	18
Connecting to A Wired Network.....	18
Connecting to a Wireless Network	18
Chapter 5: Using the On-Screen Menu	19
Changing the 3D Mode	19
Changing the Screen Aspect Ratio	20
Setting Up Closed Captioning	21
Changing the Appearance of Digital Closed Captions	21
Using the Sleep Timer	22
Adjusting the TV Settings	23
Changing the Input Source	23
Adjusting the Picture Settings.....	24
Adjusting the Advanced Picture Settings.....	25
Adjusting the Color Temperature	26
Adjusting the Picture Size and Position.....	26
Resetting the Picture Settings	27
Adjusting the Audio Settings.....	27
Adjusting the Advanced Audio Settings.....	28
Resetting the Audio Settings	29

Adjusting the Tuner Settings	29
Setting the Tuner Mode	29
Scanning for Channels	30
Adding New Channels	30
Skipping Channels	31
Changing the Audio Language	31
Changing the Names of the Inputs	32
Activating Game Mode	33
Using the Parental Controls	33
Accessing the Parental Controls Menu	33
Enabling or Disabling Program Ratings	34
Locking and Unlocking Channels	34
Blocking and Unblocking Content by Rating	34
Changing the Parental Control Passcode	35
Resetting the Content Locks	35
Changing the On-Screen Menu Language	36
Setting the Time Zone	36
Using Picture-In-Picture (PIP) / Picture-Outside-Picture (POP)	37
Choosing Inputs for the Main and Secondary Windows	37
Using the Network Connection Menu	38
Connecting to a Wireless Network	38
Changing the Advanced Network Settings	39
Testing Your Network Connection	39
Setting Up a Bluetooth Device	39
Using the Help Menu	40
Displaying System Information	40
Resetting the TV Settings	40
Restoring the TV to Factory Default Settings	41
Using Guided Setup	41
Using the Digital Episode Guide	42
Using the Info Window	42
Chapter 6: Using VIZIO Internet Apps	43
Using the VIA Shortcut Buttons	43
Using the VIA Dock	43
Moving an App on the VIA Dock	44
Adding a New App to the VIA Dock	44
Removing an App from the VIA Dock	44

Creating and Managing User Profiles	45
Creating an Owner PIN.....	45
Creating a New User Profile	45
Removing a User Profile.....	46
Restoring the VIA Dock to the Factory Default Settings.....	47
Chapter 7: Viewing 3D Content.....	48
What You Need to View 3D Content	48
How VIZIO 3D Works	49
Watching Full HD 3D Content	50
Watching SBS, TB, or Sensio 3D Content	50
Appendix A: Troubleshooting and Technical Support.....	51
The TV displays “No Signal”.....	51
There is no power.	51
There is a picture, but no sound.	51
The screen is black.....	52
The colors do not display correctly.	52
When I press buttons on the remote, nothing happens.....	52
The picture quality seems low.	52
The display has dots (pixels) that do not change color.	52
The display image does not cover the entire screen.....	52
My 3D content is displayed as two separate images.	53
I cannot access VIZIO Internet Apps, or my Apps are not working correctly.....	53
The TV displays, “No RGB Signal. Power will be turned off.”	53
The Jag Wheel is not responding.....	53
Appendix B: Specifications.....	54
Appendix C: Warranty.....	56
Appendix D: Legal & Compliance	58

Package Contents

Your VIZIO product has been carefully packed in a cardboard carton designed to protect it from damage. When you have opened the package, check that all of the contents are included and are in good condition.

Bluetooth® Remote Control
(with batteries)



VIZIO 3D HDTV with Stand

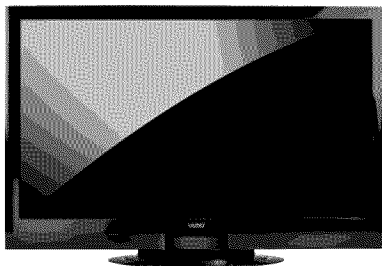

Cleaning Cloth

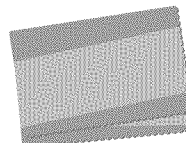

Power Cord



Quick Start Guide
and User Guide



Safety Cable

Package Contents



Save the carton and packing material. It may be useful if your device needs to be shipped for warranty service.

Chapter 1: Installing the TV

After removing the TV from the box and inspecting the package contents, you can begin installing the TV. Your TV can be installed in two ways:

- On a flat surface, using the included stand
- On a wall, using a VESA-standard wall mount (not included)

Installing the TV Stand

Your TV includes a stand designed to support the weight of the TV and keep it from falling over. However, the TV can still fall over if:

- It is placed on an uneven, unstable, or non-level surface
- It is pushed, pulled, or otherwise improperly moved
- If an earthquake occurs and the TV is not properly secured



Some models already have the base attached. If your TV already has the base attached, proceed to Step 3.

To install the TV stand:

1. Place the TV screen-down on a clean, flat surface. To prevent scratches or damage to the screen, place the TV on a soft surface, such as carpet, rug, or blanket.

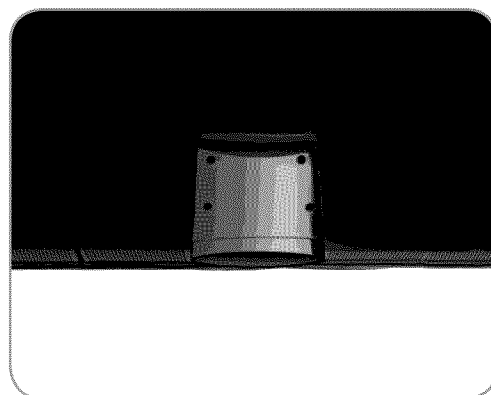

2. Slide the base plate into the slot on the stand, making sure the arrow on the stand base plate points toward the front of the TV.

If your stand has a wing screw on the bottom, tighten it securely.

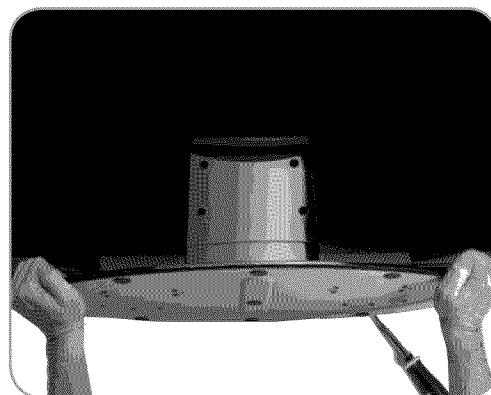

3. Move the TV with attached stand into an upright position and place on a flat, level, and stable surface.

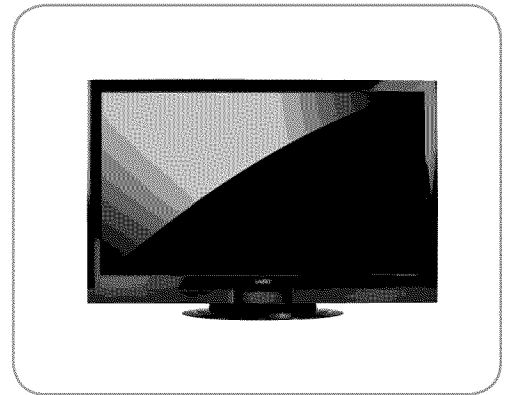

4. To help prevent the TV from falling over, attach one end of the included safety cable to the wall behind the TV. Attach the other end to one of the wall-mounting holes on the back of the TV.

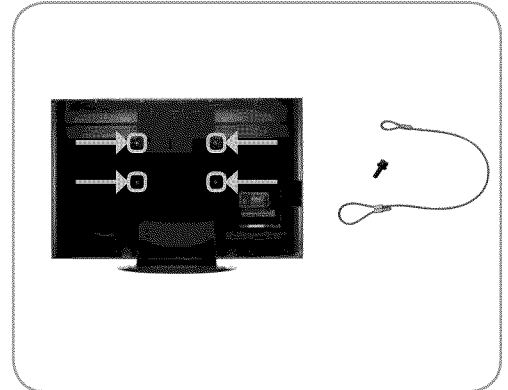

5. To ensure proper ventilation, leave 1" of space between the back of the TV and any other objects (walls, etc).

Installing the TV on a Wall

To mount your TV on a wall, you will need a wall mount. Consult the chart below to find the appropriate mount for your TV model:

	Screw Size	Screw Length	Screw Pitch	Hole Pattern
XVT3D424SV	M6	16.0 mm	1 mm	VESA standard 200 x 200 mm
XVT3D474SV	M6	16.0 mm	1 mm	VESA standard 200 x 200 mm
XVT3D554SV	M8	16.0 mm	1.25 mm	VESA standard 200 x 400 mm



Installing a TV on a wall requires lifting. To prevent injury or damage to the TV, ask someone to help you.

Be sure the mount you choose is capable of supporting the weight of the TV. After you have determined that you have the correct mount for your TV, you can begin the installation.

To install your TV on a wall:

1. Disconnect any cables connected to your TV.
2. Place the TV face-down on a clean, flat, stable surface. Be sure the surface is clear of debris that can scratch or damage the TV.
3. Remove the screws holding the stand to the TV.

Pull the stand away from the TV.

4. Attach your TV and wall mount to the wall, carefully following the instructions that came with the mount.

Chapter 2: Controls and Connections

2

Controls and Connections

Before the first-time setup, take a few moments to familiarize yourself with the various controls and connections. This will make the setup process much faster and your experience with the TV much more enjoyable!

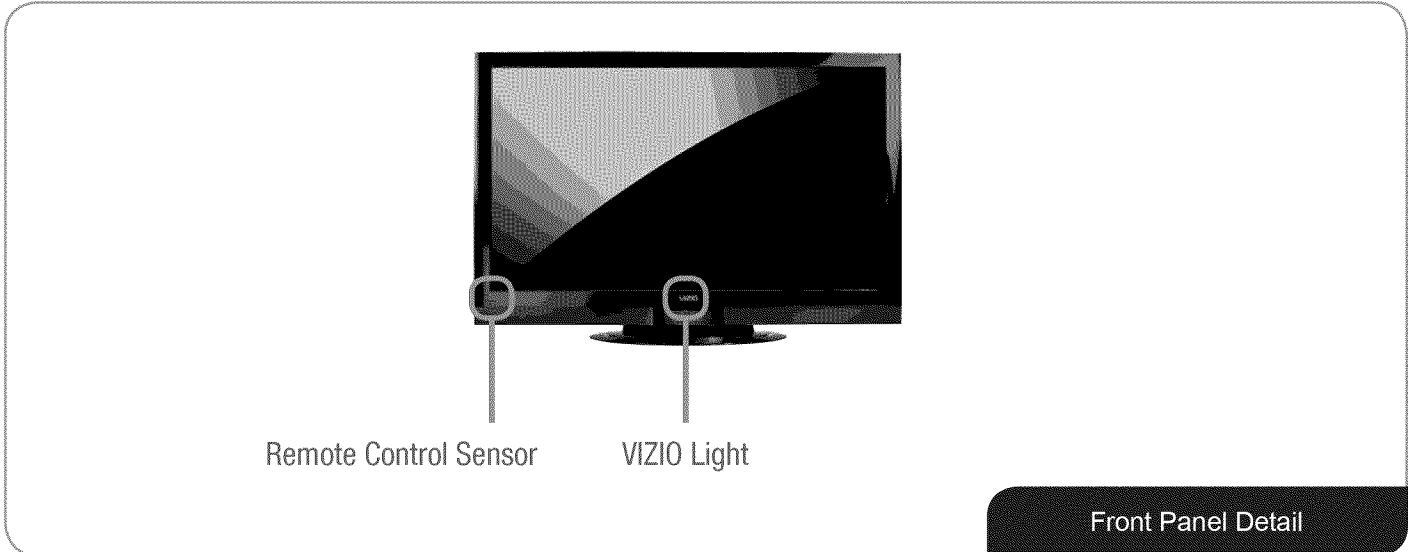

Remote Control Sensor Point the remote control directly at this sensor for the best response to the remote.

VIZIO Light The VIZIO logo lights up white when the TV is powered on.
The VIZIO logo turns orange when the TV is powered off.

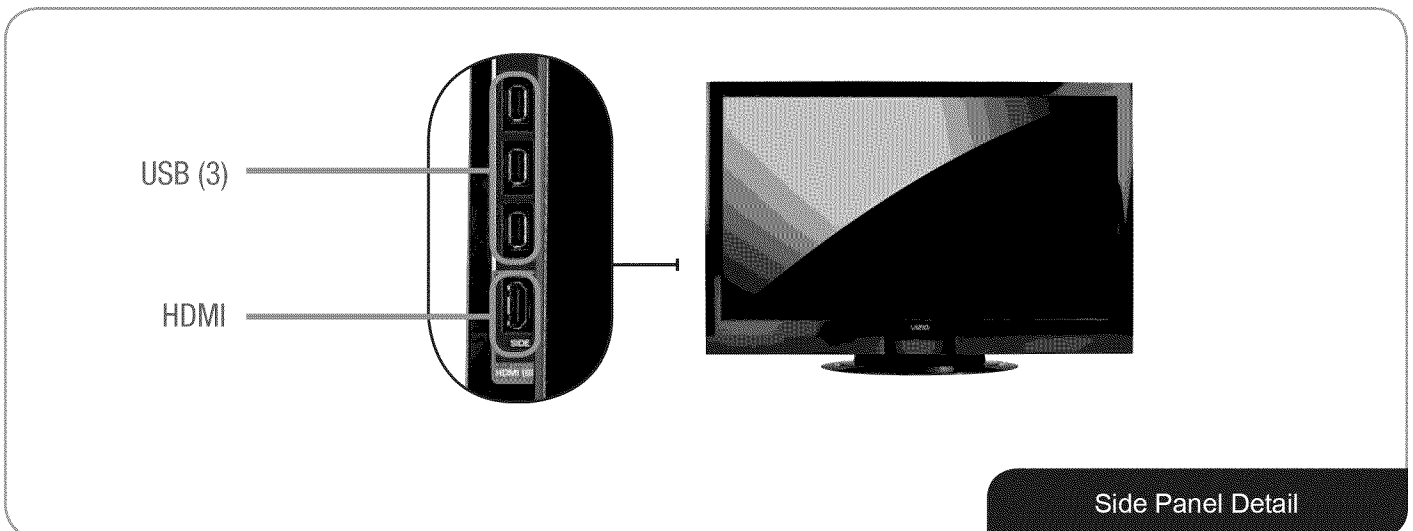

USB Ports (3) For service technician use only.

HDMI Port Connect external device (Blu-Ray/DVD player, game console, etc).

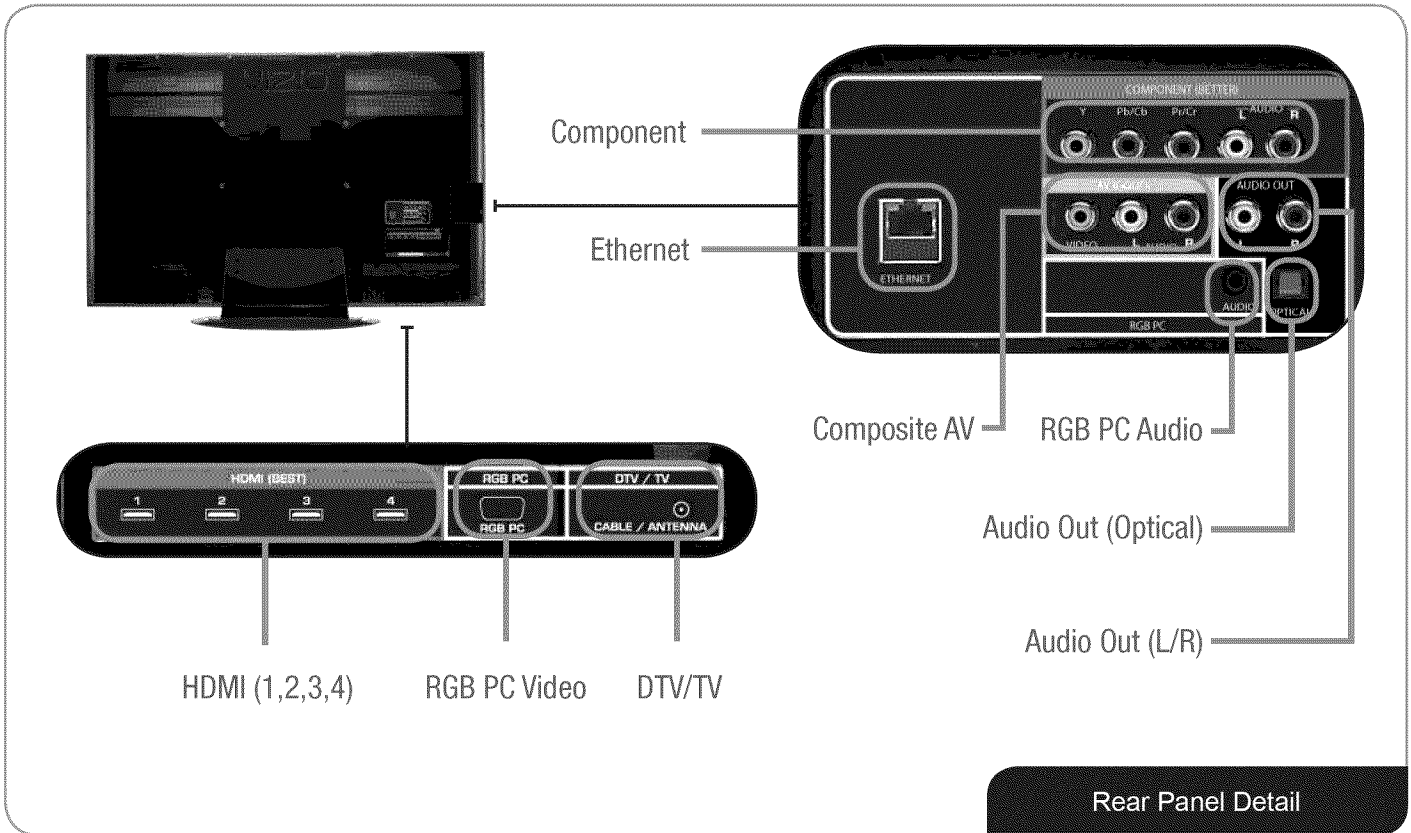

Rear Panel Detail

Ethernet Connect an ethernet cable to access a network or the Internet.

Composite AV Connect composite AV device.

Component Connect component video/audio devices.

Audio Out (L/R) Connect RCA audio device.

Audio Out (Optical) Connect to audio device (VIZIO sound bar, home theater system).

RGB PC Audio Connect 1/8" mini stereo connector from computer.

RGB PC Video Connect RGB cable from computer.

HDMI (1,2,3,4) Connect external devices (Blu-Ray, DVD, cable TV box, game console).

DTV/TV Connect coaxial cable for external antenna or cable TV.

Using the Jag Wheel Control

The Jag Wheel is an innovative, all-in-one control on the side of your HDTV that performs functions you might see as buttons on other TVs. Functions including volume up/down, power, input source, and channel up/down have been combined into a single Quick Menu controlled by the Jag Wheel.

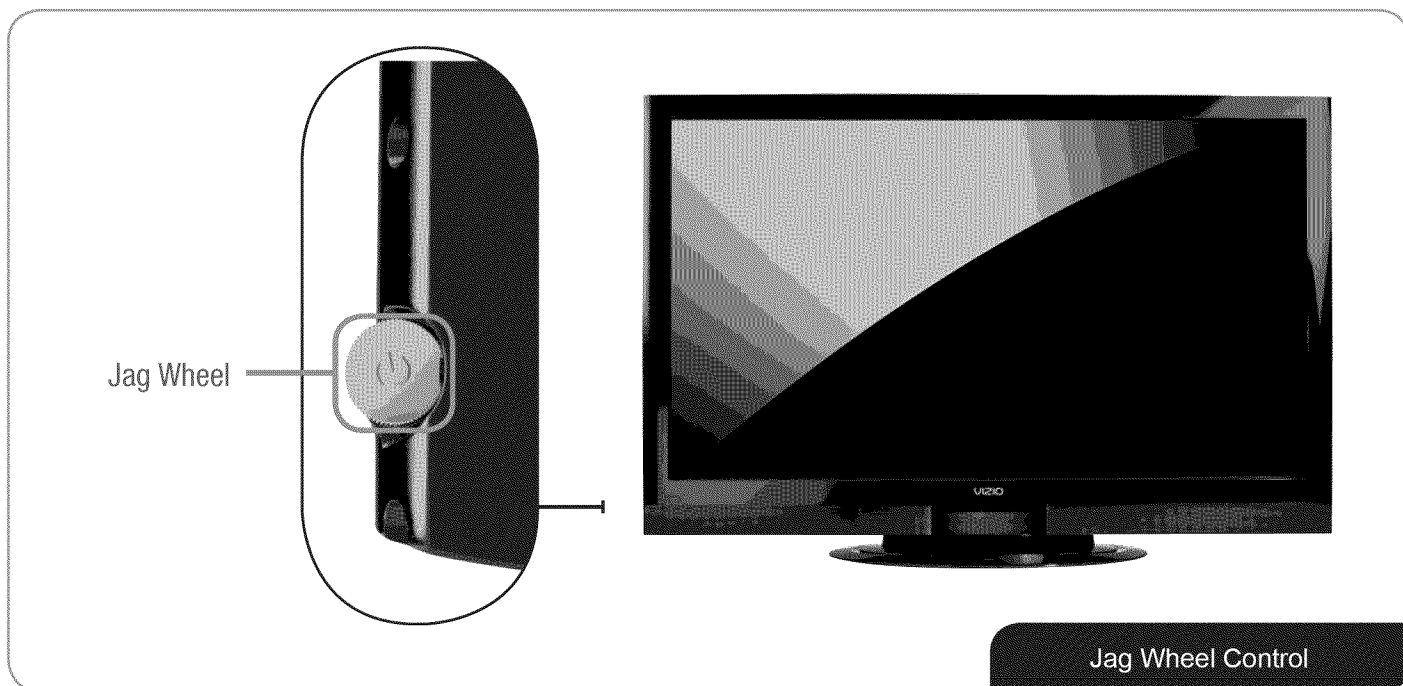

To power the TV on or off:

- Press the Jag Wheel once to turn the TV on.
- Press and hold the Jag Wheel for three seconds to turn the TV off.

To increase or decrease the volume, turn the Jag Wheel.

Using the Quick Menu

To open the Quick Menu, press and hold the Jag Wheel for two seconds. Turn the Jag Wheel to highlight a function. Press the Jag Wheel to select.

- **Volume** - Select to increase or decrease volume.
- **Channel** - Open the channel list and select a channel.
- **Input Source** - Change the input device.
- **Exit** - Close the Quick Menu.
- **Power Off** - Turn the TV off.

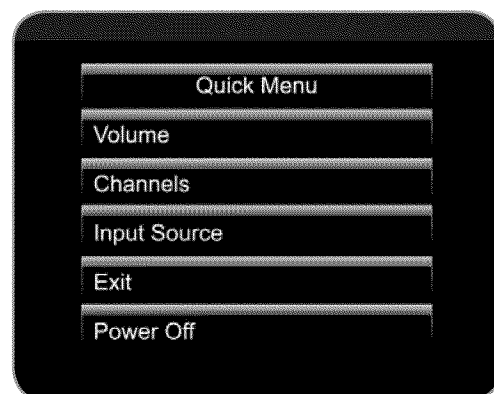

The Quick Menu closes automatically after 10 seconds if no activity is detected.

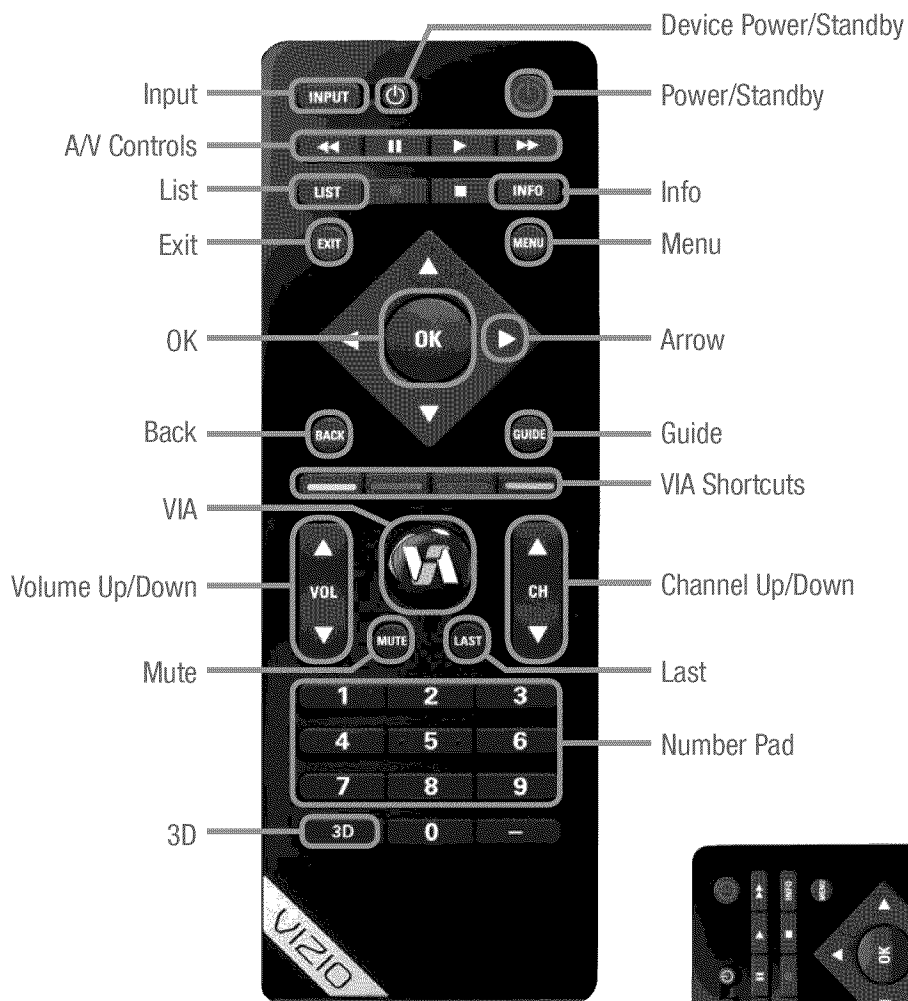

Arrow QUERTY Keypad

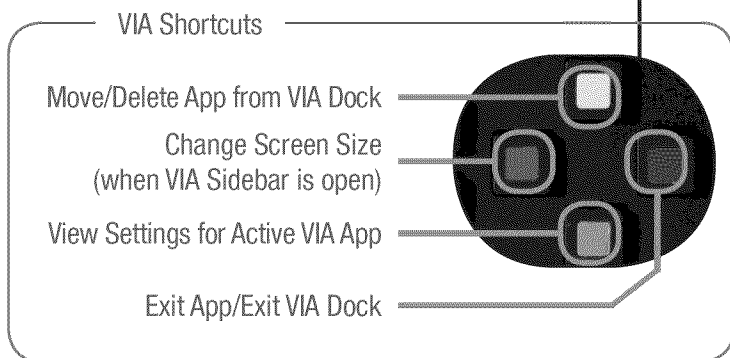

Bluetooth® Remote Control Buttons

(See opposite page for button descriptions.)

Remote Control Buttons

Power/Standby: Turn the TV on or off.

Info: Display the Info Window. See *Using the Info Window on page 42*.

Arrow: Navigate the on-screen menu and episode guide.

OK: Select highlighted menu option.

Menu: Display the on-screen menu. See *Chapter 5: Using the On-Screen Menu on page 19*.

Exit: Close the on-screen menu.

Back: Go to the previous on-screen menu options.

Guide: Display the episode guide (digital channels only). See *Using the Digital Episode Guide on page 42*.

Mute: Turn the sound off or on. When mute is activated, the TV's audio is turned off.

Last: Return to the channel last viewed.

Volume Up/Down: Increase or decrease the loudness of the TV's audio.

Channel Up/Down: Change the channel. With each press of the button, the channel will increase or decrease by one.

Number Pad: Use the number pad to manually enter a channel.

Input: Change the input device. With each press of the button, the TV will display a different input.

A/V Controls: Control external device (Blu-Ray or DVD player).

List: Display list of available channels.

VIA Shortcuts: Control VIZIO Internet Apps. See *Chapter 6: Using VIZIO Internet Apps on page 43*.

3D: Switch between 3D display modes.

QUERTY Keypad: Enter letters or numbers.

Device Power/Standby: Turn external device on or off.

VIA: Start VIA Internet Apps. See *Chapter 6: Using VIZIO Internet Apps on page 43*.

Replacing the Batteries

1. Remove the battery cover.
2. Insert two AA batteries into the remote control. Make sure that the (+) and (-) symbols on the batteries match the (+) and (-) symbols inside the battery compartment.
3. Replace the battery cover.

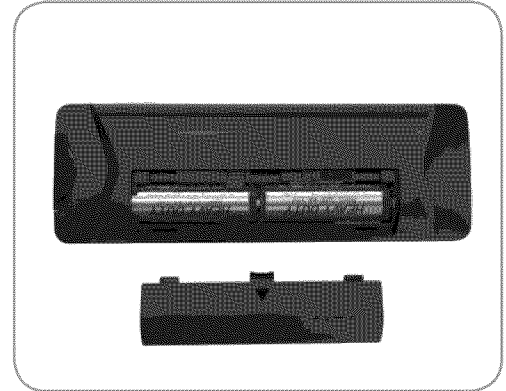

- **Use only a good quality battery.**
- **Inserting the battery incorrectly may result in cracking or leakage that may cause a fire or result in injury.**
- **Dispose of old or dead batteries in accordance with local hazardous waste regulations.**
- **Keep batteries away from children and pets.**

Activating the Bluetooth Remote Control

Your TV includes a remote control that does not require a direct line of sight to the TV. Because the remote uses Bluetooth to transmit your commands, as long as you are within range of the TV (30 feet), the remote will work even if it is not pointed at the TV.

However, until you *activate* the Bluetooth remote control, the remote will only work when pointed directly at the TV (30 foot range) with no intervening obstacles.



If you have already activated the remote in the first-time setup using the Setup App, then you do not have to activate the remote again.

To activate the Bluetooth remote control:

1. Press the MENU button on the remote.
2. Select **Bluetooth** and press **OK**.
3. Select **Pair Device** and press **OK**.
4. Hold down the **Record** and **Green VIA Shortcut** buttons for five seconds.
5. Select **Start searching for devices** and press **OK**. The TV begins to search for the remote.
6. When the remote is found, the TV displays a success message.

Using the Remote for Your Other Devices

The included remote can be used as a universal remote to control your other devices.

See *Using Guided Setup* on page 41 to set up the remote for use with your other devices.



- **The remote control should be kept dry and away from heat sources. Avoid humidity.**
- **If the DTV responds erratically to the remote control or does not respond at all, the battery may need to be replaced.**
- **When storing the remote control, remove the batteries.**
- **Do not take batteries apart, heat them, or throw them into a fire.**
- **Do not strike, throw, or drop the remote control.**
- **Do not attempt to clean the remote control with a volatile solvent. To clean the remote, wipe it with a clean, damp cloth.**

Chapter 3: Completing the First-Time Setup

The first time you turn on the TV, the Setup App will guide you through each of the steps necessary to get your TV ready for use.

Before you begin the first-time setup:

- Your TV should be installed. See *Chapter 1: Installing the TV on page 1*.
- Your devices should be connected. See *Chapter 2: Controls and Connections on page 4*.
- If you have a wireless network, have the network key ready.
- If you are connecting to your network with an ethernet cable, connect it to the ethernet port on the TV.

To complete the first-time setup:

1. Press the **Power/Standby** button on the remote. The TV powers on and the Setup App starts.

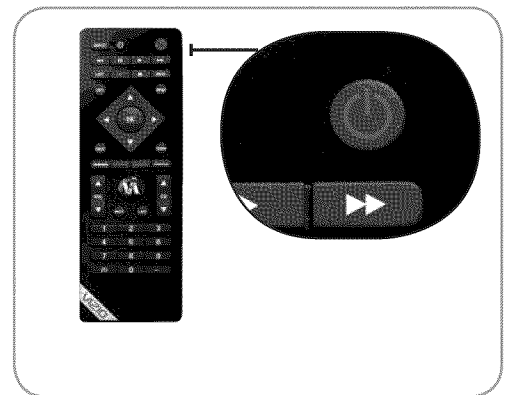

2. Activate the remote by pressing **Record** and the **Green VIA Shortcut** button for 5 seconds, then highlight **Begin Activation** and press **OK**.

Wait for the remote to be found.

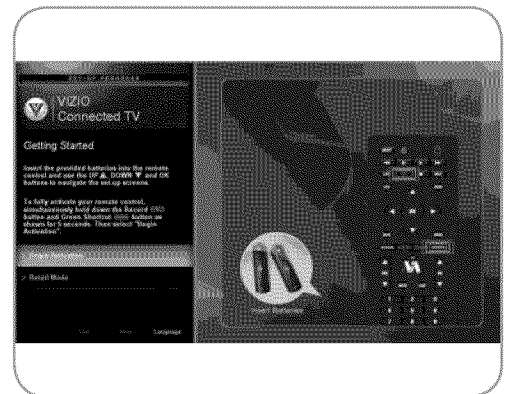

3. When the remote is found, use the **Arrow Up/Down** buttons on the remote to highlight **Connect to the Internet** and press **OK**.



4. Use the **OK** and **Arrow Up/Down** buttons on the remote to read and accept the Terms of Service and Privacy Policy for Yahoo! TV Widgets.

When you are finished, highlight **Next** and press **OK**.

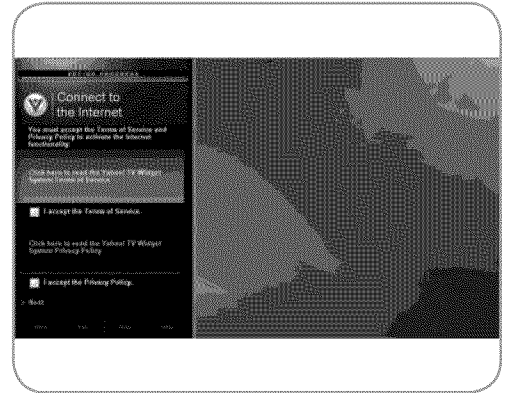

5. Select the name of your wireless network from the list of available networks and press **OK**.

If the TV is connected to your network via an ethernet cable, you will not see this screen.

Enter the network key using the **QUERTY Keypad** on the remote, then highlight **Connect** and press **OK**.

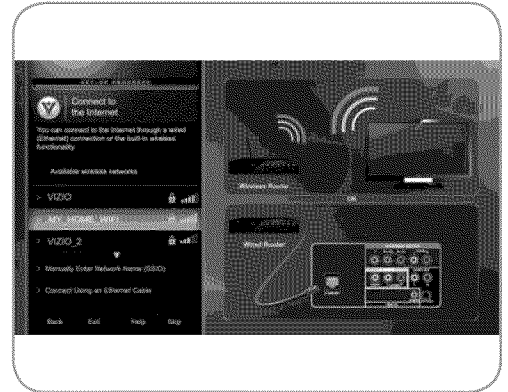

6. Enter your First Name, Last Name, Phone Number, ZIP Code, and E-mail Address using the **QUERTY Keypad** on the remote.

Highlight **Next** and press **OK**.



7. Choose the input to which your TV signal is connected.

Answer the on-screen questions about your TV connection using the **Arrows** and **OK** button on the remote.



8. Choose the device you would like to connect.

Answer the on-screen questions about your TV connection using the **Arrows** and **OK** button on the remote.



9. When you have finished adding devices, highlight **Exit to Live TV** and press **OK**.

Chapter 4: Connecting Your Devices to the TV

Your 3D HDTV can be easily connected to an external device:

- DVD or Blu-Ray player
- Video game console
- Cable box
- External antenna
- Or other device

To connect an external device to the 3D HDTV, you must first verify that the external device has one of the following types of video ports:

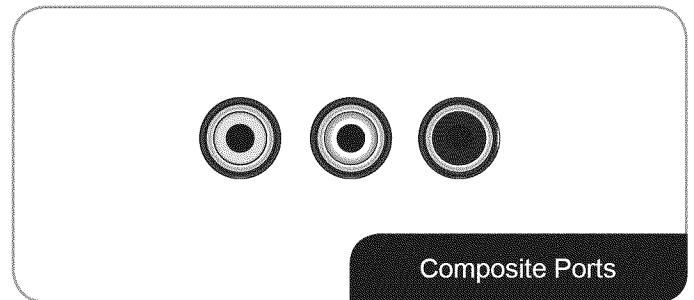
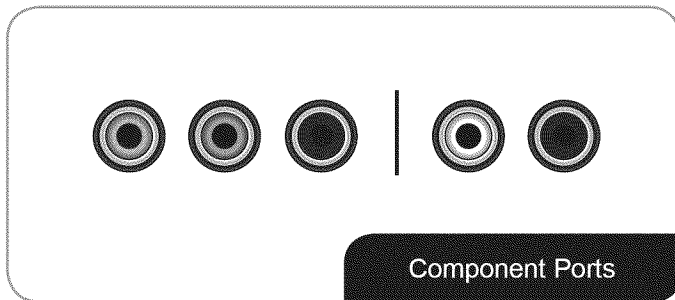
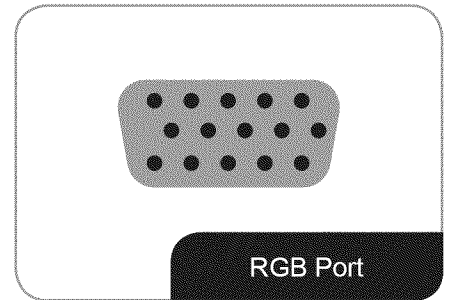
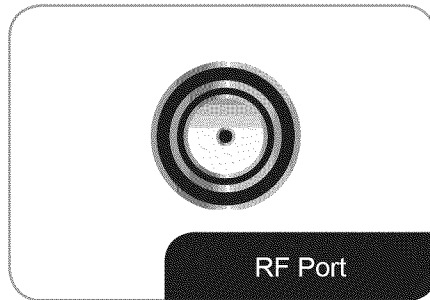
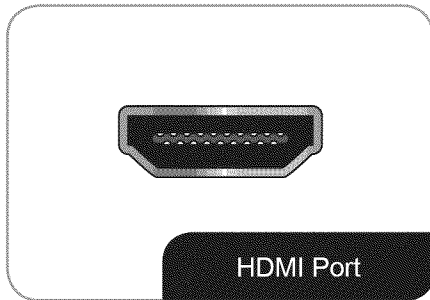

Choosing the Correct Connection

Use the table below to choose the connection with the highest possible picture quality. Use a digital connection when possible.

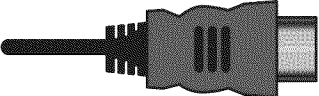
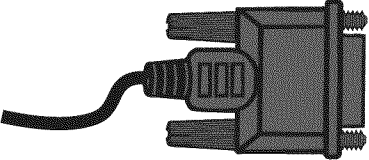
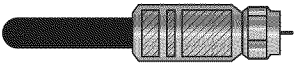
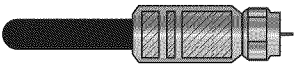
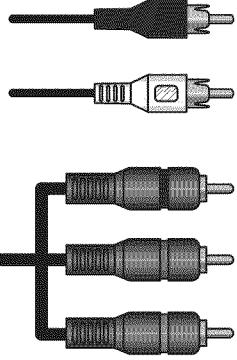
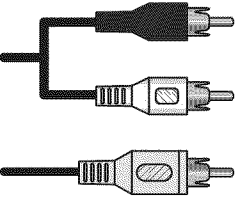
Picture Quality	Connector Image	Connector Name	Digital/Analog
BEST		HDMI	Digital
		RGB	Analog
		RF/Coaxial	Digital
BETTER		RF/Coaxial	Analog
		Component	Analog
		Composite	Analog

Connecting Your Devices

Once you have determined the best available connection type on both your device and the TV, ensure you have the corresponding cable.

For the port locations on your TV, see *Chapter 2: Controls and Connections on page 4*.

To connect a device to the TV:

1. Ensure both the TV and your device are off.
2. Connect the device and the TV. Use the best available connection. See *Choosing the Correct Connection on page 15* and the *Device Connection Chart* at right.

Ensure each end of the cable is securely connected.

3. Turn the TV on by pressing the **Power/Standby** button on the remote.
4. Turn your device on.
5. When you are ready to use your newly connected device, press the **INPUT** button on the remote and select the connection type (HDMI, RGB, etc) from the on-screen menu. Press **OK**.
6. Check the list of devices/connection types below for special instructions:

Cable TV (without cable box/directly from wall)

Perform a channel scan. See *Performing a Channel Scan*.

RGB

Make sure the desktop resolution on the PC is set to 1920 x 1080. Set the Screen Mode to **Normal**. See *Changing the Screen Aspect Ratio on page 20*.

DVD Player with DVI

Connect left (white) and right (red) audio cables to the **L** and **R** ports next to the HDMI ports on the TV.

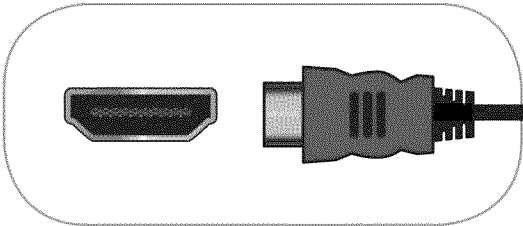
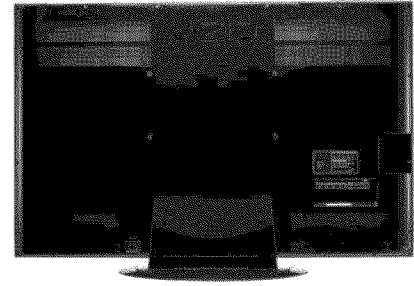
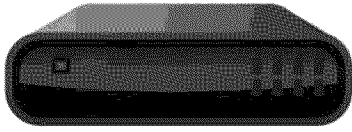

HDMI / DVI

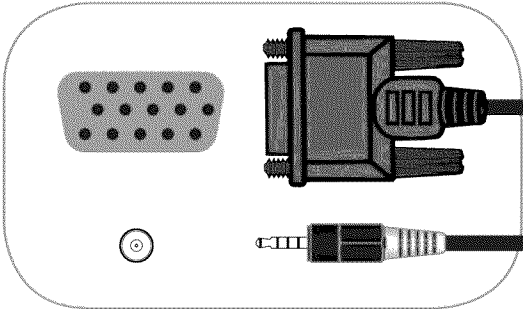
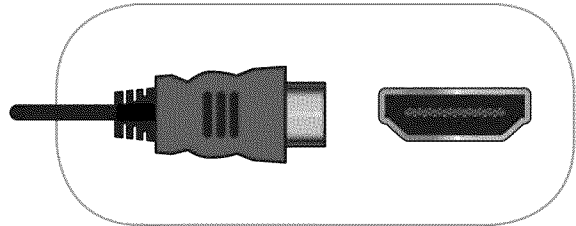

RGB

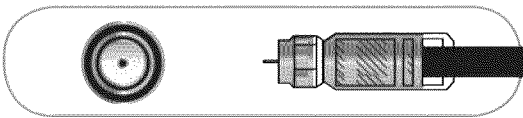
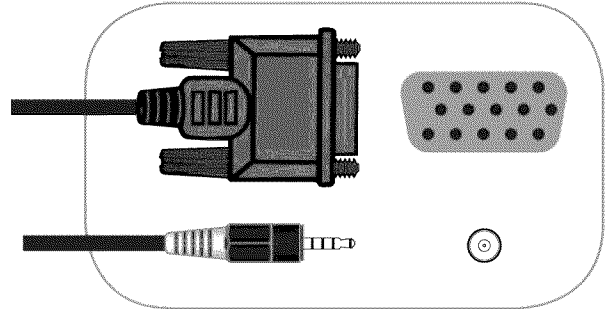

RF / Coaxial

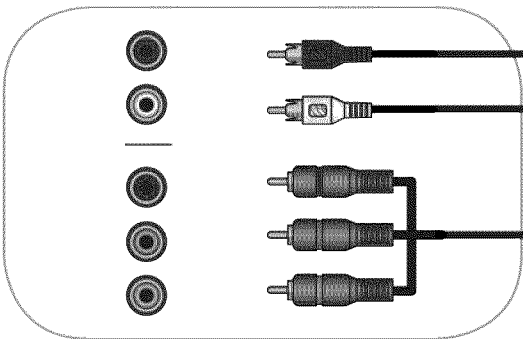
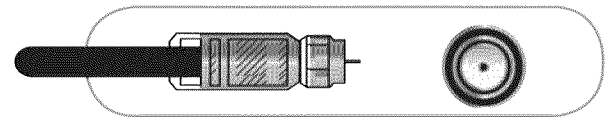

Component

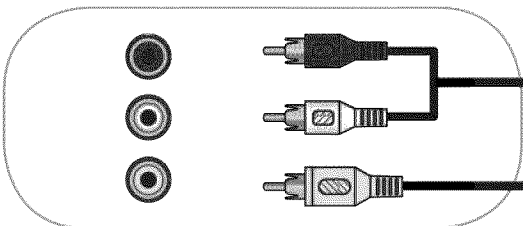
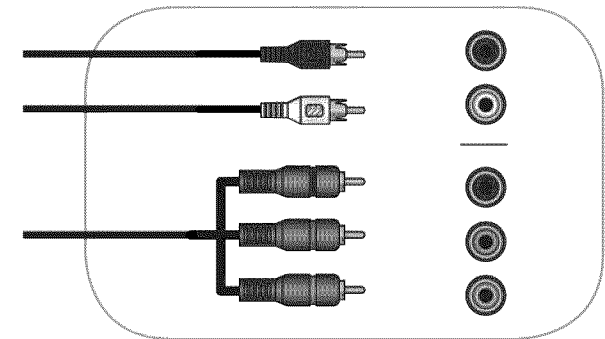

Composite AV

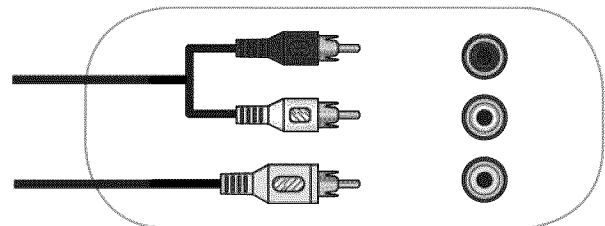

Setting Up Your Network Connection

Your TV is internet-ready, and can be connected to your home network in two ways:

- Wired, using the RJ45 (ethernet) connector on the back panel
- Wirelessly, using your home wireless network

Once you have connected to your home network and the Internet, you can use VIA apps to deliver popular online content to your TV.

Connecting to A Wired Network

To connect to a wired network:

1. Ensure you have:
 - An ethernet cable long enough to reach your TV
 - A router or modem with an available ethernet port
 - A high-speed internet connection
2. Connect your ethernet cable to the router and to the ethernet port on the back of the TV.
3. Use the Guided Network Setup to configure the TV. *See Using Guided Setup on page 41.*

Connecting to a Wireless Network

To connect to a wireless network:

1. Ensure you have:
 - A router broadcasting a high-speed wireless signal (wireless-n recommended)
 - A high-speed internet connection
2. Use the Guided Network Setup to configure the TV. *See Using Guided Setup on page 41.*

Chapter 5: Using the On-Screen Menu

Your TV features an easy-to-use on-screen menu.

To open the on-screen menu, press the **MENU** button on the remote. You can also open the on-screen menu by pressing the **VIA** button and selecting **HDTV Settings** from the VIA Dock, then pressing **OK**.

From this menu, you can:

- Change the 3D mode
- Change the screen aspect ratio
- Set up closed captioning
- Activate the sleep timer
- Adjust the TV settings
- Adjust PIP (Picture-in-Picture) controls
- Adjust Network Settings
- Pair Bluetooth devices
- Access the Help menu



While navigating the on-screen menu, you can press the BACK button at any time to return to the previous menu screen.

Changing the 3D Mode

To correctly view 3D content, you must set the 3D mode to match the 3D format of the content.

To change the 3D mode:

1. Press the **MENU** button on the remote. The on-screen menu is displayed.
2. Use the **Arrow** buttons on the remote to highlight the **3D** icon and press **OK**. The Output Mode menu is displayed.
3. If viewing 2D content, highlight **2D** and press **OK**. The menu closes.

If viewing 3D content, highlight **3D** and press **OK**.

4. Select the 3D mode to match the content you are watching:

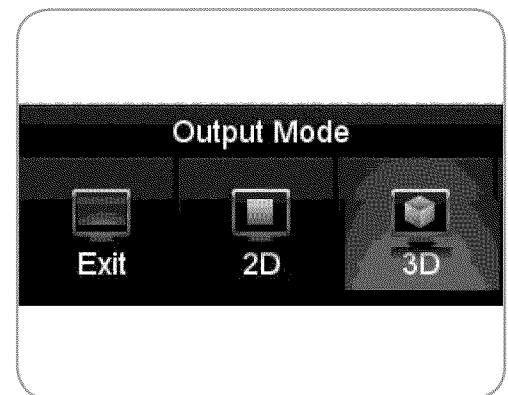

SBS - Displays side-by-side 3D.

TB - Displays top/bottom 3D.

Sensio - Displays Sensio 3D.

5. The TV displays, "3D viewing mode enabled. Please wear 3D glasses." Put on your 3D glasses and turn them on.



You can also quickly change the 3D display mode by pressing the 3D button on the remote.

Changing the Screen Aspect Ratio

The TV can display images in four different modes: Wide, Zoom, Normal, and Stretch. Each mode displays the picture differently.

To change the screen aspect ratio:

1. Press the **MENU** button on the remote.
2. Use the **Arrow** buttons to highlight the **Wide** icon. Press **OK**.
3. Use the **Arrow** buttons to highlight your desired screen mode and press **OK**:

- **Wide** mode stretches a 4:3 aspect ratio picture to the edges of the screen. Since the picture is being stretched, the display image may appear distorted. If the program is already formatted for widescreen viewing (1.85:1 or 2.35:1), then black bars will appear on the top and bottom of the display image.
- **Zoom** mode expands images with black bars to fit the screen.
- **Normal** mode preserves an original 4:3 aspect ratio. Since the 4:3 aspect ratio is not large enough to fill the TV's screen, black bars are added to the left and right of the display image.
- **Stretch** mode expands the display image to fill the screen. Images may appear wider than intended. If you are watching widescreen (1.85:1 or 2.35:1) content, black bars will still appear on the top and bottom of the display image.

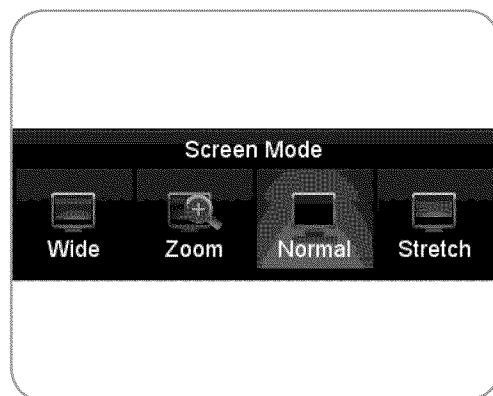

Setting Up Closed Captioning

Your TV can display closed captions for programs that include them. Closed captions display a transcription of a program's dialogue.



If the program you are viewing is not being broadcast with closed captions, the TV will not display them.

To activate or deactivate closed captions:

1. Press the **MENU** button on the remote. The on-screen menu is displayed.
2. Use the **Arrow** buttons on the remote to highlight the **CC** icon and press **OK**. The Closed Caption menu is displayed.
3. Use the **Arrow** buttons on the remote to highlight the type of closed captions you wish to see:
 - **Analog Closed Caption** for analog (NTSC) TV channels.
 - **Digital Closed Caption** for digital (ATSC) TV channels.
4. After highlighting the type of closed captions you wish to see, use the **Left/Right Arrow** buttons on the remote to select the caption channel you wish to display, then press **EXIT**.

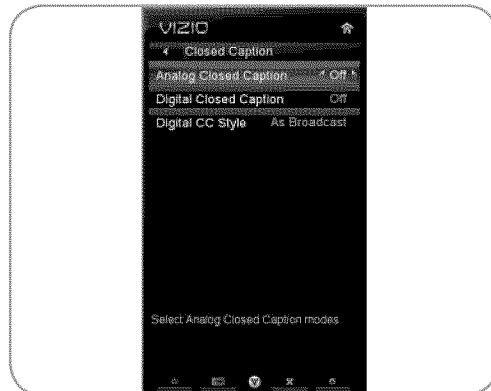

Caption channels usually display different languages. For example, CC1 may display English captions and CC2 may display Spanish captions.

Changing the Appearance of Digital Closed Captions

Digital closed captions can be displayed according to your preference.

To change the appearance of digital closed captions:

1. From the Closed Caption menu, use the **Arrow** buttons to highlight **Digital CC Style**.
2. Use the **Left/Right Arrow** buttons on the remote to select **Custom**, then press **OK**. The Digital CC Style menu appears.
3. Use the **Up/Down Arrow** buttons on the remote to highlight the setting you wish to change, then use the **Left/Right Arrow** buttons to change the setting:
 - **Caption Style** - Choose **Auto** to keep default settings or **Custom** to manually change each setting.



- **Text Size** - Adjust the size of the text.
- **Color** - Change the color of the text.
- **Opacity** - Change the transparency of the text.
- **BG Color** - Change the background color.
- **BG Opacity** - Change the transparency of the background.
- **Window Color** - Change the edge color.
- **Window Opacity** - Change the edge type.

4. When you are satisfied with the appearance of the closed captions, press the **EXIT** button on the remote.

Using the Sleep Timer

When activated, the TV's sleep timer will turn the TV off after a set period of time.

To use the sleep timer:

1. Press the **MENU** button on the remote. The on-screen menu is displayed.
2. Use the **Arrow** buttons on the remote to highlight the **Sleep Timer** icon and press **OK**. The Sleep Timer menu is displayed.
3. Use the **Up/Down Arrow** buttons on the remote to highlight **Timer** and press **OK**. The Timers menu is displayed.
4. Use the **Up/Down Arrow** buttons on the remote to highlight the period of time after which you want the TV to turn off. Press **OK**, then press **EXIT**.

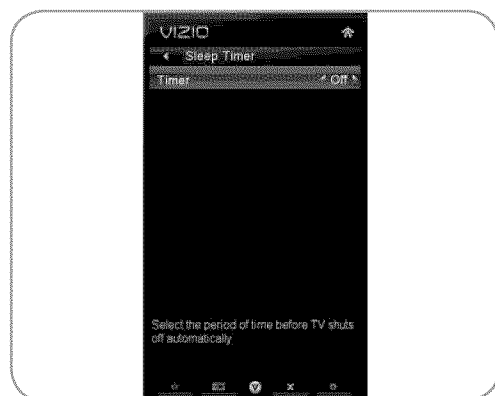

Adjusting the TV Settings

From the TV Settings Menu, you can:

- Change the input source
- Adjust the picture settings
- Adjust the audio settings
- Adjust the tuner settings
- Name device inputs
- Activate Game Mode
- Set the parental controls
- Change the on-screen menu language
- Set the time

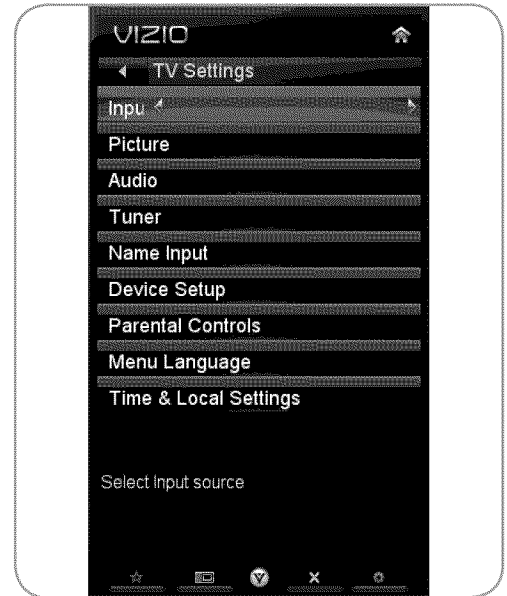

Changing the Input Source

External devices such as DVD players, Blu-Ray Players, and video game consoles can be connected to your TV. To use one of these devices with your TV, you must first change the input source in the on-screen menu.

For instructions on connecting external devices, see *Chapter 4: Connecting Your Devices to the TV on page 14*.

To change the input device:

1. Press the **MENU** button on the remote. The on-screen menu is displayed.
2. Use the **Arrow** buttons on the remote to highlight the TV Settings icon and press **OK**. The TV Settings menu is displayed.
3. Use the **Up/Down Arrow** buttons on the remote to highlight the Input Source and press **OK**. The Input Source Selection menu is displayed.
4. Use the **Up/Down Arrow** buttons on the remote to highlight the input source you wish to display. Press **OK**, then press **EXIT**.

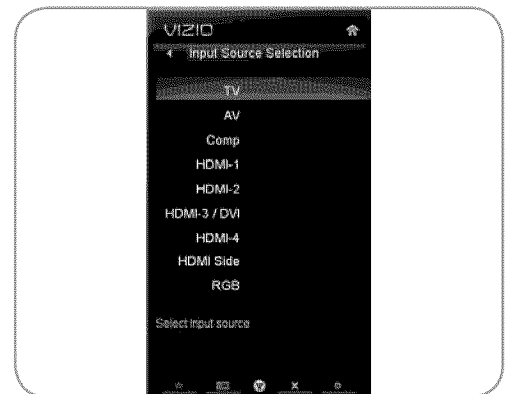

Adjusting the Picture Settings

Your TV display can be adjusted to suit your preferences and viewing conditions.

To adjust the picture settings:

1. Press the **MENU** button on the remote. The on-screen menu is displayed.
2. Use the **Arrow** buttons on the remote to highlight the **TV Settings** icon and press **OK**. The TV Settings menu is displayed.
3. Use the **Up/Down Arrow** buttons on the remote to highlight **Picture** and press **OK**. The Picture Settings menu is displayed.
4. Use the **Arrow** buttons on the remote to highlight **Picture Mode**, then use the **Left/Right Arrow** buttons to change the picture mode:
 - **Standard** mode sets the various picture settings to values that will produce the best picture in the most cases. This is the recommended setting.
 - **Movie** mode sets the picture settings to values perfect for watching a movie in a dark room.
 - **Game** mode optimizes the picture settings for displaying game console output.
 - **Vivid** mode sets the picture settings to values that produce a brighter, more vivid picture.
 - **Football, Golf, Basketball, and Baseball** modes optimize the picture settings for their respective sports. Also try these modes for other sports.
 - **Custom** picture mode allows you to manually change each of the picture settings:



Backlight - Adjusts the LED brightness to affect the overall brilliance of the picture. This option is not available unless Ambient Light Sensor is set to **OFF**. See *Adjusting the Advanced Picture Settings* on page 25.

Brightness - Adjusts the black level of the picture. When this setting is too low, the picture may be too dark to distinguish details. When this setting is too high, the picture may appear faded or washed out.

Contrast - Adjusts the white level of the picture. When this setting is too high, the picture may appear dark. When this setting is too low, the picture may appear faded or washed out. If the setting is too high or too low, detail may be difficult to distinguish in dark or bright areas of the picture.

Color - Adjusts the intensity of the picture colors.

Tint - Adjusts the hue of the picture. This setting is useful in adjusting the flesh tones in the picture. If flesh appears too orange, reduce the level of color before adjusting tint.

Sharpness - Adjusts the edge sharpness of picture elements. It can be used to sharpen non-HD (high definition) content; however, it will not produce detail that does not otherwise exist.

Adjusting the Advanced Picture Settings

To adjust the advanced picture settings:

1. From the Picture Settings menu, use the **Arrow** buttons to highlight **More**, then press **OK**.
2. Use the Arrow buttons on the remote to highlight **Advanced Picture**, then press **OK**. The Advanced Picture menu is displayed.
3. Use the **Arrow** buttons to highlight the setting you wish to adjust, then press **Left/Right Arrow** to change the setting:



Smooth Motion Effect - Activates Smooth Motion™ motion estimation/motion compensation, which suppresses motion judder, or “stuttering” of the image when the camera moves across a scene horizontally. Select **Off**, **Low**, **Middle**, or **High**.

Real Cinema Mode - Allows selection of the type of compensation used for the Smooth Motion™ effect. Select **Off**, **Precision** or **Smooth**.

Noise Reduction - Diminishes artifacts in the image caused by the digitizing of image motion content. Select **Off**, **Low**, **Medium**, or **High**.

Color Enhancement - Reduces oversaturation of some colors and improves flesh tones. Select **Off**, **Normal**, **Rich Color**, **Green/Flesh**, and **Green/Blue**.

Adaptive Luma - Adjusts the average brightness of the picture to compensate for large areas of brightness. Select **Off**, **Low**, **Medium**, **Strong**, or **Extend**.

Film Mode - Optimizes the picture for watching film. Select **Auto** or **Off**.

Smart Dimming - Improves the contrast ratio of the screen by adjusting the backlight intelligently. Select **Off** or **On**.

Ambient Light Sensor - Detects the light levels in the room to optimize the brightness of the TV's backlight. Select **Low**, **Middle**, **High**, or **Off**. When the Ambient Light Sensor is on, you will be unable to manually adjust the backlight.

4. When you have finished adjusting the Advanced Picture Settings, press the **EXIT** button on the remote.

Adjusting the Color Temperature

Adjusting the color temperature will change the “warmness” or “coolness” of the white areas of the picture.

To adjust the color temperature:

1. From the Picture Settings Menu, use the **Arrow** buttons to highlight **More**, then press **OK**.
2. Use the Arrow buttons on the remote to highlight **Color Temperature**, then press **OK**. The Color Temperature menu is displayed.
3. Use the **Arrow** buttons on the remote to highlight **Color Temperature**, then use the **Left/Right Arrow** buttons to change the color temperature preset:

- **Normal** is optimized for television viewing.
- **Cool** produces a blue-hued picture.
- **Computer** optimizes the picture for use as a PC monitor.
- **Custom** allows you to manually change each of the color temperature settings:

Red/Green/Blue Gain - Adjusts the amount of each color in the display.

Red/Green/Blue Offset - Adjusts the position of each color in the display.

4. If you want to reset the color temperatures to the factory default settings, highlight **Reset Color Temperature** and press **OK**.
5. When you have finished adjusting the color temperature, press the **EXIT** button on the remote.

Adjusting the Picture Size and Position

When displaying an image from the HDMI or RGB input, the size and position of the display image can be adjusted.

To adjust the picture size and position:

1. Ensure the input is set to **HDMI** or **RGB**.
2. From the Picture Settings menu, use the **Arrow** buttons to highlight **More**, then press **OK**.
3. Use the Arrow buttons on the remote to highlight **Size & Position**, then press **OK**. The Size & Position menu is displayed.

Use the **Arrow** buttons to highlight the setting you wish to adjust, then press **Left/Right Arrow** to change the setting:

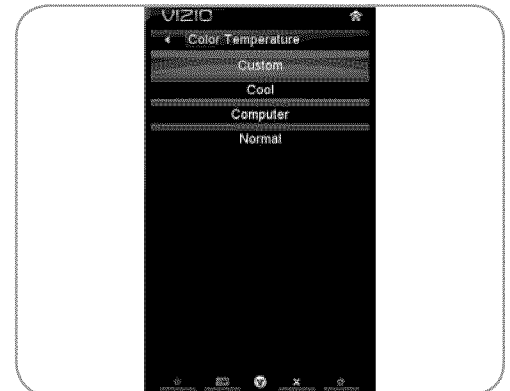

Auto Adjust - Automatically adjusts display image to optimal size and position. (RGB input only.)

Horiz. Position - Adjusts the horizontal (left/right) position of the display image.

Vertical Position - Adjusts the vertical (up/down) position of the display image.

Horizontal Size - Adjusts the width of the display image.

Fine Tune - Adjusts the height of the display image. (RGB input only.)

4. When you have finished adjusting the color temperature, press the **EXIT** button on the remote.

Resetting the Picture Settings

To reset the picture settings to the factory default settings:

1. From the Picture Settings menu, use the **Arrow** buttons to highlight **More**, then press **OK**.
2. Use the Arrow buttons on the remote to highlight **Reset Picture Mode**, then press **OK**. The TV displays, “Are you sure you want to RESET Picture Settings to the factory defaults?”
3. Highlight **Yes** and press **OK**.
4. Press the **EXIT** button on the remote.

Adjusting the Audio Settings

To adjust the audio settings:

1. Press the **MENU** button on the remote. The on-screen menu is displayed.
2. Use the **Arrow** buttons on the remote to highlight the TV Settings icon and press **OK**. The TV Settings menu is displayed.
3. Use the **Arrow** buttons on the remote to highlight **Audio** and press **OK**. The Audio Settings menu is displayed.
4. Use the **Arrow** buttons to highlight the setting you wish to adjust, then press **Left/Right Arrow** to change the setting:



Audio Mode - Change the preset equalizer. Select **Flat**, **Rock**, **Pop**, **Classical**, or **Jazz**.

Balance - Adjusts the loudness of the audio output from the left and right speakers.

Lip Sync - Adjusts the synchronization between the display image and the accompanying audio track.

TV Speakers - Turns the built-in speakers on or off.

Advanced Audio - See *Adjusting the Advanced Audio Settings* on page 28.

Bluetooth Audio - Turns the built-in Bluetooth transmitter on or off.

Equalizer Settings - Adjusts the boost or attenuation of different frequencies. (This setting is only available when SRS TruSurround HD is set to Off.)

Reset Audio Mode - Restores the audio settings to the factory defaults. See *Resetting the Audio Settings* on page 29.

5. When you have finished adjusting the audio settings, press the **EXIT** button on the remote.

Adjusting the Advanced Audio Settings

To adjust the advanced audio settings:

1. From the Audio Settings Menu, use the **Arrow** buttons to highlight **Advanced Audio**, then press **OK**. The Advanced Audio menu is displayed.
2. Use the **Arrow** buttons to highlight the setting you wish to adjust, then press **Left/Right Arrow** to change the setting:

SRS TruSurround HD - TruSurround HD™ is a robust multichannel virtualization technology developed by SRS Labs that provides an enhanced listening experience unlike any other technology that has been offered for a two speaker playback environment. Select **On** or **Off**.

SRS TruVolume - TruVolume™ intelligently normalizes volume fluctuations due to television commercials or channel changes. Select **On** or **Off**.

Digital Audio Out - Changes the type of processing for the Optical output when connected to a home theater audio system. Select **Dolby Digital**, **PCM**, or **Off**.

Analog Audio Out - Sets the volume control properties for the analog RCA (red/white) connectors when connected to a home theater audio system. Select **Variable** to control the external speakers' volume from the TV's volume controls, or select **Fixed** to control the external speakers' volume from your home theater system controls.

Audio Controls - Select the device controlled by the VIZIO remote. Select **TV** to force the remote to control the TV's audio, or select **External** to force the remote to control the

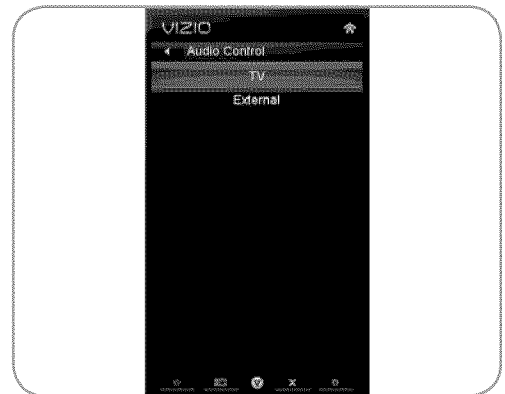
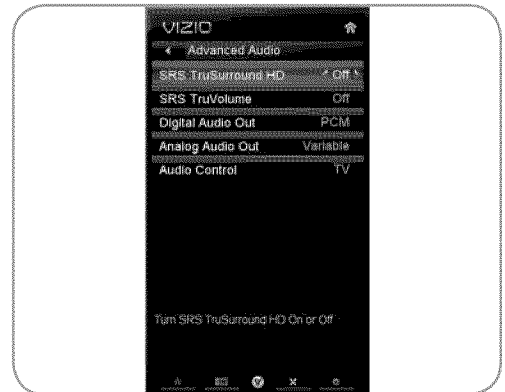

external audio device.

3. When you have finished adjusting the advanced audio settings, press the **EXIT** button on the remote.

Resetting the Audio Settings

To reset the audio settings to the factory default settings:

1. Press the **MENU** button on the remote. The on-screen menu is displayed.
2. Use the **Arrow** buttons on the remote to highlight the TV Settings icon and press **OK**. The TV Settings menu is displayed.
3. Use the **Arrow** buttons on the remote to highlight **Audio** and press **OK**. The Audio Settings menu is displayed.
4. Use the **Arrow** buttons to highlight **Reset Audio Mode** and press **OK**. The TV displays, "Are you sure you want to RESET Audio Settings to the factory defaults?"
5. Highlight **Yes** and press **OK**.
6. Press the **EXIT** button on the remote.

Adjusting the Tuner Settings

The Tuner Settings Menu can be used to perform channel scans or make adjustments when the TV is receiving channels from an antenna, cable, or satellite.

Setting the Tuner Mode

If you are using a device that is connected to the RF input, such as an external antenna or cable TV connection, you must set the tuner mode.

To set the tuner mode:

1. Press the **MENU** button on the remote. The on-screen menu is displayed.
2. Use the **Arrow** buttons on the remote to highlight the TV Settings icon and press **OK**. The TV Settings menu is displayed.
3. Use the **Arrow** buttons on the remote to highlight **Tuner Settings** and press **OK**. The Tuner Settings menu is displayed.
4. Highlight **Tuner Mode** and press **OK**. The Tuner Mode menu is displayed.
5. Highlight **Antenna** or **Cable** and press **OK**.
6. Press the **EXIT** button on the remote.

Scanning for Channels

Before the TV can detect and display channels and their associated information, you must scan for channels. A channel scan may also be necessary when the TV has been moved to an area where different free-to-air broadcast television channels are available.

1. From the Tuner Settings menu, highlight **Auto Channel Scan**. The auto channel scan begins.
2. Wait until the channel scan is 100% complete. Highlight **Done** and press **OK**.
3. Press the **EXIT** button on the remote.

Adding New Channels

Occasionally, you may need to add a new analog channel or add a new range of channels. You can do this by using the Partial Channel Search and Add Analog Channel options.

To add a range of new channels:

1. From the Tuner Settings menu, highlight **Partial Channel Search**. The Partial Channel Search menu is displayed.
2. Highlight **Scan Mode** and select the type of channel you are adding: **Analog**, **Digital**, or **Analog/Digital**.
3. Highlight **From Channel** and enter the channel from which you want to begin the scan. (Use the **Number Pad** on the remote to enter the channel.)
4. Highlight **To Channel** and enter the channel to which you want to end the scan. (Use the **Number Pad** on the remote to enter the channel.)
5. Highlight **Start** and press **OK**. The partial channel search begins.
6. Wait until the partial channel search is 100% complete. Highlight **Done** and press **OK**.
7. Press the **EXIT** button on the remote.



To add a single new analog channel:

1. From the Tuner Settings menu, highlight **Add Analog Channel**. The Add Analog Channel menu is displayed.
2. Highlight **Enter Channel #** and use the **Number Pad** on the remote to enter the number of the channel you are adding.
3. Highlight **Add Channel** and press **OK**. The TV scans for the channel.
4. When the TV is done scanning for the channel, press the **EXIT** button on the remote.

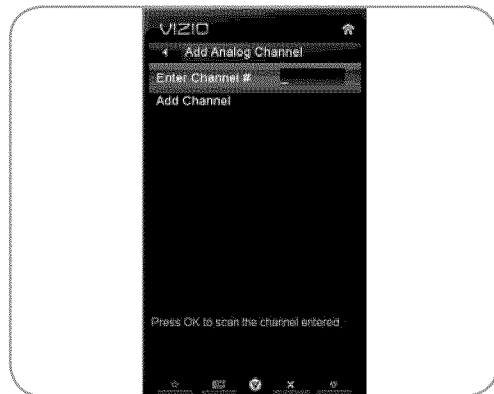

Skip Channels

After a channel scan is completed, you may find that some channels are too weak to watch comfortably. There may also be some channels you do not want to view. You can remove these channels from the TV's memory with the Skip Channel feature.



Channels that have been removed with the Skip Channel feature can still be viewed if the channel is entered using the Number Pad. If you wish to completely block a channel from being viewed, use the parental controls. See Using the Parental Controls.

To remove a channel:

1. From the Tuner Settings menu, highlight **Skip Channel**. The Skip Channel menu is displayed.
2. For each channel you wish to remove, use the **Up/Down Arrow** buttons on the remote to highlight the channel and press **OK**. An **X** appears to the right of each channel you select.
3. When you have selected all of the channels you wish to remove, press the **EXIT** button on the remote.



Changing the Audio Language

Some digital free-to-air and cable channels broadcast programs in more than one language. The TV's MTS (Multichannel Television Sound) feature allows you to listen to audio in your preferred language.



Not all programs are broadcast in multiple languages. The MTS feature only works when the program being viewed is being broadcast in the language you select.

To use the Analog MTS feature:

1. From the Tuner Settings menu, highlight **Analog MTS** and press **OK**. The Analog MTS menu is displayed.
2. Select **Mono**, **Stereo**, or **SAP** (secondary audio programming). Press **OK**.
3. Press the **EXIT** button on the remote.

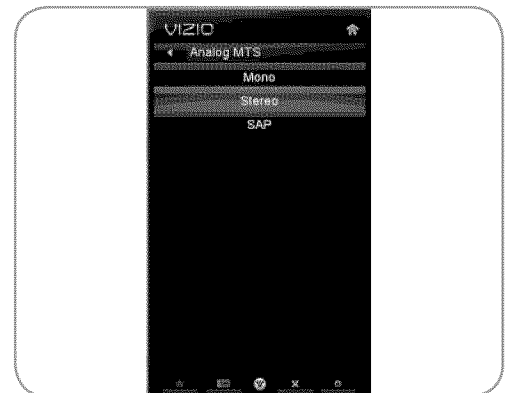

To use the Digital MTS feature:

1. From the Tuner Settings menu, highlight **Digital MTS** and press **OK**. The Digital MTS menu is displayed.
2. Select your preferred language: **English**, **French**, or **Spanish**. Press **OK**.
3. Press the **EXIT** button on the remote.



Changing the Names of the Inputs

To make it easier to recognize the different devices attached to the inputs on your TV, you can rename the inputs. For example, if you have a DVD player connected to the Component input, you can rename that input to display “DVD Player”.

To change the name of an input:

1. Press the **MENU** button on the remote. The on-screen menu is displayed.
2. Use the **Arrow** buttons on the remote to highlight the TV Settings icon and press **OK**. The TV Settings menu is displayed.
3. Use the **Arrow** buttons on the remote to highlight **Name Input** and press **OK**. The Name Input menu is displayed.
4. Highlight **Input Source** and press **OK**. Highlight the input you want to rename and press **OK**.
5. If you would like to use a preset input label, highlight **Input Labels** and press **OK**. Highlight the input label you want to use and press **OK**.



If you would like to name the input yourself, highlight the field below Input Labels and enter your custom label using the **QUERTY Keypad** on the remote and press **OK**. (If you would like to use the on-screen keyboard instead, highlight **Show Keyboard** and press **OK**.)

6. When you have finished naming your input, press the **EXIT** button on the remote.

Activating Game Mode

Game mode optimizes the TV for use as a video game display. When Game Mode is on, the video and audio synchronization is improved for video games.

To turn Game Mode on or off:

1. Press the **MENU** button on the remote. The on-screen menu is displayed.
2. Use the **Arrow** buttons on the remote to highlight the TV Settings icon and press **OK**. The TV Settings menu is displayed.
3. Use the **Arrow** buttons on the remote to highlight **Game Mode** and press **OK**. The Game Mode menu is displayed.
4. Select **Off** or **On** and press **OK**.
5. Press the **EXIT** button on the remote.

Using the Parental Controls

The TV's parental controls allow you to prevent the TV from displaying certain channels or programs without a password.

Accessing the Parental Controls Menu

To access the Parental Controls menu:

Enabling or Disabling Program Ratings

To manage program content according to its rating, you must enable the Program Rating feature.

To enable or disable the Program Rating feature:

1. From the Parental Controls menu, highlight **Rating Enable** and press **OK**. The Rating Enable menu is displayed.
2. Select **On** or **Off** and press **OK**.

Locking and Unlocking Channels

When a channel is locked, it will be inaccessible. Locking a channel is a good way to prevent children from viewing inappropriate material.

To lock or unlock a channel:

1. From the Parental Controls menu, highlight **Channel Locks** and press **OK**. The Channel Locks menu is displayed.
2. Highlight the channel you want to lock or unlock and press **OK**.
 - When a channel is **locked**, the Lock icon appears **locked**. The channel is **not** accessible unless the parental passcode is entered.
 - When a channel is **unlocked**, the Lock icon appears **unlocked**. The channel is accessible.

Blocking and Unblocking Content by Rating

A channel may sometimes broadcast programs that are meant for children, and at other times broadcast programs that are meant for mature audiences. You may not want to block the channel completely using a channel lock, but you may wish to block certain programs from being viewed.

When this is the case, you can use the TV's Rating Block feature to block content based on its rating.



For a list of content ratings and their definitions, visit www.tvguidelines.org.

To block or unblock content by its rating:

1. From the Parental Controls menu, highlight the content type you want to adjust and press **OK**:
 - USA - TV** - USA television program broadcasts.
 - USA - Movie** - USA movie broadcasts.
 - CAN - English** - Canadian English television program broadcasts.
 - CAN - French** - Canadian French television program broadcasts.

2. For each rating type you want to block or unblock, use the **Up/Down** and **Left/Right Arrow** buttons on the remote to highlight the rating type and press **OK**.
 - When the rating type is **blocked**, the Lock icon appears **locked**. **Content with this rating cannot be viewed.**
 - When the rating type is **unblocked**, the Lock icon appears **unlocked**. **Content with this rating can be viewed.**
3. If you want to block all unrated content, highlight **Block Unrated Shows** and use the **Arrow** buttons on the remote to select **On**.
4. When you are finished adjusting the rating level blocks, press the **EXIT** button on the remote.

Changing the Parental Control Passcode

If you use the parental controls, you should change the passcode to prevent children from accessing inappropriate material.

1. From the Parental Controls menu, highlight **Change PIN** and press **OK**. The Change PIN menu is displayed.
2. In the New Pin field, use the Number Pad on the remote to enter your new 4-digit parental control passcode.
3. In the Confirm Pin field, use the Number Pad on the remote to re-enter your new 4-digit parental control passcode.
4. Write down your new parental control passcode and save it in a secure location.
5. Press the **EXIT** button on the remote.

Resetting the Content Locks

To reset the content locks to the factory-default settings:

1. From the Parental Controls menu, highlight **RESET LOCKS** and press **OK**. The TV displays, "Are you sure you want to RESET ALL LOCKS SETTINGS to the factory defaults?"
2. Highlight **Yes** and press **OK**.

Changing the On-Screen Menu Language

Your TV can display the on-screen menu in different languages.

To change the on-screen menu language:

1. Press the **MENU** button on the remote. The on-screen menu is displayed.
2. Use the **Arrow** buttons on the remote to highlight the TV Settings icon and press **OK**. The TV Settings menu is displayed.
3. Use the **Arrow** buttons on the remote to highlight **Menu Language** and press **OK**. The Menu Language menu is displayed.
4. Highlight your preferred language (**English, French, or Spanish**) and press **OK**.
5. Press the **EXIT** button on the remote.



Setting the Time Zone

To ensure the correct time is displayed when you press the INFO button, set the TV's time zone:

1. Press the **MENU** button on the remote. The on-screen menu is displayed.
2. Use the **Arrow** buttons on the remote to highlight the TV Settings icon and press **OK**. The TV Settings menu is displayed.
3. Use the **Arrow** buttons on the remote to highlight **Time & Local Settings** and press **OK**. The Time & Local Settings menu is displayed.
4. Highlight **Time Zone** and press **OK**. The Time Zone menu is displayed.
5. Highlight your time zone and press **OK**.
6. Highlight **Daylight Savings** and press **OK**. The Daylight Savings menu is displayed.
7. Highlight **Off** or **On** and press **OK**.
8. Press the **EXIT** button on the remote.

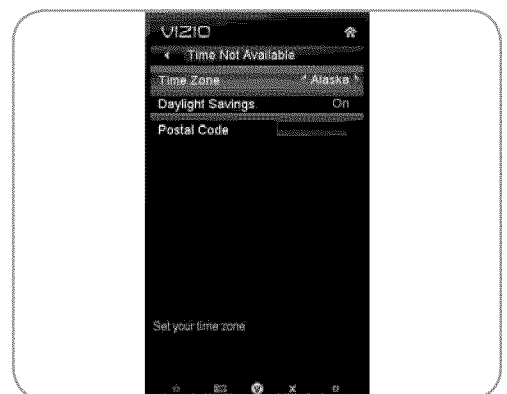

Using Picture-In-Picture (PIP) / Picture-Outside-Picture (POP)

Your TV features PIP and POP modes. These features allow you to watch two input sources at the same time. When using PIP, the main input is displayed on the full screen, and the secondary is displayed in a smaller window. When using POP, the two inputs are displayed side by side.



PIP is only available when the Rating Enable option in the Parental Controls menu is set to Off. See Enabling or Disabling Program Ratings on page 34.

To enable or disable PIP/POP:

1. Press the **MENU** button on the remote. The on-screen menu is displayed.
2. Use the **Arrow** buttons on the remote to highlight the PIP icon and press **OK**. The PIP Controls menu is displayed.
3. Highlight **PIP Mode** and press **OK**. The PIP Controls menu is displayed.
4. Highlight **Off**, **PIP**, or **POP**. Press **OK**.
5. If **PIP** is the PIP Mode selected, use the **Arrow** buttons to adjust each of the PIP settings:

Position - The location of the PIP window. Select **Top Right**, **Bottom Right**, **Top Left**, or **Bottom Left**.

Size - The size of the PIP window. Select **Small**, **Medium**, or **Large**.

Audio - The input for which the TV outputs sound. Select **Main** or **PIP**.

6. Press the **EXIT** button on the remote.

Choosing Inputs for the Main and Secondary Windows

Not all inputs can be displayed using PIP/POP. Use the table below to determine which inputs can be displayed using PIP/POP. (A “✓” between two inputs denotes compatibility.)

	TV	Composite AV	Component	HDMI	RGB
TV			✓	✓	✓
Composite AV			✓	✓	✓
Component	✓	✓		✓	
HDMI	✓	✓	✓		✓
RGB	✓	✓		✓	

Using the Network Connection Menu

Your TV is internet-ready, featuring both an ethernet port and built-in high-speed wireless-N.

Connecting to a Wireless Network

To connect to a wireless network whose network name (SSID) **is** being broadcast:

1. Press the **MENU** button on the remote. The on-screen menu is displayed.
2. Use the **Arrow** buttons on the remote to highlight the **Network** icon and press **OK**. The Network Connection menu is displayed.
3. Highlight **More Access Points** and press **OK**. The More Access Points menu, a list of available wireless networks, is displayed.
4. Highlight the name of your wireless network (this is the network's SSID) and press **OK**.
5. Using the **QUERTY Keypad** on the remote, enter your network's password, then highlight **Connect** and press **OK**. (If you would like to use the on-screen keyboard instead, highlight **Show Keyboard** and press **OK**.)
6. Press the **EXIT** button on the remote.

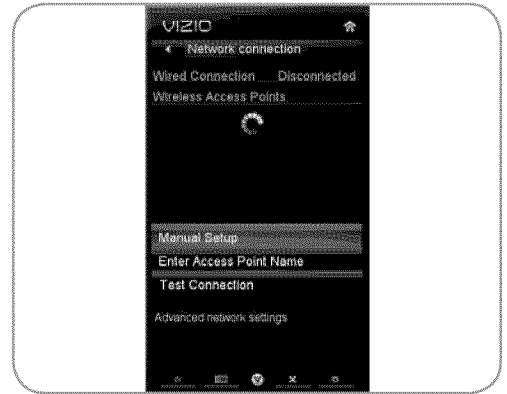

To connect to a wireless network whose network name (SSID) **is not** being broadcast:

1. Press the **MENU** button on the remote. The on-screen menu is displayed.
2. Use the **Arrow** buttons on the remote to highlight the **Network** icon and press **OK**. The Network Connection menu is displayed.
3. Highlight **Enter Access Point Name** and press **OK**.
4. Using the **QUERTY Keypad** on the remote, enter your network's name (SSID), then highlight **Connect** and press **OK**. (If you would like to use the on-screen keyboard instead, highlight **Show Keyboard** and press **OK**.)
5. Using the **QUERTY Keypad** on the remote, enter your network's password, then highlight **Connect** and press **OK**. (If you would like to use the on-screen keyboard instead, highlight **Show Keyboard** and press **OK**.)
6. Press the **EXIT** button on the remote.

Changing the Advanced Network Settings

Advanced users can fine-tune the network settings using the Manual Setup feature.

To change advanced network settings:

1. From the Network Connection menu, highlight **Manual Setup** and press **OK**. The Change Settings menu is displayed.
2. Use the **Arrow** and **OK** buttons to adjust each setting:
 - DHCP** - (Dynamic Host Configuration Protocol) This setting must be turned **Off** to change any of the other settings.
 - IP Address** - The IP address assigned to the TV.
 - Subnet Mask** - The subnet mask.
 - Default Gateway** - Your network's default gateway address.
 - Pref. DNS Server** - Your preferred domain name server address.
 - Alt DNS Server** - Your alternate domain name server address.
3. If you need the RJ45 (ethernet) MAC address or the Wireless MAC address to set up your network, these are displayed at the bottom of the Change Settings menu.
4. Press the **EXIT** button on the remote.

Testing Your Network Connection

To test your network connection:

1. From the Network Connection menu, highlight **Test Connection** and press **OK**.
2. The Test Connection screen displays the connection method, network name, signal strength, and download speed of your network connection.
3. Press the **EXIT** button on the remote.

Setting Up a Bluetooth Device

To pair a Bluetooth device with your TV:

1. Press the **MENU** button on the remote. The on-screen menu is displayed.
2. Use the **Arrow** buttons on the remote to highlight the **Bluetooth** icon and press **OK**. The Bluetooth menu is displayed.
3. Highlight **Pair Device** and press **OK**.

4. If you are pairing the included Bluetooth remote, hold down both the **Green VIA Shortcut** button and the **Record** button for 5 seconds.

If you are pairing a different Bluetooth device, place the device in “discoverable” mode as per the device instructions.

5. Highlight **Start searching for devices** and press **OK**. If the pairing is successful, the device will appear in the list of connected devices.
6. Press the **EXIT** button on the remote.

Using the Help Menu

You can use the TV's Help menu to:

- Display system information
- Reset the TV settings
- Restore the TV to its factory default settings
- Get guided setup help for the remote, tuner, devices, and network

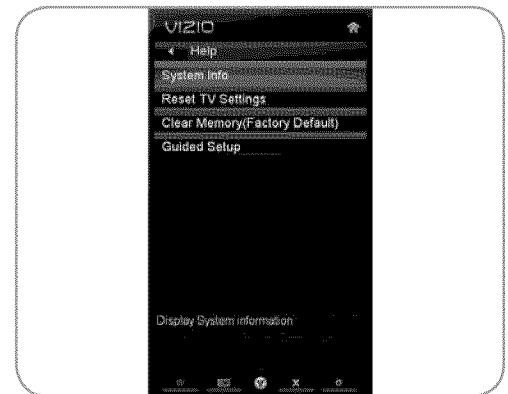

Displaying System Information

To display a summary of the TV settings:

1. Press the **MENU** button on the remote. The on-screen menu is displayed.
2. Use the **Arrow** buttons on the remote to highlight the **Help** icon and press **OK**. The Help menu is displayed.
3. Highlight **System Info** and press **OK**.
4. Use the **Up/Down Arrow** buttons to scroll through the system information.
5. When you are finished reviewing the system information, press the **EXIT** button on the remote.

Resetting the TV Settings

To reset the TV's picture and audio settings:

1. Press the **MENU** button on the remote. The on-screen menu is displayed.
2. Use the **Arrow** buttons on the remote to highlight the **Help** icon and press **OK**. The Help menu is displayed.
3. Highlight **Reset TV Settings** and press **OK**. The TV displays, “Are you sure you would like to Restore Defaults? This will erase any custom settings.”
4. Highlight **Yes** and press **OK**.
5. Press the **EXIT** button on the remote.

Restoring the TV to Factory Default Settings

All of the on-screen menu settings can be reset to the factory defaults.



If you restore the TV to the factory-default settings, all changes you have made to the settings will be lost!

To restore the TV to its factory default settings:

1. Press the **MENU** button on the remote. The on-screen menu is displayed.
2. Use the **Arrow** buttons on the remote to highlight the **Help** icon and press **OK**. The Help menu is displayed.
3. Highlight **Clear Memory (Factory Default)** and press **OK**.
4. Enter your parental control passcode. The TV displays, “Are you sure you would like to Restore Defaults? This will erase any custom settings.”
5. Highlight **Yes** and press **OK**. The TV displays “Memory is being cleared. The TV will reset shortly.”
6. Wait for the TV to turn off. The TV will turn back on shortly afterward and the Setup App will begin. See *Chapter 3: Completing the First-Time Setup on page 11*.

Using Guided Setup

The TV’s Setup App can be used to easily set up the Bluetooth remote, the TV tuner, your external devices, and to connect the TV with your network.

To access guided setup:

1. Press the **MENU** button on the remote. The on-screen menu is displayed.
2. Use the **Arrow** buttons on the remote to highlight the **Help** icon and press **OK**. The Help menu is displayed.
3. Highlight **Guided Setup** and press **OK**.
4. Highlight the guided setup you want to access and press **OK**:



Remote Setup - Set up the Bluetooth remote.

Tuner Setup - Set up the TV tuner.

Device Setup - Set up your external devices.

Network Setup - Connect the TV to your network.

5. Follow the on-screen instructions. When finished, press the **EXIT** button on the remote.

Using the Digital Episode Guide

Your TV features an on-screen digital episode guide. This guide displays program information broadcast by digital television stations as well as the current time and date.

To use the digital episode guide, press the **GUIDE** button on the remote.

While viewing the digital episode guide, use the **Left/Right Arrow** buttons to change the channel.



Using the Info Window

The Info Window can be displayed by pressing the INFO button on the remote:

- Press the **INFO** button **one** time to display channel and input information.
- Press the **INFO** button **two** times to display the program title and closed captioning information.
- Press the **INFO** button **three** times to display the program description.

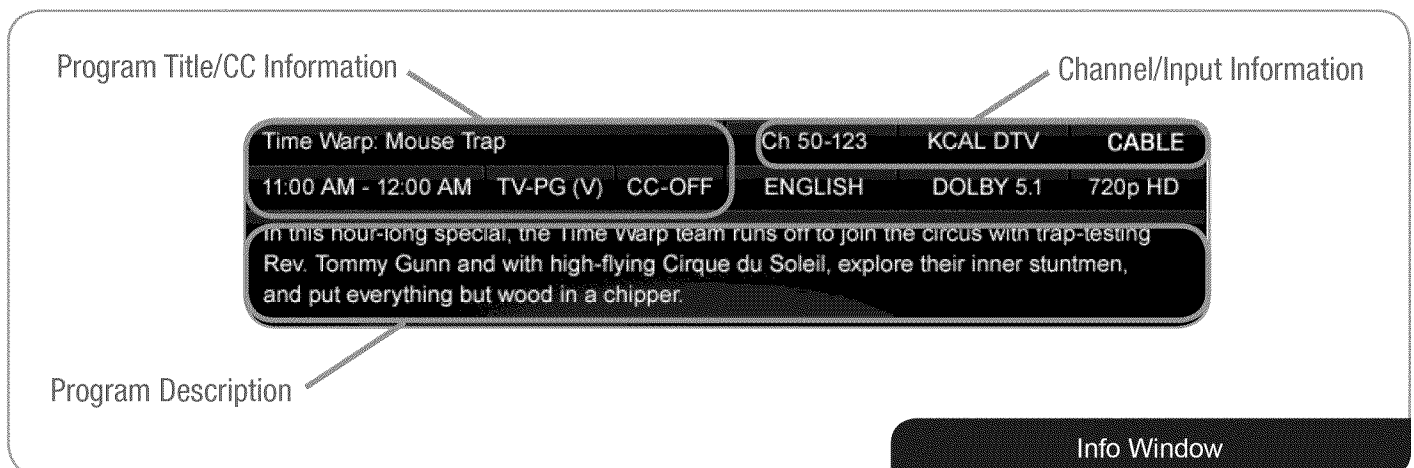

Chapter 6: Using VIZIO Internet Apps

VIZIO Internet Apps (VIA) delivers popular online content to your TV. VIA features a selection of Apps that allow you to watch movies and TV shows, listen to music, get weather and news information, and more—all on demand!



A high-speed Internet connection is required to receive product updates and to access online content.

See *Setting Up Your Network Connection* on page 18 if your TV is not yet connected to your home network.

Using the VIA Shortcut Buttons

Use the four colored buttons on the remote to perform common VIA tasks:

- **Yellow** - Move or delete an App from the VIA Dock. In some Apps, this button is also used to create a “snippet”. For these Apps, the snippet is available from the App Dock by highlighting the App and pressing **Up/Down Arrow**.
- **Blue** - Change the size of the main display window when an App is open in the sidebar.
- **Red** - Exit from an open App or to close the App Dock.
- **Green** - View settings for an open App.



Using the VIA Dock

The VIA Dock is where all of your VIA Apps are accessed.

To use the VIA Dock and launch an App:

1. Press the **VIA** button on the remote.
2. Highlight a VIA App by scrolling left and right using the **Left/Right Arrow** buttons on the remote. (The highlighted App is in the lower left corner of the screen.)
3. Launch a VIA App by highlighting it and pressing the **OK** button on the remote.



Moving an App on the VIA Dock

You can personalize your VIA Dock by moving Apps.

To move an App:

1. Press the **VIA** button on the remote.
2. Highlight a VIA App by scrolling left and right using the **Left/Right Arrow** buttons on the remote. (The highlighted App is in the lower left corner of the screen.)
3. Press the **Yellow VIA Shortcut** button.
4. Confirm that you want to move the App by pressing the **Blue VIA Shortcut** button.
5. Use the **Left/Right Arrow** buttons to move the App to the new location on the VIA Dock.
6. Press the **Yellow VIA Shortcut** button to drop the App in the new location.

Adding a New App to the VIA Dock

Though your TV arrives pre-loaded with featured VIA Apps, new Apps are continually being added to the Widget Gallery. The VIA Dock can hold a total of 17 Apps.

To add a new App:

1. Press the **VIA** button on the remote.
2. Highlight the **Widget Gallery** App by scrolling left and right using the **Left/Right Arrow** buttons on the remote. (The highlighted App is in the lower left corner of the screen.)
3. Select **Widget Gallery** by pressing the **OK** button. The Yahoo! Widget Gallery is displayed.
4. Use the **Arrow** and **OK** buttons to select a new App.
5. Highlight **Add Widget to My Profile** and press **OK**.

Removing an App from the VIA Dock

To remove an App:

1. Press the **VIA** button on the remote.
2. Highlight the App you want to delete by scrolling left and right using the **Left/Right Arrow** buttons on the remote. (The highlighted App is in the lower left corner of the screen.)
3. Press the **Yellow VIA Shortcut** button.
4. Press the **Red VIA Shortcut** button. The TV displays, "Permanently delete Widget?"
5. Press the **Red VIA Shortcut** button to confirm that you want to delete.
6. Press the **EXIT** button.

Creating and Managing User Profiles

User profiles allow you to keep a customized set of Apps in the VIA Dock. For each profile you create, a different set of Apps and App settings are saved.

Creating an Owner PIN

Creating an owner PIN allows you to restrict access to the Administrative Controls menu in the Profile App. You can also restrict other profiles from installing new Apps.

To create an owner PIN:

1. Press the **VIA** button on the remote.
2. Highlight the **Profile** App by scrolling left and right using the **Left/Right Arrow** buttons on the remote. (The highlighted App is in the lower left corner of the screen.)
3. Select the App by pressing the **OK** button. The Profile App is displayed.
4. Highlight **Administrative Controls** and press **OK**. The Administrative Controls menu is displayed.
5. Highlight **Create Owner Pin** and press **OK**. The Owner PIN menu is displayed.
6. Highlight **Create Owner Pin** and press **OK**. The PIN Creation menu is displayed.
7. Enter a 4-digit passcode using the **Number Pad** on the remote or the on-screen number pad. Write down your passcode and save it in a secure location.
8. Highlight **OK** and press **OK**. The PIN Confirmation menu is displayed.
9. Re-enter your 4-digit passcode. Highlight **OK** and press **OK**. The Security Question dialog is displayed. Press **OK**.
10. Highlight a security question and press **OK**. The Security Answer menu is displayed.
11. Enter your security answer using the **QUERTY Keyboard** and press **OK**. The Create Profile menu is displayed.
12. Highlight **Done** and press **OK**.

Creating a New User Profile

To create a new user profile:

1. Press the **VIA** button on the remote.
2. Highlight the **Profile** App by scrolling left and right using the **Left/Right Arrow** buttons on the remote. (The highlighted App is in the lower left corner of the screen.)
3. Select the App by pressing the **OK** button. The Profile App is displayed.
4. Highlight **Administrative Controls** and press **OK**. (If you have an Owner PIN, you must enter it now.) The Administrative Controls menu is displayed.
5. Highlight **Create Profile** and press **OK**. The Create Profile menu is displayed.

6. Highlight the **Name** field and press **OK**.
7. Enter your name using the **QUERTY Keyboard** on the remote or the on-screen keyboard, then press **OK**. The Create Profile menu is displayed.
8. Highlight **Avatar** and press **OK**. The Avatar menu is displayed.
9. Highlight a picture for your profile and press **OK**. The Create Profile menu is displayed.
10. Highlight **Create Profile PIN** and press **OK**. The PIN Creation menu is displayed.
11. Enter a 4-digit passcode using the **Number Pad** on the remote or the on-screen number pad. Write down your passcode and save it in a secure location.
12. Highlight **OK** and press **OK**. The PIN Confirmation menu is displayed.
13. Re-enter your 4-digit passcode. Highlight **OK** and press **OK**. The Security Question dialog is displayed. Press **OK**.
14. Highlight a security question and press **OK**. The Security Answer menu is displayed.
15. Enter your security answer using the **QUERTY Keyboard** and press **OK**. The Create Profile menu is displayed.
16. If you would like to prevent the user of this new profile from installing new Apps, turn **Limit Profile to On**. (You need an Owner PIN. Enter it after turning **Limit Profile to On**.)
17. Highlight **Done** and press **OK**.

Removing a User Profile

To remove a user profile:

1. Press the **VIA** button on the remote.
2. Highlight the **Profile** App by scrolling left and right using the **Left/Right Arrow** buttons on the remote. (The highlighted App is in the lower left corner of the screen.)
3. Select the App by pressing the **OK** button. The Profile App is displayed.
4. Highlight **Administrative Controls** and press **OK**. (If you have an Owner PIN, you must enter it now.) The Administrative Controls menu is displayed.
5. Highlight **Remove Profile** and press **OK**. The Remove Profile menu is displayed.
6. Highlight the name of the profile you want to remove and press **OK**. The TV displays, "Are you sure you want to delete this profile? This operation cannot be undone."
7. Highlight **OK** and press **OK**.

Restoring the VIA Dock to the Factory Default Settings

The VIA Dock, and all of its installed Widgets can be restored to the factory default settings.



If you restore the TV to the factory-default settings, all changes you have made to the settings will be lost!

To restore the VIA Dock to the factory default settings:

1. Press the **VIA** button on the remote.
2. Highlight the **Profile** App by scrolling left and right using the **Left/Right Arrow** buttons on the remote. (The highlighted App is in the lower left corner of the screen.)
3. Select the App by pressing the **OK** button. The Profile App is displayed.
4. Highlight **System Settings** and press **OK**. The System Settings menu is displayed.
5. Highlight **Restore Factory Settings** and press **OK**. The TV displays, "Are you sure you want to proceed?"
6. Select **Restore Factory Settings** and press **OK**. The TV displays, "Are you sure?"
7. Highlight **Restore Factory Settings** and press **OK**.
8. Wait 5 seconds for the TV to restart.

Chapter 7: Viewing 3D Content

Your TV can display several types of 3D content:

- Full HD 3D (Active-shutter 3D)
- Side by Side (SBS)
- Top/Bottom (TB)
- Sensio



Read the important 3D safety information at the beginning of this User Guide before using 3D.

What You Need to View 3D Content

To view 3D content, you will need:

- 3D HDTV
- 3D Blu-ray player with a Blu-ray 3D disc (sold separately)
- VIZIO Full HD 3D Glasses (sold separately)
- 3D-compliant HDMI cable (sold separately)

VIZIO 3D HDTV

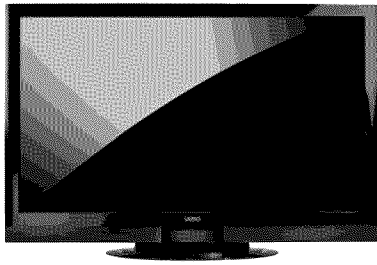

3D Blu-ray Player

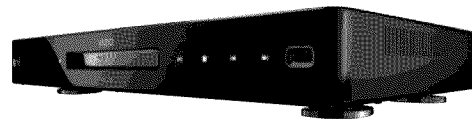

VIZIO Full HD 3D Glasses

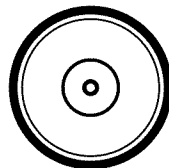

Blu-ray 3D Disc



3D-Compliant HDMI Cable

What You Need

How VIZIO 3D Works

Our eyes have space between them, so when we look around, we see two slightly different pictures. We never notice, because we are able to combine these pictures into one three-dimensional image.

The VIZIO 3D HDTV takes advantage of this phenomenon to create a stunning 3D image. When displaying 3D content, the 3D HDTV actually displays a high-definition image for one eye, then quickly switches to a high-definition image for the other eye. The images are alternately displayed in this way many times per second.

VIZIO Full HD 3D glasses are in sync with the 3D HDTV, also alternating many times per second, only allowing the right and left eyes to see the images intended for them.

The final result is a stunning, life-like, high-resolution 3D picture.

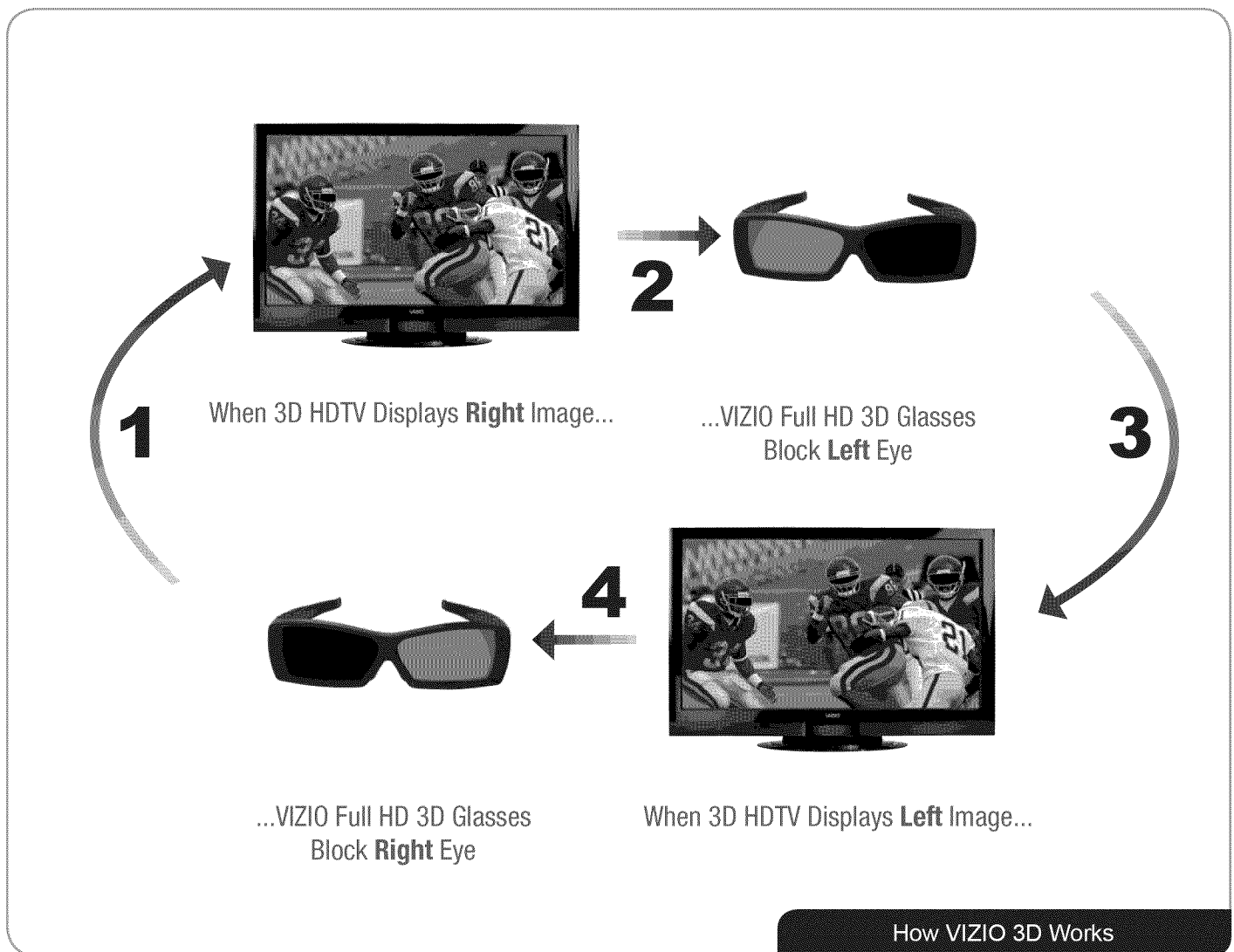

Watching Blu-ray 3D Content

To view Blu-ray 3D content:

1. Ensure you have the following equipment:
 - 3D Blu-ray player
 - VIZIO Full HD 3D Glasses
 - Blu-ray 3D disc
 - 3D-compliant HDMI cable
2. Ensure the 3D Blu-ray player and your TV are connected with the 3D-compliant HDMI cable. See *Connecting Your Devices* on page 16.
3. Ensure the 3D Blu-ray player is off. Press the **Power/Standby** button on the remote to turn the TV on.
4. Press the **INPUT** button on the remote and select the input to which the Blu-ray player is connected (HDMI-1, HDMI-2, etc).
5. Turn the 3D Blu-ray player on. Insert the Blu-ray 3D disc into the player.
6. When the disc is loaded, select the **Play Movie** option in the disc's main menu.
7. The TV displays, "3D Content detected. Select YES to switch to 3D, NO to display in 2D." Highlight **Yes** and press **OK**.
8. Turn on your VIZIO Full HD 3D Glasses and put them on.

Watching SBS, TB, or Sensio 3D Content

Some broadcast television is broadcast in side-by-side (SBS), top/bottom (TB), or Sensio format.

To view SBS, TB, or Sensio 3D content:

1. Ensure the program you are watching is broadcast in SBS, TB, or Sensio.
2. Press the **3D** button on the remote. The Output Mode menu is displayed.
3. Highlight **3D** and press **OK**.
4. Select the 3D mode to match the content you are watching: **SBS**, **TB**, or **Sensio**.
5. The TV displays, "3D viewing mode enabled. Please wear 3D glasses." Put on your 3D glasses and turn them on.

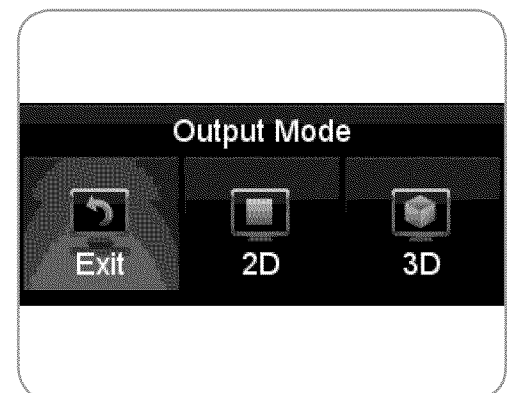

Appendix A: Troubleshooting and Technical Support

Products are often returned due to a technical problem rather than due to a defect. If you are experiencing a problem when using your TV, try to fix the issue using this troubleshooting guide.

If, after using this troubleshooting guide, you are still experiencing an issue with your TV, contact VIZIO's Support Department. Quality customer support and service are integral parts of VIZIO's commitment to service excellence.

Address: 39 Tesla
Irvine, CA 92618, USA

Web: www.VIZIO.com

Phone: (877) 698-4946

Hours of operation:

Monday - Friday: 6 am to 9 pm (PST)

Fax: (949) 585-9563

Saturday - Sunday: 8 am to 4pm (PST)

Email: techsupport@vizio.com



Have your serial number and date of purchase ready when you call.

The TV displays “No Signal”.

- Press the INPUT button on the remote control to select a different input source.
- If you have a cable connected to the TV, see Setting Up for Cable TV Viewing.
- If you have an external antenna connected to the TV, see Setting Up an External Antenna
- If you are in a moving vehicle, the TV will not receive free-to-air television signals.

There is no power.

- Make sure the ON/OFF switch is turned to ON, then press the Power button on the remote or TV.
- Ensure the power adapter is securely connected to an electrical outlet.
- Plug another electrical device into the electrical outlet to be sure the outlet is working.

There is a picture, but no sound.

- Press the Volume UP button on the remote, or touch the Volume UP control on the TV.
- Press the MUTE button on the remote to be sure mute is off.
- Ensure there are no headphones connected to the TV.

The screen is black.

- Make sure the ON/OFF switch is turned to ON, then press the Power button on the remote or TV.
- Press the INPUT button on the remote control to select a different input source.
- Ensure the TV's battery is fully charged. See Getting Started for instructions on plugging the TV in.
- Adjust backlight, brightness, and contrast. Press MENU, then select Settings > Picture Settings.

The colors do not display correctly.

- Adjust the color. See [Adjusting Picture Settings](#).
- If you are using an antenna, ensure it is connected securely and correctly. Adjust the antenna or move the TV to get a better signal.

When I press buttons on the remote, nothing happens.

- When using the remote, point it directly at the TV.
- Remove any obstacles between the remote and the TV.
- Remove the clear plastic tab from the back of the remote.
- Replace the battery in the remote. (Battery type is CR2025.)

The picture quality seems low.

- If you are using an antenna, ensure it is connected securely and correctly. Adjust the antenna or move the TV to get a better signal.
- View high-definition (HD) programs when possible.
- If you are in a moving vehicle, the TV will not receive free-to-air television signals.

The display has dots (pixels) that do not change color.

- Your TV is precision-manufactured using a high level of technology. However, sometimes individual pixels may not display. This is common in this type of product and does not mean your TV is defective.

The display image does not cover the entire screen.

- Change the screen mode. Press MENU on the remote, then select Settings > Screen Mode > Wide.
- If there are still bars on the sides of the display image, they may be part of the image the TV is receiving.

My 3D content is displayed as two separate images.

- Enable SBS (side-by-side) 3D Mode. See *Changing the 3D Mode on page 19*.

I cannot access VIZIO Internet Apps, or my Apps are not working correctly.

- Press the **VIA** button on the remote.
- Ensure the TV is connected to your network. See *Setting Up Your Network Connection on page 18*.
- Press the **Green VIA Shortcut** button to display the help screen for an App.

The TV displays, “No RGB Signal. Power will be turned off.”

- Press **INPUT** to select the correct input source for the device you are attempting to use.
- Ensure that your external devices are turned on and that they are securely connected.
- Check all cables to ensure they are working. Try using different cables.

The Jag Wheel is not responding.

- Turn the TV off. Unplug the power cable from both the TV and the electrical outlet. Wait for 30 seconds, then reconnect the power cable. Turn the TV on.

Appendix B: Specifications

	XVT3D424SV	XVT3D474SV	XVT3D554SV
Screen Size	42"	47"	55"
Viewable Area	42.02"	46.96"	54.64"
Dimensions w/ Stand	40.15 x 27.91 x 9.05"	45.22 x 30.63 x 10.62"	52.18 x 35.12 x 13.11"
w/o Stand	40.15 x 25.83 x 2.32"	45.22 x 28.89 x 2.95"	52.18 x 33.28 x 2.99"
Weight w/ Stand	41.45 lbs	53.90 lbs	76.06 lbs
w/o Stand	38.36 lbs	48.50 lbs	68.34 lbs
TV Type	Edge-lit LED	Full Array LED	Full Array LED
Refresh Rate	480 Hz	480 Hz	480 Hz
Maximum Resolution	1920 x 1080	1920x1080	1920x1080
Colors	1.06 Billion	1.06 Billion	1.06 Billion
Smart Dimming	128 Zones	160 Zones	120 Zones
Smooth Motion	Yes	Yes	Yes
Dynamic Contrast Ratio	1,000,000:1	10,000,000:1	10,000,000:1
Response Time	4 ms	4 ms	4 ms
Brightness	450 nits	500 nits	500 nits
HDMI Inputs	5	5	5
Component Video Inputs	1	1	1
Composite Inputs	1	1	1
RF Antenna Input	1	1	1
Viewing Angle	178/178	178/178	178/178
USB 2.0 Ports	3	3	3
PC Inputs	1	1	1
3D Supported Format	SBS, T/B, Sensio, Sequential	SBS, T/B, Sensio, Sequential	SBS, T/B, Sensio, Sequential
3D Standard Type	Full HD 3D (Active)	Full HD 3D (Active)	Full HD 3D (Active)
Internet Connectivity	802.11n dual-band Ethernet	802.11n dual-band Ethernet	802.11n dual-band Ethernet
Bluetooth	HID (Remote) A2DP/AVRCP (Headset) HVP (VOIP)	HID (Remote) A2DP/AVRCP (Headset) HVP (VOIP)	HID (Remote) A2DP/AVRCP (Headset) HVP (VOIP)
Audio Outputs	SPDIF Stereo	SPDIF Stereo	SPDIF Stereo
Number of Speakers	2	2	2

	XVT3D424SV	XVT3D474SV	XVT3D554SV
Watts per Channel	15W	15W	15W
Surround/ Simulated Surround	SRS TruSurround HD	SRS TruSurround HD	SRS TruSurround HD
Sound Leveller	SRS TruVolume	SRS TruVolume	SRS TruVolume
Language Options	English, Spanish, French	English, Spanish, French	English, Spanish, French
Remote Control Type	VUR10 3D	VUR10 3D	VUR10 3D
Ambient Light Sensor	Yes	Yes	Yes
Energy Star 4.1 Qualified	Yes	Yes	Yes
Power	88.1 W	103 W	119 W
Mercury Free	Yes	Yes	Yes
Certifications	CSA, CSA-US, FCC Class B, BQB, HDMI 1.4A including 3D	CSA, CSA-US, FCC Class B, BQB, HDMI 1.4A including 3D	CSA, CSA-US, FCC Class B, BQB, HDMI 1.4A including 3D
Compliances	ATSC Spec A/65, EIA/CEA-766-A	ATSC Spec A/65, EIA/CEA-766-A	ATSC Spec A/65, EIA/CEA-766-A
Wall Mount Size	200(V) x 200(H) mm	200(V) x 200(H) mm	200(V) x 400(H) mm
Screw Size	M6	M6	M8

Appendix C: Warranty

ON PARTS AND LABOR

Covers units purchased as new in United States and Puerto Rico Only.

VIZIO provides a warranty to the original purchaser of a new Product against defects in materials and workmanship for a period of one year of non-commercial usage and ninety (90) days of commercial use. If a Product covered by this warranty is determined to be defective within the warranty period, VIZIO will either repair or replace the Product at its sole option and discretion.

To obtain warranty service, contact VIZIO Technical Support via e-mail: TechSupport@VIZIO.com or via phone at 877 MY VIZIO (877.698.4946) from 6:00AM to 9:00PM Monday through Friday and 8:00AM to 4:00PM Saturday and Sunday, Pacific Time, or visit www.VIZIO.com. PRE-AUTHORIZATION MUST BE OBTAINED BEFORE SENDING ANY PRODUCT TO A VIZIO SERVICE CENTER. Proof of purchase in the form of a purchase receipt or copy thereof is required to show that a Product is within the warranty period.

Parts and Labor

There will be no charge for parts or labor during the warranty period. Replacement parts and Products may be new or recertified at VIZIO's option and sole discretion. Replacement parts and Products are warranted for the remaining portion of the original warranty or for ninety (90) days from warranty service or replacement, whichever is greater.

Type of Service

Defective Products must be sent to a VIZIO service center to obtain warranty service. VIZIO is not responsible for transportation costs to the service center, but VIZIO will cover return shipping to the customer. PRE-AUTHORIZATION IS REQUIRED BEFORE SENDING ANY PRODUCT TO A VIZIO SERVICE CENTER FOR WARRANTY SERVICE.

Product returns to VIZIO's service centers must utilize either the original carton box and shipping material or packaging that affords an equal degree of protection. VIZIO Technical Support will provide instructions for packing and shipping the covered Product to the VIZIO service center.

Limitations and Exclusions

VIZIO's one-year limited warranty only covers defects in materials and workmanship. This warranty does not cover, for example: cosmetic damage, normal wear and tear, improper operation, improper voltage supply or power surges, signal issues, damages from shipping, acts of God, any type of customer misuse, modifications or adjustments, as well as installation and set-up issues or any repairs attempted by anyone other than by a VIZIO authorized service center. Products with unreadable or removed serial numbers, or requiring routine maintenance are not covered. This one year limited warranty does not cover Products sold "AS IS", "FACTORY RECERTIFIED", or by a non-authorized reseller.

THERE ARE NO EXPRESS WARRANTIES OTHER THAN THOSE LISTED OR DESCRIBED ABOVE. ANY IMPLIED WARRANTIES, INCLUDING ANY IMPLIED WARRANTY OF MERCHANTABILITY AND FITNESS FOR A PARTICULAR PURPOSE, SHALL BE LIMITED IN DURATION TO THE PERIOD OF TIME SET FORTH ABOVE. VIZIO'S TOTAL LIABILITY FOR ANY AND ALL LOSSES AND DAMAGES RESULTING FROM ANY CAUSE WHATSOEVER INCLUDING VIZIO'S

NEGLIGENCE, ALLEGED DAMAGE, OR DEFECTIVE GOODS, WHETHER SUCH DEFECTS ARE DISCOVERABLE OR LATENT, SHALL IN NO EVENT EXCEED THE PURCHASE PRICE OF THE PRODUCT. VIZIO SHALL NOT BE RESPONSIBLE FOR LOSS OF USE, LOSS OF INFORMATION OR DATA, COMMERCIAL LOSS, LOST REVENUE OR LOST PROFITS, OR OTHER INCIDENTAL OR CONSEQUENTIAL DAMAGES. SOME STATES DO NOT ALLOW LIMITATIONS ON HOW LONG AN IMPLIED WARRANTY LASTS OR THE EXCLUSION OF INCIDENTAL OR CONSEQUENTIAL DAMAGES, SO THE ABOVE LIMITATIONS OR EXCLUSIONS MAY NOT APPLY TO YOU. THIS WARRANTY GIVES YOU SPECIFIC LEGAL RIGHTS, AND YOU MAY ALSO HAVE OTHER RIGHTS, WHICH VARY FROM STATE TO STATE. THIS WARRANTY IS SUBJECT TO CHANGE WITHOUT NOTICE.

CHECK WWW.VIZIO.COM FOR THE MOST CURRENT VERSION.

Personal Data

If your VIZIO product is capable of storing personal data and other information, ALL CONTENTS AND INFORMATION WILL BE DELETED IN THE COURSE OF SOME IN-HOME AND ALL SHIP-IN WARRANTY SERVICE. If this occurs, your product will be restored to you configured as originally purchased. You will be responsible for restoring all applicable data and passwords. Recovery and reinstallation of user data is not covered under this Limited Warranty. In order to protect your personal information, VIZIO recommends that you always clear all personal information from the unit before it is serviced, regardless of the servicer.

ZERO BRIGHT PIXEL DEFECT GUARANTEE

This policy covers “zero bright pixel” defects for the duration of the limited “ONE YEAR WARRANTY” on select new product purchases. To determine if this guarantee applies to your product, refer to the “DETAILS” tab of the model’s product information page (www.VIZIO.com) or look for the “zero bright pixel” guarantee on the box.

Appendix D: Legal & Compliance

FCC Class B Radio Interference Statement

NOTE: This equipment has been tested and found to comply with the limits for a Class B digital device, pursuant to Part 15 of the FCC Rules. These limits are designed to provide reasonable protection against harmful interference in a residential installation. This equipment generates, uses and can radiate radio frequency energy, and if not installed and used in accordance with the instructions, may cause harmful interference to radio communications. However, there is no guarantee that interference will not occur in a particular installation. If this equipment does cause harmful interference to radio or television reception, which can be determined by turning the equipment off and on, the user is encouraged to try to correct the interference by one or more of the following measures:

1. Reorient or relocate the receiving antenna.
2. Increase the separation between the equipment and receiver.
3. Connect the equipment into an outlet on a circuit different from that to which the receiver is connected.
4. Consult the dealer or an experienced radio/TV technician for help.

Notice

1. The changes or modifications not expressly approved by the party responsible for compliance could void the user's authority to operate the equipment.
2. Shielded interface cables and AC power cord, if any, must be used in order to comply with the emission limits.
3. The manufacturer is not responsible for any radio or TV interference caused by unauthorized modification to this equipment. It is the responsibilities of the user to correct such interference.

FCC warning

Changes or modifications not expressly approved by the party responsible for compliance with the FCC Rules could void the user's authority to operate this equipment.

Caution

Always use an AC/DC power adapter that is properly grounded. Use the AC cords listed below for each area.

USA: UL

Canada: CSA

Germany: VDE

UK: BASE/BS

Japan: Electric Appliance Control Act

Index

A

Activating the Bluetooth Remote Control 9
Adaptive Luma 25
Adding a New App 44
Adding New Channels 30
Advanced Audio Settings 28
Advanced Network Settings 39
Advanced Picture Settings 25
Ambient Light Sensor 25
Audio Language 31
Audio Settings 27
Auto Adjust 27
Auto Channel Scan 30

B

Backlight 24
Blocking and Unblocking Content 34
Bluetooth Device 39
Brightness 24

C

Channel Locks 34
Choosing the Correct Connection 15
Closed Captioning 21
Color 24
Color Enhancement 25
Color Temperature 26
Connecting Your Devices 14, 16
Contrast 24
Custom picture mode 24

D

Digital Episode Guide 42

F

Factory Default Settings 41
Film Mode 25
Fine Tune 27
First-Time Setup 11
Front Panel 4

G

Game Mode 33
Guided Setup 41

H

Help Menu 40
Horizontal Size 27
Horiz. Position 27

I

Info Window 42
Input Labels 32
Input Source 23

J

Jag Wheel 6

M

Movie mode 24
Moving an App 43
MTS (Multichannel Television Sound) 31

N

Network Connection Menu 38
Noise Reduction 25
Normal mode 20

O

On-Screen Menu 19
On-Screen Menu Language 36
Owner PIN 45

P

Parental Control Passcode 35
Parental Controls Menu 33
Picture-In-Picture 37
Picture Settings 24
Picture Size and Position 26
Program Ratings 34

Q

Quick Menu 6

R

Real Cinema Mode 25
Rear Panel 5
Remote Control Buttons 8
Removing an App 44

S

Screen Aspect Ratio 20
Setup App 11
Sharpness 25
Side Panel 4
Skipping Channels 31
Sleep Timer 22
Smart Dimming 25
Smooth Motion Effect 25
Standard mode 24
Stretch mode 20

System Information 40

T

Testing Your Network Connection 39

Time Zone 36

Tint 24

Tuner Mode 29

Tuner Settings Menu 29

TV Settings Menu 23

TV Stand 1

U

User Profiles 45

V

Vertical Position 27

VIA Dock 43

VIA Shortcut Buttons 43

Vivid mode 24

VIZIO Internet Apps 43

W

wall mount 3

Wide mode 20

Wired Network 18

Wireless Network 18

Z

Zoom mode 20

VIZIO



TRADEMARKS SHOWN ARE THE PROPERTY OF THEIR RESPECTIVE OWNERS. IMAGES USED ARE FOR ILLUSTRATION PURPOSES ONLY. VIZIO, THE V LOGO, WHERE VISION MEETS VALUE, AND OTHER VIZIO TRADEMARKS ARE THE INTELLECTUAL PROPERTY OF VIZIO INC. PRODUCT FEATURES AND SPECIFICATIONS ARE SUBJECT TO CHANGE WITHOUT NOTICE. © 2010 VIZIO INC. ALL RIGHTS RESERVED.

101005ST-A