



Dear VIZIO Customer,

Congratulations on your new VIZIO High Definition LCD Television purchase. This User Manual covers the following models: M190VA, M220VA and M260VA in black color and M190VA-W, M220VA-W and M260VA-W in white color; for specific difference between the models please refer to the specification sheets in Chapter 11. Thank you for your support. For maximum benefit of your set, please read these instructions before making any adjustments, and retain them for future reference. We hope you will experience many years of enjoyment from your new VIZIO HDTV High Definition Television.

For assistance, please call **877-MYVIZIO** (877-698-4946) or e-mail us at www.VIZIO.com.

To purchase or inquire about accessories and installation services for your VIZIO HDTV, please visit our website at www.VIZIO.com or call toll free at **(888) 849-4623**.

We recommend you register your VIZIO HDTV either at our website www.VIZIO.com or fill out and mail your registration card. For peace of mind and to protect your investment beyond the standard warranty, VIZIO offers on-site extended warranty service plans. These plans give additional coverage during the standard warranty period. Visit our website or call us to purchase a plan.

Write down the serial number located on the back of your HDTV for easy reference when obtaining warranty support:

Serial #: _____	Purchase Date _____
-----------------	---------------------

VIZIO is a registered trademark of VIZIO, Inc. dba V, Inc.

HDMI logo and "High Definition Multimedia Interface" are registered trademarks of HDMI Licensing LLC.

Manufactured under license from Dolby Laboratories.

Dolby and the double-D symbol are trademarks of Dolby Laboratories.

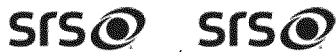

TruSurround HD and TruVolume are trademarks of SRS Labs, Inc.

TruSurround HD and TruVolume technologies are incorporated under license from SRS Labs, Inc.



This product qualifies for ENERGY STAR in the "factory default (Home Use)" setting and this is the setting in which power savings will be achieved. Changing the factory default picture setting or enabling other features will increase power consumption that could exceed the limits necessary to qualify for Energy Star rating.

THE TRADEMARKS SHOWN HEREIN ARE THE PROPERTY OF THEIR RESPECTIVE OWNERS; IMAGES USED ARE FOR ILLUSTRATION PURPOSES ONLY. BRAVO, VIZIO AND THE V LOGO AND WHERE VISION MEETS VALUE AND OTHER VIZIO TRADEMARKS ARE THE INTELLECTUAL PROPERTY OF VIZIO INC. PRODUCT SPECIFICATIONS ARE SUBJECT TO CHANGE WITHOUT NOTICE OR OBLIGATION. © 2008 VIZIO INC. ALL RIGHTS RESERVED.



Important Safety Instructions

Your HDTV is designed and manufactured to operate within defined design limits, and misuse may result in electric shock or fire. To prevent your HDTV from being damaged, the following instructions should be observed for the installation, use, and maintenance of your HDTV. Read the following safety instructions before operating your HDTV. Keep these instructions in a safe place for future reference.

- To reduce the risk of electric shock or component damage, switch off the power before connecting other components to your HDTV.
- Unplug the power cord before cleaning your HDTV. A damp cloth is sufficient for cleaning your HDTV. Do not use a liquid or a spray cleaner for cleaning your HDTV. Do not use abrasive cleaners.
- Always use the accessories recommended by the manufacturer to insure compatibility.
- When moving your HDTV from an area of low temperature to an area of high temperature, condensation may form in the housing. Wait before turning on your HDTV to avoid causing fire, electric shock, or component damage.
- Use only with the cart, stand, tripod, bracket, or table specified by manufacturer or sold with your HDTV. When a cart is used, use caution when moving the cart/HDTV combination to avoid injury from tip-over. Do not place your HDTV on an unstable cart, stand, or table. If your HDTV falls, it can injure a person and cause serious damage to your HDTV. Use only a cart or stand recommended by the manufacturer or sold with your HDTV.
- A distance of at least 3 feet should be maintained between your HDTV and any heat source, such as a radiator, heater, oven, amplifier etc. Do not install your HDTV close to smoke. Operating your HDTV close to smoke or moisture may cause fire or electric shock.
- Slots and openings in the back and bottom of the cabinet are provided for ventilation. To ensure reliable operation of your HDTV and to protect it from overheating, be sure these openings are not blocked or covered. Do not place your HDTV in a bookcase or cabinet unless proper ventilation is provided.
- Never push any object into the slots and openings on your HDTV cabinet. Do not place any objects on the top of your HDTV. Doing so could short circuit parts causing a fire or electric shock. Never spill liquids on your HDTV.
- Your HDTV should be operated only from the type of power source indicated on the label. If you are not sure of the type of power supplied to your home, consult your dealer or local power company.
- Do not apply pressure or throw objects at your HDTV. This may compromise the integrity of the display. The manufacturer's warranty does not cover user abuse or improper installations.
- The power cord must be replaced when using different voltage than the voltage specified. For more information, contact your dealer.
- Your HDTV is equipped with a **three-pronged grounded plug (a plug with a third grounding pin)**. This plug will fit only into a grounded power outlet. This is a safety feature. If your outlet does not accommodate the three-pronged, have an electrician install the correct outlet, or use an adapter to ground your HDTV safely. **Do not defeat the safety purpose of the grounded plug.**
- When connected to a power outlet, power is always flowing into your HDTV. To totally disconnect power, unplug the power cord.

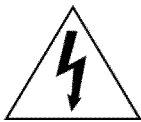

- The lightning flash with arrowhead symbol within an equilateral triangle is intended to alert the user to the presence of un-isolated, dangerous voltage within the inside of your HDTV that may be of sufficient magnitude to constitute a risk of electric shock to

persons.

- The exclamation point within an equilateral triangle is intended to alert the user to the presence of important operating and servicing instructions in the literature accompanying your HDTV.



- Do not overload power strips and extension cords. Overloading can result in fire or electric shock.
- The wall socket should be installed near your HDTV and easily accessible.
- Only power of the marked voltage can be used for your HDTV. Any other voltage than the specified voltage may cause fire or electric shock
- Do not touch the power cord during lightning. To avoid electric shock, avoid handling the power cord during electrical storms.
- Unplug your HDTV during a lightning storm or when it will not be used for long period of time. This will protect your HDTV from damage due to power surges.
- Do not attempt to repair or service your HDTV yourself. Opening or removing the back cover may expose you to high voltages, electric shock, and other hazards. If repair is required, contact your dealer and refer all servicing to qualified service personnel.
- Keep your HDTV away from moisture. Do not expose your HDTV to rain or moisture. If water penetrates into your HDTV, unplug the power cord and contact your dealer. Continuous use in this case may result in fire or electric shock.
- Do not use your HDTV if any abnormality occurs. If any smoke or odor becomes apparent, unplug the power cord and contact your dealer immediately. Do not try to repair your HDTV yourself.
- Avoid using dropped or damaged appliances. If your HDTV is dropped and the housing is damaged, the internal components may function abnormally. Unplug the power cord immediately and contact your dealer for repair. Continued use of your HDTV may cause fire or electric shock.
- Do not install your HDTV in an area with heavy dust or high humidity. Operating your HDTV in environments with heavy dust or high humidity may cause fire or electric shock.
- Follow instructions for moving your HDTV. Ensure that the power cord and any other cables are unplugged before moving your HDTV.
- When unplugging your HDTV, hold the power plug, not the cord. Pulling on the power cord may damage the wires inside the cord and cause fire or electric shock. When your HDTV will not be used for an extended period of time, unplug the power cord.
- To reduce risk of electric shock, do not touch the connector with wet hands.
- Insert batteries in accordance with instructions. Incorrect polarities may cause the batteries to leak which can damage the remote control or injure the operator.
- If any of the following occurs, contact the dealer:
 - The power cord fails or frays.
 - Liquid sprays or any object drops into your HDTV.
 - Your HDTV is exposed to rain or other moisture.
 - Your HDTV is dropped or damaged in any way.
 - The performance of your HDTV changes substantially.



Television Antenna Connection Protection

External Television Antenna Grounding

If an outside antenna/satellite dish or cable system is to be connected to the TV, make sure that the antenna or cable system is electrically grounded to provide some protection against voltage surges and static charges.

Article 810 of the National Electrical Code, ANSI/NFPA 70, provides information with regard to proper grounding of the mast and supporting structure, grounding of the lead-in wire to an antenna discharge unit, size of the grounding conductors, location of antenna discharge unit, connection to grounding electrodes, and requirements of the grounding electrode.

Lightning Protection

For added protection of the TV during a lightning storm or when it is left unattended or unused for long periods of time, unplug the TV from the wall outlet and disconnect the antenna or cable system.

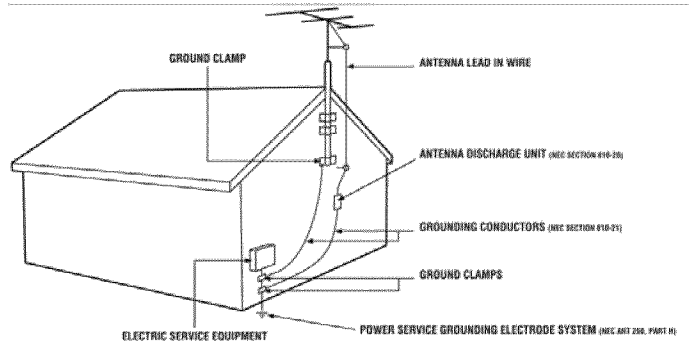

Power Lines

Do not locate the antenna near overhead light or power circuits, or where it could fall into such power lines or circuits.

Remember, the screen of the coaxial cable is intended to be connected to earth in the building installation.

FCC Bulletin for New TV Owners

The nationwide switch to digital television broadcasting will be complete on June 12, 2009, but your local television stations may switch sooner. After the switch, analog-only television sets that receive TV programming through an antenna will need a converter box to continue to receive over-the-air TV. Watch your local stations to find out when they will turn off their analog signal and switch to digital-only broadcasting. Analog-only TVs should continue to work as before to receive low power, Class A or translator television stations and with cable and satellite TV services, gaming consoles, VCRs, DVD players, and similar products.

For additional information, please contact the parties listed below, as appropriate:

FCC (US Federal Communications Commission)

<http://www.fcc.gov/>

Phone: 1-888-CALL-FCC (1-888-225-5322)

TTY: 1-888-TELL-FCC (1-888-835-5322)

Fax: 1-866-418-0232

E-mail: fccinfo@fcc.gov

NTIA (National Telecommunications and Information Administration)

<http://www.ntia.doc.gov/> 1-888-DTV-2009

Listings of US Television Stations: <http://www.high-techproductions.com/usTVstations.htm>

Note: Your HDTV comes with a built-in tuner capable of processing digital broadcasts. No extra converter box is needed.



Table of Contents

Important Safety Instructions.....	2
Television Antenna Connection Protection	4
FCC Bulletin for New TV Owners.....	4
CHAPTER 1 SETTING UP YOUR HDTV.....	8
Attaching the TV Stand.....	8
Unpack the TV and stand base:.....	8
Attach the TV stand base:.....	8
Detach the TV stand base:.....	9
Wall Mounting Your HDTV	9
CHAPTER 2 BASIC CONTROLS AND CONNECTIONS.....	10
Front Panel	10
Side Control Panel.....	10
Rear Panel Connections.....	11
Side Panel Connections	12
CHAPTER 3 VIZIO REMOTE CONTROL	13
Installing the Batteries	13
Remote Control Range.....	13
VIZIO Remote Control Precautions.....	13
Remote Control Buttons	14
CHAPTER 4 GETTING STARTED.....	15
CHAPTER 5 USING YOUR HDTV FOR THE FIRST TIME	16
Select Input Source	16
Watching a TV Program	16
Viewing Digital TV Program Information	17
INFO Button	17
CHAPTER 6 CONNECTING EQUIPMENT	18
Which Video Connection Should I Use ?	18
Connecting Your DVD Player.....	22
Using HDMI (Best).....	22
Connecting Coaxial (RF)	24
Using Your Antenna or Digital Cable for Standard TV or Digital TV.....	24
Connecting Your VCR or Video Camera.....	24
Connecting a Home Theater System	25
Connecting a Computer.....	25
CHAPTER 7 YOUR HDTV SETTINGS	26
Using the HDTV Settings Menu	26
TV Menu	26
Timer Menu	26
Photo Menu	26
Wide Menu	26
Audio Menu	27
Picture Menu	27
Parental Menu	27
Help Menu	27
CC (Closed Caption) Menu	27
CHAPTER 8 ADJUSTING YOUR HDTV SETTINGS	28
TV Settings	28



Input	28
PC Settings	29
Timer Menu	30
Photo Menu	30
Wide Menu	31
Audio Menu	33
Picture Menu	34
Parental Menu	36
Help Menu	38
System Info	38
CC (Closed Caption) Menu	38
CHAPTER 9 MAINTENANCE AND TROUBLESHOOTING	39
Cleaning the TV and Remote Control	39
Troubleshooting Guide	39
Telephone & Technical Support	42
Compliance.....	42
FCC Class B Radio Interference Statement	43
CHAPTER 10 SPECIFICATIONS	44
Preset PC Resolutions	47
CHAPTER 11 WARRANTY.....	49
Index.....	51



Opening the Package

Your HDTV and its accompanying accessories are carefully packed in a cardboard carton that has been designed to protect it from transportation damage. Once you have opened the carton, check that your HDTV is in good condition and that all of the contents are included.

The screen surface can easily be scratched or broken, so handle your HDTV gently and never place your HDTV with the screen facing downwards on a surface without protective padding.

IMPORTANT: Save the carton and packing material for future shipping.

Package Contents

- VIZIO M190VA or M220VA or M260VA
- VIZIO remote control VR10 or VR10W (Depending on your TV color)
- 2 AA batteries for the remote control
- This user manual
- Cleaning cloth
- Quick Setup Guide
- Registration Card

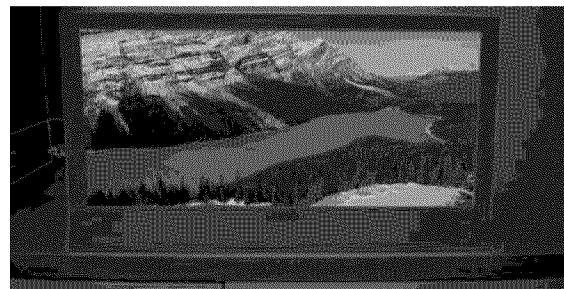
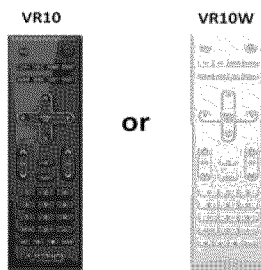

Reminder: These models are either black or white.

Caution: Do not apply pressure or throw objects at your HDTV. This may compromise the integrity of the display. The manufacturer's warranty does not cover user abuse or improper installations.

HDTV Accessories and Services

Additional certified accessories for your HDTV are sold separately, including:

- Wall mounts
- High Definition cables
- Extra or replacement remote controls
- Sound Bars
- Blu-ray DVD Players

VIZIO also offers installation services and extended warranty services for your HDTV.

To purchase or inquire about additional accessories and services for your VIZIO HDTV, visit our website at www.VIZIO.com or call us toll free at **877-MYVIZIO** (877-698-4946).



Chapter 1 Setting Up Your HDTV

- Read this user manual carefully before installing your HDTV.
- The power consumption of your HDTV is 25W (M190VA), 28W (M220VA) and 44W (M260VA) average. When an extension cord is required, use one with the correct power rating. The cord must be grounded and the grounding feature must not be compromised.
- Install your HDTV on a flat surface to avoid tipping.
- For proper ventilation, you must allow a 1" space between the back of your HDTV and the wall.
- Avoid installing your HDTV in places with high humidity, dust, or smoke so you do not shorten the service life of the electronic components.
- Install your HDTV in a level, landscape orientation, with the VIZIO logo at the bottom to prevent poor ventilation and excessive component damage.
- If you want to mount your HDTV on the wall, see below for additional information.
- Read this user manual carefully before installing your HDTV.

VIZIO offers professional installation. Contact VIZIO for more information on these services at **877-MYVIZIO** (877-698-4946) or www.VIZIO.com.

Attaching the TV Stand

Unpack the TV and stand base:

1. Remove the remote control, batteries, and base.
2. Remove the TV from the box and lay it face down on a clean, flat surface.

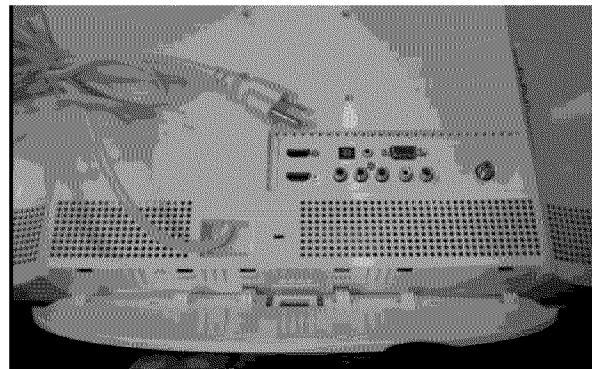
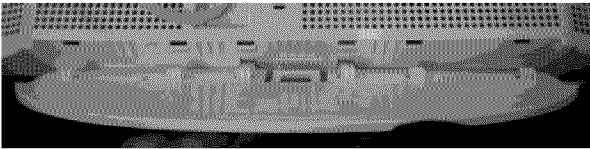

Note: Make sure that the surface is free of debris to prevent the TV screen from getting scratched.

Attach the TV stand base:

1. Align the stand hooks with the holes at the bottom surface of TV.
2. Push the base gently into place.
3. A snap sound could be heard, it means that the base is locked into place.

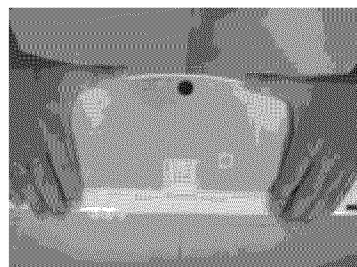
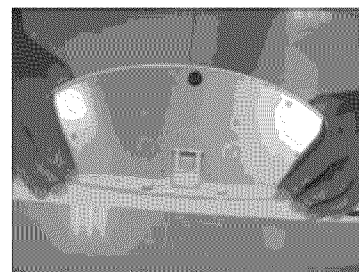
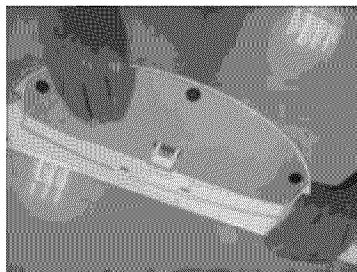

Detach the TV stand base:

1. Lay the HDTV face down on a clean, flat surface.
2. Pull up on the locking clip, release it, and then slowly slide the base towards you.

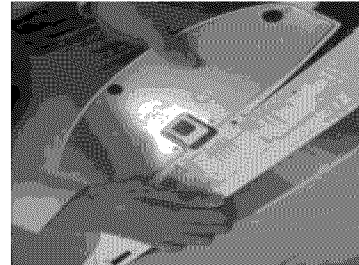
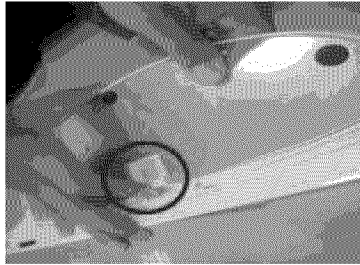

Wall Mounting Your HDTV

Your HDTV can be mounted on the wall for viewing. If you choose to mount your HDTV on the wall, follow the instructions below.

1. Write down the serial number located on the back of your HDTV in the space provided on page 1 to have it handy if you need to call for support.
2. Remove the stand base and neck:
 - a. Disconnect the cables from your HDTV.
 - b. Place your HDTV face down on a soft, flat surface to prevent damage to the screen.
 - c. Remove the TV stand base per above instructions.
3. Mount your HDTV on the wall:
 - a. Attach your HDTV to a wall mount (sold separately) using the mounting holes in the back panel of your HDTV (see illustration at the right).
 - b. Read the instructions that came with your specific wall mount to properly hang your HDTV.

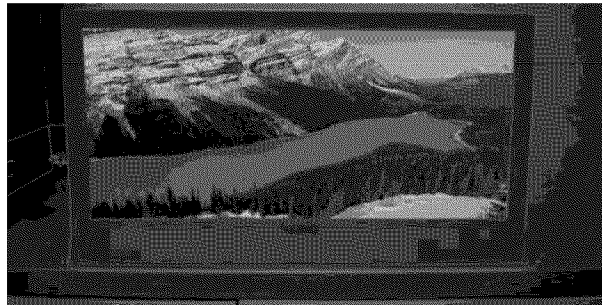

Wall Mounting Specifications	
Screw Size	• M4
Screw Length	• 10mm
Screw Pitch	• 0.7 mm
Hole Pattern	• VESA standard 75 x 75 mm (M190VA and M220VA) • VESA standard 100 x 100 mm (M260VA)

NOTE: If using wall mounts different from our certified ones, please verify that they are UL/CSA/ETL listed wall mount brackets with suitable weight specs.



Chapter 2 Basic Controls and Connections

Front Panel

Remote Control Sensor—Point the remote control directly at this window on the lower right corner of your HDTV for the best response to the remote signal.



Side Control Panel

1. LIGHT SENSOR—Activate it through the OSD menu if you would like the TV to automatically adjust to the ambient lighting of the room. This location applies only to the 19" models, the 22" and 26" models have the sensor placed on the power light indicator area.

2. POWER ()—Turn your HDTV on by pressing the button once. Press the button again to turn your HDTV off.

3. MENU—Press to launch the on-screen menu. If a sub-menu is active, this button will proceed to the next level.

4. CH ▲/▼—Press to change the channels up or down. While the menu is active, these buttons function as up and down controls.

5. VOL ▲/▼—Press to increase or decrease the speaker volume. While the menu is active, these buttons function as left and right controls.

6. INPUT (SELECT)—Press to cycle through the various devices connected to your TV (called Inputs). The inputs cycle in the following sequence: DTV/TV, AV (Composite), COMPONENT, HDMI 1, HDMI 2, RGB (VGA) and PHOTO. Once you have stepped through the entire sequence, you will return to the beginning. If a sub-menu is active, pressing this button will return to the previous menu level. Additionally, when the menu is active, this button confirms the menu function to be adjusted.

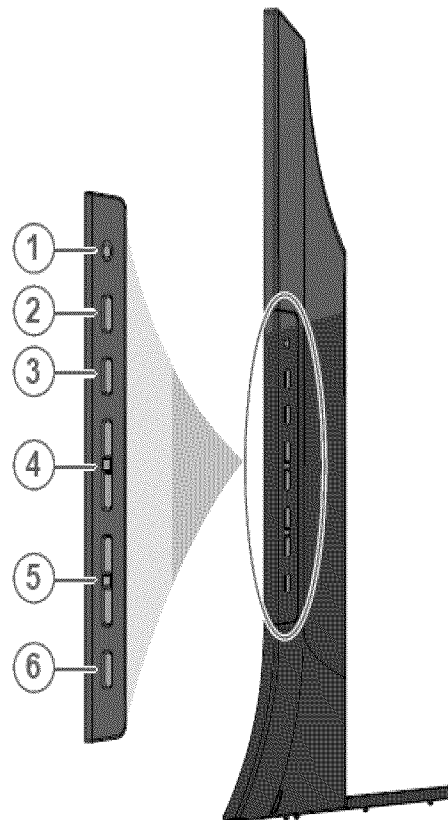

Rear Panel Connections

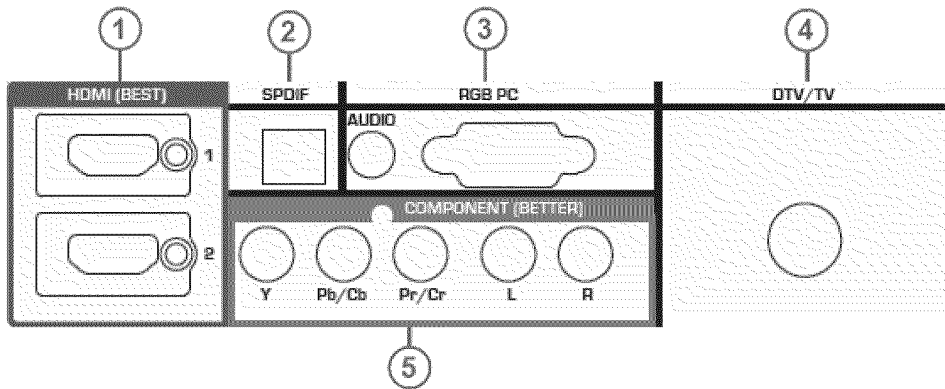

1. **HDMI 1**—Connect digital video devices such as a DVD player or Set-Top Box through these all digital connectors. For users who want to connect to a DVI enabled device, use a DVI-HDMI cable and connect the analog audio output of the device to the 1/8" stereo jack called AUDIO, a Y-adapter may be needed.
HDMI 2—Connect another digital video device such as a DVD player or Set-Top Box through this all digital connector. For users who want to connect to a DVI enabled device, use a DVI-HDMI cable and connect the analog audio output of the device to the 1/8" stereo jack called AUDIO, a Y-adapter may be needed. Your VIZIO Certified HDMI-DVI cables are available for purchase from www.VIZIO.com or by calling **877-MYVIZIO** (877-698-4946).
2. **SPDIF**—(OPTICAL) When digital TV is selected for viewing, the audio associated with the programming will be available on the SPDIF Optical connector for connection to a VIZIO Sound Bar or your Home Theater system.
3. **RGB PC**— Connect the video and audio from a computer here. Connect a 1/8" mini plug stereo connector from the computer to the TV if you want the sound to come from the HDTV speakers.
4. **DTV/TV**— Connect to an antenna or digital cable source. For digital TV stations in your area visit www.antennaweb.org. For cable and satellite set-top boxes, we recommend that you use a HDMI or component cable connection for high definition image quality.
5. **COMPONENT (Y Pb/Cb Pr/Cr)**—Connect component video devices such as a DVD Player or set top box here.

Below picture applies to black color models

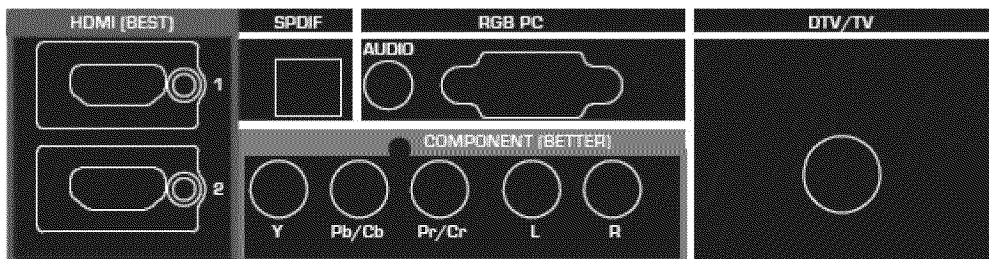

Side Panel Connections

1. **HEADPHONES**— Connect your personal headphones here.
2. **AV**— Connect composite video devices, such as a VCR or game console. Use the white and red connectors to connect the external audio from the same source.
3. **USB PORT**—Insert a FAT/FAT32 formatted USB drive to view pictures. This port is also used for service.

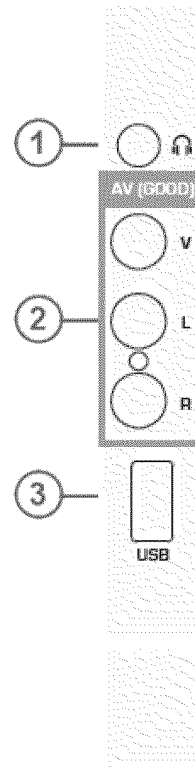

Below picture applies to black color models



Chapter 3 VIZIO Remote Control

Installing the Batteries

1. Remove the battery cover.
2. Insert two AA batteries into the remote control. Make sure that you match the (+) and (-) symbols on the batteries with the (+) and (-) symbols inside the battery compartment.
3. Replace the battery cover.

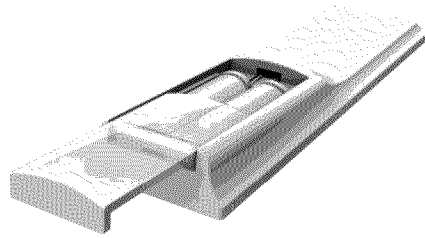

Precautionary Tips for Inserting the Batteries:

- Only use AA batteries.
- Do not mix new and old batteries. This may result in cracking or leakage that may cause a fire or lead to personal injury.
- Inserting the batteries incorrectly may also result in cracking or leakage that may cause a fire or lead to personal injury.
- Dispose of batteries according to local hazardous waste regulations.
- Keep the batteries away from children and pets.

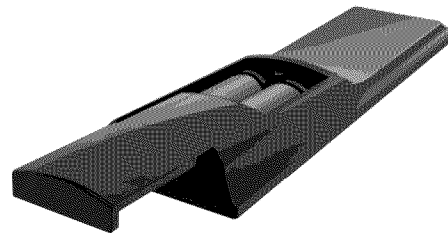

Remote Control Range

- Point the remote control directly at this sensor for the best response to the remote signal.
- Do not place any obstacles between the remote control and the remote control sensor.
- The effective range of the remote control is approximately 22 feet (7 meters) from the front of the remote control sensor, 30° to the left and right, 15° up and down.



VIZIO Remote Control Precautions

- The remote control should be kept dry and away from heat sources. Avoid humidity.
- If the TV responds erratically to the remote control or does not respond at all, check the batteries. If the batteries are low or exhausted, replace them with fresh batteries.
- When not using the remote control for a long period of time, remove the batteries.
- Do not take the batteries apart, heat them, or throw them into a fire.
- Do not subject the remote control to undue physical stress, such as striking or dropping it.
- Do not attempt to clean the remote control with a volatile solvent. Wipe it with a clean, damp cloth.



Remote Control Buttons

INPUT—Press to cycle through the various devices connected to your TV (called Inputs). The inputs cycle in the following sequence: DTV/TV, AV (Composite), COMPONENT, HDMI 1, HDMI 2, RGB and USB. Once you have stepped through the entire sequence, you will return to the beginning.

POWER ()—Press to turn the TV on from the Standby mode. Press it again to return to the Standby mode.

TV—Press to select the TV input.

AV—Press to select the AV (Composite) input.

COMP—Press to select the Component input.

HDMI—Press to select the HDMI input. Press repeatedly to cycle between both HDMI inputs.

SLEEP—Press to select the Sleep Timer options: Off, 30, 60, 90 or 120 minutes.

WIDE—Press to cycle through the available aspect ratios or screen formats, the options are Normal, Wide, Zoom, Panoramic and Stretch.

CC (Closed Caption)—Press to select the Closed Caption option. The options are: Off, CC1, CC2, CC3 and CC4 for analog signals and Off, Service1 through Service6 for digital signals when they are being broadcast.

EXIT— Press to exit from open menus.

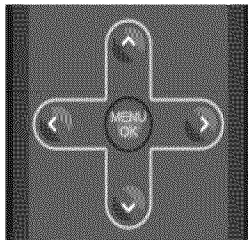

Up (▲), Down (▼), Left (◀) or Right (▶) navigation buttons — Press to navigate open menus, adjust other TV settings such as Brightness and Contrast, or turn menu options On and Off.

MENU/OK— Press to bring up the OSD menu. When the OSD menu is up, pressing this key

select the highlighted option in the menu.

VOL ▲/▼—Press to turn the volume up or down.

CH ▲/▼—Press to change the channels up or down.

MUTE  —Press to turn the sound on and off.

LAST— Press to recall the previously viewed channel. When the Menu is active, press this button repeatedly to go to the previous level or out of the On Screen Menu completely.

Number Button Pad—Press to select a channel or enter a password.

INFO—Press to display program and channel information.

- (**DASH**) —Press to insert a dash between the main and sub-channels. For example, channel 28-2 would be selected by the button sequence 2, 8, DASH, 2.

The following keys do not function on these models:

Pause (II)—Press to pause live TV. It does not apply to this model.

Play (▶)—Press to start playing the recorded programming when in *Pause Live TV mode*. It does not apply to this model.

Stop (■)—Press to take you out of *Pause Live TV mode* and back to live TV. It does not apply to this model.

GUIDE— Press to display program information. It does not apply to this model.

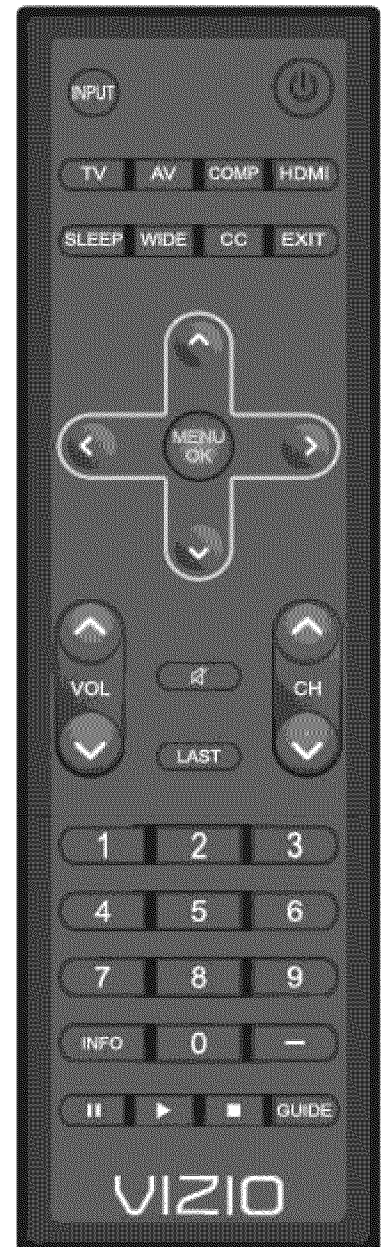

Chapter 4 Getting Started

Your HDTV has a built-in setup Wizard that runs when you turn on your TV for the first time. Follow the on-screen directions to easily setup your new HDTV.

1. Insert the batteries into the remote control.
2. Plug the attached power cord into an AC wall socket.
3. Connect your devices to your HDTV (see Chapter 6 for detailed steps).
4. Turn on your TV. The Setup Wizard will automatically play and guide you thru the initial setup of your HDTV. Use the Arrow and MENU/OK buttons to navigate through the setup App. During the setup process you will:
 - Choose your Menu language
 - Select the TV to Home Mode for the best picture and most efficient energy usage.
 - Select the signal input (Antenna or Cable)
 - Scan your TV channels (unless you have a Cable/Satellite Set-Top Box)

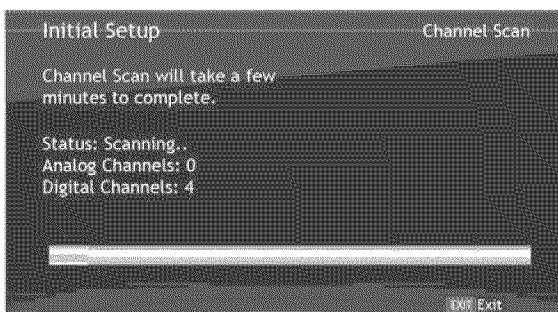
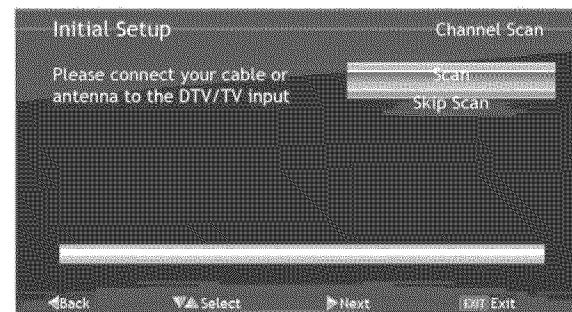
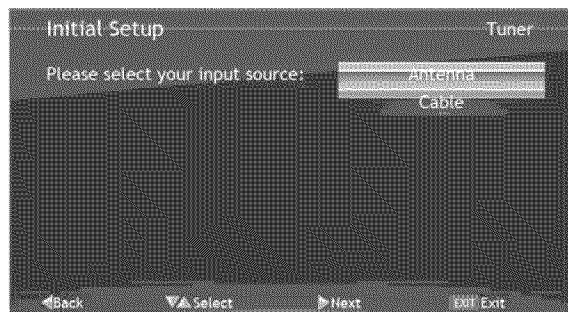
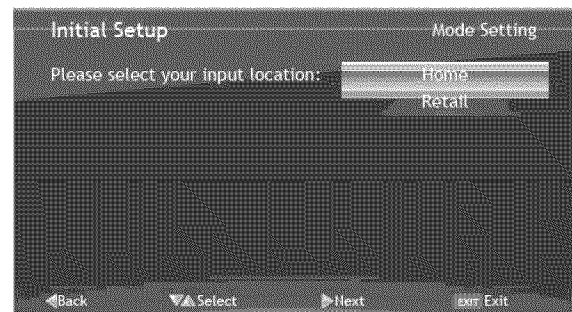

Chapter 5 Using your HDTV for the first time

Select Input Source

Select the input source for your HDTV by pressing the **INPUT** button on the remote control or the side of your TV. Pressing this button will cycle you through the following options: DTV/TV, AV, COMPONENT, HDMI 1, HDMI 2, RGB, and PHOTO.

Turn on your device and you will see a picture on your HDTV. If there is no picture, make sure you have selected the correct input on your HDTV.

Note: If the selected device is RF connected, your HDTV needs to be in **TV** mode and on either channel 3 or channel 4 matching the channel which has been selected on the back of the VCR, Cable Box, External TV Tuner or Satellite Receiver. Please refer to the User's Manual of the respective equipment for details.

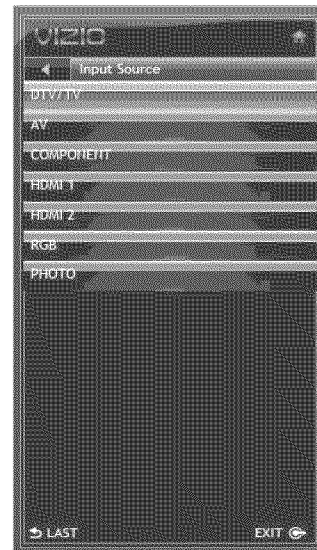

Watching a TV Program

Before you start watching TV, please make sure that any cable, satellite or off-air antenna connections are secure. Also, verify that the AC power cord is plugged into a correctly grounded electrical outlet or surge protector.

1. Press the power button on the remote control.
2. Select the input to which your device is connected that provides TV programming (e.g. TV, HDMI, COMP).

Note: You should be able to see a picture. If you do not, make sure that all of your HDTV connections are secure and you have selected the correct video input source. Each press of the **INPUT** button on the remote control will cycle through the available inputs. Press the button until the input associated with the device you want to view is shown.

3. When using the TV input, press the channel buttons on the remote control or the CH ▲ or ▼ buttons to change the channel. The Channel buttons and on the remote, control will not work if you are watching a program using HDMI, Component, or AV (Composite video) inputs.



Viewing Digital TV Program Information

INFO Button

When you press the **INFO** button, an information header is shown over the picture for a few seconds. Each press of the **INFO** button will display more information about the program:

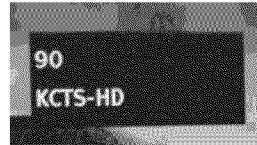

Press a second time, you will see the following display:

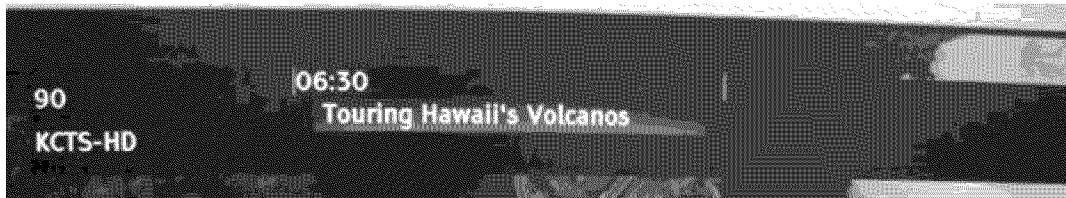



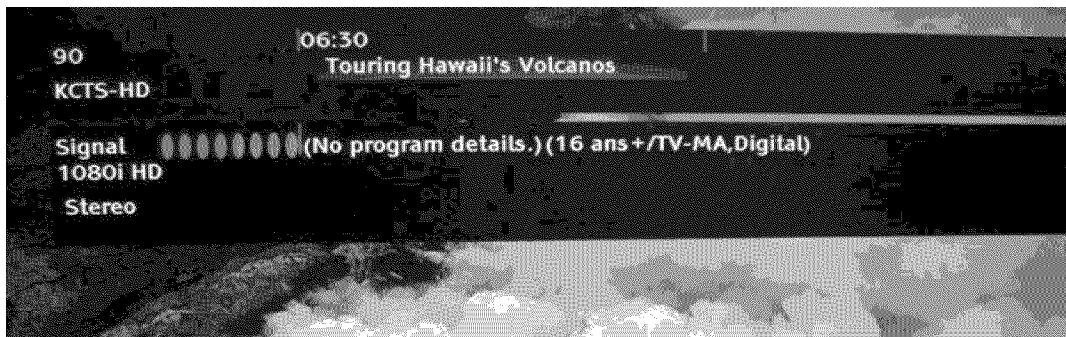

Press a third time and the display should be as shown below



Chapter 6 Connecting Equipment

Which Video Connection Should I Use ?

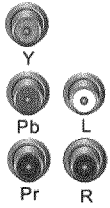
You have six options for connecting your video equipment box to your HDTV from a basic connection to the most advanced for digital displays. Based on your Home Theater configuration, you can decide which option is the right one for you.

Connection Quality (type)	Connector	Description
Best (digital)	 HDMI	HDMI delivers the best image quality of any of the cable types available and it's all done over one cable. You get a great picture and cut down on your cable clutter. HDMI provides digital quality and amazing sound so if your TV has HDMI, this is the connection type you should be using.
Best (digital) ----- Compatible (analog)		RF connects your TV antenna or cable service (no set-top box) by using a coaxial cable, this cable usually connects your TV directly from the wall to this input. When digital content is being received, this input delivers the best image quality.
Best (analog)	 VGA	The RGB (VGA) port allows you to connect your computer so you can use the TV as your monitor.
Better (analog)		Component consists of three cables for transmitting video and two cables for transmitting audio: one red and one white. Component video provides a sharper image than Composite video and should be used instead of composite when possible. However, because it is still an analog connection, it won't provide the superior quality video and audio that HDMI can produce.
Compatible (analog)		Composite consists of one yellow cable for transmitting video and two cables for transmitting audio: one red and one white. It is capable of transmitting stereo sound and standard definition video (480i). While it provides a good image, it has lower image quality than HDMI or Component. So try to use one of those connections first.

Note: To maintain the display quality, use a VIZIO certified HDMI cable. This cable is available in 6, 8, and 12 foot lengths. Visit www.vizio.com or call 1-888-VIZIOCE (1-888-849-4623) for details.



Connecting Your Cable or Satellite Box

Using HDMI (Best)

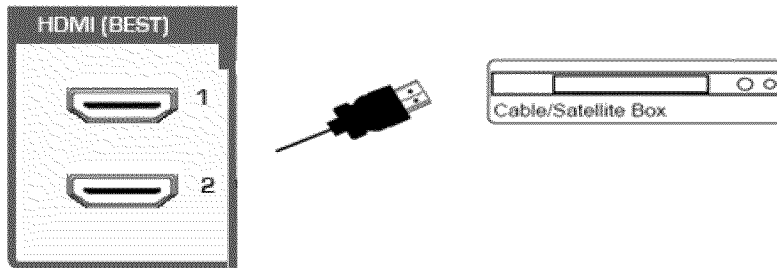

Cable and Satellite Boxes that have a HDMI digital interface should be connected using HDMI for optimal results. To maintain image quality, use a VIZIO certified HDMI cable. This cable is available in 6, 15, and 30 foot lengths. See www.VIZIO.com or call **877-MYVIZIO** (877-698-4946) for details.

1. Turn off your HDTV and Cable/Satellite Box.
2. Connect an HDMI cable to the HDMI output of your HDTV Set-Top Box and the other end to either **HDMI 1** or **HDMI 2** input on your HDTV.
3. Turn on the power to your HDTV and your Cable/Satellite Box.
4. Select **HDMI 1** or **HDMI 2** using the **INPUT** button on the remote control, or directly by pressing the **HDMI** button on the remote control.

Note:

- The HDMI input on your HDTV supports High-bandwidth Digital Content Protection (HDCP). HDCP encrypts the transmission between the video source and the digital display for added security and protection.
- Refer to your Cable/Satellite Set-Top Box user manual for more information about the video output requirements of the product or consult your cable or satellite operator.



HDMI Connections for Cable or Satellite Boxes with DVI

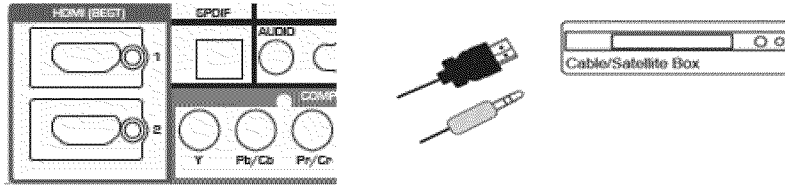

1. Turn off the power to your HDTV and HDTV Set-Top Box.
2. Using a HDMI-DVI cable, connect the DVI end to your HDTV Set-Top Box and the HDMI end to either **HDMI 1** or **HDMI 2** input on your HDTV.
3. Using a 1/8" stereo audio cable, connect the cable to the audio output (a Y-adaptor to phono jacks may be needed) connectors associated with the DVI output on your HDTV Set-Top Box and connect the other end to the audio connector associated with the HDMI input on your HDTV.
4. Turn on the power to your HDTV and your Cable/Satellite Box.
5. Select **HDMI 1** or **HDMI 2** using the **INPUT** button on the remote control, or directly by pressing the **HDMI** button on the remote control.

Using Component Video (Better)

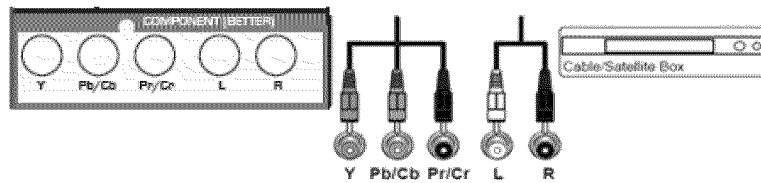

1. Turn off your HDTV and Cable/Satellite Box.
2. Connect the component cables (green, blue, and red) from your Cable/Satellite Box to the **COMPONENT** jacks on your HDTV.
3. Connect the audio cables (white and red) from your Cable/Satellite Box to the **COMPONENT L** and **R Audio** jacks on your HDTV.
4. Turn on your HDTV and Cable/Satellite Box.
5. Select **COMPONENT** using the **INPUT** button on the remote control, or directly by pressing the **COMP** button on the remote control.



Using Composite Video (Compatible)

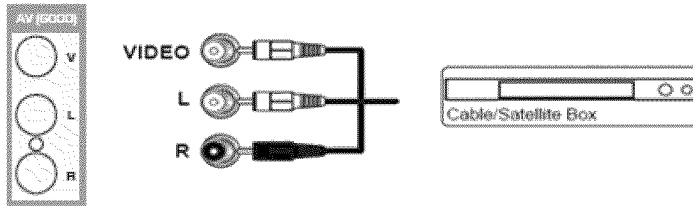

1. Turn off your HDTV and Cable/Satellite Box.
2. Connect the video cable (yellow) from your Cable/Satellite Box to the **AV** jack (yellow) on your HDTV.
3. Connect the audio cables (white and red) from your Cable/Satellite Box to the corresponding **L** and **R AUDIO** jacks on your HDTV.
4. Turn on your HDTV and Cable/Satellite Box.
5. Select **AV** using the **INPUT** button on the remote control, or directly by pressing the **AV** button on the remote control.

Using Coaxial (Antenna Compatible)

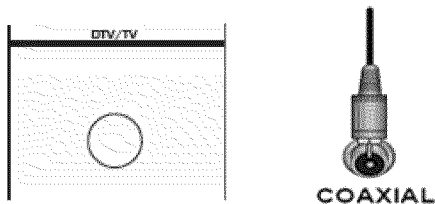

1. Turn off the power to your HDTV.
2. Connect the coaxial (RF) connector from your Cable Set-Top Box or Satellite Set Top Box to the **DTV/TV** connector on your HDTV.
3. Turn on the power to your HDTV.
4. Select **TV** using the **INPUT** button on the remote control, or directly by pressing the **TV** button on the remote control.
5. Perform an Auto Channel scan. See *Adjusting Your HDTV/TV Settings* for more information.



Connecting Your DVD Player

Using HDMI (Best)

DVD players that have a HDMI digital interface should be connected using HDMI for optimal results. To maintain image quality, use a VIZIO certified HDMI cable. This cable is available in 6, 15, and 30 foot lengths. See www.VIZIO.com or call **877-MYVIZIO** (877-698-4946) for details.

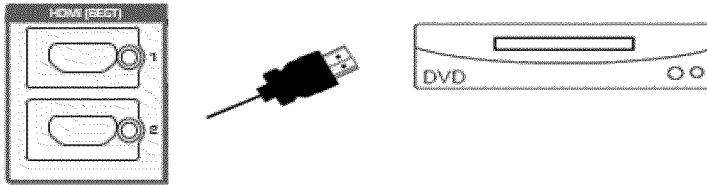

1. Turn off your HDTV and DVD player.
2. Connect a HDMI cable to the HDMI output of your DVD player and the other end to either **HDMI 1** or **HDMI 2** inputs on your HDTV.
3. Turn on the power to your HDTV and your DVD player.
4. Select **HDMI 1** or **HDMI 2** using the **INPUT** button on the remote control, or directly by pressing the **HDMI** button on the remote control.

Note:

- The HDMI input on your HDTV supports High-bandwidth Digital Content Protection (HDCP). HDCP encrypts the transmission between the video source and the digital display for added security and protection.
- Refer to your DVD player user manual for more information about the video output requirements.

HDMI Connections for DVD Player with DVI

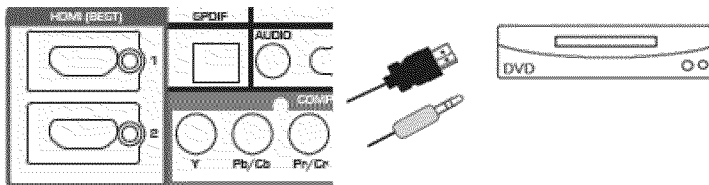

1. Turn off your HDTV and DVD player.
2. Using a HDMI-DVI cable, connect the DVI end to your DVD player and the HDMI end to either **HDMI 1** or **HDMI 2** Input on your HDTV.
3. Connect the audio cables (white and red) from the DVI audio output jacks on the DVD player to the 1/8" audio input jack on your HDTV. You may need to use a 1/8" Y stereo adapter.
4. Turn on the power to your HDTV and your DVD player.
5. Select **HDMI 1** or **HDMI 2** using the **INPUT** button on the remote control, or directly by pressing the **HDMI** button on the remote control.



Using Component Video (Better)

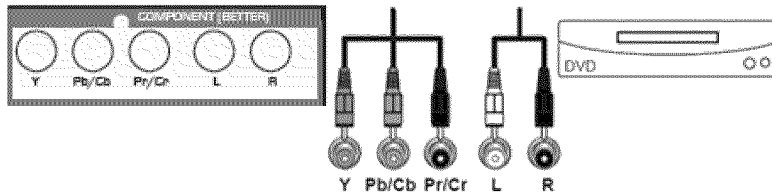

1. Turn off the power to your HDTV and DVD player.
2. Connect the component cable (green, blue, and red) from your DVD player to the **COMPONENT** jacks on your HDTV.
3. Connect the audio cables (white and red) from your DVD player to the **COMPONENT L** and **R AUDIO** jacks on your HDTV.
4. Turn on the power to your HDTV and DVD player.
5. Select **Component** using the **INPUT** button on the remote control, or directly by pressing the **COMP** button on the remote control.

Using Composite (AV) Video (Compatible)

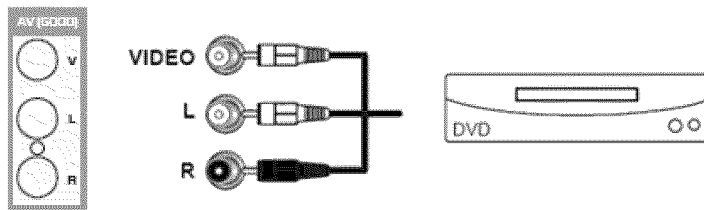

1. Turn off the power to your HDTV and DVD player.
2. Connect the video cable (yellow) from your DVD player to the **AV** jack on your HDTV.
3. Connect the audio cables (white and red) on your DVD player to the **L** and **R AUDIO** jacks on your HDTV.
4. Turn on the power to your HDTV and DVD Player.
5. Select **AV** using the **INPUT** button on the remote control, or directly by pressing the **AV** button on the remote control.



Connecting Coaxial (RF)

Using Your Antenna or Digital Cable for Standard TV or Digital TV

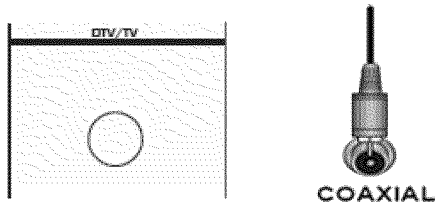

1. Turn off the power to your HDTV.
2. Connect the coaxial (RF) connector from your antenna or cable to the **DTV/TV** connector on your HDTV.
3. Turn on the power to your HDTV.
4. Select **TV** using the **INPUT** button on the remote control, or directly by pressing the **TV** button on the remote control.
5. Perform an Auto Channel scan. See Adjusting Your HDTV/TV Settings for more information.

Connecting Your VCR or Video Camera

Using AV

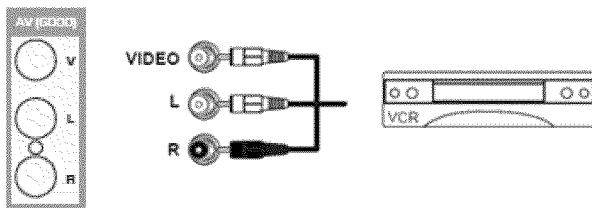

1. Turn off the power to your HDTV and VCR or Video Camera.
2. Connect the yellow AV cable from your VCR or video camera to the **AV** jack on your HDTV.
3. Connect the audio cables on your VCR or video camera to the corresponding **L** and **R AUDIO** jacks on your HDTV.
4. Turn on the power to your HDTV and VCR or Video Camera.
5. Select **AV** using the **INPUT** button on the remote control or side of the TV.

Note: Refer to your VCR or Video Camera user manual for more information about the video output requirements of the product.



Connecting a Home Theater System



If your sound system has a SPDIF (optical) digital audio input you can connect it to the **OPTICAL** digital audio out on the back of your HDTV. This is active when receiving audio with the content being viewed no matter which input is being used.

1. Connect one end of the optical cable to the optical connection on the Home Theater and the other end to the **SPDIF** jack on your HDTV.
2. Turn on the power to your HDTV and Home Theater.

Change the input on your Home Theater to optical. See your Home Theater user manual for more information.

Connecting a Computer

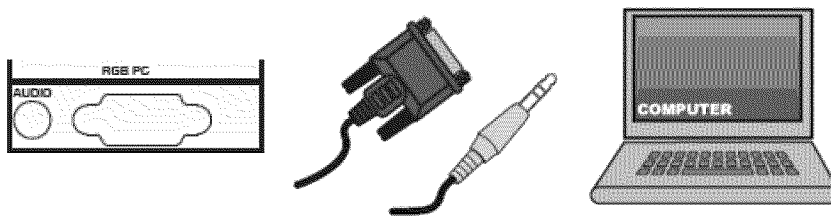

1. Set computer to a resolution supported by your HDTV. **If your computer supports it, we recommend 1920x1080 for the M220VA models.** (See *Preset PC Resolutions*).
2. Turn off the power to your HDTV and Computer.
3. Connect the VGA cable from your computer to the **RGB PC** jack on your HDTV.
4. Connect the 1/8-inch audio cable from your computer to the RGB PC **Audio** jack on your HDTV. This step is optional and only needed to transmit audio from the computer through the TV.
5. Turn on the power to your HDTV and computer.
6. Select **RGB** using the **INPUT** button on the remote control or side of your HDTV.

Note: Refer to your PC computer user manual for more information about the video output requirements.

Chapter 7 Your HDTV Settings

Using the HDTV Settings Menu

The remote control or the buttons on the front of the TV can control all the function settings. The *HDTV Settings Menu* allows you to adjust contrast, brightness and other settings. The TV will save changes made to the settings, even if the TV is turned off.

The *HDTV Settings Menu* consists of several menu options. The main menu options may vary depending on your selected input source.

Note: Some of the main menu options may have additional submenus, for example, the TV settings submenu for PC Settings.

1. Press the **MENU/OK** button on the remote control. The *HDTV Settings App* opens.
2. Use the navigation keys around the **MENU/OK** button to select one of the menu options.
3. Press **MENU/OK** to select the option or feature you want to adjust.
4. Once the menu option is displayed, press arrow Up or Down Navigation buttons to select one of the items to adjust.
5. Press **MENU/OK** to select, and then press Up, Down, Left or Right Navigation buttons to adjust the selection.
6. Press **LAST** once to return to the previous screen or repeatedly to exit the On Screen Menu completely when finished making adjustments.
7. Press **EXIT** to close the *HDTV Settings Menu*.

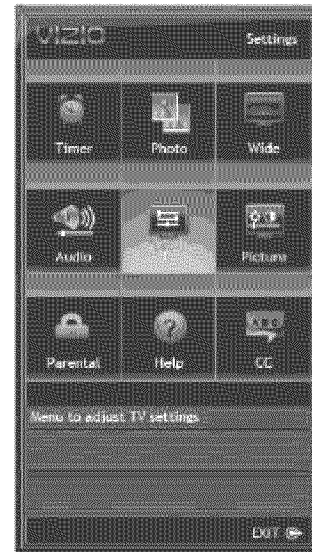

TV Menu

When first selected the OSD shows the TV menu as the default option for your HDTV, this menu provides the following options: Input, Channels, Menu Language, Date & Time and PC Setting.

Timer Menu

Select the timer to turn off the TV in 30, 60, 90, 120 minutes.

Photo Menu

This menu provides the user with the different parameters and options to make viewing photos more enjoyable. The options under this menu are: Photo, Sort, File and Thumbnail Size.

Wide Menu

Select how the picture displays on the screen. As you select through the options, you will see the screen adjusting to the different sizes. The options vary depending on the selected input and the TV program, the following are the different view modes: Normal, Wide, Zoom, Panoramic and Stretch.



Audio Menu

This menu provides all options to be adjusted to set the sound preferences from the built-in speakers. Under this menu the options are: SRS TruSurround HD™, SRS TruVolume™, Equalizer Settings, Bass & Treble, Balance, Speakers, Digital Audio Out, Analog MTS, Digital MTS and Reset Audio Mode.

Picture Menu

This menu provides the options to customize your preferences on the looks and feel of the content of the signal being viewed. The following are the different settings and options under this menu: Picture Mode, Noise Reduction, Fast Response, Ambient Light Sensor and Reset Picture Mode. If changes beyond these options are required, Picture Mode needs to be selected as Custom.

Parental Menu

This menu provides the user with the options to restrict the viewing of programs or content according to preset values and ratings provided by the signal being watched. If a Set-Top box is being used, these options could be part of the box settings. Please refer to your cable/satellite set-top box user manual for more information.

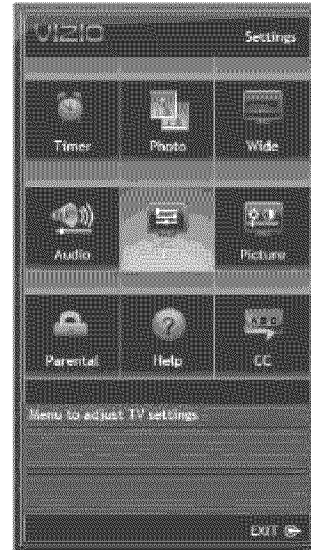

Help Menu

Under this menu you find the options to obtain the TV system information and the resetting of the TV settings to factory defaults.

CC (Closed Caption) Menu

This menu is used to setup the closed caption content (being received with the signal) according to your preferences. The following are the options under this menu: Analog Closed Caption, Digital Closed Caption and Digital CC Style.



Chapter 8 Adjusting Your HDTV Settings

The following is a more detailed description of the different OSD (On-Screen Display) menu settings and adjustments regarding the options and features which are part of your HDTV. Starting with the default TV Menu and then in sequence according to the main OSD menu.

It is recommendable to use your remote control navigation buttons to select the parameters to be adjusted.

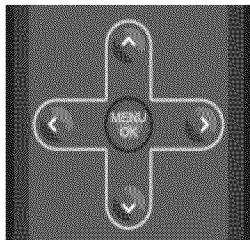

Up (▲), Down (▼), Left (◀) or Right (▶) navigation buttons — Press to navigate open menus, adjust other TV settings such as Brightness and Contrast, or turn menu options On and Off.

MENU/OK— Press to bring up the OSD menu. When the OSD menu is up, pressing this key select the highlighted option in the menu.

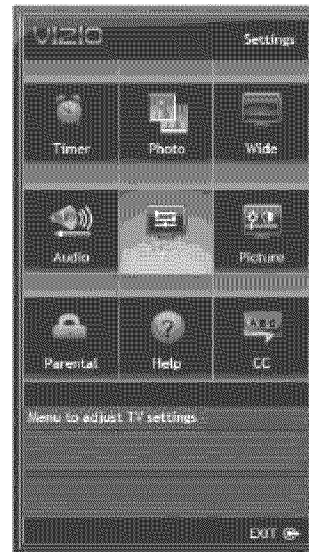

TV Settings

When you first turned on your HDTV you set up your TV for DTV / TV channels using the Initial Setup screens. If you did not do this or if your setup has changed, you can do this from the TV menu.

Input

1. **Input Source:** Select the Input Source for your HDTV. Choose from **DTV/TV**, **AV**, **COMPONENT**, **HDMI 1**, **HDMI 2**, **RGB**, and **PHOTO**.
2. **Input Naming:** Use this option to rename the input being watched to your preferred name; i.e. DTV/TV could be called Cable or Antenna.

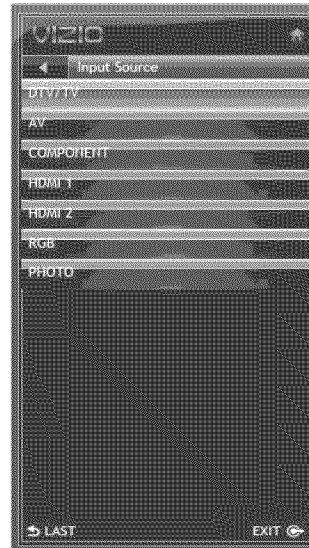

Channels

1. **Signal Source:** Select the type of signal (Antenna or Cable) being fed into the HDTV. This option is only for over the air signal or cable service without set-top box.
2. **Master List:** When selected this option displays the list of channels to which your TV can be tuned. It also allows selecting all channels (Mark All) or deselected all channels (Unmark All) as well as to select only the digital (Digital Only) channels.
3. **Additional Scan:** Selecting Additional Scan to On (activated) allows to scan for more channels without losing the channels already in the master list. This option is handy when relocating the TV or repositioning the direction of the antenna.
4. **Scan Channels:** If the original channel scanning had been skipped, this option allows you to perform this step. This option is also used after Additional Scan has been set to On.



5. **Channel Name Edit:** If it is desired to change the name of the channel to a more comprehensive or favorite name, this option provides you with a choice. A small keyboard will be displayed and using the navigation keys, you rename the channel to your preference.

Menu Language

This option allows changing the language being used on the OSD menu to either English or French or Spanish. English is the default language.

Date & Time

1. **Time Zone:** Select this option to set the correct time zone for you area, this will ensure that the correct time is shown when the INFO button on the remote control is pressed. The time zones are as follows: Newfoundland, Atlantic, Eastern, Central, Mountain, Pacific, Alaska, Hawaii, Indiana and Arizona.
2. **Daylight Saving:** When enabled, this option will automatically display the correct time in the zones in which Daylight Saving time applies.
3. **Auto Update:** If you decide to manually change the date and time, set this option to Disable. This will allow the navigation buttons to be used to make the changes.

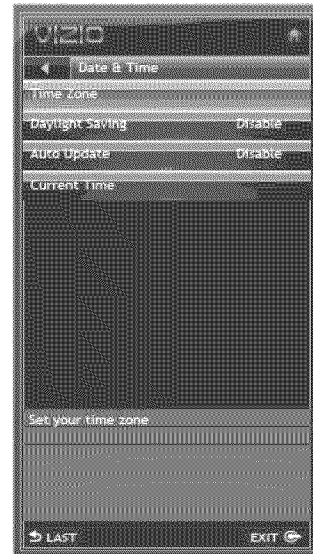

PC Settings

Select if you are connecting to your PC (computer). This option can only be selected when you are in the RGB input.

1. **Auto Sync:** The TV will automatically position and tune the display for optimum performance.
2. **Horiz. Position:** Adjust the horizontal (left/right) position of the image.
3. **Vertical Position:** Adjust the vertical (up/down) position of the image.
4. **Fine Tune:** Fine tunes the image for crisp content over the entire display area.



Timer Menu

Select this option to have the HDTV turning off automatically using increments of 30 minutes, the options are: Off, 30 minutes, 60 minutes, 90 minutes and 120 minutes. The default being Off.

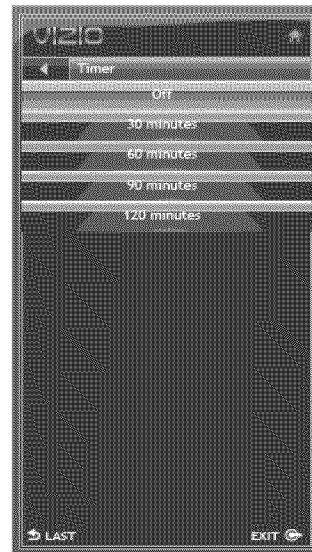

Photo Menu

When using a USB device with photos (.JPEG/.JPG files) as data, the following options and settings are available for you to use.

Note: The connected USB device must:

- Have a minimum 1 GB of memory.
- Be formatted as FAT32.
- Have a write speed higher than 10Mb/sec (USB1.1 or higher).
- Contain no other files.

Sort

Select to change the order of viewing the photos in the desired folder.

1. **Date:** Select it to organize your photos according to the date they were taken.
2. **Name:** Using this option will organize your photos according the file name in alphabetical order.

File

Select this option to organize your folders and photos.

1. **List:** This option shows your photos in the folder based on their names.
2. **Thumbnail:** This option displays your photos as thumbnails, making it easier to select them.

Thumbnail Size

Select this option to change the size of the thumbnails being displayed, the sizes are Small, Medium and Large.



Wide Menu

The following table shows the different screen modes and display sizes according to the content being sent to the HDTV.

Type	480p/480i(4:3)	720p(16:9)	1080i/1080p(16:9)	RGB(4:3)	RGB(16:9)
Content					
Normal					
Wide					
Zoom					
Panoramic					
Stretch					

Note: The red lines show the video signal being overscanned.

Normal	SD(4:3) with cropping 3% and maintain aspect. HD(16:9) with no cropping. RGB with no cropping.	Wide	SD (4:3) H & Vwith cropping 3%. HD (16:9) H & V with cropping 2.5%
Zoom	For signal with Letter Box, 4:3 signal --the H cropping: 3%. V cropping: 14% (reference only) 16:9 signal --the H cropping: 14%. V cropping: 14% (reference only)		
Panoramic	H & V overscan cropping 3% and stretched out full screen(Only for SD)		
Stretch	H overscan with cropping 12.5% V overscan with cropping 2.5%(Only for HD) RGB(4:3) extend to full screen RGB(16:9) H overscan with cropping 12.5%		



The following paragraphs describe in detail the differences of the Aspect Ratio being processed by the TV:

Normal Mode

The original 4:3 aspect ratio (1.33:1 source) is preserved, so black bars are added to the left and right of the display image. Standard TV broadcasts are displayed with a 4:3 Aspect Ratio. Movies in 4:3 Aspect Ratio may be referred to as pan-and-scan or full frame.

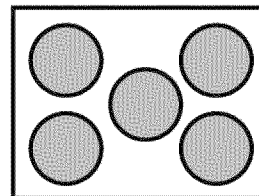

Wide Mode

When watching a standard broadcast or full-frame movie in this mode, the display image is stretched proportionately to fill the TV screen. When watching a widescreen (1.78:1 source) program or movie, the display image fills the TV screen. If you are watching a widescreen (1.85:1 or 2.35:1 source) program or movie, there will still be black bars at the top and bottom of the screen.

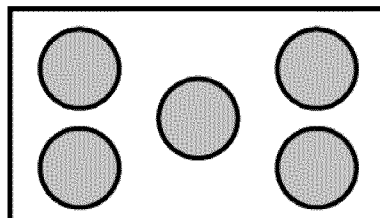

Zoom Mode

When watching a widescreen (1.78:1, 1.85:1, or 2.35:1 source) program or movie, the display image is zoomed proportionally to fill the width of the screen. The top and bottom are cut off to remove most of the source material's black bars. This mode is good for programs or movies with sub-titles.

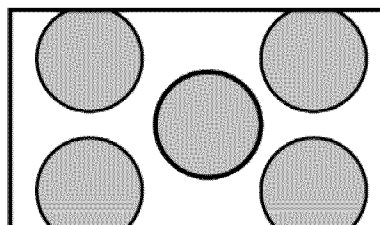

Panoramic Mode

When watching a standard broadcast or full frame movie in this mode, the 4:3 Aspect Ratio (1.33:1 source) display image is stretched horizontally on the left and right sides to fill the TV screen. The center of the image is not stretched.

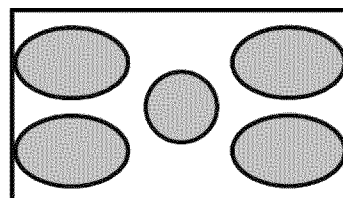

Stretch Mode

When watching a widescreen program (1.78:1 source) with black bars on the sides, the display image will stretch to fill the TV screen. People will appear wider than they really are. If you are watching a widescreen (1.85:1 or 2.35:1 source) program or movie, there will still be black bars at the top and bottom. This mode is available only when watching a widescreen program.

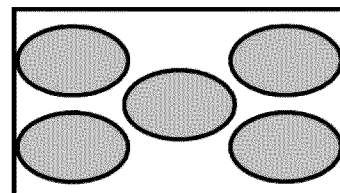

Audio Menu

Your HDTV sound is optimized by the use of SRS TruSurround HD™ and SRS TruVolume™ technologies, different options are available if you decide to explore the differences in HD Audio using the options.

SRS TruSurround HD™

This technology creates an immersive, feature-rich surround sound experience from two speakers, complete with rich bass, high frequency detail and clear dialog.

SRS TruVolume™

This technology provides the listener with a comfortable and consistent volume level, preventing the sudden fluctuations of the sound level. VIZIO recommends turning TruVolume off when listening to music content.

Note: When SRS TruSurround HD is ON, Equalizer adjustments are not available.

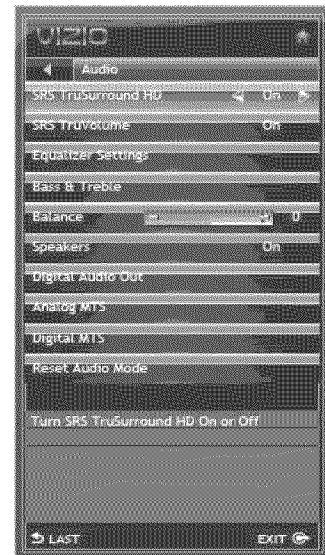

Equalizer Settings

To select this option it requires that the SRS TruSurround HD features to be Off (disable), the preset choices are: Off, Classical, Disco, Flat, Jazz, Pop and Rock.

Bass & Treble

These options allow setting the values of the low and high tones to your preference. Keep in mind that they are adjustable as long as the SRS feature is Off.

Balance

Using balance allows you to distribute the level of the sound evenly or either to the left or right audio channels.

Speakers

Selecting this option will allow to set the internal speakers either Off or On, especially, if the audio is being routed through your Home Theater System.

Digital Audio Out

If you are planning to process the audio out of your HDTV through a Home Theater System, it is recommended the use of this output and select either Auto or Force PCM option.

Analog MTS (Multichannel Television Sound)

This feature allows hearing the second audio program (SAP) when broadcast as well as to listen to simulated stereo sound if it is being used. The choices are Mono, Stereo and SAP.

Digital MTS

This option has the choices of English, French and Spanish languages.

Reset Audio Mode

Use this option when if you do not want to keep any changes made to the audio settings. It will reset the HDTV back to the factory defaults.



Picture Menu

This menu provides the options to customize your preferences on the looks and feel of the content of the signal being viewed.

Picture Mode

Use this option to adjust the different parameters of the content to satisfy your personal preferences. There are five preset modes: Home, Game, Movie, Retail and Photo which values cannot be adjusted and a sixth mode called Custom Mode which allows you to make the necessary adjustments.

Custom Mode

If selected, the following options and parameters are available to be adjusted to your preferences:

1. **Brightness:** Use this option to adjust the black levels. If the brightness is too low you will not be able to see the detail in darker parts of the picture and if the brightness is too high the picture will look washed out.
2. **Contrast:** Use this option to adjust the white levels. If the contrast is too low the picture will look washed out and if the contrast is too high you will not be able to see any detail in the bright parts of a picture.
3. **Color:** Use this option to adjust the saturation of colors in the image or picture.
4. **Tint:** Use this option to adjust the skin or flesh tone for a realistic appearance. If people's faces look too orange try reducing the level of color first.
5. **Sharpness:** Use this option to adjust the edge enhancement of the picture. It does not produce detail that otherwise does not exist. This adjustment is helpful when viewing Standard Definition sources.
6. **Backlight:** Use this option to adjust the brightness of the screen without affecting the Black and Contrast levels.
7. **Adaptive Luma:** Use this option to control the Average Picture Level (APL) which will prevent the overall picture from looking too light.
8. **Color Enhancement:** Use this option to increase the picture reproduction performance by reducing oversaturation of certain colors and improving flesh tones.

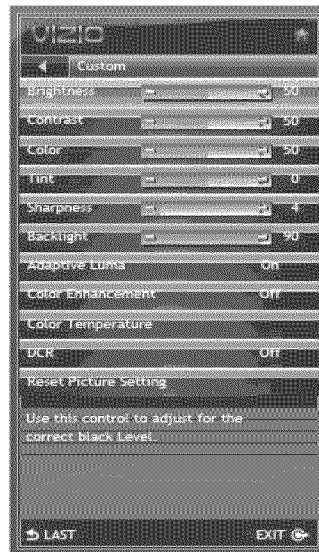
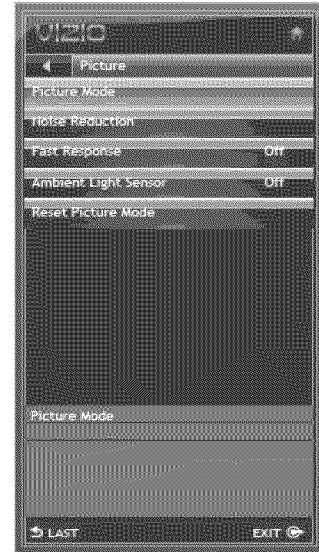

9. **Color Temperature:** Use this option to control the “warmness” or “coolness” of the white areas of the picture. Choose from **Custom**, **Cool**, **Normal**, or **PC**. **Normal** is the setting for television broadcasting. **Custom** allows you to set a preset calibrated for a white point to suit individual preferences. **Cool** produces a blue-hued image. **PC** sets the white point at the established setting for a computer display (7300K applies only to the 19” and 22” models while the 9300K applies to the 26” models). Each preset may also be adjusted for a customized setting.

10. **DCR (Dynamic Contrast Ratio):** Use this option to improve the black level performance and increase contrast ratio.

Noise Reduction

This feature diminishes picture artifacts caused by the digitizing of image motion content that may be present in the picture. Choose from **Off**, **Low**, **Medium**, or **High**.

Fast Response

This feature is mainly used when the signal originates from a game or computer device.

Ambient Light Sensor

Choose **On** or **Off**. When set to **On**, your HDTV will automatically adjust to light changes in the room.

Reset Picture Mode

Use this option to return all Picture Settings which have been changed to original or factory default values, without affecting any other parameter or feature settings. When it is selected, a second screen appears asking to verify and confirm the resetting.

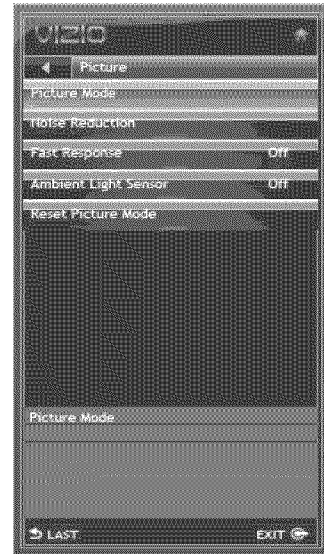

Parental Menu

This menu has all the different options to restrict certain channel and program viewing, this can be done by turning on the Parental Control. Selected programs, movies and channels can then be made available only after an authorized password has been entered and accepted by the TV. When this feature is selected, the first screen will ask for the default password or PIN, which is **1234**. Then the following options will appear:

Rating Enable

Select from **ON** or **OFF**. If set to **OFF**, you will not be able to set the US TV, US Movie, Canadian English, or Canadian French Ratings.

Channel Locks

Block individual channels from being displayed.

USA-TV

Press **OK** to block (locked) or allow (unlocked) channels by the following US TV ratings:

- TV-Y – All children
- TV-Y7 – Older children
- TV-G – General audience
- TV-PG – Guidance suggested
- TV-14 – Strongly cautioned
- TV-MA – Mature audience

You can also customize the TV ratings for the following content:

- A – All sub-ratings
- FV – Fantasy violence
- D – Sexual dialog
- L – Adult language
- S – Sexual situations
- V - Violence

USA-Movie

Press the **OK** button to block (locked) or allow (unlocked) channels by the following US Movie ratings:

- G – General audience
- PG – Parental guidance suggested
- PG-13 – Recommended for children 13 years of age or older
- R – Mature audience
- NC-17 – No one under 17 years of age
- X – No one under 17 years of age

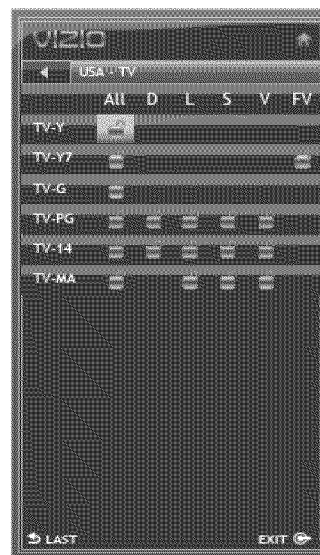

CAN-English

Press the **OK** button to block (locked) or allow (unlocked) channels by the following Canadian English ratings:

- C – Children
- C8+ – Children 8 years or older
- G – General Programming, suitable for all audiences
- PG – Parental guidance
- 14+ – Viewers 14 years or older
- 18+ – Adult programming

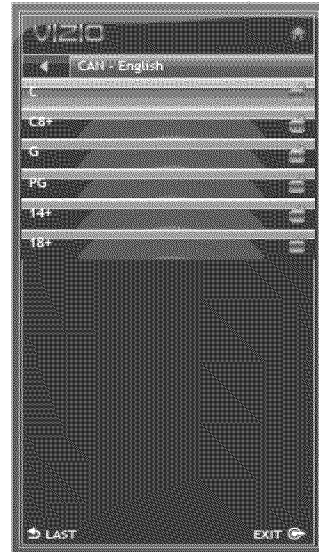

CAN-French

Press the **OK** button to block (locked) or allow (unlocked) channels by the following Canadian French ratings:

- G – General audience
- 8 ans+ – General – not recommended for young children
- 13 ans+ – Not suitable for children under 13 years of age
- 16 ans+ – Not suitable for under 16 years of age
- 18 ans+ – Adults only

Alt Rating Region

This option applies to locations with rating systems different from ratings in standard regions.

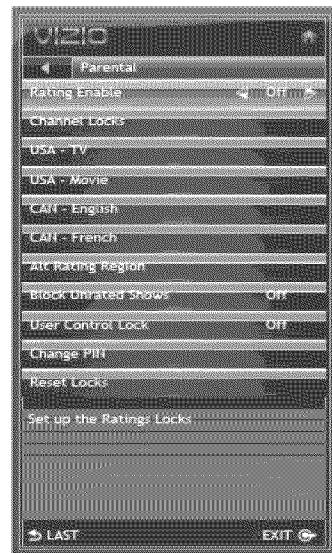

Block Unrated Shows

This option allows blocking programming that does not have a rating.

User Control Lock

Use this option to restrict the use of the HDTV by locking the mechanical control buttons on the side of the TV.

Change PIN (Password)

Enter a new, 4-digit password using the number buttons on the remote control. Enter it a second time to confirm you entered it correctly

Notes: 1. If you decide to change the password, make sure you write down and store the new password in a secure place. The *Reset Locks* feature does NOT reset the password.

2. All option adjustments can be done only if the Rating Enable option is set to ON.



Help Menu

Under this menu the following options are available:

System Info

Display information about your TV, such as signal format and current software version.

System Reset

This option gives you two choices on resetting the values.

1. **Start Setup Wizard:** Use this function to return to the Initial Setup menu. Please refer to the *Getting Started* section for more information. This option will remove all previously scanned channels.
2. **Reset All Settings:** Return all Picture and Audio settings to factory default. A screen will come up to confirm your selection or to cancel it.

Note: Both choices of System Reset will display a confirmation screen after being selected.

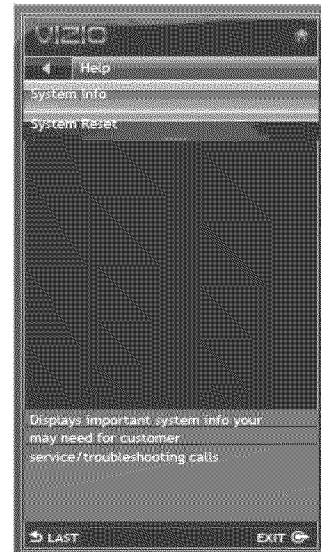

CC (Closed Caption) Menu

To select the options in the CC sub-menu, press the **OK** button or the right navigation button. A new menu will be displayed showing the following CC settings:

Analog Closed Caption

The CC feature is available when watching regular analog (NTSC) TV. Select from CC1, CC2, CC3, CC4, or Off. Closed Caption for regular TV is usually CC1 or CC2.

Digital Closed Caption

The CC feature is available when watching digital TV. Select from CS1, CS2, CS3, CS4, CS5, CS6, or Off.

Digital CC Style

The Digital CC Style feature is available when watching digital TV. Select either As Broadcaster or Custom. If Custom is selected then you can customize the way Closed Caption is displayed. The options available are:

- **Caption Style** (custom or as broadcast).

Note: the following options will only be available if Caption Style is set to Custom.

- **Text Size** (letter size)
- **Color** (text color)
- **Opacity** (color of the background where Closed Caption is displayed)
- **Background Color** (color of the background where Closed Caption is displayed)
- **Background Opacity** (sets the transparency of the background)
- **Window Color** (color of the area where characters are displayed)
- **Window Opacity** (transparency of the area where characters are displayed)

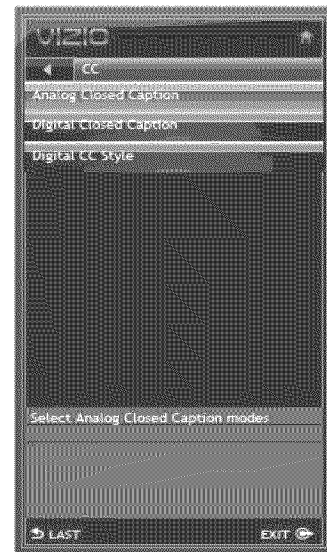

Chapter 9 Maintenance and Troubleshooting

Cleaning the TV and Remote Control

1. Remove the power adapter cable from the TV.
2. Use a soft cloth moistened with diluted neutral cleaner to clean the TV and remote control. VIZIO recommends using an HDTV cleaning solution which can be purchased at any major retailer.
3. Wring liquid out of the cloth before cleaning to prevent water from penetrating into the housing.
4. Wipe the TV and remote control with a dry cloth after cleaning.

Important:

- Do not use volatile solvent (such as toluene, rosin and alcohol). Such chemicals may damage the housing, screen glass, and remote control, and cause labeling to peel.
- The screen glass is very fragile. Do not scrape it with any sharp object.
- Do not press or tap the screen to avoid cracking.

Troubleshooting Guide

If the TV fails or the performance changes dramatically, check the display in accordance with the following instructions. Remember to check the peripherals to pinpoint the source of the failure. If the display still fails to perform as expected, contact the VIZIO for assistance by calling 1-877-MYVIZIO (698-4946) or e-mail us at techsupport@VIZIO.com.

General TV Problems	Solution
Receive the error message "No Signal."	<ul style="list-style-type: none"> • Press the INPUT button on the remote control to select a different input source. • If you are using cable connected directly to the TV or an antenna, scan for channels from the Tuner menu in the on-screen menu.
No power.	<ul style="list-style-type: none"> • Make sure the power button is ON. • Make sure the AC power cord is firmly connected to a live outlet. • Plug another electrical device to the power outlet to verify that the outlet is working.
No sound.	<ul style="list-style-type: none"> • Press Volume + (Up) on the remote control. • Press MUTE on the remote control to make sure that MUTE is not ON. • Check your audio settings. The audio may be set to SAP, or the speakers are set to off. • Make sure that headphones are not connected. • Check the audio connections of external devices that may be connected to your HDTV. • If you are using an antenna, the signal strength of the channel may be low. Make sure your antenna is connected securely to the TV and move the antenna around the room or close to a window.
If the screen is black.	<ul style="list-style-type: none"> • Make sure the power button is ON (in the case of indoor antenna use). • Press the INPUT button on the remote control to select a different input source. • Check the connections of external devices that may be connected to your



General TV Problems	Solution
	HDTV.
Power is ON but there is no image on the screen.	<ul style="list-style-type: none"> • Make sure all cables attached to your HDTV are connected to the correct output on the external device. • Adjust brightness, contrast or backlight. • Press the INPUT button on the remote control to select a different input source.
Wrong or abnormal colors appear.	<ul style="list-style-type: none"> • Check Color and Tint settings in Picture Menu. • Reset Picture settings. • Check the video cables to make sure they are securely connected. • If you are using an antenna, the signal strength of the channel may be low. Make sure your antenna is connected securely to the TV and move the antenna around the room or close to a window (in the case of indoor antenna use).
Control buttons do not work.	<ul style="list-style-type: none"> • Press only one button at a time.
Remote control does not work.	<ul style="list-style-type: none"> • Point the remote control directly at the remote sensor on your TV. • Remove any obstacles between the remote control and the remote sensor. • Replace dead batteries with new ones. • Make sure you have selected TV mode on the remote control.
There appear to be image quality issues.	<ul style="list-style-type: none"> • If you are using an antenna, the signal strength of the channel may be low. Make sure your antenna is connected securely to the TV and move the antenna around the room or close to a window (in the case of indoor antenna use). • For best image quality, view HD wide-screen programs where possible. • If HD content is not available view "Standard Definition" from a digital source. • Standard, analog TV will always be noticeably inferior to HD because your digital flat panel TV has video that is many times better than old TV so you will see interference and deficiencies you did not know you had.
You cannot see a picture.	<ul style="list-style-type: none"> • Make sure the power button is ON. • Make sure AC power cord is firmly connected to a live outlet. • Press the INPUT button on the remote control to select a different input source. • Check the connections of external devices that may be connected to your HDTV. • If your HDTV is connected to a computer, press any button on your keyboard to "wake" your computer. • If you are using an antenna, the signal strength of the channel may be low. Make sure your antenna is connected securely to the TV and move the antenna around the room or close to a window (in the case of indoor antenna use).
You see a distorted picture or hear unusual sound.	<ul style="list-style-type: none"> • You may be getting interference from electrical appliances, cars, motorcycles, or fluorescent lights. If you have not mounted it on the wall, try moving your HDTV to another location to see if this is the cause of the problem.
The picture has abnormal patterns.	<ul style="list-style-type: none"> • Check the connections of external devices that may be connected to your HDTV. • Make sure the specifications of external devices meet the specifications of your HDTV (i.e. resolution). • If you are using an antenna, the signal strength of the channel may be low. Make sure your antenna is connected securely to the TV and move the antenna around the room or close to a window (in the case of indoor antenna use).
The display image does not cover the entire screen.	<ul style="list-style-type: none"> • If you are in RGB mode (Computer), make sure that H-Size and V-Position in the on-screen menu are set correctly. • If you are using TV, AV or Component with 480i input, press WIDE button on



General TV Problems	Solution
You can see a picture but you cannot hear sound.	<p>the remote control to scroll through various screen modes.</p> <ul style="list-style-type: none"> • Press Volume + (Up) on the remote control. • Press MUTE on the remote control to make sure that MUTE is not ON. • Check your audio settings. The audio may be set to SAP, or the speakers are set to off. • Make sure that headphones are not connected. • Check the audio connections of external devices that may be connected to your HDTV.
The TV has pixels (dots) that are always dark or colored.	<ul style="list-style-type: none"> • Your HDTV is manufactured using an extremely high level of precision technology, however, sometimes some pixels of your HDTV may not display. Pixel defects within industry specifications are inherent to this type of product and do not constitute a defective product.
You see “noise” or “trash” on the screen.	<ul style="list-style-type: none"> • When your HDTV’s digital capabilities exceed a digital broadcast signal, the signal is up-converted (increased) to match your TV’s display capabilities. Up-converting can cause noise or trash. • If you are using an antenna, the signal strength of the channel may be low. Make sure your antenna is connected securely to the TV and move the antenna around the room or close to a window (in the case of indoor antenna use).
You switch to a different input and the volume changes.	<ul style="list-style-type: none"> • The TV remembers the volume level from the last time you adjusted it. If the sound level is higher or lower from another source, then the volume will change.
You switch to a different input and the screen size changes.	<ul style="list-style-type: none"> • The TV remembers the viewing mode from the last time you used a particular input (AV, Component, HDMI and TV).
Tips for High-Definition Users.	<ul style="list-style-type: none"> • Your HDTV is an ideal platform for viewing High Definition Content. • Best image quality will be achieved by HDMI. The next best is Component, followed by Composite. • Due to variances in broadcast practices, it is possible some image distortions can occur.
Tips for Letterbox Content Users.	<ul style="list-style-type: none"> • Some Letterboxed (or “Widescreen”) versions of DVD movies are formatted for standard 4:3 Televisions. Your HDTV has the ability to expand this content so the entire screen is filled at the expense of image accuracy.

Media Viewer Problems	Solution
USB device is not recognized.	<ul style="list-style-type: none"> • Make sure the device is correctly inserted. • Make sure the device is FAT or FAT32 • Make sure it contains the supported files. • Make sure files are .jpg or .jpeg only.
Image is interrupted or distorted.	<ul style="list-style-type: none"> • Make sure the device is correctly inserted. • Make sure that the file complies with the supported format, bit rate and/or profile. Also check the file for damage. • Some files that comply with the supported format may not play back or display properly.
Slideshow doesn’t start.	<ul style="list-style-type: none"> • Make sure the viewer isn’t in pause, rotation, or zoom mode.



Telephone & Technical Support

Products are often returned due to a technical problem rather than a defective product that may result in unnecessary shipping charges billed to you. Our trained support personnel can often resolve the problem over the phone. For more information on warranty service or repair, after the warranty period, please contact our Support Department at the number below.

Customer support and quality service are integral parts of VIZIO's commitment to service excellence. For technical assistance contact our VIZIO Technical Support Department via email or phone.

Email: techsupport@VIZIO.com
(877) 698-4946 Fax: (949) 585-9563
Hours of operation: Monday - Friday: 6 am to 9 pm
Saturday – Sunday: 8 am to 4 pm

Please have your VIZIO model number, serial number, and date of purchase available before you call.

VIZIO
Address:
39 Tesla
Irvine, CA 92618, USA
Telephone: (888) 849-4623 (949) 428-2525 Fax: (949) 585-9514
Web: www.VIZIO.com

Compliance

Caution: Always use a power cable that is properly grounded. Please use the AC cords listed below for each area.

USA: UL **Canada:** CSA
Germany: VDE **UK:** BASE/BS
Japan: Electric Appliance Control Act



FCC Class B Radio Interference Statement

NOTE: This equipment has been tested and found to comply with the limits for a Class B digital device, pursuant to Part 15 of the FCC Rules. These limits are designed to provide reasonable protection against harmful interference in a residential installation. This equipment generates uses and can radiate radio frequency energy, and if not installed and used in accordance with the instructions, may cause harmful interference to radio communications. However, there is no guarantee that interference will not occur in a particular installation. If this equipment does cause harmful interference to radio or television reception, which can be determined by turning the equipment off and on, the user is encouraged to try to correct the interference by one or more of the following measures:

1. Reorient or relocate the receiving antenna.
2. Increase the separation between the equipment and receiver.
3. Connect the equipment into an outlet on a circuit different from that to which the receiver is connected.
4. Consult the dealer or an experienced radio/TV technician for help.

Notice:

1. The changes or modifications not expressly approved by the party responsible for compliance could void the user's authority to operate the equipment.
2. Shielded interface cables and AC power cord, if any, must be used in order to comply with the emission limits.
3. The manufacturer is not responsible for any radio or TV interference caused by unauthorized modification to this equipment. It is the responsibilities of the user to correct such interference.



Chapter 10 Specifications

Product specifications may change without notice or obligation.

M190VA /M190VA-W Specifications		
Panel	18.5" Diagonal, 16:9 Aspect Ratio	
Resolution	1366 x 768 pixels	
Pixel (Dot) Pitch	0.300mm(H) x 0.300mm(V)	
Display Compatibility	HDTV (720p)	
Colors	16.7 Million	
Brightness cd/m ² (typical)	250nits	
Dynamic Contrast Ratio	20,000 : 1	
Response Time	5ms	
Viewing Angle	170° x 160° (horizontal/vertical)	
Inputs	1x RF 1x Composite Video and stereo audio 1x Component and stereo audio	2x HDMI 1x RGB 1x USB Port (photo/service)
Outputs	1x SPDIF Optical Digital Audio, 1x headphone	
Features	Noise Reduction, CC, V-Chip 2.0. Supports 1080i (HDTV), 720P (HDTV), 480P (EDTV) and 480i (SDTV) video signals. HDMI V.1.3. USB supports Digital images (JPEG) photo files. Supports 640x480, 800x600, 1024x768, 1360x768 via RGB or 1920x1080i via HDMI [®] . 3-D comb filter, 3:2 or 2:2 reverse pull-down, ATSC with 8VSB & QAM demodulation, ATSC with MPEG-2 decoding, NTSC video decoding via Video (AV or Component). Progressive Scan Video via HDMI [®] , Component or RGB. Built in speakers x 2. Dolby Digital Decoding, SRS TruSurround HD and SRS TruVolume sound enhancement.	
Speakers	2xBuilt-in, 3W Speakers	
Panel Life	30,000 hours to half the original brightness	
Power		
Input	Direct connection to Power board.	
Voltage Range	120Vac at 60Hz	
Power Consumption	25W, <1W Standby.	
Environmental Conditions		
Operating	Temperature: 5°C~35°C, Relative Humidity: 20~80%, Altitude: 0~6,561ft	
Non-Operating	Temperature: -20°C~50°C, Relative Humidity: 10~90%, Altitude: 0~40,000ft	
Dimensions	18.01"W x 12.54"H x 4.28"D with stand; 18.01"W x 12.54"H x 2.29"D w/o stand	
Net Weight	6.71lbs without stand, 7.48lbs with stand	
Gross Weight	11.69lbs	
Certifications	Energy Star 4.0, UL, CUL, FCC Class B	
Compliances	EIA/CEA-766-A	



M220VA/M220VA-W Specifications		
Panel	21.53." Diagonal, 16:9 Aspect Ratio	
Resolution	1920 x 1080	
Pixel (Dot) Pitch	0.248mm(H) x 0.248mm(V)	
Display Compatibility	1080p (FHDTV)	
Colors	16.7 Million	
Brightness cd/m ² (typical)	250nits	
Dynamic Contrast Ratio	20,000:1	
Response Time	5ms	
Viewing Angle	170° x 160° (horizontal/vertical)	
Inputs	1x RF 1x Composite Video and stereo audio 1x Component and stereo audio	2x HDMI 1x RGB 1x USB Port (photo/service)
Outputs	1x SPDIF Optical Digital Audio, 1x headphone	
Features	Noise Reduction, CC, V-Chip 2.0. Supports 1080P (Full HDTV), 1080i (HDTV), 720P (HDTV), 480P (EDTV) and 480i (SDTV) video signals. 1080P FHDTV, HDMI V.1.3. USB supports Digital images (JPEG) photo files. Supports 640x480, 800x600, 1024x768, 1360x768, 1920x1080 via RGB or 1920x1080 via HDMI®. 3-D comb filter, 3:2 or 2:2 reverse pull-down, ATSC with 8VSB & QAM demodulation, ATSC with MPEG-2 decoding, NTSC video decoding via Video (AV or Component). Progressive Scan Video via HDMI®. Component or RGB. Built in speakers x 2. Dolby Digital Decoding, SRS TruSurround HD and SRS TruVolume sound enhancement.	
Speakers	2xBuilt-in, 3W Speakers	
Panel Life	30,000 hours to half the original brightness	
Power		
Input	Direct connection to Power board.	
Voltage Range	120Vac at 60Hz	
Power Consumption	28W, <1W Standby.	
Environmental Conditions		
Operating	Temperature: 5°C~35°C, Relative Humidity: 20~80%, Altitude: 0~6,561ft	
Non-Operating	Temperature: -20°C~50°C, Relative Humidity: 10~90%, Altitude: 0~40,000ft	
Dimensions	20.63"W x 14.09" H x 5.03" D with stand; 20.63" W x 14.09"H x 2.27" D without stand	
Net Weight	7.634lbs without stand, 8.653lbs with stand	
Gross Weight	13.45lbs	
Certifications	Energy Star 4.0, UL, CUL, FCC Class B	
Compliances	EIA/CEA-766-A	



M260VA/M260VA-W Specifications		
Panel	26.01" Diagonal, 16:9 Aspect Ratio	
Resolution	1366 x 768 pixels	
Pixel (Dot) Pitch	0.421mm(H) x 0.421mm(V)	
Display Compatibility	HDTV (720p)	
Colors	16.7 Million	
Brightness cd/m ² (typical)	400nits	
Dynamic Contrast Ratio	20,000 : 1	
Response Time	8ms	
Viewing Angle	178° x 178° (horizontal/vertical)	
Inputs	1x RF 1x Composite Video and stereo audio 1x Component and stereo audio	2x HDMI 1x RGB 1x USB Port (photo/service)
Outputs	1x SPDIF Optical Digital Audio, 1x headphone	
Features	Noise Reduction, CC, V-Chip 2.0. Supports 1080i (HDTV), 720P (HDTV), 480P (EDTV) and 480i (SDTV) video signals. HDMI V.1.3. USB supports Digital images (JPEG) photo files. Supports 640x480, 800x600, 1024x768, 1360x768 via RGB or 1920x1080 via HDMI [®] . 3-D comb filter, 3:2 or 2:2 reverse pull-down, ATSC with 8VSB & QAM demodulation, ATSC with MPEG-2 decoding, NTSC video decoding via Video (AV, S-Video, or Component). Progressive Scan Video via HDMI [®] , Component or RGB. Built in speakers x 2. Dolby Digital Decoding, SRS TruSurround HD and SRS TruVolume sound enhancement.	
Speakers	2xBuilt-in, 5W Speakers	
Panel Life	30,000 hours to half the original brightness	
Power		
Input	Direct connection to Power board.	
Voltage Range	120Vac at 60Hz	
Power Consumption	44W, <1W Standby.	
Environmental Conditions		
Operating	Temperature: 5°C~35°C, Relative Humidity: 20~80%, Altitude: 0~6,561ft	
Non-Operating	Temperature: -20°C~50°C, Relative Humidity: 10~90%, Altitude: 0~40,000ft	
Dimensions	25.35"W x 17.00"H x 5.86"D with stand; 25.35"W x 17.00"H x 2.30"D w/o stand	
Net Weight	11.75lbs without stand, 13.12lbs with stand	
Gross Weight	19.40lbs	
Certifications	Energy Star 4.0, UL, CUL, FCC Class B	
Compliances	EIA/CEA-766-A	



Preset PC Resolutions

M190VA/M190VA-W Preset PC Resolutions

If connecting to a PC through the RGB PC input, set the TV timing mode to VESA 1360x768 at 60Hz for better picture quality (refer to the graphic card's user guide for questions on how to set this timing mode). See the table below for the factory preset resolutions.

Refresh (Hz)	Resolution	H.Freq (kHz)	H.Sync	V.Freq (Hz)	V.Sync	Pixel Freq (MHz)
60	640 x 480	31.469	N	59.94	N	25.175
75	640 x 480	37.5	N	75	N	31.5
70	720 x 400	31.46	N	70.08	P	28.32
60	800 x 600	37.897	P	60.317	P	40
75	800 x 600	46.875	P	75	P	49.5
60	1024 x 768	48.363	N	60.004	N	65
70	1024 x 768	56.476	N	70.069	N	75
75	1024 x 768	60.023	N	75.026	N	78.75
60	1360 x 768	47.72	P	59.799	P	84.75

M220VA/M220VA-W Preset PC Resolutions

If connecting to a PC through the RGB PC input, set the TV timing mode to VESA 1920x1080 at 60Hz for better picture quality (refer to the graphic card's user guide for questions on how to set this timing mode). See the table below for the factory preset resolutions.

Refresh (Hz)	Resolution	H.Freq (kHz)	H.Sync	V.Freq (Hz)	V.Sync	Pixel Freq (MHz)
60	640 x 480	31.469	N	59.94	N	25.175
75	640 x 480	37.5	N	75	N	31.5
70	720 x 400	31.46	N	70.08	P	28.32
60	800 x 600	37.897	P	60.317	P	40
75	800 x 600	46.875	P	75	P	49.5
60	1024 x 768	48.363	N	60.004	N	65
70	1024 x 768	56.476	N	70.069	N	75
75	1024 x 768	60.023	N	75.026	N	78.75
60	1920 x 1080	66.587	P	59.934	P	138.5



M260VA/M260VA-W Preset PC Resolutions

If connecting to a PC through the RGB PC input, set the TV timing mode to VESA 1360x768 at 60Hz for better picture quality (refer to the graphic card's user guide for questions on how to set this timing mode). See the table below for the factory preset resolutions.

Refresh (Hz)	Resolution	H.Freq (kHz)	H.Sync	V.Freq (Hz)	V.Sync	Pixel Freq (MHz)
60	640 x 480	31.469	N	59.94	N	25.175
75	640 x 480	37.5	N	75	N	31.5
70	720 x 400	31.46	N	70.08	P	28.32
60	800 x 600	37.897	P	60.317	P	40
75	800 x 600	46.875	P	75	P	49.5
60	1024 x 768	48.363	N	60.004	N	65
70	1024 x 768	56.476	N	70.069	N	75
75	1024 x 768	60.023	N	75.026	N	78.75
60	1360 x 768	47.72	P	59.799	P	84.75



Chapter 11 Warranty

ONE-YEAR LIMITED WARRANTY ON PARTS AND LABOR

Covers units purchased as new in United States and Puerto Rico Only

VIZIO provides a warranty to the original purchaser of its products against defects in materials and workmanship for a period of one year of non-commercial usage and ninety (90) days of commercial use. If a VIZIO product is defective within the warranty period, VIZIO will either repair or replace the unit at its sole option and discretion.

To obtain warranty service, contact VIZIO Technical Support via email: TechSupport@VIZIO.com or via phone at 877 MY VIZIO (877.698.4946) from 6:00AM to 9:00PM Monday through Friday and 8:00AM to 4:00PM Saturday and Sunday, Pacific Time, or visit www.VIZIO.com. Proof of purchase in the form of a purchase receipt or copy thereof is required.

Parts and Labor

There will be no charge for parts or labor during the warranty period. Replacement parts and units may be new or recertified at VIZIO's option and sole discretion. Replacement parts and units are warranted for the remaining portion of the original warranty or for ninety (90) days from warranty service or replacement, whichever is later.

Types of Service

Units 30" or larger will usually be serviced in-home. In-home service requires complete and easy access to the unit and does not include de-installation or re-installation of the product. However, in some cases, it may be necessary to send the unit to a VIZIO service center. VIZIO will cover the transportation charges to and from the same customer location.

Units less than 30" must be sent to a VIZIO service center. VIZIO is not responsible for transportation costs to the service center, but VIZIO will cover return shipping to the customer. **PRE-AUTHORIZATION IS REQUIRED BEFORE SENDING ANY UNIT IN FOR SERVICE.**

Any returns to VIZIO's service centers must utilize either the original carton box and shipping material or a replacement box and material provided by VIZIO. VIZIO technical support will provide instructions for packing and shipping the unit to the VIZIO service center.

Limitations and Exclusions

VIZIO's one-year limited warranty only covers defects in materials and workmanship. Items not covered include but are not limited to cosmetic damage, normal wear and tear, misuse, signal issues, power surges, and damages from shipping, acts of God, any sort of customer misuse, installation, customer modifications, adjustments, and set-up issues. Units with unreadable or removed serial numbers, "image burn-in", and routine maintenance are not covered. This warranty does not cover products sold "AS IS", "FACTORY RECERTIFIED", or by a non-authorized reseller.



THERE ARE NO EXPRESS WARRANTIES OTHER THAN THOSE LISTED OR DESCRIBED ABOVE. ANY IMPLIED WARRANTIES, INCLUDING ANY IMPLIED WARRANTY OF MERCHANTABILITY AND FITNESS FOR A PARTICULAR PURPOSE, SHALL BE LIMITED IN DURATION TO THE PERIOD OF TIME SET FORTH ABOVE. VIZIO'S TOTAL LIABILITY FOR ANY AND ALL LOSSES AND DAMAGES RESULTING FROM ANY CAUSE WHATSOEVER SHALL IN NO EVENT EXCEED THE PURCHASE PRICE OF THE DISPLAY. VIZIO SHALL NOT BE RESPONSIBLE FOR LOSS OF USE, COMMERCIAL LOSS, LOST REVENUE OR LOST PROFITS, OR OTHER INCIDENTAL OR CONSEQUENTIAL DAMAGES. SOME STATES DO NOT ALLOW LIMITATIONS ON HOW LONG AN IMPLIED WARRANTY LASTS OR THE EXCLUSION OF INCIDENTAL OR CONSEQUENTIAL DAMAGES, SO THE ABOVE LIMITATIONS OR EXCLUSIONS MAY NOT APPLY TO YOU. THIS WARRANTY GIVES YOU SPECIFIC LEGAL RIGHTS, AND YOU MAY ALSO HAVE OTHER RIGHTS, WHICH VARY FROM STATE TO STATE. THIS WARRANTY IS SUBJECT TO CHANGE WITHOUT NOTICE. CHECK www.VIZIO.com FOR THE MOST CURRENT VERSION.

Personal Data

If your VIZIO product is capable of storing personal data and other information, **ALL CONTENTS AND INFORMATION WILL BE DELETED IN THE COURSE OF SOME IN-HOME AND ALL SHIP-IN WARRANTY SERVICE.** If this occurs, your product will be restored to you configured **as originally purchased.** You will be responsible for restoring all applicable data and passwords. Recovery and reinstallation of user data is not covered under this Limited Warranty. **In order to protect your personal information, VIZIO recommends that you always clear all personal information from the unit before it is serviced, regardless of the servicer.**

ZERO BRIGHT PIXEL DEFECT GUARANTEE

This policy covers “zero bright pixels” defects for the duration of the limited “ONE YEAR WARRANTY” on select new product purchases. To determine if this guarantee applies to your product, refer to the “DETAILS” tab of the model’s product information page (www.VIZIO.com) or look for the “zero bright pixel” guarantee on the box.



Index

16:9	26	System Info	38
4:3	26	Home Theater	
Accessories	7	Connecting	25
Adjustments		INFO Button	17
Volume	10	Input Source	
Advanced Adjustments	26	Choosing	16
Antenna	18	Inputs	
Aspect Ratio	26	Antenna	4
Blackbars	26	Connectors	18
Cable Box		Maintenance of TV	39
Connecting	19	Parental Controls	
Cleaning	39	Rating Enable	37
Coaxial connection		Photo Menu	26, 30
Satellite box	24	Remote Control	13
Coaxial Connection		Batteries	13
cable TV	24	Precautions	13
Component Connector	18	Range	13
Composite Connector	18	RGB	18
Computer Equipment		Safety Instructions	2
Connecting	25	Satellite Box	
Connecting		Connecting	19
Computer	25	Setting up	8
Connecting Equipment		Specifications	44
Cable	19	S-Video	18
DVD	22	Technical Support	42
Home Theater	25	Troubleshooting	39
Rear Panel Connections	11	TV Menu	26
Satellite Box	19	TV Settings App	26
Contents	7	Input Menu	26
Controls		Timer Menu	26, 30
Front Panel	10	Wide Menu	26
DVD Player		TV Settings Menu	
Connecting	22	Input Source Menu	28
DVI		TV Stand	
Cable Box	20	Attaching	8
DVD Player	22	Wall mounting	9
Satellite Box	20	Watching TV	
Getting Started	15	Getting your Programs	16
Grounding	4	Program Information	17
HDMI	18	Wide	26
Help Menu			

