



Contents

Models

DRB4900S
DRL4980S
DRB4800S
DRL4880S
DRB4600S
DRL4680S
DRB4400S
DRL4480S

| | | | |
|---------------------------------|-----------|--------------------------------------|------------|
| <u>Appliance Registration</u> | 2 | <u>Press Guard Cycle</u> | 7 |
| <u>Automatic Drying</u> | 8 | <u>Problem Solver</u> | 12-14 |
| <u>Care and Cleaning</u> | 11 | <u>Safety Instructions</u> | 3-5 |
| <u>Consumer Services</u> | 15 | <u>Sorting</u> | 7, 9 |
| <u>Cycle Settings</u> | 7 | <u>Storing Dryer</u> | 11 |
| <u>Dryer Exhaust</u> | 11 | <u>Timed Drying</u> | 8 |
| <u>Energy-Saving Tips</u> | 5 | <u>User Maintenance Instructions</u> | 11 |
| <u>Knits Drying Tips</u> | 8, 13 | <u>Warranty</u> | Back Cover |
| <u>Important Phone Numbers</u> | 15 | | |
| <u>Light Bulb Replacement</u> | 11 | | |
| <u>Lint Filter</u> | 7, 11 | | |
| <u>Loading</u> | 7, 9 | | |
| <u>Model and Serial Numbers</u> | 2 | | |
| <u>Operating the Dryer</u> | 6-8 | | |
| <u>Perm. Press Drying Tips</u> | 8, 13, 14 | | |

Use and Care of
Your Dryer

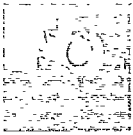

HELP US HELP YOU...

Read this book carefully.

It is intended to help you operate and maintain your new dryer properly.

Keep it handy for answers to your questions.

If you don't understand something or need more help, write (include your phone number)

Consumer Affairs
Appliance Park
Louisville, KY 40225

Save time and money.

Before you request service... check the Problem Solver section. It lists causes of minor operating problems that you can correct yourself.

If you received a damaged washer...

Immediately contact the dealer (or builder) that sold you the dryer.

Write down the model and serial numbers.

You'll find them on a label on the front of the dryer behind the door.

These numbers are also on the Consumer Product Ownership Registration Card that came with your dryer. Before sending in this card, please write these numbers here:

Model Number

Serial Number

Use these numbers in any correspondence or service calls concerning your dryer.

WARNING: For your safety the information in this manual must be followed to minimize the risk of fire or explosion or to prevent property damage, personal injury or loss of life.

—Do not store or use gasoline or other flammable vapors and liquids in the vicinity of this or any other appliance.

—WHAT TO DO IF YOU SMELL GAS

- Do not try to light any appliance.
- Do not touch any electrical switch; do not use any phone in your building.
- Clear the room, building or area of all occupants.

• Immediately call your gas supplier from a neighbor's phone. Follow the gas supplier's instructions.

• If you cannot reach your gas supplier, call the fire department.

—Installation and service must be performed by a qualified installer, service agency or the gas supplier.

All drying instruction terms in this book conform to the Care Labeling Rule established by the Federal Trade Commission, January 1984.

If you need service

To obtain service, see the Consumer Services page in the back of this book.

We're proud of our service and want you to be pleased. If for some reason you are not happy with the service you receive, here are three steps to follow for further help.

First, contact the people who serviced your appliance. Explain why you are not pleased. In most cases, this will solve the problem.

NEXT, if you are still not pleased, write all the details—including your phone number—to:

Consumer Relations
Appliance Park
Louisville, KY 40225

FINALLY, if your problem is still not resolved, write:

Major Appliance Consumer
Action Panel
20 North Wacker Drive
Chicago, IL 60606

IMPORTANT SAFETY INSTRUCTIONS

Read all instructions before using this appliance.



IMPORTANT SAFETY NOTICE

The California Safe Drinking Water and Toxic Enforcement Act requires the governor of California to publish a list of substances known to the state to cause cancer, birth defects or other reproductive harm and requires businesses to warn customers of potential exposure to such substances.

Gas appliances can cause minor exposure to four of these substances, namely benzene, carbon monoxide, formaldehyde and soot, caused primarily by the incomplete combustion of natural gas or LP fuels.

Properly adjusted dryers will minimize incomplete combustion. Exposure to these substances can be minimized further by properly venting the dryers to the outdoors.



Warning—To reduce the risk of fire, electric shock, or injury to persons when using your appliance, follow basic precautions, including the following:

- Use this appliance only for its intended purpose as described in this Use and Care Book.



- This dryer must be properly installed and located in accordance with the Installation Instructions before it is used. If you did not receive an Installation Instructions sheet with your dryer, you can obtain one by contacting the service location nearest you.

- Properly ground to conform with all governing codes and ordinances. Follow details in Installation Instructions.
- Locate where the temperature is above 50°F. (10°C.) for satisfactory operation of the dryer control system. Do not install or store the dryer where it will be exposed to the weather.
- Connect to a properly rated, protected and sized power supply circuit to avoid electrical overload.
- Exhausting to the outside is **STRONGLY RECOMMENDED** to prevent large amounts of moisture and lint from being blown into the room. Carefully follow the Exhausting Details in the Installation Instructions.



- Do not repair or replace any part of the appliance or attempt any servicing unless specifically recommended in this Use and Care Book or in published user-repair instructions that you understand and have the skills to carry out.



- When disconnecting this appliance pull by the plug rather than the cord to avoid damage to the cord or junction of cord and plug. Make sure that the cord is located so that it will not be stepped on, tripped over or otherwise subjected to damage or stress.

To Minimize the Possibility of a Fire Hazard

- Exhaust Duct—See Installation Instructions. Use only rigid metal or flexible metal 4" diameter ductwork inside the dryer cabinet or for exhausting to the outside. USE OF PLASTIC OR OTHER COMBUSTIBLE DUCTWORK CAN CAUSE A FIRE. FOIL OR OTHER EASILY PUNCTURED DUCTWORK CAN CAUSE A FIRE IF IT COLLAPSES OR BECOMES OTHERWISE RESTRICTED IN USE OR DURING INSTALLATION.
- Do not use heat to dry articles containing rubber, plastic, or similar materials (such as padded bras, tennis shoes, galoshes, bath mats, rugs, bibs, baby pants, plastic bags, etc.) as these materials may melt or burn. Also, some rubber materials, when heated, can under certain circumstances produce fire by spontaneous combustion.

(continued next page)

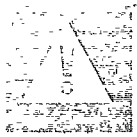

IMPORTANT SAFETY INSTRUCTIONS

(continued)

- Garments labeled "Dry Away from Heat" (such as life jackets containing Kapok) must not be put in your dryer.



- Do not wash or dry articles that have been cleaned in, washed in, soaked in, or spotted with combustible or explosive substances (such as wax, paint, gasoline, degreasers, dry-cleaning solvents, kerosene, etc.) which may ignite or explode. Do not add these substances to the wash water. Do not use these substances around your washer and/or dryer during operation.
- Any article on which you have used a cleaning solvent, or which contains flammable materials (such as cleaning cloths, mops, towels used in beauty salons, restaurants or barber shops, etc.) must not be placed in or near the dryer until all traces of these flammable liquids or solids and their fumes have been removed. There are many highly flammable items used in homes such as: acetone, denatured alcohol, gasoline, kerosene, some household cleaners, some spot removers, turpentine, waxes, wax removers and products containing petroleum distillates.



- Clean the lint filter before each load to prevent lint accumulation inside the dryer or in the room. **DO NOT OPERATE THE DRYER WITHOUT THE LINT FILTER IN PLACE.**
- Keep the area around and underneath your appliances free from the accumulation of combustible materials, such as lint, paper, rags, chemicals, etc.
- The interior of the machine and the exhaust duct connection inside the dryer should be cleaned periodically by a qualified individual.

To Minimize the Possibility of Injury

- Never reach into the dryer while the drum is moving. Before loading, unloading or adding clothes, wait until the drum has completely stopped.
- Do not dry fiberglass articles in your dryer. Skin irritation could result from the remaining glass particles that may be picked up by clothing during subsequent dryer uses.



- The laundry process can reduce the flame retardancy of fabrics. To avoid such a result, the garment manufacturer's care instructions should be followed very carefully.



- Close supervision is necessary if this appliance is used by or near children. Do not allow children to play inside, on, or with this appliance or any discarded appliance. Dispose of discarded appliances and shipping or packing materials properly. Before discarding a dryer, or removing from service, remove the door of the dryer compartment.

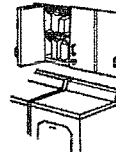

- Keep all laundry aids (such as detergents, bleaches, fabric softeners, etc.) out of the reach of children, preferably in a locked cabinet. Observe all warnings on container labels to avoid personal injury.
- Keep the floor around your appliances clean and dry to reduce the possibility of slipping.



- To minimize the possibility of electric shock, unplug this appliance from the power supply before attempting any maintenance or cleaning (except the removal and cleaning of the lint filter).

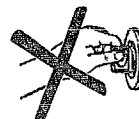

NOTE: Turning the Cycle Selector knob to an OFF position does NOT disconnect the appliance from the power supply.

- Do not tamper with the controls.

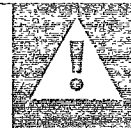

- Do not operate this appliance if it is damaged, malfunctioning, partially disassembled, or has missing or broken parts, including a damaged cord or plug.
- Never climb on or stand on the dryer top.
- If yours is a gas dryer, it is equipped with an automatic electric ignition and does not have a pilot light. DO NOT ATTEMPT TO LIGHT WITH A MATCH. Burns may result from having your hand in the vicinity of the burner when the automatic ignition may turn on.

Dryer-applied Fabric Softeners or Anti-static Conditioners

You may wish to soften your laundered fabrics or reduce the static electricity in them. We recommend you use either a fabric softener in the wash cycle, according to the manufacturer's instructions for those products, or try a dryer-added product for which the manufacturer gives written assurance on the package that their product can be safely used in your dryer.

Service or performance problems caused by the use of these products are the responsibility of the manufacturers of those products and are not covered under the warranty of this appliance.

SAVE THESE INSTRUCTIONS

ENERGY-SAVING TIPS

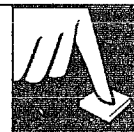

- Sort clothes by weight so you won't have to run an extra cycle for one or two heavier, slower-drying items.
- Do not overload your dryer. For efficient drying, clothes need to tumble freely.
- Use Automatic Cycles whenever possible to help prevent overdrying and to save energy.
- Remove garments promptly at the end of the drying cycle and place on hangers.
- Dry your clothes in consecutive loads. Using a "warm" dryer will save energy.
- Clean the dryer lint filter each time you dry.
- Clean the dryer exhaust ducting at least once a year. A partially clogged exhaust can lengthen drying time.



HOW TO OPERATE YOUR DRYER

Features and appearances may vary slightly

WARNING—To reduce the risk of fire, electric shock, or injury to persons when using your appliance, read the **IMPORTANT SAFETY INSTRUCTIONS** before operating this appliance.

DRB4900S and DRL4980S/DRB4800S and DRL4880S

DRYING SELECTIONS

PRESS GUARD CYCLE

SIGNAL

START

HEAVY DUTY 6 CYCLE
LARGE CAPACITY
AUTOMATIC DRYER

AUTO REGULAR OFF AUTO PERMANENT PRESS

COOL DOWN

DE WRINKLE DAMP DRY 70 MIN

TIMED

OPTIONAL PRESS GUARD

1 2 3 4 5

DRB4600S and DRL4680S

DRYING SELECTIONS

START

HEAVY DUTY 5 CYCLE
LARGE CAPACITY
AUTOMATIC DRYER

AUTO REGULAR OFF AUTO PERMANENT PRESS

COOL DOWN

DE WRINKLE DAMP DRY 70 MIN

TIMED

5 3

DRB4400S and DRL4480S

START

HEAVY DUTY 3 CYCLE
LARGE CAPACITY
AUTOMATIC DRYER

AUTOMATIC (HIGH HEAT) OFF (MEDIUM HEAT) TIMED

FLUFF (NO HEAT)

5 3

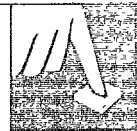

Check the Lint Filter

Clean the lint filter each time the dryer is used. Always be sure the lint filter is in place. Don't use the dryer without it. See Care and Cleaning section.

Sort and Load the Clothes

Good sorting for the dryer begins at the washer. Generally, if clothes are sorted correctly for washing, they're sorted correctly for drying. See the How to Sort the Clothes section. If you do mix various types of fabrics in your load, set the controls for the lighter-weight fabrics and remove when dry. Reset controls for the remaining heavier fabrics.

Set the Controls — Controls and features will vary from model to model

See the Suggested Fabric and Drying Selections guide.

1 Drying Selections.

Select the proper heat for your load.

| Drying Selections | Should be used with cycles indicated • | | |
|--------------------------|----------------------------------------|----------------------------------------|--------------|
| | Automatic Regular cycle | Automatic Perm. Press and Knits Cycles | Timed Cycles |
| Cottons High Heat | • | | • |
| Perm. Press Medium Heat | | • | • |
| Fluff No Heat* | | | • |
| Knits/Delicates Low Heat | | • | • |

* Fluff-No Heat option can be used with an automatic cycle, but for best performance it is recommended to be used with a timed cycle.

NOTE: Drying times will vary according to the type of heat used (Electric, Natural gas or LP gas), size of load, types of fabrics, wetness of clothes, and condition of exhaust ducts.

2 Press Guard Feature.

Turn the Press Guard cycle indicator to YES and the Cycle Selector knob to Optional Press Guard. This feature will minimize wrinkles setting in the clothes. The Press Guard feature provides approximately one hour of no-heat tumbling after the clothes are dry. Use your SIGNAL to remind you to remove clothes. See Signal section.

3 Cycle Selector.

Turn the Cycle Selector to the desired cycle setting. The selector may be turned in either direction.

4 Signal.

Set this signal, if desired, to remind you to remove clothes from the dryer when the cycle ends. See the Signal section.

5 Start Knob.

Turn the Start knob to start the dryer. (Opening the door during operation stops the dryer. To restart, close the door and turn the Start knob.)



OPERATING INSTRUCTIONS

(continued)

Signal. Operates with any cycle. (on models so equipped)

The signal control can be set anywhere between OFF and LOUD, depending on the desired sound level. The signal will sound just before the end of the cycle to remind you to remove the clothes.

To stop the signal while sounding, turn the signal control to OFF or advance the Cycle Selector to OFF.

The signal should always be used when drying polyester knits or permanent press items which should be removed as soon as the dryer stops to help prevent setting of wrinkles.

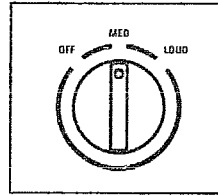

Polyester Knits & Permanent Press Drying Tips

- **DO NOT OVERLOAD—** Garments being dried or dewrinkled should tumble freely.
- **REMOVE CLOTHES PROMPTLY—** To help prevent wrinkling, remove clothes from the dryer promptly at the end of the drying cycles.
- **PLACE ON HANGERS—** Permanent press and polyester knit garments look best if placed on hangers after drying.

The Difference Between Auto Regular and Timed Regular Drying (on models so equipped)

Auto Regular Drying

When using the Auto Regular Cycles, the dryer continually senses the temperature of the air in the dryer drum. Wet laundry keeps the air cool. When laundry is dry enough (and the drum air warm enough) the heat turns off. When the air cools, the heat turns back on. This off and on cycling may happen a number of times (depending on the fabric, load size and Cycle Selector setting). The Cycle Selector advances (when the heat is off) until it automatically turns off dryer.

Timed Regular Drying

When using the Timed Regular Cycles, you select the number of minutes you wish the dryer to run and it turns off at the end of this time period.

Drying Selections Guide for the Automatic Cycles (on models so equipped—appearance will vary)

Set to regular position

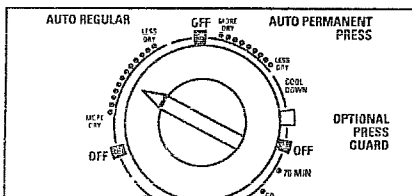

- For most regular loads.

Set toward More Dry

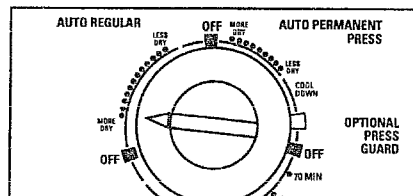

- For loads that include heavy-weight fabrics.
- If you desire to remove more moisture from your load.

Set toward Less Dry

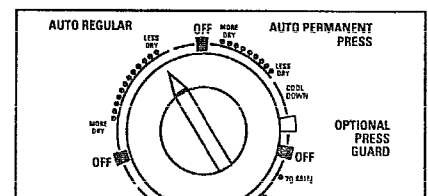

- For light weight fabric loads.
- If you desire to remove less moisture from the load.

HOW TO SORT CLOTHES

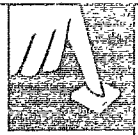

Sort by Surface Texture

Separate

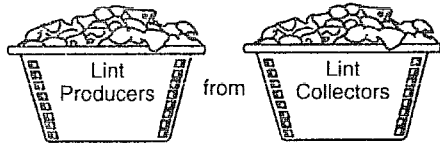

LINT PRODUCERS—such as terry toweling and chenille—give up lint.

LINT COLLECTORS—such as man-made fibers and napped fabrics like velveteen and corduroy—attract lint. These must be dried separately.

Sort by Fabric

Separate

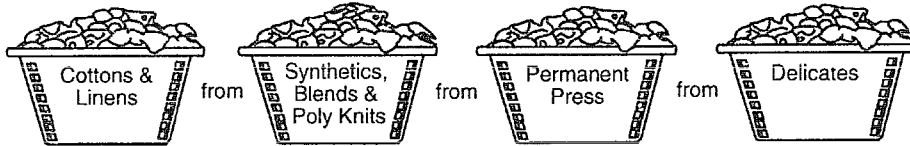

In addition to sorting to reduce lint collection, we recommend that you wash fabrics of similar construction together whenever possible.

Sort by Color

Separate

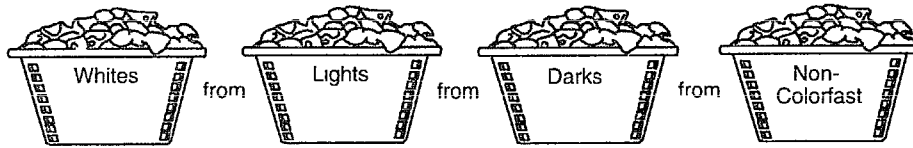

Sort by Weight

Separate

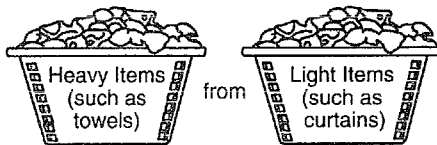

For information on tumble drying extra large items and different fabrics and loads, see the Suggested Fabrics and Drying Selections guide.

HOW TO LOAD THE CLOTHES

Don't overload your dryer. Crowded loads don't dry efficiently and clothes may be unnecessarily wrinkled. Loads should look like this:

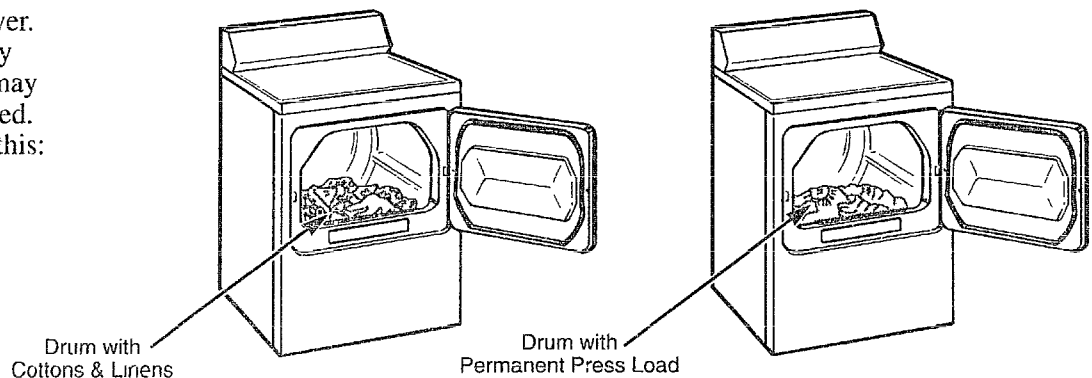



SUGGESTED FABRIC AND DRYING SELECTIONS

| Cycle Suggested | For Clothes Load/Fabrics such as: | Drying Selection |
|-----------------------------------|------------------------------------------------------------------------------------------------------------------------------------------------------|------------------|
| Automatic Regular | <ul style="list-style-type: none"> • Cottons and linens • Down-filled garments, if machine washing and drying is recommended | High Heat |
| Automatic Permanent Press & Knits | <ul style="list-style-type: none"> • Permanent press fabrics with cotton • Synthetics | Medium Heat |
| Delicates | <ul style="list-style-type: none"> • Silks and wools • Rayon and acetate | Low Heat |
| Timed | <ul style="list-style-type: none"> • Pillows* • Blankets** • Extra large items*** | High Heat |
| | | Medium Heat |

The terms High, Medium and Low Heat are those usually found on fabric care labels. For best results, follow your specific fabric care label.

Special Instructions

Refer to garment manufacturer's care labels for more information.

| | |
|-------------------------------------------------------------------------------------------|------------------------------------------------------------------------------------------------------------------------------------------------------------------------------------------------------------------------------------------------------------------------------------------------------------------------------------------------------------------------------------------------------------------------------------------------------------------------------------------------------------------------------------------------------------------------|
| *Pillows | Check ticking for holes or weak seams where feathers or filling could escape. DRY ONLY ONE PILLOW AT A TIME. Set dryer for maximum time. Stop dryer occasionally and shake pillow to redistribute filling for more even drying. Check pillow at end of drying time—if not completely dry, return pillow to dryer and reset for more drying time. Feather pillows dry very slowly and must be dried completely to prevent mildew. DO NOT tumble dry pillows containing kapok. |
| **Blankets | Put 2 or 4 dry towels into the dryer; tumble dry for 5 minutes. Set timer for 20-25 minutes. DO NOT set control for more than 25 minutes. DRY ONLY ONE BLANKET AT A TIME. Remove blanket at the end of the cycle and block the blanket back to its original shape. Allow to dry thoroughly before storing. |
| ***Extra Large Items—Queen or King size sheets; Blankets or Spreads; Mattress Covers/Pads | First setting—20 minutes; check and redistribute load. Then set timer for 15 minutes; check load again. Reset timer at 5 minute intervals, checking after each 5 minutes to make sure that the articles do not fill the dryer drum: many large articles, when wet, have ample room in the dryer, but as they dry and fluff up, they may not have room to tumble. CAUTION: If large items do not have room to tumble, the air flow may be blocked, which could result in scorching your valuable items. NOTE: Mattress covers/pads should be dried alone. |

CARE AND CLEANING



User Maintenance Instructions

CAUTION: If yours is an electric dryer, before you have it connected in your new residence, be sure your licensed electrician confirms that the supply voltage matches the voltage specified on the rating plate.

Dryer Exterior

Wipe off any spills or washing compounds. Wipe or dust with a damp cloth. Try not to strike the surface with sharp objects.

Dryer control panel and finishes may be damaged by some laundry pre-treatment soil and stain remover products if such products are sprayed on or have direct contact with the dryer.

Apply these pre-treatment products away from the dryer. The fabric may then be washed and dried normally. Damage to your dryer caused by pre-treatment products is not covered by your warranty.

Dryer Drum

The porcelain enamel drum is rust-resistant and requires no special care.

Dryer Exhaust

Inspect and clean the dryer exhaust ducting at least once a year.

Dryer Storage

To store your dryer for a short period of time, disconnect the power supply and clean the lint filter.

Lint Filter

Before every dryer use, clean the lint filter. Put your moistened fingers at the corner of the filter and wipe all the way across to the other corner.

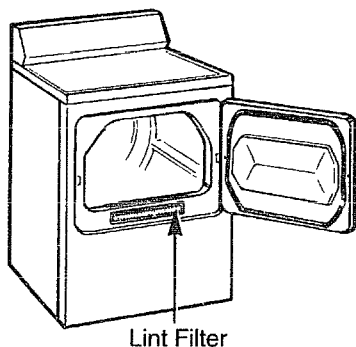

Periodically, remove the lint filter and insert the suction hose from your vacuum cleaner into the opening.

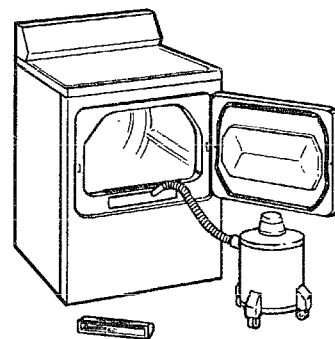

Air Circulation

Do not obstruct the flow of combustion and ventilating air.

Interior Lamp (on models so equipped)

BEFORE REPLACING THE LIGHT BULB, BE SURE TO UNPLUG THE DRYER POWER CORD. Unscrew the bulb and replace it with the same type 10 watt bulb.

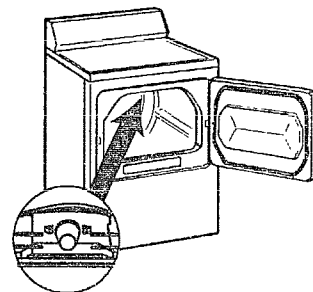



QUESTIONS? USE THIS PROBLEM SOLVER

| PROBLEM | POSSIBLE CAUSE |
|------------------------------|---------------------------------------------------------------------------------------------------------------------------------------------------------------------------------------------------------------------------------------------------------------------------------------------------------------------------------------------------------------------------------------------------------------------------------------------------------------------------------------------------------------------------------------------------------------------------------------------------------------------------------------------------------------------------------------------------------------------------------------------------------------------------------------------------------------------------------------------------------------------------------------------------------------------------------------------------------------------------------------------------------------------------------------------------------------------------------------------------------------------------------------------------------------------------------------------------------------------------------------------------------------------------------------------------------------------------------------------------------------------------------------------------------------------------------------------------|
| DRYER WON'T START | <ul style="list-style-type: none">• Dryer unplugged. Make sure power cord is plugged in.• No power to dryer. Check fuses and circuit breakers to make sure dryer is getting current. Most electric dryers use two.• Controls improperly set. Make sure controls are set and the Start knob is turned to START. Opening the door during operation stops the dryer. To restart, close the door and turn Start knob to START.• Dryer door is open. Close door securely—dryer will not run with door open.• Circuit is overloaded. Do not operate other appliances on the same electrical outlet or circuit while the dryer is operating. |
| CLOTHES TAKE TOO LONG TO DRY | <ul style="list-style-type: none">• Controls improperly set. Check all controls to make sure they are correctly set for the load you want to dry. See the How to Operate Your Dryer section.• Clogged lint filter. Remove and clean filter before every load. Periodically clean area under lint filter with vacuum cleaner. See the Care and Cleaning section.• Improper ducting. Make sure dryer is ducted in accordance with the Installation Instructions.• Obstruction in exhaust ducting. Make sure ducting is clean and free of obstruction; make sure damper in outside wall cap operates easily. If flexible ducting is used, be sure it is not kinked and is properly installed according to the Installation Instructions.• Blown fuses or tripped circuit breakers. Check household fuses or circuit breakers. Most electric dryers use two. It is possible for one to be blown or tripped and the dryer will still tumble without heat.• Improper sorting. Do not mix heavy, hard-to-dry items with lightweight articles.• Large loads of moisture-holding fabrics, such as beach towels, take a long time to remove moisture.• Too many items in dryer. Dry only one washer load at a time. Do not combine loads.• Too few items in dryer. If drying only one article, add two more similar articles, even if dry, to insure proper tumbling. |
| SHRINKAGE, GENERAL | <ul style="list-style-type: none">• Some fabrics will shrink whether machine washed and tumble dried or washed by hand and drip dried; others may be safely washed but will shrink in a dryer. Follow garment manufacturers' care labels exactly. If in doubt, do not machine wash or tumble dry. |

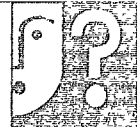

| PROBLEM | POSSIBLE CAUSE |
|--------------------------------------------------|----------------------------------------------------------------------------------------------------------------------------------------------------------------------------------------------------------------------------------------------------------------------------------------------------------------------------------------------------------------------------------------------------------------------------------------------------------------------------------------------------------------------------------------------------------------------------------------------------------------------------------------------------------------------------------------------------------------------------------------------------------------------------------------------------------------------------------------------------------------------------------------------------------------------------------------------------------------------------------------------------------------------------------------------------------------------------------------------------------------------------------------------------------------------------------------------------------------------------------------------------------------------------------------------------------------------------|
| SHRINKAGE, KNITS | <ul style="list-style-type: none">• Relaxation shrinkage can occur in knit fabrics that have been improperly stretched and elongated by the manufacturer. When this occurs, garment may be pressed back into shape after each wash and dry cycle.• Progressive or delayed shrinkage is caused when starch or sizing (in some fabrics) is gradually removed by laundering. May be noticed in older garments that have been laundered many times without previous shrinkage. Treat as for relaxation shrinkage above.• Shrinkage caused by overheating occurs in certain knit fabrics that have been heat-shaped. When washing, drying or ironing temperatures exceed the temperatures used to shape set, shrinkage may occur. This cannot be corrected, but it can be prevented by washing in cold or warm water; drying on low heat. |
| WRINKLING IN PERMANENT PRESS AND "NO-IRON" ITEMS | <ul style="list-style-type: none">• Leaving clothes in dryer after tumbling stops. Remove clothes promptly and hang them immediately.• Too many items in dryer. Dry only one washer load at a time. Do not combine loads.• Too few items in dryer. If drying only one article, add two or more similar articles, even if dry, to insure proper tumbling.• Improper loads. Avoid laundering heavy permanent press items, such as work clothes, with lighter permanent press items, such as shirts or blouses. Do not wash or dry permanent press with regular laundry.• Too many clothes in washer. Items must have room to move freely. Permanent press loads should always be smaller than regular loads...no more than medium loads.• Use of incorrect wash and dry cycles. If available, use Permanent Press wash cycle which provides a cool-down rinse to minimize wrinkling. Also, if available, use Permanent Press drying cycle.• Incorrect water level. Use large water level for medium load; medium level or half full for small load.• Washing repeatedly in too hot water. Wash in cool or warm water with plenty of detergent.• Failure to use fabric softener. Proper use of fabric softener will minimize wrinkling. |

(continued next page)



THE PROBLEM SOLVER

(continued)

| PROBLEM | POSSIBLE CAUSE |
|-------------------------------------------------------------|--------------------------------------------------------------------------------------------------------------------------------------------------------------------------------------------------------------------------------------------------------------------------------------------------------------------------------------------------------------------------------------------------------------------------------------------------------------------------------------------------------------------------------------------------------------------------------------------------------------------------------------------------------------------------------------------------------------------------------------------------------------------------------------------------------------------------------------------------------------------------------------------------------------------------------------------------------------------------------------------------------------------------------------------------------------------------------------------------------------------|
| TO REMOVE WRINKLES ON DRYERS WITH A PERMANENT PRESS SETTING | <p data-bbox="528 257 887 289">TO REMOVE WRINKLES:</p> <ul data-bbox="528 300 1337 570" style="list-style-type: none"><li data-bbox="528 300 986 331">• Retumble on Permanent Press setting.<li data-bbox="528 342 1059 374">• Rinse and dry on Permanent Press setting.<li data-bbox="528 385 1337 449">• If unsuccessful, retumble on normal temperature for 10–12 minutes and hang immediately.<li data-bbox="528 459 711 491">• Iron carefully.<li data-bbox="528 502 948 534">• Send to Dry Cleaners for pressing.<li data-bbox="528 544 1193 576">• Some wrinkles may remain which cannot be removed.* <p data-bbox="528 587 1437 768">* NOTE: If you follow good laundry procedures and permanent press clothes still come out wrinkled, the finish may not be good quality. Also, in permanent press synthetic/cotton blends, the cotton portion of the fabric can eventually wear away leaving only the synthetic. Since its the cotton portion which is treated for permanent press, a loss or decrease of permanent press performance will result.</p> |

We'll Be There

With the purchase of your new RCA appliance, receive the assurance that if you ever need information or assistance, we'll be there. All you have to do is call—toll-free!

In-Home Repair Service ***800-GE-CARES (800-432-2737)***

Our consumer service professionals will provide expert repair service on your RCA appliance, scheduled at a time that's convenient for you. Many GE Consumer Service company-operated locations offer you service today or tomorrow, or at your convenience (7:00 a.m. to 7:00 p.m. weekdays, 9:00 a.m. to 2:00 p.m. Saturdays). Our factory-trained technicians know your appliance inside and out—so most repairs can be handled in just one visit.

For Customers With Impaired Hearing... ***800-833-4322***

Consumers with impaired hearing or speech who have access to a TDD or a conventional teletypewriter may call 800-TDD-GEAC (800-833-4322) to request information or service.

Service Contracts ***800-626-2224***

You can have the secure feeling that GE Consumer Service will still be there after your RCA product warranty expires. Purchase a GE contract while your warranty is still in effect and you'll receive a substantial discount. With a multiple-year contract, you're assured of future service at today's prices.

Parts and Accessories ***800-626-2002***

Individuals qualified to service their own appliances can have needed parts or accessories sent directly to their home. Our parts system provides access to over 47,000 Genuine Renewal Parts...and all are fully warranted. VISA, MasterCard and Discover cards are accepted.

User maintenance instructions contained in this booklet cover procedures intended to be performed by any user. Other servicing generally should be referred to qualified service personnel. Caution must be exercised, since improper servicing may cause unsafe operation.

YOUR RCA AUTOMATIC CLOTHES DRYER WARRANTY

Save proof of original purchase date such as your sales slip or cancelled check to establish warranty period.

WHAT IS COVERED

FULL ONE-YEAR WARRANTY

For one year from date of original purchase, we will provide, free of charge, parts and service labor in your home to repair or replace *any part of the dryer* that fails because of a manufacturing defect.

This warranty is extended to the original purchaser and any succeeding owner for products purchased for ordinary home use in the 48 mainland states, Hawaii and Washington, D.C. In Alaska the warranty is the same except that it is LIMITED because you must pay to ship the product to the service shop or for the service technician's travel costs to your home.

FOR SERVICE

We at RCA strive to provide the highest quality products and service. Therefore we have designated GE CONSUMER SERVICE, a leader in the service industry, to fulfill your service needs. Should your appliance need service, during warranty period or beyond, call 800-GE-CARES (800-432-2737).

WHAT IS NOT COVERED

- Service trips to your home to teach you how to use the product.

Read your Use and Care material. If you then have any questions about operating the product, please contact your dealer or Manager—Consumer Affairs
RCA Appliances
Appliance Park
Louisville, KY 40225

- Improper installation.

If you have an installation problem, contact your dealer or installer. You are responsible for providing adequate electrical, gas, exhausting and other connecting facilities.

- Replacement of house fuses or resetting of circuit breakers.
- Failure of the product if it is used for other than its intended purpose or used commercially.
- Damage to product caused by accident, fire, floods or acts of God.

WARRANTOR IS NOT RESPONSIBLE FOR CONSEQUENTIAL DAMAGES.

Some states do not allow the exclusion or limitation of incidental or consequential damages, so the above limitation or exclusion may not apply to you. This warranty gives you specific legal rights, and you may also have other rights which vary from state to state. To know what your legal rights are in your state, consult your local or state consumer affairs office or your state's Attorney General.

Warrantor: RCA Appliances

If further help is needed concerning this warranty, write:
Manager—Consumer Affairs
RCA Appliances
Appliance Park
Louisville, KY 40225

This book is printed on recycled paper.

Part No. 113D5580P204
Pub No. 79-9047

8-94 CG

DRB4900S DRL4980S
DRB4800S DRL4880S
DRB4600S DRL4680S
DRB4400S DRL4480S

RCA

Printed in Louisville, KY





Contents

| | | | |
|---------------------------------|-----------|--------------------------------------|------------|
| <u>Appliance Registration</u> | 2 | <u>Press Guard Cycle</u> | 7 |
| <u>Automatic Drying</u> | 8 | <u>Problem Solver</u> | 12-14 |
| <u>Care and Cleaning</u> | 11 | <u>Safety Instructions</u> | 3-5 |
| <u>Consumer Services</u> | 15 | <u>Sorting</u> | 7, 9 |
| <u>Cycle Settings</u> | 7 | <u>Storing Dryer</u> | 11 |
| <u>Dryer Exhaust</u> | 11 | <u>Timed Drying</u> | 8 |
| <u>Energy-Saving Tips</u> | 5 | <u>User Maintenance Instructions</u> | 11 |
| <u>Knits Drying Tips</u> | 8, 13 | <u>Warranty</u> | Back Cover |
| <u>Important Phone Numbers</u> | 15 | | |
| <u>Light Bulb Replacement</u> | 11 | | |
| <u>Lint Filter</u> | 7, 11 | | |
| <u>Loading</u> | 7, 9 | | |
| <u>Model and Serial Numbers</u> | 2 | | |
| <u>Operating the Dryer</u> | 6-8 | | |
| <u>Perm. Press Drying Tips</u> | 8, 13, 14 | | |

Models

DRB4900S
DRL4980S
DRB4800S
DRL4880S
DRB4600S
DRL4680S
DRB4400S
DRL4480S

Use and Care of
Your Dryer

40

79-9047



HELP US HELP YOU...

Read this book carefully.

It is intended to help you operate and maintain your new dryer properly.

Keep it handy for answers to your questions.

If you don't understand something or need more help, write (include your phone number)

Consumer Affairs
Appliance Park
Louisville, KY 40225

Save time and money.

Before you request service... check the Problem Solver section. It lists causes of minor operating problems that you can correct yourself.

If you received a damaged washer...

Immediately contact the dealer (or builder) that sold you the dryer.

Write down the model and serial numbers.

You'll find them on a label on the front of the dryer behind the door.

These numbers are also on the Consumer Product Ownership Registration Card that came with your dryer. Before sending in this card, please write these numbers here:

Model Number

Serial Number

Use these numbers in any correspondence or service calls concerning your dryer.

WARNING: For your safety the information in this manual must be followed to minimize the risk of fire or explosion or to prevent property damage, personal injury or loss of life.

—Do not store or use gasoline or other flammable vapors and liquids in the vicinity of this or any other appliance.

—WHAT TO DO IF YOU SMELL GAS

- Do not try to light any appliance.
- Do not touch any electrical switch; do not use any phone in your building.
- Clear the room, building or area of all occupants.

• Immediately call your gas supplier from a neighbor's phone. Follow the gas supplier's instructions.

• If you cannot reach your gas supplier, call the fire department.

—Installation and service must be performed by a qualified installer, service agency or the gas supplier.

All drying instruction terms in this book conform to the Care Labeling Rule established by the Federal Trade Commission, January 1984.

If you need service

To obtain service, see the Consumer Services page in the back of this book.

We're proud of our service and want you to be pleased. If for some reason you are not happy with the service you receive, here are three steps to follow for further help.

First, contact the people who serviced your appliance. Explain why you are not pleased. In most cases, this will solve the problem.

NEXT, if you are still not pleased, write all the details—including your phone number—to:

Consumer Relations
Appliance Park
Louisville, KY 40225

FINALLY, if your problem is still not resolved, write:

Major Appliance Consumer
Action Panel
20 North Wacker Drive
Chicago, IL 60606

IMPORTANT SAFETY INSTRUCTIONS

Read all instructions before using this appliance.



IMPORTANT SAFETY NOTICE

The California Safe Drinking Water and Toxic Enforcement Act requires the governor of California to publish a list of substances known to the state to cause cancer, birth defects or other reproductive harm and requires businesses to warn customers of potential exposure to such substances.

Gas appliances can cause minor exposure to four of these substances, namely benzene, carbon monoxide, formaldehyde and soot, caused primarily by the incomplete combustion of natural gas or LP fuels.

Properly adjusted dryers will minimize incomplete combustion. Exposure to these substances can be minimized further by properly venting the dryers to the outdoors.

 **Warning**—To reduce the risk of fire, electric shock, or injury to persons when using your appliance, follow basic precautions, including the following:

• Use this appliance only for its intended purpose as described in this Use and Care Book.

 • This dryer must be properly installed and located in accordance with the Installation Instructions before it is used. If you did not receive an Installation Instructions sheet with your dryer, you can obtain one by contacting the service location nearest you.

—Properly ground to conform with all governing codes and ordinances. Follow details in Installation Instructions.

—Locate where the temperature is above 50°F. (10°C.) for satisfactory operation of the dryer control system. Do not install or store the dryer where it will be exposed to the weather.

—Connect to a properly rated, protected and sized power supply circuit to avoid electrical overload.

—Exhausting to the outside is **STRONGLY RECOMMENDED** to prevent large amounts of moisture and lint from being blown into the room. Carefully follow the Exhausting Details in the Installation Instructions.



• Do not repair or replace any part of the appliance or attempt any servicing unless specifically recommended in this Use and Care Book or in published user-repair instructions that you understand and have the skills to carry out.



• When disconnecting this appliance pull by the plug rather than the cord to avoid damage to the cord or junction of cord and plug. Make sure that the cord is located so that it will not be stepped on, tripped over or otherwise subjected to damage or stress.

To Minimize the Possibility of a Fire Hazard

• **Exhaust Duct**—See Installation Instructions. Use only rigid metal or flexible metal 4" diameter ductwork inside the dryer cabinet or for exhausting to the outside. USE OF PLASTIC OR OTHER COMBUSTIBLE DUCTWORK CAN CAUSE A FIRE. FOIL OR OTHER EASILY PUNCTURED DUCTWORK CAN CAUSE A FIRE IF IT COLLAPSES OR BECOMES OTHERWISE RESTRICTED IN USE OR DURING INSTALLATION.

• Do not use heat to dry articles containing rubber, plastic, or similar materials (such as padded bras, tennis shoes, galoshes, bath mats, rugs, bibs, baby pants, plastic bags, etc.) as these materials may melt or burn. Also, some rubber materials, when heated, can under certain circumstances produce fire by spontaneous combustion.

(continued next page)



IMPORTANT SAFETY INSTRUCTIONS

(continued)

- Garments labeled "Dry Away from Heat" (such as life jackets containing Kapok) must not be put in your dryer.



- Do not wash or dry articles that have been cleaned in, washed in, soaked in, or spotted with combustible or explosive substances (such as wax, paint, gasoline, degreasers, dry-cleaning solvents, kerosene, etc.) which may ignite or explode. Do not add these substances to the wash water. Do not use these substances around your washer and/or dryer during operation.

- Any article on which you have used a cleaning solvent, or which contains flammable materials (such as cleaning cloths, mops, towels used in beauty salons, restaurants or barber shops, etc.) must not be placed in or near the dryer until all traces of these flammable liquids or solids and their fumes have been removed. There are many highly flammable items used in homes such as: acetone, denatured alcohol, gasoline, kerosene, some household cleaners, some spot removers, turpentine, waxes, wax removers and products containing petroleum distillates.

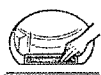

- Clean the lint filter before each load to prevent lint accumulation inside the dryer or in the room. **DO NOT OPERATE THE DRYER WITHOUT THE LINT FILTER IN PLACE.**

- Keep the area around and underneath your appliances free from the accumulation of combustible materials, such as lint, paper, rags, chemicals, etc.
- The interior of the machine and the exhaust duct connection inside the dryer should be cleaned periodically by a qualified individual.

To Minimize the Possibility of Injury

- Never reach into the dryer while the drum is moving. Before loading, unloading or adding clothes, wait until the drum has completely stopped.
- Do not dry fiberglass articles in your dryer. Skin irritation could result from the remaining glass particles that may be picked up by clothing during subsequent dryer uses.



- The laundry process can reduce the flame retardancy of fabrics. To avoid such a result, the garment manufacturer's care instructions should be followed very carefully.



- Close supervision is necessary if this appliance is used by or near children. Do not allow children to play inside, on, or with this appliance or any discarded appliance. Dispose of discarded appliances and shipping or packing materials properly. Before discarding a dryer, or removing from service, remove the door of the dryer compartment.

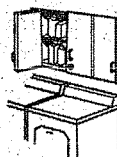

- Keep all laundry aids (such as detergents, bleaches, fabric softeners, etc.) out of the reach of children, preferably in a locked cabinet. Observe all warnings on container labels to avoid personal injury.
- Keep the floor around your appliances clean and dry to reduce the possibility of slipping.



- To minimize the possibility of electric shock, unplug this appliance from the power supply before attempting any maintenance or cleaning (except the removal and cleaning of the lint filter).

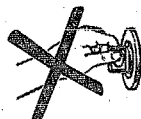

NOTE: Turning the Cycle Selector knob to an OFF position does NOT disconnect the appliance from the power supply.

- Do not tamper with the controls.



- Do not operate this appliance if it is damaged, malfunctioning, partially disassembled, or has missing or broken parts, including a damaged cord or plug.
- Never climb on or stand on the dryer top.
- If yours is a gas dryer, it is equipped with an automatic electric ignition and does not have a pilot light. DO NOT ATTEMPT TO LIGHT WITH A MATCH. Burns may result from having your hand in the vicinity of the burner when the automatic ignition may turn on.

Dryer-applied Fabric Softeners or Anti-static Conditioners

You may wish to soften your laundered fabrics or reduce the static electricity in them. We recommend you use either a fabric softener in the wash cycle, according to the manufacturer's instructions for those products, or try a dryer-added product for which the manufacturer gives written assurance on the package that their product can be safely used in your dryer.

Service or performance problems caused by the use of these products are the responsibility of the manufacturers of those products and are not covered under the warranty of this appliance.

SAVE THESE INSTRUCTIONS

ENERGY-SAVING TIPS

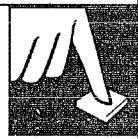

- Sort clothes by weight so you won't have to run an extra cycle for one or two heavier, slower-drying items.
- Do not overload your dryer. For efficient drying, clothes need to tumble freely.
- Use Automatic Cycles whenever possible to help prevent overdrying and to save energy.
- Remove garments promptly at the end of the drying cycle and place on hangers.
- Dry your clothes in consecutive loads. Using a "warm" dryer will save energy.
- Clean the dryer lint filter each time you dry.
- Clean the dryer exhaust ducting at least once a year. A partially clogged exhaust can lengthen drying time.



HOW TO OPERATE YOUR DRYER

Features and appearances may vary slightly

WARNING—To reduce the risk of fire, electric shock, or injury to persons when using your appliance, read the **IMPORTANT SAFETY INSTRUCTIONS** before operating this appliance.

DRB4900S and DRL4980S/DRB4800S and DRL4880S

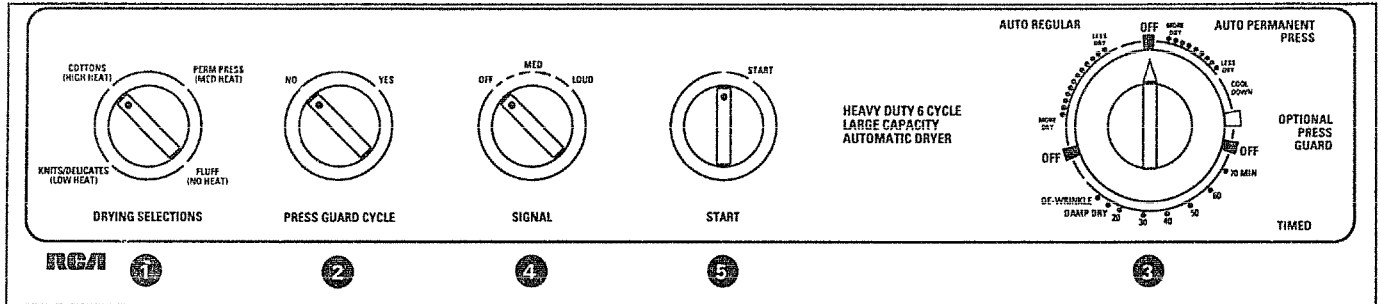

DRB4600S and DRL4680S

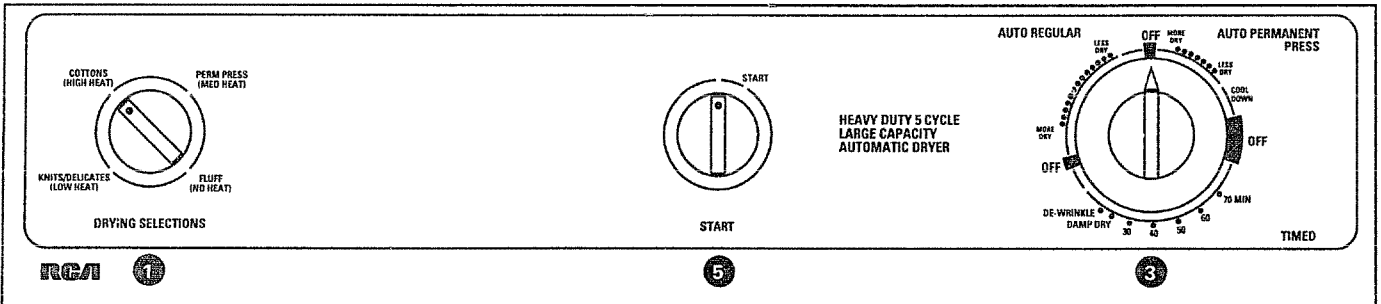

DRB4400S and DRL4480S

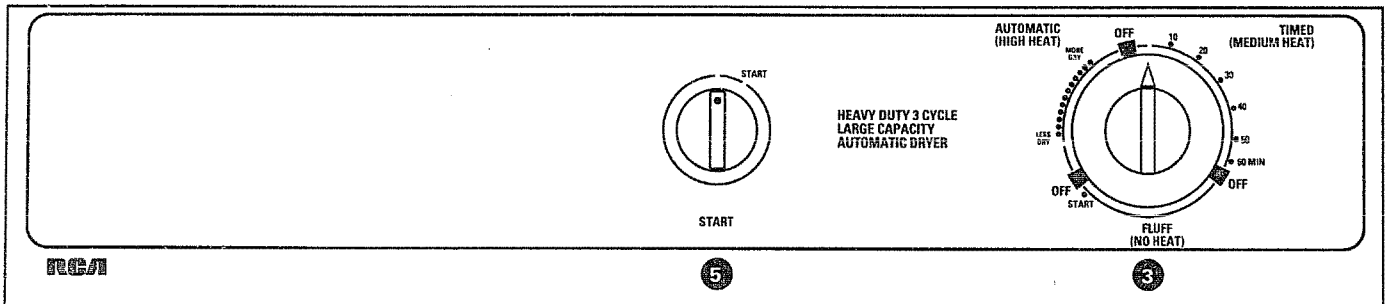

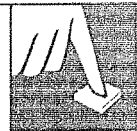

Check the Lint Filter

Clean the lint filter each time the dryer is used. Always be sure the lint filter is in place. Don't use the dryer without it. See Care and Cleaning section.

Sort and Load the Clothes

Good sorting for the dryer begins at the washer. Generally, if clothes are sorted correctly for washing, they're sorted correctly for drying. See the How to Sort the Clothes section. If you do mix various types of fabrics in your load, set the controls for the lighter-weight fabrics and remove when dry. Reset controls for the remaining heavier fabrics.

Set the Controls — Controls and features will vary from model to model

See the Suggested Fabric and Drying Selections guide.

1 Drying Selections.

Select the proper heat for your load.

| Drying Selections | Should be used with cycles indicated • | | |
|--------------------------|----------------------------------------|----------------------------------------|--------------|
| | Automatic Regular cycle | Automatic Perm. Press and Knits Cycles | Timed Cycles |
| Cottons High Heat | • | | • |
| Perm. Press Medium Heat | | • | • |
| Fluff No Heat* | | | • |
| Knits/Delicates Low Heat | | • | • |

*Fluff-No Heat option can be used with an automatic cycle, but for best performance it is recommended to be used with a timed cycle.

NOTE: Drying times will vary according to the type of heat used (Electric, Natural gas or LP gas), size of load, types of fabrics, wetness of clothes, and condition of exhaust ducts.

2 Press Guard Feature.

Turn the Press Guard cycle indicator to YES and the Cycle Selector knob to Optional Press Guard. This feature will minimize wrinkles setting in the clothes. The Press Guard feature provides approximately one hour of no-heat tumbling after the clothes are dry. Use your SIGNAL to remind you to remove clothes. See Signal section.

3 Cycle Selector.

Turn the Cycle Selector to the desired cycle setting. The selector may be turned in either direction.

4 Signal.

Set this signal, if desired, to remind you to remove clothes from the dryer when the cycle ends. See the Signal section.

5 Start Knob.

Turn the Start knob to start the dryer. (Opening the door during operation stops the dryer. To restart, close the door and turn the Start knob.)



OPERATING INSTRUCTIONS

(continued)

Signal. Operates with any cycle. (on models so equipped)

The signal control can be set anywhere between OFF and LOUD, depending on the desired sound level. The signal will sound just before the end of the cycle to remind you to remove the clothes.

To stop the signal while sounding, turn the signal control to OFF or advance the Cycle Selector to OFF.

The signal should always be used when drying polyester knits or permanent press items which should be removed as soon as the dryer stops to help prevent setting of wrinkles.

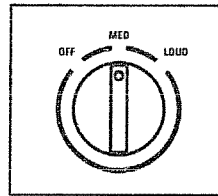

Polyester Knits & Permanent Press Drying Tips

- **DO NOT OVERLOAD—** Garments being dried or dewrinkled should tumble freely.
- **REMOVE CLOTHES PROMPTLY—** To help prevent wrinkling, remove clothes from the dryer promptly at the end of the drying cycles.
- **PLACE ON HANGERS—** Permanent press and polyester knit garments look best if placed on hangers after drying.

The Difference Between Auto Regular and Timed Regular Drying (on models so equipped)

Auto Regular Drying

When using the Auto Regular Cycles, the dryer continually senses the temperature of the air in the dryer drum. Wet laundry keeps the air cool. When laundry is dry enough (and the drum air warm enough) the heat turns off. When the air cools, the heat turns back on. This off and on cycling may happen a number of times (depending on the fabric, load size and Cycle Selector setting). The Cycle Selector advances (when the heat is off) until it automatically turns off dryer.

Timed Regular Drying

When using the Timed Regular Cycles, you select the number of minutes you wish the dryer to run and it turns off at the end of this time period.

Drying Selections Guide for the Automatic Cycles (on models so equipped—appearance will vary)

Set to regular position

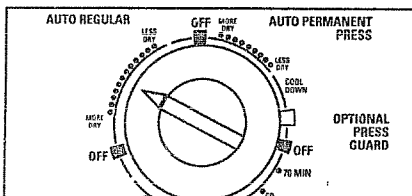

- For most regular loads.

Set toward More Dry

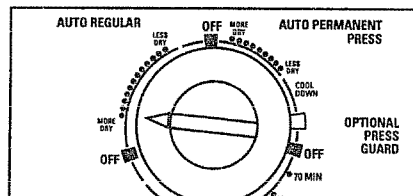

- For loads that include heavy-weight fabrics.
- If you desire to remove more moisture from your load.

Set toward Less Dry

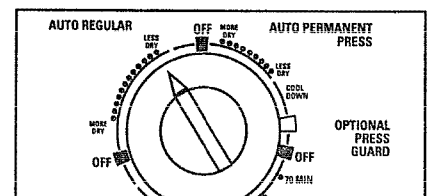

- For light weight fabric loads.
- If you desire to remove less moisture from the load.

HOW TO SORT CLOTHES

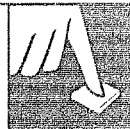

Sort by Surface Texture

Separate

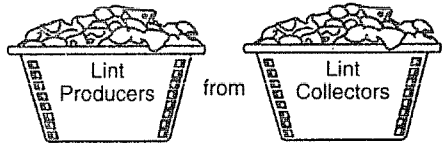

LINT PRODUCERS—such as terry toweling and chenille—give up lint.

LINT COLLECTORS—such as man-made fibers and napped fabrics like velveteen and corduroy—attract lint. These must be dried separately.

Sort by Fabric

Separate

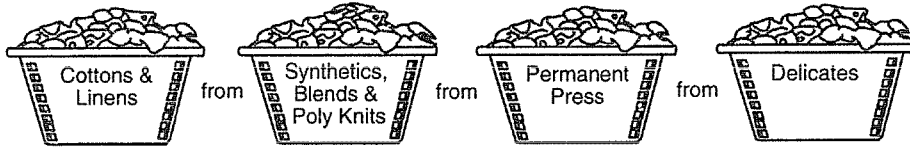

In addition to sorting to reduce lint collection, we recommend that you wash fabrics of similar construction together whenever possible.

Sort by Color

Separate

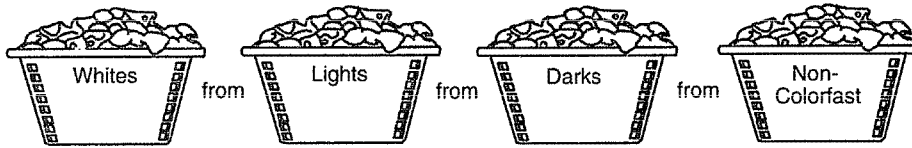

Sort by Weight

Separate

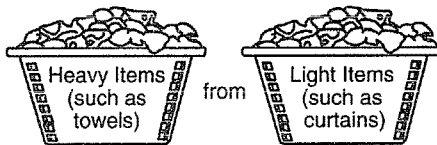

For information on tumble drying extra large items and different fabrics and loads, see the Suggested Fabrics and Drying Selections guide.

HOW TO LOAD THE CLOTHES

Don't overload your dryer. Crowded loads don't dry efficiently and clothes may be unnecessarily wrinkled. Loads should look like this:

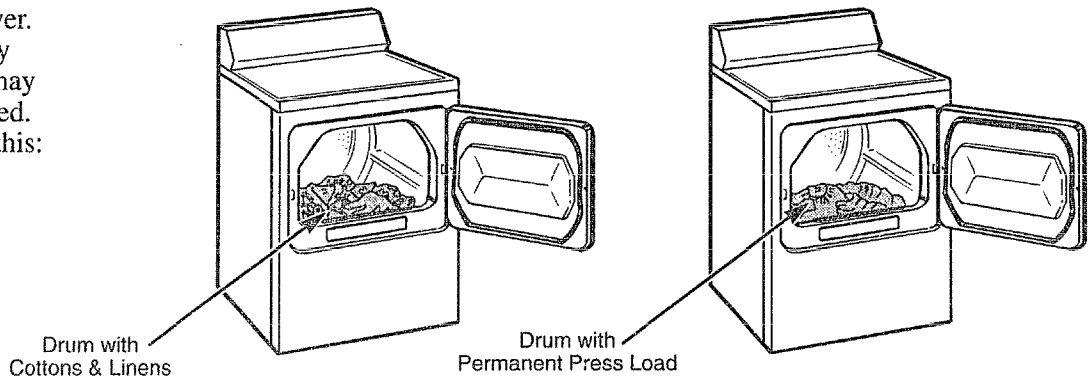



SUGGESTED FABRIC AND DRYING SELECTIONS

| Cycle Suggested | For Clothes Load/Fabrics such as: | Drying Selection |
|-----------------------------------|------------------------------------------------------------------------------------------------------------------------------------------------------|------------------|
| Automatic Regular | <ul style="list-style-type: none"> • Cottons and linens • Down-filled garments, if machine washing and drying is recommended | High Heat |
| Automatic Permanent Press & Knits | <ul style="list-style-type: none"> • Permanent press fabrics with cotton • Synthetics | Medium Heat |
| Delicates | <ul style="list-style-type: none"> • Silks and wools • Rayon and acetate | Low Heat |
| Timed | <ul style="list-style-type: none"> • Pillows* • Blankets** • Extra large items*** | High Heat |
| | | Medium Heat |

The terms High, Medium and Low Heat are those usually found on fabric care labels. For best results, follow your specific fabric care label.

Special Instructions

Refer to garment manufacturer's care labels for more information.

| | |
|-------------------------------------------------------------------------------------------|------------------------------------------------------------------------------------------------------------------------------------------------------------------------------------------------------------------------------------------------------------------------------------------------------------------------------------------------------------------------------------------------------------------------------------------------------------------------------------------------------------------------------------------------------------------------|
| *Pillows | Check ticking for holes or weak seams where feathers or filling could escape. DRY ONLY ONE PILLOW AT A TIME. Set dryer for maximum time. Stop dryer occasionally and shake pillow to redistribute filling for more even drying. Check pillow at end of drying time—if not completely dry, return pillow to dryer and reset for more drying time. Feather pillows dry very slowly and must be dried completely to prevent mildew. DO NOT tumble dry pillows containing kapok. |
| **Blankets | Put 2 or 4 dry towels into the dryer; tumble dry for 5 minutes. Set timer for 20-25 minutes. DO NOT set control for more than 25 minutes. DRY ONLY ONE BLANKET AT A TIME. Remove blanket at the end of the cycle and block the blanket back to its original shape. Allow to dry thoroughly before storing. |
| ***Extra Large Items—Queen or King size sheets; Blankets or Spreads; Mattress Covers/Pads | First setting—20 minutes; check and redistribute load. Then set timer for 15 minutes; check load again. Reset timer at 5 minute intervals, checking after each 5 minutes to make sure that the articles do not fill the dryer drum: many large articles, when wet, have ample room in the dryer, but as they dry and fluff up, they may not have room to tumble. CAUTION: If large items do not have room to tumble, the air flow may be blocked, which could result in scorching your valuable items. NOTE: Mattress covers/pads should be dried alone. |

CARE AND CLEANING

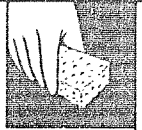

User Maintenance Instructions

CAUTION: If yours is an electric dryer, before you have it connected in your new residence, be sure your licensed electrician confirms that the supply voltage matches the voltage specified on the rating plate.

Dryer Exterior

Wipe off any spills or washing compounds. Wipe or dust with a damp cloth. Try not to strike the surface with sharp objects.

Dryer control panel and finishes may be damaged by some laundry pre-treatment soil and stain remover products if such products are sprayed on or have direct contact with the dryer.

Apply these pre-treatment products away from the dryer. The fabric may then be washed and dried normally. Damage to your dryer caused by pre-treatment products is not covered by your warranty.

Dryer Drum

The porcelain enamel drum is rust-resistant and requires no special care.

Dryer Exhaust

Inspect and clean the dryer exhaust ducting at least once a year.

Dryer Storage

To store your dryer for a short period of time, disconnect the power supply and clean the lint filter.

Lint Filter

Before every dryer use, clean the lint filter. Put your moistened fingers at the corner of the filter and wipe all the way across to the other corner.

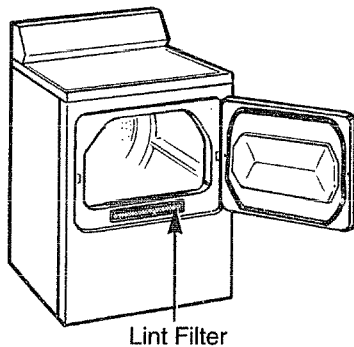

Periodically, remove the lint filter and insert the suction hose from your vacuum cleaner into the opening.

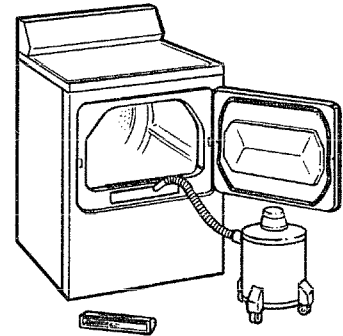

Air Circulation

Do not obstruct the flow of combustion and ventilating air.

Interior Lamp (on models so equipped)

BEFORE REPLACING THE LIGHT BULB, BE SURE TO UNPLUG THE DRYER POWER CORD. Unscrew the bulb and replace it with the same type 10 watt bulb.

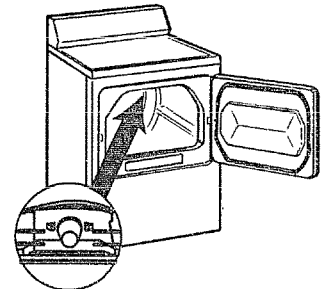



QUESTIONS? USE THIS PROBLEM SOLVER

| PROBLEM | POSSIBLE CAUSE |
|------------------------------|---------------------------------------------------------------------------------------------------------------------------------------------------------------------------------------------------------------------------------------------------------------------------------------------------------------------------------------------------------------------------------------------------------------------------------------------------------------------------------------------------------------------------------------------------------------------------------------------------------------------------------------------------------------------------------------------------------------------------------------------------------------------------------------------------------------------------------------------------------------------------------------------------------------------------------------------------------------------------------------------------------------------------------------------------------------------------------------------------------------------------------------------------------------------------------------------------------------------------------------------------------------------------------------------------------------------------------------------------------------------------------------------------------------------------------------------------|
| DRYER WON'T START | <ul style="list-style-type: none">• Dryer unplugged. Make sure power cord is plugged in.• No power to dryer. Check fuses and circuit breakers to make sure dryer is getting current. Most electric dryers use two.• Controls improperly set. Make sure controls are set and the Start knob is turned to START. Opening the door during operation stops the dryer. To restart, close the door and turn Start knob to START.• Dryer door is open. Close door securely—dryer will not run with door open.• Circuit is overloaded. Do not operate other appliances on the same electrical outlet or circuit while the dryer is operating. |
| CLOTHES TAKE TOO LONG TO DRY | <ul style="list-style-type: none">• Controls improperly set. Check all controls to make sure they are correctly set for the load you want to dry. See the How to Operate Your Dryer section.• Clogged lint filter. Remove and clean filter before every load. Periodically clean area under lint filter with vacuum cleaner. See the Care and Cleaning section.• Improper ducting. Make sure dryer is ducted in accordance with the Installation Instructions.• Obstruction in exhaust ducting. Make sure ducting is clean and free of obstruction; make sure damper in outside wall cap operates easily. If flexible ducting is used, be sure it is not kinked and is properly installed according to the Installation Instructions.• Blown fuses or tripped circuit breakers. Check household fuses or circuit breakers. Most electric dryers use two. It is possible for one to be blown or tripped and the dryer will still tumble without heat.• Improper sorting. Do not mix heavy, hard-to-dry items with lightweight articles.• Large loads of moisture-holding fabrics, such as beach towels, take a long time to remove moisture.• Too many items in dryer. Dry only one washer load at a time. Do not combine loads.• Too few items in dryer. If drying only one article, add two more similar articles, even if dry, to insure proper tumbling. |
| SHRINKAGE, GENERAL | <ul style="list-style-type: none">• Some fabrics will shrink whether machine washed and tumble dried or washed by hand and drip dried; others may be safely washed but will shrink in a dryer. Follow garment manufacturers' care labels exactly. If in doubt, do not machine wash or tumble dry. |

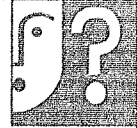

| PROBLEM | POSSIBLE CAUSE |
|--------------------------------------------------|----------------------------------------------------------------------------------------------------------------------------------------------------------------------------------------------------------------------------------------------------------------------------------------------------------------------------------------------------------------------------------------------------------------------------------------------------------------------------------------------------------------------------------------------------------------------------------------------------------------------------------------------------------------------------------------------------------------------------------------------------------------------------------------------------------------------------------------------------------------------------------------------------------------------------------------------------------------------------------------------------------------------------------------------------------------------------------------------------------------------------------------------------------------------------------------------------------------------------------------------------------------------------------------------------------------------------|
| SHRINKAGE, KNITS | <ul style="list-style-type: none">• Relaxation shrinkage can occur in knit fabrics that have been improperly stretched and elongated by the manufacturer. When this occurs, garment may be pressed back into shape after each wash and dry cycle.• Progressive or delayed shrinkage is caused when starch or sizing (in some fabrics) is gradually removed by laundering. May be noticed in older garments that have been laundered many times without previous shrinkage. Treat as for relaxation shrinkage above.• Shrinkage caused by overheating occurs in certain knit fabrics that have been heat-shaped. When washing, drying or ironing temperatures exceed the temperatures used to shape set, shrinkage may occur. This cannot be corrected, but it can be prevented by washing in cold or warm water; drying on low heat. |
| WRINKLING IN PERMANENT PRESS AND "NO-IRON" ITEMS | <ul style="list-style-type: none">• Leaving clothes in dryer after tumbling stops. Remove clothes promptly and hang them immediately.• Too many items in dryer. Dry only one washer load at a time. Do not combine loads.• Too few items in dryer. If drying only one article, add two or more similar articles, even if dry, to insure proper tumbling.• Improper loads. Avoid laundering heavy permanent press items, such as work clothes, with lighter permanent press items, such as shirts or blouses. Do not wash or dry permanent press with regular laundry.• Too many clothes in washer. Items must have room to move freely. Permanent press loads should always be smaller than regular loads...no more than medium loads.• Use of incorrect wash and dry cycles. If available, use Permanent Press wash cycle which provides a cool-down rinse to minimize wrinkling. Also, if available, use Permanent Press drying cycle.• Incorrect water level. Use large water level for medium load; medium level or half full for small load.• Washing repeatedly in too hot water. Wash in cool or warm water with plenty of detergent.• Failure to use fabric softener. Proper use of fabric softener will minimize wrinkling. |

(continued next page)



THE PROBLEM SOLVER

(continued)

| PROBLEM | POSSIBLE CAUSE |
|-------------------------------------------------------------|---------------------------------------------------------------------------------------------------------------------------------------------------------------------------------------------------------------------------------------------------------------------------------------------------------------------------------------------------------------------------------------------------------------------------------------------------------------------------------------------------------------------------------------------------------------------------------------------------------------------------------------------------------------------------------------------------------------------------------------------------------------------------------------------------------------------------------------------------|
| TO REMOVE WRINKLES ON DRYERS WITH A PERMANENT PRESS SETTING | <p>TO REMOVE WRINKLES:</p> <ul style="list-style-type: none">• Retumble on Permanent Press setting.• Rinse and dry on Permanent Press setting.• If unsuccessful, retumble on normal temperature for 10–12 minutes and hang immediately.• Iron carefully.• Send to Dry Cleaners for pressing.• Some wrinkles may remain which cannot be removed.* <p>* NOTE: If you follow good laundry procedures and permanent press clothes still come out wrinkled, the finish may not be good quality. Also, in permanent press synthetic/cotton blends, the cotton portion of the fabric can eventually wear away leaving only the synthetic. Since its the cotton portion which is treated for permanent press, a loss or decrease of permanent press performance will result.</p> |

We'll Be There

With the purchase of your new RCA appliance, receive the assurance that if you ever need information or assistance, we'll be there. All you have to do is call—toll-free!

In-Home Repair Service **800-GE-CARES (800-432-2737)**

Our consumer service professionals will provide expert repair service on your RCA appliance, scheduled at a time that's convenient for you. Many GE Consumer Service company-operated locations offer you service today or tomorrow, or at your convenience (7:00 a.m. to 7:00 p.m. weekdays, 9:00 a.m. to 2:00 p.m. Saturdays). Our factory-trained technicians know your appliance inside and out—so most repairs can be handled in just one visit.

For Customers With Impaired Hearing... **800-833-4322**

Consumers with impaired hearing or speech who have access to a TDD or a conventional teletypewriter may call 800-TDD-GEAC (800-833-4322) to request information or service.

Service Contracts **800-626-2224**

You can have the secure feeling that GE Consumer Service will still be there after your RCA product warranty expires. Purchase a GE contract while your warranty is still in effect and you'll receive a substantial discount. With a multiple-year contract, you're assured of future service at today's prices.

Parts and Accessories **800-626-2002**

Individuals qualified to service their own appliances can have needed parts or accessories sent directly to their home. Our parts system provides access to over 47,000 Genuine Renewal Parts...and all are fully warranted. VISA, MasterCard and Discover cards are accepted.

User maintenance instructions contained in this booklet cover procedures intended to be performed by any user. Other servicing generally should be referred to qualified service personnel. Caution must be exercised, since improper servicing may cause unsafe operation.

YOUR RCA AUTOMATIC CLOTHES DRYER WARRANTY

Save proof of original purchase date such as your sales slip or cancelled check to establish warranty period.

WHAT IS COVERED

FULL ONE-YEAR WARRANTY

For one year from date of original purchase, we will provide, free of charge, parts and service labor in your home to repair or replace *any part of the dryer* that fails because of a manufacturing defect.

This warranty is extended to the original purchaser and any succeeding owner for products purchased for ordinary home use in the 48 mainland states, Hawaii and Washington, D.C. In Alaska the warranty is the same except that it is LIMITED because you must pay to ship the product to the service shop or for the service technician's travel costs to your home.

FOR SERVICE

We at RCA strive to provide the highest quality products and service. Therefore we have designated GE CONSUMER SERVICE, a leader in the service industry, to fulfill your service needs. Should your appliance need service, during warranty period or beyond, call 800-GE-CARES (800-432-2737).

WHAT IS NOT COVERED

- Service trips to your home to teach you how to use the product.

Read your Use and Care material. If you then have any questions about operating the product, please contact your dealer or Manager—Consumer Affairs
RCA Appliances
Appliance Park
Louisville, KY 40225

- Improper installation.

If you have an installation problem, contact your dealer or installer. You are responsible for providing adequate electrical, gas, exhausting and other connecting facilities.

- Replacement of house fuses or resetting of circuit breakers.
- Failure of the product if it is used for other than its intended purpose or used commercially.
- Damage to product caused by accident, fire, floods or acts of God.

WARRANTOR IS NOT RESPONSIBLE FOR CONSEQUENTIAL DAMAGES.

Some states do not allow the exclusion or limitation of incidental or consequential damages, so the above limitation or exclusion may not apply to you. This warranty gives you specific legal rights, and you may also have other rights which vary from state to state. To know what your legal rights are in your state, consult your local or state consumer affairs office or your state's Attorney General.

Warrantor: RCA Appliances

If further help is needed concerning this warranty, write:
Manager—Consumer Affairs
RCA Appliances
Appliance Park
Louisville, KY 40225

This book is printed on recycled paper.

Part No. 113D5580P204
Pub No. 79-9047

8-94 CG

DRB4900S DRL4980S
DRB4800S DRL4880S
DRB4600S DRL4680S
DRB4400S DRL4480S

RCA
Printed in Louisville, KY