

TV Sound Bar System

Operating Instructions

SA-32SE1/SA-40SE1/SA-46SE1

WARNING

To reduce the risk of fire or electric shock, do not expose this apparatus to rain or moisture.

To reduce the risk of fire, do not cover the ventilation opening of the apparatus with newspapers, tablecloths, curtains, etc. Do not place the naked flame sources such as lighted candles on the apparatus.

To reduce the risk of fire or electric shock, do not expose this apparatus to dripping or splashing, and do not place objects filled with liquids, such as vases, on the apparatus.

Do not expose batteries or apparatus with battery-installed to excessive heat such as sunshine, fire or the like.

Do not install the appliance in a confined space, such as a bookcase or built-in cabinet.

As the main plug of AC adaptor is used to disconnect the unit from the mains, connect it to an easily accessible AC outlet. Should you notice an abnormality in it, disconnect it from the AC outlet immediately.

The unit is not disconnected from the mains as long as it is connected to the AC outlet, even if the unit itself has been turned off.

To prevent injury, this apparatus must be securely attached to the floor/wall in accordance with the installation instructions.

Do not use the AC power cord with other products.

The mains switch is located on the rear exterior.

The nameplate is located on the bottom exterior.

The serial number is located on the bottom exterior.

For customers in the United States, Canada, and Taiwan

The date of manufacturer marking is located on the bottom exterior.

For customers in the United States and Canada



ENERGY STAR[®] is a U.S. registered mark.

As an ENERGY STAR[®] partner, Sony Corporation has determined that this product meets the ENERGY STAR[®] guidelines for energy efficiency.

For customers in the United States

Owner's Record

The model and serial numbers are located on the bottom of the unit. Record these numbers in the space provided below. Refer to them whenever you call upon your Sony dealer regarding this product.

Model No. _____ Serial No. _____

These following indications are located on the bottom exterior of the AC Adaptor.

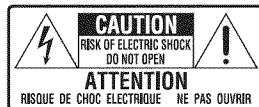

This symbol is intended to alert the user to the presence of uninsulated "dangerous voltage" within the product's enclosure that may be of sufficient magnitude to constitute a risk of electric shock to persons.



This symbol is intended to alert the user to the presence of important operating and maintenance (servicing) instructions in the literature accompanying the appliance.

Important Safety Instructions

- 1) Read these instructions.
 - 2) Keep these instructions.
 - 3) Heed all warnings.
 - 4) Follow all instructions.
 - 5) Do not use this apparatus near water.
 - 6) Clean only with dry cloth.
 - 7) Do not block any ventilation openings. Install in accordance with the manufacturer's instructions.
 - 8) Do not install near any heat sources such as radiators, heat registers, stoves, or other apparatus (including amplifiers) that produce heat.
 - 9) Do not defeat the safety purpose of the polarized or grounding-type plug. A polarized plug has two blades with one wider than the other. A grounding type plug has two blades and a third grounding prong. The wide blade or the third prong are provided for your safety. If the provided plug does not fit into your outlet, consult an electrician for replacement of the obsolete outlet.
 - 10) Protect the power cord from being walked on or pinched particularly at plugs, convenience receptacles, and the point where they exit from the apparatus.
 - 11) Only use attachments/accessories specified by the manufacturer.
 - 12) Use only with the cart, stand, tripod, bracket, or table specified by the manufacturer, or sold with the apparatus. When a cart is used, use caution when moving the cart/apparatus combination to avoid injury from tip-over.
- 
- 13) Unplug this apparatus during lightning storms or when unused for long periods of time.
 - 14) Refer all servicing to qualified service personnel. Servicing is required when the apparatus has been damaged in any way, such as power-supply cord or plug is damaged, liquid has been spilled or objects have fallen into the apparatus, the apparatus has been exposed to rain or moisture, does not operate normally, or has been dropped.

The following FCC statement applies only to the version of this model manufactured for sale in the U.S.A. Other versions may not comply with FCC technical regulations.

NOTE:

This equipment has been tested and found to comply with the limits for a Class B digital device, pursuant to Part 15 of the FCC Rules. These limits are designed to provide reasonable protection against harmful interference in a residential installation.

This equipment generates, uses and can radiate radio frequency energy and, if not installed and used in accordance with the instructions, may cause harmful interference to radio communications. However, there is no guarantee that interference will not occur in a particular installation. If this equipment does cause harmful interference to radio or television reception, which can be determined by turning the equipment off and on, the user is encouraged to try to correct the interference by one or more of the following measures:

- Reorient or relocate the receiving antenna.
- Increase the separation between the equipment and receiver.
- Connect the equipment into an outlet on a circuit different from that to which the receiver is connected.
- Consult the dealer or an experienced radio/TV technician for help.

CAUTION

You are cautioned that any changes or modifications not expressly approved in this manual could void your authority to operate this equipment.

For customers in Europe



Disposal of Old Electrical & Electronic Equipment (Applicable in the European Union and other European countries with separate collection systems)

This symbol on the product or on its packaging indicates that this product shall not be treated as household waste. Instead it shall be handed over to the applicable collection point for the recycling of electrical and electronic equipment. By ensuring this product is disposed of correctly, you will help prevent potential negative consequences for the environment and human health, which could otherwise be caused by inappropriate waste handling of this product. The recycling of materials will help to conserve natural resources. For more detailed information about recycling of this product, please contact your local Civic Office, your household waste disposal service or the shop where you purchased the product.



Disposal of waste batteries (applicable in the European Union and other European countries with separate collection systems)

This symbol on the battery or on the packaging indicates that the battery provided with this product shall not be treated as household waste.

On certain batteries this symbol might be used in combination with a chemical symbol. The chemical symbols for mercury (Hg) or lead (Pb) are added if the battery contains more than 0.0005% mercury or 0.004% lead.

By ensuring these batteries are disposed of correctly, you will help prevent potentially negative consequences for the environment and human health which could otherwise be caused by inappropriate waste handling of the battery. The recycling of the materials will help to conserve natural resources.

In case of products that for safety, performance or data integrity reasons require a permanent connection with an incorporated battery, this battery should be replaced by qualified service staff only.

To ensure that the battery will be treated properly, hand over the product at end-of-life to the applicable collection point for the recycling of electrical and electronic equipment.

For all other batteries, please view the section on how to remove the battery from the product safely. Hand the battery over to the applicable collection point for the recycling of waste batteries.

For more detailed information about recycling of this product or battery, please contact your local Civic Office, your household waste disposal service or the shop where you purchased the product.

Notice for customers: The following information is only applicable to equipment sold in countries applying EU Directives.

The manufacturer of this product is Sony Corporation, 1-7-1 Konan Minato-ku Tokyo, 108-0075 Japan. The Authorized Representative for EMC and product safety is Sony Deutschland GmbH, Hedelfinger Strasse 61, 70327 Stuttgart, Germany. For any service or guarantee matters please refer to the addresses given in separate service or guarantee documents.

About This Manual

The instructions in this manual are for model SA-32SE1/SA-40SE1/SA-46SE1. The illustrations used in this manual are of the SA-32SE1 model and they may be different from your model. Any differences in operation are marked in the manual as “SA-32SE1 model only”.

Table of Contents

Supplied accessories	6
Guide to parts and controls	7
Getting started.....	9
Installing a battery	9
Hooking up the unit.....	9
Installing the unit.....	11
Listening to TV sound from the speaker of the unit	13
Listening to TV sound.....	13
Control the volume of the unit by adjusting the TV volume.....	13
Selecting the sound field.....	14
Precautions.....	15
Troubleshooting	16
POWER	16
SOUND	16
REMOTE CONTROL.....	16
OTHER.....	17
Specifications	17

Supplied accessories

- Operating Instructions (this manual)
- Compatible list (Except for China model) (1)
- Remote control (RM-ANU102) (1)

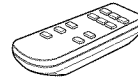

- R03 batteries (size AAA) (2)



- Audio cord (1)

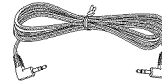

- Plug adaptor (1)



- AC adaptor (1)
- AC power cord (mains lead) (1)
- Foot pads (4)

Guide to parts and controls

This manual mainly explains operations using the buttons on the remote control, but the same operations can also be performed using the buttons on the unit having the same or similar names.

Unit

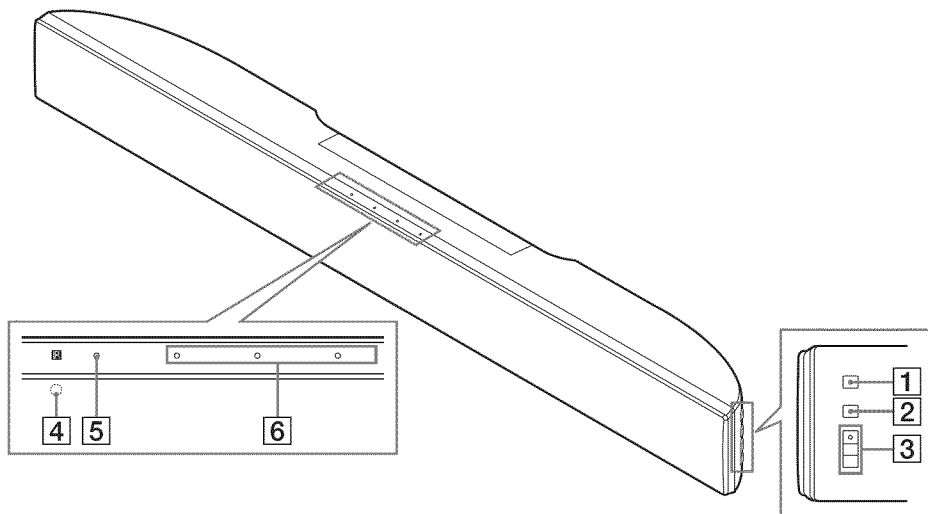

Remote control (RM-ANU102)

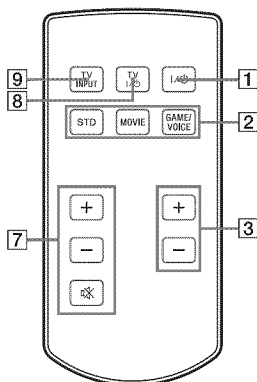

1 I/O (POWER) button

2 SOUND FIELD button

Selects the sound field (page 14).
Unit: Each time you press the button, the sound field changes cyclically as follows:

STANDARD → MOVIE → GAME/VOICE
→ STANDARD → ...

3 Unit: \triangle +*/- button

Remote control: VOL \triangle +/- button

Adjusts the volume.

* The \triangle + button on the unit has tactile dots. Use the tactile dots as references when operating the unit.

4 Remote control sensor

Receives signals from remote control.

continued

5 STANDBY indicator

Lights up in red when the unit is in standby mode.

Notes

- While the unit is in the standby mode, the unit turns on when a sound of a TV is detected. However, it may not turn on if the sound of a TV is very small.
- The unit enters the standby mode automatically when there is no sound input from a TV for about 5 minutes.

6 SOUND FIELD indicator

Shows the status of the SOUND FIELD.

The indicator of the selected sound field lights up in green.

When the volume level is set to maximum or minimum, the indicator flashes 6 times in quick succession.

If you are using a Sony TV, the **7 - **9** operations can be performed with the remote control of the unit.**

7 TV VOL +/- button

Adjust the TV volume.

TV MUTING button

Activates the TV's muting function.

8 TV I/ button

Turns the TV on or off.

9 TV INPUT button

Selects the TV input.

Getting started

Installing a battery

Slide and remove the battery compartment lid, and insert the two supplied R03 (size AAA) batteries,  side first, matching the polarities shown below.

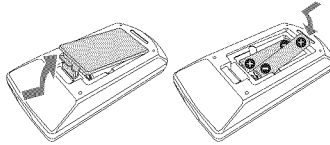

Notes

- Do not mix an old battery with a new one or mix different types of batteries.
- Do not leave the remote control in an extremely hot or humid place.
- Do not expose the remote control sensor to direct sunlight or lighting apparatuses. Doing so may cause a malfunction.
- If you do not intend to use the remote control for an extended period of time, remove the batteries to avoid possible damage from battery leakage and corrosion.
- When the remote control no longer operates the unit, replace both batteries with new ones.
- Do not drop any foreign object into the remote control casing, particularly when replacing the batteries.

Hooking up the unit

- 1** Remove the screw on the rear cover of the unit, then remove the rear cover.

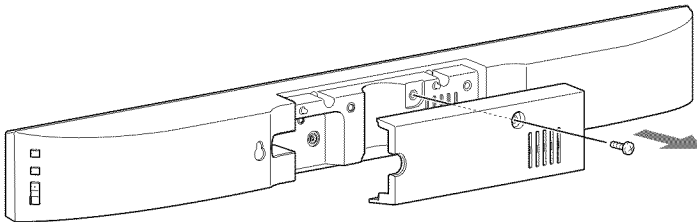

2 Connect an audio cord and a power source.

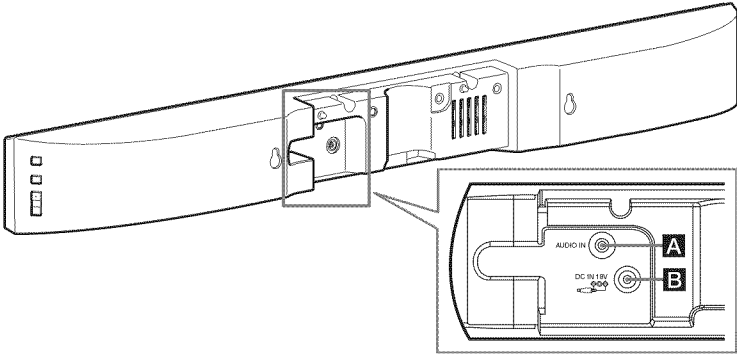

A AUDIO IN jack

Connect the TV audio output jack to the AUDIO IN jack of this unit using an audio cord (supplied).

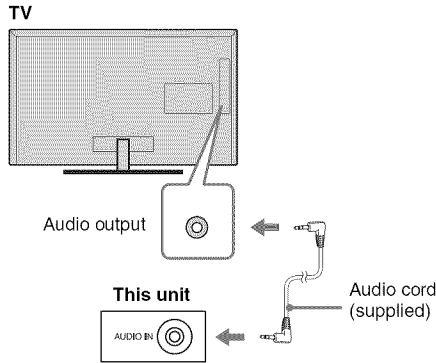

If the audio output jack of your TV is not compatible with the audio cord (supplied)

Connect the audio cord (supplied) to the TV audio output jack using the plug adaptor (supplied).

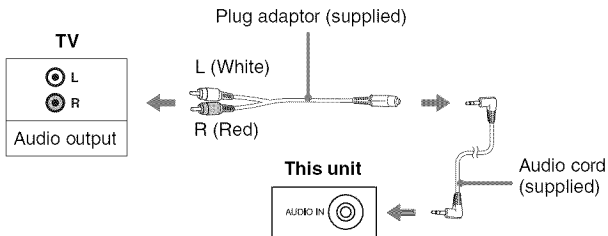

B DC IN 18V jack

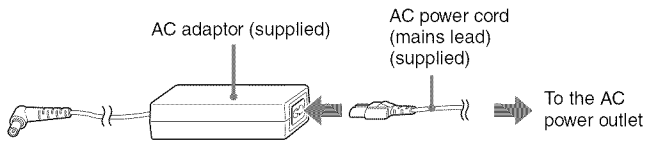

Attach the AC power cord (mains lead) (supplied) to the AC adaptor (supplied). Then plug the connector of the AC adaptor into the DC IN 18V jack on the rear of the unit.

After you have made all connections, connect the AC power cord (mains lead) into the AC power outlet. If the supplied adaptor on the plug does not fit your wall outlet, detach it from the plug (only for models equipped with an adaptor).

- 3 Guide the audio cord and the cable attached to the AC adaptor through the notch at the side of the rear cover, then reattach the rear cover to the unit and secure it with the screw removed in step 1.**

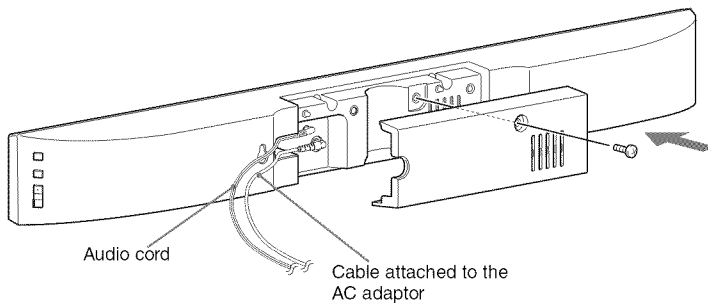

Installing the unit

Installing the unit on a flat surface

Be sure to attach the supplied foot pads to prevent vibration or movement as shown in the illustration below.

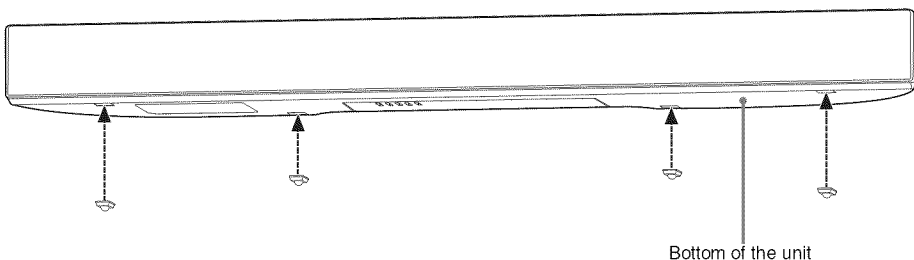

Installing the unit on a wall

You can secure the unit on a wall.

Notes

- Use screws that are suitable for the wall material and strength. As a plaster board wall is especially fragile, attach the screws securely to a wall beam. Install the speaker on a vertical and flat reinforced area of the wall.
- Be sure to subcontract the installation to Sony dealers or licensed contractors and pay special attention to safety during the installation.
- Sony is not responsible for accidents or damage caused by improper installation, insufficient wall strength, improper screw installation or natural calamity, etc.

1 Prepare screws (not supplied) that are suitable for the hook on the rear of the unit. See the illustrations below.

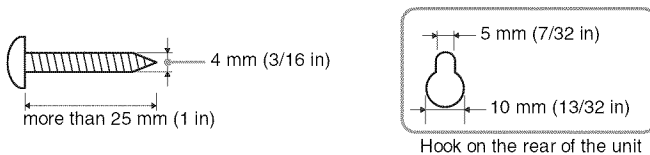

2 Fasten the screws to the wall. The screws should protrude from the wall. See the illustration below.

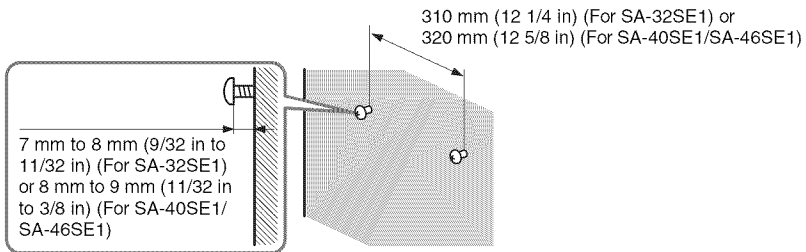

3 Hang the unit onto the screws.

Align the holes on the rear of the unit to the screws, then hang the unit onto the two screws.

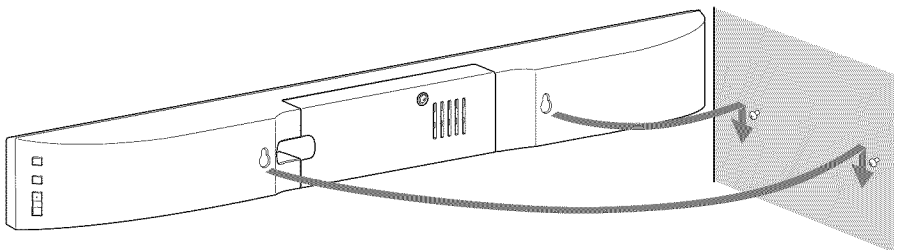

Installing the unit to the TV (Except for China model)

You can install this unit to the TV using the optional speaker attachment bracket. For details on the compatible TV model and the speaker attachment bracket, refer to the supplied "Compatible list".

Listening to TV sound from the speaker of the unit

Listening to TV sound

1 Turn on the unit or make sure the unit is in standby mode.

2 Turn on the TV.

While the unit is in the standby mode, the unit turns on automatically when a sound of a TV is detected.

3 Adjust the volume of the unit.

Note

When the sound output level of your TV cannot be changed, adjust the volume of the unit.

Control the volume of the unit by adjusting the TV volume

If the sound output jack of the TV can be set to “Variable”, the volume of the unit can be changed by adjusting the TV volume. For TV settings, refer to the operating instructions of the TV.

1 Set the sound output jack of the TV to “Variable”.

2 Adjust the volume of the unit according to the TV.

The above settings 1 and 2 allow you to control the volume of the unit by adjusting the TV volume.

Note

If sufficient volume level cannot be obtained from the unit when the sound output jack of the TV is set to “Variable”, set the sound output jack of the TV to “Fixed” and adjust the volume of the unit.

Selecting the sound field

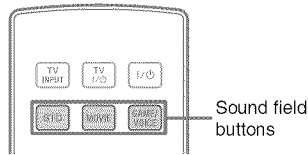

Press one of the sound field buttons you want to use.

You can also use SOUND FIELD button on the unit.

Sound field	Effect
STANDARD (STD)	Suitable for use for a wide range of sources of any type.
MOVIE	Provides dynamic sound and realistic sensation.
GAME/VOICE	Features easy-to-hear dialogue and clear sound.

Precautions

On safety

Should any solid object or liquid get into the unit, unplug the unit, and have it checked by qualified personnel before operating it again.

On power sources

- Before operating the unit, check that the operating voltage is identical with your local power supply.
- Do not plug the AC power cord (mains lead) for the unit into an electrical outlet until you have made all other connections. Make sure the TV or other equipment is unplugged from the electrical outlet prior to connecting it to the unit.
- Do not connect the AC power cord (mains lead) to a voltage transformer or inverter. Connecting the AC power cord (mains lead) to a voltage transformer for overseas travel or an inverter for use in an automobile may cause heat to build up in the AC adaptor and may cause burns or a malfunction.
- Do not use an AC adaptor or AC power cord (mains lead) other than the supplied AC adaptor and AC power cord (mains lead). Do not modify the cord.

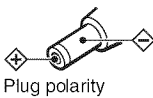

- Do not touch the plug of the AC power cord (mains lead) with wet hands.
- Do not touch the AC power cord (mains lead), AC adaptor or the unit, if connected to an electrical outlet, during an electrical storm.
- Do not place heavy items on the cord.
- Do not place the AC power cord (mains lead) near heating equipment and do not expose the cord to heat.

- Completely disconnect the AC power cord (mains lead) from the wall socket (mains) if it is not going to be used for an extended period of time. When unplugging the unit, always grip the plug. Never pull the cord itself.
- (USA and Canada model only)
One blade of the plug is wider than the other for the purpose of safety and will fit into the wall outlet only one way. If you are unable to insert the plug fully into the outlet, contact your dealer.
- The AC power cord (mains lead) can be changed only by a qualified service facility.

On placement

- Do not place the unit in an inclined position or in locations that are extremely hot, cold, dusty, dirty, or humid or lacking adequate ventilation, or subject to vibration, direct sunlight or a bright light.
- Be careful when placing the unit on surfaces that have been specially treated (for example, with wax, oil, polish) as staining or discoloration of the surface may result.
- Since a strong magnet is used for the speakers, keep personal credit cards using magnetic coding or spring-wound watches away from the unit to prevent possible damage from the magnet.

On heat buildup

- Heat buildup on the unit during operation is normal and is not a cause for alarm.
- Do not touch the cabinet if it has been used continuously at a high volume because the cabinet may have become hot.
- Do not obstruct the ventilation holes.

On cleaning

Clean this unit with a soft cloth slightly moistened with a mild detergent solution. Do not use any type of abrasive pad, scouring powder, or solvent, such as thinner, benzene, or alcohol.

Troubleshooting

If you experience any of the following difficulties while using the unit, use this troubleshooting guide to help you remedy the problem. Should any problem persist, consult your nearest Sony dealer.

POWER

The power is not turned on.

- Make sure the AC adaptor and the AC power cord (mains lead) is connected correctly and firmly (page 11).
- Press the I/⏻ (POWER) button on the unit. The SOUND FIELD indicator lights up in green.

The unit enters standby mode automatically.

- The unit enters standby mode automatically when there is no sound input for approximately 5 minutes.

SOUND

There is no sound or only a very low-level sound is heard.

- Check that the audio cord of the unit and the TV is fully inserted (page 10).
- Press VOL ▲ + (or ▲ + on the unit) repeatedly (page 7).
- Cancel the muting function of the TV.
- Check that headphones are not connected to the TV.

Sound from the unit is not synchronized with TV.

- For some TV models, the sound from the unit and sound of a TV may not be synchronized when sound is output from both the unit and TV. Set the sound output jack of the TV to “Fixed” if it can be switched between “Fixed” and “Variable”. Set the TV volume to minimum or mute the TV sound and adjust the volume of the unit.
- If any other home theatre system is used at the same time, turn off the power of the unit.

The sound is distorted.

- Press TV VOL ▲ – repeatedly (page 8).
- Press VOL ▲ – (or ▲ – on the unit) repeatedly (page 7).

There is severe noise.

- Someone is using a portable telephone or other equipment that emits radio waves near the unit. Move the portable telephone, etc. away from the unit.

REMOTE CONTROL

The remote control does not function.

- Point the remote control at the remote control sensor on the unit (page 7).
- Remove any obstacles in the path between the remote control and the unit.
- Replace all the batteries in the remote control with new ones, if they are weak.

OTHER

The STANDBY indicator flashes.

- Turn off the unit and unplug the AC power cord (mains lead) immediately.
- Remove anything that is blocking the ventilation hole.

If the unit still does not operate properly after performing the above measures, reset the unit as follows:

Use the button on the unit for the operation.

1 Press I/⏻ to turn on the unit.

2 Hold down I/⏻ for 5 seconds.

STANDBY indicator flashes 3 times and the unit is reset to the default settings.

Specifications

Amplifier section

AUDIO POWER SPECIFICATIONS

POWER OUTPUT AND TOTAL HARMONIC DISTORTION:

(FTC)

(USA model only)

L + R

With 8 ohm loads, both channels driven, from 300 – 20,000 Hz; rated 14 watts per channel minimum RMS power, with no more than 1% total harmonic distortion from 250 milliwatts to rated output.

POWER OUTPUT (reference)

L / R

20 W (per channel at 8 ohms, 1 kHz)

(China model only)

POWER OUTPUT (rated)

(Measured under MOVIE sound field)

L + R

9.5 W + 9.5 W
(at 8 ohms, 1 kHz,
1% THD)

(Other models)

POWER OUTPUT (rated)

L + R

16 W + 16 W
(at 8 ohms, 1 kHz,
1% THD)

POWER OUTPUT (reference)

L / R

20 W (per channel at 8 ohms, 1 kHz, 10% THD)

Speaker section

Front speaker unit	
Speaker system	Full range, passive radiator type
Speaker unit	
For SA-32SE1	65 mm (2 5/8 in) (Cone type) 70 mm × 100 mm (2 7/8 in × 4 in) (Passive radiator)
For SA-40SE1/SA-46SE1	65 mm (2 5/8 in) (Cone type) 65 mm (2 5/8 in) × 2 (Passive radiator)
Rated impedance	8 ohms

General

Inputs	AUDIO IN jack (1)
Power requirements	DC 18 V (2.6 A) (100 V - 240 V AC, 50/60 Hz using the supplied AC adaptor)
Power consumption	In standby mode: 0.5 W or less

Main unit

Dimensions (w/h/d) (Approx.)	
For SA-32SE1	754.2 mm × 80 mm × 76.7 mm (29 3/4 in × 3 1/4 in × 3 1/8 in)
For SA-40SE1	942.4 mm × 80 mm × 67.7 mm (37 1/8 in × 3 1/4 in × 2 3/4 in)
For SA-46SE1	1,077.6 mm × 80 mm × 67.7 mm (42 1/2 in × 3 1/4 in × 2 3/4 in)
Mass (Approx.)	
For SA-32SE1	1.9 kg (4 lb 4 oz)
For SA-40SE1	2.2 kg (4 lb 14 oz)
For SA-46SE1	2.5 kg (5 lb 9 oz)

AC adaptor

Input	100 V - 240 V AC, 50/60 Hz
Output	DC 18 V, 2.6 A
Dimensions (w/h/d) (Approx.)	
India model	124 mm × 32 mm × 60 mm (5 in × 1 5/16 in × 2 3/8 in)
Other models	121 mm × 33 mm × 53 mm (4 7/8 in × 1 5/16 in × 2 1/8 in)
Mass (Approx.)	
India model	294 g (10.4 oz)
Other models	240 g (8.5 oz)

Design and specifications are subject to change without notice.



* 4 2 6 9 5 4 4 1 2 * (1)