



Refrigerators

Safety Information2, 3

Operating Instructions

Care and Cleaning6–8

Control Settings4

Refrigerator Features5

Replacing the Light Bulb6

Installation Instructions . . .9–11

Troubleshooting Tips . . .12, 13

Consumer Support

Consumer Support . . .Back Cover

Warranty15

**Owner's Manual
& Installation
Instructions**

- 2 Cubic Foot Models
- 3 Cubic Foot Models
- 4 Cubic Foot Models
- 6 Cubic Foot Models

ATTENTION:

Defrosting—Do not use sharp, pointed objects to remove frost or ice from surfaces of the freezer compartment. Doing so could puncture the cooling coil, causing the unit to lose its ability to maintain cold temperatures and voiding the warranty. See the Care and Cleaning section for instructions on defrosting the freezer compartment.

Write the model and serial numbers here:

Model # _____

Serial # _____

Find these numbers on a label inside the refrigerator on the side wall.



IMPORTANT SAFETY INFORMATION. READ ALL INSTRUCTIONS BEFORE USING.

⚠ WARNING!

Use this appliance only for its intended purpose as described in this Owner's Manual.



SAFETY PRECAUTIONS

When using electrical appliances, basic safety precautions should be followed, including the following:

- This refrigerator must be properly installed and located in accordance with the Installation Instructions before it is used.
- Do not allow children to climb, stand or hang on the shelves in the refrigerator. They could damage the refrigerator and seriously injure themselves.
- Do not store or use gasoline or other flammable vapors and liquids in the vicinity of this or any other appliance.
- **Before replacing a burned-out light bulb, the refrigerator should be unplugged** in order to avoid contact with a live wire filament. (A burned-out light bulb may break when being replaced.)
- Keep fingers out of the “pinch point” areas; clearances between the doors and cabinet are necessarily small. Be careful closing doors when children are in the area.
- Unplug the refrigerator before cleaning and making repairs.

NOTE: We strongly recommend that any servicing be performed by a qualified individual.
- Turning the temperature control dial to the **OFF** position stops cooling but does not shut off power to the refrigerator.

⚠ DANGER! RISK OF CHILD ENTRAPMENT PROPER DISPOSAL OF THE REFRIGERATOR

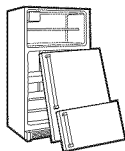

Child entrapment and suffocation are not problems of the past. Junked or abandoned refrigerators are still dangerous... even if they will sit for “just a few days.” If you are getting rid of your old refrigerator, please follow the instructions below to help prevent accidents.

Before You Throw Away Your Old Refrigerator or Freezer:

- Take off the doors.
- Leave the shelves in place so that children may not easily climb inside.

Refrigerants

All refrigeration products contain refrigerants, which under federal law must be removed prior to product disposal. If you are getting rid of an old refrigeration product, check with the company handling the disposal about what to do.

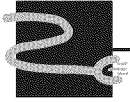

USE OF EXTENSION CORDS

Because of potential safety hazards under certain conditions, we strongly recommend against the use of an extension cord.

However, if you must use an extension cord, it is absolutely necessary that it be a UL-listed, 3-wire grounding type appliance extension cord having a grounding type plug and outlet and that the electrical rating of the cord be 15 amperes (minimum) and 120 volts.



HOW TO CONNECT ELECTRICITY

Do not, under any circumstances, cut or remove the third (ground) prong from the power cord. For personal safety, this appliance must be properly grounded.

The power cord of this appliance is equipped with a 3-prong (grounding) plug which mates with a standard 3-prong (grounding) wall outlet to minimize the possibility of electric shock hazard from this appliance.

Have the wall outlet and circuit checked by a qualified electrician to make sure the outlet is properly grounded.

If you have only a standard 2-prong wall outlet, it is your personal responsibility and obligation to have it replaced with a properly grounded 3-prong wall outlet.

The refrigerator should always be plugged into its own individual electrical outlet which has a voltage rating that matches the rating plate.

This provides the best performance and also prevents overloading house wiring circuits which could cause a fire hazard from overheated wires.

Never unplug your refrigerator by pulling on the power cord. Always grip plug firmly and pull straight out from the outlet.

Repair or replace immediately all power cords that have become frayed or otherwise damaged. Do not use a cord that shows cracks or abrasion damage along its length or at either end.

When moving the refrigerator away from the wall, be careful not to roll over or damage the power cord.



READ AND FOLLOW THIS SAFETY INFORMATION CAREFULLY.

SAVE THESE INSTRUCTIONS

About the control on the refrigerator.

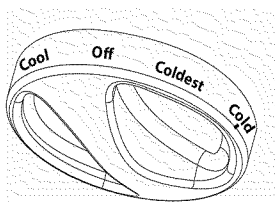

Fig. 1

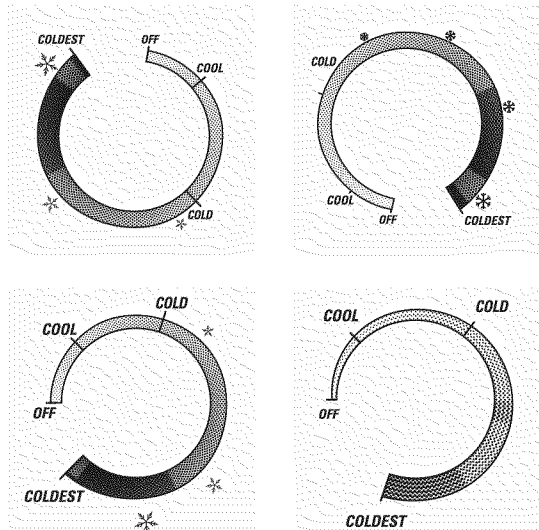

Fig. 2

The control will look like one of the above.



Control Settings

The temperature control maintains the temperature in the refrigerator. Setting the control at **COOL** is the warmest setting. Setting the control at **COLDEST** is the coldest setting. Set the control at **COLD**. (See Fig. 1 or 2)

Allow 24 hours for the refrigerator to reach the desired temperature. If you want a colder or warmer temperature, move the dial one setting at a time. Moving the control to **OFF** stops cooling but does not turn off the power to the refrigerator. Setting the control too high/one of the Snowflake positions may cause freezing in the refrigerator depending on the room temperature.

How To Test Temperatures

Use the milk test. Place a container of milk on a shelf and check it a day later. If the milk is too warm or too cold, adjust the temperature control.

After changing the control, allow 24 hours for the refrigerator to reach the temperature you have set.

Shelves

To remove a shelf, lift up the back slightly and pull forward. Some models have multi-position shelves that can be moved to different levels.

Ice Tray Compartment

This compartment is designed for production of ice cubes and short-term storage (a few days at most) of some commercially-frozen foods when in contact with the evaporator (cold surface in compartment.)

Door Shelves

Shelves on the door provide convenient storage for frequently used items. Some models have doors that are deep enough to store large bottles.

Key-Ejecting Lock (on some models)

The key for the spring-loaded lock is automatically ejected—key will not remain in lock in either the open or closed position.

Keep the key out of reach of children and away from the refrigerator.

If a replacement key is needed, it can be ordered by visiting our Website **GEAppliances.com**, or calling GE Parts and Accessories, 800.626.2002. Order part WR05X10006.

Care and cleaning of the refrigerator.

Cleaning the Outside

Keep the outside clean. Wipe with a clean cloth lightly dampened with kitchen appliance wax or mild liquid dish detergent. Dry and polish with a clean, soft cloth.

Do not wipe the refrigerator with a soiled dish cloth or wet towel. These may leave a residue that can erode the paint. Do not use scouring pads, powdered cleaners, bleach or cleaners containing bleach because these products can scratch and weaken the paint finish.

Protect the paint finish. The finish on the outside of the refrigerator is a high quality, baked-on paint finish. With proper care, it will stay new-looking and rust-free for years. Apply a coat of kitchen/appliance wax when the refrigerator is new, and then at least twice a year.



Cleaning the Inside

To help prevent odors, leave an open box of baking soda in the refrigerator.

Unplug the refrigerator before cleaning. If this is not practical, wring excess moisture out of sponge or cloth when cleaning around the control.

Use warm water and baking soda solution—about a tablespoon (15 ml) of baking soda to a quart (1 liter) of water. This both cleans and neutralizes odors. Rinse and wipe dry.

Other parts of the refrigerator—including door gaskets, fruit and vegetable drawers, and all plastic parts—can be cleaned the same way.

Do not wash any plastic refrigerator parts in the dishwasher.

Replacing the Light Bulb (on some models)

Unplug the refrigerator before replacing a burned-out bulb. Setting the controls to **OFF** does not remove power to the light circuit.

The light bulb is located behind the temperature control housing and is visible through the slots in the housing.

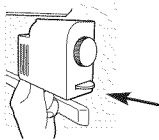

Reach up through the opening at the bottom of the control housing and gently unscrew the light bulb. Replace with a bulb of the same or lower wattage.

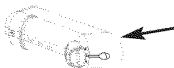

Using a Philips screwdriver, unscrew the lens and pull horizontally until the lens is removed. Gently unscrew the light bulb and replace with a bulb of 15 watts or less.

Defrosting (on push button defrost models only)

Defrost whenever frost on the wall of the ice tray compartment becomes 1/4" thick.

To defrost:

- Remove foods and ice trays from the refrigerator and ice tray compartment.
- Ensure drip tray is below ice tray compartment to collect water.
- Push in the red "Defrost Button" located in the center of the temperature control dial. Defrost cycle will start immediately. **NOTE:** Turning the temperature control dial to the **OFF** position is not required.

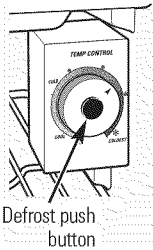

Defrosting usually takes a few hours. When defrosting is complete, the red "Defrost Button" will release automatically. Then the refrigerator will resume normal operation while moving towards the set temperature.

NOTE: After defrosting, allow a few hours to reach the set temperature before making any further adjustments.

To defrost faster, keep the door open. Also, pouring warm (not hot) water on the frosted part may speed defrosting. **Do not use boiling water**—it may damage plastic parts.

CAUTION: If you decide to "speed up" the defrost cycle by manually removing ice, **NEVER use a sharp or metallic instrument to chip away the ice as it may damage the cooling coils.** (A punctured cooling coil will cause serious problems and void the warranty.) Do not use any electrical device in defrosting your refrigerator.

After defrosting:

- After red "Defrost Button" has released, empty water from the drip tray. Wash the tray with warm water. Dry the drip tray completely.
- Wipe the ice tray compartment with a damp cloth.
- Return drip tray to below ice tray compartment.
- Return food and ice trays to the refrigerator and close the door.

IMPORTANT: If the red "Defrost Button" is pushed accidentally, it can not be manually released. The defrost cycle will run until complete.

To speed up the defrost cycle, remove the drip tray and apply a warm damp cloth against the temperature sensing wire located on the underside of the ice tray compartment. After several minutes, the heat from the warm cloth will raise the temperature of the thermostat, causing the defrost cycle to end and releasing the red "Defrost Button." The refrigerator will then resume normal operation.

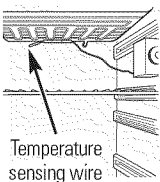

NOTE: If ice buildup is very thick, it may keep the ice tray compartment door from opening or closing completely. Don't try to force it open or closed; after defrosting, the door will open and close easily.

Care and cleaning of the refrigerator.

Defrosting (on manual defrost models only)

Defrost whenever frost on the wall of the ice tray compartment becomes 1/4" thick. **Never use a sharp or metallic instrument to remove frost as it may damage the cooling coils.** (A punctured cooling coil will cause serious problems and void the warranty.) We recommend using a plastic scraper. Do not use any electrical device in defrosting your refrigerator.

To defrost:

- Remove foods and ice trays from the ice tray compartment.
- Set the temperature control dial to **0**.
- On models without a drip tray, place a pan beneath the ice tray compartment to collect water.

Defrosting usually takes a few hours. To defrost faster, keep the door open. Also, pouring warm (not hot) water on the frosted part may speed defrosting. **Do not use boiling water**—it may damage plastic parts.

After defrosting:

- Empty water from the drip tray or from the pan placed beneath the ice tray compartment. Wash the tray or pan with warm water.
- Wipe the ice tray compartment with a damp cloth.
- Turn the temperature control to the desired setting and return food and ice trays to the refrigerator.

NOTE: If ice buildup is very thick, it may keep the ice tray compartment door from opening or closing completely. Don't try to force it open; after defrosting, the door will open and close easily.

Preparing for Vacation

For long vacations or absences, remove food and unplug the refrigerator. Move the control to the **OFF** position, and clean the interior with a baking soda solution of one tablespoon (15 ml) of baking soda to one quart (1 liter) of water. Leave the door open.

Preparing to Move

Secure all loose items such as shelves and ice trays by taping them securely in place to prevent damage.

Be sure the refrigerator stays in an upright position during moving.

Preparing to install the refrigerator.

GEAppliances.com

Read these instructions completely and carefully.



Refrigerator Location

- Do not install the refrigerator where the temperature will go below 50°F (10°C) because it will not run often enough to maintain proper temperatures.
- Install it on a floor strong enough to support it fully loaded.
- If the 2 cubic foot model is placed on a countertop or stand, the front surface of the door should be 3" or more back from the edge of the countertop or stand to avoid accidental tipping of the appliance during normal use.
- Do not install it closer than 5" (13 cm) from range.

The following applies only to the 2, 3 and 4 Cubic Foot Models:

- Do not install it in a recessed area.
- Do not build in the refrigerator.

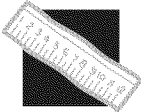

Clearances

Allow the following clearances for ease of installation and proper air circulation.

	2, 3 and 4 Cubic Foot Models	6 Cubic Foot Model only
Sides	1/2"(13 mm)	0"(0 mm)*
Top	2"(51 mm)	0"(0 mm)
Back	2"(51 mm)**	1"(25 mm)

*1-1/4"(32 mm) for hinge side clearance

** From the rear cabinet surface to the wall

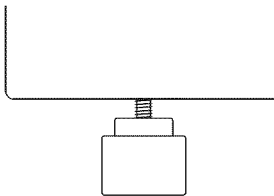

Turn counterclockwise to raise, clockwise to lower.

Leveling Legs (on some models)

Adjustable legs at the front corners of the refrigerator should be set so the refrigerator is firmly positioned on the floor and the front is raised just enough that the door closes easily when opened about halfway.

To adjust the leveling legs, turn the legs **counterclockwise to raise** the refrigerator, **clockwise to lower** it.

Preparing to install the refrigerator.

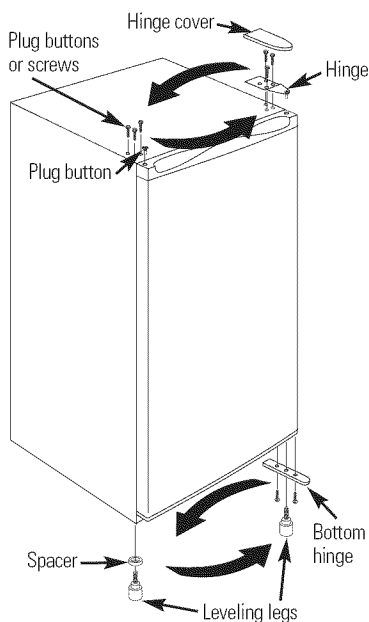

Door Reversal (on some models)

1. Remove the small plug button on the left side of the door top cap.
 2. Remove the 3 (2 on some models) plug buttons or screws on the left side on top of the cabinet.
 3. Remove the plastic hinge cover by lifting it up by the front edge. Some models also require removal of a screw.
 4. Remove the 3 (2 on some models) screws from the top hinge.
 5. Lift the door up and off the bottom hinge (right side).
 6. Tilt the refrigerator cabinet back to remove the right leveling leg.
 7. Remove the screws on the bottom hinge (right side) and remove the leveling legs. Move the bottom hinge to the left side and secure it with screws. Re-install the leveling legs.
- IMPORTANT:** The left leg has a spacer or spacer feature that must be moved to the right side leveling leg when the door swing is reversed.
8. Screw the right leveling leg, with the spacer in place, back in place on the right side.
 9. Position the door on the left bottom hinge. With the magnetic gasket holding the door in place, secure the top hinge with screws.
 10. **Make sure the door is aligned with the refrigerator cabinet before continuing.**
 11. Replace the hinge cover on top of the hinge.
 12. Put the plug button in the hole on the right side of the door cap.
 13. Put the 3 (2 on some models) plug buttons on the right side on top of the cabinet

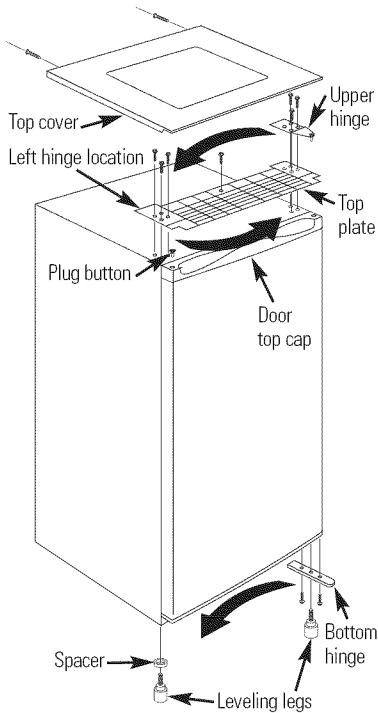

Door Reversal (on some models)

4 Cubic Foot Models

1. Remove the two screws at the back of the top cover.
 2. Remove the top cover by lifting the back up about 2" and then sliding it forward.
 3. Remove the small plug button on the left side of the door top cap.
 4. Remove the three screws on the upper hinge (right side). Remove the hinge.
 5. Remove the three screws at the left hinge location on the top plate.
 6. Remove the screw in the middle of the top plate and remove the top plate.
 7. Lift the door up and off the bottom hinge (right side).
 8. Tilt the refrigerator cabinet back to remove the right leveling leg.
 9. Remove the screws on the bottom hinge (right side) and the left leveling leg. Move the bottom hinge to the left side and secure it with the screws and leveling leg.
- IMPORTANT:** The left leg has a spacer that must be moved to the right side leveling leg when the door swing is reversed.
10. Screw the right leveling leg, with the spacer in place, back in place on the right side.
 11. Position the door on the left bottom hinge. With the magnetic gasket holding the door in place, secure the top hinge with screws.
 12. **Make sure the door is aligned with the refrigerator cabinet before continuing.**
 13. Replace the top plate and screws.
 14. Slide the top cover back in place and replace the two screws.
 15. Put the plug button in the hole on the right side of the door top cap.

Before you call for service...



Troubleshooting Tips

Save time and money! Review the chart below first and you may not need to call for service.

Problem	Possible Causes	What To Do
Refrigerator does not operate	Control in OFF position.	* Move the control to a temperature setting.
	Refrigerator is unplugged.	* Push the plug completely into the outlet.
	The fuse is blown/circuit breaker is tripped.	* Replace fuse or reset the breaker.
	Red defrost button was pushed accidentally (on push button models).	* See IMPORTANT: text in Defrosting under Care and Cleaning .
Vibration or rattling (slight vibration is normal)	Front leveling legs (on some models) need adjusting.	* See Leveling Legs .
	Refrigerator is on an uneven surface.	* Use shims to level the refrigerator.
Motor operates for long periods or cycles	Normal when refrigerator is first plugged in.	* Wait 24 hours for the refrigerator to completely cool down.
	Often occurs when large amounts of food are placed in refrigerator.	* This is normal.
	Door left open.	* Check to see if package is holding door open.
	Hot weather or frequent door openings.	* This is normal.
	Temperature control set at the coldest setting.	* See About the control .
	Not enough clearance from the wall.	* See Clearances in Preparing to install the refrigerator .
	Door will not open	Refrigerator is locked (lock is available on some models).



Troubleshooting Tips

Problem	Possible Causes	What To Do
Refrigerator too warm	Temperature control not set cold enough.	* See About the control.
	Warm weather or frequent door openings.	* Set the temperature control one step colder. See About the control.
	Door left open.	* Check to see if package is holding door open.
	Cabinet sides are warm (applies only to 2, 3 and 4 Cubic Foot Models).	* This is normal for a hot wall type condenser.
	Red defrost button was pushed accidentally (on push button models).	* See IMPORTANT: text in Defrosting under Care and Cleaning.
Refrigerator has odor	Foods transmitting odor to refrigerator.	* Foods with strong odors should be tightly wrapped. * Keep an open box of baking soda in the refrigerator; replace every three months.
	Interior needs cleaning.	* See Care and cleaning.
	Defrost water pan needs cleaning.	* See Care and cleaning.
Moisture forms on outside of refrigerator	Not unusual during periods of high humidity.	* Wipe surface dry.
Moisture collects inside (in humid weather, air carries moisture into refrigerator when door is opened)	Too frequent or too long door openings.	
Refrigerator too cold	Temperature control set too cold.	* See About the control.

Notes.

Refrigerator Warranty. (For customers in the United States)



All warranty service provided by our Factory Service Centers, or an authorized Customer Care® technician. To schedule service, on-line, 24 hours a day, visit us at GEAppliances.com, or call 800.GE.CARES. Please have serial and model numbers available when calling for service.

Staple your receipt here. Proof of the original purchase date is needed to obtain service under the warranty.

For The Period Of:

One Year

From the date of the original purchase

GE Will Replace:

Any part of the refrigerator which fails due to a defect in materials or workmanship. During this **limited one-year warranty**, GE will also provide, **free of charge**, all labor and related service costs to replace the defective part.

What GE Will Not Cover:

- Service trips to your home to teach you how to use the product.
- Improper installation, delivery or maintenance.
- Failure of the product if it is abused, misused, or used for other than the intended purpose or used commercially.
- Loss of food due to spoilage.
- Damage caused after delivery.
- Replacement of house fuses or resetting of circuit breakers.
- Replacement of the light bulbs.
- Damage to the product caused by accident, fire, floods or acts of God.
- Incidental or consequential damage caused by possible defects with this appliance.
- Product not accessible to provide required service.

EXCLUSION OF IMPLIED WARRANTIES—Your sole and exclusive remedy is product repair as provided in this Limited Warranty. Any implied warranties, including the implied warranties of merchantability or fitness for a particular purpose, are limited to one year or the shortest period allowed by law.

This warranty is extended to the original purchaser and any succeeding owner for products purchased for home use within the USA. If the product is located in an area where service by a GE Authorized Servicer is not available, you may be responsible for a trip charge or you may be required to bring the product to an Authorized GE Service location for service. In Alaska, the warranty excludes the cost of shipping or service calls to your home.

Some states do not allow the exclusion or limitation of incidental or consequential damages. This warranty gives you specific legal rights, and you may also have other rights which vary from state to state. To know what your legal rights are, consult your local or state consumer affairs office or your state's Attorney General.

Consumer Support.



GE Appliances Website

GEAppliances.com

Have a question or need assistance with your appliance? Try the GE Appliances Website 24 hours a day, any day of the year! For greater convenience and faster service, you can now download Owner's Manuals, order parts, catalogs, or even schedule service on-line. You can also "Ask Our Team of Experts™" your questions, and so much more...

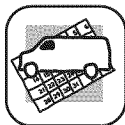

Schedule Service

GEAppliances.com

Expert GE repair service is only one step away from your door. Get on-line and schedule your service at your convenience 24 hours any day of the year! Or call 800.GE.CARES (800.432.2737) during normal business hours.

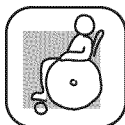

Real Life Design Studio

GEAppliances.com

GE supports the Universal Design concept—products, services and environments that can be used by people of all ages, sizes and capabilities. We recognize the need to design for a wide range of physical and mental abilities and impairments. For details of GE's Universal Design applications, including kitchen design ideas for people with disabilities, check out our Website today. For the hearing impaired, please call 800.TDD.GEAC (800.833.4322).



Extended Warranties

GEAppliances.com

Purchase a GE extended warranty and learn about special discounts that are available while your warranty is still in effect. You can purchase it on-line anytime, or call 800.626.2224 during normal business hours. GE Consumer Home Services will still be there after your warranty expires.

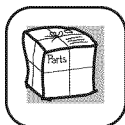

Parts and Accessories

GEAppliances.com

Individuals qualified to service their own appliances can have parts or accessories sent directly to their homes (VISA, MasterCard and Discover cards are accepted). Order on-line today, 24 hours every day or by phone at 800.626.2002 during normal business hours.

Instructions contained in this manual cover procedures to be performed by any user. Other servicing generally should be referred to qualified service personnel. Caution must be exercised, since improper servicing may cause unsafe operation.



Contact Us

GEAppliances.com

If you are not satisfied with the service you receive from GE, contact us on our Website with all the details including your phone number, or write to:

General Manager, Customer Relations
GE Appliances, Appliance Park
Louisville, KY 40225



Register Your Appliance

GEAppliances.com

Register your new appliance on-line—at your convenience! Timely product registration will allow for enhanced communication and prompt service under the terms of your warranty, should the need arise. You may also mail in the pre-printed registration card included in the packing material.