



# MICROWAVE / CONVECTION OVEN

Use and Care Guide

# HORNO DE MICROONDAS/CONVECCIÓN

Manual de uso y cuidado

Models/Modelos 721. 67902  
721. 67903  
721. 67909



ENGLISH

ESPAÑOL

Sears, Roebuck and Co., Hoffman Estates, IL 60179 U.S.A.

MFL31663701

[www.sears.com](http://www.sears.com)

# TABLE OF CONTENTS

<b>WARRANTY</b> .....	<b>2</b>	Sensor Popcorn/Sensor Cook .....	16
<b>SAFETY</b> .....	<b>3-4</b>	Sensor Cook Table.....	17
Precautions to Avoid Possible Exposure		Auto Defrost/Auto Defrost Table .....	18
to Excessive Microwave Energy .....	3	Time Defrost/Express Defrost.....	19
Grounding Instructions .....	3	<b>USING YOUR CONVECTION OVEN</b> .....	<b>20-26</b>
Important Safety Instructions .....	4	Tips for Convection Cooking/Precautions.....	20
<b>UNDERSTANDING YOUR MICROWAVE OVEN..</b>	<b>5-10</b>	Auto Bake/Auto Bake Table .....	21
Specifications .....	5	Auto Roast/Auto Roast Table.....	22
Installation .....	5	Convection .....	23
Parts and Accessories .....	6	Convection Cooking Guide .....	24
Control Panel Features .....	7	Convection Baking Table.....	25
Cooking Comparison Guide .....	8	Meat Roasting Table for Convection Cooking.....	26
Cookware Guide .....	9	<b>USING YOUR COMBINATION OVEN</b> .....	<b>27-28</b>
How to Use Accessories .....	9	Tips for Combination Cooking.....	27
Tips for Microwave Cooking.....	10	Helpful Hints for Combination Cooking.....	27
Cleaning .....	10	Combination .....	27
<b>USING YOUR MICROWAVE OVEN.....</b>	<b>11-19</b>	Combination Cooking Guide .....	27
Clock/Child Lock/Kitchen Timer .....	11	<b>HEATING/REHEATING GUIDE.....</b>	<b>28</b>
Option/Option Table/Timed Cooking/Add Minute..	12	<b>FRESH VEGETABLE GUIDE.....</b>	<b>30</b>
Warm Hold/More and Less .....	13	<b>TROUBLESHOOTING.....</b>	<b>31-33</b>
Multistage Cooking/Microwave Power Levels.....	14	Questions and Answers .....	31-32
Sensor Cooking Operation Instruction .....	15	Before Calling for Service .....	33
Sensor Reheat/Sensor Reheat Table .....	15	<b>MASTER PROTECTION AGREEMENTS .....</b>	<b>66</b>

## WARRANTY

### One-Year Limited Warranty

When installed, operated and maintained according to all instructions supplied with the product, if this appliance fails due to a defect in material or workmanship within one year from the date of purchase, call 1-800-4-MY-HOME® to arrange for free repair.

### Five-Year Limited Warranty on the Magnetron

For five years from the date of purchase, if the magnetron in this microwave oven fails due to a defect in material or workmanship, Sears will replace the magnetron. Safety regulations require the magnetron to be installed by Sears. After the first year, the customer assumes any labor costs associated with magnetron replacement.

If this appliance is used for other than private family purposes, this warranty applies for only 90 days from the date of purchase.

### This warranty covers only defects in material and workmanship. Sears will NOT pay for:

1. Expendable items that can wear out from normal use, including but not limited to filters, belts, light bulbs, and bags.
2. A service technician to instruct the user in correct product installation, operation, or maintenance.
3. A service technician to clean or maintain this product.
4. Damage to or failure of this product if it is not installed, operated, or maintained according to all instructions supplied with the product.

5. Damage to or failure of this product resulting from accident, abuse, misuse, or use for other than its intended purpose.
6. Damage to or failure of this product caused by the use of detergents, cleaners, chemicals, or utensils other than those recommended in all instructions supplied with the product.
7. Damage to or failure of parts or systems resulting from unauthorized modifications made to this product.

### Disclaimer of implied warranties, limitation of remedies

Customer's sole and exclusive remedy under this limited warranty shall be product repair as provided herein. Implied warranties, including warranties of merchantability or fitness for a particular purpose, are limited to one year or the shortest period allowed by law. Sears shall not be liable for incidental or consequential damages. Some states and provinces do not allow the exclusion or limitation of incidental or consequential damages or limitations on the duration of implied warranties of merchantability or fitness, so these exclusions or limitations may not apply to you.

This warranty applies only while this appliance is used in the United States and Canada.

This warranty gives you specific legal rights, and you may also have other rights which vary from state to state.

**Sears, Roebuck and Co., Dept. 817WA, Hoffman Estates, IL 60179**  
**Sears Canada Inc., Toronto, Ontario, Canada M5B 2B8**

# SAFETY

## PRECAUTIONS TO AVOID POSSIBLE EXPOSURE TO EXCESSIVE MICROWAVE ENERGY

- DO NOT attempt to operate this oven with the door open, since open-door operation can result in harmful exposure to microwave energy. **It is important not to defeat or tamper with the safety interlocks.**
- DO NOT operate the oven if it is damaged. It is particularly important that the oven door close properly and that there is no damage to the:
  1. door (bent).
  2. hinges and latches (broken or loosened).
  3. door seals and sealing surfaces.
- DO NOT place any object between the oven front face and the door or allow soil or cleaner residue to accumulate on sealing surfaces.
- THE OVEN should not be adjusted or repaired by anyone except properly qualified service personnel.

## GROUNDING INSTRUCTIONS

This appliance must be grounded! If an electrical short circuit occurs, grounding reduces the risk of electric shock by providing an escape wire for the electric current. This appliance is equipped with a

cord having a grounding wire with a grounding plug. Put the plug into an outlet that is properly installed and grounded.

### WARNING

**If you use the grounding plug improperly, you risk electric shock.**

Ask a qualified electrician or the Sears Service Department if you do not understand the grounding instructions or if you wonder whether the appliance is properly grounded.

**If you use an extension cord, be sure that:**

- The extension cord has the same electrical rating as the appliance.
- The marked rating of the extension cord shall be equal to or greater than the electrical rating of the appliance.
- The extension cord is a grounding-type 3-wire cord.
- The extension cord does not drape over a countertop or tabletop, where it can be pulled on by children or tripped over accidentally.
- The electrical cord is dry and not pinched or crushed in any way.

**NOTE: This oven draws 13.0 amperes at 120 volts, 60 hz.**

# SAFETY

## IMPORTANT SAFETY INSTRUCTIONS

The safety instructions below will tell you how to use your microwave oven to avoid harm to yourself or damage to your oven.



**WARNING** – To reduce the risk of burns, electric shock, fire, injury to persons, or exposure to excessive microwave energy:

1. Read all the instructions before using your microwave oven.
2. Do not allow children to use this oven without close supervision!
3. Read and follow the specific **PRECAUTIONS TO AVOID POSSIBLE EXPOSURE TO EXCESSIVE MICROWAVE ENERGY** found on page 3.
4. Do not tamper with the built-in safety switches on the oven door! The oven has several built-in safety switches to make sure the power is off when the door is open.
5. When cleaning the door and the surfaces that touch the door, use only mild, nonabrasive soaps or detergents and a sponge or soft cloth.
6. If your oven is dropped or damaged, have it thoroughly checked by a qualified service technician before using it again.
7. To avoid a fire hazard:
  - a) Do not severely overcook foods. It can cause a fire in the oven.
  - b) Do not use recycled paper products in your oven. They can contain particles that can cause arcing or may ignite.
  - c) Do not overcook potatoes. Overcooking could cause a fire.
  - d) Do not store combustible items (bread, cookies, etc.) in the oven, because if lightning strikes the power lines, it may cause the oven to turn ON.
  - e) Do not use wire twist-ties in the oven. Be sure to remove them before placing the item in the oven.
  - f) Do not use the cavity for storage purposes. Do not leave paper products, cooking utensils, or food in the cavity when not in use.
8. If a fire should start:
  - a) Keep the oven door closed.
  - b) Turn the oven off.
  - c) Disconnect the power cord or shut off the power at the fuse or circuit breaker panel.
9. Do not use this oven for commercial purposes. This microwave is made for household use only.
10. Install or locate this appliance in accordance with the provided installation instructions.
11. To avoid electric shock:
  - a) This appliance must be grounded! Connect it only to a properly grounded outlet. (See the **Grounding Instructions** on page 3.)
  - b) Do not operate this appliance if it has a damaged cord or plug, if it is not working properly, or if it has been damaged or dropped.
  - c) Do not immerse the electrical cord or plug in water.
  - d) Keep the cord away from heated surfaces.
  - e) This appliance should be serviced only by qualified service personnel.
12. Liquids such as water, coffee, or tea are able to be overheated beyond the boiling point without appearing to be boiling due to surface tension of the liquid. Visible bubbling or boiling when the container is removed from the microwave oven is not always present. This could result in very hot liquids suddenly boiling over. When the container is disturbed or when a spoon or other utensil is inserted into the liquid. To reduce the risk of injury to persons:
  - 1) Do not overheat the liquid.
  - 2) Stir the liquid both before and halfway through heating it.
  - 3) Use extreme care when inserting a spoon or other utensil into the container once heating has begun.
  - 4) Do not use straight-sided containers with narrow necks.
  - 5) After heating, allow the container to stand in the microwave oven for a short time before removing the container.
13. Keep the glass tray and the turntable roller rest in the oven when you are cooking.
14. Do not use the oven outdoors. Do not store the oven outdoors. Do not use this product near water.
  - For example, near a kitchen sink, in a wet basement, near a swimming pool or similar location.
15. Do not cover or block any openings in the oven.
16. Do not run the microwave oven empty.
17. Do not let the cord hang over the edge of a table or counter.
18. Do not heat glass turntable excessively.
  - Do not cook bacon directly on the glass turntable.
  - Do not allow the gray film on special microwave cooking packages to touch the glass turntable. Put the package on a microwave-safe dish.
  - Keep a browning dish at least 3/16 in. (.5 cm) above the glass turntable. If you use the browning dish incorrectly, you could break the glass turntable.
19. Be careful not to chip or scratch the edges of the turntable. Chips or scratches may cause the turntable to break during use.
20. Some produce such as whole eggs and sealed containers, for example, closed glass jars, are able to explode and should not be heated in this oven.

**SAVE THESE INSTRUCTIONS!**

# UNDERSTANDING YOUR MICROWAVE OVEN

## SPECIFICATIONS

Power Supply		120 VAC, 60 Hz
Rated Power Consumption	Microwave	1,500 W
	Convection	1,500 W
Power Output	Microwave	1,000 W*
	Convection	1,500 W
Frequency		2,450 MHz
Rated Current	Microwave	13 A
	Convection	13 A
Overall Dimensions (W x H x D)		22 <sup>5</sup> / <sub>8</sub> " x 14 <sup>7</sup> / <sub>8</sub> " x 20" (57 x 38 x 51 cm)
Oven Cavity Dimensions (W x H x D)		15 <sup>1</sup> / <sub>4</sub> " x 10 <sup>7</sup> / <sub>8</sub> " x 15 <sup>1</sup> / <sub>4</sub> " (39 x 28 x 39 cm)
Capacity of Oven Cavity		1.5 Cu. Ft.

\*IEC 60705 RATING STANDARD

Specifications subject to change without prior notice.

## INSTALLATION

### A. Circuits

For safety purposes this oven must be plugged into a 20-amp circuit. No other electrical appliances or lighting circuits should be on this line. If in doubt, consult a licensed electrician.

### B. Voltage Warning

The voltage used at the wall receptacle must be the same as specified on the oven nameplate located on the front or on the side of the control panel of the oven. Use of a higher voltage is dangerous and may result in a fire or other type of accident causing oven damage. Low voltage will cause slow cooking. In case your microwave oven does not perform normally in spite of proper voltage, remove and reinsert the plug.

### C. Placement of the Oven

Your microwave oven can be placed easily in your kitchen, family room, or anywhere else in your home. Place the oven on a flat surface such as a kitchen countertop or a specially designed microwave oven cart at least 39.4 in. (100 cm) from floor. Do not place oven above a gas or electric range. Free airflow around the oven is important. Allow at least 4 in. (10 cm) of space at the top, sides, and back of the oven for proper ventilation.

#### NOTES:

- Never place the turntable in the oven upside down.

### D. Do Not Block the Air Vents

All air vents should be kept clear during cooking. If air vents are covered during oven operation, the oven may overheat. In this case, a sensitive thermal safety device automatically turns the oven off. The oven will be inoperable until it has cooled sufficiently.

### E. Electronic Interference

1. Microwave oven operation may interfere with TV, phone, or radio reception.
2. When there is interference, it may be reduced or eliminated by taking the following measures:
  - a. Clean the door and the sealing surfaces of the oven.
  - b. Reorient the receiving antenna of radio or TV.
  - c. Relocate the microwave oven in relation to the TV, phone, or radio.
  - d. Move the microwave oven away from the receiver.
  - e. Plug the microwave oven into a different outlet so the microwave oven and receiver are on different branch circuits.

# UNDERSTANDING YOUR MICROWAVE OVEN

## PARTS AND ACCESSORIES

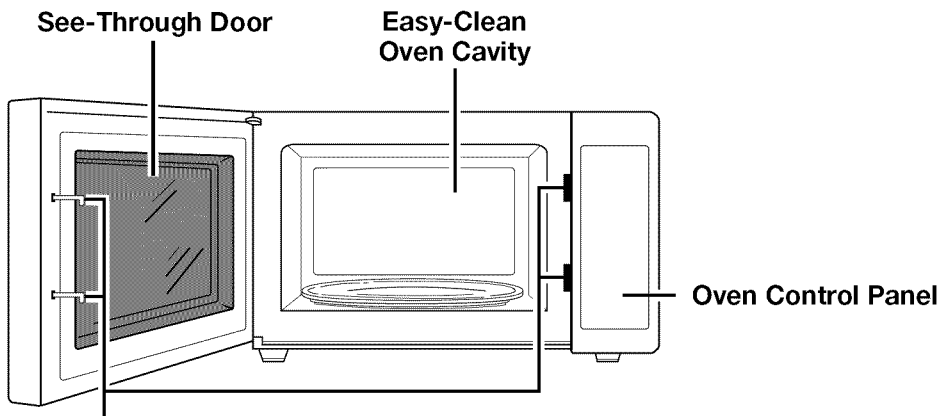

### Safety Interlock System

Your oven comes with the following accessories:

- 1 Use and Care Guide
- 1 Glass Turntable
- 1 Turntable Roller Rest
- 1 Metal Rack

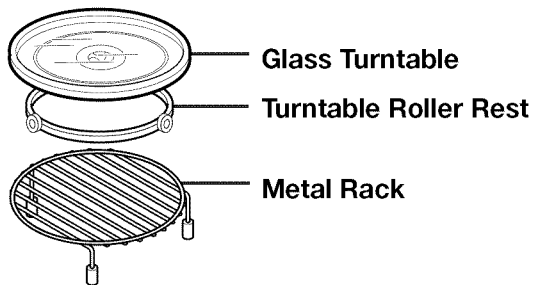

# UNDERSTANDING YOUR MICROWAVE OVEN

## CONTROL PANEL FEATURES

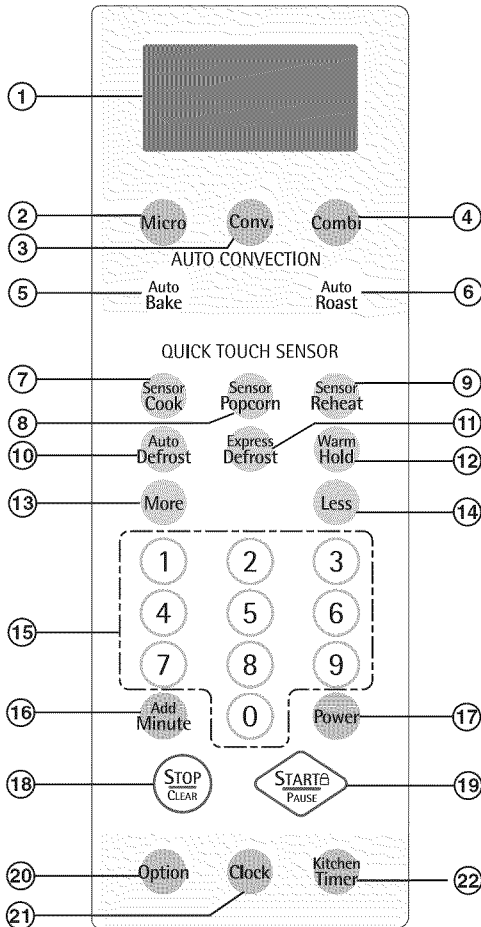

1. **DISPLAY.** The Display includes a clock and indicators to tell you time of day, cooking time settings, and cooking functions selected.
2. **MICRO.** Touch this pad when setting microwave cooking.
3. **CONV.** Touch this pad to operate the oven for convection cooking only.
4. **COMBI.** Touch this pad to program the amount of roasting time and heat for a cooking cycle using both microwave energy and convection energy.
5. **CONVECTION AUTO BAKE.** Touch this pad to automatically bake frozen pizza, muffins, biscuits, and frozen French fries using both microwave and convection energy alternately.
6. **CONVECTION AUTO ROAST.** Touch this pad to automatically roast beef, chicken, turkey breasts, and pork using both microwave and convection energy alternately.

7. **SENSOR COOK.** Touch this pad to cook 10 types of foods. The oven sensor will tell the oven how long to cook depending on the amount of steam coming from the food.
8. **SENSOR POPCORN.** Touch this pad when popping commercially packaged popcorn in your microwave oven. The oven sensor will tell the oven how long to cook depending on the amount of steam it detects from the popcorn.
9. **SENSOR REHEAT.** Touch this pad to reheat precooked, room-temperature, or refrigerated foods. The oven sensor will tell the oven how long to cook depending on the amount of steam coming from the food.
10. **AUTO DEFROST.** Touch this pad once to automatically defrost meat, poultry, fish, or bread according to weight. Touch this pad twice to defrost most other frozen foods by time.
11. **EXPRESS DEFROST.** Touch this pad for rapid defrosting of one pound of frozen food.
12. **WARM HOLD.** Touch this pad to keep hot, cooked foods warm in your microwave oven.
13. **MORE.** Touch this pad to add 10 seconds of cooking time each time it is pressed.
14. **LESS.** Touch this pad to subtract ten seconds of cooking time each time it is pressed.
15. **NUMBER.** Touch number pads to enter cooking times, cook powers, quantities, weights, or food categories.
16. **ADD MINUTE.** Touch this pad to set and start cooking at 100% power.
17. **POWER.** Touch this pad to select a cooking power level.
18. **STOP/CLEAR.** Touch this pad to cancel a currently running program or erase a cooking cycle being programmed.
19. **START/PAUSE.** Touch this pad to start a program or to pause the oven during cooking or defrosting. Press and hold for child lock.
20. **OPTION.** Touch this pad to change the oven's default settings for volume, clock, scroll speed, units of weight, and language.
21. **CLOCK.** Touch this pad to enter the time of day.
22. **KITCHEN TIMER.** Touch this pad to set the kitchen timer.

# UNDERSTANDING YOUR MICROWAVE OVEN

## COOKING COMPARISON GUIDE

Cooking with your new oven offers a wide variety of food preparation options: microwave cooking, convection cooking, and combination cooking.

**Microwave cooking** uses very short, high-frequency radio waves. The movement of the microwaves through the food generates heat and cooks most foods faster than regular methods, while retaining their natural texture and moisture. Microwave cooking heats food directly, not the cookware or the interior of the oven. Reheating is easy and defrosting is particularly convenient because less time is spent in food preparation.

**Convection cooking** constantly circulates heated air around the food, creating even browning and sealed-in flavor by the constant motion of hot air over the food surfaces.

**Combination cooking** combines microwave energy with convection to cook with speed and accuracy, while browning and crisping to perfection.

You can use microwave cooking, convection cooking, or combination cooking to cook by time. Simply preset the length of cooking time desired and your oven turns off automatically.

The following guide shows at a glance the difference between microwave, convection, and combination cooking.

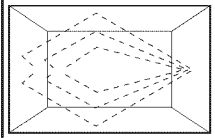
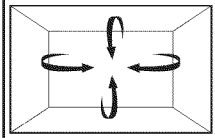
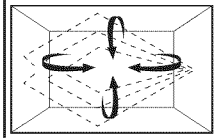
	MICROWAVE	CONVECTION	COMBINATION
<b>COOKING METHOD</b>	 <p>Microwave energy is distributed evenly throughout the oven for fast, thorough cooking of food.</p>	 <p>Hot air circulates around food to produce browned exteriors and sealed-in juices.</p>	 <p>Microwave energy and convection heat combine to shorten the cooking time of regular ovens, while browning and sealing in juices.</p>
<b>HEAT SOURCE</b>	Microwave energy.	Circulating heated air.	Microwave energy and circulating heated air.
<b>BENEFITS</b>	<ul style="list-style-type: none"> <li>• Fast, high-efficiency cooking.</li> <li>• Oven and surroundings do not get hot.</li> <li>• Easy clean-up.</li> </ul>	<ul style="list-style-type: none"> <li>• Aids in browning and seals in flavor.</li> <li>• Cooks some foods faster than regular ovens.</li> </ul>	<ul style="list-style-type: none"> <li>• Shortened cooking time from microwave energy.</li> <li>• Browning and crisping from convection heat.</li> </ul>
<p>Read this guide to learn the many different things your Microwave/Convection/Combination Oven can do. You will find a wide variety of cooking methods and programs designed to suit your lifestyle.</p>			



# UNDERSTANDING YOUR MICROWAVE OVEN

## COOKWARE GUIDE

### Microwave Cooking

Most heat-resistant, nonmetallic cookware is safe for use in your microwave oven.

However, to test cookware before using, follow these steps:

1. Place the empty cookware in the microwave oven.
2. Measure 1 cup (250 ml) of water in a glass measuring cup and place it in the oven beside the cookware.
3. Microwave on 100% power for 1 minute. If the dish is warm, it **should not** be used for microwave cooking.

### Convection Cooking

- Metal pans are recommended for all types of baked products, but especially where browning or crusting is important.
- Dark or dull-finish metal pans are best for breads and pies because they absorb heat and produce a crisper crust.

- Shiny aluminum pans are better for cakes, cookies, or muffins because these pans reflect heat and help produce a light, tender crust.
- Glass or glass-ceramic casserole or baking dishes are best suited for egg and cheese recipes due to the cleanability of glass.

### Combination Cooking

- Glass or glass-ceramic baking containers are recommended. Do not use items with metal trim as it may cause arcing (sparking) with oven wall or oven rack, damaging the cookware, the rack, or the oven.
- Heat-resistant plastic microwave cookware (safe to 450°F (230°C) may be used, but is not recommended for foods that require crusting or all-around browning, because plastic is a poor conductor of heat.

COOKWARE	MICROWAVE	CONVECTION	COMBINATION
Heat-Resistant Glass, Ceramic-Glass	Yes	Yes	Yes
Ceramics, China	Yes (Do not use china with gold or silver trim.)	Yes	Yes
Metal Cookware	No	Yes	No
Non-Heat-Resistant Glass	No	No	No
Microwave-Safe Plastic	Yes	No	Yes*
Plastic Wrap, Wax Paper	Yes	No	No
Paper Products	Yes	No	No
Straw, Wicker, and Wood	Yes	No	No

\*Use only microwave cookware that is safe to 450°F (230°C)

## HOW TO USE ACCESSORIES

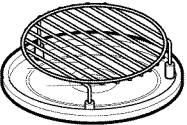
	MICROWAVE	CONVECTION	COMBINATION
 <p>Metal Rack Glass Turntable</p>	X	○	○

# UNDERSTANDING YOUR MICROWAVE OVEN

## TIPS FOR MICROWAVE COOKING

### BROWNING

Meat and poultry with high fat content that are cooked for 10 or 15 minutes or longer will brown lightly. Foods cooked a shorter time can be brushed with a browning agent, such as Worcestershire sauce, soy sauce, or barbecue sauce.

### COVERING

A cover traps heat and steam and causes the food to cook more quickly. Use a lid or microwave-safe plastic wrap with one corner folded back to vent the excess steam. Lids on glass casseroles can become hot during cooking. Handle carefully. Waxed paper will prevent the food from splattering in the oven and help retain heat. When warming bread items, use waxed paper, napkins, or paper towels. To absorb extra moisture, wrap sandwiches and fatty foods in paper towels.

### SPACING

Arrange individual foods, such as baked potatoes, cupcakes, and hors d'oeuvres in a circle and at least 1 in. (2.5 cm) apart. This will help the food cook more evenly.

### STIRRING

Stirring blends flavors and redistributes the heat in foods. Always stir from the outside toward the center of the dish. Food at the outside of the dish heats first.

### TURNING

Large foods, such as roasts and whole poultry, should be turned so that the top and bottom cook evenly. Also turn over chicken pieces and chops.

## CLEANING

Wipe the oven inside and outside with a soft cloth and a mild detergent solution. Then rinse and wipe dry. This should be done weekly or more often, if needed. Never use cleaning powders or rough pads.

Excessive oil splatters on the inside top will be difficult to remove if left for many days. Wipe splatters with a wet paper towel, especially after cooking chicken or bacon.

### REMOVABLE PARTS

The metal rack, glass turntable and turntable roller rest are removable. They should be hand-washed in warm (not hot) water with a mild detergent and a soft cloth. Once they are clean, rinse well and dry with a soft cloth. Never use cleaning powders, steel wool, or rough pads.

### ARRANGEMENT

Do not stack food. Arrange in a single layer in the dish for more even cooking. Because dense foods cook more slowly, place thicker portions of meat, poultry, fish, and vegetables toward the outside of the dish.

### TESTING FOR DONENESS

Because foods cook quickly in a microwave oven, you need to test frequently for doneness.

### STANDING TIME

Depending on density, food often needs to stand from 2 to 15 minutes either in or outside of the oven after cooking power shuts off. Outside of the oven, you usually need to cover food during standing time to retain heat. Remove most foods when they are slightly undercooked and they will finish cooking during standing time. The internal temperature of food will rise about 10°F (6°C) during standing time.

### SHIELDING

To prevent some portions of rectangular or square dishes from overcooking, you may need to shield them with small strips of aluminum foil to block the microwaves. You can also cover poultry legs and wing tips with foil to keep them from overcooking. **Always keep foil at least 1 in. (2.5 cm) from the oven walls** to prevent arcing.

### PIERCING

Pierce the shell, skin, or membrane of foods before cooking to prevent them from bursting. Foods that require piercing include yolks and whites of eggs, hot dogs, clams, oysters, and whole vegetables, such as potatoes and squash.

- Removable parts may be cleaned at the sink. Be careful not to chip or scratch the edges as this may cause them to break during use.
- The glass turntable may also be cleaned in a dishwasher.
- The turntable roller rest should be cleaned regularly.

### SPECIAL CARE

For best performance and safety, the inner door panel and the oven front frame should be free of food or grease buildup. Wipe often with a mild detergent; then rinse and wipe dry. Never use cleaning powders or rough pads.





After cleaning the control panel, touch STOP/CLEAR to clear any entries that might have been entered accidentally while cleaning the panel.

# USING YOUR MICROWAVE OVEN

## CLOCK

When the oven is first plugged into a power outlet, the "Please set clock" prompt will flash several times until the clock is set.

**Example: To set the clock for 10:30.**





Touch:	Display Shows:
1. 	
2. 	ENTER TIME OF DAY
3. 	10:30 TOUCH START
4. 	10:30

**NOTE:** Please unplug and plug in to reset the clock.

## KITCHEN TIMER

Your microwave oven can be used as a kitchen timer. You can set up to 99 minutes, 99 seconds.

**Example: To set 3 minutes.**



Touch:	Display Shows:
1. 	Time of day
2. 	ENTER TIME IN MIN AND SEC
3. 	3:00 TOUCH TIMER
4. 	Timer and time counting down

**NOTE:** To cancel, press Kitchen Timer.

## CHILD LOCK

Use this safety feature to lock the control panel when you are cleaning the oven, or so that children cannot use the oven unsupervised.

**Example: To set Child Lock.**

Touch:	Display Shows:
1. 	Time of day
2.  Touch and hold until "LOCKED" appears (approximately 4 seconds).	LOCKED





**Example: To cancel CHILD LOCK.**

Touch:	Display Shows:
1.  Touch and hold until "LOCKED" disappears (approximately 4 seconds).	Time of day

# USING YOUR MICROWAVE OVEN

## OPTION

**Example: To change defrost weight mode (from lbs. to kg).**

Touch:	Display Shows:
1. 	Time of day
2. 	SOUND TOUCH 1 CLOCK TOUCH 2 SCROLL SPEED TOUCH 3 LBS F / KG C TOUCH 4 DEMO TOUCH 5 LANGUAGE TOUCH 6
3. 	LBS F TOUCH 1 KG C TOUCH 2
4. 	KG C

You can change the default values for beep sound, clock, scroll speed, units, demo, and language. See the following table for more information.

## OPTION TABLE







Function	Pad	Option
Sound	1	Mute, low, medium, loud
Clock	2	On or off
Scroll Speed	3	Slow, normal, or fast
Units	4	Lbs, °F or Kg, °C
Demo	5	On or off
Language	6	English or Spanish

## TIMED COOKING

This feature lets you program a specific cook time and power. For best results, there are 10 power level settings in addition to HIGH (100%) power. Refer to the "Microwave Power Levels Table" on page 14 for more information.

**NOTE:** If you do not select a power level, the oven will automatically cook at 100% power.



**Example: Timed Cooking for 2 minutes.**

Touch:	Display Shows:
1. 	ENTER COOKING TIME
2.   	2:00 TOUCH START OR POWER
3. 	2:00 ENTER POWER LEVEL 1 - 10
4. 	2:00 P - 80 TOUCH START
5. 	COOK 80 Time counting down

## ADD MINUTE

A time-saving pad, this simplified control lets you quickly set and start microwave cooking at 100% power without the need to touch START.

**Example: To cook for 2 minutes.**

Touch:	Display Shows:
1. 	Time of day
2.  Twice	Time counting down and POWER 100



**NOTE:** If you touch ADD MINUTE, it will add 1 minute up to 99 minutes 59 seconds. This feature is also ideal for a 1-minute quick-start.

# USING YOUR MICROWAVE OVEN

## WARM HOLD

You can safely keep hot, cooked food warm in your microwave oven for up to 99 minutes. You can use WARM HOLD by itself or to automatically follow a cooking cycle.

**Example: Warm Hold.**

Touch:	Display Shows:
1. 	Time of day
2. 	TOUCH START
3. 	WARM

At the end of the Warm Hold, "END" will be displayed and four tones will sound.

**NOTE:** To end, hit STOP/CLEAR.

## MORE and LESS

More

Less

The MORE and LESS functions of this oven adjust the cooking cycle's cook time while the microwave is running. **MORE** adds 10 seconds to the cook time; **LESS** subtracts 10 seconds.

- Use MORE or LESS when cooking time is counting down in the display. MORE and LESS cannot be set when "SENSING" is displayed.
- MORE and LESS do not adjust cook time for the DEFROST and WARM/HOLD cooking cycles.
- Press **MORE** or **LESS** pads during active cooking cycle.
- For convection cooking, MORE or LESS are used as temperature selection pads.

**To make WARM HOLD automatically follow another cycle:**

- **While you are entering cooking instructions, touch WARM HOLD** before touching START.
- **When the last cooking cycle is over, you will hear two tones.** "Warm" will come on while the oven continues to run.
- You can set WARM HOLD to follow AUTO DEFROST, CONV., or multi-stage cooking.

### NOTES:













- **WARM HOLD** operates for up to 99 minutes.
- **Opening** the oven door cancels WARM HOLD. Close the door and touch WARM HOLD, then touch START if additional Warm Hold time is desired.
- **Food cooked covered** should be covered during WARM HOLD.
- **Pastry items** (pies, turnovers, etc.) should be uncovered during WARM HOLD.
- **Complete meals** kept warm on a dinner plate should be covered during WARM HOLD.
- **Do not use** more than one complete WARM HOLD cycle. The quality of some foods will suffer with extended time.

# USING YOUR MICROWAVE OVEN

## MULTISTAGE COOKING

For best results, some recipes call for different cook powers during different stages of a cook cycle. You can program your oven to switch from one power level to another for up to 2 stages.

**Example: 2-stage cook cycle.**

Touch:	Display Shows:
1. 	ENTER COOKING TIME
2.    to set a 3-minute cook time for the first stage.	3 : 00 TOUCH START OR POWER
3. 	3 : 00 ENTER POWER LEVEL 1 - 10
4.  to set an 80% cook power for the first stage.	3 : 00 P - 80 TOUCH START
5. 	ENTER COOKING TIME
6.    to set a 7-minute cook time for the second stage.	7 : 00 TOUCH START OR POWER
7. 	7 : 00 ENTER POWER LEVEL 1 - 10
8.  to set a 50% cook power for the second stage.	7 : 00 P - 50 TOUCH START
9. 	COOK 80 Time counting down
10. When the first stage is over, you will hear two short tones as the oven begins the second cook stage.	

## MICROWAVE POWER LEVELS

Your microwave oven has 10 cook power levels to let you cook or heat a wide variety of foods. Refer to the table below for suggestions:

### Microwave Power Level Table

Power Level	Use
10 (High)	<ul style="list-style-type: none"> <li>• Boiling water.</li> <li>• Making candy.</li> <li>• Cooking poultry pieces, fish, and vegetables.</li> <li>• Cooking tender cuts of meat.</li> <li>• Whole poultry.</li> </ul>
9	<ul style="list-style-type: none"> <li>• Reheating rice, pasta, and vegetables.</li> </ul>
8	<ul style="list-style-type: none"> <li>• Reheating prepared foods quickly.</li> <li>• Reheating sandwiches.</li> </ul>
7	<ul style="list-style-type: none"> <li>• Cooking egg, milk, and cheese dishes.</li> <li>• Cooking cakes, breads.</li> <li>• Melting chocolate.</li> </ul>
6	<ul style="list-style-type: none"> <li>• Cooking veal.</li> <li>• Cooking whole fish.</li> <li>• Cooking puddings and custard.</li> </ul>
5	<ul style="list-style-type: none"> <li>• Cooking ham, whole poultry, and lamb.</li> <li>• Cooking rib roast, sirloin tip.</li> </ul>
4	<ul style="list-style-type: none"> <li>• Thawing meat, poultry, and seafood.</li> </ul>
3	<ul style="list-style-type: none"> <li>• Cooking less tender cuts of meat.</li> <li>• Cooking pork chops, roast.</li> </ul>
2	<ul style="list-style-type: none"> <li>• Taking chill out of fruit.</li> <li>• Softening butter.</li> </ul>
1	<ul style="list-style-type: none"> <li>• Keeping casseroles and main dishes warm.</li> <li>• Cream cheese.</li> </ul>
0	<ul style="list-style-type: none"> <li>• Standing time.</li> </ul>

# USING YOUR MICROWAVE OVEN

## SENSOR COOKING OPERATION INSTRUCTION

A sensor detects steam from the food and automatically adjusts cook time for the best cooking results. It's easy and convenient—the oven will guide you, step-by-step, to cook or reheat foods. The Sensor Menu, with many popular food choices, is preprogrammed to cook or reheat food perfectly every time.

For more information about Sensor Cooking Programs, see the sensor reheat and cook tables on pages 15 and 17. These tables provide specific instructions for cooking and heating a variety of foods.

- The Sensor Cooking system works by detecting a buildup of vapor.
- Make sure the door remains closed.
- Once the vapor is detected, two beeps will sound.
- Opening the door or touching the STOP/CLEAR before the vapor is detected will abort the process. The oven will stop.
- Before using Sensor Cooking, make sure the glass turntable is dry, to ensure the best results.



### Categories:

Sensor Reheat  
Sensor Popcorn  
Sensor Cook

## SENSOR REHEAT

This feature allows you to reheat precooked room-temperature or refrigerated foods without selecting cooking times and power levels. This feature has 3 categories: Dinner Plate, Soup/Sauce, and Casserole. See the following table for more information.

**Example : To reheat casserole.**

Touch:	Display Shows:
1. 	Time of day
2. 	SELECT MENU 1-3
3. 	CASSEROLE ↓ SENSING

The oven will reheat food automatically by sensor system.

## SENSOR REHEAT TABLE

	Food	Serving Amount and Recommendations
1	Dinner Plate	Serving size is about 8 to 16 oz (225 to 450 g). Place food to be heated on a dinner plate or similar dish. Cover with plastic wrap and vent*.
2	Soup/ Sauce	Serving size is 1 to 4 cups (250 ml to 1 l). Place food to be heated in a casserole dish. Cover with plastic wrap and vent*.
3	Casserole	Serving size is 1 to 4 cups (250 ml to 1 l). Place food to be heated in a casserole dish. Cover with plastic wrap and vent*.

\*Fold back one corner of the plastic wrap to vent excess steam.

# USING YOUR MICROWAVE OVEN

## SENSOR POPCORN



SENSOR POPCORN lets you pop commercially packaged microwave popcorn (1.75 or 3.5 oz. [50 or 99 g]).

**For best results:**

- Use fresh popcorn.
- Place only one bag of prepackaged microwave popcorn on the center of turntable.

**Example : To pop 3.5 oz. (100 g).**

**Touch:**

1. 
2. 

**Display Shows:**

Time of day  
  
POPCORN  
↓  
SENSING

**NOTES:**



- Do not attempt to reheat or cook any unpopped kernels.
- Do not use popcorn-popping devices in the microwave oven with this feature.
- UNDER NO CIRCUMSTANCES should you use a popper that concentrates the microwave energy.

## SENSOR COOK

SENSOR COOK allows you to cook most of your favorite foods without having to select cooking times and power levels. The oven automatically determines required cooking times for each food item. SENSOR COOK has 10 food categories (see the table on the following page).

**Example: To cook a frozen entrée.**

**Touch:**

1. 
2. 
3. 

**Display Shows:**

Time of day  
  
SELECT MENU 0-9  
  
FROZEN ENTREE  
↓  
SENSING

The oven will cook food automatically by sensor system.



# USING YOUR MICROWAVE OVEN

## SENSOR COOK TABLE

	Food	Serving Amount and Recommendations
1	Potato	Serving size is 1 to 4 medium sized potatoes, about 8 to 10 oz. (225 to 280 g) each. Pierce each potato several times with a fork and place around the edge of the oven tray, at least 1 in. (2.5 cm) apart.
2	Fresh Vegetable	Serving size is 1 to 4 cups (250 ml to 1 l). Place moist vegetables in a microwavable container. Add 2 to 4 tablespoons (30 to 60 ml) water. Cover with plastic wrap and vent*. Most vegetables need stirring and 2 to 3 minutes standing time after cooking.
3	Frozen Vegetable	Serving size is 1 to 4 cups (250 ml to 1 l). Remove from package and place vegetables in a microwavable container. Add 2 to 4 tablespoons (30 to 60 ml) water. Cover with plastic wrap and vent*. Most vegetables need stirring and 2 to 3 minutes standing time after cooking.
4	Frozen Entrée	Entrée size is 10 to 20 oz. (285 to 560 g). Remove from outer package. Loosen cover on three sides. If entrée is not in a microwave-safe container, place it on a plate, cover with plastic wrap, and vent*. Most entrées need 2 to 3 minutes standing time after cooking.
5	Rice	Follow package instructions for ingredient amounts. Place rice and liquid (water, chicken, or vegetable stock) in a microwave-safe container, cover with casserole lid or plastic wrap and vent*. Most rice needs 2 to 3 minutes standing time after cooking.
6	Casserole	Serving size is 1 to 4 cups (250 ml to 1 l). Combine the ingredients per the recipe in a 1- to 2-quart (1- to 2-l) casserole dish. Cover with plastic wrap and vent*. After cooking is complete, allow 3 minutes standing time.
7	Ground Meat	Serving size is 4 to 32 oz. (1/4 to 2 lbs.) (115 to 900 g). Crumble meat into a microwave-safe container. Season and cover with plastic wrap. Vent cover for well-done meat. Cover dish for medium cooked meat (such as meat to be used in another dish and cooked further).
8	Fish/Seafood	Serving size is 4 to 32 oz. (1/4 to 2 lbs.) (115 to 900 g). Place the food around the sides of a microwave-safe container. Season and add 1/4 to 1/2 cup (60 to 125 ml) liquid (wine, water, salsa, etc.) if desired. Cover with plastic wrap and vent*.
9	Scrambled Eggs	Serving size is 2 to 5 eggs. Break eggs into a 4-cup (1 l) measuring cup or 1-quart (1 l) casserole dish. Add 1 tablespoon (15 ml) milk or water per egg and beat. Cover with plastic wrap and vent*. When cooking is complete, remove from oven, stir, and allow 1 to 2 minutes standing time.
0	Frozen Pizza	Serving size is 1 or 2 pieces. Use only frozen pizza intended for microwave use. Do not cover. Follow package directions.

\*Fold back one corner of the plastic wrap to vent excess steam.

# USING YOUR MICROWAVE OVEN







## AUTO DEFROST

Four defrost choices are preset in the oven. The defrost feature provides you with the best defrosting method for frozen foods, because the oven automatically sets the defrosting times for each food item according to the weight you enter. For added convenience, the AUTO DEFROST includes a built-in tone mechanism that reminds you to check, turn over, separate, or rearrange the food during the defrost cycle. Four different defrosting options are provided.

1. **MEAT**
2. **POULTRY**
3. **FISH**
4. **BREAD**

After touching the AUTO DEFROST pad once, select the food category by touching number pad 1 (Meat), 2 (Poultry), 3 (Fish), or 4 (Bread). Available weight ranges for Meat, Poultry, and Fish are 0.1 to 6.0 lbs. (.05 to 2.7 kg). The available weight range for Bread is 0.1 to 1.0 lb. (.05 to 2.7 kg).

**Example: To defrost 1.2 lbs. (0.5 kg) of meat.**

Touch:	Display Shows:
1. 	Time of day
2. 	MEAT TOUCH 1 POULTRY TOUCH 2 FISH TOUCH 3 BREAD TOUCH 4
3. 	ENTER WEIGHT
4.  and  to enter the weight	1.2 LBS TOUCH START
5. 	MEAT Time counting down

**NOTE:**

When you touch the START/PAUSE pad, the display changes to defrost time countdown. The oven will beep during the DEFROST cycle. At this time, open the door and turn, separate, or rearrange the food. Remove any portions that have thawed. Return frozen portions to the oven and touch START/PAUSE to resume the defrost cycle. **The oven will not CLEAR during the BEEP unless the door is opened.**

**For best results:**

- Remove fish, shellfish, meat, and poultry from its original closed paper or plastic package (wrapper). Otherwise, the wrap will hold steam and juice close to the foods, which can cause the outer surface of the foods to cook.
- Form the meat into the shape of a doughnut before freezing. When defrosting, scrape off thawed meat when the beep sounds and continue defrosting.
- Place foods in a shallow glass baking dish or on a microwave roasting rack to catch drippings.
- Foods should still be somewhat icy in the center when removed from the oven.



## AUTO DEFROST TABLE

Category	Food
<b>MEAT</b> 0.1 to 6.0 lbs. (.05 to 2.7 kg)	<b>BEEF</b> Ground beef, round steak, cubes for stew, tenderloin steak, pot roast, rib roast, rump roast, chuck roast, hamburger patty <b>LAMB</b> Chops (1-in. [2.5-cm] thick), rolled roast <b>PORK</b> Chops (1/2-in. [1-cm] thick), hot dogs, spareribs, country-style ribs, rolled roast, sausage <b>VEAL</b> Cutlets (1 lb. (0.5 kg), 1/2-in. [1-cm] thick).
<b>POULTRY</b> 0.1 to 6.0 lbs. (.05 to 2.7 kg)	<b>POULTRY</b> Whole (under 4 lbs. [1.8 kg]), pieces, breasts (boneless) <b>CORNISH HENS</b> Whole <b>TURKEY</b> Breast (under 6 lbs. [2.7 kg])
<b>FISH</b> 0.1 to 6.0 lbs. (.05 to 2.7 kg)	<b>FISH</b> Fillets, whole steaks <b>SHELLFISH</b> Crab meat, lobster tails, shrimp, scallops
<b>BREAD</b> 0.1 to 1.0 lbs. (.05 to 2.7 kg)	<b>MUFFINS</b> <b>ROLL CAKE</b>

# USING YOUR MICROWAVE OVEN

## TIME DEFROST



Example: To defrost for 3 minutes.

- | Touch:   | Display Shows:             |
|--|----------------------------|
| 1.  twice | ENTER DEFROST TIME         |
| 2.        | 3:00<br>TOUCH START        |
| 3.        | TIME<br>Time counting down |

At the end of the defrost time, tones sound and oven turns off.

## EXPRESS DEFROST

Example: 1 lb. (0.5 kg) of meat.

- | Touch:   | Display Shows:                                  |
|--|---|
| 1.  | MEAT TOUCH 1<br>POULTRY TOUCH 2<br>FISH TOUCH 3 |
| 2.  | TOUCH START                                     |
| 3.  | QUICK<br>Time counting down                     |

At the end of the defrost time, tones sound and oven turns off.

### NOTE:

- The oven beeps approximately midway through a defrost cycle to remind you to check the food. Pause the oven by opening the door. Once food has been checked or rearranged, close door and press START/PAUSE to resume the defrost cycle.

# USING YOUR CONVECTION OVEN

## TIPS FOR CONVECTION COOKING

This section gives you cooking instructions and procedures for operating each convection function. Please read these instructions carefully.

Convection cooking circulates hot air through the oven cavity with a fan. The constantly moving air surrounds the food to heat the outer portion quickly, creating even browning and sealed-in flavor by the constant motion of hot air over the food surfaces. Your oven uses convection cooking whenever you use the Convection button. **DO NOT USE THE OVEN WITHOUT THE TURNTABLE IN PLACE.**

1. **Always use the metal rack** on the turntable when convection cooking.
2. **Do not cover** the turntable or metal rack with aluminum foil. It interferes with the flow of air that cooks the food.
3. **Round pizza pans** are excellent cooking utensils for many convection-only items. Choose pans that do not have extended handles.
4. **Use convection cooking** for items like soufflés, breads, cookies, angel food cakes, pizza, and for some meat and fish cooking.
5. **Your oven comes** equipped with a metal tray which can be used for cooking in convection mode or combination mode.
6. **You do not need to use** any special techniques to adapt your favorite oven recipes to convection cooking; however, in general you need to lower the oven temperature by 25°F (14°C) from the recommended temperature mentioned in package instructions when cooking packaged food in convection mode.
7. **When baking** cakes, cookies, breads, rolls, or other baked foods, most recipes call for preheating. Preheat the empty oven just as you do a regular oven. You can start heavier, dense foods such as meats, casseroles, and poultry without preheating.
8. **All heatproof** cookware or metal utensils can be used in convection cooking.
9. **As in conventional cooking**, the distance of the food from the heat source affects cooking results. Refer to the tables in this Use and Care Guide.
10. **Use metal utensils** only for convection cooking. Never use for microwave or combination cooking since arcing and damage to the oven may occur.
11. **After preheating**, if you do not open the door, the oven will automatically hold at the preheated temperature for 30 minutes.

## PRECAUTIONS

- The oven cavity, door, turntable, roller rest, metal tray, metal rack, and cooking utensils will become very hot.

USE THICK OVEN GLOVES when removing the food, cooking utensils, metal rack, metal tray, and turntable from the oven after convection cooking.





- Do not use lightweight plastic containers, plastic wraps, or paper products during any convection cycle.

# USING YOUR CONVECTION OVEN

## AUTO BAKE

To automatically bake frozen pizza, muffins, biscuits and frozen French fries using both microwave and convection energy alternately:

**Example: To bake 6 muffins.**

<b>Touch:</b>	<b>Display Shows:</b>
1. 	Time of day
2. 	FROZEN PIZZA TOUCH 1 MUFFINS TOUCH 2 BISCUIT/DINNER ROLL/B. STICK TOUCH 3 FROZEN FRENCH FRIES TOUCH 4
3. 	USE RACK AND 6 CUP MUFFIN PAN NO FOOD IN OVEN TOUCH START
Touch appropriate digit touch pad.	
<ul style="list-style-type: none"> <li>Muffins and biscuits require a preheat cycle and should be placed on the rack after the signal sounds.</li> <li>Frozen pizza <b>MUST</b> be placed directly on the convection cooking rack. <b>DO NOT</b> use a metal pizza tray or aluminum foil.</li> <li>Muffins, biscuits, and dinner rolls can use metal muffin tins if glass pan is not available.</li> <li>Breadsticks and frozen French fries can be placed on a small shallow metal pan, such as a tray, if a glass pan is not available.</li> </ul>	
4. 	PREHEAT
<ul style="list-style-type: none"> <li>If additional information is needed, oven will prompt in display.</li> </ul>	

At the end of the cooking time, tones sound, **END** displays, and the oven turns off.

## AUTO BAKE TABLE







Food	Serving Amount and Recommendations
<b>1. FROZEN PIZZA</b>	For best results, a pizza pan is not required. Use a 12-inch thin-crust frozen pizza. If baking a rising-crust pizza, add an additional 10 to 20 minutes' baking time on convection cook at 450°F (230°C). Place the frozen pizza directly on the short rack.
<b>2. MUFFINS</b>	Use 1 package of a muffin mix. Place the short rack on the turntable. After <b>PREHEAT</b> , use 6-cup muffin pan; place pan on rack.
<b>3. BISCUIT/DINNER ROLL/BREAD STICK</b>	For best results, bake one pan of biscuits, dinner rolls, or breadsticks at a time. After <b>PREHEAT</b> , place the biscuits 1–2 in. (2.5–5 cm) apart on a greased pizza pan or cookie sheet on the short rack. Cool on the rack for 10 minutes after cooking.
<b>4. FROZEN FRENCH FRIES</b>	Use frozen, prepared French fries. Do not overlap or layer potatoes. For crispier potatoes, use <b>MORE</b> to add additional cooking time. Spread the french fries on a pizza pan or cookie sheet. Place the pan on the short rack. After cooking, remove the pan from the oven. Weight range: 4 to 16 oz. (115 to 450 g).

# USING YOUR CONVECTION OVEN

## AUTO ROAST

Auto roast will automatically roast beef, whole chicken, turkey breasts, and pork using both microwave and convection energy alternately.

**Example: To roast a whole chicken (3 lbs. [1.5 kg]).**

Touch:	Display Shows:
1. 	Time of day
2. 	BEEF TOUCH 1 WHOLE CHICKEN TOUCH 2 TURKEY BREASTS TOUCH 3 PORK TOUCH 4
3. 	USE RACK ENTER 2.5 - 6 LBS
4.  	3.0 LBS TOUCH START
5. 	ROAST Time counting down

- If additional information is needed, the oven will prompt in the display.

At the end of the cooking time, tones sound, **END** displays, and the oven turns off.

## AUTO ROAST TABLE

Food	Serving Amount and Recommendations
<b>1. BEEF</b>	Weigh roast and pat dry with paper towels. Place a microwave-safe/heatproof plate on turntable to catch drippings. Place roast on short rack. After cooking, loosely tent roast beef with aluminum foil and let stand for 5 to 10 minutes. Weight range: 2 to 4 lbs. (1 to 2 kg)
<b>2. WHOLE CHICKEN</b>	Weigh whole chicken. Remove giblets and neck and discard. Thoroughly wash inside and outside of chicken with cold water. Pat chicken dry with paper towels. Secure the legs with kitchen twine. Brush outside of chicken with melted butter or margarine. Place a microwave-safe/heatproof plate on turntable to catch drippings. Place chicken breast side up on short rack. After cooking, loosely tent roast chicken with aluminum foil and let stand for 10 minutes. Weight range: 2.5 to 6 lbs. (1 to 3 kg)
<b>3. TURKEY BREASTS</b>	Weigh turkey breast and pat dry with paper towels. Brush turkey breast with melted butter. Place a microwave-safe/heatproof plate on turntable to catch drippings. Place turkey breast on short rack. After cooking, loosely tent roast turkey with aluminum foil and let stand for 5 to 10 minutes. Weight range: 3 to 6 lbs. (1 to 3 kg)
<b>4. PORK</b>	Weigh roast and pat dry with paper towels. Place a microwave-safe/heatproof plate on turntable to catch drippings. Place roast on short rack. After cooking, loosely tent roast with aluminum foil and let stand for 5 to 10 minutes. Weight range: 2 to 4 lbs. (1 to 2 kg)







# USING YOUR CONVECTION OVEN

## CONVECTION

During convection cooking, a heating element is used to raise the temperature of the air inside the oven. Convection cooking temperature ranges from 225°F (107°C) to 450°F (230°C); and 100°F (38°C) may be programmed.





It is best to preheat the oven when convection cooking.

**Example: To set the convection cooking at 325°F (160°C) for 45 minutes with preheating.**

Touch:	Display Shows:
1. 	Time of day
2. 	350 F TOUCH MORE OR LESS FOR TEMP SET OR START OR ENTER COOKING TIME
3. 	325 F TOUCH START FOR PREHEAT OR ENTER COOKING TIME
4. 	PREHEAT 325 F
<b>NOTES:</b>	
<ul style="list-style-type: none"> <li>• After preheating, display scrolls "PLACE FOOD ON RACK" with sound.</li> <li>• <b>Use thick oven gloves; oven interior will be hot.</b></li> <li>• Open the door, place food on the rack, and close the door. Display scrolls "ENTER COOKING TIME."</li> </ul>	
5. 	45:00 TOUCH START
6. 	CV 325 F Time counting down.

- NOTES:**
- When the oven reaches the set preheat temperature, five tones will sound and the oven will automatically hold that temperature for 30 minutes.
  - The oven temperature drops very quickly when the door is opened; however, this should not prevent food from being fully cooked during normal cooking time.

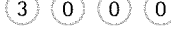
**Example: To set the convection cooking at 375°F (190°C) for 30 minutes without preheating.**

Touch:	Display Shows:
1. 	Time of day
2. 	350 F TOUCH MORE OR LESS FOR TEMP SET OR START OR ENTER COOKING TIME
3. 	375 F TOUCH START FOR PREHEAT OR ENTER COOKING TIME
4. 	30:00 TOUCH START
5. 	CV 375 F Time counting down.

- NOTES:**
- The temperature range has 10 steps from 225°F (107°C) to 450°F (230°C) including 100°F (38°C) (dough rising).
  - Use MORE/LESS to increase/decrease the temperature by 25°F (14°C) after touching the CONVECTION button. (The default temperature is 350°F [180°C].)

# USING YOUR CONVECTION OVEN

## CONVECTION COOKING Guide

1. Always use the metal rack when convection baking.
2. Aluminum pans conduct heat quickly. For most convection baking, light, shiny finishes give the best results because they prevent overbrowning in the time it takes to cook the center areas. Pans with dull (satin-finish) bottoms are recommended for cake pans and pie pans for best bottom browning.
3. Dark or nonshiny finishes, glass, and pyroceram absorb heat which may result in dry, crisp crusts.
4. Preheating the oven is recommended when baking foods by convection.
5. To prevent uneven heating and save energy, open the oven door to check food as little as possible.

FOOD		Oven Temp.	Time, Min.	Comments
<b>Breads</b>	Biscuits	400°F (200°C)	10 to 12	Canned refrigerated biscuits take 2 to 4 minutes less time.
	Corn Bread	400°F (200°C)	15 to 20	Remove from pans immediately and cool slightly on wire rack.
	Muffins	400°F (200°C)	18 to 24	
	Popovers	350°F (180°C)	30 to 40	Pierce each popover with a fork after removing from oven to allow steam to escape.
	Nut Bread or Fruit Bread	350°F (180°C)	55 to 65	Interiors will be moist and tender.
	Yeast Bread	375°F (190°C)	18 to 25	Lightly grease baking sheet.
	Plain or Sweet Rolls	350°F (180°C)	13 to 16	
<b>Cakes</b>	Angel Food	350°F (180°C)	40 to 50	Invert and cool in pan.
	Cheesecake	350°F (180°C)	60 to 65	After cooking, turn oven off and let cheesecake stand in oven 30 minutes with door ajar.
	Coffee Cake	350°F (180°C)	25 to 30	Interior will be moist and tender.
	Cupcakes	350°F (180°C)	15 to 20	
	Fruitcake (loaf)	350°F (180°C)	80 to 90	
	Gingerbread	350°F (180°C)	35 to 40	
	Butter Cakes, Cake Mixes	350°F (180°C)	30 to 40	Grease and flour pan.
	Fluted Tube Cake	350°F (180°C)	40 to 50	
Pound Cake	350°F (180°C)	60 to 70	Cool in pan 10 minutes before inverting on wire rack.	
<b>Cookies</b>	Bar	350°F (180°C)	35 to 45	Follow package instructions if using a mix.
	Drop or Sliced	375°F (190°C)	10 to 14	Follow package instructions if using a mix.

### NOTES:

- The oven temperature indicated in the table above is recommended over the package instruction temperature.
- The baking times in the table above are only guidelines for your reference. You need to adjust the baking time according to the food condition or your preference.



# USING YOUR CONVECTION OVEN

## CONVECTION BAKING TABLE

FOOD		Oven Temp.	Time, Min.	Comments
<b>Fruits, Other Desserts</b>	Baked Apples or Pears	350°F (180°C)	30 to 30	Bake in cookware with shallow sides.
	Bread Pudding	300°F (150°C)	35 to 40	Pudding is done when knife inserted near center comes out clean.
	Cream Puffs	400°F (200°C)	30 to 35	Puncture puffs twice with toothpick to release steam after 25 minutes of baking time.
	Custard (individual)	350°F (180°C)	45 to 50	Set cups in baking dish. Pour boiling water around cups to a depth of 1 in. (2.5 cm).
	Meringue Shells	300°F (150°C)	30 to 35	When done, turn oven off and let shells stand in oven 1 hour to dry.
<b>Pies, Pastries</b>	Frozen	375°F (190°C)	40 to 45	Follow package directions for preparation.
	Meringue-Topped	325°F (160°C)	13 to 16	Follow package directions for preparation.
	Two-Crust	400°F (200°C)	50 to 55	Follow package directions for preparation.
	Quiche	350°F (180°C)	30 to 35	Let stand 5 minutes before cutting.
	Pastry Shell	400°F (200°C)	10 to 16	Pierce pastry with fork to prevent shrinkage.
<b>Casseroles</b>	Meat, chicken, seafood combinations	350°F (180°C)	20 to 40	Cook times vary with casserole size and ingredients.
	Pasta	350°F (180°C)	25 to 45	Cook times vary with casserole size and ingredients.
	Potatoes, Scalloped	350°F (180°C)	55 to 60	Let stand 5 minutes before serving.
	Vegetable	350°F (180°C)	25 to 35	Cook times vary with casserole size and ingredients.
<b>Convenience Foods</b>	Frozen Bread Dough	350°F (180°C)	30 to 35	Follow package directions for preparation.
	Frozen Entrée	350°F (180°C)	50 to 60	Follow package directions for preparation.
	Frozen Pizza Rolls, Egg Rolls	400°F (200°C)	8 to 10	Follow package directions for preparation.
	Pizza	425°F (220°C)	15 to 25	Follow package directions for preparation.
	Slice-and-Bake Cookies	375°F (190°C)	13 to 15	Let stand a few minutes before removing from pan to cool.
<b>Main Dishes</b>	Meat Loaf	325°F (160°C)	55 to 60	Let stand 5 minutes after cooking.
	Oven-Baked Stew	325°F (160°C)	80 to 90	Brown meat before combining with liquid and vegetables.
	Swiss Steak	350°F (180°C)	60 to 70	Let stand 2 minutes after cooking.
	Stuffed Peppers	350°F (180°C)	40 to 45	Use green, red, or yellow peppers.
<b>Vegetables</b>	Acorn Squash Halves	375°F (190°C)	55 to 60	Pierce skin several places. Add 1/4 cup (60 ml) water to dish. Turn squash halves cut side up after 30 minutes of cook time and cover.
	Baked Potatoes	425°F (220°C)	50 to 60	Pierce skin with a fork before baking.
	Twice-Baked Potatoes	400°F (200°C)	25 to 30	Pierce skin with fork before baking.

### NOTES:

- The oven temperatures indicated in the table above are recommended over the package instruction temperature.
- The baking times in the table above are only guidelines for your reference. You need to adjust the baking time according to the food condition or your preference.

# USING YOUR CONVECTION OVEN

## MEAT ROASTING TABLE FOR CONVECTION COOKING

MEATS		Oven Temp.	Time, Min./lb.
<b>Beef</b>	Rib (2 to 4 lbs. [1 to 2 kg])		
	Rare	325°F (160°C)	21 to 26
	Medium	325°F (160°C)	26 to 31
	Well	325°F (160°C)	31 to 36
	Boneless Rib, Top Sirloin		
	Rare	325°F (160°C)	25 to 30
	Medium	325°F (160°C)	30 to 35
	Well	325°F (160°C)	35 to 40
	Beef Tenderloin		
	Rare	325°F (160°C)	12 to 16
Medium	325°F (160°C)	16 to 20	
<b>Pot Roast</b> (2½ to 3 lbs. [1 to 1.5 kg])	Chuck, Rump	325°F (160°C)	45 to 50
<b>Ham</b>	Canned (3-lb. [1.5 kg] fully cooked)	325°F (160°C)	20 to 25
	Butt (5-lb. [2.3 kg] fully cooked)	325°F (160°C)	20 to 25
	Shank (5-lb. [2.3 kg] fully cooked)	325°F (160°C)	17 to 20
<b>Lamb</b>	Bone-In (2 to 4 lbs. [1 to 2 kg])		
	Medium	325°F (160°C)	21 to 26
	Well	325°F (160°C)	26 to 31
	Boneless (2 to 4 lbs. [1 to 2 kg])		
	Medium	325°F (160°C)	25 to 30
Well	325°F (160°C)	29 to 34	
<b>Pork</b>	Bone-In (2 to 4 lbs. [1 to 2 kg])	325°F (160°C)	26 to 30
	Boneless (2 to 4 lbs. [1 to 2 kg])	325°F (160°C)	32 to 36
	Pork Chops (1/2- to 1-inch [1- to 2.5-cm] thick)		
	2 chops	325°F (160°C)	12 to 15
	4 chops	325°F (160°C)	15 to 18
	6 chops	325°F (160°C)	18 to 25
<b>Poultry</b>	Whole Chicken (2½ to 3½ lbs. [1 to 2 kg])	375°F (190°C)	25 to 35
	Chicken Pieces (2½ to 3½ lbs. [1 to 2 kg])	350°F (180°C)	13 to 16
	Cornish Hens		
	Unstuffed (1 to 1½ lbs. [0.5 to 0.7 kg])	375°F (190°C)	10 to 15
	Stuffed (1 to 1½ lbs. [0.5 to 0.7 kg])	375°F (190°C)	15 to 20
	Duckling (4 to 5 lbs. [2 to 2.3 kg])	375°F (190°C)	19 to 21
Turkey Breast (4 to 6 lbs. [2 to 3 kg])	325°F (160°C)	21 to 25	
<b>Seafood</b>	Fish, Whole (3 to 5 lbs. [1.5 to 2.3 kg])	400°F (200°C)	10 to 15
	Lobster Tails (6 to 8 oz. [170 to 225 g] each)	350°F (180°C)	12 to 17

### NOTES:

- The roasting times in the table above are only guidelines for your reference. You need to adjust the roasting time according to the food condition or your preference.

# USING YOUR COMBINATION OVEN

## TIPS FOR COMBINATION COOKING

This section gives you instructions to operate each combination cooking function. Please read these instructions carefully. Sometimes combination microwave-convection cooking is suggested to get the best cooking results since it shortens the cooking time for foods that normally need a long time to cook. This cooking process also leaves meats juicy on the inside and crispy on the outside. In combination cooking, the convection heat and microwave energy alternate automatically. Your oven has two preprogrammed settings that make it easy to use combination cooking.

## HELPFUL HINTS FOR COMBINATION COOKING

1. **Meats** may be roasted directly on the metal rack or in a shallow roasting pan placed on the rack. When using the metal rack, please check your cooking guide for information on proper use.
2. **Less tender** cuts of beef can be roasted and tenderized using oven cooking bags.
3. **When baking**, check for doneness after cooking time is up. If not completely done, let stand in oven for a few minutes to complete cooking.





## PRECAUTIONS

1. All cookware used for combination cooking must be BOTH microwave-safe and ovenproof.
2. During combination baking, some baking cookware may cause arcing when it comes in contact with the oven walls or metal accessory racks. Arcing is a discharge of electricity that occurs when microwaves come in contact with metal.
  - If arcing occurs when using the metal rack, place a heatproof dish between the pan and the metal rack.
  - If arcing occurs with other baking cookware, do not use them for combination cooking.

## COMBINATION

	Oven Temperature	Microwave Power
Combination Roast	350°F (180°C)	40%

**Example: To roast with combination cooking for 45 minutes.**

Touch:	Display Shows:
1. 	Time of day
2. 	350 F TOUCH MORE OR LESS FOR TEMP SET OR ENTER COOKING TIME
3. 	45:00 TOUCH START
4. 	E8 350 F Time counting down

### NOTES:

- The temperature can be adjusted; however, the microwave power cannot.
- By using MORE/LESS in combination cooking, you can adjust the temperature by 25°F (14°C) after step 3. (The default temperature is 350°F [180°C].)

# USING YOUR COMBINATION OVEN

## COMBINATION COOKING GUIDE

MEATS		Oven Temp.	Time, Min./lb.
<b>Beef</b>	Rib (2 to 4 lbs. [1 to 2 kg])		
	Rare	300°F (150°C)	11 to 14
	Medium	300°F (150°C)	14 to 17
	Well	300°F (150°C)	17 to 20
	Boneless Rib, Top Sirloin		
	Rare	300°F (150°C)	11 to 14
	Medium	300°F (150°C)	14 to 17
	Well	300°F (150°C)	17 to 20
	Beef Tenderloin		
	Rare	300°F (150°C)	14 to 17
Medium	300°F (150°C)	17 to 20	
Chuck, Rump, or Pot Roast (2½ to 3 lbs. [1 to 1.5 kg]) (Use cooking bag for best results.) Turn over after half of the cooking time.		275°F (140°C)	30 to 40
<b>Ham</b>	Canned (3-lb. [1.5 kg] fully cooked)	300°F (150°C)	15 to 18
	Butt (5-lb. [2.3 kg] fully cooked)	300°F (150°C)	15 to 18
	Shank (5-lb. [2.3 kg] fully cooked)	300°F (150°C)	15 to 18
	Turn over after half of the cooking time.		
<b>Lamb</b>	Bone-In (2 to 4 lbs. [1 to 2 kg])		
	Medium	300°F (150°C)	13 to 18
	Well	300°F (150°C)	18 to 23
	Boneless (2 to 4 lbs. [1 to 2 kg])		
	Medium	300°F (150°C)	14 to 19
	Well	300°F (150°C)	19 to 24
Turn over after half of the cooking time.			
<b>Pork</b>	Bone-In (2 to 4 lbs. [1 to 2 kg])	300°F (150°C)	13 to 16
	Boneless (2 to 4 lbs. [1 to 2 kg])	300°F (150°C)	18 to 23
	Pork Chops (¾- to 1-in. [2- to 2.5-cm] thick)		
	2 chops	350°F (180°C)	10 to 13
	4 chops	350°F (180°C)	13 to 16
	6 chops	350°F (180°C)	16 to 19
	Turn over after half of the cooking time.		
<b>Poultry</b>	Whole Chicken (2½ to 6 lbs. [1 to 3 kg])	375°F (190°C)	18 to 20
	Chicken Pieces (2½ to 6 lbs. [1 to 3 kg])	375°F (190°C)	15 to 18
	Cornish Hens		
	Unstuffed	375°F (190°C)	18 to 25
	Stuffed	375°F (190°C)	23 to 30
	Duckling	375°F (190°C)	15 to 18
	Turkey Breast (4 to 6 lbs. [2 to 3 kg]) Turn breast side up after half of the cooking time.	300°F (150°C)	11 to 15
<b>Seafood</b>	Fish Fillets (1-lb. [0.5-kg])	350°F (180°C)	7 to 10
	Lobster Tails (6 to 8 oz. [170 to 225 g] each)	350°F (180°C)	10 to 15
	Shrimp (1 to 2 lbs. [0.5 to 1 kg])	350°F (180°C)	8 to 13
	Scallops (1 to 2 lbs. [0.5 to 1 kg])	350°F (180°C)	8 to 13

**NOTE:** The roasting times in the table above are only guidelines for your reference. You need to adjust the time according to the food condition or your preference.

# HEATING/REHEATING GUIDE

To heat or reheat successfully in a microwave oven, it is important to follow several guidelines. Measure the amount of food in order to determine the time needed to reheat. Arrange the food in a circular pattern for best results. Room temperature food will heat faster than refrigerated food. Canned foods should be taken out of the can and placed in a microwave-safe container. The food will heat more evenly if covered with a microwave-safe lid or vented plastic wrap\*. Remove cover carefully to prevent steam burns. Use the following table as a guide for reheating cooked food.

ITEMS	Cook Time (at High)	Special Instructions
Sliced Meat 3 slices (1/4-inch thick [.63 cm])	1-2 minutes	Place sliced meat on microwavable plate. Cover with plastic wrap and vent*. Note: Gravy or sauce helps to keep meat juicy.
Chicken Pieces 1 breast 1 leg and thigh	2-3 <sup>1</sup> / <sub>2</sub> minutes 1 <sup>1</sup> / <sub>2</sub> -3 minutes	Place chicken pieces on microwavable plate. Cover with plastic wrap and vent*.
Fish Fillet (6-8 oz. [170-225 g])	2-4 minutes	Place fish on microwavable plate. Cover with plastic wrap and vent*.
Lasagna 1 serving (10 <sup>1</sup> / <sub>2</sub> oz. [300 g])	4-6 minutes	Place lasagna on microwavable plate. Cover with plastic wrap and vent*.
Casserole 1 cup (250 ml) 4 cups (1l)	1-3 <sup>1</sup> / <sub>2</sub> minutes 5-8 minutes	COOK covered in microwavable casserole. Stir once halfway through cooking.
Casserole - Cream or Cheese 1 cup (250 ml) 4 cups (1l)	1 <sup>1</sup> / <sub>2</sub> -3 minutes 3 <sup>1</sup> / <sub>2</sub> -5 <sup>1</sup> / <sub>2</sub> minutes	COOK covered in microwavable casserole. Stir once halfway through cooking.
Sloppy Joe or Barbecued Beef 1 sandwich (1/2 cup [125 ml] meat filling) without bun	1-2 <sup>1</sup> / <sub>2</sub> minutes	Reheat filling and bun separately. Cook filling covered in microwavable casserole. Stir once. Heat bun as directed in table below.
Mashed Potatoes 1 cup (250 ml) 4 cups (1l)	1-3 minutes 5-8 minutes	COOK covered in microwavable casserole. Stir once halfway through cooking.
Baked Beans 1 cup (250 ml)	1 <sup>1</sup> / <sub>2</sub> -3 minutes	COOK covered in microwavable casserole. Stir once halfway through cooking.
Ravioli or Pasta in Sauce 1 cup (250 ml) 4 cups (1l)	2 <sup>1</sup> / <sub>2</sub> -4 minutes 7 <sup>1</sup> / <sub>2</sub> -11 minutes	COOK covered in microwavable casserole. Stir once halfway through cooking.
Rice 1 cup (250 ml) 4 cups (1l)	1 <sup>1</sup> / <sub>2</sub> -3 <sup>1</sup> / <sub>2</sub> minutes 4-6 <sup>1</sup> / <sub>2</sub> minutes	COOK covered in microwavable casserole. Stir once halfway through cooking.
Sandwich Roll or Bun 1 roll	15-30 seconds	Wrap in paper towel and place on glass microwavable rack.
Vegetables 1 cup (250 ml) 4 cups (1l)	1 <sup>1</sup> / <sub>2</sub> -2 <sup>1</sup> / <sub>2</sub> minutes 4-6 minutes	COOK covered in microwavable casserole. Stir once halfway through cooking.
Soup 1 serving (8 oz. (250 ml))	1 <sup>1</sup> / <sub>2</sub> -2 <sup>1</sup> / <sub>2</sub> minutes	COOK covered in microwavable casserole. Stir once halfway through cooking.

\*Fold back one corner of the plastic wrap to vent excess steam.

# FRESH VEGETABLE GUIDE

VEGETABLE	AMOUNT	Cook Time (at High)	Instructions	Standing Time
Artichokes (8 oz. (225 g) each)	2 medium 4 medium	5-8 min. 10-13 min.	Trim. Add 2 tsp (10 ml) water and 2 tsp (10 ml) juice. Cover.	2-3 min.
Asparagus, Fresh, Spears	1 lb. (0.5 kg)	3-6 min.	Add 1/2 cup (125 ml) water. Cover.	2-3 min.
Beans, Green and Wax	1 lb. (0.5 kg)	7-11 min.	Add 1/2 cup (125 ml) water in 1 1/2-qt. (1.5-l) casserole. Stir halfway through cooking.	2-3 min.
Beets, Fresh	1 lb. (0.5 kg)	12-16 min.	Add 1/2 cup (125 ml) water in 1 1/2-qt. (1.5-l) covered casserole. Rearrange halfway through.	2-3 min.
Broccoli, Fresh, Spears	1 lb. (0.5 kg)	4-8 min.	Place broccoli in a baking dish. Add 1/2 (125 ml) cup water.	2-3 min.
Cabbage, Fresh, Chopped	1 lb. (0.5 kg)	4-7 min.	Add 1/2 cup (125 ml) water in 1 1/2-qt. (1.5-l) covered casserole. Stir halfway through cooking.	2-3 min.
Carrots, Fresh, Sliced	2 cups (0.5 l)	2-4 min.	Add 1/4 cup (60 ml) water in 1-qt. (1-l) covered casserole. Stir halfway through cooking.	2-3 min.
Cauliflower, Fresh, Whole	1 lb. (0.5 kg)	7-11 min.	Trim. Add 1/4 cup (60 ml) water in 1-qt. (1-l) covered casserole. Stir halfway through cooking.	2-3 min.
Flowerettes, Fresh Celery, Fresh, Sliced	2 cups (0.5 l) 4 cups (1 l)	2 1/2-4 1/2 min. 6-8 min.	Slice. Add 1/2 cup (125 ml) water in 1 1/2-qt. (1.5-l) covered casserole. Stir halfway through cooking.	2-3 min.
Corn, Fresh	2 ears	5-9 min.	Husk. Add 2 tbsp (30 ml) water in 1 1/2-qt. (1.5-l) baking dish. Cover.	2-3 min.
Mushrooms, Fresh, Sliced	1/2 lb. (225 g)	2-3 1/2 min.	Place mushrooms in 1 1/2-qt. (1.5-l) covered casserole. Stir halfway through cooking.	2-3 min.
Parsnips, Fresh, Sliced	1 lb. (0.5 kg)	4-8 min.	Add 1/2 cup (125 ml) water in 1 1/2-qt. (1.5-l) covered casserole. Stir halfway through cooking.	2-3 min.
Peas, Green, Fresh	4 cups (1 l)	7-10 min.	Add 1/2 cup (125 ml) water in 1 1/2-qt. (1.5-l) covered casserole. Stir halfway through cooking.	2-3 min.
Sweet Potatoes Whole Baking (6-8 oz. (170-225 g) each)	2 medium 4 medium	5-10 min. 7-13 min.	Pierce potatoes several times with fork. Place on 2 paper towels. Turn over halfway through cooking.	2-3 min. 2-3 min.
White Potatoes, Whole Baking (6-8 oz. (170-225 g) each)	2 potatoes 4 potatoes	5-8 min. 10-14 min.	Pierce potatoes several times with fork. Place on 2 paper towels. Turn over halfway through cooking.	2-3 min. 2-3 min.
Spinach, Fresh, Leaf	1 lb. (0.5 kg)	4-7 min.	Add 1/2 cup (125 ml) water in 2-qt. (2-l) covered casserole.	2-3 min.
Squash, Acorn or Butternut, Fresh	1 medium	6-8 min.	Cut squash in half. Remove seeds. Place in 8-in. x 8-in. (20-cm x 20-cm) baking dish. Cover.	2-3 min.
Zucchini, Fresh, Sliced	1 lb. (0.5 kg)	4 1/2-7 1/2 min.	Add 1/2 cup (125 ml) water in 1 1/2-qt. (1.5-l) covered casserole. Stir halfway through cooking.	2-3 min.
Zucchini, Fresh, Whole	1 lb. (0.5 kg)	6-9 min.	Pierce. Place on 2 paper towels. Turn over and rearrange halfway through cooking.	2-3 min.

# TROUBLESHOOTING

## Questions and Answers

### Operation

Question	Answer
Why is the oven light not on during cooking?	Bulb may be burned out, requiring replacement.
Is there a clock display? Is there no clock display?	Set a cook time. Touch START. Check the house circuit safety device.
Why does steam come out of the air exhaust vent?	Steam is normally produced during cooking. The microwave oven has been designed to vent this steam.
Will the microwave oven be damaged if it operates empty?	Yes. Never operate the oven empty or without the glass turntable.
Does microwave energy pass through the viewing screen in the door?	No. The metal screen bounces the energy back to the oven cavity. The holes (or ports) allow only light to pass through. They do not let microwave energy pass through.
Why does a tone sound when a pad on the control panel is touched?	The tone tells you that the setting has been entered.
Can the microwave oven be damaged if food is cooked for too long?	Like any other cooking appliance, it is possible to overcook food to the point that the food creates smoke and even possibly fire and damage to the inside of the oven. It is always best to be near the oven while you are cooking.
When the oven is plugged into the wall outlet for the first time, it doesn't work properly. What is wrong?	The microcomputer controlling your oven may temporarily become scrambled and fail to function as programmed when you plug it in for the first time or when power resumes after a power interruption. Unplug the oven from the 120-volt household outlet and then plug it back in to reset the microcomputer by resetting the clock.
Why is there light reflection around the outer case?	This light is from the oven light which is located between the oven cavity and the outer wall of the oven.
What are the various sounds heard when the microwave oven is operating?	The clicking sound is caused by a mechanical switch turning the microwave oven's magnetron ON and OFF. The heavy hum and clunk is from the change in power the magnetron draws as it is turned ON and OFF by a mechanical switch. The change in blower speed is from the change in line voltage caused by the magnetron being turned ON and OFF.

# TROUBLESHOOTING

## Questions and Answers (continued)

### Food

Question	Answer
What is wrong when baked foods have a hard, dry, brown spot?	A hard, dry, brown spot indicates overcooking. Shorten the cooking or reheating time.
Why do eggs sometimes pop?	When baking, frying, or poaching eggs, the yolk may pop due to steam buildup inside the yolk membrane. To prevent this, simply pierce the yolk with a wooden toothpick before cooking. <b>CAUTION:</b> Never microwave eggs in the shell.
Why are scrambled eggs sometimes a little dry after cooking?	Eggs will dry out when they are overcooked, even if the same recipe is used each time. The cooking time may need to be varied for one of these reasons: <ul style="list-style-type: none"> <li>• Eggs vary in size.</li> <li>• Eggs are at room temperature one time and at refrigerator temperature another time.</li> <li>• Eggs continue cooking during standing time.</li> </ul>
Why do baked apples sometimes burst during cooking?	The peel has not been removed from the top half of each apple to allow for expansion of the interior of the apple during cooking. As in conventional cooking methods, the interior of the apple expands during the cooking process.
Why do baked potatoes sometimes burn during cooking?	If the cooking time is too long, fire could result. At the end of the recommended cooking time, potatoes should be slightly firm. <b>CAUTION: Do not overcook.</b>
Why is a standing time recommended after microwave cooking time is over?	Standing time allows foods to continue cooking evenly for a few minutes after the actual microwave oven cooking cycle ends. The amount of standing time depends upon the density of the foods.
Why is additional time required for cooking food stored in the refrigerator?	As in conventional cooking, the initial temperature of food affects total cooking time. You need more time to cook food taken out of a refrigerator than for food at room temperature.



# TROUBLESHOOTING

## BEFORE CALLING FOR SERVICE

You can often correct operating problems yourself. If your microwave oven fails to work properly, locate the operating problem in the list below and try the solutions listed for each problem.

If the microwave oven still does not work properly, contact the nearest Sears Parts & Repair Center, which is fully equipped to handle your service requirements. See warranty notice.

Problem	Possible Causes
Oven does not start	<ul style="list-style-type: none"> <li>• Is the power cord plugged in?</li> <li>• Is the door closed?</li> <li>• Is the cooking time set?</li> <li>• Has the house circuit breaker tripped or blown?</li> </ul>
Arcing or sparking	<ul style="list-style-type: none"> <li>• Are you using approved cookware?</li> <li>• Is the oven empty?</li> </ul>
Incorrect time of day	<ul style="list-style-type: none"> <li>• Have you tried to reset the time of day?</li> </ul>
Unevenly cooked foods	<ul style="list-style-type: none"> <li>• Are you using approved cookware?</li> <li>• Is the glass turntable in the oven?</li> <li>• Did you turn or stir the food while it was cooking?</li> <li>• Were the foods completely defrosted?</li> <li>• Was the time/cooking power level correct?</li> </ul>
Overcooked foods	<ul style="list-style-type: none"> <li>• Was the time/cooking power level correct?</li> </ul>
Undercooked foods	<ul style="list-style-type: none"> <li>• Are you using approved cookware?</li> <li>• Were the foods completely defrosted?</li> <li>• Was the time/cooking power level correct?</li> <li>• Are the ventilation ports clear?</li> </ul>
Improper defrosting	<ul style="list-style-type: none"> <li>• Are you using approved cookware?</li> <li>• Was the time/cooking power level correct?</li> <li>• Did you turn or stir the food during the defrosting cycle?</li> </ul>

ENGLISH

## FEDERAL COMMUNICATIONS COMMISSION RADIO FREQUENCY INTERFERENCE STATEMENT (U.S.A. ONLY)

### WARNING:

This equipment generates and uses ISM frequency energy and if not installed and used properly, that is in strict accordance with the manufacturer's instructions, may cause interference to radio and television reception. It has been type-tested and found to comply with limits for ISM Equipment pursuant to part 18 of FCC Rules, which are designed to provide reasonable protection against such interference in a residential installation.

However, there is no guarantee that interference will not occur in a particular installation. If this equipment does cause interference to radio or television reception, which can be determined by turning the equipment off and on, the user is encouraged to try to correct the interference by one or more of the following:

- Reorient the receiving antenna of the radio or television.
- Relocate the microwave oven with respect to the receiver.
- Move the microwave oven away from the receiver.
- Plug the microwave oven into a different outlet so that the microwave oven and the receiver are on different branch circuits.

**The manufacturer** is not responsible for any radio or TV interference caused by **unauthorized modification** to this microwave oven. It is the responsibility of the user to correct such interference.

# Get it fixed, at your home or ours!

## Your Home

For expert troubleshooting and home solutions advice:

**manage my home**

[www.managemyhome.com](http://www.managemyhome.com)

For repair – **in your home** – of **all** major brand appliances, lawn and garden equipment, or heating and cooling systems, **no matter who made it, no matter who sold it!**

For the replacement parts, accessories and owner's manuals that you need to do-it-yourself.

For Sears professional installation of home appliances and items like garage door openers and water heaters.

**1-800-4-MY-HOME<sup>®</sup>** (1-800-469-4663)

Call anytime, day or night (U.S.A. and Canada)

[www.sears.com](http://www.sears.com)      [www.sears.ca](http://www.sears.ca)

## Our Home

For repair of carry-in items like vacuums, lawn equipment, and electronics, call anytime for the location of your nearest

**Sears Parts & Repair Service Center**

**1-800-488-1222** (U.S.A.)

[www.sears.com](http://www.sears.com)

**1-800-469-4663** (Canada)

[www.sears.ca](http://www.sears.ca)

To purchase a protection agreement on a product serviced by Sears:

**1-800-827-6655** (U.S.A.)

**1-800-361-6665** (Canada)

Para pedir servicio de reparación a domicilio, y para ordenar piezas:

**1-888-SU-HOGAR<sup>®</sup>**

(1-888-784-6427)

Au Canada pour service en français:

**1-800-LE-FOYER<sup>MC</sup>**

(1-800-533-6937)

[www.sears.ca](http://www.sears.ca)

# Sears