

Blu-ray Disc/DVD Home Theatre System

Operating Instructions

WARNING

Do not install the appliance in a confined space, such as a bookcase or built-in cabinet.

To reduce the risk of fire, do not cover the ventilation opening of the apparatus with newspapers, tablecloths, curtains, etc. Do not place the naked flame sources such as lighted candles on the apparatus. Do not expose batteries or apparatus with battery-installed to excessive heat such as sunshine, fire or the like.

To prevent injury, this apparatus must be securely attached to the floor/wall in accordance with the installation instructions.

Indoor use only.

CAUTION

The use of optical instruments with this product will increase eye hazard. As the laser beam used in this Blu-ray Disc / DVD Home Theatre System is harmful to eyes, do not attempt to disassemble the cabinet.

Refer servicing to qualified personnel only.



This appliance is classified as a CLASS 3R LASER product. Visible and invisible laser radiation is emitted when the laser protective housing is opened, so be sure to avoid direct eye exposure. This marking is located on the laser protective housing inside the enclosure.

CLASS 1 LASER PRODUCT
LUOKAN 1 LASERLAITE
KLASS 1 LASERAPPARAT
1类激光产品

This appliance is classified as a CLASS 1 LASER product. This marking is located on the rear exterior.

For the customers in the U.S.A.

To reduce the risk of fire or electric shock, do not expose this apparatus to rain or moisture.

These following indications are located on the rear exterior.



This symbol is intended to alert the user to the presence of uninsulated “dangerous voltage” within the product’s enclosure that may be of sufficient magnitude to constitute a risk of electric shock to persons.



This symbol is intended to alert the user to the presence of important operating and maintenance (servicing) instructions in the literature accompanying the appliance.

Owner's Record

The model and serial numbers are located on the rear exterior of the unit. Record these numbers in the space provided below. Refer to them whenever you call upon your Sony dealer regarding this product. Model No. BDV-E280/BDV-T28 Serial No. _____

The following FCC statement applies only to the version of this model manufactured for sale in the U.S.A. Other versions may not

comply with FCC technical regulations.

NOTE:

This equipment has been tested and found to comply with the limits for a Class B digital device, pursuant to Part 15 of the FCC Rules. These limits are designed to provide reasonable protection against harmful interference to a residential installation. This equipment generates, uses, and can radiate radio frequency energy and, if not installed and used in accordance with the instructions, may cause harmful interference to radio communications. However, there is no guarantee that interference will not occur in a particular installation. If this equipment does cause harmful interference to radio or television reception, which can be determined by turning the equipment off and on, the user is encouraged to try to correct the interference by one or more of the following measures:

- Reorient or relocate the receiving antenna (aerial).
- Increase the separation between the equipment and receiver.
- Connect the equipment into an outlet on a circuit different from that to which the receiver is connected.
- Consult the dealer or an experienced radio/TV technician for help.

CAUTION

You are cautioned that any changes or modifications not expressly approved in this manual could void your authority to operate this equipment.

Properly shielded and grounded cables and connectors must be used for connection to host computers and/or peripherals in order to meet FCC emission limits.

Important Safety Instructions

- 1) Read these instructions.
- 2) Keep these instructions.
- 3) Heed all warnings.
- 4) Follow all instructions.
- 5) Do not use this apparatus near water.
- 6) Clean only with dry cloth.
- 7) Do not block any ventilation openings. Install in accordance with the manufacturer's instructions.
- 8) Do not install near any heat sources such as radiators, heat registers, stoves, or other apparatus (including amplifiers) that produce heat.
- 9) Do not defeat the safety purpose of the polarized or grounding-type plug. A polarized plug has two blades with one wider than the other. A grounding type plug has two blades and a third grounding prong. The wide blade or the third prong are provided for your safety. If the provided plug does not fit into your outlet, consult an electrician for replacement of the obsolete outlet.
- 10) Protect the power cord from being walked on or pinched particularly at plugs, convenience receptacles, and the point where they exit from the apparatus.
- 11) Only use attachments/accessories specified by the manufacturer.
- 12) Use only with the cart, stand, tripod, bracket, or table specified by the manufacturer, or sold with the apparatus. When a cart is used, use caution when moving the cart/apparatus combination to avoid injury from tip-over.



- 13) Unplug this apparatus during lightning storms or when unused for long periods of time.
- 14) Refer all servicing to qualified service personnel. Servicing is required when the apparatus has been damaged in any way, such as power-supply cord or plug is damaged, liquid has been spilled or objects have fallen into the apparatus, the apparatus has been exposed to rain or moisture, does not operate normally, or has been dropped.

For the customers in Canada, Mexico, and Latin America

To reduce the risk of fire or electric shock, do not expose this apparatus to dripping or splashing, and do not place objects filled with liquids, such as vases, on the apparatus.

Precautions

On power sources

- The unit is not disconnected from the mains as long as it is connected to the AC outlet, even if the unit itself has been turned off.
- As the main plug is used to disconnect the unit from the mains, connect the unit to an easily accessible AC outlet. Should you notice an abnormality in the unit, disconnect the main plug from the AC outlet immediately.

On watching 3D video images

Some people may experience discomfort (such as eye strain, fatigue, or nausea) while watching 3D video images. Sony recommends that all viewers take regular breaks while watching 3D video images. The length and frequency of necessary breaks will vary from person to person. You must decide what works best. If you experience any discomfort, you

should stop watching the 3D video images until the discomfort ends; consult a doctor if you believe necessary. You should also review (i) the instruction manual and/or the caution message of any other device used with, or Blu-ray Disc contents played with this product and (ii) our website (<http://esupport.sony.com/>) for the latest information. The vision of young children (especially those under six years old) is still under development. Consult your doctor (such as a pediatrician or eye doctor) before allowing young children to watch 3D video images. Adults should supervise young children to ensure they follow the recommendations listed above.

Copy Protection

Please be advised of the advanced content protection systems used in both Blu-ray Disc™ and DVD media. These systems, called AACS (Advanced Access Content System) and CSS (Content Scramble System), may contain some restrictions on playback, analog output, and other similar features. The operation of this product and the restrictions placed may vary depending on the date of purchase, as the governing board of the AACS may adopt or change its restriction rules after the time of purchase.

Copyrights and Trademarks

- This system incorporates with Dolby* Digital and Dolby Pro Logic (II) adaptive matrix surround decoder and the DTS** Digital Surround System.
 - * Manufactured under license from Dolby Laboratories. Dolby, Pro Logic, and the double-D symbol are trademarks of Dolby Laboratories.
 - ** Manufactured under license under U.S. Patent #'s: 5,451,942; 5,956,674;

5,974,380; 5,978,762; 6,226,616; 6,487,535; 7,212,872; 7,333,929; 7,392,195; 7,272,567 & other U.S. and worldwide patents issued & pending. DTS, DTS-HD and the Symbol are registered trademarks, & DTS-HD Master Audio, and the DTS logos are trademarks of DTS, Inc. Product includes software. © DTS, Inc. All Rights Reserved.

- This system incorporates High-Definition Multimedia Interface (HDMI™) technology. HDMI, the HDMI logo and High-Definition Multimedia Interface are trademarks or registered trademarks of HDMI Licensing LLC in the United States and other countries.
- Java is a trademark of Oracle and/or its affiliates.
- “BD-LIVE” and “BONUSVIEW” are trademarks of Blu-ray Disc Association.
- “Blu-ray Disc” is a trademark.
- “Blu-ray Disc,” “DVD+RW,” “DVD-RW,” “DVD+R,” “DVD-R,” “DVD VIDEO,” and “CD” logos are trademarks.
- “Blu-ray 3D” and “Blu-ray 3D” logo are trademarks of Blu-ray Disc Association.
- “BRAVIA” is a trademark of Sony Corporation.
- “AVCHD” and the “AVCHD” logo are trademarks of Panasonic Corporation and Sony Corporation.
- “XMB,” “XMB,” and “xross media bar” are trademarks of Sony Corporation and Sony Computer Entertainment Inc.
- “PLAYSTATION” is a trademark of Sony Computer Entertainment Inc.
- The Wi-Fi CERTIFIED™ Logo is a certification mark of the Wi-Fi Alliance.
- The Wi-Fi Protected Setup™ Mark is a mark of the Wi-Fi Alliance.

- “Wi-Fi CERTIFIED™” and “Wi-Fi Protected Setup™” are trademarks of the Wi-Fi Alliance.
- “PhotoTV HD” and the “PhotoTV HD” logo are trademarks of Sony Corporation.
- MPEG Layer-3 audio coding technology and patents licensed from Fraunhofer IIS and Thomson.
- iPhone, iPod, iPod classic, iPod nano, and iPod touch are trademarks of Apple Inc., registered in the U.S. and other countries.



- “Made for iPod,” and “Made for iPhone” mean that an electronic accessory has been designed to connect specifically to iPod or iPhone, respectively, and has been certified by the developer to meet Apple performance standards. Apple is not responsible for the operation of this device or its compliance with safety and regulatory standards. Please note that the use of this accessory with iPod or iPhone may affect wireless performance.
- Windows Media is either a registered trademark or trademark of Microsoft Corporation in the United States and/or other countries. This product contains technology subject to certain intellectual property rights of Microsoft. Use or distribution of this technology outside of this product is prohibited without the appropriate license(s) from Microsoft. Content owners use Microsoft PlayReady™ content access technology to protect their intellectual property, including copyrighted content. This device uses PlayReady technology to access PlayReady-protected content and/or WMDRM-protected content. If the device

fails to properly enforce restrictions on content usage, content owners may require Microsoft to revoke the device’s ability to consume PlayReady-protected content. Revocation should not affect unprotected content or content protected by other content access technologies. Content owners may require you to upgrade PlayReady to access their content. If you decline an upgrade, you will not be able to access content that requires the upgrade.

- All other trademarks are trademarks of their respective owners.
- Other system and product names are generally trademarks or registered trademarks of the manufacturers. ™ and ® marks are not indicated in this document.

About These Operating Instructions

- The instructions in these Operating Instructions describe the controls on the remote. You can also use the controls on the unit if they have the same or similar names as those on the remote.
- In this manual, “disc” is used as a general reference for BDs, DVDs, Super Audio CDs, or CDs unless otherwise specified by the text or illustrations.
- The instructions in this manual are for BDV-E280 and BDV-T28. BDV-E280 is the model used for illustration purposes. Any difference in operation is clearly indicated in the text, for example, “BDV-E280 only.”
- Some illustrations are presented as conceptual drawings, and may be different from the actual products.
- The items displayed on the TV screen may vary depending on the area.
- The default setting is underlined.

Table of Contents

About These Operating Instructions	5
Unpacking	7
Index to Parts and Controls.....	8

Getting Started

Step 1: Installing the System	13
Step 2: Connecting the System ...	14
Step 3: Connecting to the Network	20
Step 4: Performing the Easy Setup	22
Step 5: Selecting the Source	23
Step 6: Enjoying Surround Sound	24

Playback

Playing a Disc	27
Playing from a USB Device.....	28
Enjoying an iPod/iPhone.....	29
Playing via a Network.....	31
Available Options	32

Sound Adjustment

Selecting the Effect to Suit the Source	34
Selecting the Audio Format, Multilingual Tracks, or Channel.....	34
Enjoying Multiplex Broadcast Sound	35

Tuner

Listening to the Radio	36
------------------------------	----

Other Operations

Using the Control for HDMI Function for “BRAVIA” Sync	38
Setting the Speakers	39
Using the Sleep Timer	40
Deactivating the Buttons on the Unit	40
Controlling Your TV with the Supplied Remote.....	41
Changing the Brightness of the Front Panel Display	41
Saving Power in Standby Mode.....	41
Browsing Websites	42
Setting up the Network	43

Settings and Adjustments

Using the Setup Display	47
[Network Update].....	47
[Screen Settings].....	48
[Audio Settings].....	49
[BD/DVD Viewing Settings]	50
[Parental Control Settings]	50
[Music Settings].....	51
[System Settings].....	51
[Network Settings].....	51
[Easy Setup].....	52
[Resetting]	52

Additional Information

Precautions	53
Notes about the Discs	54
Troubleshooting.....	55
Playable Discs	60
Playable Types of Files	61
Supported Audio Formats.....	62
Specifications	63
Language Code List.....	64
Index	65

Unpacking

BDV-E280/BDV-T28

- Front speakers (2)

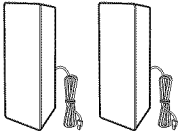

- Surround speakers (2)

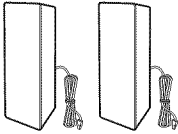

- Center speaker (1)



- Subwoofer (1)

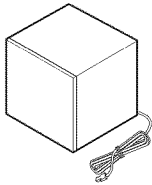

- FM wire antenna (aerial) (1)

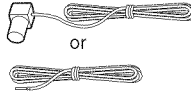

- Video cord (1) (U.S. and Canada models only)

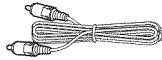

- Remote commander (remote) (1)

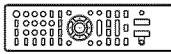

- R6 (size AA) batteries (2)



- HDMI cable (1) (Mexican and Latin American models of BDV-E280 and U.S. and Canada models of BDV-T28 only)

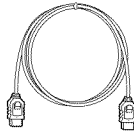

- HDMI cable (2) (Mexican and Latin American models of BDV-T28 only)

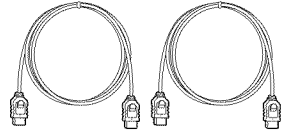

- Dock for iPod/iPhone (TDM-iP30) (1) (U.S. and Canada models only)

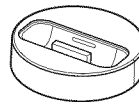

- USB cable (1) (U.S. and Canada models only)

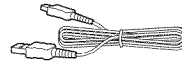

- Operating Instructions
- Quick Setup Guide
- Speaker Installation Guide
- Software License Information

Preparing the remote

Insert two R6 (size AA) batteries (supplied) by matching the ⊕ and ⊖ ends on the batteries to the markings inside the compartment.

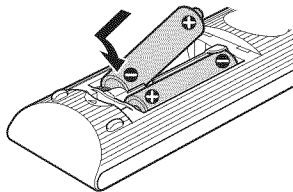



Index to Parts and Controls

For more information, refer to the pages indicated in parentheses.

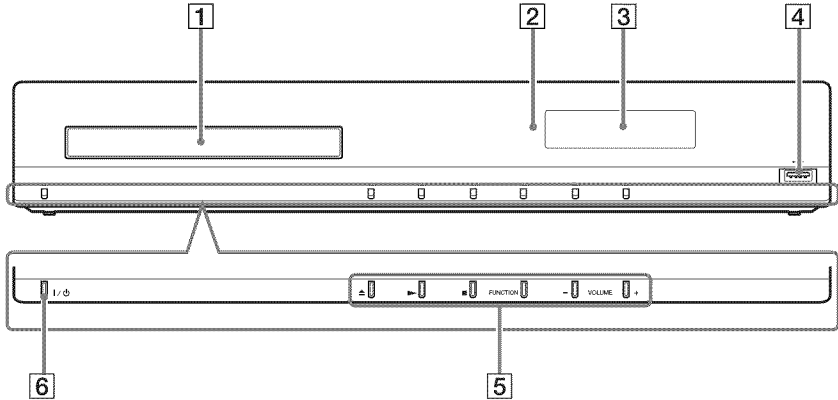
Front panel



- 1 Disc tray (page 27)**
- 2 Remote sensor**
- 3 Front panel display**
- 4  (USB) port (page 28) (Mexican and Latin American models only)**
Used for connecting a USB device.
- 5 Play operation buttons**
 -  (open/close) (page 27)**
Opens or closes the disc tray.
 -  (play)**
Starts or re-starts playback (resume play).
Plays a slideshow when a disc containing JPEG image files is inserted.

■ (stop)

Stops playback and remembers the stop point (resume point).

The resume point for a title/track is the last point you played or the last photo for a photo folder.

FUNCTION

Selects the playback source.

VOLUME +/-

Adjusts the system's volume.

- 6  (on/standby)**

Turns on the unit, or sets it to standby mode.

Front panel display

About the indications in the front panel display

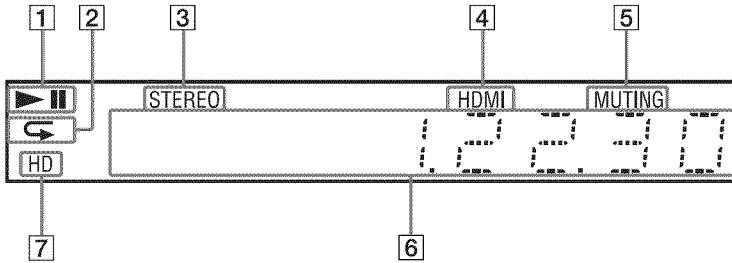

- 1 Displays the system's playing status.
- 2 Lights up when repeat play is activated.
- 3 Lights up when stereo sound is received. (Radio only)
- 4 Lights up when the HDMI (OUT) jack is correctly connected to an HDCP (High-bandwidth Digital Content Protection)-compliant device with HDMI or DVI (Digital Visual Interface) input.
- 5 Lights up when muting is on.
- 6 Displays the system's status, such as radio frequency, etc.
- 7 Lights up when outputting 720p/1080i/1080p video signals from the HDMI (OUT) jack.

Rear panel

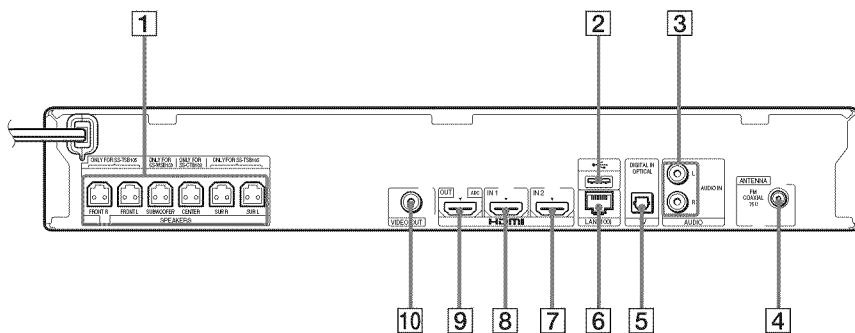

- | | |
|--|---------------------------------------|
| 1 SPEAKERS jacks (page 14) | 6 LAN (100) terminal (page 20) |
| 2 (USB) port (page 28) | 7 HDMI (IN 2) jack (page 17) |
| 3 AUDIO (AUDIO IN L/R) jacks (page 17) | 8 HDMI (IN 1) jack (page 17) |
| 4 ANTENNA (FM COAXIAL 75Ω) jack (page 19) | 9 HDMI (OUT) jack (page 15) |
| 5 TV (DIGITAL IN OPTICAL) jack (page 15) | 10 VIDEO OUT jack (page 15) |

Remote control

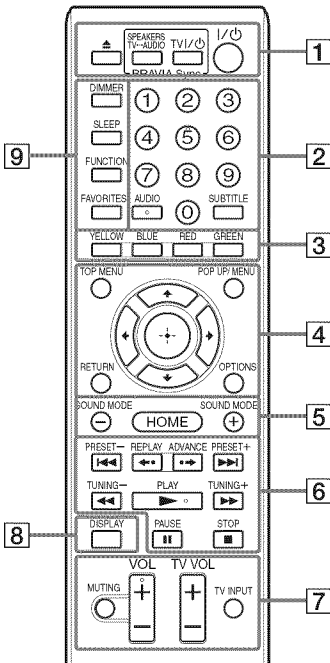

Number 5, AUDIO, VOL +, and ► buttons have a tactile dot. Use the tactile dot as a reference when operating the remote.

- **TV** : For TV operations
(For details, see “Controlling Your TV with the Supplied Remote” (page 41).)

1 ▲ (open/close)

Opens or closes the disc tray.

SPEAKERS TV↔AUDIO

Selects whether TV sound is output from the system’s speakers or the TV’s speaker(s). This function works only when you set [Control for HDMI] to [On] (page 51).

TV I/O (on/standby) (page 41) **TV**

Turns on the TV or sets it to standby mode.

I/O (on/standby) (pages 22, 36)

Turns on the system or sets it to standby mode.

2 Number buttons (pages 37, 41)

Enters the title/chapter numbers, preset station number, etc.

AUDIO (pages 34, 35)

Selects the audio format/track.

SUBTITLE (page 50)

Selects the subtitle language when multilingual subtitles are recorded on a BD-ROM/DVD VIDEO.

3 Color buttons (yellow/blue/red/green)

Short cut keys for selecting items on some BD menus (can also be used for Java interactive operations on BDs).

4 TOP MENU

Opens or closes the BD’s or DVD’s Top Menu.

POP UP/MENU

Opens or closes the BD-ROM’s Pop-up Menu, or the DVD’s menu.

OPTIONS (pages 24, 32, 42)

Displays the options menu on the TV screen or in the front panel display. (The location differs based on the selected function.)

RETURN

Returns to the previous display.

←/↑/↓/→

Moves the highlight to a displayed item.

+ (enter)

Enters the selected item.

5 SOUND MODE +/- (page 34)

Selects the sound mode.

HOME (pages 22, 36, 39, 42, 43, 47)

Enters or exits the system’s home menu.

6 Playback operation buttons

See “Playback” (page 27).

◀◀/▶▶ (previous/next)

Skip to the previous/next chapter, track, or file.

◀••/••▶ (replay/advance)

Briefly replay the current scenes for 10 seconds./Briefly fast forwards the current scenes for 15 seconds.

◀◀/▶▶ (fast/slow/freeze frame)

Fast reverse/fast forward the disc during playback. Each time you press the button, the search speed changes.

Activates slow-motion play when pressed for more than one second in pause mode.

Plays one frame at a time when pressed in pause mode.

Slow-motion and single-frame playback are not available for Blu-ray 3D Discs.

▶ (play)

Starts or re-starts playback (resume play).

Activates One-Touch Play (page 38) when the system is on and set to the “BD/DVD” function.

⏸ (pause)

Pauses or re-starts playback.

■ (stop)

Stops playback and remembers the stop point (resume point). The resume point for a title/track is the last point you played or the last photo for a photo folder.

Radio operation buttons

See “Tuner” (page 36).

PRESET +/-

TUNING +/-

7 MUTING

Turns off the sound temporarily.

VOL +/- (page 36)

Adjusts the volume.

TV VOL +/-

Adjusts the TV volume.

TV INPUT

Switches the TV’s input source between the TV and other input sources.

8 DISPLAY (pages 27, 31, 42)

Displays playback and web browsing information on the TV screen.

Displays the preset radio station, frequency, etc., in the front panel display.

Displays the stream information/decoding status in the front panel display when the function is set to other than “BD/DVD.” When the system is set to the “HDMI1,” “HDMI2,” or “TV” function, the stream information/decoding status appears only when a digital signal is input.

The stream information/decoding status may not appear depending on the stream or item being decoded.

9 DIMMER (page 41)

Changes the brightness of the front panel display.

SLEEP (page 40)

Sets the sleep timer.

FUNCTION (pages 23, 36)

Selects the playback source.

FAVORITES

Displays the Internet contents added to the Favorites List. You can save 18 favorite Internet contents.

Step 1: Installing the System

How to position the system

Install the system by referring to the illustration below.

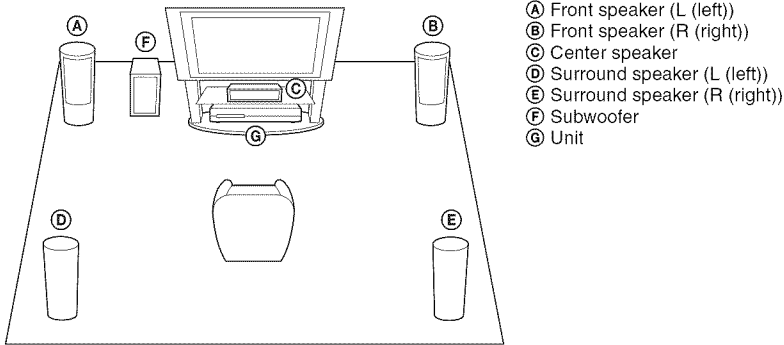

- Ⓐ Front speaker (L (left))
- Ⓑ Front speaker (R (right))
- Ⓒ Center speaker
- Ⓓ Surround speaker (L (left))
- Ⓔ Surround speaker (R (right))
- Ⓕ Subwoofer
- Ⓖ Unit

Note

- Use caution when placing the speakers and/or speaker stands attached to the speakers on a specially treated (waxed, oiled, polished, etc.) floor, as staining or discoloration may result.
- Do not lean or hang on a speaker, as it may fall down.

Tip

- You can install the speakers on a wall. For details, refer to the supplied "Speaker Installation Guide."

Step 2: Connecting the System

For connecting the system, read the information on the following pages.

Do not connect the AC power cord (mains lead) of the unit to a wall outlet (mains) until all the other connections are made.

Note

- When you connect another component with a volume control, turn down the volume of the other components to a level where sound is not distorted.

Connecting the speakers

To connect speaker cords to the unit

Connect the speaker cords to match the color of the SPEAKERS jacks of the unit.

When connecting to the unit, insert the connector until it clicks.

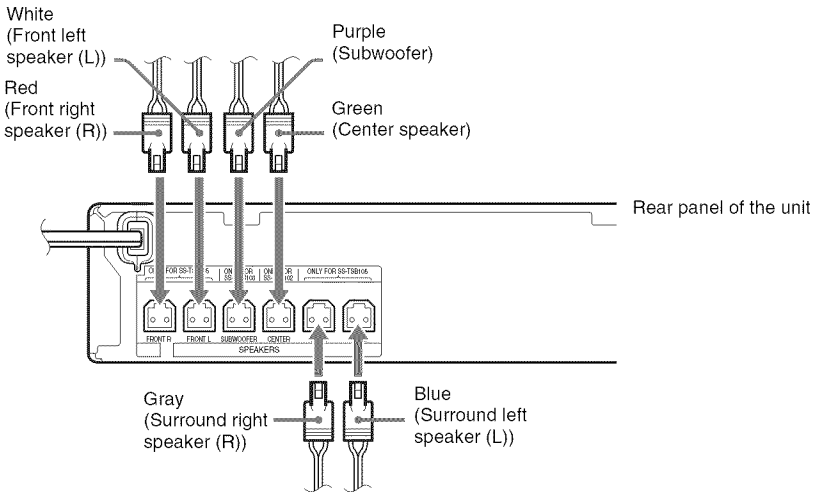

Connecting the TV

Connect the system to your TV to display the image of the system on your TV, and listen to TV sound via the system's speakers.

Depending on the jacks and functions on your TV, select the connection method.

- When your TV has an HDMI jack that is marked "ARC"¹⁾: Connection (A)
- When your TV has an HDMI jack: Connections (A) and (C)
- When your TV does not have HDMI jacks: Connections (B) and (C)

Video connections

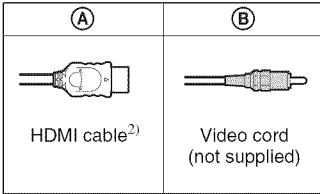

Audio connection

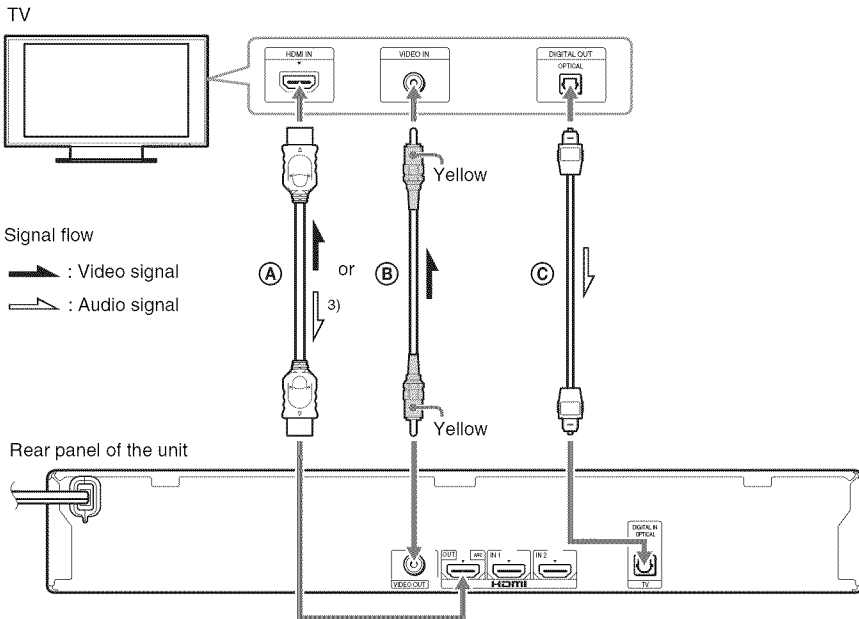
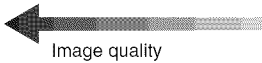
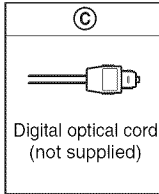

¹⁾Audio Return Channel. For details, see "About Audio Return Channel" (page 16).

²⁾The HDMI cable is supplied with Mexican and Latin American models and BDV-T28 only.

³⁾Available only when your TV is compatible with the Audio Return Channel function.

Ⓐ HDMI cable connection

If your TV has an HDMI jack, connect to the TV with an HDMI cable. This will provide better image quality compared to other types of connections.

When connecting with an HDMI cable, you need to select the type of output signal when performing the Easy Setup (page 22).

For further HDMI settings, see “[HDMI Settings]” (page 51).

About Audio Return Channel

If your TV is compatible with the Audio Return Channel function, an HDMI cable connection also sends a digital audio signal from the TV. You do not need to make a separate audio connection for listening to TV sound. For setting the Audio Return Channel function, see [Audio Return Channel] (page 51).

Ⓑ Video cord connection

If your TV does not have an HDMI jack, make this connection.

Ⓒ Digital optical cord connection

This connection sends an audio signal to the system from the TV. To listen to TV sound via the system, perform this connection. With this connection, the system receives a Dolby Digital multiplex broadcast signal and you can enjoy multiplex broadcast sound.

Note

- You can enjoy the TV sound by selecting the “TV” function (page 23).
- If your TV does not have a digital optical output jack, you can connect the unit and your TV with an audio cord for listening to TV sound via the system. For connection details, see “Connecting the other components” (page 17).

Connecting the other components

When a component you wish to connect to the system has an HDMI (OUT) jack

You can connect a component that has an HDMI (OUT) jack such as a set-top box/digital satellite receiver or PLAYSTATION®3, etc., with an HDMI cable. An HDMI cable connection can send both video and audio signals. By connecting the system and the component using an HDMI cable, you can enjoy high-quality digital picture and sound via the HDMI (IN 1) or HDMI (IN 2) jack.

Rear panel of the unit

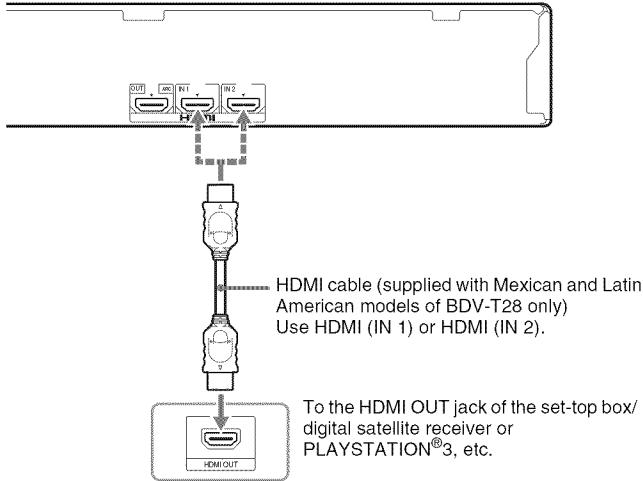

Note

- Video signals from the HDMI (IN 1/2) jacks are sent to the HDMI (OUT) jack only when the “HDMI1” or “HDMI2” function is selected.
- To send an audio signal from the HDMI (IN 1/2) jacks to the HDMI (OUT) jack, you may need to change the audio output setting. For details, see [Audio Output] in [Audio Settings] (page 49).

When the component does not have an HDMI OUT jack

Connect the system so that video signals from the system and other component are sent to the TV, and audio signals from the component are sent to the system as follows.

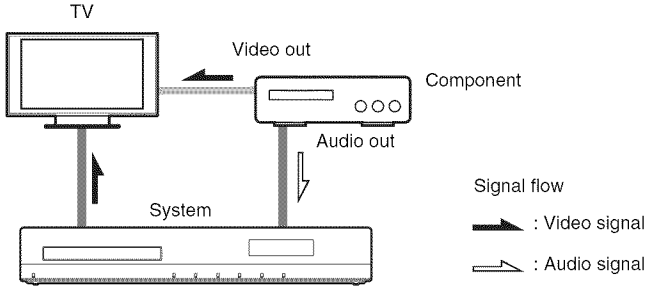

If the component plays sound only, connect the audio output of the component to the system.

Rear panel of the unit

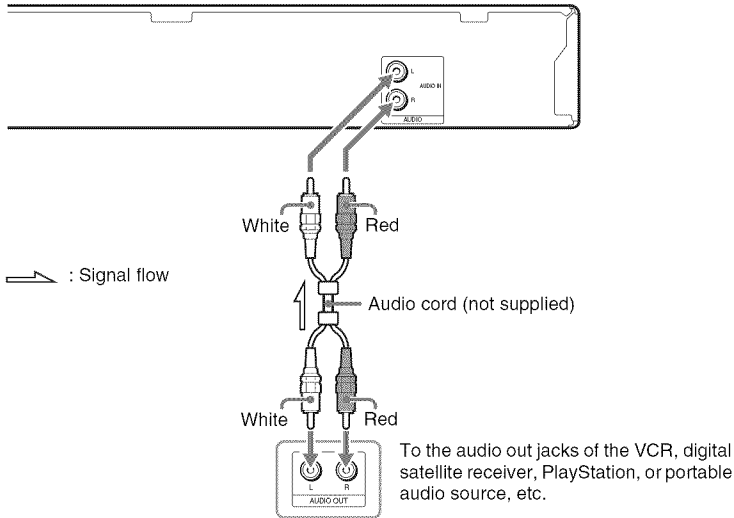

Note

- If you make connection above, set [Control for HDMI] in [HDMI Settings] of [System Settings] to [Off] (page 51).
- You can enjoy component sound by selecting the “AUDIO” function (page 23).

Connecting the antenna (aerial)

Rear panel of the unit

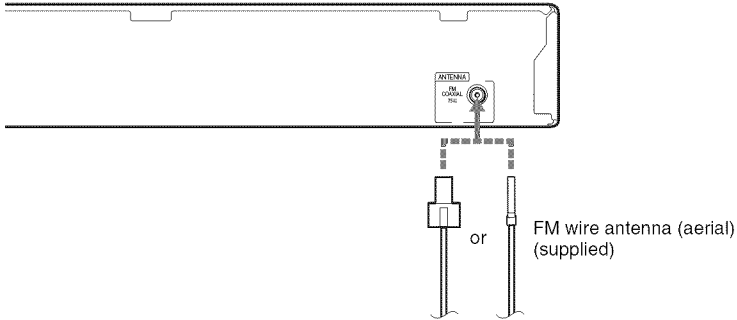

Note

- Be sure to fully extend the FM wire antenna (aerial).
- After connecting the FM wire antenna (aerial), keep it as horizontal as possible.

Tip

- If you have poor FM reception, use a 75-ohm coaxial cable (not supplied) to connect the unit to an outdoor FM antenna (aerial).

Step 3: Connecting to the Network

Note

- To connect the system to your network, you need to make network settings that suit your usage environment and components. For details, see “Setting up the Network” (page 43) and “[Network Settings]” (page 51).

Select the method based on your LAN (Local Area Network) environment.

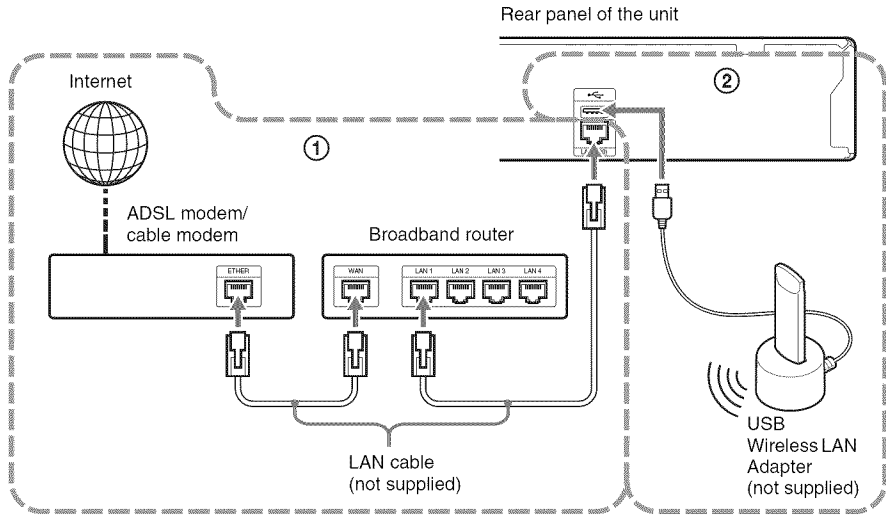

① Wired Setup

Use a LAN cable to connect to the LAN (100) terminal on the unit.

② USB Wireless Setup

Use a wireless LAN via the USB Wireless LAN Adapter (Sony UWA-BR100* only).

The USB Wireless LAN Adapter may not be available in some regions/countries.

* As of November 2010.

Turn the unit off before connecting the extension cable or inserting the USB Wireless LAN Adapter. After inserting the USB Wireless LAN Adapter to the base and connecting the extension cable to the  (USB) port (front or rear), turn the unit on again.

Note

- The placement distance between the USB Wireless LAN Adapter and your wireless LAN router differs based on your usage environment. If the system cannot connect to the network or the network connection is unstable, move the USB Wireless LAN Adapter to a different position or place the USB Wireless LAN Adapter and the wireless LAN router closer to each other.
- You can also get information for network settings from the following Sony support page:

For customers in the U.S.:

<http://www.sony.com/support>

For customers in Canada:

English: <http://www.sony.ca/support>

French: <http://fr.sony.ca/support>

For customers in Mexico and Latin America:

<http://esupport.sony.com/LA>

Step 4: Performing the Easy Setup

Before performing Step 4

Make sure all connections are secure, and then connect the AC power cord (mains lead).

Follow the Steps below to make the basic adjustments for using the system.

Displayed items vary depending on the country model.

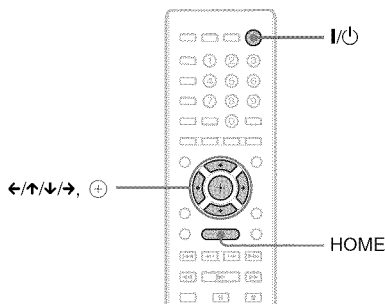

- 1** Turn on the TV.
- 2** Press I/Power.
- 3** Switch the input selector on your TV so that the signal from the system appears on the TV screen.

The Easy Setup Display for OSD language selection appears.

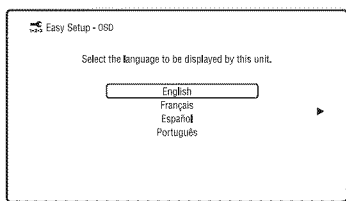

- 4** Perform the [Easy Setup]. Follow the on-screen instructions to make the basic settings using ←/↑/↓/→, and ⊕.

Depending on the connection method (page 15), perform the following setting.

- HDMI cable connection: Follow the instructions that are displayed on the TV screen.
- Video cord connection: Select [16:9] or [4:3] so that the picture is displayed correctly.

To recall the Easy Setup Display

- 1** Press HOME.
The home menu appears on the TV screen.
- 2** Press ←/→ to select  [Setup].
- 3** Press ↑/↓ to select [Easy Setup], then press ⊕.
- 4** Press ←/→ to select [Start], then press ⊕.
The Easy Setup Display appears.

Step 5: Selecting the Source

You can select the playback source.

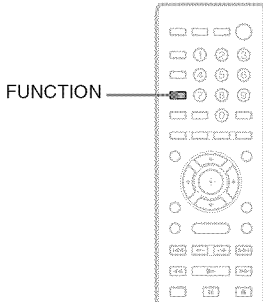

Press FUNCTION repeatedly until the desired function appears in the front panel display.

Each time you press FUNCTION, the function changes as follows.

“BD/DVD” → “FM” → “HDMI1” →
 “HDMI2” → “TV” → “AUDIO” → “BD/
 DVD” → ...

Function	Source
“BD/DVD”	Disc, USB device, iPod/iPhone, or network device to be played by the system
“FM”	FM radio (page 36)
“HDMI1”/ “HDMI2”	Component that is connected to the HDMI (IN 1) or HDMI (IN 2) jack on the rear panel (page 17)
“TV”	Component (TV, etc.) that is connected to the TV (DIGITAL IN OPTICAL) jack on the rear panel, or a TV compatible with the Audio Return Channel function that is connected to the HDMI (OUT) jack on the rear panel (page 15)
“AUDIO”	Component that is connected to the AUDIO (AUDIO IN L/R) jacks on the rear panel (page 17)

Step 6: Enjoying Surround Sound

After performing the previous Steps and starting playback, you can easily enjoy surround sound. You can also select pre-programmed surround settings that are tailored to different kinds of sound sources. They bring the exciting and powerful sound of movie theaters into your home.

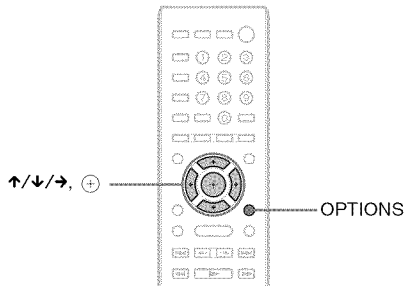

Selecting surround settings based on your listening preference

The setting method differs depending on the function.

When playing via the “BD/DVD”* or “FM” function

- 1** Press **OPTIONS**.
The option menu appears on the TV screen.
- 2** Press **↑/↓** to select [Surround Setting], then press **⊕**.
- 3** Press **↑/↓** repeatedly until the surround setting you want appears on the TV screen.
See the table below for surround sound setting descriptions.
- 4** Press **⊕**.
The setting is made.

* Surround sound settings do not apply to Internet content.

When playing via the “HDMI1,” “HDMI2,” “TV,” or “AUDIO” function

- 1** Press **OPTIONS**.
The option menu appears in the front panel display.
- 2** Press **↑/↓** repeatedly until “SUR. SET” appears in the front panel display, then press **⊕** or **→**.
- 3** Press **↑/↓** repeatedly until the surround setting you want appears in the front panel display.
See the table below for surround sound setting descriptions.
- 4** Press **⊕**.
The setting is made.
- 5** Press **OPTIONS**.
The option menu in the front panel display turns off.

Note

- When the home menu is displayed on the TV screen, this setting can be changed by selecting the surround setting via [Surround Setting] in [Audio Settings] of [Setup] (page 49).

About speaker output of each surround setting

The table below describes the options when you connect all the speakers to the unit.
The default setting is [A.F.D. Multi] (“A.F.D. MULTI”).

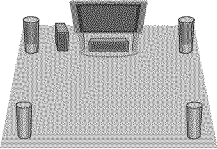
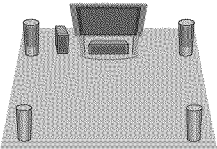
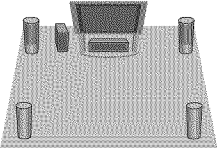
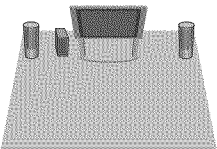
Sound from	Surround setting	Effect
Depending on the source.	[A.F.D. Standard] “A.F.D. STD” (AUTO FORMAT DIRECT STANDARD)	The system discriminates the sound format of the source and presents sound as it was recorded/encoded.
	[A.F.D. Multi] “A.F.D. MULTI” (AUTO FORMAT DIRECT MULTI)	<ul style="list-style-type: none"> • 2 channel source: The system simulates surround sound from 2 channel sources and outputs sound from the 5.1 channel speakers by duplicating 2 channel source sound across each speaker. • Multi-channel source: The system outputs sound from the speakers depending on the number of channels of the source.
	<ul style="list-style-type: none"> • [Dolby Pro Logic] “PRO LOGIC” • [Dolby PL II Movie] “PLII MOVIE” 	<ul style="list-style-type: none"> • 2 channel source: The system simulates surround sound from 2 channel sources and outputs sound from the 5.1 channel speakers. <ul style="list-style-type: none"> – [Dolby Pro Logic] (“PRO LOGIC”) performs Dolby Pro Logic decoding. – [Dolby PL II Movie] (“PLII MOVIE”) performs Dolby Pro Logic II movie mode decoding. • Multi-channel source: The system outputs sound from the speakers depending on the number of channels of the source.
	<ul style="list-style-type: none"> • [DTS Neo:6 Cinema] “NEO6 CIN” • [DTS Neo:6 Music] “NEO6 MUS” 	<ul style="list-style-type: none"> • 2 channel source: The system simulates surround sound from 2 channel sources and produces 6.1 channel sound. <ul style="list-style-type: none"> – [DTS Neo:6 Cinema] (“NEO6 CIN”) performs DTS Neo:6 Cinema mode decoding. – [DTS Neo:6 Music] (“NEO6 MUS”) performs DTS Neo:6 Music mode decoding. • Multi-channel source: The system outputs sound from the speakers depending on the number of channels of the source.
	[2ch Stereo] “2CH ST.”	The system outputs the sound from the front speakers and subwoofer regardless of sound format or number of channels. Multi-channel surround formats are downmixed to 2 channels.

Note

- When you select [A.F.D. Multi] (“A.F.D. MULTI”), depending on the disc or source, the beginning of the sound may be cut off while the optimum mode is automatically selected. To avoid cutting the sound, select [A.F.D. Standard] (“A.F.D. STD”).
- When bilingual broadcast sound is input, [Dolby Pro Logic] (“PRO LOGIC”) and [Dolby PL II Movie] (“PLII MOVIE”) are not effective.

- Depending on the input stream, the surround settings may not be effective.
- When you play a Super Audio CD, surround settings are not activated.

Tip

- You can also select the surround setting in [Surround Setting] of [Audio Settings] (page 49).
- For functions other than “BD/DVD,” you can check whether [Dolby Pro Logic] (“PRO LOGIC”), [Dolby PL II Movie] (“PLII MOVIE”), or the DTS Neo:6 mode is activated by pressing DISPLAY repeatedly so that the stream information/decoding status appears in the front panel display.

Playing a Disc

For playable discs, see “Playable Discs” (page 60).

- 1 Switch the input selector on your TV so that the signal from the system appears on your TV screen.
- 2 Press **▲**, and place a disc on the disc tray.

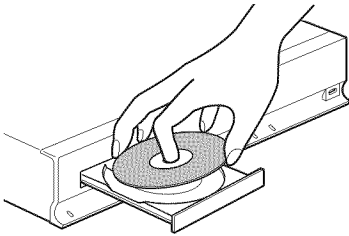

- 3 Press **▲** to close the disc tray.
 - appears on the home menu and playback starts.

If playback does not start automatically, select ● in the [Video], [Music], or [Photo] category, and press **+**.

Enjoying BONUSVIEW/BD-LIVE

Some BD-ROMs with “BD-LIVE Logo*” have bonus content and other data that can be downloaded for enjoyment.

* BD-LIVE™

- 1 Connect the USB device to the **↔ (USB)** port on the rear of the unit.
- For local storage, use a 1 GB or larger USB memory.

Rear panel

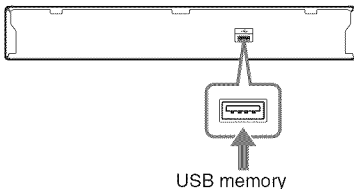

USB memory

- 2 Prepare for BD-LIVE (BD-LIVE only).
 - Connect the system to a network (page 20).
 - Set [BD Internet Connection] to [Allow] (page 50).
- 3 Insert a BD-ROM with BONUSVIEW/BD-LIVE.

The operation method differs depending on the disc. Refer to the operating instructions of the disc.

Tip

- To delete data in the USB memory, select [Erase BD Data] in [Video], and press **+**. All data stored in the buda folder will be deleted.

Enjoying Blu-ray 3D

You can enjoy Blu-ray 3D Discs with the 3D logo*.



- 1 Prepare for Blu-ray 3D Disc playback.
 - Connect the system to your 3D-compatible TV using a High-Speed HDMI cable (supplied with Mexican and Latin American models and BDV-T28 only).
 - Set [3D Output Setting] and [TV Screen Size Setting for 3D] in [Screen Settings] (page 48).
- 2 Insert a Blu-ray 3D Disc.

The operation method differs depending on the disc. Refer to the operating instructions supplied with the disc.

Tip

- Refer also to the operating instructions of your 3D-compatible TV.

Displaying the play information

You can check the playback information, etc., by pressing DISPLAY.

The displayed information differs depending on the disc type and system status.

Example: when playing a BD-ROM

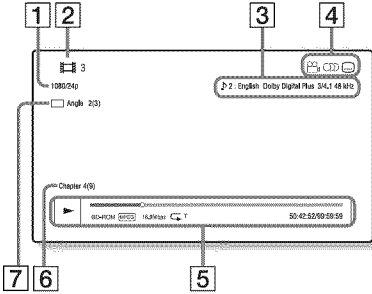

- 1 Output resolution/Video frequency
- 2 Title number or name
- 3 The currently selected audio setting
- 4 Available functions (Angle, audio, subtitle)
- 5 Playback information
Displays play mode, playing status bar, disc type, video codec, bit rate, repeat type, elapsed time, total playing time
- 6 Chapter number
- 7 The currently selected angle

Playing from a USB Device

You can play video/music/photo files on the connected USB device.

For playable types of files, see “Playable Types of Files” (page 61).

- 1 **Connect the USB device to the  (USB) port on the unit.**

Refer to the operating instructions of the USB device before connecting.



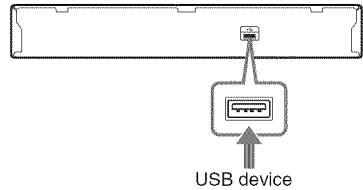

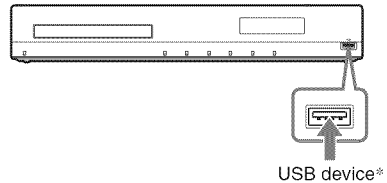

Rear panel







Front panel



* Mexican and Latin American models only.

- 2 **Press HOME.**
The home menu appears on the TV screen.
- 3 **Press  to select  [Video],  [Music], or  [Photo].**
- 4 **(For U.S. and Canada models)**
Press  to select  [USB device], then press .

(For Mexican and Latin American models)

Press  to select  [USB device (front)] or  [USB device (rear)], then press .

Note

- Do not remove the USB device during operation. To avoid data corruption or damage to the USB device, turn the system off when connecting or removing the USB device.

Enjoying an iPod/iPhone

You can enjoy the music/video*/photo* and charge the battery of an iPod/iPhone via the system.

* U.S. and Canada models only.

Compatible iPod/iPhone models

The compatible iPod/iPhone models are as follows. Update your iPod/iPhone with the latest software before using with the system.

Made for iPod classic, iPod 5th generation (video), iPod nano 6th generation, iPod nano 5th generation (video camera), iPod nano 4th generation (video), iPod nano 3rd generation (video), iPod nano 2nd generation (aluminum), iPod nano 1st generation, iPod touch 4th generation, iPod touch 3rd generation, iPod touch 2nd generation, iPod touch 1st generation, iPhone 4, iPhone 3GS, iPhone 3G, iPhone

To enjoy an iPod/iPhone via the system

- (For U.S. and Canada models)**
Connect the Dock for iPod/iPhone (supplied) to the  (USB) port on the unit, then place the iPod/iPhone onto the Dock for iPod/iPhone.

When you play a video/photo file, connect the video out jack of the Dock for iPod/iPhone to the video input jack of your TV with a video cord (supplied) before placing the iPod/iPhone onto the Dock for iPod/iPhone.

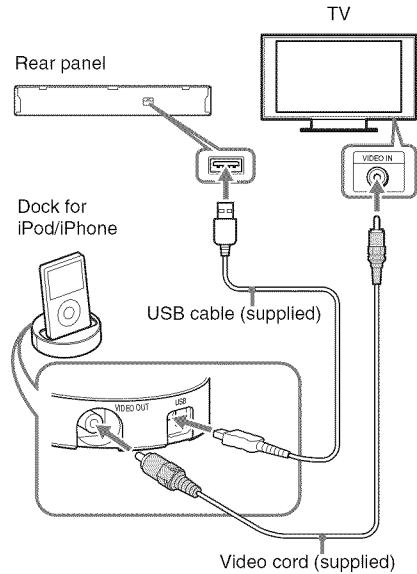

(For other models)

Connect the iPod/iPhone to the  (USB) port on the unit with the iPod/iPhone's USB cable.

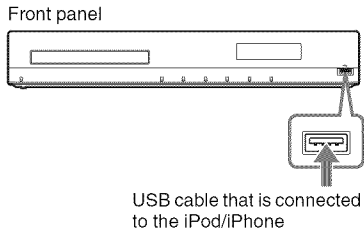
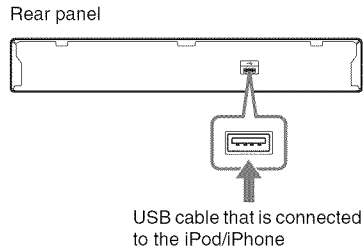

- 2 Press HOME.**

The home menu appears on the TV screen.

3 Press **←/→** to select **[Video]***, **[Music]**, or **[Photo]***.

* U.S. and Canada models only.

4 (For U.S. and Canada models)
Press **↑/↓** to select **[iPod]**, then press **⊕**.

(For Other models)

Press **↑/↓** to select **[iPod (front)]** or **[iPod (rear)]**, then press **⊕**.

■ If you selected **[Video]*** or **[Music]** in Step 3

The video/music files are listed on the TV screen. Go to the next Step.

■ If you selected **[Photo]** in Step 3*

[Please change the TV input to the video input...] appears on the TV screen. Switch the input selector on your TV so that the signal from the iPod/iPhone appears on your TV screen. Then, start the slideshow by operating the iPod/iPhone directly.

* U.S. and Canada models only.

5 Press **←/↑/↓/→** and **⊕** to select the file that you want to play.

The sound from the iPod/iPhone is played on the system.

When you play a video file, switch the input selector on your TV so that the signal from the iPod/iPhone appears on your TV screen. (U.S. and Canada models only)

You can operate the iPod/iPhone using the buttons on the remote.

For operation details, refer to the operating instructions of the iPod/iPhone.

Note

- To change a system setting, such as the surround setting, while viewing images from your iPod/iPhone on your TV, select the input on your TV for this system before operating the system. (U.S. and Canada models only.)

To operate the iPod/iPhone using the remote

You can operate the iPod/iPhone using the buttons on the remote. The following table shows an example of buttons that can be used. (Depending on the iPod/iPhone model, the operation may be different.)

For **[Video]*/[Music]**

Press	Operation
▶	Starts play.
⏸	Pauses play.
■	Stops play.
◀◀ or ▶▶	Fast reverses or forwards.
◀◀ or ▶▶	Goes to the previous/next file or chapter (if any).

For **[Photo]***

Press	Operation
▶ , ⏸	Starts/pauses play. When you press and hold either of these buttons for several seconds, the connected iPod/iPhone enters sleep mode.
■	Pauses play.
◀◀ or ▶▶	Fast reverses or forwards.
◀◀ or ▶▶	Goes to the previous/next file. When you press and hold either of these buttons, the connected iPod/iPhone fast reverses or fast forwards.
DISPLAY	Turns the backlight on (or extends it for 30 seconds).
OPTIONS , ←	Returns to previous display/folder hierarchy.
↑/↓	Selects the previous/next item.
⊕ , →	Enters the selected item.

* U.S. and Canada models only.

Note

- The iPod/iPhone is charged when connected to the system while the system is turned on.
- You cannot transfer songs onto the iPod/iPhone from this system.
- Sony cannot accept responsibility in the event that data recorded to iPod/iPhone is lost or damaged when using an iPod/iPhone connected to this unit.
- This product has been designed specifically to work with iPod/iPhone and has been certified to meet Apple performance standards.

Available Options

Various settings and playback operations are available by pressing **OPTIONS**. The available items differ depending on the situation.

Common options

Items	Details
[Surround Setting]	Changes the surround setting (page 24).
[Repeat Setting]	Sets repeat playback.
[3D Menu]	[3D Depth Adjustment]: Adjusts the depth of 3D images.
[Favorites List]	Displays the Favorites List.
[Play/Stop]	Starts or stops playback.
[Play from beginning]	Plays the item from the beginning.
[Add to Favorites]	Adds an Internet content item to the Favorites List.
[Remove from Favorites]	Erases an Internet content item from the Favorites List.

[Video] only

Items	Details
[A/V SYNC]	Adjusts the gap between picture and sound. For details, see “Adjusting the delay between the picture and sound” (page 33).
[3D Output Setting]	Sets whether or not to output 3D video automatically. Note <ul style="list-style-type: none">• 3D video from the HDMI (IN 1) or HDMI (IN 2) jack is output regardless of this setting.

Items	Details
[Video Settings]	<ul style="list-style-type: none">• [Picture Quality Mode]: Selects the picture settings for different lighting environments.• [FNR]: Reduces the random noise appearing in the picture.• [BNR]: Reduces the mosaic-like block noise in the picture.• [MNR]: Reduces minor noise around the picture outlines (mosquito noise).
[Pause]	Pauses playback.
[Top Menu]	Displays the BD's or DVD's Top Menu.
[Menu/Popup Menu]	Displays the BD-ROM's Pop-up Menu or DVD's menu.
[Title Search]	Searches for a title on BD-ROMs/DVD VIDEOS and starts playback from the beginning.
[Chapter Search]	Searches for a chapter and starts playback from the beginning.
[Angle]	Switches to other viewing angles when multi-angles are recorded on BD-ROMs/DVD VIDEOS.
[IP Content Noise Reduction]	Adjusts the video quality for Internet content.

[Music] only

Items	Details
[Add Slideshow BGM]	Registers music files in the USB memory as slideshow background music (BGM).
[Shuffle Setting] (iPod/iPhone only)	Sets shuffle playback.

[Photo] only

Items	Details
[Slideshow]	Starts a slideshow.
[Slideshow Speed]	Changes the slideshow speed.
[Slideshow Effect]	Sets the effect when playing a slideshow.

Items	Details
[Slideshow BGM]	<ul style="list-style-type: none"> • [Off]: Turns off the function. • [My Music from USB]: Sets the music files registered in [Add Slideshow BGM]. • [Play from Music CD]: Sets the tracks on CD-DAs (music CDs).
[Rotate Left]	Rotates the photo counterclockwise by 90 degrees.
[Rotate Right]	Rotates the photo clockwise by 90 degrees.
[View Image]	Displays the selected picture.

Adjusting the delay between the picture and sound

(A/V SYNC)

When the sound does not match the pictures on the TV screen, you can adjust the delay between the picture and sound.

The setting method differs depending on the function.

Note

- Depending on the input stream, A/V SYNC may not be effective.

When playing video content via the “BD/DVD” function

1 Press **OPTIONS**.

The option menu appears on the TV screen.

2 Press **↑/↓** to select [A/V SYNC], then press **⊕**.

3 Press **←/→** to adjust the delay between the picture and sound.

You can adjust from 0 ms to 300 ms in 25 ms increments.

4 Press **⊕**.

The setting is made.

When playing via the “HDMI1,” “HDMI2,” “TV,” or “AUDIO” function

1 Press **OPTIONS**.

The option menu appears in the front panel display.

2 Press **↑/↓** repeatedly until “A/V SYNC” appears in the front panel display, then press **⊕** or **→**.

3 Press **↑/↓** to adjust the delay between the picture and sound.

You can adjust from 0 ms to 300 ms in 25 ms increments.

4 Press **⊕**.

The setting is made.

5 Press **OPTIONS**.

The option menu in the front panel display turns off.

Selecting the Effect to Suit the Source

You can select a suitable sound mode for movies or music.

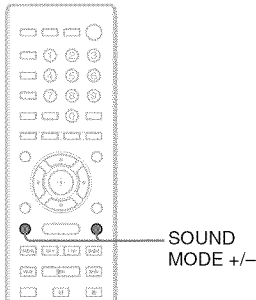

Press SOUND MODE +/- repeatedly during playback until the desired mode appears in the front panel display.

- **“AUTO”**: The system selects “MOVIE” or “MUSIC” automatically to produce the sound effect depending on the disc or sound stream.
- **“MOVIE”**: The system provides the sound for movies.
- **“MUSIC”**: The system provides the sound for music.
- **“SPORTS”**: The system adds reverberation for sports programs.
- **“GAME ROCK”**: The system provides the sound for music/rhythm games.

Note

- Depending on the disc or source, when you select “AUTO,” the beginning of the sound may be cut off as the system selects the optimum mode automatically. To avoid cutting the sound, select other than “AUTO.”
- Depending on the input stream, the sound mode may not be effective.
- When you play a Super Audio CD, this function does not work.

Selecting the Audio Format, Multilingual Tracks, or Channel

When the system is playing a BD/DVD VIDEO recorded in multiple audio formats (PCM, Dolby Digital, MPEG audio, or DTS) or multilingual tracks, you can change the audio format or language.

With a CD, you can select the sound from the right or left channel and listen to the sound of the selected channel through both the right and left speakers.

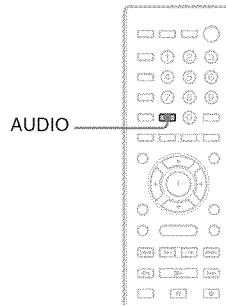

Press AUDIO repeatedly during playback to select the desired audio signal.

The audio information appears on the TV screen.

■ BD/DVD VIDEO

Depending on the BD/DVD VIDEO, the choice of language varies.

When 4 digits are displayed, they indicate a language code. See “Language Code List” (page 64) to confirm which language the code represents. When the same language is displayed two or more times, the BD/DVD VIDEO is recorded in multiple audio formats.

■ DVD-VR

The types of sound tracks recorded on a disc are displayed.

Example:

- [1 Stereo]
- [1 Stereo (Audio1)]
- [1 Stereo (Audio2)]
- [1 Main]
- [1 Sub]
- [1 Main/Sub]

Note

- [1 Stereo (Audio1)] and [1 Stereo (Audio2)] do not appear when only one audio stream is recorded on the disc.

■ CD

- [1 Stereo]: The standard stereo sound.
- [1 1/L]: The sound of the left channel (monaural).
- [1 2/R]: The sound of the right channel (monaural).
- [1 L+R]: The sound of both the left and right channels output from each individual speaker.

Enjoying Multiplex Broadcast Sound

(DUAL MONO)

You can enjoy multiplex broadcast sound when the system receives or plays a Dolby Digital multiplex broadcast signal.

Note

- To receive the Dolby Digital signal, you need to connect a TV or other component to the unit with a digital optical cord (page 15). If your TV is compatible with the Audio Return Channel function (pages 15,51), you can receive a Dolby Digital signal via an HDMI cable.

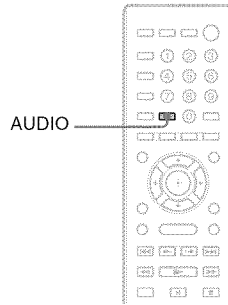

Press AUDIO repeatedly until the desired signal appears in the front panel display.

- “MAIN” : Sound of the main language will be output.
- “SUB” : Sound of the sub language will be output.
- “MAIN/SUB” : Mixed sound of both the main and sub languages will be output.

Listening to the Radio

You can enjoy radio sound with the system's speakers.

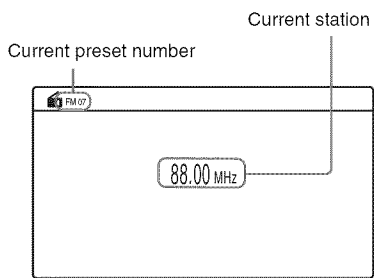
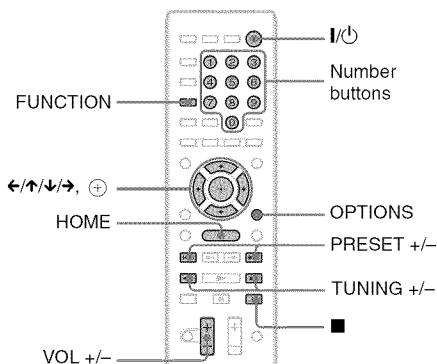

- 1 Press **FUNCTION** repeatedly until "FM" appears in the front panel display.
- 2 Select the radio station.

Automatic tuning

Press and hold **TUNING +/-** until the auto scanning starts.

[Auto Tuning] appears on the TV screen. Scanning stops when the system tunes in a station.

To stop the automatic tuning manually, press **TUNING +/-** or **■**.

Manual tuning

Press **TUNING +/-** repeatedly.

- 3 Adjust the volume by pressing **VOL +/-**.

If an FM program is noisy

If an FM program is noisy, you can select monaural reception. There will be no stereo effect, but reception will improve.

- 1 Press **OPTIONS**.
The option menu appears on the TV screen.
- 2 Press **↑/↓** to select [FM Mode], then press **+**.
- 3 Press **↑/↓** to select [Monaural].
 - [Stereo]: Stereo reception.
 - [Monaural]: Monaural reception.
- 4 Press **+**.
The setting is made.

To turn off the radio

Press **I/Power**.

Presetting radio stations

You can preset up to 20 stations. Before tuning, make sure to turn down the volume to minimum.

- 1 Press **FUNCTION** repeatedly until "FM" appears in the front panel display.
- 2 Press and hold **TUNING +/-** until the auto scanning starts.
Scanning stops when the system tunes in a station.
- 3 Press **OPTIONS**.
The option menu appears on the TV screen.
- 4 Press **↑/↓** to select [Preset Memory], then press **+**.
- 5 Press **↑/↓** to select the preset number you want, then press **+**.
- 6 Repeat Steps 2 to 5 to store other stations.

To change the preset number

Select the desired preset number by pressing **PRESET +/-**, then perform the procedure from Step 3.

Selecting the preset station

- 1 Press FUNCTION repeatedly until "FM" appears in the front panel display.**

The last received station is tuned in.

- 2 Press PRESET +/- repeatedly to select the preset station.**

The preset number and frequency appear on the TV screen and front panel display.

Each time you press the button, the system tunes in one preset station.

Tip

- You can select the preset station number directly by pressing the number buttons.
- Each time you press DISPLAY, the display in the front panel display changes as follows:
Frequency → Preset number →
Stream information/Decoding status* →
Frequency → ...

* Does not appear depending on the setting of [Surround Setting].

Other Operations

Using the Control for HDMI Function for “BRAVIA” Sync

This function is available on TVs with the “BRAVIA” Sync function.

By connecting Sony components that are compatible with the Control for HDMI function via an HDMI cable, operation is simplified.

Note

- Some functions can only be used if the connected TV is compatible, and require prior setting via the TV. Refer to the operating instructions of the TV.
- To use the System Audio Control function, you need to make an audio connection between the system and TV (page 15).

Using “BRAVIA” Sync

Control for HDMI - Easy Setting

You can set the system’s [Control for HDMI] function automatically by enabling the corresponding setting on the TV.

For details about the Control for HDMI function, see “[HDMI Settings]” (page 51)

System Power Off

You can turn the system off in sync with the TV.

Note

- The system does not turn off automatically while playing music or when set to the “FM” function.

One-Touch Play

When you press **▶** on the remote, the system and your TV turn on, and your TV’s input is set to the HDMI input to which the system is connected.

System Audio Control

You can simplify operation to enjoy sound from the TV or other components.

You can use the System Audio Control function as follows:

- When the system is turned on, the sound of the TV or other components can be output from the speakers of the system.
- When sound from the TV or other components is output via the speakers of the system, you can change the speakers to which TV sound is output by pressing **SPEAKERS TV ↔ AUDIO**.
- When sound from the TV or other components is output via the speakers of the system, you can adjust the volume and turn off the sound of the system by operating the TV.

Note

- While the TV is in PAP (picture and picture) mode, or the system is playing video/photo files from the iPod/iPhone, the System Audio Control function will not work.
- Depending on the TV, when you adjust the unit’s volume, the volume level appears on the TV screen. In this case, the volume level that appears on the TV screen and the unit’s front panel display may differ.

Audio Return Channel

You can enjoy TV sound via the system by using just one HDMI cable. For details of the setting, see “Connecting the TV” (page 15).

Remote Easy Control

You can control the basic functions of the system via the TV remote when the system’s video output is displayed on the TV screen.

Language Follow

When you change the language for the on-screen display of the TV, the system’s on-screen display language is also changed after turning the system off and on.

Routing Control

When you perform One-Touch Play on the connected component, the system turns on and sets the system’s function to “HDMI1” or “HDMI2” (depending on the HDMI input jack in use), and your TV’s input is automatically set to the HDMI input to which the system is connected.

Note

- Make sure that the component is connected to the system via an HDMI cable, and the Control for HDMI function of the connected component is set to on.

Setting the Speakers

[Speaker Settings]

To obtain the best possible surround sound, set connection of the speakers and their distance from your listening position. Then use the test tone to adjust the level and the balance of the speakers to the same level.

1 Press HOME.

The home menu appears on the TV screen.

2 Press \leftarrow/\rightarrow to select [Setup].

3 Press \uparrow/\downarrow to select [Audio Settings], then press \oplus .

4 Press \uparrow/\downarrow to select [Speaker Settings], then press \oplus .

The [Speaker Settings] display appears.

5 Press \uparrow/\downarrow to select the item, then press \oplus .

Check the following settings.

■ [Connection]

If you do not connect center or surround speakers, set the parameters for [Center] and [Surround]. Since the front speaker and subwoofer settings are fixed, you cannot change them.

[Front]

[Yes]

[Center]

[Yes]: Normally select this.

[None]: Select this if no center speaker is used.

[Surround]

[Yes]: Normally select this.

[None]: Select this if no surround speaker is used.

[Subwoofer]

[Yes]

■ [Distance]

When you move the speakers, be sure to set the parameters of the distance (A) from the listening position to the speakers.

You can set the parameters from 0 to 23 feet (0.0 to 7.0 meters).

The speakers in the illustration correspond to the following:

- ① Center speaker
- ② Front left speaker (L)
- ③ Front right speaker (R)
- ④ Subwoofer
- ⑤ Surround left speaker (L)
- ⑥ Surround right speaker (R)

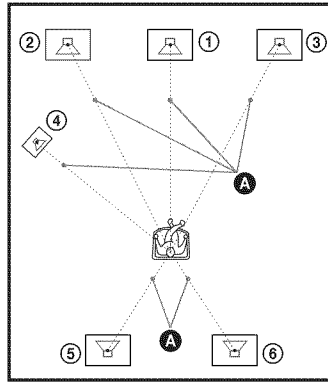

[Front Left/Right] 10 ft/3.0 m: Set the front speaker distance.

[Center]* 10 ft/3.0 m: Set the center speaker distance.

[Surround Left/Right]* 10 ft/3.0 m: Set the surround speaker distance.

[Subwoofer] 10 ft/3.0 m: Set the subwoofer distance.

* This item appears when you set it to [Yes] in the [Connection] setting.

Note

- Depending on the input stream, [Distance] may not be effective.

[Tip]

- You can change measurement units (feet or meters) by pressing the color button (RED).

■ [Level]

You can adjust the sound level of the speakers. You can set the parameters from -6.0 dB to +6.0

dB. Be sure to set [Test Tone] to [On] for easy adjustment.

[Front Left/Right] 0.0 dB: Set the front speaker level.

[Center]* 0.0 dB: Set the center speaker level.

[Surround Left/Right]* 0.0 dB: Set the surround speaker level.

[Subwoofer] 0.0 dB: Set the subwoofer level.

* This item appears when you set it to [Yes] in the [Connection] setting.

■ [Test Tone]

The speakers will emit a test tone to adjust [Level].

[Off]: The test tone is not emitted from the speakers.

[On]: The test tone is emitted from each speaker in sequence while adjusting level. When you select one of the [Speaker Settings] items, the test tone is emitted from each speaker in sequence.

Adjust the sound level as follows.

- 1 Set [Test Tone] to [On].
- 2 Press \uparrow/\downarrow to select [Level], then press \oplus .
- 3 Press \uparrow/\downarrow to select the desired speaker type, then press \oplus .
- 4 Press \leftarrow/\rightarrow to select the left or right speaker, then press \uparrow/\downarrow to adjust the level.
- 5 Press \oplus .
- 6 Repeat Steps 3 to 5.
- 7 Press RETURN.
The system returns to the previous display.
- 8 Press \uparrow/\downarrow to select [Test Tone], then press \oplus .
- 9 Press \uparrow/\downarrow to select [Off], then press \oplus .

Note

- The test tone signals are not output from the HDMI (OUT) jack.

Tip

- To adjust the volume of all the speakers at one time, press VOL +/-.

Using the Sleep Timer

You can set the system to turn off at a preset time, so you can fall asleep listening to music. The time can be preset in intervals of 10 minutes.

Press SLEEP.

Each time you press SLEEP, the minutes display (the remaining time) in the front panel display changes by 10 minutes.

When you set the sleep timer, the remaining time appears every 5 minutes.

When the remaining time is less than 2 minutes, "SLEEP" flashes in the front panel display.

To check the remaining time

Press SLEEP once.

To change the remaining time

Press SLEEP repeatedly to select the desired time.

Deactivating the Buttons on the Unit

(Child Lock)

You can deactivate the buttons on the unit (except for \mathbb{I}/\mathbb{O}) for preventing misoperation, such as child mischief (child lock function).

Press ■ on the unit for more than 5 seconds.

"LOCKED" appears in the front panel display. The child lock function is activated and the buttons on the unit are locked. (You can operate the system by using the remote.)

To cancel, press ■ for more than 5 seconds so that "UNLOCK" appears in the front panel display.

Note

- When you operate the buttons on the unit while the child lock function is on, "LOCKED" flashes in the front panel display.

Controlling Your TV with the Supplied Remote

By adjusting the remote signal, you can control your TV with the supplied remote.

Note

- When you replace the batteries of the remote, the code number may reset itself to the default (SONY) setting. Reset the appropriate code number.

Preparing the remote for controlling the TV

Press and hold TV I/⏻ while entering your TV's manufacturer's code (see the table) using the number buttons. Then release TV I/⏻.

If the setting is unsuccessful, the currently registered code is not changed. Re-enter the code number.

Code numbers of controllable TVs

If more than one code number is listed, try entering them one at a time until you find the code that works with your TV.

Manufacturer	Code number
SONY	01 (default)
LG	02
PANASONIC	05
SAMSUNG	02, 06
SHARP	03
TOSHIBA	04
VIZIO	07

Changing the Brightness of the Front Panel Display

Press DIMMER.

Each time you press DIMMER, the brightness of the front panel display is changed.

Saving Power in Standby Mode

Check that the following settings are both made:

- [Control for HDMI] in [HDMI Settings] is set to [Off] (page 51).
- [Quick Start Mode] is set to [Off] (page 51).

Browsing Websites

You can connect to the Internet and enjoy websites like the Sony homepage using the system.

1 Prepare for Internet browsing.

Connect the system to a network (page 20).

2 Press HOME.

The home menu appears on the TV screen.

3 Press \leftarrow/\rightarrow to select [Network].

4 Press \uparrow/\downarrow to select [Internet Browser], then press \oplus .

The [Internet Browser] display appears.

Note

- Some websites may not display correctly, or not function.

To enter a URL

Select [URL entry] from the options menu. Enter the URL using the software keyboard, then select [Enter].

To set the default start page

While the page you want to set is displayed, select [Set as start page] from the options menu.

To quit Internet Browser

Press HOME.

Internet Browser display

You can check website information by pressing DISPLAY. The display information differs depending on the website and page status.

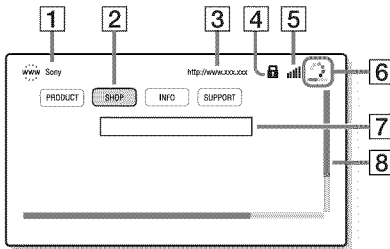

1 Page title

2 Cursor

Move by pressing $\leftarrow/\uparrow/\downarrow/\rightarrow$. Place the cursor on the link you want to view, then press \oplus . The linked website is displayed.

3 Page address

4 SSL icon

Appears when the linked URL is secured.

5 Signal strength indicator

Appears when the system is connected to a wireless network.

6 Progress bar/Loading icon

Appears when the page is being read, or during file download/transfer.

7 Text input field

Press \oplus , then choose [Input] from the options menu to open the software keyboard.

8 Scroll bar

Press $\leftarrow/\uparrow/\downarrow/\rightarrow$ to move the page display left, up, down, or right.

Available options

Various settings and operations are available by pressing OPTIONS.

The available items differ depending on the situation.

Items	Details
[Browser Setup]	Displays the Internet Browser settings. <ul style="list-style-type: none">• [Zoom]: Increases or decreases the size of the displayed contents.• [JavaScript Setup]: Sets whether to enable or disable JavaScript.• [Cookie Setup]: Sets whether or not to accept browser cookies.• [SSL Alarm Display]: Sets whether to enable or disable SSL.
[Input]	Displays the software keyboard to enter characters while browsing a website.
[Break]	Moves the cursor to the next line in the text input field.

Items	Details
[Delete]	Erases one character on the left side of the cursor during text input.
[Window List]	Displays a list of all currently opened websites. Allows you to return to a previously displayed website by selecting the window.
[Bookmark List]	Displays the bookmark list.
[Character encoding]	Sets the character code.
[Previous page]	Moves to a previously displayed page.
[Next page]	Moves to the previously displayed next page.
[Cancel loading]	Stops loading a page.
[Reload]	Reloads the same page.
[URL entry]	Allows you to enter a URL when the software keyboard is displayed.
[Add to Bookmark]	Adds the currently displayed website to the bookmark list.
[Set as start page]	Sets the currently displayed website as the default start page.
[Open in new window]	Opens a link in a new window.
[Display certificate]	Displays server certificates sent from pages that support SSL.

Setting up the Network

[Internet Settings]

Before setting, connect the system to the network. For details, see “Step 3: Connecting to the Network” (page 20).

To open the setting display

1 Press HOME.

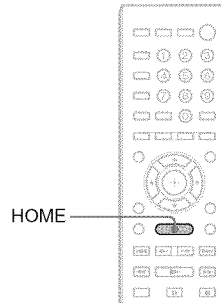

The home menu appears on the TV screen.

2 Press ←/→ to select [Setup].

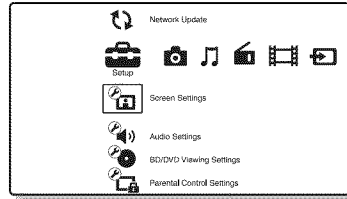

3 Press ↑/↓ to select [Network Settings], then press +.

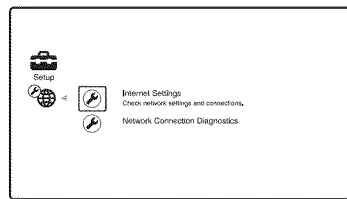

4 Press \uparrow/\downarrow to select [Internet Settings], then press \oplus .

The [Internet Settings] display appears.

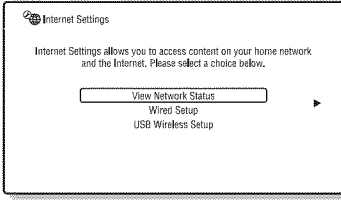

Note

- The [Internet Settings] items are necessary to connect to the Internet. Enter the respective (alphanumeric) values for your broadband router or Wireless LAN router. The items that need to be set may differ, depending on the Internet service provider or the router. For details, refer to the instruction manuals that have been provided by your Internet service provider or supplied with the router.
- For more information, go to the following URL.

For customers in the U.S.:
<http://www.sony.com/support>

For customers in Canada:
English: <http://www.sony.ca/support>
French: <http://fr.sony.ca/support>

For customers in Mexico and Latin America:
<http://esupport.sony.com/LA>

When connecting to the LAN with a LAN cable

Follow the Steps below for connecting to a LAN (Local Area Network).

Auto setting

- 1** Press \uparrow/\downarrow to select [Wired Setup] on the [Internet Settings] display, then press \oplus .
- 2** Press \uparrow/\downarrow to select [Auto], then press \oplus .
The system performs the network setting automatically, and internet settings appear on the TV screen.
- 3** Press \rightarrow .

4 Press \uparrow/\downarrow to select [Save & Connect], then press \oplus .

The system starts checking the network connection.

5 Check that the message [Internet Settings is now complete.] appears, then press \oplus .

The setup is finished. If the message does not appear, follow the on-screen messages.

Manual setting

- 1** Press \uparrow/\downarrow to select [Wired Setup] on the [Internet Settings] display, then press \oplus .
- 2** Press \uparrow/\downarrow to select [Custom], then press \oplus .
- 3** Press \uparrow/\downarrow to select the network setting type, then press \oplus .

- [Auto]: The system sets the IP address automatically, and the [DNS Settings] display appears.
When you select [Auto] and press \oplus , the system sets the DNS setting automatically.
When you select [Specify IP address] and press \oplus , enter the DNS settings manually.
Press $\leftarrow/\uparrow/\downarrow/\rightarrow$ and the number buttons to set the following items, then press \oplus .
 - [Primary DNS]
 - [Secondary DNS]
- [Specify IP address]: Enter the network settings manually according to your network environment.
Press $\leftarrow/\uparrow/\downarrow/\rightarrow$ and the number buttons to set the following items, then press \oplus .
 - [IP Address]
 - [Subnet Mask]
 - [Default Gateway]
 - [Primary DNS]
 - [Secondary DNS]

- 4** Press \uparrow/\downarrow to select the proxy server setting, then press \oplus .
- [No]: A proxy server is not used.
 - [Yes]: Enter the proxy server setting. Press $\leftarrow/\uparrow/\downarrow/\rightarrow$ and the number buttons, then press \oplus .
- The value of the internet settings appears on the TV screen.

5 Press \rightarrow .

- 6** Press \uparrow/\downarrow to select [Save & Connect], then press \oplus .
- The system starts checking the network connection.

- 7** Check that the message [Internet Settings is now complete.] appears, then press \oplus .
- The setup is finished. If the message does not appear, follow the on-screen messages.

When connecting to the wireless LAN with the USB Wireless LAN Adapter

Follow the Steps below for connecting to a wireless LAN (Local Area Network).

When your wireless router is compatible with the WPS function

- 1** Press \uparrow/\downarrow to select [USB Wireless Setup] on the [Internet Settings] display, then press \oplus .
- 2** Press \uparrow/\downarrow to select [Wi-Fi Protected Setup (WPS)], then press \oplus .
- 3** Activate the WPS function of your wireless router, press \uparrow/\downarrow to select [Start], then press \oplus .

For details about activating the WPS function, see the operating instructions of your router.

- 4** Check that the message [Wi-Fi Protected Setup was successful.] appears, then press \rightarrow .
- Setup of wireless LAN connectivity and the IP address is finished.
- Next, enter the proxy server setting. Follow Steps 4 to 7 of “Manual setting” in “When connecting to the LAN with a LAN cable” above.

When your wireless router is not compatible with the WPS function

- 1** Press \uparrow/\downarrow to select [USB Wireless Setup] on the [Internet Settings] display, then press \oplus .
 - 2** Press \uparrow/\downarrow to select [Scan], then press \oplus .
- The system searches for available wireless LANs, then the list of wireless LANs appears.
- 3** Press \uparrow/\downarrow to select the wireless LAN name, then press \oplus .

■ When the selected wireless LAN is unsecured

Setup of wireless LAN connectivity is finished. Next, enter the IP address settings by following the Steps of “Auto setting” or “Manual setting” in “When connecting to the LAN with a LAN cable” above.

■ When the selected wireless LAN is secured

The display for entering a WEP or WPA key appears. Go to Step 5.

■ To specify the wireless LAN name

Select [Manual Entry].

The input display appears. Enter the wireless LAN name by following the on-screen messages, then press \rightarrow .

4 Press **↑/↓** to select the security mode, then press **+**.

- [None]: Select this if the wireless LAN is unsecured. Setup of wireless LAN connectivity is finished. Next, enter the IP address settings by following the Steps of “Auto setting” or “Manual setting” in “When connecting to the LAN with a LAN cable” above.
- [WEP]: The wireless LAN is protected by a WEP key.
- [WPA/WPA2-PSK]: The wireless LAN is protected by a WPA-PSK or WPA2-PSK.
- [WPA2-PSK]: The wireless LAN is protected by a WPA2-PSK.

5 Enter the **WEP key/WPA key** by following the on-screen messages, then press **→**.

Setup of wireless LAN connectivity is finished. Next, enter the IP address settings by following the Steps of “Auto setting” or “Manual setting” in “When connecting to the LAN with a LAN cable” above.

About wireless LAN security

Since communication via the wireless LAN function is established by radio waves, the wireless signal may be susceptible to interception. To protect wireless communication, this system supports various security functions. Be sure to correctly configure the security settings in accordance with your network environment.

No Security

Although you can easily make settings, anyone can intercept wireless communication or intrude into your wireless network, even without any sophisticated tools. Keep in mind that there is a risk of unauthorized access or interception of data.

WEP

WEP applies security to communications to prevent outsiders from intercepting communications or intruding into your wireless network. WEP is a legacy security technology that enables older device which do not support TKIP/AES to be connected.

WPA-PSK (TKIP), WPA2-PSK (TKIP)

TKIP is a security technology developed in response to the deficiencies of WEP. TKIP assures a higher security level than WEP.

WPA-PSK (AES), WPA2-PSK (AES)

AES is a security technology that uses an advanced security method distinct from WEP and TKIP.

AES assures a higher security level than WEP or TKIP.

Using the Setup Display

You can make various adjustments of items such as picture and sound.

Select  (Setup) on the home menu when you need to change the settings of the system.

The default settings are underlined.

Note

- Playback settings stored in the disc take priority over the Setup Display settings and not all the functions described may work.

1 Press HOME.

The home menu appears on the TV screen.

2 Press \leftarrow/\rightarrow to select [Setup].

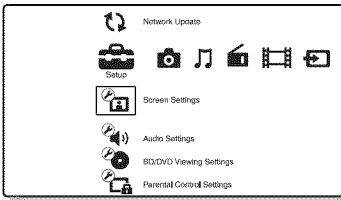





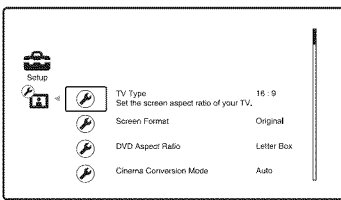





3 Press \uparrow/\downarrow to select the setup category icon to change, then press \oplus .

Example: [Screen Settings]



You can setup the following options.

Icon	Explanation
	[Network Update] (page 47) Updates the software of the system.
	[Screen Settings] (page 48) Makes the screen settings according to the type of connecting jacks.

Icon	Explanation
	[Audio Settings] (page 49) Makes the audio settings according to the type of connecting jacks.
	[BD/DVD Viewing Settings] (page 50) Makes detailed settings for BD/DVD playback.
	[Parental Control Settings] (page 50) Makes detailed settings for the Parental Control function.
	[Music Settings] (page 51) Makes detailed settings for Super Audio CD playback.
	[System Settings] (page 51) Makes the system-related settings.
	[Network Settings] (page 51) Makes detailed settings for Internet and network.
	[Easy Setup] (page 52) Re-runs the Easy Setup to make the basic settings.
	[Resetting] (page 52) Resets the system to the factory settings.

[Network Update]

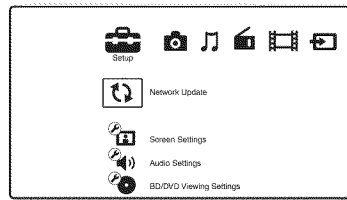

You can update and improve the functions of the system.

For information about update functions, refer to the following website:

For customers in the U.S.:
<http://www.sony.com/support>

For customers in Canada:
English: <http://www.sony.ca/support>
French: <http://fr.sony.ca/support>

For customers in Mexico and Latin America:
<http://esupport.sony.com/LA>

During a software update, "UPDATING" appears in the front panel display. After the update completes, the main unit automatically turns off. Please wait for the software update to complete; do not turn the main unit on or off, or operate the main unit or TV.

[Screen Settings]

■ [3D Output Setting]

[Auto]: Normally select this.

[Off]: Select this to display all contents in 2D.

Note

- 3D video from the HDMI (IN 1) or HDMI (IN 2) jack is output regardless of this setting.

■ [TV Screen Size Setting for 3D]

Sets the screen size of your 3D compatible TV.

Note

- This setting does not apply to 3D video from the HDMI (IN 1) or HDMI (IN 2) jack.

■ [TV Type]

[16:9]: Select this when connecting to a wide-screen TV or a TV with a wide-mode function.

[4:3]: Select this when connecting to a 4:3 screen TV without a wide-mode function.

■ [Screen Format]

[Original]: Select this when connecting to a TV with a wide-mode function. Displays a 4:3 screen picture in 16:9 aspect ratio even on a wide-screen TV.

[Fixed Aspect Ratio]: Changes the picture size to fit the screen size with the original picture aspect ratio.

■ [DVD Aspect Ratio]

[Letter Box]: Displays a wide picture with black bands on the top and bottom.



[Pan & Scan]: Displays a full-height picture on the entire screen, with trimmed sides.

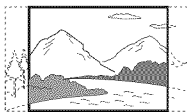

■ [Cinema Conversion Mode]

[Auto]: Normally select this. The unit automatically detects whether the material is video-based or film-based, and switches to the appropriate conversion method.

[Video]: The conversion method suited for video-based material will always be selected regardless of the material.

■ [Output Video Format]

[HDMI]: Normally select [Auto]. Select [Original Resolution] to output the resolution recorded on the disc. (When the resolution is lower than SD resolution, it is scaled up to SD resolution.)

[Video]: Automatically sets the lowest resolution.

■ [BD/DVD-ROM 1080/24p Output]

[Auto]: Outputs 1920 × 1080p/24 Hz video signals only when connecting a 1080/24p-compatible TV using the HDMI (OUT) jack.

[Off]: Select this when your TV is not compatible with 1080/24p video signals.

■ [YCbCr/RGB (HDMI)]

[Auto]: Automatically detects the type of external device, and switches to the matching color setting.

[YCbCr (4:2:2)]: Outputs YCbCr 4:2:2 video signals.

[YCbCr (4:4:4)]: Outputs YCbCr 4:4:4 video signals.

[RGB]: Select this when connecting to a device with an HDCP-compliant DVI jack.

■ [HDMI Deep Color Output]

[Auto]: Normally select this.

[16bit], [12bit], [10bit]: Outputs 16bit/12bit/10bit video signals when the connected TV is compatible with Deep Color.

[Off]: Select this when the picture is unstable or colors appear unnatural.

■ [Pause Mode] (BD/DVD VIDEO/DVD-R/DVD-RW only)

[Auto]: The picture, including subjects that move dynamically, is output with no jitter. Normally select this position.

[Frame]: The picture, including subjects that do not move dynamically, is output in high resolution.

[Audio Settings]

■ [BD Audio MIX Setting]

[On]: Outputs the audio obtained by mixing the interactive audio and secondary audio to the primary audio.

[Off]: Outputs the primary audio only.

■ [Audio DRC]

You can compress the dynamic range of the sound track.

[Auto]: Performs playback at the dynamic range specified by the disc (BD-ROM only).

[On]: The system reproduces the sound track with the kind of dynamic range that the recording engineer intended.

[Off]: No compression of dynamic range.

■ [Attenuate - AUDIO]

Distortion may occur when you listen to a component connected to the AUDIO (AUDIO IN L/R) jacks. You can prevent distortion by reducing the input level on the unit.

[On]: Attenuates the input level. The output level is changed.

[Off]: Normal input level.

■ [Audio Output]

You can select the output method where the audio signal is output.

[Speaker]: Outputs multi-channel sound from the system's speakers only.

[Speaker + HDMI]: Outputs multi-channel sound from the system's speakers and 2-channel linear PCM signals from the HDMI (OUT) jack.

[HDMI]: Outputs sound from the HDMI (OUT) jack only. Sound format depends on the connected component.

Note

- When [Control for HDMI] is set to [On] (page 51), [Audio Output] is set to [Speaker + HDMI] automatically and this setting cannot be changed.
- When [Audio Output] is set to [HDMI], the output signal format for the "TV" function is 2-channel linear PCM.

■ [Sound Effect]

You can set the system's sound effects (SOUND MODE and [Surround Setting]) to on/off.

[On]: Enables all of the system's sound effects. The upper limit of sampling frequency is set to 48 kHz.

[Off]: The sound effects are disabled. Select this when you do not want to set the upper limit of sampling frequency.

■ [Surround Setting]

You can select the surround setting. For details, see "Step 6: Enjoying Surround Sound" (page 24)

■ [Speaker Settings]

To obtain the best possible surround sound, set the speakers. For details, see "Setting the Speakers" (page 39).



[BD/DVD Viewing Settings]

You can make detailed settings for BD/DVD playback.

■ [BD/DVD Menu]

You can select the default menu language for BD-ROMs or DVD VIDEOS.

When you select [Select Language Code], the display for entering the language code appears. Enter the code for your language by referring to “Language Code List” (page 64).

■ [Audio]

You can select the default track language for BD-ROMs or DVD VIDEOS.

When you select [Original], the language given priority in the disc is selected.

When you select [Select Language Code], the display for entering the language code appears. Enter the code for your language by referring to “Language Code List” (page 64).

■ [Subtitle]

You can select the default subtitle language for BD-ROMs or DVD VIDEOS.

When you select [Select Language Code], the display for entering the language code appears. Enter the code for your language by referring to “Language Code List” (page 64).

■ [BD Hybrid Disc Playback Layer]

[BD]: Plays BD layer.

[DVD/CD]: Plays DVD or CD layer.

■ [BD Internet Connection]

[Allow]: Normally select this.

[Do not allow]: Prohibits Internet connection.



[Parental Control Settings]

■ [Password]

Set or change the password for the Parental Control function. A password allows you to set a restriction on BD-ROM, DVD VIDEO, or Internet video playback. If necessary, you can differentiate the restriction levels for BD-ROMs and DVD VIDEOS.

■ [Parental Control Area Code]

Playback of some BD-ROMs or DVD VIDEOS can be limited according to the geographic area. Scenes may be blocked or replaced with different scenes. Follow the on-screen instructions and enter your four-digit password.

■ [BD Parental Control]

Playback of some BD-ROMs can be limited according to the age of the users. Scenes may be blocked or replaced with different scenes. Follow the on-screen instructions and enter your four-digit password.

■ [DVD Parental Control]

Playback of some DVD VIDEOS can be limited according to a predetermined level such as the age of the users. Scenes may be blocked or replaced with different scenes. Follow the on-screen instructions and enter your four-digit password.

■ [Internet Video Parental Control]

Playback of some Internet videos can be limited according to the age of the users. Scenes may be blocked or replaced with different scenes. Follow the on-screen instructions and enter your four-digit password.

■ [Internet Video Unrated]

[Allow]: Allows the playback of unrated Internet videos.

[Block]: Blocks the playback of unrated Internet videos.



[Music Settings]

You can make detailed settings for Super Audio CD playback.

■ [Super Audio CD Playback Layer]

[Super Audio CD]: Plays the Super Audio CD layer.

[CD]: Plays the CD layer.

■ [Super Audio CD Playback Channel]

[DSD 2ch]: Plays the 2ch area.

[DSD Multi]: Plays the multi-channel area.



[System Settings]

You can make the system-related settings.

■ [OSD]

You can select your language for the system on-screen displays.

■ [HDMI Settings]

[Control for HDMI]

[On]: On. You can operate mutually between components that are connected with an HDMI cable.

[Off]: Off.

[Audio Return Channel]

This function is available when you connect the system and TV that is compatible with the Audio Return Channel function.

[Auto]: The system can receive the digital audio signal of the TV automatically via an HDMI cable.

[Off]: Off.

Note

• This function is available only when [Control for HDMI] is set to [On].

■ [Quick Start Mode]

[On]: Shortens the startup time from standby mode. You can operate the system quickly after turning it on.

[Off]: The default setting.

■ [Auto Standby]

[On]: Turns on the [Auto Standby] function.

When you do not operate the system for about 30 minutes, the system enters standby mode automatically.

[Off]: Turns off the function.

■ [Auto Display]

[On]: Automatically displays information on the screen when changing the viewing titles, picture modes, audio signals, etc.

[Off]: Displays information only when you press DISPLAY.

■ [Screen Saver]

[On]: Turns on the screen saver function.

[Off]: Off.

■ [Software Update Notification]

[On]: Sets the system to inform you of newer software version information (page 47).

[Off]: Off.

■ [System Information]

You can display the system's software version information and the MAC address.



[Network Settings]

You can make detailed settings for Internet and network.

■ [Internet Settings]

Connect the system to the network beforehand. For details, see "Step 3: Connecting to the Network" (page 20).

■ [Network Connection Diagnostics]

You can run the network diagnostic to check if the network connection has been made properly.



1-2-3 [Easy Setup]

Re-runs the Easy Setup to make the basic settings. Follow the on-screen instructions.



[Resetting]

■ [Reset to Factory Default Settings]

You can reset the system settings to the factory default by selecting the group of settings. All the settings within the group will be reset.

■ [Initialize Personal Information]

You can erase your personal information stored in the system.

Precautions

On safety

- To prevent fire or shock hazard, do not place objects filled with liquids, such as vases, on the system, or place the system near water, such as near a bathtub or shower room. Should any solid object or liquid fall into the cabinet, unplug the system and have it checked by qualified personnel before operating it any further.
- Do not touch the AC power cord (mains lead) with wet hands. Doing so may cause an electric shock.

On power sources

- Unplug the unit from the wall outlet (mains) if you do not intend to use it for an extended period of time. To disconnect the cord, pull it out by the plug, never by the cord.

On placement

- Place the system in a location with adequate ventilation to prevent heat build-up in the system.
- At high volume, over long periods of time, the cabinet becomes hot to the touch. This is not a malfunction. However, touching the cabinet should be avoided. Do not place the system in a confined space where ventilation is poor as this may cause overheating.
- Do not block the ventilation slots by putting anything on the system. The system is equipped with a high power amplifier. If the ventilation slots are blocked, the system can overheat and malfunction.
- Do not place the system on surfaces (rugs, blankets, etc.) or near materials (curtains, draperies) that may block the ventilation slots.
- Do not install the system in a confined space, such as a bookshelf or similar unit.
- Do not install the system near heat sources such as radiators, air ducts, or in a place subject to direct sunlight, excessive dust, mechanical vibration, or shock.
- Do not install the system in an inclined position. It is designed to be operated in a horizontal position only.
- Keep the system and discs away from components with strong magnets, such as microwave ovens, or large loudspeakers.
- Do not place heavy objects on the system.

On operation

- If the system is brought directly from a cold to a warm location, or is placed in a very damp room, moisture may condense on the lenses inside the unit. Should this occur, the system may not operate properly. In this case, remove the disc and leave the system turned on for about half an hour until the moisture evaporates.
- When you move the system, take out any disc. If you do not, the disc may be damaged.
- If anything falls into the cabinet, unplug the unit and have it checked by qualified personnel before operating it any further.

On adjusting volume

- Do not turn up the volume while listening to a section with very low level inputs or no audio signals. If you do, the speakers may be damaged when a peak level section is suddenly played.

On cleaning

- Clean the cabinet, panel, and controls with a soft cloth slightly moistened with a mild detergent solution. Do not use any type of abrasive pad, scouring powder or solvent such as alcohol or benzine. If you have any questions or problems concerning your system, please consult your nearest Sony dealer.

On cleaning discs, disc/lens cleaners

- **Do not use cleaning discs or disc/lens cleaners (including wet or spray types). These may cause the apparatus to malfunction.**

On replacement of parts

- In the events that this system is repaired, repaired parts may be collected for reuse or recycling purposes.

On your TV's color

- If the speakers should cause the TV screen to have color irregularity, turn off the TV then turn it on after 15 to 30 minutes. If color irregularity should persist, place the speakers further away from the TV set.

IMPORTANT NOTICE

Caution: This system is capable of holding a still video image or on-screen display image on your television screen indefinitely. If you leave the still video image or on-screen display image displayed on your TV for an extended period of time you risk permanent damage to your television screen. Projection televisions are especially susceptible to this.

On moving the system

- Before moving the system, make sure that there is no disc inserted, and remove the AC power cord (mains lead) from the wall outlet (mains).

Notes about the Discs

On handling discs

- To keep the disc clean, handle the disc by its edge. Do not touch the surface.
- Do not stick paper or tape on the disc.



- Do not expose the disc to direct sunlight or heat sources such as hot air ducts, or leave it in a car parked in direct sunlight as the temperature may rise considerably inside the car.
- After playing, store the disc in its case.

On cleaning

- Before playing, clean the disc with a cleaning cloth.

Wipe the disc from the center out.



- Do not use solvents such as benzine, thinner, commercially available cleaners, or anti-static spray intended for vinyl LPs.

This system can only play a standard circular disc. Using neither standard nor circular discs (e.g., card, heart, or star shape) may cause a malfunction.



Do not use a disc that has a commercially available accessory attached, such as a label or ring.

Troubleshooting



If you experience any of the following difficulties while using the system, use this troubleshooting guide to help remedy the problem before requesting repairs. Should any problem persist, consult your nearest Sony dealer.

Note that if service personnel changes some parts during repair, these parts may be retained.

General

Symptom	Problems and solutions
The power is not turned on.	<ul style="list-style-type: none">• Check that the AC power cord (mains lead) is connected securely.
The remote does not function.	<ul style="list-style-type: none">• The distance between the remote and the unit is too far.• The batteries in the remote are weak.
The disc tray does not open and you cannot remove the disc even after you press  .	<ul style="list-style-type: none">• Try the following: ① Press and hold  and  on the unit for more than 5 seconds to open the disc tray. ② Remove the disc. ③ Disconnect the AC power cord (mains lead) from the wall outlet (mains), then reconnect after several minutes.
The system does not work normally.	<ul style="list-style-type: none">• Disconnect the AC power cord (mains lead) from the wall outlet (mains), then reconnect after several minutes.

Messages

Symptom	Problems and solutions
[A new software version is available. Please go to the “Setup” section of the menu and select “Network Update” to perform the update.] appears on the TV screen.	<ul style="list-style-type: none">• See [Network Update] (page 47) to update the system to a newer software version.
“PROTECTOR” and “PUSH PWR” appear alternately in the front panel display.	<p>Press  to turn off the system, and check the following items after “STANDBY” disappears.</p> <ul style="list-style-type: none">• Are the + and – speaker cords short-circuited?• Are you using only the specified speakers?• Is anything blocking the ventilation holes of the system? <p>After checking the above items and fixing any problems, turn on the system. If the cause of the problem cannot be found even after checking all the above items, consult your nearest Sony dealer.</p>
“LOCKED” appears in the front panel display.	<ul style="list-style-type: none">• Set the child lock function to off (page 40).
“DEMO LOCK” appears in the front panel display.	<ul style="list-style-type: none">• Contact your nearest Sony dealer or local authorized Sony service facility.
“Exxxx” appears in the front panel display.	<ul style="list-style-type: none">• Contact your nearest Sony dealer or local authorized Sony service facility and give the error code.
 appears without any messages on the entire TV screen.	<ul style="list-style-type: none">• Contact your nearest Sony dealer or local authorized Sony service facility.

Picture

Symptom	Problems and solutions
There is no picture.	<ul style="list-style-type: none"> • Check the output method on your system (page 15).
There is no picture when you make an HDMI cable connection.	<ul style="list-style-type: none"> • The unit is connected to an input device that is not HDCP (High-bandwidth Digital Content Protection) compliant (“HDMI” on the front panel does not light up) (page 15).
3D images from the HDMI (IN 1) or HDMI (IN 2) jack do not appear on the TV screen.	<ul style="list-style-type: none"> • Depending on the TV or video component, 3D images may not appear.
No picture appears when the video output resolution selected in [Output Video Format] is incorrect.	<ul style="list-style-type: none"> • Press and hold ▶ and VOLUME – on the unit for more than 5 seconds to reset the video output resolution to the lowest resolution.
The dark area of the picture is too dark/the bright area is too bright or unnatural.	<ul style="list-style-type: none"> • Set [Picture Quality Mode] to [Standard] (default) (page 32).
The picture is not output correctly.	<ul style="list-style-type: none"> • Check the [Output Video Format] settings in [Screen Settings] (page 48). • If the analog and digital signals are output at the same time, set [BD/DVD-ROM 1080/24p Output] in [Screen Settings] to [Off] (page 48). • For BD-ROMs, check the [BD/DVD-ROM 1080/24p Output] settings in [Screen Settings] (page 48).
Picture noise appears.	<ul style="list-style-type: none"> • Clean the disc. • If the picture output from your system goes through your VCR to get to your TV, the copy-protection signal applied to some BD/DVD programs could affect picture quality. If you still experience problems even when you connect your unit directly to your TV, try connecting your unit to the other input jacks.
An image is not displayed on the entire TV screen.	<ul style="list-style-type: none"> • Check the setting of [TV Type] in [Screen Settings](page 48). • The aspect ratio on the disc is fixed.
Color irregularity occurs on the TV screen.	<ul style="list-style-type: none"> • If the speakers are used with a CRT-based TV or projector, install the speakers at least 1.0 ft (0.3 meters) from the TV set. • If the color irregularity persists, turn off the TV set once, then turn it on after 15 to 30 minutes. • Make sure that no magnetic object (magnetic latch on a TV stand, health care device, toy, etc.) is placed near the speakers.
There is no picture after playing a video/photo file on the iPod/iPhone. (U.S. and Canada models only.)	<ul style="list-style-type: none"> • Select the input on your TV for this system.

Sound

Symptom	Problems and solutions
There is no sound.	<ul style="list-style-type: none"> • The speaker cord is not connected securely. • Check the speaker settings (page 39).
The Super Audio CD sound of a component that is connected to the HDMI (IN 1) or HDMI (IN 2) jack is not output.	<ul style="list-style-type: none"> • HDMI (IN 1) and HDMI (IN 2) does not accept an audio format that contains copy protection. Connect the analog audio output of the component to the AUDIO (AUDIO IN L/R) jacks of the unit.
There is no sound from the TV via the HDMI (OUT) jack when using the Audio Return Channel function.	<ul style="list-style-type: none"> • Set [Control for HDMI] in [HDMI Settings] of [System Settings] to [On] (page 51). Also, set [Audio Return Channel] in [HDMI Settings] of [System Settings] to [Auto] (page 51). • Make sure that your TV is compatible with the Audio Return Channel function. • Make sure that an HDMI cable is connected to a jack on your TV that is compatible with the Audio Return Channel function.
The system does not output sound correctly when connected to a set-top box.	<ul style="list-style-type: none"> • Set [Audio Return Channel] in [HDMI Settings] of [System Settings] to [Off] (page 51).
Severe hum or noise is heard.	<ul style="list-style-type: none"> • Move your TV away from the audio components. • Clean the disc.
The sound loses stereo effect when you play a CD.	<ul style="list-style-type: none"> • Select stereo sound by pressing AUDIO (page 34).
The sound comes from the center speaker only.	<ul style="list-style-type: none"> • Depending on the disc, the sound may come from the center speaker only.
No sound or only a very low-level sound is heard from the surround speakers.	<ul style="list-style-type: none"> • Check the speaker connections and settings (pages 14, 39). • Check the surround setting (page 24). • Depending on the source, the effect of the surround speakers may be less noticeable. • A 2 channel source is being played.
Distortion occurs in the sound of a connected component.	<ul style="list-style-type: none"> • Reduce the input level for the connected component by setting [Attenuate - AUDIO] (page 49).

Tuner

Symptom	Problems and solutions
Radio stations cannot be tuned in.	<ul style="list-style-type: none"> • Check that the antenna (aerial) is connected securely. Adjust the antenna (aerial) or connect an external antenna (aerial) if necessary. • The signal strength of the stations is too weak (when tuning in with automatic tuning). Use manual tuning.

Playback

Symptom	Problems and solutions
The disc does not play.	<ul style="list-style-type: none">• The region code on the BD/DVD does not match the system.• Moisture has condensed inside the unit and may cause damage to the lenses. Remove the disc and leave the unit turned on for about half an hour.• The system cannot play a recorded disc that is not correctly finalized (page 60).
File names are not displayed correctly.	<ul style="list-style-type: none">• The system can only display ISO 8859-1-compliant character formats. Other character formats may be displayed differently.• Depending on the writing software used, the input characters may be displayed differently.
A disc does not start playing from the beginning.	<ul style="list-style-type: none">• Resume play has been selected. Press OPTIONS and select [Play from beginning], then press +.
Playback does not start from the resume point where you last stopped playing.	<ul style="list-style-type: none">• The resume point may be cleared from memory depending on the disc when<ul style="list-style-type: none">– you open the disc tray.– you disconnect the USB device.– you play other content.– you turn off the unit.
The language for the soundtrack/subtitle or angles cannot be changed.	<ul style="list-style-type: none">• Try using the BD's or DVD's menu.• Multi-lingual tracks/subtitles or multi-angles are not recorded on the BD or DVD being played.
Bonus contents or other data that are contained in a BD-ROM cannot be played.	<ul style="list-style-type: none">• Try the following: ① Remove the disc. ② Turn the system off. ③ Remove and reconnect the USB device (page 28). ④ Turn the system on. ⑤ Insert the BD-ROM with BONUSVIEW/BD-LIVE.

USB device

Symptom	Problems and solutions
The USB device is not recognized.	<ul style="list-style-type: none">• Try the following: ① Turn the system off. ② Remove and reconnect the USB device. ③ Turn the system on.• Make sure that the USB device is securely connected to the  (USB) port.• Check if the USB device or a cable is damaged.• Check if the USB device is on.• If the USB device is connected via a USB hub, disconnect it and connect the USB device directly to the unit.

BRAVIA Internet Video

Symptom	Problems and solutions
The picture/sound is poor/certain programs display with a loss of detail, especially during fast-motion or dark scenes.	<ul style="list-style-type: none">• Picture/sound quality may be poor depending on Internet content providers.• Picture/sound quality may be improved by changing the connection speed. Sony recommends a connection speed of at least 2.5 Mbps for standard-definition video and 10 Mbps for high-definition video.• Not all videos contain sound.
The picture is small.	<ul style="list-style-type: none">• Press ↑ to zoom in.

“BRAVIA” Sync ([Control for HDMI])

Symptom	Problems and solutions
The [Control for HDMI] function does not work (“BRAVIA” Sync).	<ul style="list-style-type: none"> • Check that [Control for HDMI] is set to [On] (page 51). • If you change the HDMI connection, turn the system off and on again. • If power failure occurs, set [Control for HDMI] to [Off], then set [Control for HDMI] to [On] (page 51). • Check the following and refer to the operating instructions supplied with the component. <ul style="list-style-type: none"> – the connected component is compatible with the [Control for HDMI] function. – the connected component’s setting for the [Control for HDMI] function is correct.

Network connection

Symptom	Problems and solutions
The system cannot connect to the network.	<ul style="list-style-type: none"> • Check the network connection (page 20) and the network settings (page 51).

USB wireless LAN connection

Symptom	Problems and solutions
You cannot connect your PC to the Internet after [Wi-Fi Protected Setup (WPS)] is performed.	<ul style="list-style-type: none"> • The wireless settings of the router may change automatically if you use the Wi-Fi Protected Setup function before adjusting the settings of the router. In this case, change the wireless settings of your PC accordingly.
You cannot connect the system to your wireless LAN router.	<ul style="list-style-type: none"> • Check if the wireless LAN router is on. • Depending on the usage environment, including the wall material, radio wave reception conditions, or obstacles between the system and the wireless LAN router, the possible communication distance may be shortened. Move the system and the wireless LAN router closer to each other. • Devices that use a 2.4 GHz frequency band, such as a microwave, Bluetooth, or digital cordless device, may interrupt the communication. Move the unit away from such devices, or turn off such devices.
The desired wireless router is not detected even if [Scan] is performed.	<ul style="list-style-type: none"> • Press RETURN to return to the previous screen, and try [Scan] again. If the desired wireless router is still not detected, press RETURN to select [Manual registration].
The system cannot connect to the network or the network connection is unstable.	<ul style="list-style-type: none"> • The distance between the unit and the wireless LAN router is too far (page 20).

Playable Discs

Blu-ray Disc	BD-ROM ¹⁾ BD-R/BD-RE ²⁾
DVD³⁾	DVD-ROM DVD-R/DVD-RW DVD+R/DVD+RW
CD³⁾	CD-DA (Music CD) CD-ROM CD-R/CD-RW Super Audio CD

¹⁾Since the Blu-ray Disc specifications are new and evolving, some discs may not be playable depending on the disc type and the version. Also, the audio output differs depending on the source, connected output jack, and selected audio settings.

²⁾BD-RE: Ver.2.1

BD-R: Ver.1.1, 1.2, 1.3 including organic pigment type BD-R (LTH type)
BD-Rs recorded on a PC cannot be played if postscripts are recordable.

³⁾A CD or DVD disc will not play if it has not been correctly finalized. For more information, refer to the operating instructions supplied with the recording device.

Discs that cannot be played

- BDs with cartridge
- BDXLs
- DVD-RAMs
- HD DVDs
- DVD Audio discs
- PHOTO CDs
- Data part of CD-Extras
- Super VCDs
- Audio material side on DualDiscs
- For U.S. and Canada models: A disc recorded in a color system other than NTSC, such as PAL
(This system conforms to the NTSC color system.)

Notes on discs

This product is designed to play back discs that conform to the Compact Disc (CD) standard. DualDiscs and some music discs encoded with copyright protection technologies do not conform to the Compact Disc (CD) standard. Therefore, these discs may not be compatible with this product.

Note on playback operations of a BD/DVD

Some playback operations of a BD/DVD may be intentionally set by software producers. Since this system plays a BD/DVD according to the disc contents the software producers designed, some playback features may not be available.

Note about double-layer BDs/DVDs

The playback picture and sound may be momentarily interrupted when the layers switch.

Region code (BD-ROM/DVD VIDEO only)

Your system has a region code printed on the rear of the unit and will only play a BD-ROM/DVD VIDEO (playback only) labeled with identical region codes or .

Playable Types of Files

Video

File format	Extensions
MPEG-1 Video/PS ¹⁾	“.mpg,” “.mpeg,” “.m2ts,”
MPEG-2 Video/PS, TS ¹⁾	“.mts”
Xvid	“.avi”
MPEG4/AVC ¹⁾	“.mkv,” “.mp4,” “.m4v,” “.m2ts,” “.mts”
WMV9 ¹⁾	“.wmv,” “.asf”
AVCHD	2)

Music

File format	Extensions
MP3 (MPEG-1 Audio Layer III)	“.mp3”
AAC ¹⁾³⁾	“.m4a”
WMA9 Standard ¹⁾³⁾	“.wma”
LPCM	“.wav”

Photo

File format	Extensions
JPEG	“.jpg,” “.jpeg”
GIF	“.gif”
PNG	“.png”

¹⁾The system does not play files encoded with DRM.

²⁾The system plays AVCHD-format files that are recorded via a digital video camera, etc. To watch AVCHD-format files, the disc with AVCHD-format files on it must be finalized.

³⁾The system does not play files encoded with Lossless, etc.

Note

- Some files may not play depending on the file format, the file encoding, or the recording condition.
- Some files edited on a PC may not play.
- The system can recognize the following files or folders in BDs, DVDs, CDs and USB devices:
 - up to folders in the 5th tree
 - up to 500 files in a single tree
- Some USB devices may not work with this system.
- The system can recognize Mass Storage Class (MSC) devices (such as flash memory or an HDD), Still Image Capture Devices (SICDs), and 101-key keyboards (front  (USB) port only). (Mexican and Latin American models only.)
- To avoid data corruption or damage to USB memory or other devices, turn the system off before connecting or removing USB memory or other devices.
- The system may not play high bit rate video files from a DATA CD smoothly. It is recommended to play high bit rate video files using a DATA DVD.

Supported Audio Formats

Audio formats supported by this system are as follows.

Function	Format							
	LPCM 2ch	LPCM 5.1ch LPCM 7.1ch	Dolby Digital	Dolby TrueHD, Dolby Digital Plus	DTS	DTS-ES Discrete 6.1, DTS-ES Matrix 6.1, DTS96/24	DTS-HD High Resolution Audio	DTS-HD Master Audio
“BD/DVD”	○	○	○	○	○	○	○	○
“HDMI1” “HDMI2”	○	–	○	–	○	–	–	–
“TV” (DIGITAL IN)	○	–	○	–	○	–	–	–

○: Supported format.

–: Unsupported format.

Note

- HDMI (IN 1) and HDMI (IN 2) do not input sound in the case of an audio format that contains copy protections such as Super Audio CD or DVD-Audio.
- For the LPCM 2ch format, the supported sampling frequency of the digital signal is up to 96 kHz when using the “HDMI1” or “HDMI2” function, and 48 kHz when using the “TV” function.

Specifications

Amplifier Section

U.S. models:

AUDIO POWER SPECIFICATIONS

POWER OUTPUT AND TOTAL HARMONIC

DISTORTION:

(FTC)

Front L + Front R: With 3 ohms loads, both channels driven, from 180 - 20,000 Hz; rated 60 watts per channel minimum RMS power, with no more than 1% total harmonic distortion from 250 milli watts to rated output.

Other models:

POWER OUTPUT (rated)

Front L/Front R: 108 W + 108 W (at 3 ohms, 1 kHz, 1% THD)

POWER OUTPUT (reference)

Front L/Front R/Center/Surround L/Surround R:

167 W (per channel at 3 ohms, 1 kHz)

Subwoofer: 165 W (at 3 ohms, 80 Hz)

Inputs (Analog)

AUDIO (AUDIO IN) Sensitivity: 450/250 mV

Inputs (Digital)

TV (Audio Return Channel/OPTICAL)

Supported formats: LPCM 2CH (up to 48 kHz), Dolby Digital, DTS

HDMI (IN 1)/HDMI (IN 2)

Supported formats: LPCM 2CH (up to 96 kHz), Dolby Digital, DTS

Video Section

Outputs VIDEO: 1 V_{p-p} 75 ohms

HDMI Section

Connector Type A (19pin)

BD/DVD/Super Audio CD/CD System

Signal format system

U.S. and Canada models: NTSC

Other models: NTSC/PAL

USB Section

• (USB) port: Type A (For connecting USB memory, memory card reader, digital still camera, and digital video camera)

LAN Section

LAN (100) terminal 100BASE-TX Terminal

FM Tuner Section

System PLL quartz-locked digital synthesizer

Tuning range

U.S. and Canada models: 87.5 MHz - 108.0 MHz (100 kHz step)

Other models: 87.5 MHz - 108.0 MHz (50 kHz step)

Antenna (aerial) FM wire antenna (aerial)

Antenna (aerial) terminals 75 ohms, unbalanced

Speakers

Front/Surround (SS-TSB105)

Dimensions (approx.) 85 mm × 220 mm × 95 mm (3 ³/₈ in × 8 ³/₄ in × 3 ³/₄ in) (w/h/d)

Mass (approx.) 0.6 kg (1 lb 6 oz)

Center (SS-CTB102)

Dimensions (approx.) 315 mm × 54 mm × 55 mm (12 ¹/₂ in × 2 ¹/₄ in × 2 ¹/₄ in) (w/h/d)

Mass (approx.) 0.4 kg (15 oz)

Subwoofer (SS-WSB103)

Dimensions (approx.) 260 mm × 265 mm × 270 mm (10 ¹/₄ in × 10 ¹/₂ in × 10 ³/₄ in) (w/h/d)

Mass (approx.) 6.0 kg (13 lb 4 oz)

General

Power requirements

U.S. and Canada models: 120 V AC, 60 Hz

Argentine models: 220 V - 240 V AC, 50/60 Hz

Other models: 110 V - 240 V AC, 50/60 Hz

Power consumption On: 160 W

Standby: 0.3 W (at the Power Saving mode)

Dimensions (approx.) 400 mm × 65 mm × 315 mm (15 ³/₄ in × 2 ⁵/₈ in × 12 ¹/₂ in) (w/h/d) incl. projecting parts

Mass (approx.) 3.3 kg (7 lb 5 oz)

Design and specifications are subject to change without notice.

- Standby power consumption 0.3W.
- Over 85% power efficiency of amplifier block is achieved with the full digital amplifier, S-Master.

Language Code List

The language spellings conform to the ISO 639: 1988 (E/F) standard.

Code Language	Code Language	Code Language	Code Language
1027 Afar	1183 Irish	1347 Maori	1507 Samoan
1028 Abkhazian	1186 Scots Gaelic	1349 Macedonian	1508 Shona
1032 Afrikaans	1194 Galician	1350 Malayalam	1509 Somali
1039 Amharic	1196 Guarani	1352 Mongolian	1511 Albanian
1044 Arabic	1203 Gujarati	1353 Moldavian	1512 Serbian
1045 Assamese	1209 Hausa	1356 Marathi	1513 Siswati
1051 Aymara	1217 Hindi	1357 Malay	1514 Sesotho
1052 Azerbaijani	1226 Croatian	1358 Maltese	1515 Sundanese
1053 Bashkir	1229 Hungarian	1363 Burmese	1516 Swedish
1057 Byelorussian	1233 Armenian	1365 Nauru	1517 Swahili
1059 Bulgarian	1235 Interlingua	1369 Nepali	1521 Tamil
1060 Bihari	1239 Interlingue	1376 Dutch	1525 Telugu
1061 Bislama	1245 Inupiak	1379 Norwegian	1527 Tajik
1066 Bengali;	1248 Indonesian	1393 Occitan	1528 Thai
Bangla	1253 Icelandic	1403 (Afan)Oromo	1529 Tigrinya
1067 Tibetan	1254 Italian	1408 Oriya	1531 Turkmen
1070 Breton	1257 Hebrew	1417 Punjabi	1532 Tagalog
1079 Catalan	1261 Japanese	1428 Polish	1534 Setswana
1093 Corsican	1269 Yiddish	1435 Pashto;	1535 Tonga
1097 Czech	1283 Javanese	Pushto	1538 Turkish
1103 Welsh	1287 Georgian	1436 Portuguese	1539 Tsonga
1105 Danish	1297 Kazakh	1463 Quechua	1540 Tatar
1109 German	1298 Greenlandic	1481 Rhaeto-	1543 Twi
1130 Bhutani	1299 Cambodian	Romance	1557 Ukrainian
1142 Greek	1300 Kannada	1482 Kirundi	1564 Urdu
1144 English	1301 Korean	1483 Romanian	1572 Uzbek
1145 Esperanto	1305 Kashmiri	1489 Russian	1581 Vietnamese
1149 Spanish	1307 Kurdish	1491 Kinyarwanda	1587 Volapük
1150 Estonian	1311 Kirghiz	1495 Sanskrit	1613 Wolof
1151 Basque	1313 Latin	1498 Sindhi	1632 Xhosa
1157 Persian	1326 Lingala	1501 Sangho	1665 Yoruba
1165 Finnish	1327 Laothian	1502 Serbo-Croatian	1684 Chinese
1166 Fiji	1332 Lithuanian	1503 Singhalese	1697 Zulu
1171 Faroese	1334 Latvian; Lettish	1505 Slovak	
1174 French	1345 Malagasy	1506 Slovenian	
1181 Frisian			1703 Not specified

Parental Control/Area Code List

Code Area	Code Area	Code Area	Code Area
2044 Argentina	2109 Germany	2362 Mexico	2499 Sweden
2047 Australia	2200 Greece	2376 Netherlands	2086 Switzerland
2046 Austria	2219 Hong Kong	2390 New Zealand	2543 Taiwan
2057 Belgium	2248 India	2379 Norway	2528 Thailand
2070 Brazil	2238 Indonesia	2427 Pakistan	2184 United Kingdom
2090 Chile	2239 Ireland	2424 Philippines	
2092 China	2254 Italy	2428 Poland	
2093 Colombia	2276 Japan	2436 Portugal	
2115 Denmark	2304 Korea	2489 Russia	
2165 Finland	2333 Luxembourg	2501 Singapore	
2174 France	2363 Malaysia	2149 Spain	

Index

Numerics

- 3D 27
- 3D Output Setting 48

A

- A/V SYNC 33
- Attenuate - AUDIO 49
- Audio 50
- Audio DRC 49
- Audio Output 49
- Audio Return Channel 51
- Audio Settings 49
- Auto Display 51
- Auto Standby 51

B

- BD Audio MIX Setting 49
- BD Hybrid Disc Playback Layer 50
- BD Internet Connection 50
- BD Parental Control 50
- BD/DVD Menu 50
- BD/DVD Viewing Settings 50
- BD/DVD-ROM 1080/24p Output 48
- BD-LIVE 27
- BONUSVIEW 27
- BRAVIA Internet Video 31
- BRAVIA Sync 38

C

- CD 60
- Child Lock 40
- Cinema Conversion Mode 48
- Control for HDMI 38, 51

D

- Dolby Digital 34
- DTS 34
- DVD 60
- DVD Aspect Ratio 48
- DVD Parental Control 50

E

- Easy Setup 22, 52

F

- FM Mode 36
- Front panel 8
- Front panel display 9

H

- HDMI
 - YCbCr/RGB (HDMI) 48
- HDMI Deep Color Output 49

I

- Initialize Personal Information 52
- Internet content 31
- Internet Settings 43, 51
- Internet Video Parental Control 50
- Internet Video Unrated 50

L

- Language Code List 64

M

- Multiplex broadcast sound 35
- Music Settings 51

N

- Network Connection
 - Diagnostics 51
- Network Settings 51
- Network Update 47

O

- OSD 51
- Output Video Format 48

P

- Parental Control Area Code 50
- Parental Control Settings 50
- Password 50
- Pause Mode 49
- Play information 28
- Playable discs 60

Q

- Quick Start Mode 51

R

- Rear panel 10
- Region code 60
- Remote control 11
- Reset to Factory Default Settings 52
- Resetting 52

S

- Screen Format 48
- Screen Saver 51
- Screen Settings 48
- SLEEP 40
- Slideshow 32
- Sound Effect 49
- Speaker Settings 39, 49
 - Connection 39
 - Distance 39
 - Level 39
- Subtitle 50
- Super Audio CD Playback
 - Channel 51
- Super Audio CD Playback Layer 51
- Surround Setting 49
- System Information 51

T

- Test Tone 40
- TV Screen Size Setting for 3D 48
- TV Type 48

U

- Update 47
- USB 28

W

- WEP 46
- WPA2-PSK (AES) 46
- WPA2-PSK (TKIP) 46
- WPA-PSK (AES) 46
- WPA-PSK (TKIP) 46

The software of this system may be updated in the future. To find out details on any available updates, please visit the following URL.

For customers in the U.S.:
<http://www.sony.com/support>

For customers in Canada:
English: <http://www.sony.ca/support>
French: <http://fr.sony.ca/support>

For customers in Mexico and Latin America:
<http://esupport.sony.com/LA>



<http://www.sony.net/>



* 4 2 6 5 1 6 2 1 1 * (1)