

# Blu-ray Disc/DVD Home Theatre System

**Operating Instructions**

## WARNING

Do not install the appliance in a confined space, such as a bookcase or built-in cabinet.

To reduce the risk of fire, do not cover the ventilation opening of the apparatus with newspapers, tablecloths, curtains, etc. Do not place the naked flame sources such as lighted candles on the apparatus. Do not expose batteries or apparatus with battery-installed to excessive heat such as sunshine, fire or the like.

To prevent injury, this apparatus must be securely attached to the floor/wall in accordance with the installation instructions.

Indoor use only.

## CAUTION

The use of optical instruments with this product will increase eye hazard. As the laser beam used in this Blu-ray Disc / DVD Home Theatre System is harmful to eyes, do not attempt to disassemble the cabinet.

Refer servicing to qualified personnel only.



This appliance is classified as a CLASS 3R LASER product. Visible and invisible laser radiation is emitted when the laser protective housing is opened, so be sure to avoid direct eye exposure. This marking is located on the laser protective housing inside the enclosure.

CLASS 1 LASER PRODUCT  
LUOKAN 1 LASERLAITE  
KLASS 1 LASERAPPARAT  
1类激光产品

This appliance is classified as a CLASS 1 LASER product. This marking is located on the rear exterior.

## For the customers in the U.S.A.

**To reduce the risk of fire or electric shock, do not expose this apparatus to rain or moisture.**

These following indications are located on the rear exterior.



This symbol is intended to alert the user to the presence of uninsulated “dangerous voltage” within the product’s enclosure that may be of sufficient magnitude to constitute a risk of electric shock to persons.



This symbol is intended to alert the user to the presence of important operating and maintenance (servicing) instructions in the literature accompanying the appliance.

## Owner's Record

The model and serial numbers are located on the bottom exterior of the unit. Record these numbers in the space provided below. Refer to them whenever you call upon your Sony dealer regarding this product. Model No. BDV-E580/BDV-T58 Serial No. \_\_\_\_\_

The following FCC statement applies only to the version of this model manufactured for sale in the U.S.A. Other versions may not

comply with FCC technical regulations.

## NOTE:

This equipment has been tested and found to comply with the limits for a Class B digital device, pursuant to Part 15 of the FCC Rules. These limits are designed to provide reasonable protection against harmful interference to a residential installation. This equipment generates, uses, and can radiate radio frequency energy and, if not installed and used in accordance with the instructions, may cause harmful interference to radio communications. However, there is no guarantee that interference will not occur in a particular installation. If this equipment does cause harmful interference to radio or television reception, which can be determined by turning the equipment off and on, the user is encouraged to try to correct the interference by one or more of the following measures:

- Reorient or relocate the receiving antenna (aerial).
- Increase the separation between the equipment and receiver.
- Connect the equipment into an outlet on a circuit different from that to which the receiver is connected.
- Consult the dealer or an experienced radio/TV technician for help.

## CAUTION

You are cautioned that any changes or modifications not expressly approved in this manual could void your authority to operate this equipment.

Properly shielded and grounded cables and connectors must be used for connection to host computers and/or peripherals in order to meet FCC emission limits.

## Important Safety Instructions

- 1) Read these instructions.
- 2) Keep these instructions.
- 3) Heed all warnings.
- 4) Follow all instructions.
- 5) Do not use this apparatus near water.
- 6) Clean only with dry cloth.
- 7) Do not block any ventilation openings. Install in accordance with the manufacturer's instructions.
- 8) Do not install near any heat sources such as radiators, heat registers, stoves, or other apparatus (including amplifiers) that produce heat.
- 9) Do not defeat the safety purpose of the polarized or grounding-type plug. A polarized plug has two blades with one wider than the other. A grounding type plug has two blades and a third grounding prong. The wide blade or the third prong are provided for your safety. If the provided plug does not fit into your outlet, consult an electrician for replacement of the obsolete outlet.
- 10) Protect the power cord from being walked on or pinched particularly at plugs, convenience receptacles, and the point where they exit from the apparatus.
- 11) Only use attachments/ accessories specified by the manufacturer.
- 12) Use only with the cart, stand, tripod, bracket, or table specified by the manufacturer, or sold with the apparatus. When a cart is used, use caution when moving the cart/ apparatus combination to avoid injury from tip-over.



- 13) Unplug this apparatus during lightning storms or when unused for long periods of time.
- 14) Refer all servicing to qualified service personnel. Servicing is required when the apparatus has been damaged in any way, such as power-supply cord or plug is damaged, liquid has been spilled or objects have fallen into the apparatus, the apparatus has been exposed to rain or moisture, does not operate normally, or has been dropped.

The nameplate and the date of manufacture marking are located on the bottom exterior.

### For the customers in Mexico and Latin America

To reduce the risk of fire or electric shock, do not expose this apparatus to dripping or splashing, and do not place objects filled with liquids, such as vases, on the apparatus.

The nameplate is located on the bottom exterior.

### Precautions

#### On power sources

- The unit is not disconnected from the mains as long as it is connected to the AC outlet, even if the unit itself has been turned off.
- As the main plug is used to disconnect the unit from the mains, connect the unit to an easily accessible AC outlet. Should you notice an abnormality in the unit, disconnect the main plug from the AC outlet immediately.

### On watching 3D video images

Some people may experience discomfort (such as eye strain, fatigue, or nausea) while watching 3D video images. Sony

recommends that all viewers take regular breaks while watching 3D video images. The length and frequency of necessary breaks will vary from person to person. You must decide what works best. If you experience any discomfort, you should stop watching the 3D video images until the discomfort ends; consult a doctor if you believe necessary. You should also review (i) the instruction manual and/or the caution message of any other device used with, or Blu-ray Disc contents played with this product and (ii) our website (<http://esupport.sony.com/>) for the latest information. The vision of young children (especially those under six years old) is still under development. Consult your doctor (such as a pediatrician or eye doctor) before allowing young children to watch 3D video images. Adults should supervise young children to ensure they follow the recommendations listed above.

### For the Blu-ray Disc/DVD receiver (HBD-E580/HBD-T58) (For the customers in the U.S.A.)

This equipment must not be co-located or operated in conjunction with any other antenna or transmitter.

This equipment complies with FCC radiation exposure limits set forth for an uncontrolled environment and meets the FCC radio frequency (RF) Exposure Guidelines in Supplement C to OET65.

This equipment should be installed and operated keeping the radiator at least 20cm or more away from person's body (excluding extremities: hands, wrists, feet and ankles).

## Copy Protection

Please be advised of the advanced content protection systems used in both Blu-ray Disc™ and DVD media. These systems, called AACS (Advanced Access Content System) and CSS (Content Scramble System), may contain some restrictions on playback, analog output, and other similar features. The operation of this product and the restrictions placed may vary depending on the date of purchase, as the governing board of the AACS may adopt or change its restriction rules after the time of purchase.

## Copyrights and Trademarks

- This system incorporates with Dolby® Digital and Dolby Pro Logic (II) adaptive matrix surround decoder and the DTS\*\* Digital Surround System.
  - \* Manufactured under license from Dolby Laboratories. Dolby, Pro Logic, and the double-D symbol are trademarks of Dolby Laboratories.
  - \*\* Manufactured under license under U.S. Patent #'s: 5,451,942; 5,956,674; 5,974,380; 5,978,762; 6,226,616; 6,487,535; 7,212,872; 7,333,929; 7,392,195; 7,272,567 & other U.S. and worldwide patents issued & pending. DTS, DTS-HD and the Symbol are registered trademarks, & DTS-HD Master Audio, and the DTS logos are trademarks of DTS, Inc. Product includes software. © DTS, Inc. All Rights Reserved.
- This system incorporates High-Definition Multimedia Interface (HDMI™) technology. HDMI, the HDMI logo and High-Definition Multimedia Interface are trademarks or registered trademarks of HDMI Licensing

- LLC in the United States and other countries.
- Java is a trademark of Oracle and/or its affiliates.
- “BD-LIVE” and “BONUSVIEW” are trademarks of Blu-ray Disc Association.
- “Blu-ray Disc” is a trademark.
- “Blu-ray Disc,” “DVD+RW,” “DVD-RW,” “DVD+R,” “DVD-R,” “DVD VIDEO,” and “CD” logos are trademarks.
- “Blu-ray 3D” and “Blu-ray 3D” logo are trademarks of Blu-ray Disc Association.
- “BRAVIA” is a trademark of Sony Corporation.
- “AVCHD” and the “AVCHD” logo are trademarks of Panasonic Corporation and Sony Corporation.
- “XMB,” “XMB,” and “xross media bar” are trademarks of Sony Corporation and Sony Computer Entertainment Inc.
- “PLAYSTATION” is a trademark of Sony Computer Entertainment Inc.
- Music and video recognition technology and related data are provided by Gracenote®. Gracenote is the industry standard in music recognition technology and related content delivery. For more information, please visit [www.gracenote.com](http://www.gracenote.com). CD, DVD, Blu-ray Disc, and music and video-related data from Gracenote, Inc., copyright © 2000-present Gracenote. Gracenote Software, copyright © 2000-present Gracenote. One or more patents owned by Gracenote apply to this product and service. See the Gracenote website for a nonexhaustive list of applicable Gracenote patents. Gracenote, CDDB, MusicID, MediaVOCS, the Gracenote logo and logotype, and the “Powered by Gracenote” logo are either registered trademarks or trademarks of Gracenote in the United States and/or other countries.



- The Wi-Fi CERTIFIED™ Logo is a certification mark of the Wi-Fi Alliance.
- The Wi-Fi Protected Setup™ Mark is a mark of the Wi-Fi Alliance.
- “Wi-Fi CERTIFIED™” and “Wi-Fi Protected Setup™” are trademarks of the Wi-Fi Alliance.
- “PhotoTV HD” and the “PhotoTV HD” logo are trademarks of Sony Corporation.
- MPEG Layer-3 audio coding technology and patents licensed from Fraunhofer IIS and Thomson.
- iPhone, iPod, iPod classic, iPod nano, and iPod touch are trademarks of Apple Inc., registered in the U.S. and other countries.



- “Made for iPod,” and “Made for iPhone” mean that an electronic accessory has been designed to connect specifically to iPod or iPhone, respectively, and has been certified by the developer to meet Apple performance standards. Apple is not responsible for the operation of this device or its compliance with safety and regulatory standards. Please note that the use of this accessory with iPod or iPhone may affect wireless performance.
- Windows Media is either a registered trademark or trademark of Microsoft Corporation in the United States and/or other countries. This product contains technology subject to certain intellectual property rights of Microsoft. Use or distribution of this technology outside of this product is prohibited without the appropriate

license(s) from Microsoft. Content owners use Microsoft PlayReady™ content access technology to protect their intellectual property, including copyrighted content. This device uses PlayReady technology to access PlayReady-protected content and/or WMDRM-protected content. If the device fails to properly enforce restrictions on content usage, content owners may require Microsoft to revoke the device's ability to consume PlayReady-protected content. Revocation should not affect unprotected content or content protected by other content access technologies. Content owners may require you to upgrade PlayReady to access their content. If you decline an upgrade, you will not be able to access content that requires the upgrade.

- DLNA®, the DLNA Logo and DLNA CERTIFIED™ are trademarks, service marks, or certification marks of the Digital Living Network Alliance.
- All other trademarks are trademarks of their respective owners.
- Other system and product names are generally trademarks or registered trademarks of the manufacturers. ™ and ® marks are not indicated in this document.

---

## About These Operating Instructions

- The instructions in these Operating Instructions describe the controls on the remote. You can also use the controls on the unit if they have the same or similar names as those on the remote.
- In this manual, “disc” is used as a general reference for BDs, DVDs, Super Audio CDs, or CDs unless otherwise specified by the text or illustrations.
- The instructions in this manual are for BDV-E580, BDV-E880, BDV-E980, and BDV-T58. BDV-E580 is the model used for illustration purposes. Any difference in operation is clearly indicated in the text, for example, “BDV-E580 only.”
- Some illustrations are presented as conceptual drawings, and may be different from the actual products.
- The items displayed on the TV screen may vary depending on the area.
- The default setting is underlined.

# Table of Contents

About These Operating Instructions .....	5	Browsing Websites .....	52
Unpacking .....	7	Setting up the Network .....	53
Index to Parts and Control .....	11		
<b>Getting Started</b>		<b>Settings and Adjustments</b>	
<b>Step 1: Installing the System</b> .....	16	Using the Setup Display .....	57
<b>Step 2: Connecting the System</b> ...	20	[Network Update] .....	57
<b>Step 3: Connecting to the</b>		[Screen Settings] .....	58
<b>Network</b> .....	27	[Audio Settings] .....	59
<b>Step 4: Performing the Easy</b>		[BD/DVD Viewing Settings] .....	60
<b>Setup</b> .....	29	[Parental Control Settings] .....	61
<b>Step 5: Selecting the Source</b> .....	30	[Music Settings] .....	61
<b>Step 6: Enjoying Surround</b>		[System Settings] .....	61
<b>Sound</b> .....	31	[Network Settings] .....	62
		[Easy Setup] .....	63
		[Resetting] .....	63
<b>Playback</b>		<b>Additional Information</b>	
Playing a Disc .....	34	Precautions .....	64
Playing from a USB Device .....	35	Notes about the Discs .....	65
Enjoying an iPod/iPhone .....	36	Troubleshooting .....	66
Playing via a Network .....	38	Playable Discs .....	71
Available Options .....	41	Playable Types of Files .....	72
		Supported Audio Formats .....	73
<b>Sound Adjustment</b>		Specifications .....	74
Selecting the Effect to Suit		Language Code List .....	76
the Source .....	43	Index .....	77
Selecting the Audio Format, Multilingual			
Tracks, or Channel .....	43		
Enjoying Multiplex Broadcast			
Sound .....	44		
<b>Tuner</b>			
Listening to the Radio .....	45		
<b>Other Operations</b>			
Using the Control for HDMI Function for			
“BRAVIA” Sync .....	47		
Calibrating the Appropriate Settings			
Automatically .....	48		
Setting the Speakers .....	49		
Using the Sleep Timer .....	50		
Deactivating the Buttons on			
the Unit .....	51		
Controlling Your TV with the Supplied			
Remote .....	51		
Changing the Brightness of the Front			
Panel Display .....	51		
Saving Power in Standby Mode .....	51		

# Unpacking

## BDV-E580/BDV-T58

- Front speakers (2)

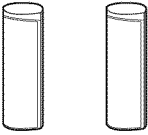

- Surround speakers (2)

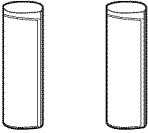

- Center speaker (1)



- Subwoofer (1)

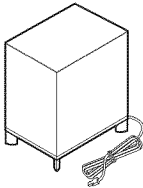

- Speaker cords (5, red/white/green/gray/blue)

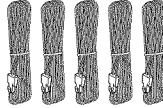

- FM wire antenna (aerial) (1)

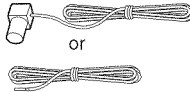

- Video cord (1)



- Remote commander (remote) (1)

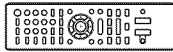

- R6 (size AA) batteries (2)



- Calibration mic (1)



- HDMI cable (1) (BDV-T58 only)

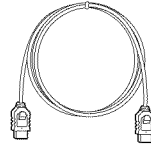

- Dock for iPod/iPhone (TDM-iP30) (1)

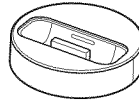

- USB cable (1)

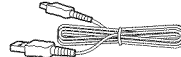

- Operating Instructions
- Quick Setup Guide
- Speaker Installation Guide
- Software License Information
- Easy Setup Disc (DVD)

# BDV-E880

- Front speakers (2)

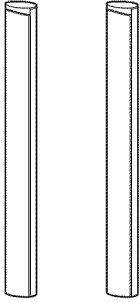

- Surround speakers (2)

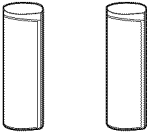

- Center speaker (1)



- Subwoofer (1)

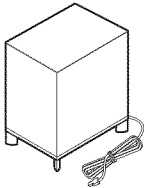

- Speaker cords (5, red/white/green/gray/blue)

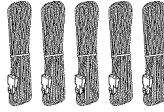

- Speaker-bottom covers (2)

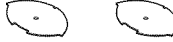

- Bases (2)



- Lower parts of the front speakers (2)

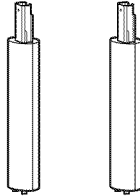

- Screws (silver) (2)



- Screws (black) (6)



- FM wire antenna (aerial) (1)

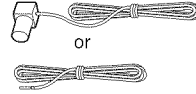

- Remote commander (remote) (1)

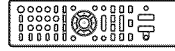

- R6 (size AA) batteries (2)



- Calibration mic (1)



- HDMI cable (1)

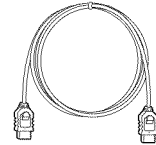

- Operating Instructions
- Quick Setup Guide
- Speaker Installation Guide
- Software License Information



# BDV-E980

- Front speakers (2)

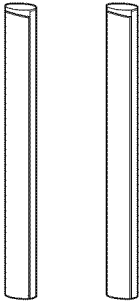

- Surround speakers (2)

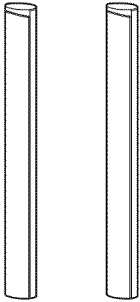

- Center speaker (1)



- Subwoofer (1)

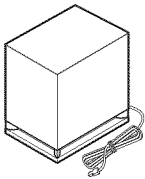

- Speaker cords (5, red/white/green/gray/blue)

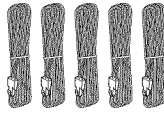

- Speaker-bottom covers (4)



- Bases (4)

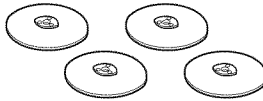

- Lower parts of the front and surround speakers (4)

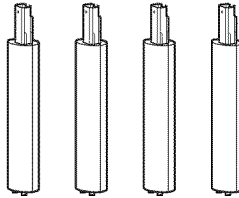

- Screws (silver) (4)

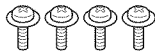

- Screws (black) (12)



- FM wire antenna (aerial) (1)

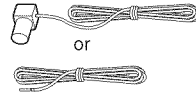

or



- Remote commander (remote) (1)

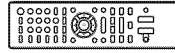

- R6 (size AA) batteries (2)



- Calibration mic (1)



- HDMI cable (1)

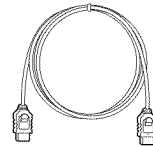

- Operating Instructions
- Quick Setup Guide
- Speaker Installation Guide
- Software License Information

## Preparing the remote

Insert two R6 (size AA) batteries (supplied) by matching the ⊕ and ⊖ ends on the batteries to the markings inside the compartment.

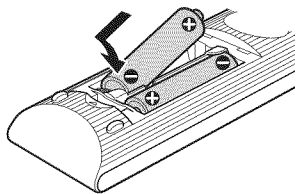

# Index to Parts and Control

For more information, refer to the pages indicated in parentheses.

## Front panel

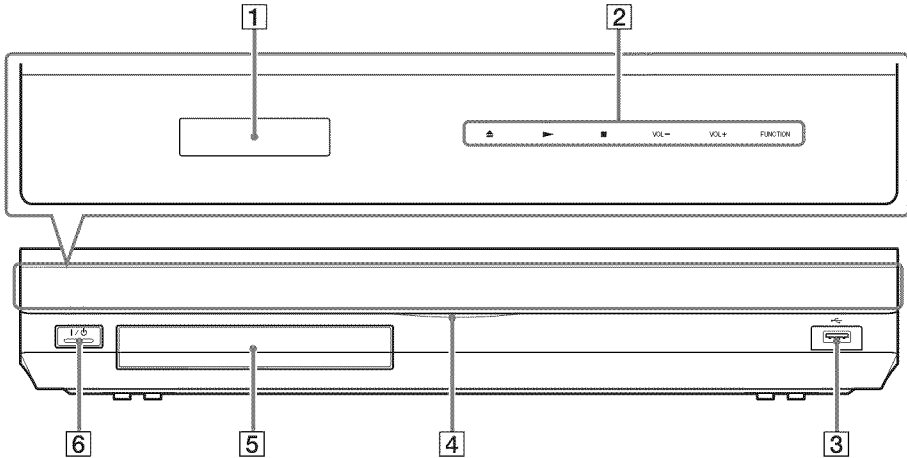

**1 Front panel display**

**2 Soft-touch buttons/indicators**

**▲ (open/close) (page 34)**

Opens or closes the disc tray.

**▶ (play)**

Starts or re-starts playback (resume play).  
Plays a slideshow when a disc containing JPEG image files is inserted.

**■ (stop)**

Stops playback and remembers the stop point (resume point).  
The resume point for a title/track is the last point you played or the last photo for a photo folder.

**VOL +/-**

Adjusts the system's volume.

**FUNCTION**

Selects the playback source.

**3  (USB) port (page 35)**

Used for connecting a USB device.

**4 Power indicator**

Lights up while the system is turned on.

**5 Disc tray (page 34)**

**6  (on/standby)/Remote sensor**

Turns on the unit, or sets it to standby mode.

### About soft-touch buttons/indicators

These buttons function when the soft-touch button indicators are lit.

You can turn on/off the indicators by setting [Illumination/Display] (page 61). When you set [Illumination/Display] to [Simple/Off], the indicators turn off. In this case, touch any soft-touch button. When the indicators light up, touch the desired button.

**Note**

- These buttons work when you touch them lightly. Do not press on them with excessive force.

## Front panel display

### About the indications in the front panel display

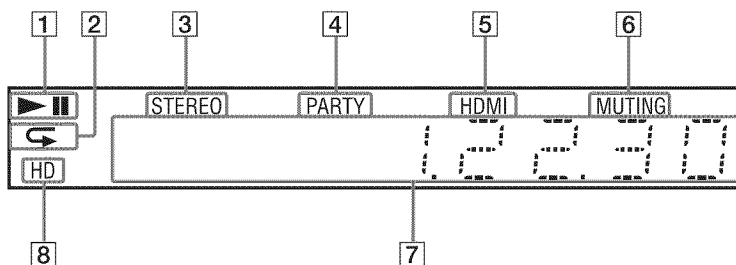

- 1 Displays the system's playing status.
- 2 Lights up when repeat play is activated.
- 3 Lights up when stereo sound is received. (Radio only)
- 4 Lights up when the system is playing via the PARTY STREAMING function.
- 5 Lights up when the HDMI (OUT) jack is correctly connected to an HDCP (High-bandwidth Digital Content Protection)-compliant device with HDMI or DVI (Digital Visual Interface) input.
- 6 Lights up when muting is on.
- 7 Displays the system's status, such as radio frequency, etc.
- 8 Lights up when outputting 720p/1080i/1080p video signals from the HDMI (OUT) jack or 720p/1080i video signals from the COMPONENT VIDEO OUT jacks.

# Rear panel

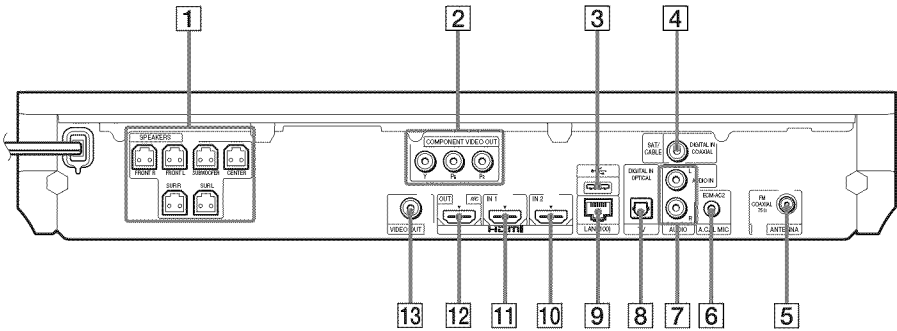

- |   |   |
|---|---|
| <b>1</b> SPEAKERS jacks (page 20)   | <b>7</b> AUDIO (AUDIO IN L/R) jacks (page 24)   |
| <b>2</b> COMPONENT VIDEO OUT jacks (page 22)  | <b>8</b> TV (DIGITAL IN OPTICAL) jack (page 22) |
| <b>3</b>  (USB) port (page 35) | <b>9</b> LAN (100) terminal (page 27)           |
| <b>4</b> SAT/CABLE (DIGITAL IN COAXIAL) jack (page 24)  | <b>10</b> HDMI (IN 2) jack (page 24)            |
| <b>5</b> ANTENNA (FM COAXIAL 75Ω) jack (page 26)  | <b>11</b> HDMI (IN 1) jack (page 24)            |
| <b>6</b> A.CAL MIC jack (pages 29, 48)  | <b>12</b> HDMI (OUT) jack (page 22)             |
|   | <b>13</b> VIDEO OUT jack (page 22)              |

## Remote control

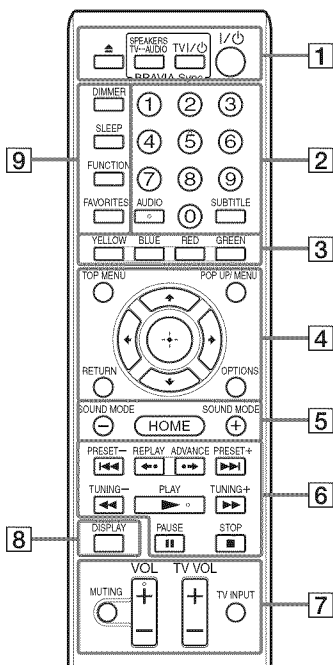

Number 5, AUDIO, VOL +, and ► buttons have a tactile dot. Use the tactile dot as a reference when operating the remote.

- **TV** : For TV operations  
(For details, see “Controlling Your TV with the Supplied Remote” (page 51).)

### 1 ▲ (open/close)

Opens or closes the disc tray.

### SPEAKERS TV ↔ AUDIO

Selects whether TV sound is output from the system’s speakers or the TV’s speaker(s). This function works only when you set [Control for HDMI] to [On] (page 61).

### TV I/O (on/standby) (page 51) **TV**

Turns on the TV or sets it to standby mode.

### I/O (on/standby) (pages 29, 45)

Turns on the system or sets it to standby mode.

### 2 Number buttons (pages 46, 51)

Enters the title/chapter numbers, preset station number, etc.

### AUDIO (pages 43, 44)

Selects the audio format/track.

### SUBTITLE (page 60)

Selects the subtitle language when multilingual subtitles are recorded on a BD-ROM/DVD VIDEO.

### 3 Color buttons (yellow/blue/red/green)

Short cut keys for selecting items on some BD menus (can also be used for Java interactive operations on BDs).

### 4 TOP MENU

Opens or closes the BD’s or DVD’s Top Menu.

### POP UP/MENU

Opens or closes the BD-ROM’s Pop-up Menu, or the DVD’s menu.

### OPTIONS (pages 31, 41, 52)

Displays the options menu on the TV screen or in the front panel display. (The location differs based on the selected function.)

### RETURN

Returns to the previous display.



Moves the highlight to a displayed item.

### ↵ (enter)

Enters the selected item.

### 5 SOUND MODE +/- (page 43)

Selects the sound mode.

### HOME (pages 29, 45, 48, 49, 52, 53, 57)

Enters or exits the system’s home menu.

## 6 Playback operation buttons

See “Playback” (page 34).

### ◀◀/▶▶ (previous/next)

Skip to the previous/next chapter, track, or file.

### ◀••/••▶ (replay/advance)

Briefly replay the current scenes for 10 seconds./Briefly fast forwards the current scenes for 15 seconds.

### ◀◀/▶▶ (fast/slow/freeze frame)

Fast reverse/fast forward the disc during playback. Each time you press the button, the search speed changes.

Activates slow-motion play when pressed for more than one second in pause mode.

Plays one frame at a time when pressed in pause mode.

Slow-motion and single-frame playback are not available for Blu-ray 3D Discs.

### ▶ (play)

Starts or re-starts playback (resume play).

Activates One-Touch Play (page 47) when the system is on and set to the “BD/DVD” function.

### ⏸ (pause)

Pauses or re-starts playback.

### ■ (stop)

Stops playback and remembers the stop point (resume point). The resume point for a title/track is the last point you played or the last photo for a photo folder.

## Radio operation buttons

See “Tuner” (page 45).

### PRESET +/-

### TUNING +/-

## 7 MUTING

Turns off the sound temporarily.

### VOL +/- (page 45)

Adjusts the volume.

### TV VOL +/- TV

Adjusts the TV volume.

### TV INPUT TV

Switches the TV’s input source between the TV and other input sources.

## 8 DISPLAY (pages 34, 38, 52)

Displays playback and web browsing information on the TV screen.

Displays the preset radio station, frequency, etc., in the front panel display.

Displays the stream information/decoding status in the front panel display when the function is set to other than “BD/DVD,” “FM,” and “AUDIO.” When the system is set to the “HDMI1,” “HDMI2,” “TV,” or “SAT/CABLE” function, the stream information/decoding status appears only when a digital signal is input.

The stream information/decoding status may not appear depending on the stream or item being decoded.

## 9 DIMMER (page 51)

Changes the brightness of the front panel display.

### SLEEP (page 50)

Sets the sleep timer.

### FUNCTION (pages 30, 45)

Selects the playback source.

### FAVORITES

Displays the Internet contents added to the Favorites List. You can save 18 favorite Internet contents.

## Getting Started

## Step 1: Installing the System

### How to position the system

Install the system by referring to the illustration below.

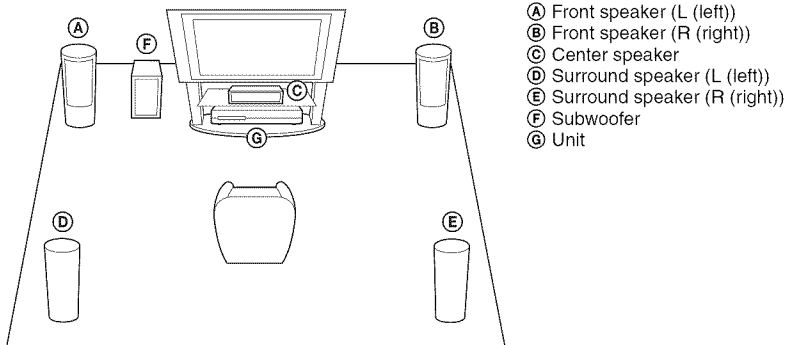

- Ⓐ Front speaker (L (left))
- Ⓑ Front speaker (R (right))
- Ⓒ Center speaker
- Ⓓ Surround speaker (L (left))
- Ⓔ Surround speaker (R (right))
- Ⓕ Subwoofer
- Ⓖ Unit

#### Note

- Use caution when placing the speakers and/or speaker stands attached to the speakers on a specially treated (waxed, oiled, polished, etc.) floor, as staining or discoloration may result.
- Do not lean or hang on a speaker, as it may fall down.

#### Tip

- To assemble the speakers, refer to the supplied "Speaker Installation Guide." (BDV-E880/BDV-E980 only)
- You can install the speakers on a wall. For details, refer to the supplied "Speaker Installation Guide."



## About the subwoofer's speaker cord

### (BDV-E980 only)

You can arrange the subwoofer's speaker cord by changing which direction it protrudes from the bottom of the subwoofer.

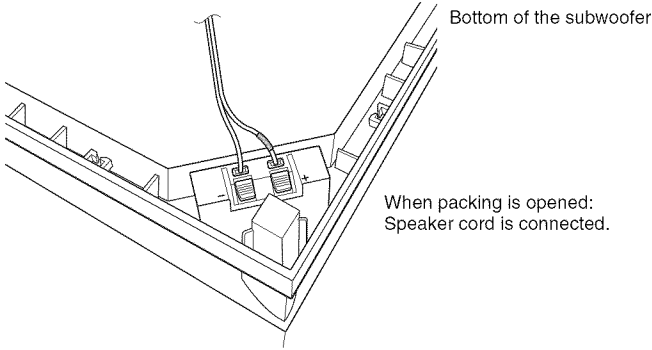

#### Note

- To avoid short-circuiting the speakers, make sure that the speaker cord connection is not like the following examples. If there is a problem, correct it.

#### Examples of an improper speaker cord connection

Stripped speaker cord is touching another speaker terminal

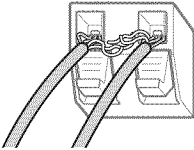

Stripped cords are touching each other due to excessive removal of insulation

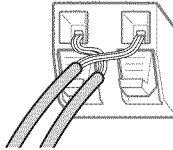

## When installing the subwoofer with the wide side facing forward

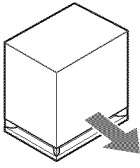

Toward the listening position

- 1** Secure the speaker cord in the speaker cord holder to the right of the speaker terminal.

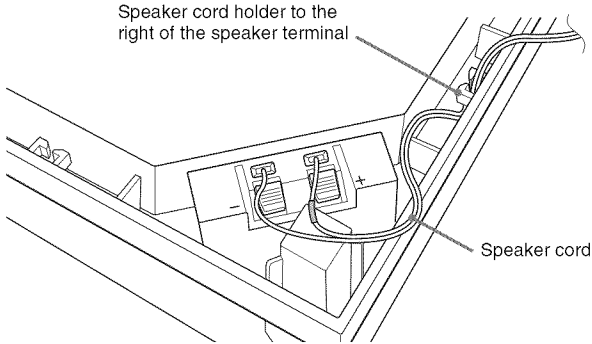

- 2** Thread the speaker cord through the gap along the side of the subwoofer.

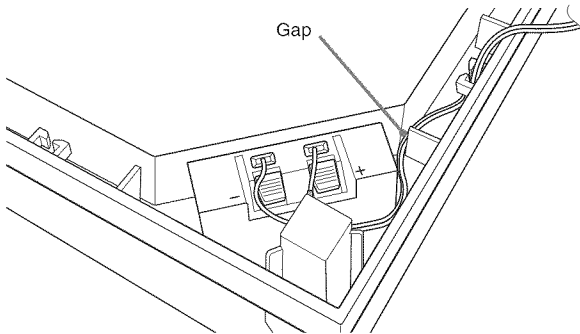

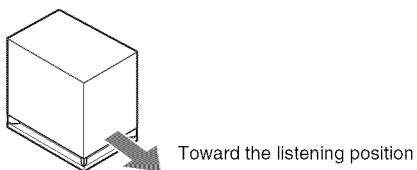
**When installing the subwoofer with the narrow side facing forward**

- 1** Secure the speaker cord in the speaker cord holder to the left of the speaker terminal.

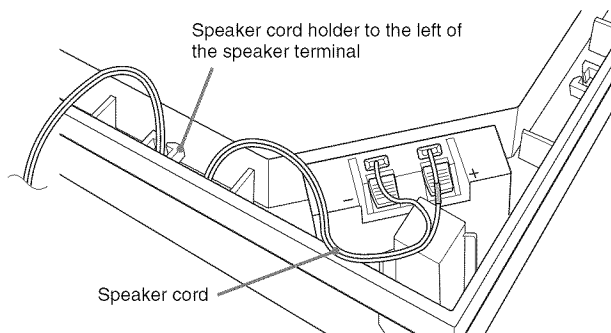

- 2** Thread the speaker cord through the gap along the side of the subwoofer.

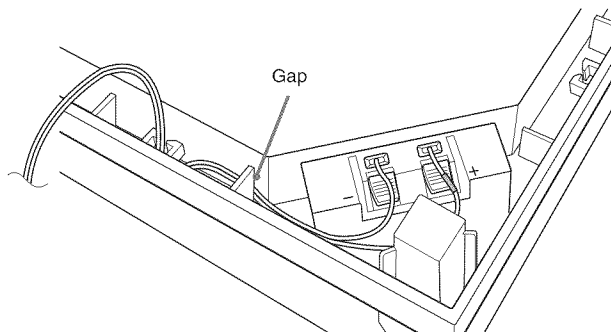

## Step 2: Connecting the System

For connecting the system, read the information on the following pages.

Do not connect the AC power cord (mains lead) of the unit to a wall outlet (mains) until all the other connections are made.

To assemble the speakers, refer to the supplied "Speaker Installation Guide." (BDV-E880/BDV-E980 only)

### Note

- When you connect another component with a volume control, turn down the volume of the other components to a level where sound is not distorted.

### Connecting the speakers

#### To connect speaker cords to the speaker

You need to connect a speaker cord to each of the front, center, and surround speakers.

The connector of the speaker cords and the color tube are color-coded based on the speaker type.

Be sure to match the speaker cords to the appropriate terminals on the speakers: the speaker cord with the color tube to  $\oplus$ , and the speaker cord without the color tube to  $\ominus$ . Do not catch the speaker cord insulation (rubber covering) in the speaker terminals.

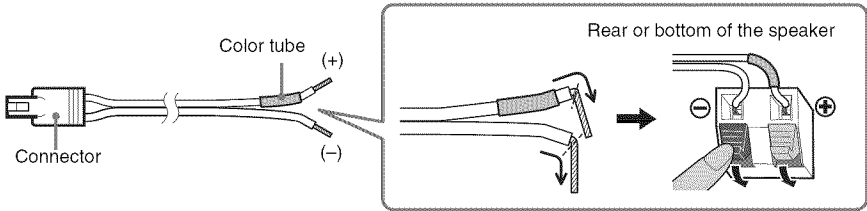

## To connect speaker cords to the unit

Connect the speaker cords to match the color of the SPEAKERS jacks of the unit.  
When connecting to the unit, insert the connector until it clicks.

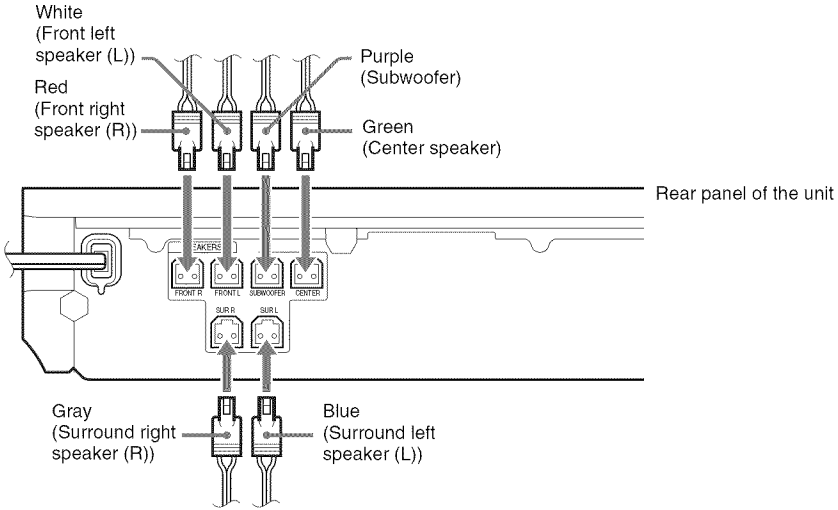

## Connecting the TV

Connect the system to your TV to display the image of the system on your TV, and listen to TV sound via the system's speakers.

Depending on the jacks and functions on your TV, select the connection method.

- When your TV has an HDMI jack that is marked "ARC<sup>1)</sup>": Connection **(A)**
- When your TV has an HDMI jack: Connections **(A)** and **(D)**
- When your TV has component video input jacks: Connections **(B)** and **(D)**
- When your TV does not have jacks above: Connections **(C)** and **(D)**

### Video connections

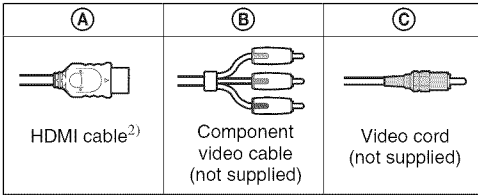

### Audio connection

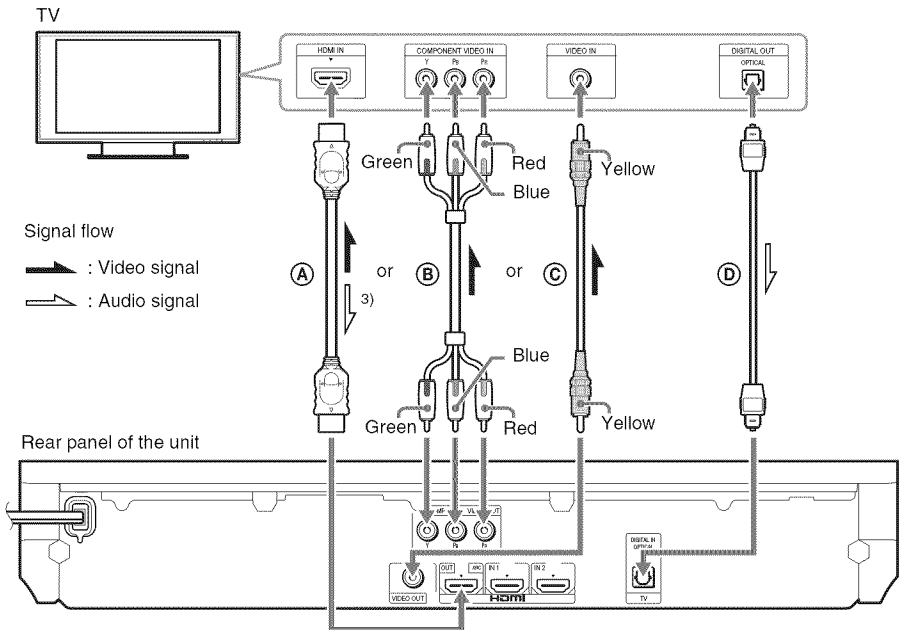
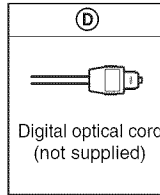

<sup>1)</sup>Audio Return Channel. For details, see "About Audio Return Channel" (page 23).

<sup>2)</sup>The HDMI cable is supplied with BDV-E880/BDV-E980/BDV-T58 only.

<sup>3)</sup>Available only when your TV is compatible with the Audio Return Channel function.

### **Ⓐ HDMI cable connection**

If your TV has an HDMI jack, connect to the TV with an HDMI cable. This will provide better image quality compared to other types of connections.

When connecting with an HDMI cable, you need to select the type of output signal when performing the Easy Setup (page 29).

For further HDMI settings, see “[HDMI Settings]” (page 61).

#### **About Audio Return Channel**

If your TV is compatible with the Audio Return Channel function, an HDMI cable connection also sends a digital audio signal from the TV. You do not need to make a separate audio connection for listening to TV sound. For setting the Audio Return Channel function, see [Audio Return Channel] (page 61).

### **Ⓑ Component video cable connection**

If your TV does not have an HDMI jack, but has component video input jacks, connect to the TV with a component video cable. Picture quality will be improved compared to using a video cord connection. When connecting with a component video cable, you need to select the type of output signal in the Easy Setup (page 29).

### **Ⓒ Video cord connection**

If your TV does not have an HDMI jack or a component video input jack, make this connection.

### **Ⓓ Digital optical cord connection**

This connection sends an audio signal to the system from the TV. To listen to TV sound via the system, perform this connection. With this connection, the system receives a Dolby Digital multiplex broadcast signal and you can enjoy multiplex broadcast sound.

#### **Note**

- You can enjoy the TV sound by selecting the “TV” function (page 30).
- If your TV does not have a digital optical output jack, you can connect the unit and your TV with an audio cord for listening to TV sound via the system. For connection details, see “Connecting the other components” (page 24).

## Connecting the other components

### When a component you wish to connect to the system has an HDMI (OUT) jack

You can connect a component that has an HDMI (OUT) jack such as a set-top box/digital satellite receiver or PLAYSTATION®3, etc., with an HDMI cable. An HDMI cable connection can send both video and audio signals. By connecting the system and the component using an HDMI cable, you can enjoy high-quality digital picture and sound via the HDMI (IN 1) or HDMI (IN 2) jack.

Rear panel of the unit

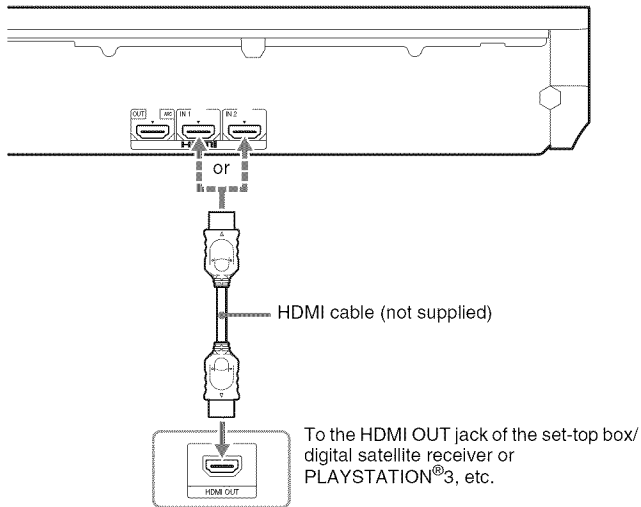

#### Note

- Video signals from the HDMI (IN 1/2) jacks are sent to the HDMI (OUT) jack only when the “HDMI1” or “HDMI2” function is selected.
- To send an audio signal from the HDMI (IN 1/2) jacks to the HDMI (OUT) jack, you may need to change the audio output setting. For details, see [Audio Output] in [Audio Settings] (page 59).



## When the component does not have an HDMI OUT jack

Connect the system so that video signals from the system and other component are sent to the TV, and audio signals from the component are sent to the system as follows.

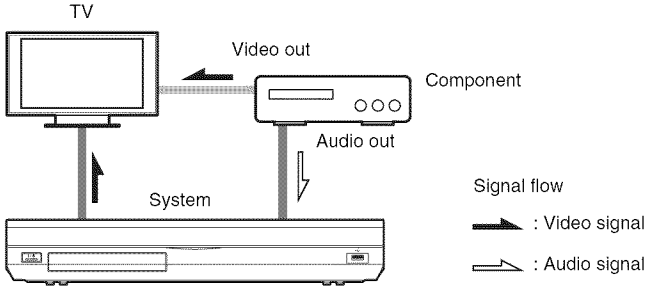

If the component plays sound only, connect the audio output of the component to the system.

Depending on the jacks on the component, select the connection method.

- Component which has a digital coaxial output jack: **A**
- Component which does not have a digital coaxial output jack: **B**

Rear panel of the unit

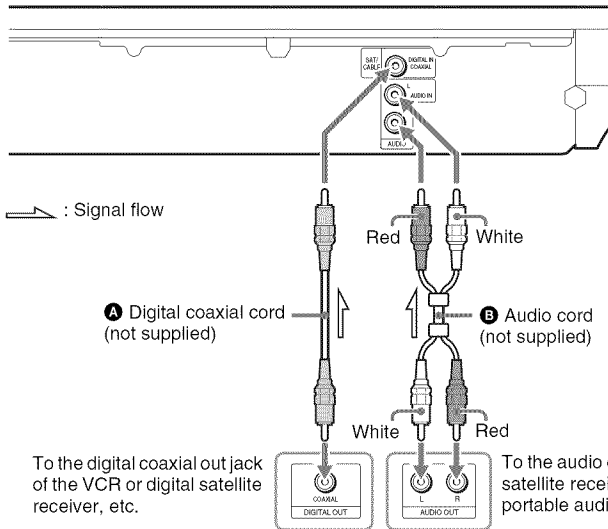

### Note

- If you make connection above, set [Control for HDMI] in [HDMI Settings] of [System Settings] to [Off] (page 61).
- You can enjoy component sound by selecting the "SAT/CABLE" function for connection **A**, or the "AUDIO" function for connection **B** (page 30).

## Connecting the antenna (aerial)

Rear panel of the unit

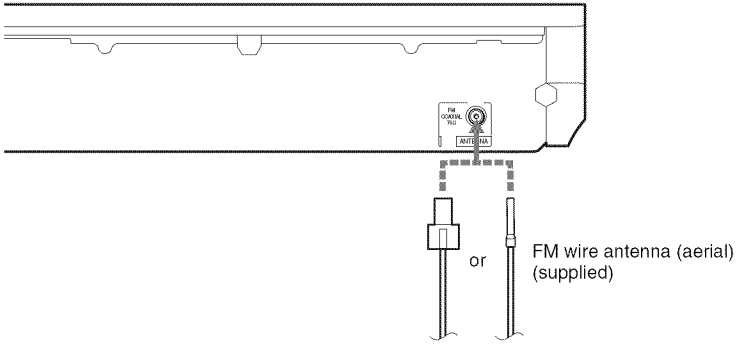

### Note

- Be sure to fully extend the FM wire antenna (aerial).
- After connecting the FM wire antenna (aerial), keep it as horizontal as possible.

### Tip

- If you have poor FM reception, use a 75-ohm coaxial cable (not supplied) to connect the unit to an outdoor FM antenna (aerial).

## Step 3: Connecting to the Network

### Note

- To connect the system to your network, you need to make network settings that suit your usage environment and components. For details, see “Setting up the Network” (page 53) and “[Network Settings]” (page 62).

### For BDV-E580/BDV-T58

Select the method based on your LAN (Local Area Network) environment.

- If you use a wireless LAN  
The system has built-in Wi-Fi, and you can connect the system to the network by making the network settings.
- If you use other than a wireless LAN  
Connect to the network by making a LAN cable connection as follows.

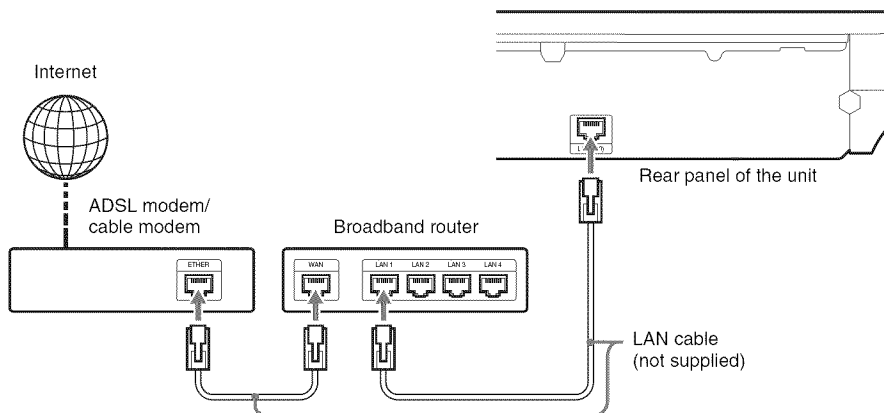

### Note

- The placement distance between the unit and your wireless LAN router differs based on your usage environment. If the system cannot connect to the network or the network connection is unstable, place the unit and the wireless LAN router closer to each other. When you cannot place the unit and the wireless LAN router closer to each other, use the optional USB Wireless LAN Adapter (Sony UWA-BR100\* only).
- To connect to a wireless LAN using a 5 GHz frequency band, you need the optional USB Wireless LAN Adapter (Sony UWA-BR100\* only).
  - \* As of November 2010. The USB Wireless LAN Adapter may not be available in some regions/countries.
- You can also get information for network settings from the following Sony support page:

For customers in the U.S.:  
<http://www.sony.com/support>

For customers in Canada:  
 English: <http://www.sony.ca/support>  
 French: <http://fr.sony.ca/support>

For customers in Mexico and Latin America:  
<http://esupport.sony.com/LA>

## For other models

Select the method based on your LAN (Local Area Network) environment.

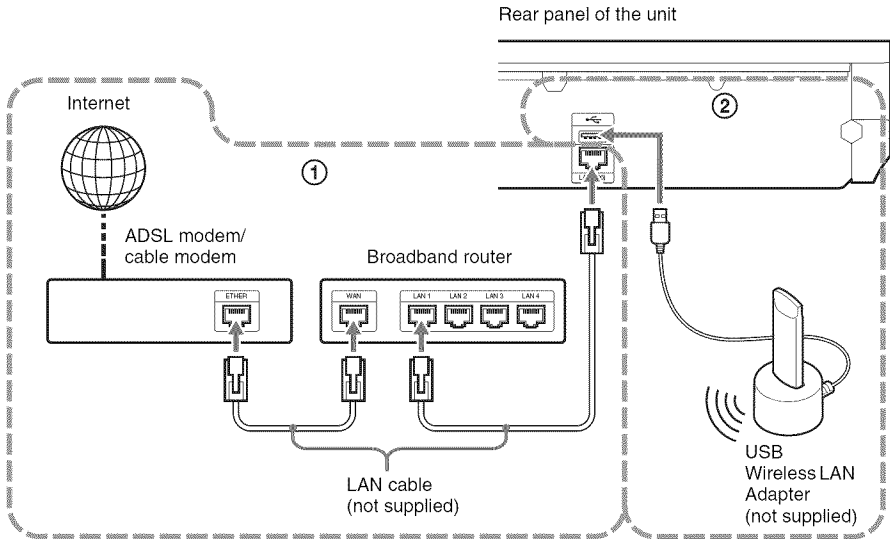

### ① Wired Setup

Use a LAN cable to connect to the LAN (100) terminal on the unit.

### ② USB Wireless Setup

Use a wireless LAN via the USB Wireless LAN Adapter (Sony UWA-BR100\* only). The USB Wireless LAN Adapter may not be available in some regions/countries.

\* As of November 2010.

Turn the unit off before connecting the extension cable or inserting the USB Wireless LAN Adapter. After inserting the USB Wireless LAN Adapter to the base and connecting the extension cable to the  (USB) port (front or rear), turn the unit on again.

#### Note

- The placement distance between the USB Wireless LAN Adapter and your wireless LAN router differs based on your usage environment. If the system cannot connect to the network or the network connection is unstable, move the USB Wireless LAN Adapter to a different position or place the USB Wireless LAN Adapter and the wireless LAN router closer to each other.
- You can also get information for network settings from the following Sony support page:

For customers in the U.S.:  
<http://www.sony.com/support>

For customers in Canada:  
 English: <http://www.sony.ca/support>  
 French: <http://fr.sony.ca/support>

For customers in Mexico and Latin America:  
<http://esupport.sony.com/LA>

## Step 4: Performing the Easy Setup

### Before performing Step 4

Make sure all connections are secure, and then connect the AC power cord (mains lead).

Follow the Steps below to make the basic adjustments for using the system.

Displayed items vary depending on the country model.

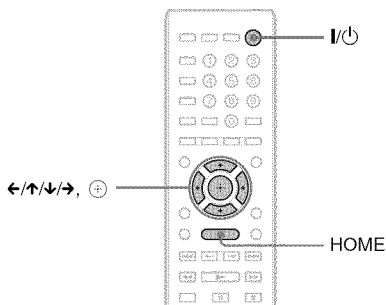

- 1 Turn on the TV.

- 2 Connect the calibration mic to the A.CAL MIC jack on the rear panel.

Set up the calibration mic at ear level using a tripod, etc. (not supplied). The front of each speaker should face the calibration mic, and there should be no obstruction between the speakers and the calibration mic.

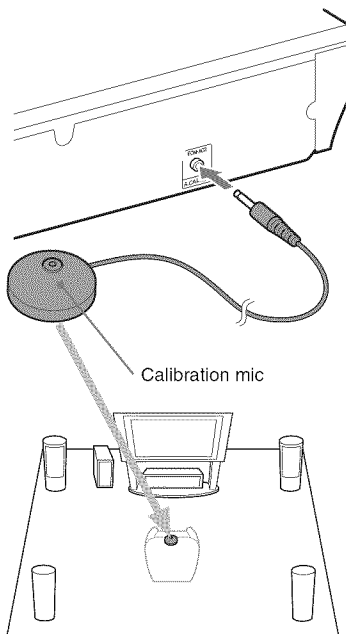

- 3 Press I/⏻.
- 4 Switch the input selector on your TV so that the signal from the system appears on the TV screen.

The Easy Setup Display for OSD language selection appears.

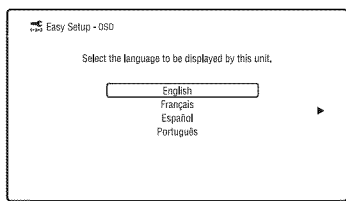

- 5** Perform the [Easy Setup]. Follow the on-screen instructions to make the basic settings using  $\leftarrow/\uparrow/\downarrow/\rightarrow$ , and  $\oplus$ .

Depending on the connection method (page 22), perform the following setting.

- **HDMI cable connection:** Follow the instructions that are displayed on the TV screen.
- **Component video cable connection:** Select the picture quality. The available settings are as follows, from lowest to highest picture quality: 480i\*, 480p\*\*, 720p, and 1080i.
  - \* 480i/576i for Mexican and Latin American models.
  - \*\* 480p/576p for Mexican and Latin American models.

**Note**

- BD-ROM playback of protected content via component video output is only supported at 480i\* output resolution. For details, see “Copy Protection” (page 4).
  - \* 480i/576i for Mexican and Latin American models.
- Video cord connection: Select [16:9] or [4:3] so that the picture is displayed correctly.

For details about [Auto Calibration] settings in [Easy Setup], see “Calibrating the Appropriate Settings Automatically” (page 48).

**To recall the Easy Setup Display**

- 1 Press HOME.**  
The home menu appears on the TV screen.
- 2 Press  $\leftarrow/\rightarrow$  to select  [Setup].**
- 3 Press  $\uparrow/\downarrow$  to select [Easy Setup], then press  $\oplus$ .**
- 4 Press  $\leftarrow/\rightarrow$  to select [Start], then press  $\oplus$ .**  
The Easy Setup Display appears.

## Step 5: Selecting the Source

You can select the playback source.

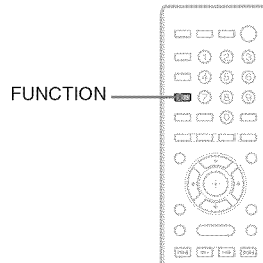

**Press FUNCTION repeatedly until the desired function appears in the front panel display.**

Each time you press FUNCTION, the function changes as follows.

“BD/DVD”  $\rightarrow$  “FM”  $\rightarrow$  “HDMI1”  $\rightarrow$   
 “HDMI2”  $\rightarrow$  “TV”  $\rightarrow$  “SAT/CABLE”  $\rightarrow$   
 “AUDIO”  $\rightarrow$  “BD/DVD”  $\rightarrow$  ...

Function	Source
“BD/DVD”	Disc, USB device, iPod/iPhone, or network device to be played by the system
“FM”	FM radio (page 45)
“HDMI1”/ “HDMI2”	Component that is connected to the HDMI (IN 1) or HDMI (IN 2) jack on the rear panel (page 24)
“TV”	Component (TV, etc.) that is connected to the TV (DIGITAL IN OPTICAL) jack on the rear panel, or a TV compatible with the Audio Return Channel function that is connected to the HDMI (OUT) jack on the rear panel (page 22)
“SAT/CABLE”	Component that is connected to the SAT/CABLE (DIGITAL IN COAXIAL) jack on the rear panel (page 24)
“AUDIO”	Component that is connected to the AUDIO (AUDIO IN L/R) jacks on the rear panel (page 24)

## Step 6: Enjoying Surround Sound

After performing the previous Steps and starting playback, you can easily enjoy surround sound. You can also select pre-programmed surround settings that are tailored to different kinds of sound sources. They bring the exciting and powerful sound of movie theaters into your home.

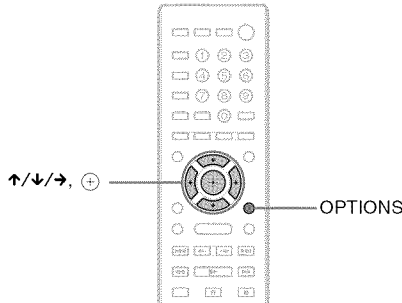

### Selecting surround settings based on your listening preference

The setting method differs depending on the function.

#### When playing via the “BD/DVD”<sup>\*</sup> or “FM” function

- 1** Press **OPTIONS**.  
The option menu appears on the TV screen.
- 2** Press **↑/↓** to select [Surround Setting], then press **⊕**.
- 3** Press **↑/↓** repeatedly until the surround setting you want appears on the TV screen.  
See the table below for surround sound setting descriptions.
- 4** Press **⊕**.  
The setting is made.

<sup>\*</sup> Surround sound settings do not apply to Internet content.

#### When playing via the “HDMI1,” “HDMI2,” “TV,” “SAT/CABLE,” or “AUDIO” function

- 1** Press **OPTIONS**.  
The option menu appears in the front panel display.
- 2** Press **↑/↓** repeatedly until “SUR. SET” appears in the front panel display, then press **⊕** or **→**.
- 3** Press **↑/↓** repeatedly until the surround setting you want appears in the front panel display.  
See the table below for surround sound setting descriptions.
- 4** Press **⊕**.  
The setting is made.

## 5 Press **OPTIONS**.

The option menu in the front panel display turns off.

### About speaker output of each surround setting

The table below describes the options when you connect all the speakers to the unit. The default setting is [A.F.D. Multi] (“A.F.D. MULTI”).

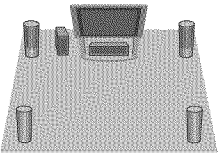
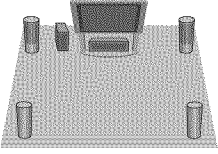
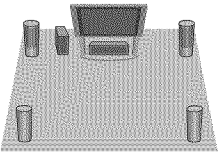
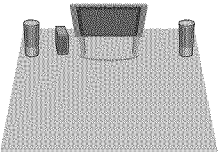
Sound from	Surround setting	Effect
Depending on the source.	[A.F.D. Standard] “A.F.D. STD” (AUTO FORMAT DIRECT STANDARD)	The system discriminates the sound format of the source and presents sound as it was recorded/encoded.
	[A.F.D. Multi] “A.F.D. MULTI” (AUTO FORMAT DIRECT MULTI)	<ul style="list-style-type: none"> <li>• 2 channel source: The system simulates surround sound from 2 channel sources and outputs sound from the 5.1 channel speakers by duplicating 2 channel source sound across each speaker.</li> <li>• Multi-channel source: The system outputs sound from the speakers depending on the number of channels of the source.</li> </ul>
	<ul style="list-style-type: none"> <li>• [Dolby Pro Logic] “PRO LOGIC”</li> <li>• [Dolby PL II Movie] “PLII MOVIE”</li> </ul>	<ul style="list-style-type: none"> <li>• 2 channel source: The system simulates surround sound from 2 channel sources and outputs sound from the 5.1 channel speakers.               <ul style="list-style-type: none"> <li>– [Dolby Pro Logic] (“PRO LOGIC”) performs Dolby Pro Logic decoding.</li> <li>– [Dolby PL II Movie] (“PLII MOVIE”) performs Dolby Pro Logic II movie mode decoding.</li> </ul> </li> <li>• Multi-channel source: The system outputs sound from the speakers depending on the number of channels of the source.</li> </ul>
	<ul style="list-style-type: none"> <li>• [DTS Neo:6 Cinema] “NEO6 CIN”</li> <li>• [DTS Neo:6 Music] “NEO6 MUS”</li> </ul>	<ul style="list-style-type: none"> <li>• 2 channel source: The system simulates surround sound from 2 channel sources and produces 6.1 channel sound.               <ul style="list-style-type: none"> <li>– [DTS Neo:6 Cinema] (“NEO6 CIN”) performs DTS Neo:6 Cinema mode decoding.</li> <li>– [DTS Neo:6 Music] (“NEO6 MUS”) performs DTS Neo:6 Music mode decoding.</li> </ul> </li> <li>• Multi-channel source: The system outputs sound from the speakers depending on the number of channels of the source.</li> </ul>
	[2ch Stereo] “2CH ST.”	The system outputs the sound from the front speakers and subwoofer regardless of sound format or number of channels. Multi-channel surround formats are downmixed to 2 channels.



**Note**

- When you select [A.F.D. Multi] (“A.F.D. MULTI”), depending on the disc or source, the beginning of the sound may be cut off while the optimum mode is automatically selected. To avoid cutting the sound, select [A.F.D. Standard] (“A.F.D. STD”).
- When bilingual broadcast sound is input, [Dolby Pro Logic] (“PRO LOGIC”) and [Dolby PL II Movie] (“PLII MOVIE”) are not effective.
- Depending on the input stream, the surround settings may not be effective.
- When you play a Super Audio CD, surround settings are not activated.

**Tip**

- You can also select the surround setting in [Surround Setting] of [Audio Settings] (page 60).
- For functions other than “BD/DVD,” “FM,” and “AUDIO,” you can check whether [Dolby Pro Logic] (“PRO LOGIC”) or the DTS Neo:6 mode is activated by pressing DISPLAY repeatedly so that the stream information/decoding status appears in the front panel display.

## Playing a Disc

For playable discs, see “Playable Discs” (page 71).

- 1 Switch the input selector on your TV so that the signal from the system appears on your TV screen.
- 2 Press **▲**, and place a disc on the disc tray.

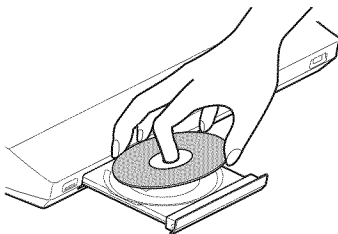

- 3 Press **▲** to close the disc tray. **⏪** appears on the home menu and playback starts.  
If playback does not start automatically, select **⏪** in the **📺** [Video], **🎵** [Music], or **📷** [Photo] category, and press **⊕**.

## Enjoying BONUSVIEW/BD-LIVE

Some BD-ROMs with “BD-LIVE Logo\*” have bonus content and other data that can be downloaded for enjoyment.

\* BD-LIVE™

- 1 Connect the USB device to the **↔** (USB) port on the rear of the unit.  
For local storage, use a 1 GB or larger USB memory.

Rear panel

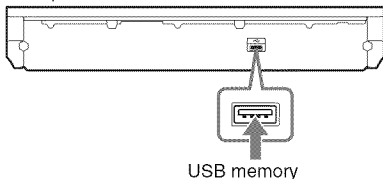

- 2 Prepare for BD-LIVE (BD-LIVE only).
  - Connect the system to a network (page 27).
  - Set [BD Internet Connection] to [Allow] (page 60).
- 3 Insert a BD-ROM with BONUSVIEW/BD-LIVE.

The operation method differs depending on the disc. Refer to the operating instructions of the disc.

**Tip**

- To delete data in the USB memory, select [Erase BD Data] in **📺** [Video], and press **⊕**. All data stored in the buda folder will be deleted.

## Enjoying Blu-ray 3D

You can enjoy Blu-ray 3D Discs with the 3D logo\*.



- 1 Prepare for Blu-ray 3D Disc playback.
  - Connect the system to your 3D-compatible TV using a High-Speed HDMI cable (supplied with BDV-E880/BDV-E980/BDV-T58 only).
  - Set [3D Output Setting] and [TV Screen Size Setting for 3D] in [Screen Settings] (page 58).

- 2 Insert a Blu-ray 3D Disc.

The operation method differs depending on the disc. Refer to the operating instructions supplied with the disc.

**Tip**

- Refer also to the operating instructions of your 3D-compatible TV.

## Displaying the play information

You can check the playback information, etc., by pressing DISPLAY.

The displayed information differs depending on the disc type and system status.

Example: when playing a BD-ROM

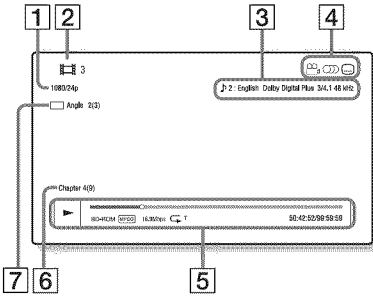

- 1 Output resolution/Video frequency
- 2 Title number or name
- 3 The currently selected audio setting
- 4 Available functions (Angle, audio, subtitle)
- 5 Playback information  
Displays play mode, playing status bar, disc type, video codec, bit rate, repeat type, elapsed time, total playing time
- 6 Chapter number
- 7 The currently selected angle

## Playing from a USB Device

You can play video/music/photo files on the connected USB device.

For playable types of files, see “Playable Types of Files” (page 72).

- 1 **Connect the USB device to the  (USB) port on the unit.**

Refer to the operating instructions of the USB device before connecting.

Rear panel

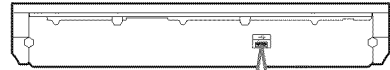





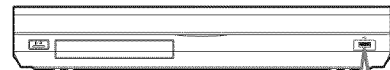



USB device

Front panel



USB device

- 2 **Press HOME.**  
The home menu appears on the TV screen.
- 3 **Press  to select  [Video],  [Music], or  [Photo].**
- 4 **Press  to select  [USB device (front)] or  [USB device (rear)], then press .**

### Note

- Do not remove the USB device during operation. To avoid data corruption or damage to the USB device, turn the system off when connecting or removing the USB device.

# Enjoying an iPod/iPhone

You can enjoy the music/video\*/photo\* and charge the battery of an iPod/iPhone via the system.

\* U.S. and Canada models only.

## Compatible iPod/iPhone models

The compatible iPod/iPhone models are as follows. Update your iPod/iPhone with the latest software before using with the system.

Made for iPod classic, iPod 5th generation (video), iPod nano 6th generation, iPod nano 5th generation (video camera), iPod nano 4th generation (video), iPod nano 3rd generation (video), iPod nano 2nd generation (aluminum), iPod nano 1st generation, iPod touch 4th generation, iPod touch 3rd generation, iPod touch 2nd generation, iPod touch 1st generation, iPhone 4, iPhone 3GS, iPhone 3G, iPhone

## To enjoy an iPod/iPhone via the system

- 1 (For U.S. and Canada models)**  
**Connect the Dock for iPod/iPhone (supplied) to the front or rear (USB) port on the unit, then place the iPod/iPhone onto the Dock for iPod/iPhone.**

When you play a video/photo file, connect the video out jack of the Dock for iPod/iPhone to the video input jack of your TV with a video cord (supplied) before placing the iPod/iPhone onto the Dock for iPod/iPhone.

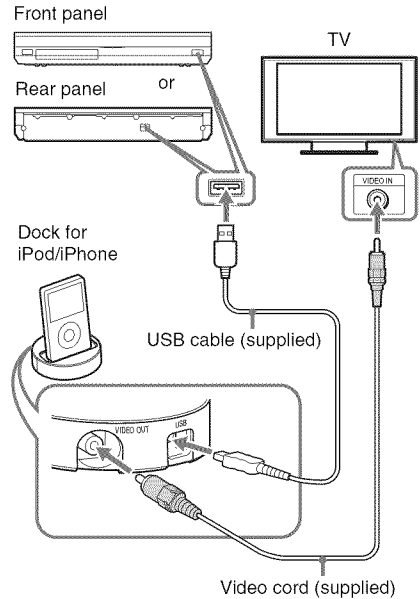

(For other models)  
 Connect the iPod/iPhone to the  (USB) port on the unit with the iPod/iPhone's USB cable.

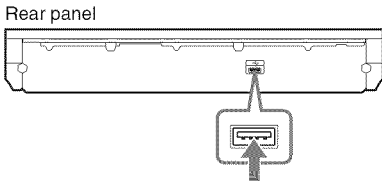



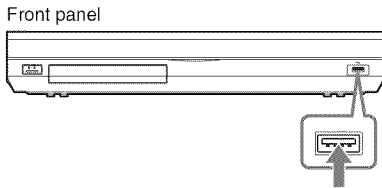

USB cable that is connected to the iPod/iPhone







USB cable that is connected to the iPod/iPhone

**2 Press HOME.**

The home menu appears on the TV screen.

**3 Press   to select  [Video]\*,  [Music], or  [Photo]\*.**

\* U.S. and Canada models only.

**4 Press   to select  [iPod (front)] or  [iPod (rear)], then press .**





■ If you selected [Video]\* or [Music] in Step 3

The video/music files are listed on the TV screen. Go to the next Step.

■ If you selected [Photo] in Step 3\*

[Please change the TV input to the video input] appears on the TV screen. Switch the input selector on your TV so that the signal from the iPod/iPhone appears on your TV screen. Then, start the slideshow by operating the iPod/iPhone directly.

\* U.S. and Canada models only.

**5 Press    and  to select the file that you want to play.**

The sound from the iPod/iPhone is played on the system.

When you play a video file, switch the input selector on your TV so that the signal from the iPod/iPhone appears on your TV screen. (U.S. and Canada models only)

You can operate the iPod/iPhone using the buttons on the remote.

For operation details, refer to the operating instructions of the iPod/iPhone.







**Note**

- To change a system setting, such as the surround setting, while viewing images from your iPod/iPhone on your TV, select the input on your TV for this system before operating the system. (U.S. and Canada models only.)













**To operate the iPod/iPhone using the remote**

You can operate the iPod/iPhone using the buttons on the remote. The following table shows an example of buttons that can be used. (Depending on the iPod/iPhone model, the operation may be different.)

**For  [Video]\* /  [Music]**



Press	Operation
	Starts play.
	Pauses play.
	Stops play.
 or 	Fast reverses or forwards.
 or 	Goes to the previous/next file or chapter (if any).

**For  [Photo]\***

Press	Operation
 , 	Starts/pauses play. When you press and hold either of these buttons for several seconds, the connected iPod/iPhone enters sleep mode.
	Pauses play.
 or 	Fast reverses or forwards.
 or 	Goes to the previous/next file. When you press and hold either of these buttons, the connected iPod/iPhone fast reverses or fast forwards.
DISPLAY	Turns the backlight on (or extends it for 30 seconds).
OPTIONS, 	Returns to previous display/folder hierarchy.
 	Selects the previous/next item.
 , 	Enters the selected item.

\* U.S. and Canada models only.

**Note**

- The iPod/iPhone is charged when connected to the system while the system is turned on.
- You cannot transfer songs onto the iPod/iPhone from this system.
- Sony cannot accept responsibility in the event that data recorded to iPod/iPhone is lost or damaged when using an iPod/iPhone connected to this unit.
- This product has been designed specifically to work with iPod/iPhone and has been certified to meet Apple performance standards.
- Do not remove the iPod/iPhone during operation. To avoid data corruption or damage to the iPod/iPhone, turn the system off when connecting or removing the iPod/iPhone.
- The system only recognizes iPods/iPhones that have previously been connected to the system.
- The System Audio Control function does not work while playing video/photo files via the iPod/iPhone (U.S. and Canada models only).
- When you connect an iPod that is not compatible with the video output function and select  [iPod (front)] or  [iPod (rear)] in [Video] or [Photo], an alert message appears on the TV screen (U.S. and Canada models only).
- The system can recognize up to 3,000 files (including folders).



# Playing via a Network

## Streaming BRAVIA Internet Video

BRAVIA Internet Video serves as a gateway delivering selected Internet content and a variety of on-demand entertainment straight to your unit.

**Tip**

- For customers in the U.S. and Canada: Some Internet content requires registration via a PC before it can be played. For further details, visit the following website:  
<http://www.sony.com/bluraysupport/>



- 1 Prepare for BRAVIA Internet Video.**  
Connect the system to a network (page 27).
- 2 Press  $\leftarrow/\rightarrow$  to select , , or .**
- 3 Press  $\uparrow/\downarrow$  to select an Internet content provider icon, then press  $\oplus$ .**  
If the Internet content list has not been retrieved, it will be represented by an unacquired icon or a new icon.

### To use the control panel

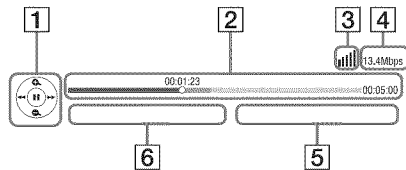
The control panel appears when the video file starts playing. The displayed items may differ depending on Internet content providers. To display again, press DISPLAY.



- 1** Control display  
Press  $\leftarrow/\uparrow/\downarrow/\rightarrow$  or  $\oplus$  for playback operations.
- 2** Playing status bar  
Status bar, cursor indicating the current position, playing time, duration of the video file

- 3 Network condition indicator  
 Indicates signal strength for a wireless connection.  
 Indicates a wired connection.
- 4 Network transmission speed
- 5 The next video file name
- 6 The currently selected video file name

## Playing files on a Home Network (DLNA)

You can play video/music/photo files on other DLNA-certified components by connecting them to your home network.

This unit can be used as a player and renderer.

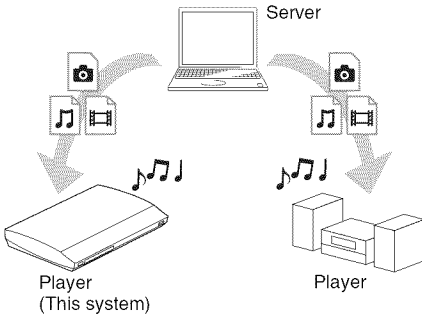

- Server: Stores and sends files
- Player: Receives and plays files from the server
- Renderer: Receives and plays files from the server, and can be operated by another component (controller)
- Controller: Operates the renderer component



### Prepare for using the DLNA function.

- Connect the system to a network (page 27).
- Prepare other DLNA-certified components. For details, see the operating instructions of the components.

## To play files stored on a DLNA server via the system (DLNA Player)

Select the DLNA server icon from  [Video],  [Music], or  [Photo] in the home menu, then select the file that you want to play.

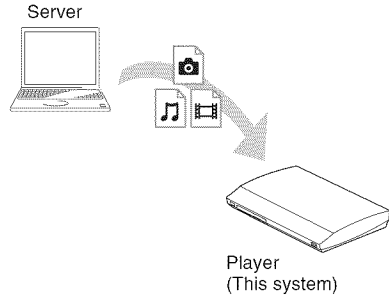

## To play remote files by operating the system (Renderer) via a DLNA controller

You can operate the system with a DLNA-certified controller, such as iPhone, when playing files stored on a DLNA server.

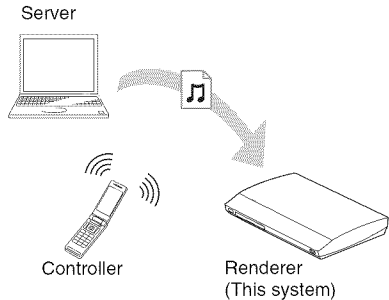

Control this system using a DLNA controller. For details of operation, see the operating instructions of the DLNA controller.

#### Note

- Do not operate the system with the supplied remote and a DLNA controller at the same time.
- For details about the DLNA controller, refer to the operating instructions of the DLNA controller.

#### Tip

- The system is compatible with the “Play To” function of Windows Media® Player 12 that comes standard with Windows 7.

## Playing the same music in different rooms (PARTY STREAMING)

You can play the same music at the same time across all Sony components which are compatible with the PARTY STREAMING function and connected to your home network.

There are two kinds of PARTY STREAMING-compatible components.

- PARTY host: Sends and plays files
- PARTY guest: Receives and plays files

This unit can be used as a PARTY host or PARTY guest.

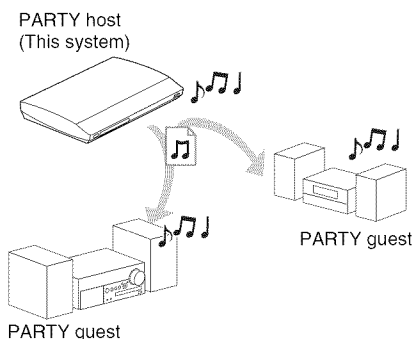

### Prepare for PARTY STREAMING.

- Connect the system to a network (page 27).
- Connect components which are compatible with the PARTY STREAMING function.

### To use the system as PARTY host

Select a track in **[Music]**, then select [Start Party] from the options menu to start a PARTY. To close the PARTY, press HOME.

### To use the system as PARTY guest

Select **[Party]** in **[Music]**, then select the PARTY host device icon.

To leave the PARTY, press OPTIONS, then select [Leave Party].

To close the PARTY, press OPTIONS, then select [Close Party].

#### Note

- The sale and product lineup of products that are compatible with the PARTY STREAMING function differ depending on the area.

## Searching for video/music information

You can acquire content information using Gracenote technology and search for related information.

- 1 **Connect the system to a network (page 27).**
- 2 **Insert a disc or connect a USB device with content about which you want to search.**  
You can perform a video search from a BD-ROM or DVD-ROM, and a music search from a CD-DA (music CD) or USB device.
- 3 **Press **←/→** to select **[Video]** or **[Music]**.**
- 4 **Press **↑/↓** to select **[Video Search]** or **[Music Search]**.**

The content information is displayed.

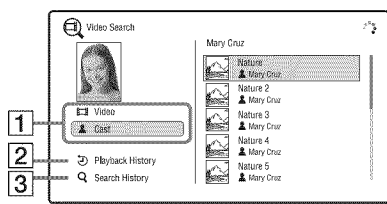

- 1 **Content details**  
Displays a list of related information, such as title, cast, track, or artist.
- 2 **[Playback History]**  
Displays a list of previously played BD-ROM/DVD-ROM/CD-DA (music CD) titles. Select a title to acquire content information.
- 3 **[Search History]**  
Displays a list of previous searches performed via the [Video Search] or [Music Search] function.



## To search for further related information

Select an item in the lists, and select [Information Search] or [Internet Video Search].

## Available Options

Various settings and playback operations are available by pressing **OPTIONS**. The available items differ depending on the situation.

### Common options

Items	Details
[Surround Setting]	Changes the surround setting (page 31).
[Repeat Setting]	Sets repeat playback.
[3D Menu]	[3D Depth Adjustment]: Adjusts the depth of 3D images.
[Favorites List]	Displays the Favorites List.
[Play/Stop]	Starts or stops playback.
[Play from beginning]	Plays the item from the beginning.
[Add to Favorites]	Adds an Internet content item to the Favorites List.
[Remove from Favorites]	Erases an Internet content item from the Favorites List.
[Start Party]	Starts a party with the selected source. This item may not appear depending on the source.
[Leave Party]	Leaves from a party which the system is participating in. The PARTY STREAMING function continues among other participating devices.
[Close Party]	Closes a party which the system is participating in. The PARTY STREAMING function ends for all other participating devices.

## [Video] only

Items	Details
[A/V SYNC]	Adjusts the gap between picture and sound. For details, see “Adjusting the delay between the picture and sound” (page 42).
[3D Output Setting]	Sets whether or not to output 3D video automatically. <b>Note</b> • 3D video from the HDMI (IN 1) or HDMI (IN 2) jack is output regardless of this setting.
[Video Settings]	<ul style="list-style-type: none"> <li>• [Picture Quality Mode]: Selects the picture settings for different lighting environments.</li> <li>• [FNR]: Reduces the random noise appearing in the picture.</li> <li>• [BNR]: Reduces the mosaic-like block noise in the picture.</li> <li>• [MNR]: Reduces minor noise around the picture outlines (mosquito noise).</li> </ul>
[Pause]	Pauses playback.
[Top Menu]	Displays the BD's or DVD's Top Menu.
[Menu/Popup Menu]	Displays the BD-ROM's Pop-up Menu or DVD's menu.
[Title Search]	Searches for a title on BD-ROMs/DVD VIDEOS and starts playback from the beginning.
[Chapter Search]	Searches for a chapter and starts playback from the beginning.
[Angle]	Switches to other viewing angles when multi-angles are recorded on BD-ROMs/DVD VIDEOS.
[IP Content Noise Reduction]	Adjusts the video quality for Internet content.
[Video Search]	Displays information on the BD-ROM/DVD-ROM based on Gracenote technology.

## [Music] only

Items	Details
[Add Slideshow BGM]	Registers music files in the USB memory as slideshow background music (BGM).
[Music Search]	Displays information on the audio CD (CD-DA) based on Gracenote technology.
[Shuffle Setting] (iPod/iPhone only)	Sets shuffle playback.

## [Photo] only

Items	Details
[Slideshow]	Starts a slideshow.
[Slideshow Speed]	Changes the slideshow speed.
[Slideshow Effect]	Sets the effect when playing a slideshow.
[Slideshow BGM]	<ul style="list-style-type: none"><li>• [Off]: Turns off the function.</li><li>• [My Music from USB]: Sets the music files registered in [Add Slideshow BGM].</li><li>• [Play from Music CD]: Sets the tracks on CD-DAs (music CDs).</li></ul>
[Rotate Left]	Rotates the photo counterclockwise by 90 degrees.
[Rotate Right]	Rotates the photo clockwise by 90 degrees.
[View Image]	Displays the selected picture.

## Adjusting the delay between the picture and sound

### (A/V SYNC)

When the sound does not match the pictures on the TV screen, you can adjust the delay between the picture and sound.

The setting method differs depending on the function.

#### Note

- Depending on the input stream, A/V SYNC may not be effective.

## When playing via the “BD/DVD” function

- 1 Press OPTIONS.**  
The option menu appears on the TV screen.
- 2 Press  $\uparrow/\downarrow$  to select [A/V SYNC], then press  $\oplus$ .**
- 3 Press  $\leftarrow/\rightarrow$  to adjust the delay between the picture and sound.**  
You can adjust from 0 ms to 300 ms in 25 ms increments.
- 4 Press  $\oplus$ .**  
The setting is made.

## When playing via the “HDMI1,” “HDMI2,” “TV,” “SAT/CABLE,” or “AUDIO” function

- 1 Press OPTIONS.**  
The option menu appears in the front panel display.
- 2 Press  $\uparrow/\downarrow$  repeatedly until “A/V SYNC” appears in the front panel display, then press  $\oplus$  or  $\rightarrow$ .**
- 3 Press  $\uparrow/\downarrow$  to adjust the delay between the picture and sound.**  
You can adjust from 0 ms to 300 ms in 25 ms increments.
- 4 Press  $\oplus$ .**  
The setting is made.
- 5 Press OPTIONS.**  
The option menu in the front panel display turns off.

# Selecting the Effect to Suit the Source

You can select a suitable sound mode for movies or music.

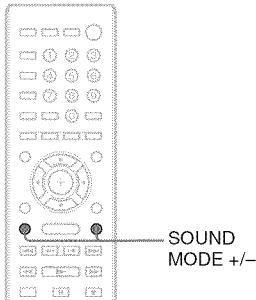

Press **SOUND MODE +/-** repeatedly during playback until the desired mode appears in the front panel display.

- **“AUTO”**: The system selects “MOVIE” or “MUSIC” automatically to produce the sound effect depending on the disc or sound stream.
- **“MOVIE”**: The system provides the sound for movies.
- **“MUSIC”**: The system provides the sound for music.
- **“SPORTS”**: The system adds reverberation for sports programs.
- **“GAME ROCK”**: The system provides the sound for music/rhythm games.
- **“OMNI-DIR”**: The same sound is audible anywhere in the room.
- **“3D SUR.”**: “3D SUR.” is a unique Sony algorithm used for playing 3D (three-dimensional) content that provides a 3D sound experience with depth and presence by creating a virtual sound field close to your ears.
- **“HALL”**: The system reproduces the sound of a concert hall.
- **“NIGHT”**: You can enjoy sound effects or dialog, as you would in a movie theater, even

at low volume. It is useful for watching movies at night.

### Note

- Depending on the disc or source, when you select “AUTO,” the beginning of the sound may be cut off as the system selects the optimum mode automatically. To avoid cutting the sound, select other than “AUTO.”
- Depending on the input stream, the sound mode may not be effective.
- When you play a Super Audio CD, this function does not work.
- When “NIGHT” is selected and sound is output from the center speaker, this effect is more pronounced, as speech (movie dialog, etc.) is easy to hear. When sound is not output from the center speaker, the system optimally adjusts the volume.

# Selecting the Audio Format, Multilingual Tracks, or Channel

When the system is playing a BD/DVD VIDEO recorded in multiple audio formats (PCM, Dolby Digital, MPEG audio, or DTS) or multilingual tracks, you can change the audio format or language.

With a CD, you can select the sound from the right or left channel and listen to the sound of the selected channel through both the right and left speakers.

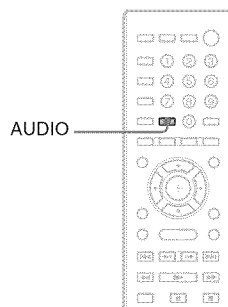

Press **AUDIO** repeatedly during playback to select the desired audio signal.

The audio information appears on the TV screen.

## ■ BD/DVD VIDEO







Depending on the BD/DVD VIDEO, the choice of language varies.

When 4 digits are displayed, they indicate a language code. See “Language Code List” (page 76) to confirm which language the code represents. When the same language is displayed two or more times, the BD/DVD VIDEO is recorded in multiple audio formats.



## ■ DVD-VR

The types of sound tracks recorded on a disc are displayed.





Example:

- [  Stereo]
- [  Stereo (Audio1)]
- [  Stereo (Audio2)]
- [  Main]
- [  Sub]
- [  Main/Sub]

### Note

- [  Stereo (Audio1)] and [  Stereo (Audio2)] do not appear when only one audio stream is recorded on the disc.

## ■ CD

- [  Stereo]: The standard stereo sound.
- [  1/L]: The sound of the left channel (monaural).
- [  2/R]: The sound of the right channel (monaural).
- [  L+R]: The sound of both the left and right channels output from each individual speaker.

# Enjoying Multiplex Broadcast Sound

## (DUAL MONO)

You can enjoy multiplex broadcast sound when the system receives or plays a Dolby Digital multiplex broadcast signal.

### Note

- To receive the Dolby Digital signal, you need to connect a TV or other component to the unit with a digital coaxial or optical cord (pages 22, 24). If your TV is compatible with the Audio Return Channel function (pages 22, 61), you can receive a Dolby Digital signal via an HDMI cable.

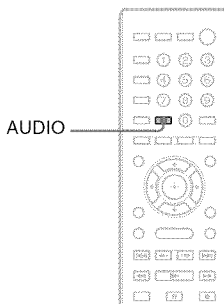

**Press AUDIO repeatedly until the desired signal appears in the front panel display.**

- “MAIN”: Sound of the main language will be output.
- “SUB”: Sound of the sub language will be output.
- “MAIN/SUB”: Mixed sound of both the main and sub languages will be output.

# Listening to the Radio

You can enjoy radio sound with the system's speakers.

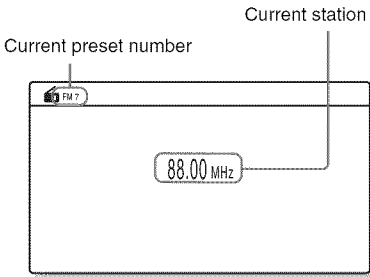
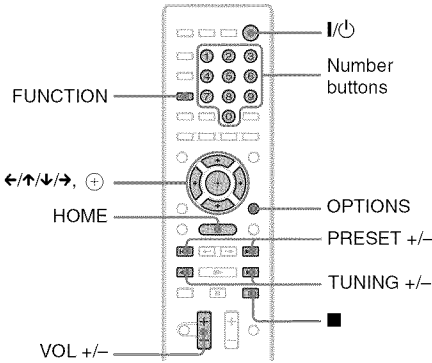

**1** Press **FUNCTION** repeatedly until “FM” appears in the front panel display.

**2** Select the radio station.

### Automatic tuning

Press and hold **TUNING +/-** until the auto scanning starts.

[Auto Tuning] appears on the TV screen. Scanning stops when the system tunes in a station.

To stop the automatic tuning manually, press **TUNING +/-** or **■**.

### Manual tuning

Press **TUNING +/-** repeatedly.

**3** Adjust the volume by pressing **VOL +/-**.

### If an FM program is noisy

If an FM program is noisy, you can select monaural reception. There will be no stereo effect, but reception will improve.

**1** Press **OPTIONS**.

The option menu appears on the TV screen.

**2** Press **↑/↓** to select [FM Mode], then press **⊕**.

**3** Press **↑/↓** to select [Monaural].

- [Stereo]: Stereo reception.
- [Monaural]: Monaural reception.

**4** Press **⊕**.

The setting is made.

### To turn off the radio

Press **I/Power**.

## Presetting radio stations

You can preset up to 20 stations. Before tuning, make sure to turn down the volume to minimum.

**1** Press **FUNCTION** repeatedly until “FM” appears in the front panel display.

**2** Press and hold **TUNING +/-** until the auto scanning starts.

Scanning stops when the system tunes in a station.

**3** Press **OPTIONS**.

The option menu appears on the TV screen.

**4** Press **↑/↓** to select [Preset Memory], then press **⊕**.

**5** Press **↑/↓** to select the preset number you want, then press **⊕**.

**6** Repeat Steps 2 to 5 to store other stations.

### To change the preset number

Select the desired preset number by pressing **PRESET +/-**, then perform the procedure from Step 3.

## Selecting the preset station

- 1 Press FUNCTION repeatedly until "FM" appears in the front panel display.**

The last received station is tuned in.

- 2 Press PRESET +/- repeatedly to select the preset station.**

The preset number and frequency appear on the TV screen and front panel display.

Each time you press the button, the system tunes in one preset station.

### **Tip**

- You can select the preset station number directly by pressing the number buttons.
- Each time you press DISPLAY, the display in the front panel display changes as follows:  
Frequency → Preset number → Stream information/Decode status → Frequency → ...

# Using the Control for HDMI Function for “BRAVIA” Sync

This function is available on TVs with the “BRAVIA” Sync function.

By connecting Sony components that are compatible with the Control for HDMI function via an HDMI cable, operation is simplified.

### Note

- Some functions can only be used if the connected TV is compatible, and require prior setting via the TV. Refer to the operating instructions of the TV.
- To use the System Audio Control function, you need to make an audio connection between the system and TV (page 22).

## Using “BRAVIA” Sync

### Control for HDMI - Easy Setting

You can set the system’s [Control for HDMI] function automatically by enabling the corresponding setting on the TV.

For details about the Control for HDMI function, see “[HDMI Settings]” (page 61)

### System Power Off

You can turn the system off in sync with the TV.

### Note

- The system does not turn off automatically while playing music or when set to the “FM” function.

### One-Touch Play

When you press ► on the remote, the system and your TV turn on, and your TV’s input is set to the HDMI input to which the system is connected.

### System Audio Control

You can simplify operation to enjoy sound from the TV or other components.

You can use the System Audio Control function as follows:

- When the system is turned on, the sound of the TV or other components can be output from the speakers of the system.
- When sound from the TV or other components is output via the speakers of the system, you can change the speakers to which TV sound is output by pressing SPEAKERS TV ↔ AUDIO.
- When sound from the TV or other components is output via the speakers of the system, you can adjust the volume and turn off the sound of the system by operating the TV.

### Note

- While the TV is in PAP (picture and picture) mode, or the system is playing video/photo files from the iPod/iPhone, the System Audio Control function will not work.
- Depending on the TV, when you adjust the unit’s volume, the volume level appears on the TV screen. In this case, the volume level that appears on the TV screen and the unit’s front panel display may differ.

### Audio Return Channel

You can enjoy TV sound via the system by using just one HDMI cable. For details of the setting, see “Connecting the TV” (page 22).

### Remote Easy Control

You can control the basic functions of the system via the TV remote when the system’s video output is displayed on the TV screen.

### Language Follow

When you change the language for the on-screen display of the TV, the system’s on-screen display language is also changed after turning the system off and on.

### Routing Control

When you perform One-Touch Play on the connected component, the system turns on and sets the system’s function to “HDMI1” or “HDMI2” (depending on the HDMI input jack in use), and your TV’s input is automatically set to the HDMI input to which the system is connected.

### Note

- Make sure that the component is connected to the system via an HDMI cable, and the Control for HDMI function of the connected component is set to on.

# Calibrating the Appropriate Settings Automatically

## [Auto Calibration]

D.C.A.C. (Digital Cinema Auto Calibration) can set the appropriate surround sound automatically.

### Note

- The system outputs a loud test sound when [Auto Calibration] starts. You cannot turn the volume down. Give consideration to children and neighbors.

### 1 Press HOME.

The home menu appears on the TV screen.

### 2 Press $\leftarrow/\rightarrow$ to select [Setup].

### 3 Press $\uparrow/\downarrow$ to select [Audio Settings], then press $\oplus$ .

### 4 Press $\uparrow/\downarrow$ to select [Auto Calibration], then press $\oplus$ .

The confirmation display for [Auto Calibration] appears.

### 5 Connect the calibration mic to the A.CAL MIC jack on the rear panel.

Set up the calibration mic at ear level using a tripod, etc. (not supplied). The front of each speaker should face the calibration mic, and there should be no obstruction between the speakers and the calibration mic.

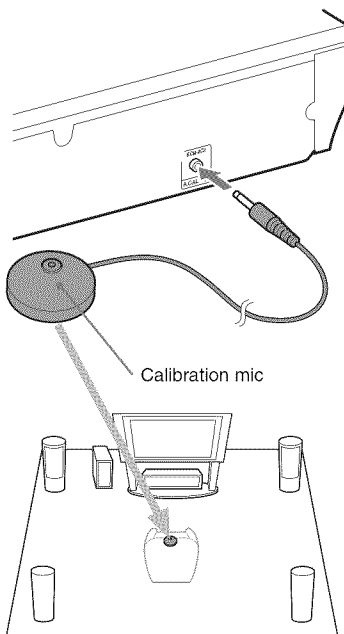

### 6 Press $\uparrow/\downarrow$ to select [OK].

To cancel, select [Cancel].

### 7 Press $\oplus$ .

[Auto Calibration] starts.

The system adjusts the speaker settings automatically.

Be quiet during the measurement.

### Note

- Before [Auto Calibration], make sure that the surround amplifier turns on and you install the surround amplifier in the appropriate location. If you install the surround amplifier in an improper location, such as another room, proper measurement will not be obtained.

### 8 Confirm the conclusions of [Auto Calibration].

The speakers connected to the unit are listed as [Yes] on the TV screen.

### Note

- If measurement fails, follow the message then retry [Auto Calibration].
- The measurement for [Subwoofer] is always [Yes] and [Speaker Settings] returns to the default setting when you perform [Auto Calibration].



**9** Press  $\uparrow/\downarrow$  to select [OK] or [Cancel], then press  $\oplus$ .

■ **The measurement is OK.**

Disconnect the calibration mic, then select [OK]. The result is implemented.

■ **The measurement is not OK.**

Follow the message, then select [OK] to retry.

**Note**

- While the Auto Calibration function is working, do not operate the system.

## Setting the Speakers

### [Speaker Settings]

To obtain the best possible surround sound, set connection of the speakers and their distance from your listening position. Then use the test tone to adjust the level and the balance of the speakers to the same level.

**1** Press HOME.

The home menu appears on the TV screen.

**2** Press  $\leftrightarrow$  to select  [Setup].

**3** Press  $\uparrow/\downarrow$  to select [Audio Settings], then press  $\oplus$ .

**4** Press  $\uparrow/\downarrow$  to select [Speaker Settings], then press  $\oplus$ .

The [Speaker Settings] display appears.

**5** Press  $\uparrow/\downarrow$  to select the item, then press  $\oplus$ .

Check the following settings.

■ **[Connection]**

If you do not connect center or surround speakers, set the parameters for [Center] and [Surround]. Since the front speaker and subwoofer settings are fixed, you cannot change them.

**[Front]**

[Yes]

**[Center]**

[Yes]: Normally select this.

[None]: Select this if no center speaker is used.

**[Surround]**

[Yes]: Normally select this.

[None]: Select this if no surround speaker is used.

**[Subwoofer]**

[Yes]

■ **[Distance]**

When you move the speakers, be sure to set the parameters of the distance (A) from the listening position to the speakers.

You can set the parameters from 0 to 23 feet (0.0 to 7.0 meters).

The speakers in the illustration correspond to the following:

- ① Center speaker
- ② Front left speaker (L)
- ③ Front right speaker (R)
- ④ Subwoofer
- ⑤ Surround left speaker (L)
- ⑥ Surround right speaker (R)

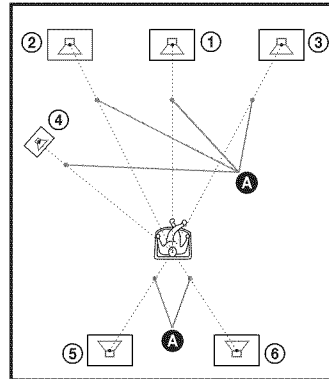

[Front Left/Right] 10 ft/3.0 m: Set the front speaker distance.

[Center]\* 10 ft/3.0 m: Set the center speaker distance.

[Surround Left/Right]\* 10 ft/3.0 m: Set the surround speaker distance.

[Subwoofer] 10 ft/3.0 m: Set the subwoofer distance.

\* This item appears when you set it to [Yes] in the [Connection] setting.

**Note**

- Depending on the input stream, [Distance] may not be effective.

**Tip**

- You can change measurement units (feet or meters) by pressing the color button (RED).

**■ [Level]**

You can adjust the sound level of the speakers. You can set the parameters from -6.0 dB to +6.0 dB. Be sure to set [Test Tone] to [On] for easy adjustment.

[Front Left/Right] 0.0 dB: Set the front speaker level.

[Center]\* 0.0 dB: Set the center speaker level.

[Surround Left/Right]\* 0.0 dB: Set the surround speaker level.

[Subwoofer] 0.0 dB: Set the subwoofer level.

\* This item appears when you set it to [Yes] in the [Connection] setting.

**■ [Test Tone]**

The speakers will emit a test tone to adjust [Level].

[Off]: The test tone is not emitted from the speakers.

[On]: The test tone is emitted from each speaker in sequence while adjusting level. When you select one of the [Speaker Settings] items, the test tone is emitted from each speaker in sequence.

Adjust the sound level as follows.

- 1** Set [Test Tone] to [On].
- 2** Press  $\uparrow/\downarrow$  to select [Level], then press  $\oplus$ .
- 3** Press  $\uparrow/\downarrow$  to select the desired speaker type, then press  $\oplus$ .
- 4** Press  $\leftarrow/\rightarrow$  to select the left or right speaker, then press  $\uparrow/\downarrow$  to adjust the level.
- 5** Press  $\oplus$ .
- 6** Repeat Steps 3 to 5.
- 7** Press RETURN.  
The system returns to the previous display.
- 8** Press  $\uparrow/\downarrow$  to select [Test Tone], then press  $\oplus$ .

- 9** Press  $\uparrow/\downarrow$  to select [Off], then press  $\oplus$ .

**Note**

- The test tone signals are not output from the HDMI (OUT) jack.

**Tip**

- To adjust the volume of all the speakers at one time, press VOL +/-.

## Using the Sleep Timer

You can set the system to turn off at a preset time, so you can fall asleep listening to music. The time can be preset in intervals of 10 minutes.

**Press SLEEP.**

Each time you press SLEEP, the minutes display (the remaining time) in the front panel display changes by 10 minutes.

When you set the sleep timer, the remaining time appears every 5 minutes.

When the remaining time is less than 2 minutes, "SLEEP" flashes in the front panel display.

**To check the remaining time**

Press SLEEP once.

**To change the remaining time**

Press SLEEP repeatedly to select the desired time.

## Deactivating the Buttons on the Unit

### (Child Lock)

You can deactivate the buttons on the unit (except for **I/⏻**) for preventing misoperation, such as child mischief (child lock function).

**Press ■ on the unit for more than 5 seconds.**

“LOCKED” appears in the front panel display. The child lock function is activated and the buttons on the unit are locked. (You can operate the system by using the remote.)

To cancel, press ■ for more than 5 seconds so that “UNLOCK” appears in the front panel display.

#### Note

- When you operate the buttons on the unit while the child lock function is on, “LOCKED” flashes in the front panel display.

## Controlling Your TV with the Supplied Remote

By adjusting the remote signal, you can control your TV with the supplied remote.

#### Note

- When you replace the batteries of the remote, the code number may reset itself to the default (SONY) setting. Reset the appropriate code number.

### Preparing the remote for controlling the TV

**Press and hold TV **I/⏻** while entering your TV's manufacturer's code (see the table) using the number buttons. Then release TV **I/⏻**.**

If the setting is unsuccessful, the currently registered code is not changed. Re-enter the code number.

## Code numbers of controllable TVs

If more than one code number is listed, try entering them one at a time until you find the code that works with your TV.

Manufacturer	Code number
SONY	01 (default)
LG	02
PANASONIC	05
SAMSUNG	02, 06
SHARP	03
TOSHIBA	04
VIZIO	07

## Changing the Brightness of the Front Panel Display

**Press DIMMER.**

Each time you press DIMMER, the brightness of the front panel display is changed.

## Saving Power in Standby Mode

Check that the following settings are both made:

- [Control for HDMI] in [HDMI Settings] is set to [Off] (page 61).
- [Quick Start Mode] is set to [Off] (page 62).

# Browsing Websites

You can connect to the Internet and enjoy websites like the Sony homepage using the system.

## 1 Prepare for Internet browsing.

Connect the system to a network (page 27).

## 2 Press HOME.

The home menu appears on the TV screen.

## 3 Press $\leftarrow/\rightarrow$ to select [Network].

## 4 Press $\uparrow/\downarrow$ to select [Internet Browser], then press $\oplus$ .

The [Internet Browser] display appears.

### Note

- Some websites may not display correctly, or not function.

## To enter a URL

Select [URL entry] from the options menu. Enter the URL using the software keyboard, then select [Enter].

## To set the default start page

While the page you want to set is displayed, select [Set as start page] from the options menu.

## To quit Internet Browser

Press HOME.

## Internet Browser display

You can check website information by pressing DISPLAY. The display information differs depending on the website and page status.

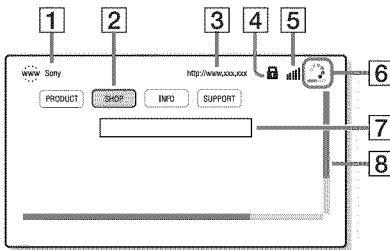

- 1 Page title
- 2 Cursor  
Move by pressing  $\leftarrow/\uparrow/\downarrow/\rightarrow$ . Place the cursor on the link you want to view, then press  $\oplus$ . The linked website is displayed.
- 3 Page address
- 4 SSL icon  
Appears when the linked URL is secured.
- 5 Signal strength indicator  
Appears when the system is connected to a wireless network.
- 6 Progress bar/Loading icon  
Appears when the page is being read, or during file download/transfer.
- 7 Text input field  
Press  $\oplus$ , then choose [Input] from the options menu to open the software keyboard.
- 8 Scroll bar  
Press  $\leftarrow/\uparrow/\downarrow/\rightarrow$  to move the page display left, up, down, or right.

## Available options

Various settings and operations are available by pressing OPTIONS. The available items differ depending on the situation.

Items	Details
[Browser Setup]	Displays the Internet Browser settings. <ul style="list-style-type: none"><li>• [Zoom]: Increases or decreases the size of the displayed contents.</li><li>• [JavaScript Setup]: Sets whether to enable or disable JavaScript.</li><li>• [Cookie Setup]: Sets whether or not to accept browser cookies.</li><li>• [SSL Alarm Display]: Sets whether to enable or disable SSL.</li></ul>
[Input]	Displays the software keyboard to enter characters while browsing a website.
[Break]	Moves the cursor to the next line in the text input field.

Items	Details
[Delete]	Erases one character on the left side of the cursor during text input.
[Window List]	Displays a list of all currently opened websites. Allows you to return to a previously displayed website by selecting the window.
[Bookmark List]	Displays the bookmark list.
[Character encoding]	Sets the character code.
[Previous page]	Moves to a previously displayed page.
[Next page]	Moves to the previously displayed next page.
[Cancel loading]	Stops loading a page.
[Reload]	Reloads the same page.
[URL entry]	Allows you to enter a URL when the software keyboard is displayed.
[Add to Bookmark]	Adds the currently displayed website to the bookmark list.
[Set as start page]	Sets the currently displayed website as the default start page.
[Open in new window]	Opens a link in a new window.
[Display certificate]	Displays server certificates sent from pages that support SSL.

# Setting up the Network

## [Internet Settings]

Before setting, connect the system to the network. For details, see “Step 3: Connecting to the Network” (page 27).

### To open the setting display

#### 1 Press HOME.

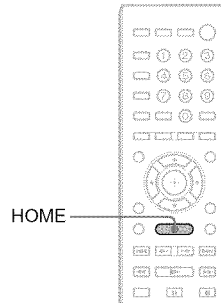

The home menu appears on the TV screen.

#### 2 Press ←/→ to select [Setup].

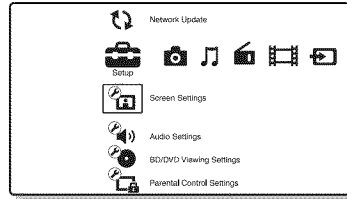

#### 3 Press ↑/↓ to select [Network Settings], then press +.

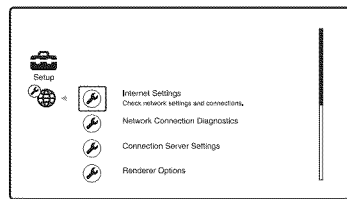

#### 4 Press $\uparrow/\downarrow$ to select [Internet Settings], then press $\oplus$ .

The [Internet Settings] display appears.

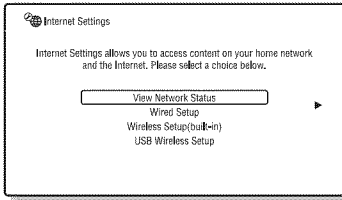

#### Note

- The [Internet Settings] items are necessary to connect to the Internet. Enter the respective (alphanumeric) values for your broadband router or Wireless LAN router. The items that need to be set may differ, depending on the Internet service provider or the router. For details, refer to the instruction manuals that have been provided by your Internet service provider or supplied with the router.
- For more information, go to the following URL.

For customers in the U.S.:  
<http://www.sony.com/support>

For customers in Canada:  
English: <http://www.sony.ca/support>  
French: <http://fr.sony.ca/support>

For customers in Mexico and Latin America:  
<http://esupport.sony.com/LA>

## When connecting to the LAN with a LAN cable

Follow the Steps below for connecting to a LAN (Local Area Network).

### Auto setting

- 1 Press  $\uparrow/\downarrow$  to select [Wired Setup] on the [Internet Settings] display, then press  $\oplus$ .
- 2 Press  $\uparrow/\downarrow$  to select [Auto], then press  $\oplus$ .  
The system performs the network setting automatically, and internet settings appear on the TV screen.
- 3 Press  $\rightarrow$ .

#### 4 Press $\uparrow/\downarrow$ to select [Save & Connect], then press $\oplus$ .

The system starts checking the network connection.

#### 5 Check that the message [Internet Settings is now complete.] appears, then press $\oplus$ .

The setup is finished. If the message does not appear, follow the on-screen messages.

### Manual setting

- 1 Press  $\uparrow/\downarrow$  to select [Wired Setup] on the [Internet Settings] display, then press  $\oplus$ .
- 2 Press  $\uparrow/\downarrow$  to select [Custom], then press  $\oplus$ .
- 3 Press  $\uparrow/\downarrow$  to select the network setting type, then press  $\oplus$ .
  - [Auto]: The system sets the IP address automatically, and the [DNS Settings] display appears.  
When you select [Auto] and press  $\oplus$ , the system sets the DNS setting automatically.  
When you select [Specify IP address] and press  $\oplus$ , enter the DNS settings manually.  
Press  $\leftarrow/\uparrow/\downarrow/\rightarrow$  and the number buttons to set the following items, then press  $\oplus$ .
    - [Primary DNS]
    - [Secondary DNS]
  - [Specify IP address]: Enter the network settings manually according to your network environment.  
Press  $\leftarrow/\uparrow/\downarrow/\rightarrow$  and the number buttons to set the following items, then press  $\oplus$ .
    - [IP Address]
    - [Subnet Mask]
    - [Default Gateway]
    - [Primary DNS]
    - [Secondary DNS]
- 4 Press  $\uparrow/\downarrow$  to select the proxy server setting, then press  $\oplus$ .
  - [No]: A proxy server is not used.
  - [Yes]: Enter the proxy server setting.  
Press  $\leftarrow/\uparrow/\downarrow/\rightarrow$  and the number buttons, then press  $\oplus$ .

The value of the internet settings appears on the TV screen.

- 5 Press **→**.
- 6 Press **↑/↓** to select [Save & Connect], then press **+**.

The system starts checking the network connection.

- 7 Check that the message [Internet Settings is now complete.] appears, then press **+**.

The setup is finished. If the message does not appear, follow the on-screen messages.

## When connecting to the wireless LAN with the system's built-in Wi-Fi or the USB Wireless LAN Adapter

Follow the Steps below for connecting to a wireless LAN (Local Area Network).

### When your wireless router is compatible with the WPS function

- 1 Press **↑/↓** to select [Wireless Setup(built-in)]\* or [USB Wireless Setup] on the [Internet Settings] display, then press **+**.
- 2 Press **↑/↓** to select [Wi-Fi Protected Setup (WPS)], then press **+**.
- 3 Activate the WPS function of your wireless router, press **↑/↓** to select [Start], then press **+**.

\* BDV-E580/BDV-T58 only.

For details about activating the WPS function, see the operating instructions of your router.

- 4 Check that the message [Wi-Fi Protected Setup was successful.] appears, then press **→**.

Setup of wireless LAN connectivity and the IP address is finished.

Next, enter the proxy server setting. Follow Steps 4 to 7 of "Manual setting" in "When

connecting to the LAN with a LAN cable" above.

### When your wireless router is not compatible with the WPS function

- 1 Press **↑/↓** to select [Wireless Setup(built-in)]\* or [USB Wireless Setup] on the [Internet Settings] display, then press **+**.
- 2 Press **↑/↓** to select [Scan], then press **+**.

\* BDV-E580/BDV-T58 only.

The system searches for available wireless LANs, then the list of wireless LANs appears.

- 3 Press **↑/↓** to select the wireless LAN name, then press **+**.

#### ■ When the selected wireless LAN is unsecured

Setup of wireless LAN connectivity is finished. Next, enter the IP address settings by following the Steps of "Auto setting" or "Manual setting" in "When connecting to the LAN with a LAN cable" above.

#### ■ When the selected wireless LAN is secured

The display for entering a WEP or WPA key appears. Go to Step 5.

#### ■ To specify the wireless LAN name Select [Manual Entry].

The input display appears. Enter the wireless LAN name by following the on-screen messages, then press **→**.

**4** Press **↑/↓** to select the security mode, then press **+**.

- [None]: Select this if the wireless LAN is unsecured. Setup of wireless LAN connectivity is finished. Next, enter the IP address settings by following the Steps of “Auto setting” or “Manual setting” in “When connecting to the LAN with a LAN cable” above.
- [WEP]: The wireless LAN is protected by a WEP key.
- [WPA/WPA2-PSK]: The wireless LAN is protected by a WPA-PSK or WPA2-PSK.
- [WPA2-PSK]: The wireless LAN is protected by a WPA2-PSK.

**5** Enter the WEP key/WPA key by following the on-screen messages, then press **→**.

Setup of wireless LAN connectivity is finished. Next, enter the IP address settings by following the Steps of “Auto setting” or “Manual setting” in “When connecting to the LAN with a LAN cable” above.

## About wireless LAN security

Since communication via the wireless LAN function is established by radio waves, the wireless signal may be susceptible to interception. To protect wireless communication, this system supports various security functions. Be sure to correctly configure the security settings in accordance with your network environment.

### No Security

Although you can easily make settings, anyone can intercept wireless communication or intrude into your wireless network, even without any sophisticated tools. Keep in mind that there is a risk of unauthorized access or interception of data.

### WEP

WEP applies security to communications to prevent outsiders from intercepting communications or intruding into your wireless network. WEP is a legacy security technology that enables older device which do not support TKIP/AES to be connected.

### WPA-PSK (TKIP), WPA2-PSK (TKIP)

TKIP is a security technology developed in response to the deficiencies of WEP. TKIP assures a higher security level than WEP.

### WPA-PSK (AES), WPA2-PSK (AES)

AES is a security technology that uses an advanced security method distinct from WEP and TKIP.

AES assures a higher security level than WEP or TKIP.



## Using the Setup Display

You can make various adjustments of items such as picture and sound.

Select  (Setup) on the home menu when you need to change the settings of the system.

The default settings are underlined.

### Note

- Playback settings stored in the disc take priority over the Setup Display settings and not all the functions described may work.

### 1 Press HOME.

The home menu appears on the TV screen.

### 2 Press $\leftarrow/\rightarrow$ to select [Setup].

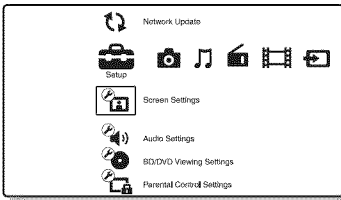





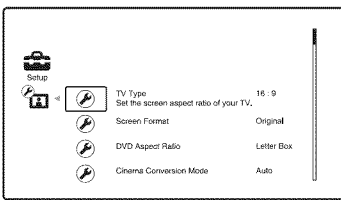





### 3 Press $\uparrow/\downarrow$ to select the setup category icon to change, then press $\oplus$ .

Example: [Screen Settings]



You can setup the following options.

Icon	Explanation
	<b>[Network Update] (page 57)</b> Updates the software of the system.
	<b>[Screen Settings] (page 58)</b> Makes the screen settings according to the type of connecting jacks.

Icon	Explanation
	<b>[Audio Settings] (page 59)</b> Makes the audio settings according to the type of connecting jacks.
	<b>[BD/DVD Viewing Settings] (page 60)</b> Makes detailed settings for BD/DVD playback.
	<b>[Parental Control Settings] (page 61)</b> Makes detailed settings for the Parental Control function.
	<b>[Music Settings] (page 61)</b> Makes detailed settings for Super Audio CD playback.
	<b>[System Settings] (page 61)</b> Makes the system-related settings.
	<b>[Network Settings] (page 62)</b> Makes detailed settings for Internet and network.
	<b>[Easy Setup] (page 63)</b> Re-runs the Easy Setup to make the basic settings.
	<b>[Resetting] (page 63)</b> Resets the system to the factory settings.

## [Network Update]

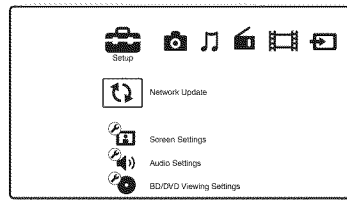

You can update and improve the functions of the system.

For information about update functions, refer to the following website:

For customers in the U.S.:  
<http://www.sony.com/support>

For customers in Canada:  
English: <http://www.sony.ca/support>  
French: <http://fr.sony.ca/support>

For customers in Mexico and Latin America:  
<http://esupport.sony.com/LA>

During a software update, "UPDATING" appears in the front panel display. After the update completes, the main unit automatically turns off. Please wait for the software update to complete; do not turn the main unit on or off, or operate the main unit or TV.

---

## [Screen Settings]

---

### ■ [3D Output Setting]

[Auto]: Normally select this.

[Off]: Select this to display all contents in 2D.

#### Note

- 3D video from the HDMI (IN 1) or HDMI (IN 2) jack is output regardless of this setting.

---

### ■ [TV Screen Size Setting for 3D]

Sets the screen size of your 3D compatible TV.

#### Note

- This setting does not apply to 3D video from the HDMI (IN 1) or HDMI (IN 2) jack.

---

### ■ [TV Type]

[16:9]: Select this when connecting to a wide-screen TV or a TV with a wide-mode function.

[4:3]: Select this when connecting to a 4:3 screen TV without a wide-mode function.

---

### ■ [Screen Format]

[Original]: Select this when connecting to a TV with a wide-mode function. Displays a 4:3 screen picture in 16:9 aspect ratio even on a wide-screen TV.

[Fixed Aspect Ratio]: Changes the picture size to fit the screen size with the original picture aspect ratio.

---

### ■ [DVD Aspect Ratio]

[Letter Box]: Displays a wide picture with black bands on the top and bottom.



[Pan & Scan]: Displays a full-height picture on the entire screen, with trimmed sides.

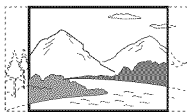

---

### ■ [Cinema Conversion Mode]

[Auto]: Normally select this. The unit automatically detects whether the material is video-based or film-based, and switches to the appropriate conversion method.

[Video]: The conversion method suited for video-based material will always be selected regardless of the material.

---

### ■ [Output Video Format]

[HDMI]: Normally select [Auto]. Select [Original Resolution] to output the resolution recorded on the disc. (When the resolution is lower than SD resolution, it is scaled up to SD resolution.)

[Component Video]: Select the resolution that suits your TV.

[Video]: Automatically sets the lowest resolution.

#### Note

- If no picture appears when setting [HDMI] or [Component Video] resolution, try another resolution setting.
- When connecting via the COMPONENT VIDEO OUT jack and [Component Video] is selected, BD-ROM playback of protected content is only supported at 480i\* output resolution (pages 22, 29).
  - \* 480i/576i for Mexican and Latin American models.

---

**■ [BD/DVD-ROM 1080/24p Output]**

[Auto]: Outputs 1920 × 1080p/24 Hz video signals only when connecting a 1080/24p-compatible TV using the HDMI (OUT) jack.  
[Off]: Select this when your TV is not compatible with 1080/24p video signals.

---

**■ [YCbCr/RGB (HDMI)]**

[Auto]: Automatically detects the type of external device, and switches to the matching color setting.

[YCbCr (4:2:2)]: Outputs YCbCr 4:2:2 video signals.

[YCbCr (4:4:4)]: Outputs YCbCr 4:4:4 video signals.

[RGB]: Select this when connecting to a device with an HDCP-compliant DVI jack.

---

**■ [HDMI Deep Color Output]**

[Auto]: Normally select this.

[16bit], [12bit], [10bit]: Outputs 16bit/12bit/10bit video signals when the connected TV is compatible with Deep Color.

[Off]: Select this when the picture is unstable or colors appear unnatural.

---

**■ [Pause Mode] (BD/DVD VIDEO/DVD-R/DVD-RW only)**

[Auto]: The picture, including subjects that move dynamically, is output with no jitter. Normally select this position.

[Frame]: The picture, including subjects that do not move dynamically, is output in high resolution.

---



---

 **[Audio Settings]**

---

**■ [BD Audio MIX Setting]**

[On]: Outputs the audio obtained by mixing the interactive audio and secondary audio to the primary audio.

[Off]: Outputs the primary audio only.

---

**■ [Audio DRC]**

You can compress the dynamic range of the sound track.

[Auto]: Performs playback at the dynamic range specified by the disc (BD-ROM only).

[Off]: No compression of dynamic range.

[On]: The system reproduces the sound track with the kind of dynamic range that the recording engineer intended.

---

**■ [Attenuate - AUDIO]**

Distortion may occur when you listen to a component connected to the AUDIO (AUDIO IN L/R) jacks. You can prevent distortion by reducing the input level on the unit.

[On]: Attenuates the input level. The output level is changed.

[Off]: Normal input level.

---

**■ [Audio Output]**

You can select the output method where the audio signal is output.

[Speaker]: Outputs multi-channel sound from the system's speakers only.

[Speaker + HDMI]: Outputs multi-channel sound from the system's speakers and 2-channel linear PCM signals from the HDMI (OUT) jack.

[HDMI]: Outputs sound from the HDMI (OUT) jack only. Sound format depends on the connected component.

**Note**

- When [Control for HDMI] is set to [On] (page 61), [Audio Output] is set to [Speaker + HDMI] automatically and this setting cannot be changed.
- When [Audio Output] is set to [HDMI], the output signal format for the "TV" and "SAT/CABLE" function is 2-channel linear PCM.

---

### ■ [Sound Effect]

You can set the system's sound effects (SOUND MODE and [Surround Setting]) to on/off.

[On]: Enables all of the system's sound effects. The upper limit of sampling frequency is set to 48 kHz.

[Off]: The sound effects are disabled. Select this when you do not want to set the upper limit of sampling frequency.

---

### ■ [Surround Setting]

You can select the surround setting. For details, see "Step 6: Enjoying Surround Sound" (page 31)

---

### ■ [Speaker Settings]

To obtain the best possible surround sound, set the speakers. For details, see "Setting the Speakers" (page 49).

---

### ■ [Auto Calibration]

You can calibrate the appropriate settings automatically. For details, see "Calibrating the Appropriate Settings Automatically" (page 48).

---

---

## [BD/DVD Viewing Settings]

You can make detailed settings for BD/DVD playback.

---

### ■ [BD/DVD Menu]

You can select the default menu language for BD-ROMs or DVD VIDEOS. When you select [Select Language Code], the display for entering the language code appears. Enter the code for your language by referring to "Language Code List" (page 76).

---

### ■ [Audio]

You can select the default track language for BD-ROMs or DVD VIDEOS. When you select [Original], the language given priority in the disc is selected. When you select [Select Language Code], the display for entering the language code appears. Enter the code for your language by referring to "Language Code List" (page 76).

---

### ■ [Subtitle]

You can select the default subtitle language for BD-ROMs or DVD VIDEOS. When you select [Select Language Code], the display for entering the language code appears. Enter the code for your language by referring to "Language Code List" (page 76).

---

### ■ [BD Hybrid Disc Playback Layer]

[BD]: Plays BD layer.

[DVD/CD]: Plays DVD or CD layer.

---

### ■ [BD Internet Connection]

[Allow]: Normally select this.

[Do not allow]: Prohibits Internet connection.

---

---



## [Parental Control Settings]

---

### ■ [Password]

Set or change the password for the Parental Control function. A password allows you to set a restriction on BD-ROM, DVD VIDEO, or Internet video playback. If necessary, you can differentiate the restriction levels for BD-ROMs and DVD VIDEOS.

---

### ■ [Parental Control Area Code]

Playback of some BD-ROMs or DVD VIDEOS can be limited according to the geographic area. Scenes may be blocked or replaced with different scenes. Follow the on-screen instructions and enter your four-digit password.

---

### ■ [BD Parental Control]

Playback of some BD-ROMs can be limited according to the age of the users. Scenes may be blocked or replaced with different scenes. Follow the on-screen instructions and enter your four-digit password.

---

### ■ [DVD Parental Control]

Playback of some DVD VIDEOS can be limited according to a predetermined level such as the age of the users. Scenes may be blocked or replaced with different scenes. Follow the on-screen instructions and enter your four-digit password.

---

### ■ [Internet Video Parental Control]

Playback of some Internet videos can be limited according to the age of the users. Scenes may be blocked or replaced with different scenes. Follow the on-screen instructions and enter your four-digit password.

---

### ■ [Internet Video Unrated]

[Allow]: Allows the playback of unrated Internet videos.

[Block]: Blocks the playback of unrated Internet videos.

---



## [Music Settings]

---

You can make detailed settings for Super Audio CD playback.

---

### ■ [Super Audio CD Playback Layer]

[Super Audio CD]: Plays the Super Audio CD layer.

[CD]: Plays the CD layer.

---

### ■ [Super Audio CD Playback Channel]

[DSD 2ch]: Plays the 2ch area.

[DSD Multi]: Plays the multi-channel area.

---

---



## [System Settings]

---

You can make the system-related settings.

---

### ■ [OSD]

You can select your language for the system on-screen displays.

---

### ■ [Illumination/Display]

You can select the status of the soft-touch buttons (page 11) and front panel display (page 12).

[Standard/On]: The soft-touch buttons and the front panel display stay illuminated.

[Simple/Off]: The soft-touch buttons and the front panel display turn off when the system is not being operated.

---

### ■ [HDMI Settings]

[Control for HDMI]

[On]: On. You can operate mutually between components that are connected with an HDMI cable.

[Off]: Off.

---

### [Audio Return Channel]

This function is available when you connect the system and TV that is compatible with the Audio Return Channel function.

[Auto]: The system can receive the digital audio signal of the TV automatically via an HDMI cable.

[Off]: Off.

**Note**

- This function is available only when [Control for HDMI] is set to [On].

---

■ **[Quick Start Mode]**

[On]: Shortens the startup time from standby mode. You can operate the system quickly after turning it on.

[Off]: The default setting.

---

■ **[Auto Standby]**

[On]: Turns on the [Auto Standby] function. When you do not operate the system for about 30 minutes, the system enters standby mode automatically.

[Off]: Turns off the function.

---

■ **[Auto Display]**

[On]: Automatically displays information on the screen when changing the viewing titles, picture modes, audio signals, etc.

[Off]: Displays information only when you press DISPLAY.

---

■ **[Screen Saver]**

[On]: Turns on the screen saver function.

[Off]: Off.

---

■ **[Software Update Notification]**

[On]: Sets the system to inform you of newer software version information (page 57).

[Off]: Off.

---

■ **[Gracenote Settings]**

[Auto]: Automatically downloads disc information when you stop playback of the disc. To download, the system must be connected to the network.

[Manual]: Downloads disc information when [Video Search] or [Music Search] is selected.

---

■ **[System Information]**

You can display the system's software version information and the MAC address.



## **[Network Settings]**

You can make detailed settings for Internet and network.

---

■ **[Internet Settings]**

Connect the system to the network beforehand. For details, see “Step 3: Connecting to the Network” (page 27).

---

■ **[Network Connection Diagnostics]**

You can run the network diagnostic to check if the network connection has been made properly.

---

■ **[Connection Server Settings]**

Sets whether or not to display the connected DLNA server.

---

■ **[Renderer Options]**

[Auto Access Permission]: Sets whether or not to allow automatic access from newly detected DLNA controller.

[Smart Select]: Allows a Sony DLNA controller to find the system as the target component to operate by using the infrared ray. You can set this function to on or off.

[Renderer Name]: Displays the system's name as it is listed on other DLNA devices on the network.

---

■ **[Renderer Access Control]**

Sets whether or not to accept commands from DLNA controllers.

---

■ **[Party Auto Start]**

[On]: Starts a PARTY or joins an existing PARTY at the request of a networked device compatible with the PARTY STREAMING function.

[Off]: Off.

---

■ **[Media Remote Device Registration]**

Registers your “Media remote” device.

---

■ **[Registered Media Remote Devices]**

Displays a list of your registered “Media remote” devices.



---

## [Easy Setup]

Re-runs the Easy Setup to make the basic settings. Follow the on-screen instructions.



## [Resetting]

---

### ■ [Reset to Factory Default Settings]

You can reset the system settings to the factory default by selecting the group of settings. All the settings within the group will be reset.

---

### ■ [Initialize Personal Information]

You can erase your personal information stored in the system.

# Precautions

### On safety

- To prevent fire or shock hazard, do not place objects filled with liquids, such as vases, on the system, or place the system near water, such as near a bathtub or shower room. Should any solid object or liquid fall into the cabinet, unplug the system and have it checked by qualified personnel before operating it any further.
- Do not touch the AC power cord (mains lead) with wet hands. Doing so may cause an electric shock.

### On power sources

- Unplug the unit from the wall outlet (mains) if you do not intend to use it for an extended period of time. To disconnect the cord, pull it out by the plug, never by the cord.

### On placement

- Place the system in a location with adequate ventilation to prevent heat build-up in the system.
- At high volume, over long periods of time, the cabinet becomes hot to the touch. This is not a malfunction. However, touching the cabinet should be avoided. Do not place the system in a confined space where ventilation is poor as this may cause overheating.
- Do not block the ventilation slots by putting anything on the system. The system is equipped with a high power amplifier. If the ventilation slots are blocked, the system can overheat and malfunction.
- Do not place the system on surfaces (rugs, blankets, etc.) or near materials (curtains, draperies) that may block the ventilation slots.
- Do not install the system in a confined space, such as a bookshelf or similar unit.
- Do not install the system near heat sources such as radiators, air ducts, or in a place subject to direct sunlight, excessive dust, mechanical vibration, or shock.
- Do not install the system in an inclined position. It is designed to be operated in a horizontal position only.
- Keep the system and discs away from components with strong magnets, such as microwave ovens, or large loudspeakers.
- Do not place heavy objects on the system.
- Do not place metal objects in front of the front panel. They may limit reception of radio waves.

- Do not place the system in a place where medical equipment is in use. It may cause a malfunction of medical equipment.
- If you use a pacemaker or other medical device, consult your physician or the manufacturer of your medical device before using the wireless LAN function.

### On operation

- If the system is brought directly from a cold to a warm location, or is placed in a very damp room, moisture may condense on the lenses inside the unit. Should this occur, the system may not operate properly. In this case, remove the disc and leave the system turned on for about half an hour until the moisture evaporates.
- When you move the system, take out any disc. If you do not, the disc may be damaged.
- If anything falls into the cabinet, unplug the unit and have it checked by qualified personnel before operating it any further.

### On adjusting volume

- Do not turn up the volume while listening to a section with very low level inputs or no audio signals. If you do, the speakers may be damaged when a peak level section is suddenly played.

### On cleaning

- Clean the cabinet, panel, and controls with a soft cloth slightly moistened with a mild detergent solution. Do not use any type of abrasive pad, scouring powder or solvent such as alcohol or benzine.  
If you have any questions or problems concerning your system, please consult your nearest Sony dealer.

### On cleaning discs, disc/lens cleaners

- **Do not use cleaning discs or disc/lens cleaners (including wet or spray types). These may cause the apparatus to malfunction.**

### On replacement of parts

- In the events that this system is repaired, repaired parts may be collected for reuse or recycling purposes.

### On your TV's color

- If the speakers should cause the TV screen to have color irregularity, turn off the TV then turn it on after 15 to 30 minutes. If color irregularity should persist, place the speakers further away from the TV set.



### IMPORTANT NOTICE

Caution: This system is capable of holding a still video image or on-screen display image on your television screen indefinitely. If you leave the still video image or on-screen display image displayed on your TV for an extended period of time you risk permanent damage to your television screen. Projection televisions are especially susceptible to this.

### On moving the system

- Before moving the system, make sure that there is no disc inserted, and remove the AC power cord (mains lead) from the wall outlet (mains).

## Notes about the Discs

### On handling discs

- To keep the disc clean, handle the disc by its edge. Do not touch the surface.
- Do not stick paper or tape on the disc.



- Do not expose the disc to direct sunlight or heat sources such as hot air ducts, or leave it in a car parked in direct sunlight as the temperature may rise considerably inside the car.
- After playing, store the disc in its case.

### On cleaning

- Before playing, clean the disc with a cleaning cloth. Wipe the disc from the center out.



- Do not use solvents such as benzine, thinner, commercially available cleaners, or anti-static spray intended for vinyl LPs.

This system can only play a standard circular disc. Using neither standard nor circular discs (e.g., card, heart, or star shape) may cause a malfunction.



Do not use a disc that has a commercially available accessory attached, such as a label or ring.

# Troubleshooting



If you experience any of the following difficulties while using the system, use this troubleshooting guide to help remedy the problem before requesting repairs. Should any problem persist, consult your nearest Sony dealer.

Note that if service personnel changes some parts during repair, these parts may be retained.

## General

Symptom	Problems and solutions
The power is not turned on.	<ul style="list-style-type: none"><li>• Check that the AC power cord (mains lead) is connected securely.</li></ul>
The remote does not function.	<ul style="list-style-type: none"><li>• The distance between the remote and the unit is too far.</li><li>• The batteries in the remote are weak.</li></ul>
The disc tray does not open and you cannot remove the disc even after you press  .	<ul style="list-style-type: none"><li>• Try the following: ① Press and hold  and  on the unit for more than 5 seconds to open the disc tray. ② Remove the disc. ③ Disconnect the AC power cord (mains lead) from the wall outlet (mains), then reconnect after several minutes.</li></ul>
The system does not work normally.	<ul style="list-style-type: none"><li>• Disconnect the AC power cord (mains lead) from the wall outlet (mains), then reconnect after several minutes.</li></ul>

## Messages

Symptom	Problems and solutions
[A new software version is available. Please go to the “Setup” section of the menu and select “Network Update” to perform the update.] appears on the TV screen.	<ul style="list-style-type: none"><li>• See [Network Update] (page 57) to update the system to a newer software version.</li></ul>
“PROTECTOR” and “PUSH PWR” appear alternately in the front panel display.	<p>Press  to turn off the system, and check the following items after “STANDBY” disappears.</p> <ul style="list-style-type: none"><li>• Are the + and – speaker cords short-circuited?</li><li>• Are you using only the specified speakers?</li><li>• Is anything blocking the ventilation holes of the system?</li></ul> <p>• After checking the above items and fixing any problems, turn on the system. If the cause of the problem cannot be found even after checking all the above items, consult your nearest Sony dealer.</p>
“LOCKED” appears in the front panel display.	<ul style="list-style-type: none"><li>• Set the child lock function to off (page 51).</li></ul>
“DEMO LOCK” appears in the front panel display.	<ul style="list-style-type: none"><li>• Contact your nearest Sony dealer or local authorized Sony service facility.</li></ul>
“Exxxx” appears in the front panel display.	<ul style="list-style-type: none"><li>• Contact your nearest Sony dealer or local authorized Sony service facility and give the error code.</li></ul>
 appears without any messages on the entire TV screen.	<ul style="list-style-type: none"><li>• Contact your nearest Sony dealer or local authorized Sony service facility.</li></ul>

## Picture

Symptom	Problems and solutions
There is no picture.	<ul style="list-style-type: none"> <li>• Check the output method on your system (page 22).</li> </ul>
There is no picture when you make an HDMI cable connection.	<ul style="list-style-type: none"> <li>• The unit is connected to an input device that is not HDCP (High-bandwidth Digital Content Protection) compliant (“HDMI” on the front panel does not light up) (page 22).</li> </ul>
3D images from the HDMI (IN 1) or HDMI (IN 2) jack do not appear on the TV screen.	<ul style="list-style-type: none"> <li>• Depending on the TV or video component, 3D images may not appear.</li> </ul>
There is no picture or output resolution is low when you make a component video cable connection.	<ul style="list-style-type: none"> <li>• When playing a BD-ROM, a high-resolution image may not be output because of copy protection limitations. We recommend to make a HDMI connection (page 22).</li> </ul>
No picture appears when the video output resolution selected in [Output Video Format] is incorrect.	<ul style="list-style-type: none"> <li>• Press and hold <b>▶</b> and VOL – on the unit for more than 5 seconds to reset the video output resolution to the lowest resolution.</li> </ul>
The dark area of the picture is too dark/the bright area is too bright or unnatural.	<ul style="list-style-type: none"> <li>• Set [Picture Quality Mode] to [Standard] (default) (page 41).</li> </ul>
The picture is not output correctly.	<ul style="list-style-type: none"> <li>• Check the [Output Video Format] settings in [Screen Settings] (page 58).</li> <li>• If the analog and digital signals are output at the same time, set [BD/DVD-ROM 1080/24p Output] in [Screen Settings] to [Off] (page 59).</li> <li>• For BD-ROMs, check the [BD/DVD-ROM 1080/24p Output] settings in [Screen Settings] (page 59).</li> </ul>
Picture noise appears.	<ul style="list-style-type: none"> <li>• Clean the disc.</li> <li>• If the picture output from your system goes through your VCR to get to your TV, the copy-protection signal applied to some BD/DVD programs could affect picture quality. If you still experience problems even when you connect your unit directly to your TV, try connecting your unit to the other input jacks.</li> </ul>
An image is not displayed on the entire TV screen.	<ul style="list-style-type: none"> <li>• Check the setting of [TV Type] in [Screen Settings](page 58).</li> <li>• The aspect ratio on the disc is fixed.</li> </ul>
Color irregularity occurs on the TV screen.	<ul style="list-style-type: none"> <li>• If the speakers are used with a CRT-based TV or projector, install the speakers at least 1.0 ft (0.3 meters) from the TV set.</li> <li>• If the color irregularity persists, turn off the TV set once, then turn it on after 15 to 30 minutes.</li> <li>• Make sure that no magnetic object (magnetic latch on a TV stand, health care device, toy, etc.) is placed near the speakers.</li> </ul>
There is no picture after playing a video/photo file on the iPod/iPhone. (U.S. and Canada models only.)	<ul style="list-style-type: none"> <li>• Select the input on your TV for this system.</li> </ul>

## Sound

Symptom	Problems and solutions
There is no sound.	<ul style="list-style-type: none"><li>• The speaker cord is not connected securely.</li><li>• Check the speaker settings (page 49).</li></ul>
The Super Audio CD sound of a component that is connected to the HDMI (IN 1) or HDMI (IN 2) jack is not output.	<ul style="list-style-type: none"><li>• HDMI (IN 1) and HDMI (IN 2) does not accept an audio format that contains copy protection. Connect the analog audio output of the component to the AUDIO (AUDIO IN L/R) jacks of the unit.</li></ul>
There is no sound from the TV via the HDMI (OUT) jack when using the Audio Return Channel function.	<ul style="list-style-type: none"><li>• Set [Control for HDMI] in [HDMI Settings] of [System Settings] to [On] (page 61). Also, set [Audio Return Channel] in [HDMI Settings] of [System Settings] to [Auto] (page 61).</li><li>• Make sure that your TV is compatible with the Audio Return Channel function.</li><li>• Make sure that an HDMI cable is connected to a jack on your TV that is compatible with the Audio Return Channel function.</li></ul>
The system does not output sound correctly when connected to a set-top box.	<ul style="list-style-type: none"><li>• Set [Audio Return Channel] in [HDMI Settings] of [System Settings] to [Off] (page 61).</li></ul>
Severe hum or noise is heard.	<ul style="list-style-type: none"><li>• Move your TV away from the audio components.</li><li>• Clean the disc.</li></ul>
The sound loses stereo effect when you play a CD.	<ul style="list-style-type: none"><li>• Select stereo sound by pressing AUDIO (page 43).</li></ul>
The sound comes from the center speaker only.	<ul style="list-style-type: none"><li>• Depending on the disc, the sound may come from the center speaker only.</li></ul>
No sound or only a very low-level sound is heard from the surround speakers.	<ul style="list-style-type: none"><li>• Check the speaker connections and settings (pages 20, 49).</li><li>• Check the surround setting (page 31).</li><li>• Depending on the source, the effect of the surround speakers may be less noticeable.</li><li>• A 2 channel source is being played.</li></ul>
Distortion occurs in the sound of a connected component.	<ul style="list-style-type: none"><li>• Reduce the input level for the connected component by setting [Attenuate - AUDIO] (page 59).</li></ul>

## Tuner

Symptom	Problems and solutions
Radio stations cannot be tuned in.	<ul style="list-style-type: none"><li>• Check that the antenna (aerial) is connected securely. Adjust the antenna (aerial) or connect an external antenna (aerial) if necessary.</li><li>• The signal strength of the stations is too weak (when tuning in with automatic tuning). Use manual tuning.</li></ul>

## Playback

Symptom	Problems and solutions
The disc does not play.	<ul style="list-style-type: none"><li>• The region code on the BD/DVD does not match the system.</li><li>• Moisture has condensed inside the unit and may cause damage to the lenses. Remove the disc and leave the unit turned on for about half an hour.</li><li>• The system cannot play a recorded disc that is not correctly finalized (page 71).</li></ul>
File names are not displayed correctly.	<ul style="list-style-type: none"><li>• The system can only display ISO 8859-1-compliant character formats. Other character formats may be displayed differently.</li><li>• Depending on the writing software used, the input characters may be displayed differently.</li></ul>

Symptom	Problems and solutions
A disc does not start playing from the beginning.	<ul style="list-style-type: none"> <li>• Resume play has been selected. Press <b>OPTIONS</b> and select [Play from beginning], then press <b>⊖</b>.</li> </ul>
Playback does not start from the resume point where you last stopped playing.	<ul style="list-style-type: none"> <li>• The resume point may be cleared from memory depending on the disc when <ul style="list-style-type: none"> <li>– you open the disc tray.</li> <li>– you disconnect the USB device.</li> <li>– you play other content.</li> <li>– you turn off the unit.</li> </ul> </li> </ul>
The language for the soundtrack/subtitle or angles cannot be changed.	<ul style="list-style-type: none"> <li>• Try using the BD's or DVD's menu.</li> <li>• Multi-lingual tracks/subtitles or multi-angles are not recorded on the BD or DVD being played.</li> </ul>
Bonus contents or other data that are contained in a BD-ROM cannot be played.	<ul style="list-style-type: none"> <li>• Try the following: ① Remove the disc. ② Turn the system off. ③ Remove and reconnect the USB device (page 35). ④ Turn the system on. ⑤ Insert the BD-ROM with <b>BONUSVIEW/BD-LIVE</b>.</li> </ul>

## USB device

Symptom	Problems and solutions
The USB device is not recognized.	<ul style="list-style-type: none"> <li>• Try the following: ① Turn the system off. ② Remove and reconnect the USB device. ③ Turn the system on.</li> <li>• Make sure that the USB device is securely connected to the  (USB) port.</li> <li>• Check if the USB device or a cable is damaged.</li> <li>• Check if the USB device is on.</li> <li>• If the USB device is connected via a USB hub, disconnect it and connect the USB device directly to the unit.</li> </ul>

## BRAVIA Internet Video

Symptom	Problems and solutions
The picture/sound is poor/certain programs display with a loss of detail, especially during fast-motion or dark scenes.	<ul style="list-style-type: none"> <li>• Picture/sound quality may be poor depending on Internet content providers.</li> <li>• Picture/sound quality may be improved by changing the connection speed. Sony recommends a connection speed of at least 2.5 Mbps for standard-definition video and 10 Mbps for high-definition video.</li> <li>• Not all videos contain sound.</li> </ul>
The picture is small.	<ul style="list-style-type: none"> <li>• Press <b>↑</b> to zoom in.</li> </ul>

## “BRAVIA” Sync ([Control for HDMI])

Symptom	Problems and solutions
The [Control for HDMI] function does not work (“BRAVIA” Sync).	<ul style="list-style-type: none"> <li>• Check that [Control for HDMI] is set to [On] (page 61).</li> <li>• If you change the HDMI connection, turn the system off and on again.</li> <li>• If power failure occurs, set [Control for HDMI] to [Off], then set [Control for HDMI] to [On] (page 61).</li> <li>• Check the following and refer to the operating instructions supplied with the component. <ul style="list-style-type: none"> <li>– the connected component is compatible with the [Control for HDMI] function.</li> <li>– the connected component's setting for the [Control for HDMI] function is correct.</li> </ul> </li> </ul>

## Network connection

---

Symptom	Problems and solutions
The system cannot connect to the network.	• Check the network connection (page 27) and the network settings (page 62).

---

## Built-in/USB wireless LAN connection

---

Symptom	Problems and solutions
You cannot connect your PC to the Internet after [Wi-Fi Protected Setup (WPS)] is performed.	• The wireless settings of the router may change automatically if you use the Wi-Fi Protected Setup function before adjusting the settings of the router. In this case, change the wireless settings of your PC accordingly.
You cannot connect the system to your wireless LAN router.	• Check if the wireless LAN router is on. • Depending on the usage environment, including the wall material, radio wave reception conditions, or obstacles between the system and the wireless LAN router, the possible communication distance may be shortened. Move the system and the wireless LAN router closer to each other. • Devices that use a 2.4 GHz frequency band, such as a microwave, Bluetooth, or digital cordless device, may interrupt the communication. Move the unit away from such devices, or turn off such devices.
The desired wireless router is not detected even if [Scan] is performed.	• Press RETURN to return to the previous screen, and try [Scan] again. If the desired wireless router is still not detected, press RETURN to select [Manual registration].
The system cannot connect to the network or the network connection is unstable.	• The distance between the unit and the wireless LAN router is too far (page 27).

---

# Playable Discs

<b>Blu-ray Disc</b>	BD-ROM <sup>1)</sup> BD-R/BD-RE <sup>2)</sup>
<b>DVD<sup>3)</sup></b>	DVD-ROM DVD-R/DVD-RW DVD+R/DVD+RW
<b>CD<sup>3)</sup></b>	CD-DA (Music CD) CD-ROM CD-R/CD-RW Super Audio CD

<sup>1)</sup>Since the Blu-ray Disc specifications are new and evolving, some discs may not be playable depending on the disc type and the version. Also, the audio output differs depending on the source, connected output jack, and selected audio settings.

<sup>2)</sup>BD-RE: Ver.2.1  
BD-R: Ver.1.1, 1.2, 1.3 including organic pigment type BD-R (LTH type)  
BD-Rs recorded on a PC cannot be played if postscripts are recordable.

<sup>3)</sup>A CD or DVD disc will not play if it has not been correctly finalized. For more information, refer to the operating instructions supplied with the recording device.

## Discs that cannot be played

- BDs with cartridge
- BDXLs
- DVD-RAMs
- HD DVDs
- DVD Audio discs
- PHOTO CDs
- Data part of CD-Extras
- Super VCDs
- Audio material side on DualDiscs
- For U.S. and Canada models: A disc recorded in a color system other than NTSC, such as PAL  
(This system conforms to the NTSC color system.)

## Notes on discs

This product is designed to play back discs that conform to the Compact Disc (CD) standard. DualDiscs and some music discs encoded with copyright protection technologies do not conform to the Compact Disc (CD) standard. Therefore, these discs may not be compatible with this product.

## Note on playback operations of a BD/DVD

Some playback operations of a BD/DVD may be intentionally set by software producers. Since this system plays a BD/DVD according to the disc contents the software producers designed, some playback features may not be available.

## Note about double-layer BDs/DVDs

The playback picture and sound may be momentarily interrupted when the layers switch.

## Region code (BD-ROM/DVD VIDEO only)

Your system has a region code printed on the rear of the unit and will only play a BD-ROM/DVD VIDEO (playback only) labeled with identical region codes or .

# Playable Types of Files

## Note

- Some files may not play depending on the file format, the file encoding, the recording condition, or DLNA server condition.
- Some files edited on a PC may not play.
- The system can recognize the following files or folders in BDs, DVDs, CDs and USB devices:
  - up to folders in the 5th tree
  - up to 500 files in a single tree
- The system can recognize the following files or folders stored in the DLNA server:
  - up to folders in the 20th tree
  - up to 999 files in a single tree
- Some USB devices may not work with this system.
- The system can recognize Mass Storage Class (MSC) devices (such as flash memory or an HDD), Still Image Capture Devices (SICDs), and 101-key keyboards (front  (USB) port only).
- To avoid data corruption or damage to USB memory or other devices, turn the system off before connecting or removing USB memory or other devices.
- The system may not play high bit rate video files from a DATA CD smoothly. It is recommended to play high bit rate video files using a DATA DVD.

## Video<sup>1)</sup>

File format	Extensions
MPEG-1 Video/PS <sup>2)5)</sup>	“.mpg,” “.mpeg,” “.m2ts,”
MPEG-2 Video/PS, TS <sup>2)6)</sup>	“.mts”
Xvid	“.avi”
MPEG4/AVC <sup>2)5)</sup>	“.mkv,” “.mp4,” “.m4v,” “.m2ts,” “.mts”
WMV9 <sup>2)5)</sup>	“.wmv,” “.asf”
AVCHD	3)5)

## Music

File format	Extensions
MP3 (MPEG-1 Audio Layer III)	“.mp3”
AAC <sup>2)4)5)</sup>	“.m4a”
WMA9 Standard <sup>2)4)</sup>	“.wma”
LPCM	“.wav”

## Photo<sup>1)</sup>

File format	Extensions
JPEG	“.jpg,” “.jpeg”
GIF	“.gif”
PNG	“.png”

<sup>1)</sup>The system does not play these files via the DLNA renderer function.

<sup>2)</sup>The system does not play files encoded with DRM.

<sup>3)</sup>The system plays AVCHD-format files that are recorded via a digital video camera, etc. To watch AVCHD-format files, the disc with AVCHD-format files on it must be finalized.

<sup>4)</sup>The system does not play files encoded with Lossless, etc.

<sup>5)</sup>The system does not play these files via the DLNA function.

<sup>6)</sup>The system plays SD resolution only via the DLNA function.



# Supported Audio Formats

Audio formats supported by this system are as follows.

Function	Format							
	LPCM 2ch	LPCM 5.1ch LPCM 7.1ch	Dolby Digital	Dolby TrueHD, Dolby Digital Plus	DTS	DTS-ES Discrete 6.1, DTS-ES Matrix 6.1, DTS96/24	DTS-HD High Resolution Audio	DTS-HD Master Audio
“BD/DVD”	○	○	○	○	○	○	○	○
“HDMI1” “HDMI2”	○	–	○	–	○	–	–	–
“SAT/CABLE” “TV” (DIGITAL IN)	○	–	○	–	○	–	–	–

○: Supported format.

–: Unsupported format.

### Note

- HDMI (IN 1) and HDMI (IN 2) do not input sound in the case of an audio format that contains copy protections such as Super Audio CD or DVD-Audio.
- For the LPCM 2ch format, the supported sampling frequency of the digital signal is up to 96 kHz when using the “HDMI1” or “HDMI2” function, and 48 kHz when using the “TV” or “SAT/CABLE” function.

# Specifications

## Amplifier Section

U.S. models:

**AUDIO POWER SPECIFICATIONS**  
**POWER OUTPUT AND TOTAL HARMONIC DISTORTION:**  
(FTC)

Front L + Front R: With 3 ohms loads, both channels driven, from 180 - 20,000 Hz; rated 60 watts per channel minimum RMS power, with no more than 1% total harmonic distortion from 250 milli watts to rated output.

Other models:

**POWER OUTPUT (rated)**

Front L/Front R: 108 W + 108 W (at 3 ohms, 1 kHz, 1% THD)

**POWER OUTPUT (reference)**

Front L/Front R/Center/Surround L/Surround R: 167 W (per channel at 3 ohms, 1 kHz)

Subwoofer: 165 W (at 3 ohms, 80 Hz)

Inputs (Analog)

**AUDIO (AUDIO IN)** Sensitivity: 450/250 mV

Inputs (Digital)

**SAT/CABLE (COAXIAL)**

**TV (Audio Return Channel/OPTICAL)**

Supported formats: LPCM 2CH (up to 48 kHz), Dolby Digital, DTS

**HDMI (IN 1)/HDMI (IN 2)**

Supported formats: LPCM 2CH (up to 96 kHz), Dolby Digital, DTS

## Video Section

Outputs

**VIDEO:** 1 V<sub>p-p</sub> 75 ohms

**COMPONENT:**

**Y:** 1 V<sub>p-p</sub> 75 ohms

**Pb, Pr:** 0.7 V<sub>p-p</sub>

75 ohms

## HDMI Section

Connector

Type A (19pin)

## BD/DVD/Super Audio CD/CD System

Signal format system

U.S. and Canada models: NTSC

Other models: NTSC/PAL

## USB Section

↔ (USB) port:

Type A (For connecting USB memory, memory card reader, digital still camera, and digital video camera)

## LAN Section

LAN (100) terminal 100BASE-TX Terminal

## Wireless LAN Section (BDV-E580/BDV-T58)

Standards Compliance IEEE 802.11 b/g/n

Frequency and Channel 2.4 GHz - 2.4835 GHz [CH1 -11]

## FM Tuner Section

System PLL quartz-locked digital synthesizer

Tuning range

U.S. and Canada models: 87.5 MHz - 108.0 MHz (100 kHz step)

Other models: 87.5 MHz - 108.0 MHz (50 kHz step)

Antenna (aerial) FM wire antenna (aerial)

Antenna (aerial) terminals 75 ohms, unbalanced

## Speakers

### Front/Surround (SS-TSB106) for BDV-E580/BDV-T58

### Surround (SS-TSB106) for BDV-E880

Dimensions (approx.) 96 mm × 245 mm × 96 mm (3 <sup>7</sup>/<sub>8</sub> in × 9 <sup>3</sup>/<sub>4</sub> in × 3 <sup>7</sup>/<sub>8</sub> in) (w/h/d)

Mass (approx.) 0.6 kg (1 lb 6 oz)

### Front (SS-TSB108) for BDV-E880/BDV-E980

Dimensions (approx.) 96 mm × 775 mm × 72 mm (3 <sup>7</sup>/<sub>8</sub> in × 30 <sup>5</sup>/<sub>8</sub> in × 2 <sup>7</sup>/<sub>8</sub> in) (w/h/d) (wall-mounted part)

275 mm × 1,205 mm × 245 mm (10 <sup>7</sup>/<sub>8</sub> in × 47 <sup>1</sup>/<sub>2</sub> in × 9 <sup>3</sup>/<sub>4</sub> in) (w/h/d) (whole speaker)

Mass (approx.) 1.4 kg (3 lb 2 oz) (wall-mounted part)

2.7 kg (6 lb) (whole speaker)

**Surround (SS-TSB109) for BDV-E980**

Dimensions (approx.)	96 mm × 775 mm × 72 mm (3 <sup>7</sup> / <sub>8</sub> in × 30 <sup>5</sup> / <sub>8</sub> in × 2 <sup>7</sup> / <sub>8</sub> in) (w/h/d) (wall- mounted part) 275 mm × 1,205 mm × 245 mm (10 <sup>7</sup> / <sub>8</sub> in × 47 <sup>1</sup> / <sub>2</sub> in × 9 <sup>3</sup> / <sub>4</sub> in) (w/h/d) (whole speaker)
Mass (approx.)	1.3 kg (2 lb 14 oz) (wall- mounted part) 2.6 kg (5 lb 12 oz) (whole speaker)

**Center (SS-CTB103)**

Dimensions (approx.)	315 mm × 59 mm × 53 mm (12 <sup>1</sup> / <sub>2</sub> in × 2 <sup>3</sup> / <sub>8</sub> in × 2 <sup>1</sup> / <sub>8</sub> in) (w/h/d)
Mass (approx.)	0.4 kg (15 oz)

**Subwoofer (SS-WSB104) for BDV-E580/  
BDV-E880/BDV-T58**

Dimensions (approx.)	380 mm × 330 mm × 191 mm (15 in × 13 in × 7 <sup>5</sup> / <sub>8</sub> in) (w/h/d)
Mass (approx.)	6.3 kg (13 lb 15 oz)

**Subwoofer (SS-WSB105) for BDV-E980**

Dimensions (approx.)	415 mm × 340 mm × 215 mm (16 <sup>3</sup> / <sub>8</sub> in × 13 <sup>1</sup> / <sub>2</sub> in × 8 <sup>1</sup> / <sub>2</sub> in) (w/h/d)
Mass (approx.)	7.8 kg (17 lb 4 oz)

**General**

## Power requirements

U.S. and Canada models:	120 V AC, 60 Hz
Other models:	110 V - 240 V AC, 50/60 Hz

## Power consumption

BDV-E580/BDV-T58	On: 170 W Standby: 0.3 W (at the Power Saving mode)
BDV-E880/BDV-E980	On: 165 W Standby: 0.3 W (at the Power Saving mode)
Dimensions (approx.)	430 mm × 75 mm × 320 mm (17 in × 3 in × 12 <sup>5</sup> / <sub>8</sub> in) (w/h/d) incl. projecting parts
Mass (approx.)	4.1 kg (9 lb 1 oz)

Design and specifications are subject to change without notice.

- Standby power consumption 0.3W.
- Over 85% power efficiency of amplifier block is achieved with the full digital amplifier, S-Master.

# Language Code List

The language spellings conform to the ISO 639: 1988 (E/F) standard.

Code	Language	Code	Language	Code	Language	Code	Language
1027	Afar	1183	Irish	1347	Maori	1507	Samoaan
1028	Abkhazian	1186	Scots Gaelic	1349	Macedonian	1508	Shona
1032	Afrikaans	1194	Galician	1350	Malayalam	1509	Somali
1039	Amharic	1196	Guarani	1352	Mongolian	1511	Albanian
1044	Arabic	1203	Gujarati	1353	Moldavian	1512	Serbian
1045	Assamese	1209	Hausa	1356	Marathi	1513	Siswati
1051	Aymara	1217	Hindi	1357	Malay	1514	Sesotho
1052	Azerbaijani	1226	Croatian	1358	Maltese	1515	Sundanese
1053	Bashkir	1229	Hungarian	1363	Burmese	1516	Swedish
1057	Byelorussian	1233	Armenian	1365	Nauru	1517	Swahili
1059	Bulgarian	1235	Interlingua	1369	Nepali	1521	Tamil
1060	Bihari	1239	Interlingue	1376	Dutch	1525	Telugu
1061	Bislama	1245	Inupiak	1379	Norwegian	1527	Tajik
1066	Bengali; Bangla	1248	Indonesian	1393	Occitan	1528	Thai
1067	Tibetan	1253	Icelandic	1403	(Afan)Oromo	1529	Tigrinya
1070	Breton	1254	Italian	1408	Oriya	1531	Turkmen
1079	Catalan	1257	Hebrew	1417	Punjabi	1532	Tagalog
1093	Corsican	1261	Japanese	1428	Polish	1534	Setswana
1097	Czech	1269	Yiddish	1435	Pashto; Pushto	1535	Tonga
1103	Welsh	1283	Javanese			1538	Turkish
1105	Danish	1287	Georgian	1436	Portuguese	1539	Tsonga
1109	German	1297	Kazakh	1463	Quechua	1540	Tatar
1130	Bhutani	1298	Greenlandic	1481	Rhaeto- Romance	1543	Twi
1142	Greek	1299	Cambodian			1557	Ukrainian
1144	English	1300	Kannada	1482	Kirundi	1564	Urdu
1145	Esperanto	1301	Korean	1483	Romanian	1572	Uzbek
1149	Spanish	1305	Kashmiri	1489	Russian	1581	Vietnamese
1150	Estonian	1307	Kurdish	1491	Kinyarwanda	1587	Volapük
1151	Basque	1311	Kirghiz	1495	Sanskrit	1613	Wolof
1157	Persian	1313	Latin	1498	Sindhi	1632	Xhosa
1165	Finnish	1326	Lingala	1501	Sangho	1665	Yoruba
1166	Fiji	1327	Laothian	1502	Serbo-Croatian	1684	Chinese
1171	Faroese	1332	Lithuanian	1503	Singhalese	1697	Zulu
1174	French	1334	Latvian; Lettish	1505	Slovak		
1181	Frisian	1345	Malagasy	1506	Slovenian	1703	Not specified

## Parental Control/Area Code List

Code	Area	Code	Area	Code	Area	Code	Area
2044	Argentina	2109	Germany	2362	Mexico	2499	Sweden
2047	Australia	2200	Greece	2376	Netherlands	2086	Switzerland
2046	Austria	2219	Hong Kong	2390	New Zealand	2543	Taiwan
2057	Belgium	2248	India	2379	Norway	2528	Thailand
2070	Brazil	2238	Indonesia	2427	Pakistan	2184	United Kingdom
2090	Chile	2239	Ireland	2424	Philippines		
2092	China	2254	Italy	2428	Poland		
2093	Colombia	2276	Japan	2436	Portugal		
2115	Denmark	2304	Korea	2489	Russia		
2165	Finland	2333	Luxembourg	2501	Singapore		
2174	France	2363	Malaysia	2149	Spain		

# Index

## Numerics

- 3D 34
- 3D Output Setting 58

## A

- A/V SYNC 42
- Attenuate - AUDIO 59
- Audio 60
- Audio DRC 59
- Audio Output 59
- Audio Return Channel 61
- Audio Settings 59
- Auto Calibration 48, 60
- Auto Display 62
- Auto Standby 62

## B

- BD Audio MIX Setting 59
- BD Hybrid Disc Playback Layer 60
- BD Internet Connection 60
- BD Parental Control 61
- BD/DVD Menu 60
- BD/DVD Viewing Settings 60
- BD/DVD-ROM 1080/24p Output 59
- BD-LIVE 34
- BONUSVIEW 34
- BRAVIA Internet Video 38
- BRAVIA Sync 47

## C

- CD 71
- Child Lock 51
- Cinema Conversion Mode 58
- Connection Server Settings 62
- Control for HDMI 47, 61

## D

- D.C.A.C. (Digital Cinema Auto Calibration) 48
- DLNA 39, 62
- Dolby Digital 43
- DTS 43
- DVD 71
- DVD Aspect Ratio 58
- DVD Parental Control 61

## E

- Easy Setup 29, 63

## F

- FM MODE 45
- Front panel 11
- Front panel display 12

## G

- Gracenote Settings 62

## H

- HDMI
  - YCbCr/RGB (HDMI) 59
- HDMI Deep Color Output 59

## I

- Illumination/Display 61
- Initialize Personal Information 63
- Internet content 38
- Internet Settings 53, 62
- Internet Video Parental Control 61
- Internet Video Unrated 61

## L

- Language Code List 76

## M

- Media Remote Device
  - Registration 62
- Multiplex broadcast sound 44
- Music Settings 61

## N

- Network Connection
  - Diagnostics 62
- Network Settings 62
- Network Update 57

## O

- OSD 61
- Output Video Format 58

## P

- Parental Control Area Code 61
- Parental Control Settings 61
- Party Auto Start 62
- Password 61
- Pause Mode 59
- Play information 35
- Playable discs 71

## Q

- Quick Start Mode 62

## R

- Rear panel 13
- Region code 71
- Registered Media Remote
  - Devices 62
- Remote control 14
- Renderer Access Control 62
- Renderer Options 62
- Reset to Factory Default Settings 63
- Resetting 63

## S

- Screen Format 58
- Screen Saver 62
- Screen Settings 58
- SLEEP 50
- Slideshow 42
- Sound Effect 60
- Speaker Settings 49, 60
  - Connection 49
  - Distance 49
  - Level 50
- Subtitle 60
- Super Audio CD Playback
  - Channel 61
- Super Audio CD Playback Layer 61
- Surround Setting 60
- System Information 62

## T

- Test Tone 50
- TV Screen Size Setting for 3D 58
- TV Type 58

## U

- Update 57
- USB 35

## W

- WEP 56
- WPA2-PSK (AES) 56
- WPA2-PSK (TKIP) 56
- WPA-PSK (AES) 56
- WPA-PSK (TKIP) 56

The software of this system may be updated in the future. To find out details on any available updates, please visit the following URL.

For customers in the U.S.:  
<http://www.sony.com/support>

For customers in Canada:  
English: <http://www.sony.ca/support>  
French: <http://fr.sony.ca/support>

For customers in Mexico and Latin America:  
<http://esupport.sony.com/LA>



<http://www.sony.net/>

