

FRIGIDAIRE

All about the

Use & Care

of your

Split Type Room Air Conditioner

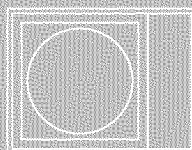

Refer to Page 2 for table of contents.

Welcome to the world of simple handling and no worries

Thank you for choosing Frigidaire. This manual contains all of the information required to guarantee your safety and the appropriate use of your air conditioner.

Please read all of the instructions before using the air conditioner and keep this manual for future reference.

We know you will enjoy your new air conditioner and thank you for choosing our product.

We hope you will consider us for future purchase.

Environmental advices

The packaging material used is recyclable. We recommend that you separate plastic, paper and cardboard and give them to recycling companies. If you need to dispose of this appliance in the future, do NOT throw it away with the rest of your domestic garbage.



Attention

The air conditioner that you have bought may be slightly different from the one illustrated in this manual. Please refer to the information related to the model you have.

This air conditioner is for domestic use only. It is not recommended for commercial or industrial use.

Contents

01. Welcome.....	01
02. Environmental advices.....	01
03. Contents.....	02
04. Safety precautions.....	04
05. Installation:	
5.1 Choosing the installation site.....	06
5.2 Parts list.....	08
5.3 Indoor unit installation.....	10
5.4 Outdoor unit installation.....	14
5.5 Refrigerant piping connection.....	16
5.6 Electrical work.....	18
5.7 Air Purge.....	21
5.8 Electrical safety.....	24
5.9 Gas leak check.....	24
5.10 Test running.....	25
06. Operation:	
6.1 Preparing the device for operation.....	26
6.2 Product description.....	27
6.3 Remote control.....	29
- Remote control operation	
- Remote control specifications	
- Remote control battery	
- When should the batteries be replaced	
- To replace batteries	
- Remote control instructions	
6.4 Remote control description.....	31
- On/Off	
- Mode	
- +	
- -	
- Fan	
- 	
- TIMER ON	
- TIMER OFF	
- Clock	
- Blow	
- TEMP	
- Turbo	
- Sleep	
- LIGHT	
6.5 INTRODUCTION FOR SPECIALFUNCTION.....	37

6.6	How the air conditioner works.....	33
	- Automatic operation	
	- Cool/heat and fan only operation	
	- Dry operation	
	- Airflow direction adjustment	
	- Sleep mode	
	- Timer operation	
	- Optimal operation	
6.7	How to use the indoor unit.....	37
	- Adjusting air flow direction	
	- Adjusting the vertical air flow direction (up/down)	
	- To set the horizontal air flow direction (left/right)	
	- To automatically swing the air flow direction (up/down)	
6.8	Manual operation.....	39
07.	Maintenance.....	40
08.	Operation tips.....	42
09.	Solution for problems.....	44
10.	Major appliance warranty.....	45

Safety precautions

To prevent injury to the user or other people and property damage, the following instructions must be followed.

Incorrect operation due to ignoring of instructions may cause harm or damage. The seriousness is classified by the following indications.

1. Connect with the power properly. Otherwise, it may cause electric shock or fire due to excess heat generation.
2. Always ensure effective grounding. No grounding may cause electric shock.
3. Disconnect the power if strange sounds, smell, or smoke comes from it. It may cause fire and electric shock.
4. Do not operate or stop the unit by switching on or off the power. It may cause electric shock or fire due to heat generation.
5. Do not operate with wet hands or in damp environment. It may cause electric shock.
6. Do not allow water to run into electric parts. It may cause failure of machine, electric shock or fire.
7. Do not use the power cord near flammable gas or combustibles, such as gasoline, benzene, thinner, etc. It may cause an explosion or fire.
8. Do not use the power cord close to heating appliances. It may cause fire and electric shock.

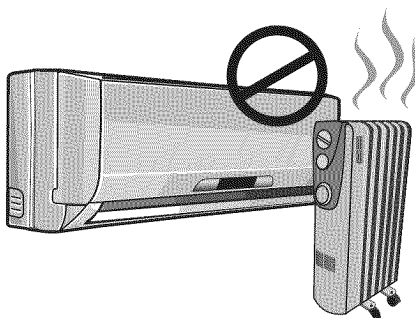

9. Do not damage or use an unspecified power cord. It may cause electric shock or fire.
21. Do not place heavy object on the power cord and ensure that the cord will not be compressed. There is danger of fire or electric shock.

- 11. Do not open the unit during operation. It may cause electric shock or injury.
- 12. Do not drink water drained from air conditioner. It contains contaminants and could make you sick.
- 13. Do not disassemble or modify unit. It may cause failure of appliance and electric shock.

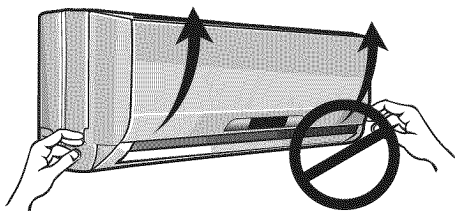

- 14. When the air filter is to be removed, do not touch the metal parts of the unit. It may cause an injury.

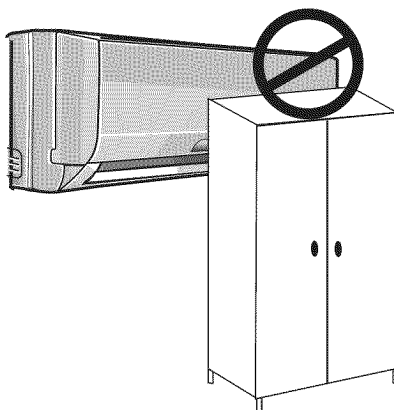

- 15. When the unit is to be cleaned, switch off, and turn off the circuit breaker. Do not clean unit when power is on as it may cause fire, electric shock or injury.
- 16. Avoid direct exposure of occupants to air flow.
- 17. Turn off the main power switch when not using the unit for a long time.

- 18. The air conditioner may be dusted with an oil free cloth, or washed with a cloth dampened in a solution of warm water and mild dishwashing detergent. Rinse thoroughly and wipe dry. Wring excess water from cloth before wiping around controls.

- 19. Ensure that the installation bracket of the outdoor unit will not damage due to prolonged exposure. If bracket damages, there will be concern of damage due to falling of unit.

- 20. Always insert the filters securely. Clean filter once every two weeks. Operation without filters may cause failure.
- 21. Always install circuit breaker and a dedicated power circuit. No installation may cause fire and electric shock.
- 22. Do not place obstacles around air-inlets or inside of air-outlet. It may cause failure of appliance or accident.

Installation

Installation warnings:

1. Carefully read the installation manual before beginning.
2. Follow each step as shown.
3. Observe all local, state, and national electrical codes and by qualified, licensed, authorized personnel only.
4. Pay attention to danger and safety notices

Choosing the installation site

Precautions for Installation

Installation at the following sites may cause problems. If you must inevitably install the unit at one of these sites, please consult your local distributor beforehand:

1. Sites with machine oil.
2. Sites with a high concentration of salinity, such as coastal areas.
3. Sites with sulfuric gas, such as hot water springs.
4. Sites with high frequency equipment, such as wireless equipment, welding machines and medical installations.
5. Sites with flammable gases or volatile material.
6. Sites with special environmental conditions.
7. Laundry rooms.

Indoor Unit

1. The unit must be installed at a site that does not obstruct the flow of air.
2. The site must support the weight of the indoor unit.
3. The site must be easily accessible for maintenance and replacement of the air filter.
4. The site must allow for the necessary space around the indoor unit, as shown in the sideward figure.
5. There should be at least 3 feet (1 meter) between the unit and radio or television devices. It is ideal that the unit be installed at the center.
6. It must be far from fire, smoke or flammable gases.
7. The indoor unit must be at least 8.2

8. ft(2.5 meters) from the ground.
8. The site must allow for the easy removal of the connector pipe and drain hose.
9. The unit must be installed at a site protected from direct sunlight.

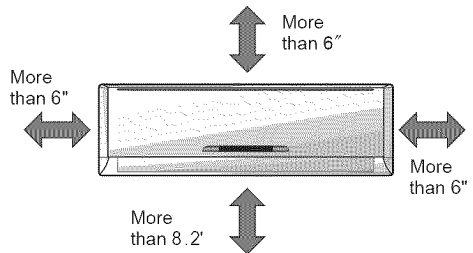

Outdoor Unit

1. The outdoor unit must be installed at a convenient site that is not exposed to strong winds. The site should be dry and well ventilated.
2. The site must support the weight of the outdoor unit and allow for vertical installation.
3. There must not be the possibility of increased noise and vibration at the site.
4. The unit must be installed at a site where the noise produced by its operation and air discharge does not disturb the neighbors or animals.
5. The site cannot have any leakage of flammable gases.
6. The site must provide enough space around the unit, as shown in the figure.
7. Children must not be able to access the installation site.

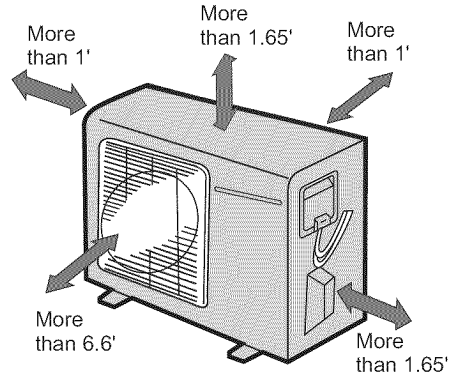

Parts list

NUMBER	PART NAME		QTY.
1	Installation plate		1
2	Drain Joint		1
3	Self-tapping screw A #7 X 1"	capacity ≤ 18000 Btu's	5
		capacity ≥ 24000 Btu's	10
4	Remote controller		1
5	Connecting pipe assembly	Liquid side	Ø1/4"
		Gas side	Ø3/8" (capacity ≤ 12000 Btu's)
			Ø1/2" (capacity ≤ 18000 Btu's)
			Ø5/8" (capacity ≥ 24000 Btu's)
6	Drainage Plug	capacity = 18000 Btu's	3
		capacity = 21500 Btu's	2
7	Remote Controller holder		1
8	Self-tapping screw B #4 X 3/8"		2

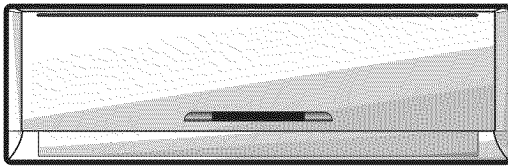

Indoor unit

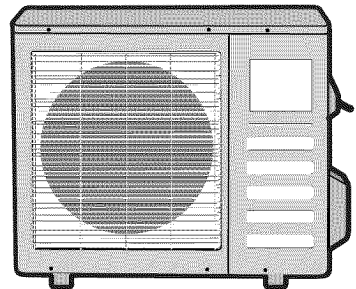
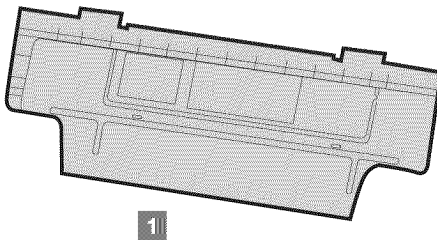
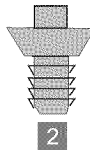
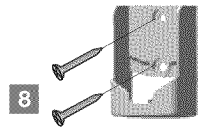

Outdoor unit

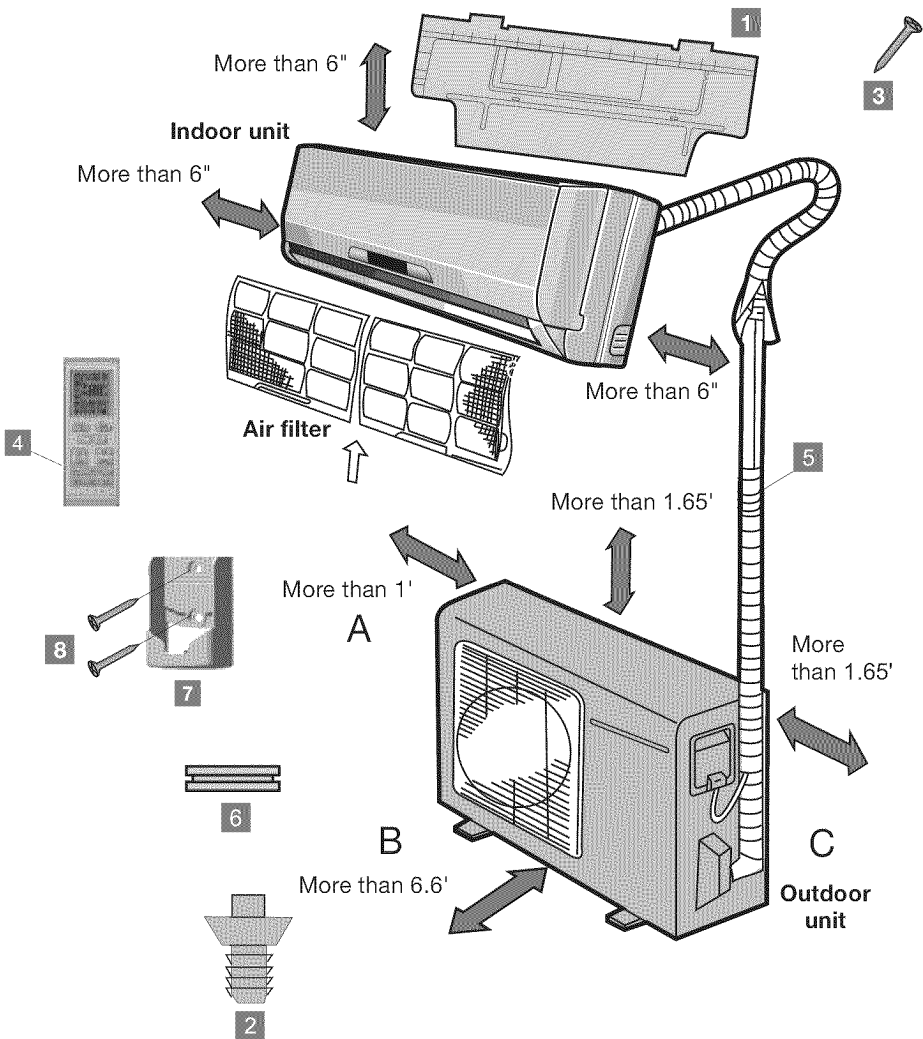

Attention

1. This illustration is for explanation purposes only.
2. Copper tubes must be insulated independently

Indoor unit installation

Installation plates and dimensions

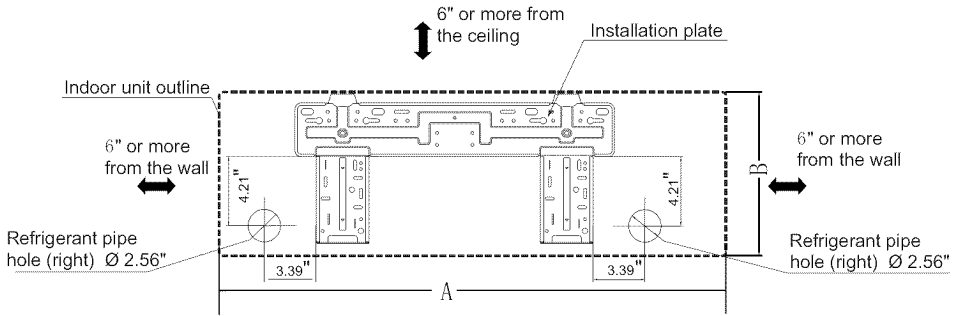

≤12000 Btu's (A:33.31" B:10.83")

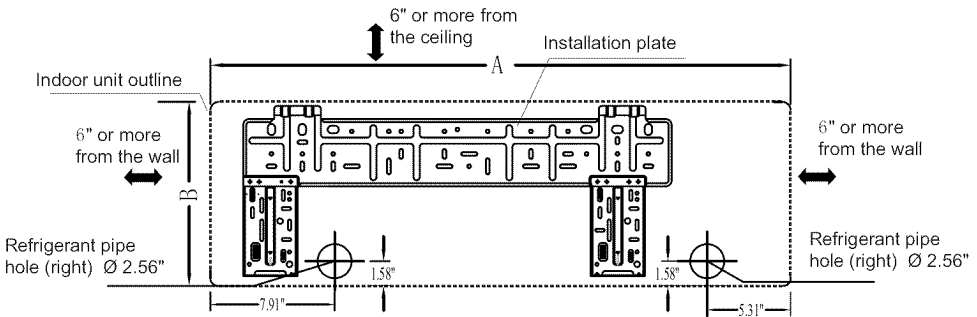

=18000 Btu's (A:36.97" B:11.73")

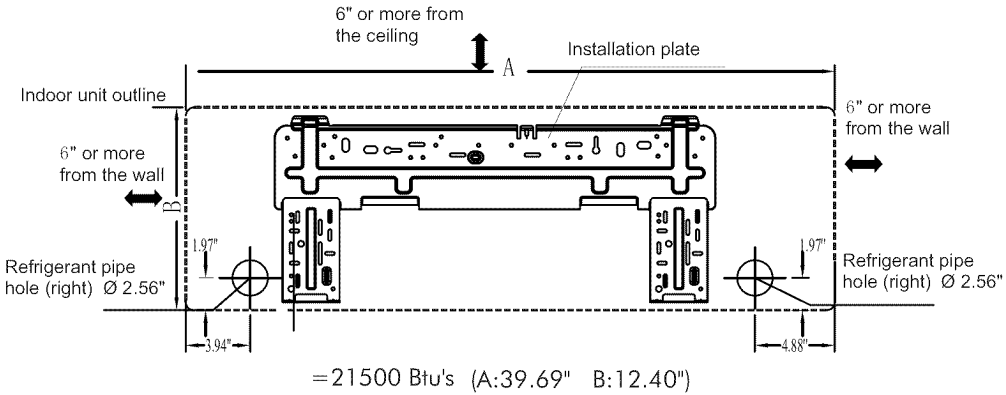

Fixing the Installation Plate

1. Install the installation plate horizontally over the structural parts on the wall using the spaces indicated on the plate, as shown in the figures above.
2. In the case of tiled, concrete or similar walls, create 0.2" diameter holes. Place anchorage supports for the appropriate assembly screws.
3. Fix the installation plate to the wall with eight A type screws.
4. At all times securing to the wall studs is recommended.

Attention

Fit the Installation Plate and drill holes in the wall according to the wall structure and corresponding mounting points on the installation plate (Dimensions are in "mm" unless otherwise stated).

Installation plate

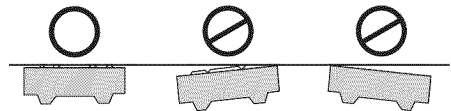

Drilling the Hole

1. Determine the position of the hole for the pipes using the installation plate and drill the pipe hole so that it is tilted slightly downward.
2. Always use a pipe cover with an opening when drilling.

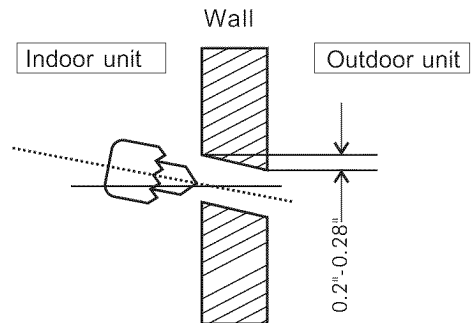

Connective pipe and drainage installation

Connective pipe

1. For the left-hand and right-hand piping, remove the pipe cover from the side panel. The pipe cover must be kept as it may be used when relocating the air conditioner to any other place.
2. For the rear-right-hand and rear-left-hand piping, install the piping as shown in the sideward figure. Bend the connective pipe to be laid at a height of 1.69" or less from the wall. Fix the end of the connective pipe.

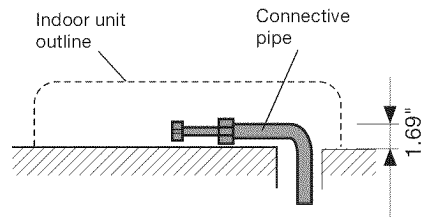
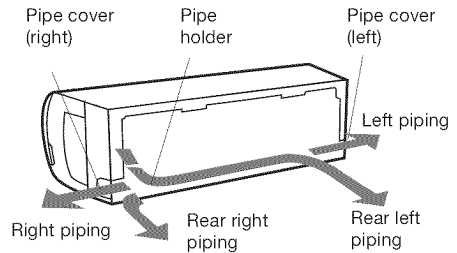

Drainage

1. Run the drain hose sloping downward. Do not install the drain hose as illustrated sideward.
2. When connecting extension drain hose, insulate the connecting part of extension drain hose with a shield pipe, do not let the drain hose slack.

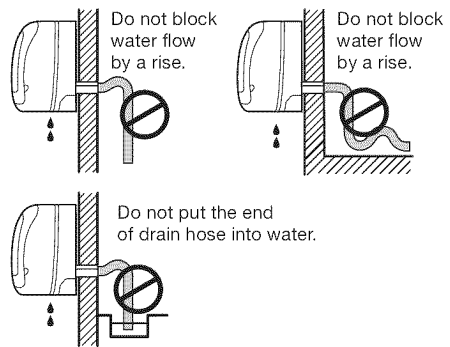

Fastening the Indoor Unit

1. Pass the piping through the hole in the wall.
2. Put the upper claw at the back of the indoor unit on the upper hook of the installation plate, move the indoor unit from side to side to see that it is securely hooked.

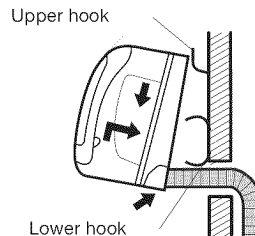

- Piping can easily be made by lifting the indoor unit with a cushioning material between the indoor unit and the wall. Get it out after finish piping.
- Push the lower part of the indoor unit up on the wall, Then move the indoor unit from side to side, up and down to check if it is hooked securely.

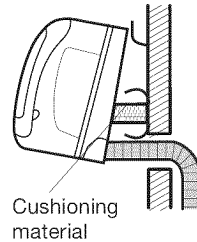

Piping and wrapping

- Bundle the tubing, connecting cable, and drain hose with tape securely and evenly as shown in the sideward figure.
- Because the condensed water from rear of the indoor unit is gathered in ponding box and is piped out of room, do not put anything else in the box.

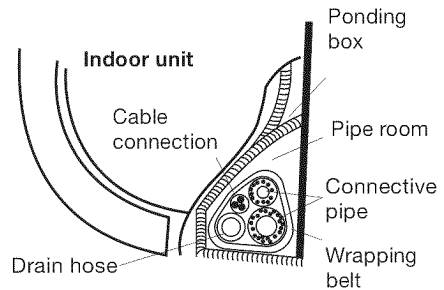

Attention

- Connect the indoor unit first, then the outdoor unit.
- Do not allow the piping to let out from the back of the indoor unit.
- Be careful not to let the drain hose slack.
- Both of the auxiliary piping should be heat insulation.
- Be sure that the drain hose is located at the lowest side of the bundle. Locating at the upper side may cause drain pan to overflow inside the unit.
- Never intercross nor intertwist the power wire with any other wiring.
- Run the drain hose sloped downward to drain out the condensed water smoothly.

Outdoor unit installation

1. Install the outdoor part of the unit on a rigid surface to avoid excess noise and vibration.
2. Direct the air vent toward an area without obstacles.
3. Install the unit at the site where it is exposed to as little wind as possible, especially in areas where it is frequently windy.
4. If the installation site is exposed to heavy winds, such as in coastal areas, place the unit along the widest part of the wall or use protective plates.
5. If suspended installation is needed, purchase kit No.EA140S from your local or servicer. The installation bracket should accord with technique requirement in the installation bracket diagram. The installation wall should be solid brick, concrete or the same intensity construction, or action to reinforce, damping supporting should be taken. The connection between bracket and wall, bracket and the air conditioner should be firm, stable and reliable.
6. Be sure there is no obstacle which blocks radiating air, including shrubs or bushes.

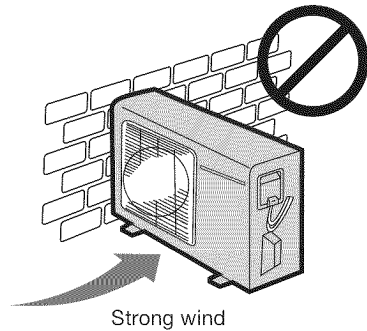
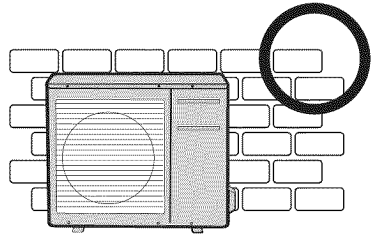

Settlement of outdoor unit
Anchor the outdoor unit tightly and horizontally on a concrete or rigid mount with a bolt and nut 0.39" or 0.32" diameter (Purchased separately).

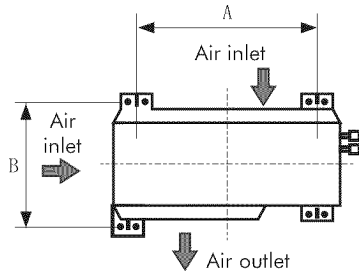

Outdoor unit dimension ft(WxHxD)	A(ft)	B(ft)
2.78'x1.77'x1.05'	1.77'	0.94'
2.92'x2.30'x1.30'	1.84'	1.18'
3.02'x2.59'x1.40'	2.00'	1.28'

Condensate drainage of outdoor unit (no for cooling only)

The condensate and defrosting water formed during heating in the outdoor unit can be properly discharged by drainage pipe .

Installation method: Insert the drain connection into one of the $\varnothing 25$ holes of the chassis and then connect drainage pipe with drain nozzle. Insert drainage plugs into the other holes
(Only for ≥ 12000 Btu's).

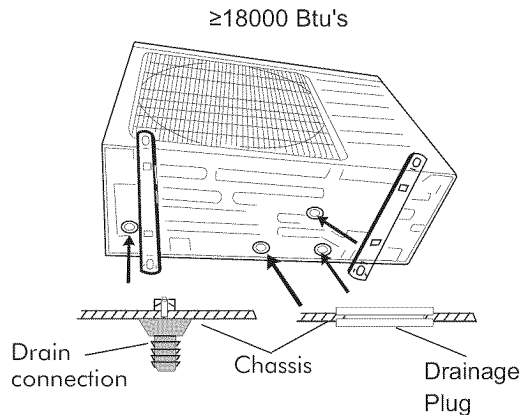
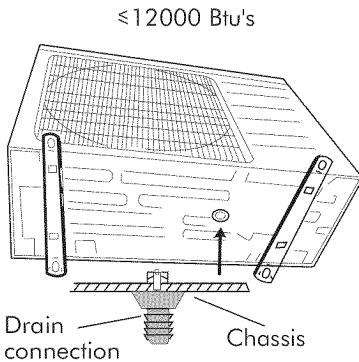

Refrigerant piping connection

Unit comes with 16.4' tubing bundle. It is not recommended to cut. If too long, loop for excess.

Note: Keep original bend so not kinking of the tube occurs.

Flaring work

Main cause for refrigerant leakage is due to defect in the flaring work.

Carry out correct flaring work using the following procedure:

1. Cut the pipes and the cable.
 - A) Use the piping kit accessory or pipes purchased locally.
 - B) Measure the distance between the indoor and the outdoor unit.
 - C) Cut the pipes a little longer than the measured distance.
 - D) Cut the cable 4.9ft longer than the pipe length.
2. Burr removal
 - A) Completely remove all burrs from the cut cross section of pipe/tube.
 - B) Put the end of the copper tube/pipe in a downward direction as you remove burrs in order to avoid dropping burrs into the tubing.
3. Put nut on.

Remove flare nuts attached to indoor and outdoor unit, then put them on pipe/tube having completed burr removal.(It is not possible to put them on after flaring work)

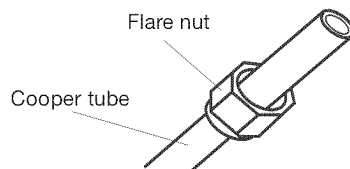
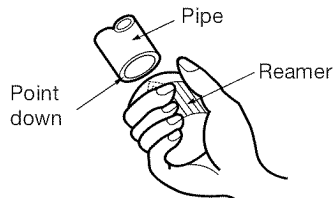
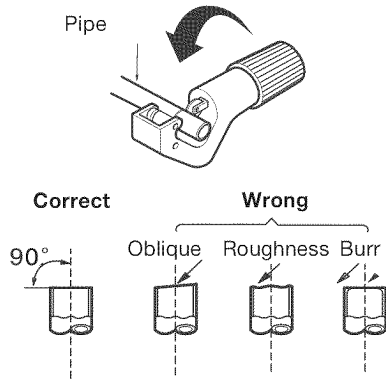

4. Flaring work.

Firmly hold copper pipe in a die in the dimension shown in the table below.

OUTER DIAMETER (inch)	A (inch)	
	Max.	Min.
1/4	0.051	0.028
3/8	0.063	0.039
1/2	0.071	0.039
5/8	0.095	0.087

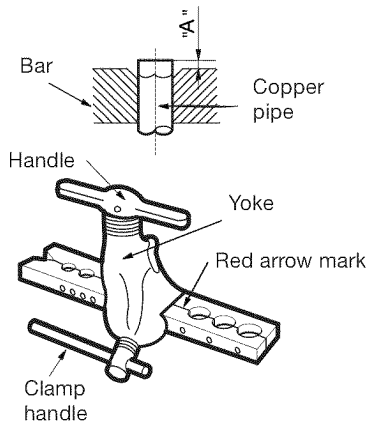

Connection Adjustment

1. Align the pipes to be connected.
2. Screw the flare nut with your fingers, and then tighten it with a spanner and torque wrench, as shown in the following figure.

Caution: Excessive twisting may break the nut, depending on the installation conditions.

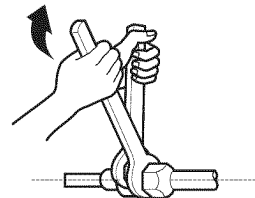
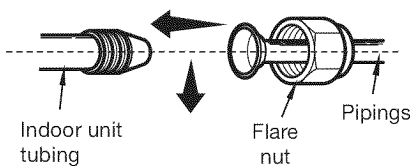

OUTER DIAMETER (inch)	TIGHTENING TORQUE (lbf-in)	ADDITIONAL TIGHTENING TORQUE (lbf-in)
1/4	139	174
3/8	260	304
1/2	434	477
5/8	651	694

Electrical work

Electric safety regulations for the initial Installation

1. If there is serious safety problem about the power supply, the technicians should refuse to install the air conditioner and explain to the client until the problem is solved.
2. Power voltage should be in the range of 90%~110%of rated voltage.
3. The circuit protector and main power switch with a 1.5 times capacity of Max. Current of the unit should be installed in power circuit.
4. Ensure the air conditioner is grounded well.
5. According to the attached Electrical Connection Diagram located on the panel of the outdoor unit to connect the wire.
6. All wiring must comply with local and national electrical codes and be installed by qualified and skilled electricians.
7. An individual branch circuit used only for this air conditioner must be available. See the following table for suggested wire sizes and fuse specifications:

CAPACITY	POWER SUPPLY	INPUT RATED AMP Switch / Fuse	AWG WIRE SIZE
≤ 9000 Btu's	115V~/ 60Hz	25A/25A	12
9000 Btu's < capacity ≤ 12000 Btu's	115V~/ 60Hz	25A/25A	12
> 12000 Btu's	208/230V~/ 60Hz	25A/25A	12

Note: The supply voltage must be consistent with the rate voltage of the air conditioner.

Connect the cable to the indoor unit

1. The inside and outside connecting cable can be connected without removing the front grille.
2. Connecting cable between indoor unit and outdoor unit shall be approved polychloroprene sheathed flexible cord, type designation 16AWG or heavier cord.
3. Lift the indoor unit panel up, remove the electrical box cover by loosening the screw.
4. Ensure the colour of wires of outdoor unit and the terminal Nos. are the same to the indoors respectively.
5. Wrap those cables not connected with terminals with insulation tapes, so that they will not touch any electrical components. Secure the cable onto the control board with the cord clamp.

Electrical box cover

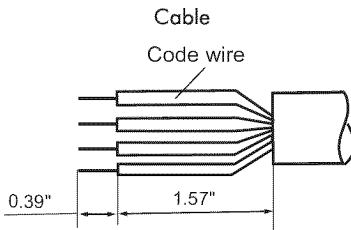
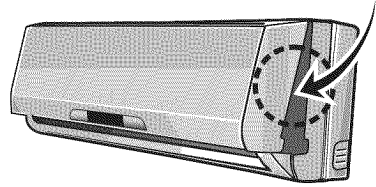

Terminal block of indoor unit

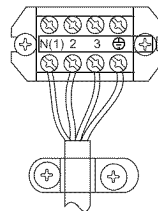

To Outdoor Unit

Connect the cable to the outdoor unit

1. Remove the electrical control board cover from the outdoor unit by loosening the screw.
2. Connect the connective cables to the terminals as identified with their respective matched numbers on the terminal block of indoor and outdoor units. The connective cable to power supply shall be approved polychloroprene sheathed flexible cord, type designation 12AWG or heavier cord.
3. Secure the cable onto the control board with the cord clamp.
4. To prevent the ingress of water, form a loop of the connective cable as illustrated in the installation diagram of indoor and outdoor units.
5. Insulate unused cords (conductors) with PVC -tape. Process them so they could not touch any electrical or metal parts.

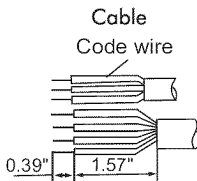
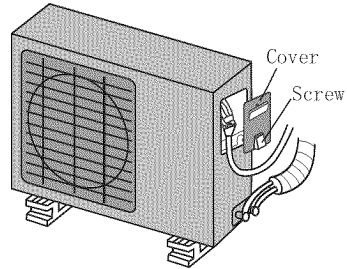

Terminal block of outdoor unit

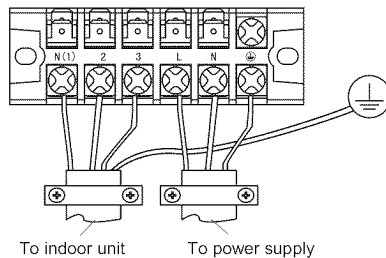

Caution

After the confirmation of the above conditions, prepare the wiring as follows:

1. Never fail to have an individual power circuit specifically for the air conditioner. As for the method of wiring, be guided by the circuit diagram posted on the inside of control cover.
2. The screws which fasten the wiring in the casing of electrical fittings are liable to come loose from vibrations to which the unit is subjected during the course of transportation. Check them and make sure that they are all tightly fastened. (If they are loose, it could cause burn-out of the wires.)
3. Specification of power source.
4. Confirm that electrical capacity is sufficient.
5. See to that the starting voltage is maintained at more than 90 percent of the rated voltage marked on the name plate.
6. Confirm that the cable thickness is as specified in the power source specification.
7. Always install an earth leakage circuit breaker in a wet or moist area.
8. The following would be caused by voltage drop: vibration of a magnetic switch, which will damage the contact point, fuse breaking, disturbance of the normal function of the overload protector.
9. The means for disconnection from a power supply shall be incorporated in the fixed wiring and have an air gap contact separation of at least 1/8 inch in each active (phase) conductors.

Air purging

Air and moisture in the refrigeration system have undesirable effects as indicated below:

1. Pressure in the system rises.
 2. Operating current rises.
 3. Cooling or heating (only for models with heating function) efficiency drops.
 4. Moisture in the refrigerant circuit may freeze and block capillary tubing.
 5. Water may lead to corrosion of parts in the refrigeration system.
- Therefore, the indoor unit and tubing between the indoor and outdoor unit must apply leakage test and be evacuated to remove any noncondensables and moisture from the system.

Air purging with vacuum pump

1. Check that each tube(both liquid and gas side tubes) between the indoor and outdoor units have been properly connected and all wiring for the test run has been completed. Remove the service valve caps from both the gas and the liquid side on the outdoor unit. Note that both the liquid and the gas side service valves on the outdoor unit are kept closed at this stage.
2. When relocating the unit to another place, perform evacuation using vacuum pump.
3. Pipe length and refrigerant amount:

Connective pipe length	Air purging	Additional amount of refrigerant to be charged
Less than 25'	Use vacuum pump.	—————
25'~65.6'	Use vacuum pump.	R410a: 1.058ozs (Pipe length-25') (\leq 12000 Btu's)
25'~98.4'	Use vacuum pump.	R410a: 0.705ozs (Pipe length-25') (=18000 Btu's)
		R410a: 1.058ozs (Pipe length-25') (=21500 Btu's)

Caution in handling the packed valve integrated in the outlets of outdoor unit.

1. Operation of opening packed valve: Open the valve stem until it hits against the stopper. Do not try to open it further.
2. Operation of closing packed valve: Securely tighten the valve stem with a special tool. Then securely tighten the valve stem cap with a spanner or the like. Refer to tightening torque table in page 17 for valve stem cap tightening torque

Note: There is a charging port integrated in the low side outlet, but not in the high side outlet. The low side outlet is shown in the sketch map below.

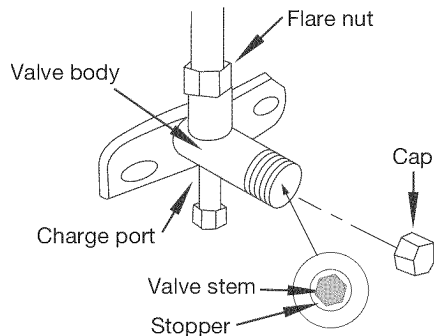
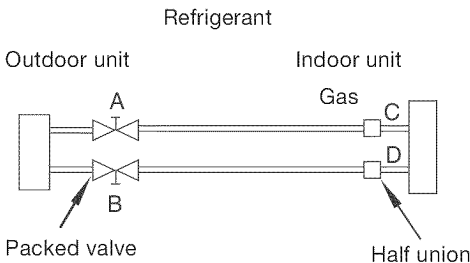

When using the vacuum pump

For method of using a manifold valve, refer to its operation manual.

1. Completely tighten the flare nuts at connection point A, B, C and D. Connect valve core removal tool to the charging port, then connect vacuum hose to valve core tool. Open the schrader valve.
Note: The schrader valve is inside the charging port.
2. Connect the other charge hose of manifold valve to the vacuum pump.
3. Fully open the handle Lo of the manifold valve.
4. Operate the vacuum pump to evacuate. After starting evacuation, slightly loose the flare nut of the Lo valve on the gas pipe side and check if the air is entering (Operation noise of the vacuum pump changes and a compound meter indicates 0 instead of minus), then tighten the flare nut. The procedure verifies if there are blocks inside the tubes.
5. Make evacuation for 15 minutes or more and check that the compound meter indicates $-7.6 \times 10^5 \mu\text{mHg}$ ($-1 \times 10^5 \text{Pa}$). After the evacuation is completed, fully close the handle Lo of the manifold valve and stop the operation of the vacuum pump.
6. Turn the stem of the packed valve B about 45° counterclockwise for 6~7 seconds after the gas comes out, then tighten the flare nut again. Make sure the pressure

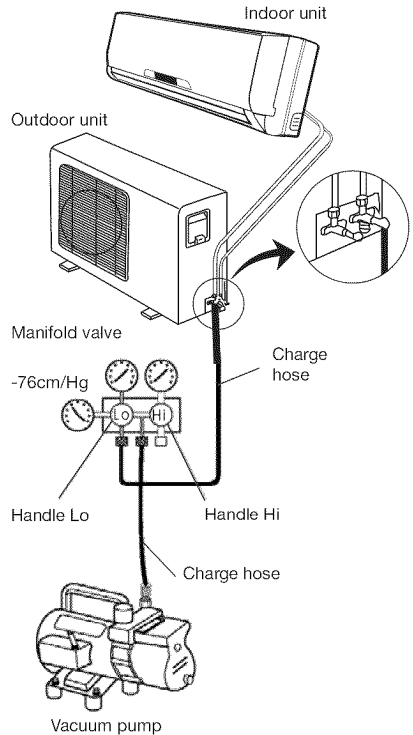

display in the pressure indicator is a little higher than the atmosphere pressure. This procedure verifies if the refrigerant goes through the tubes correctly.

7. Close the schrader valve, then remove the valve core tool. Replace the charging port cap.
8. Fully open the packed valve stems B and A.
9. Securely tighten the cap of the packed valve.

Electrical safety

Perform the electric safety check after completing installation:

1. Insulated resistance: The insulated resistance must be more than $2M\Omega$.
2. Grounding work: After finishing grounding work, measure the grounding resistance by visual detection and grounding resistance tester. Make sure the grounding resistance is less than 4Ω .
3. Electrical leakage check (performing during test running): During test operation after finishing installation, the serviceman can use the electric probe and multimeter to perform the electrical leakage check. Turn off the unit immediately if electrical leakage happens. Check and find out the solution ways till the unit operates properly.

Gas leak check

Soap water method

Apply a soap water or a liquid neutral detergent on the indoor unit connection or outdoor unit connections by a soft brush to check for leakage of the connecting points of the piping. If bubbles come out, the pipes have leakage point.

Leak detector

Use the leak detector to check for leakage.

Caution

A: Lo packed valve, B: Hi packed valve
C and D are ends of indoor unit connection.

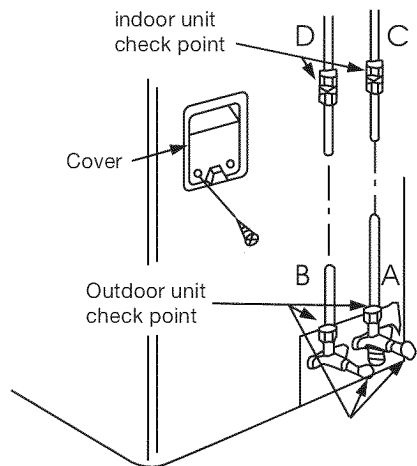

Test running

Perform test operation after completing gas leak check at the flare nut connections and electrical safety check.

1. Connect the power, press the ON/OFF button on the remote controller to turn the unit on.
2. Use the MODE button to select COOL, HEAT(Only for models with heating function), AUTO and FAN to check if all the functions work well.
3. When the ambient temperature is too low(lower than 63°F), the unit cannot be controlled by the remote controller to run in cooling mode, manual operation can be taken. Manual operation is used only when the remote controller is disable or maintenance necessary.

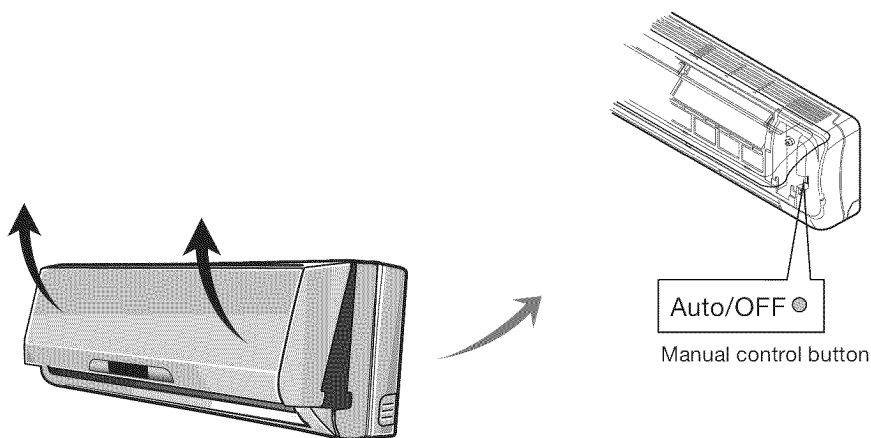

Preparing the device for operation

1. Contact a specialist to install the device.
2. Guarantee that the unit is appropriately fastened and complies with all of the aforementioned safety norms.
3. Before operating the air conditioner, ensure that the air filter is installed correctly.
4. If the unit has been out of use for a long period of time, it is recommended that the air filter be cleaned before use. During continuous use, clean the air filter every two weeks.
5. This air conditioner was designed for use under the following conditions:

MODE					
Cool		Heat*		Dehumidifier	
Temperature		Temperature		Temperature	
Indoor	Outdoor*	Indoor	Outdoor	Indoor	Outdoor
61°F~86°F	41°F~115°F	61°F~86°F	5°F~86°F	61°F~86°F	41°F~115°F

* 23°F~115°F, for the models with low temperature cooling system

* only for models with heating function

Attention

If air conditioner is used outside of the above conditions, certain safety protection features may come into operation and cause the unit to function abnormally. Room relative humidity should be less than 80%. If the air conditioner operates in excess of this figure, the surface of the air conditioner may attract condensation. Please set the horizontal louver to its maximum angle (vertically to the floor), and set HIGH fan mode. Optimum performance will be achieved within these operating temperature.

Product description

- 1 Front panel
- 2 Air filter
(beneath front panel)
- 3 Horizontal airflow grille
- 4 Vertical airflow grille
- 5 Temperature sensor
(inside the indoor unit)
- 6 Panel
- 7 Infrared signal receiver
- 8 Refrigerant gas connector
- 9 Remote control
- 10 Connecting cable
- 11 Detection valve
- 12 Drain hose and refrigerant connecting pipe

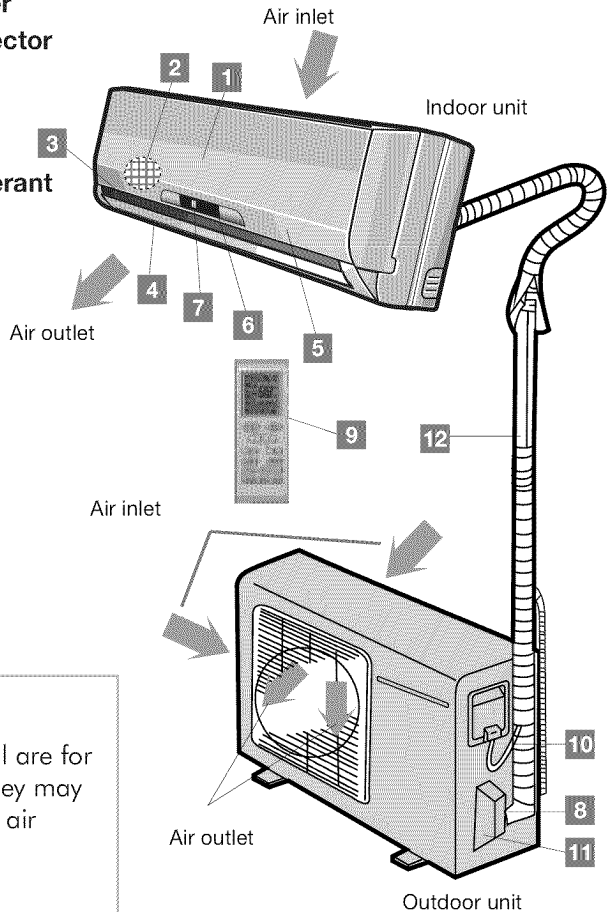

Attention

All the pictures in this manual are for explanation purpose only. They may be slightly different from the air conditioner you purchased.

Display panel (indoor unit)

- 13 HEAT indicator:** This indicator illuminates when the air conditioner is in Heat operation
- 14 COOL indicator:** This indicator illuminates when the air conditioner is in cool operation
- 15 DIGITAL SCREEN:** Show the present adjustments to temperature when air conditioner is operating.
- 16 OPERATION indicator:** This indicator illuminates red after power is on and illuminates green when the unit is in operation.
- 17 DRY indicator:** This indicator illuminates when the air conditioner is in Dry operation

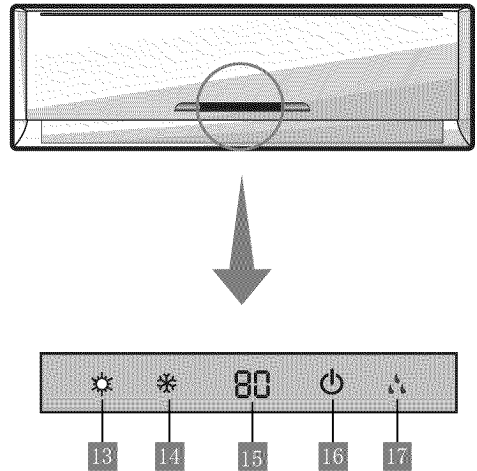

Attention

The description of the control is based on a typical model. The functions are the same in your air conditioner, even if there are some differences in the appearance.

Remote control

Remote control operation

1. Operation mode: Cool, Heat (Only for models with heating function), DRY, FAN, and AUTO (Automatic).
2. 24 hrs Timer.
3. Internal temperature range selection: 61°F - 86°F
4. LCD

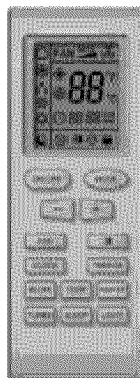

REMOTE CONTROL SPECIFICATIONS

Rated voltage	3 V
Lowest voltage of CPU emitting signal	2.4 V
Transmission distance	32.8'*
Environment	23°F ~ 140°F
* With 3 V, reaches 40'	

Attention

1. The air conditioner will not operate when curtains, doors or other materials block the signals between the remote control and the indoor unit.
2. Avoid spilling any liquid in the remote control. Do not expose to sunlight or any heat source.
3. If the infrared signal receiver in the indoor unit is exposed to sunlight, the air conditioner unit might not work properly. Use curtains or shades to avoid having sunlight directly to the receiver.
4. If other electrical equipments react to the signals sent by the remote control, change their position or consult with you local dealer.

Remote control battery: To use the remote control, it is necessary to install two (R03/Ir03x2) alkaline AAA batteries.

When should the batteries be replaced

1. There is not a "beep" anymore from the indoor unit when using the control remote or the signal light indicator does not light.
2. The indoor unit does not respond to the remote control commands to activate the programs.

To replace batteries

1. Slide out the battery compartment cover (located at the back of the remote control).
2. Install two AAA batteries in the compartment (indicated in the drawing located inside the compartment).
3. Slide in the cover.
4. If the remote control is not operated for long period of times, batteries should be discarded.

Remote control instructions

1. The signal reach distance of the remote control to the receiver that is inside the indoor unit of the air conditioner is 32.8 ft. Any obstruction placed between the receiver and the remote control can cause interference, limiting the capacity of the programming.
2. Any time when a button is pressed on the remote control, the air conditioner emits a "beep" that indicates that a command has been received and transmitted to the indoor unit.

3. When selecting the function of timer, the remote control sends (automatically) a signal to the indoor unit at the specific period. If the remote control is left in a position that the signal is blocked, a 15 minute delay can be produced.

Attention

1. When replacing batteries, do not use old batteries or a different type battery. This may cause the remote control to malfunction.
2. If you do not use the remote controller for several weeks, remove the batteries. Otherwise battery leakage may damage the remote controller.
3. The average battery life under normal use is about 6 months.
4. Replace the batteries when there is no answering beep from the indoor unit or if the transmission indicator fails to light.

Remote control description

- 1 **ON/OFF:** Press this button to start the unit operation. Push the button again to stop the unit operation.
- 2 **MODE:** Each time you press the button, a mode is selected in a sequence that goes from AUTO, COOL, DRY, FAN, and HEAT*, as the following figure indicates:



* Note: Only for models with heating function

- 3 **+**: Press the button to increase the indoor temperature setting.
- 4 **-**: Press the button to decrease the indoor temperature setting.
- 5 **FAN**: This button is used for setting Fan Speed in the sequence that goes from AUTO, , to , then back to Auto.

- 6 : Press this button, to set up swing angle and swing range, which circularly changes as below:

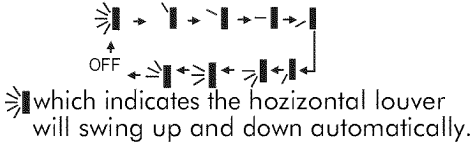



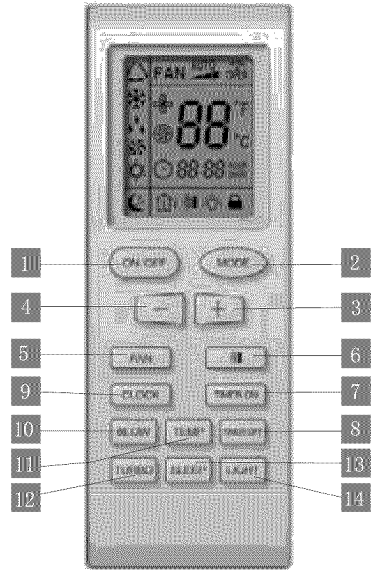

- 7 **TIMER ON:** Press this button to initiate the auto-on timer. To cancel the auto-timer program, simply press this button again.

Cooling and heating model



- 8 **TIMER OFF:** Press this button to initiate the auto-off timer. To cancel the auto-timer program, simply press the button again.
- 9 **CLOCK:** Press this button, the clock can be set up, icon blinks. Within 5 seconds, the value can be adjusted by pressing "+" or "-" button, if continuously press this button for 2 seconds above, in every 1/2 seconds, one minute will be increased, if you are still pressing the button after ten minutes increased, ten minutes will be increased every 1/2 seconds. During blinking, repress the Clock button, icon will be constantly displayed and it denotes the setting succeeded

10 BLOW: When in cool or dry mode, press "BLOW" button to active or deactivate blow function, the icon  will display and the indoor fan will continually run for 10 minutes in order to dry the indoor unit even though you have turned off the unit.

11 TEMP: When pressing "TEMP" button, there may be 3 optional icon display: , , . But only  is effective. The display panel will indicate ambient temperature for 5 seconds.



12 TURBO: Press this button to activate /deactivate the Turbo function which enables the unit to reach the preset temperature in the shortest time. In cooling mode, the unit will blow strong cooling air with super high fan speed. In heating mode, the unit will blow strong heating air with super high fan speed.

13 SLEEP: Press this button to go into the SLEEP operation mode. Press it again to cancel. This function only can be used in COOL, HEAT (Only for models with heating function) or DRY mode, and maintain the most comfortable temperature for you. To cancel SLEEP program, press this button again.

14 LIGHT: Turn the unit LED light on or off only.

INTRODUCTION FOR SPECIAL FUNCTION

1. ABOUT LOCK

Press "+" and "-" buttons simultaneously to lock or unlock the keypad. If the remote controller is locked, the icon  will be displayed on it, in that case, press any button, the mark will  flicker for three times. Repress the combination to unlock.

2. About switch between Fahrenheit and Centigrade

Under status of unit off, press "MODE" and "-" buttons simultaneously to switch °C and °F.

How the air conditioner works

Automatic operation



When the Air Conditioner is ready for use, switch on the power and the OPERATION indicator lamp on the display panel of the indoor unit starts illuminating.

1. Use the MODE button to select AUTO.
2. Use the "MODE" button to select Auto. The unit will automatically select Cool, Fan and Heat operation depending on the difference ambient temperature and system difference temperature .When in Cool Operation the panel will display 77°F. In Fan Operation the panel will display 77°F In Heat Operation the panel will display 68°F.
3. Press the ON/OFF button again to stop the unit operation.

Attention

1. When you set the air conditioner in AUTO mode, it will automatically select cooling, heating(only for models with heating function) or fan only operation depending on what temperature you have selected and the room temperature.
2. If the AUTO mode is uncomfortable, you can select desired conditions manually.

COOL / HEAT and FAN ONLY operation

1. If the AUTO mode is not comfortable, you may manually override the settings by using COOL, HEAT* or FAN ONLY** mode.
2. Press the "+" / "-" button to set the desired room temperature. When in COOL mode, the most comfortable settings are 70°F or above. When in HEAT mode, the most comfortable settings are 82°F or below.
3. Press the FAN to select the FAN mode of AUTO,  ,  or .
4. Press the ON/OFF button, the operation lamp lights and the air conditioner start to operate as your settings. Press the ON/OFF button again to stop this unit operation.

* Note: Only for models with heating function

**Note: The FAN ONLY mode can not be used to control the temperature. While in this mode, only steps 1,3 and 4 may be performed.

DRY operation

The dry mode will automatically select the drying operation based on the difference between the set temperature and the actual room temperature.

The temperature is regulated while dehumidifying by repeating turning on and off of the cooling operation or fan only. The fan speed is mainly LOW.

1. Press the MODE button to select DRY.
2. Press the "+" / "-" button to set the desired temperature from 61°F to 86°F.
3. Press the ON/OFF button, the operation lamp lights and the air conditioner starts to operate in the DRY mode. FAN SPEED is Low. Push the ON/OFF button again to stop this unit operation.

Attention

Due to the difference between the set temperature of the unit and the actual indoor temperature, the Air Conditioner in DRY mode will automatically switch the operation modes between COOL and FAN ONLY many times.

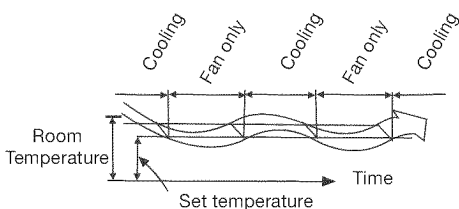

DRY FUNCTION

Air flow direction adjustment

Use  button to adjust the airflow direction up and down.

When  button is pressed, the horizontal louver moves up and down automatically. Press again to stop operation.

Attention

If the louver oscillates or moves in a position that could affect the cooling or heating (only for models with heating function) of the air conditioner, the direction of the oscillation/movement would alter automatically.

SLEEP mode(Only for >12000 Btu's)

Press the sleep button to activate the sleep mode. To deactivate, press the button again.

In cooling mode:

- The fan speed will be automatically controlled
- The air conditioner will automatically increase 2°F per hour in a 2 hour period. The set temperature will be steady for the next 5 hours, then this mode will be terminated.

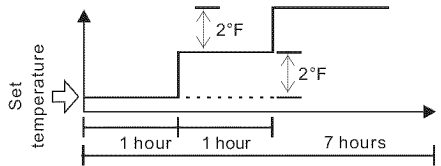

SLEEP FUNCTION (Cooling mode)

In heating mode (only for models with heating function):

- The fan speed will be automatically controlled
- The air conditioner will automatically decrease 2°F per hour in a 2 hour period. The set temperature will be steady for the next 5 hours, then this mode will be terminated.

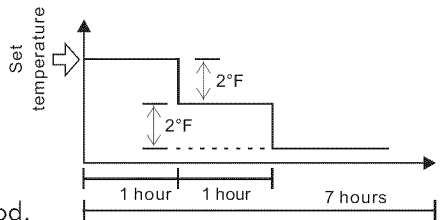

SLEEP FUNCTION (Heating mode)

TIMER Operation

TIMER button can set the auto-on time of the unit.

To set the starting time

1. Press the "TIMER ON" button to activate the auto start timer function . Auto start can be set from 0~24 hours. After pressing "TIMER ON" button, "ON" on the display will blink, and during 5 seconds blinking ,the value can be adjusted by pressing "+" or "-" button. Every press of this button, 1 minute will be increased or decreased, but continuously press the "+" or "-" button, 2 seconds later the value will be increased or decreased automatically ,and after 10 minutes increase or decreased, the value will be changed 10 minutes every 0.5 second; Press the "TIMER ON" button to conform the time.
2. when repressing the "TIMER ON" button , the "TIMER ON" setting will be canceled.

To set the stopping time

1. Press the "TIMER OFF" button to activate the auto start timer function.
2. The method of setting is the same as above of "TIMER ON".

Exemples:

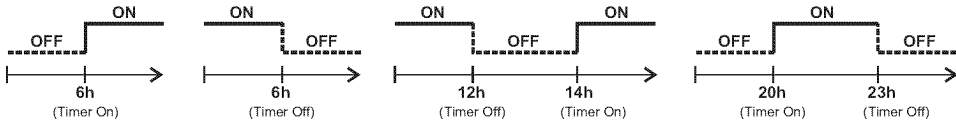

Optimal operation

To achieve optimal performance, please note the following:

1. Adjust the air flow direction correctly so that it is not directed on people.
2. Adjust the temperature to achieve the highest comfort level. Do not adjust the unit to excessive temperature levels.
3. Close doors and windows on COOL or HEAT(only for models with heating function)mode, or performance may be reduced.
4. Use TIMER ON button on the remote controller to select a time you want to start your air conditioner.
5. Do not put any object near air inlet or air outlet, as the efficiency of the air conditioner may be reduced and the air conditioner may stop running.
6. Clean the air filter periodically, otherwise cooling or heating(only for models with heating function) performance may be reduced.
7. Do not operate unit with horizontal louvre in closed position.

How to use the indoor unit

Adjusting air flow direction

Adjust the air flow direction properly otherwise, it might cause discomfort or cause uneven room temperatures. Adjust the horizontal louver using the remote controller. Adjust the vertical louver manually.

To set the horizontal air flow direction (left/ right)

Adjust the vertical louver manually using the lever on the left or right side of the vertical louver arm (Depending on the specific model you choose), or move the lever at the left(or right, or middle which is only for 24000 Btu's, depending on the specific model you choose) end of the air outlet to the desired position. Perform these adjustments before you start the unit because once it has been started, there is risk of your fingers getting caught on the fan.



To automatically swing the air flow direction (up/down)

Perform this function while the air conditioner is in operation.

Press the  button on the remote controller.

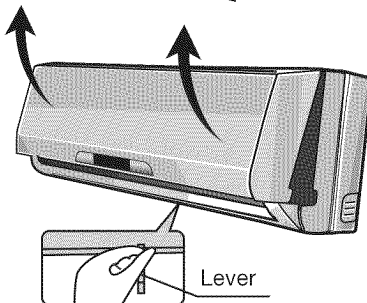
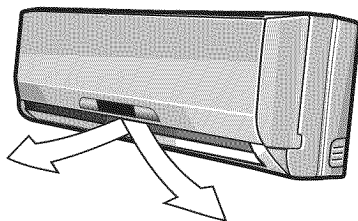
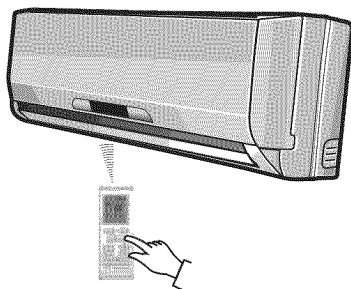
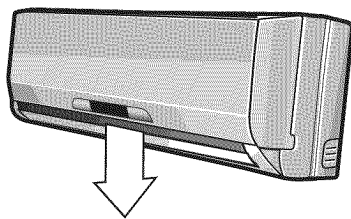
To stop the function, press the  button again.



- Press  to lock louver in desired position.
- The  button will be disabled when the air conditioner is not in operation (including when the TIMER ON is set).
- Do not operate the air conditioner for long periods with the air flow direction set downward in cooling or dry mode. Otherwise, condensation may occur on the surface of the horizontal louver and drop on to the floor or on furnishings.
- Do not move the horizontal louver manually. Always use the  button. If you move this louver manually, it may malfunction during operation. If the louver malfunctions, stop the air conditioner and restart it.
- Open angle of the horizontal louver should not be set too small, as COOLING or HEATING(only for models with heating function) performance may be impaired due to too restricted air flow area.
- Do not operate unit with horizontal louver in closed position.
- When the air conditioner is connected to power (initial operation), the horizontal louver may generate a sound for 10 seconds, this is a normal operation.

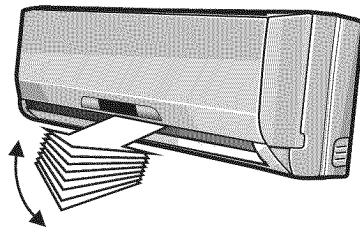

Manual operation (without remote control)

Manual operation can be used temporarily in case you can not find the remote controller or its batteries are exhausted.

1. Open and lift the front panel up to an angle until it remains fixed with a clicking sound.
2. One press of the manual control button will lead to the forced AUTO operation.
3. Close the panel firmly to its original position.

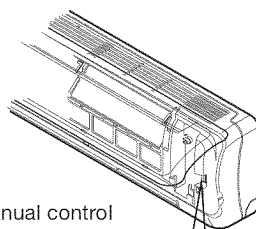
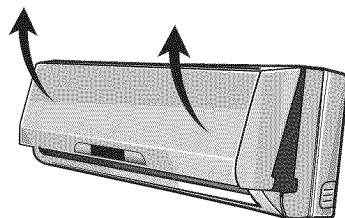

Manual control
button

Auto/OFF 

Attention

Once you press the manual button, the operation mode is shifted in an order as: AUTO and OFF.

The manual operation is mainly used for testing purpose. Do not choose it unless it is necessary. To return to the remote controller operation, use the remote controller

Maintenance

Cleaning the indoor unit and remote controller

1. It is necessary to stop the air conditioner and disconnect the power supply before cleaning.
2. Use a dry cloth to wipe the indoor unit and remote controller.
3. A cloth dampened with cold water may be used on the indoor unit if it is very dirty.
4. The front panel of the indoor unit can be removed and cleaned with water. Then wipe it with a dry cloth.
5. Do not use a chemically treated cloth or duster to clean the unit.
6. Do not use benzine, thinner, polishing powder, or similar solvents for cleaning. These may cause the plastic surface to crack or deform.

Cleaning the air filter

A clogged air filter reduces the cooling efficiency of this unit. Please clean the filter once every 2 weeks.

1. Lift the indoor unit panel up to an angle until it stops with a clicking sound.
2. Take hold of the handle of the air filter and lift it up slightly to take it out from the filter holder, then pull it downwards.
3. Remove the air filter (Fresh air filter + support frame) from the unit.
4. Remove fresh air filter from support frame.
5. Clean the fresh air filter at least once a month, and replace every 4 to 5 months. Use a vacuum cleaner, then dry.
6. Clean the support frame using a vacuum cleaner or water. Then dry

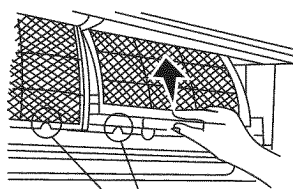
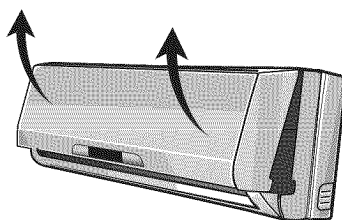

air filter

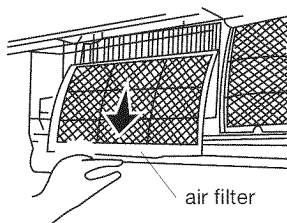

air filter

for a couple of hours.

7. Insert the fresh air filter in its original place.
8. Insert the upper part of the air filter (fresh air filter + support frame) back into the unit keeping in mind that the outside border (right and left) are lined up correctly, then place the whole filter in its initial position.

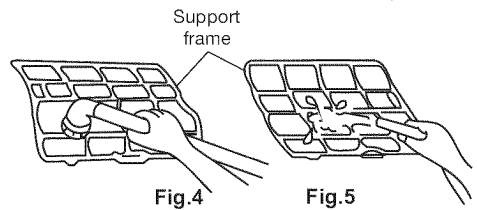
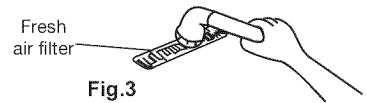
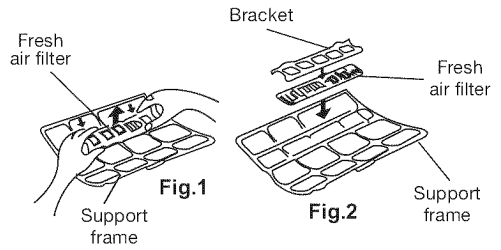
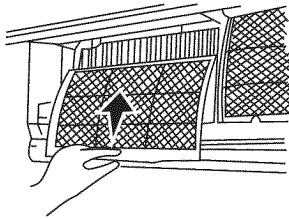

Maintenance

If you plan to idle the unit for a long time, perform the following:

1. Operate in fan mode for about half a day to dry the inside of the unit.
2. Stop the air conditioner and disconnect power. Remove the batteries from the remote controller.
3. The outdoor unit requires periodic maintenance and cleaning. Do not attempt to do this yourself. Contact your dealer or servicer.

Check before operation

1. Check that the wiring is not broken or disconnected.
2. Check that the air filter is installed.
3. Check whether the air outlet or inlet is blocked after the air conditioner has not been used for a long time.

Operation tips

The following events may occur during normal operation.

Protection of the air conditioner.

Compressor protection

The compressor can't restart for 3 minutes after it stops.

Anti-cold air (Only for models with heating function)

The unit is designed not to blow cold air in HEAT mode, when the indoor heat exchanger is in one of the following three situations and the set temperature has not been reached.

1. When heating has just starting.
2. Defrosting.
3. Low temperature heating.

Defrosting (Only for models with heating function)

Frost may be generated on the outdoor unit during heat cycle when outdoor temperature is low and humidity is high resulting in lower heating efficiency of the air conditioner. During this condition, air conditioner will stop heating operation and start defrosting automatically.

The time of defrosting may vary from 0 to 8 minutes according to the outdoor temperature and the amount of frost buildup on the outdoor unit.

The indoor or outdoor fan stop running when defrosting (Only for models with heating function).

A white mist coming out from the indoor unit

A white mist may generate due to a large temperature difference between air inlet and air outlet in COOL mode in an indoor environment that has a high relative humidity.

A white mist may generate due to moisture generated from defrosting process when the air conditioner restarts in HEAT mode operation after defrosting.

Low noise of the air conditioner

You may hear a low hissing sound when the compressor is running or has just stopped running. This sound is the sound of the refrigerant flowing or coming to stop.

You can also hear a low "squeak" sound when the compressor is running or has just stopped running. This is caused by heat expansion and cold contraction of the plastic parts in the unit when the temperature is changing.

A noise may be heard due to louver returning to its original position when power is first turned on.

Dust is blown out from the indoor unit.

This is a normal condition when the air conditioner has not been used for a

long time or during first use of the unit.

A peculiar smell comes out from the indoor unit.

This is because the indoor unit gives off smells permeated from building material, furniture or smoke.

The air conditioner turns to FAN only mode from COOL or HEAT (Only for models with heating function) mode.

When indoor temperature reaches the temperature setting on air conditioner, the compressor will stop automatically, and the air conditioner turns to FAN only mode. The compressor will start again when the indoor temperature rises in COOL mode or falls in HEAT mode (Only for models with heating function) to the set point.

Dripping water condenses on the surface of indoor unit

Dripping water may generate on the surface of the indoor unit when cooling in a high relatively humidity (relative humidity higher than 80%). Adjust the horizontal louver to the maximum air outlet position and select HIGH fan speed.

Heating mode (Only for models with heating function)

The air conditioner draws in heat from the outdoor unit and releases it via the indoor unit during heating operation. When the outdoor temperature falls, heat drawn in by the air conditioner decreases accordingly. At the same time, heat loading of the air conditioner increases due to larger difference between indoor and outdoor temperature. If a comfortable temperature can't be achieved by the air conditioner, we suggest you use a supplementary heating device.

Auto-restart function

Power failure during operation will stop the unit completely.

For the unit without Auto-restart feature, when the power restores, the OPERATION indicator on the indoor unit starts illuminating. To restart the operation, press the ON/OFF button on the remote controller. For the unit with Auto-restart feature, when the power restores, the unit restarts automatically with all the previous settings preserved by the memory function.

Lightning or a car wireless telephone operating nearby may cause the unit to malfunction.

Disconnect the unit with power and then re-connect the unit with power again. Push the ON/OFF button on the remote controller to restart operation.

Solutions for problems

If your air conditioner malfunctions, check the following information to find solutions or probable causes of the failure. Do not try to repair the unit by yourself, if these solutions do not solve the failures, call your local service repair team.

Poor Equipment performance

1. The air outlet or inlet of outdoor unit is obstructed.
2. The air outlet or inlet of indoor unit is obstructed.
3. The outdoor temperature is high due to direct sunlight or another heat source.
4. Heater or a cooking stove is being used in the same room.
5. Room is full of people.
6. The air filter is obstructed by dust or is dirty.
7. Inappropriate temperature adjustment.
8. The capacity of the equipment is not adequate for the size of the room.
9. Air conditioner was just turn on.
10. Windows or doors are open.

The unit does not start

1. No power supply.
2. The voltage is different.
3. Temperature is not adjusted properly.
4. Fuse have blown.
5. The remote control batteries need to be replaced.
6. The time you have set with timer is incorrect.

Attention

Stop the air conditioner immediately if one of the following malfunctions occur

1. The operation indicator or other indicator flash(5 times per second) and the flashing is not stop by disconnecting the power and and then connecting it again.
2. Fuse blows frequently or circuit breaker trips frequently.
3. Water spills over the equipment.
4. Remote control does not work.
5. Any other abnormal situations.

Major Appliance Warranty

Your appliance is covered by a full one-year warranty and a limited 2-5 year warranty (sealed system). For one year from your original date of purchase, Electrolux will pay all costs for repairing or replacing any parts of this appliance that prove to be effective in materials or workmanship when such appliance is installed, used and maintained in accordance with the provided instructions. From the second to the fifth year from your original purchase date, Electrolux will repair or replace any parts in the Sealed Refrigeration System (compressor, condenser, evaporator and tubing) proves to be defective in materials or workmanship. The consumer will be responsible for diagnostic costs and any removal, transportation and reinstallation costs which are required because of service, costs for labor, parts and transportation other than with respect to the Sealed Refrigeration System.

Exclusions **This warranty does not cover the following:**

1. Products with original serial numbers that have been removed, altered or cannot be readily determined.
2. Product that has been transferred from its original owner to another party or removed outside the USA or Canada.
3. Rust on the interior or exterior of the unit.
4. Products purchased "as-is" are not covered by this warranty.
5. Food loss due to any refrigerator or freezer failures.
6. Products used in a commercial setting.
8. Service calls to correct the installation of your appliance or to instruct you how to use your appliance.
7. Service calls which do not involve malfunction or defects in materials or workmanship, or for appliances not in ordinary household use or used other than in accordance with the provided instructions.
9. Expenses for making the appliance accessible for servicing, such as removal of trim, cupboards, shelves, etc., which are not a part of the appliance when it is shipped from the factory.
10. Service calls to repair or replace appliance light bulbs, air filters, water filters, other consumables, or knobs, handles, or other cosmetic parts.
11. Surcharges including, but not limited to, any after hour, weekend, or holiday service calls, tolls, ferry trip charges, or mileage expense for service calls to remote areas, including the state of Alaska.
12. Damages to the finish of appliance or home incurred during installation, including but not limited to floors, cabinets, walls, etc.
13. Damages caused by: services performed by unauthorized service companies; use of parts other than genuine Electrolux parts or parts obtained from persons other than authorized service companies; or external causes such as abuse, misuse, inadequate power supply, accidents, fires, or acts of God.

Major Appliance Warranty

DISCLAIMER OF IMPLIED WARRANTIES; LIMITATION OF REMEDIES

CUSTOMER'S SOLE AND EXCLUSIVE REMEDY UNDER THIS LIMITED WARRANTY SHALL BE PRODUCT REPAIR OR REPLACEMENT AS PROVIDED HEREIN. CLAIMS BASED ON IMPLIED WARRANTIES, INCLUDING WARRANTIES OF MERCHANTABILITY OR FITNESS FOR A PARTICULAR PURPOSE, ARE LIMITED TO ONE YEAR OR THE SHORTEST PERIOD ALLOWED BY LAW, BUT NOT LESS THAN ONE YEAR. ELECTROLUX SHALL NOT BE LIABLE FOR CONSEQUENTIAL OR INCIDENTAL DAMAGES SUCH AS PROPERTY DAMAGE AND INCIDENTAL EXPENSES RESULTING FROM ANY BREACH OF THIS WRITTEN LIMITED WARRANTY OR ANY IMPLIED WARRANTY. SOME STATES AND PROVINCES DO NOT ALLOW THE EXCLUSION OR LIMITATION OF INCIDENTAL OR CONSEQUENTIAL DAMAGES, OR LIMITATIONS ON THE DURATION OF IMPLIED WARRANTIES, SO THESE LIMITATIONS OR EXCLUSIONS MAY NOT APPLY TO YOU. THIS WRITTEN WARRANTY GIVES YOU SPECIFIC LEGAL RIGHTS. YOU MAY ALSO HAVE OTHER RIGHTS THAT VARY FROM STATE TO STATE.

If You Need Service

Keep your receipt, delivery slip, or some other appropriate payment record to establish the warranty period should service be required. If service is performed, it is in your best interest to obtain and keep all receipts. Service under this warranty must be obtained by contacting Electrolux at the addresses or phone numbers below.

This warranty only applies in the USA and Canada. In the USA, your appliance is warranted by Electrolux Major Appliances North America, a division of Electrolux Home Products, Inc. In Canada, your appliance is warranted by Electrolux Canada Corp. Electrolux authorizes no person to change or add to any obligations under this warranty. Obligations for service and parts under this warranty must be performed by Electrolux or an authorized service company. Product features or specifications as described or illustrated are subject to change without notice.

USA

1.800.944.9044

Electrolux Major Appliances
North America
P.O. Box 212378
Augusta, GA 30907



Canada

1.800.265.8352

Electrolux Canada Corp.
5855 Terry Fox Way
Mississauga, Ontario, Canada
L5V 3E4

