

Front Load Clothes Washer
Front Load Clothes Washer (french)
Lavadora de Ropa Carga Frontal

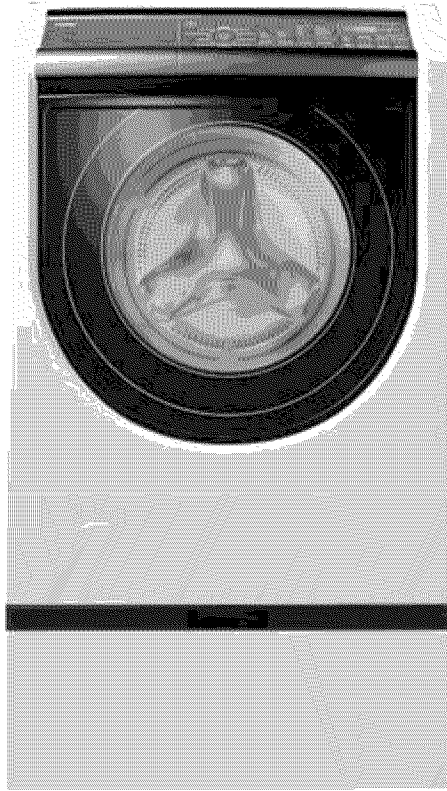

User Manual

Model # HWF5300, HWF5200, HWF5000

Guide de l'Utilisateur

Modèle # HWF5300, HWF5200, HWF5000

Manual del Usuario

Para Modelo de # HWF5300, HWF5200, HWF5000

Haier

Quality · Innovation · Style

IMPORTANT SAFETY INSTRUCTIONS

WARNING - To reduce the risk of fire, electric shock, or injury to persons when using your appliance, follow the basic precautions, including the following:

1. Read all of the instructions before using this appliance.
2. Use this appliance only for its intended purpose as described in this user manual.
3. This washer must be properly installed in accordance with the installation instructions before it is used.
4. Unplug your washer before cleaning.
5. Never unplug your washer by pulling on the power cord. Always grasp the plug firmly and pull straight out from the outlet.
6. Do not operate your washer in the presence of explosive flames.
7. Do not use the washer for commercial clothes washing.
8. Do not tamper with controls.
9. Do not allow children to play on or in the appliance. Close supervision of children is necessary when the appliance is used near children.
10. Washer must be grounded, see grounding instructions on page 2.
11. Under certain conditions, hydrogen gas may be produced in a hot-water system that has not been used for 2 weeks or more **HYDROGEN GAS IS EXPLOSIVE**. If the hot water system has not been used for such a period, before using a washing machine, turn on all hot-water faucets and let the water flow from each for several minutes. This will release any accumulated hydrogen gas. As the gas is flammable, do not smoke or use an open flame during this time.
12. Do not wash articles that have been previously cleaned in, washed in, soaked in, or spotted with gasoline, dry-cleaning solvents or other flammable or explosive substances to the wash water. These substances give off vapours that could ignite or explode.
13. Do not add gasoline, dry-cleaning solvents, or other flammable or explosive substances to wash water. These substances give off vapours that could ignite or explode.
14. Before the appliance is removed from service or discarded, remove the door.
15. Do not reach into the appliance if the tub or agitator is moving.
16. Do not install or store this appliance where it will be exposed to the weather.
17. Do not repair or replace any part of the appliance or attempt any servicing unless specifically recommended in the user-maintenance instructions or in published user repair instructions that you understand and have the skills to carry out.

SAVE THESE INSTRUCTIONS

GROUNDING INSTRUCTIONS

This appliance must be grounded. In the event of malfunction or breakdown, grounding will reduce the risk of electric shock by providing a path of least resistance for electric current. This appliance is equipped with a cord having an equipment-grounding conductor and a grounding plug. The plug must be plugged into an appropriate outlet that is properly installed and grounded in accordance with all local codes and ordinances.

Warning – Improper connections of the equipment-grounding conductor can result in a risk of electric shock. Check with a qualified electrician or serviceman if you are in doubt as to whether the appliance is properly grounded.

DANGER

Risk of child entrapment. Before you throw away your old appliance, take off the door so that children may not easily get trapped inside.

Thank you for purchasing our Haier product. This easy-to-use manual will guide you in getting the best use of your washer.

Remember to record the model and serial number. They are on a label in back of the washer.

Model number

Serial number

Date of purchase

Staple your receipt to your manual. **You will need it to obtain warranty service.**

ELECTRICAL CONNECTIONS

This appliance must be grounded. In the event of an electrical short circuit, grounding reduces the risk of electric shock by providing an escape wire for the electric current. This appliance is equipped with a cord having a grounding wire with a grounded plug. The plug must be inserted into an outlet that is properly installed and grounded.



- Improper use of the plug can result in a risk of electric shock.
- Consult a qualified electrician or service person if the grounding instructions are not completely understood or if doubt exists as to whether the appliance is properly grounded.

Wiring Requirements:

- This appliance must be plugged into at least 15 AMP 120 VOLT, 60 HZ GROUNDED OUTLET.

Note: Where a standard two-prong outlet is encountered, it is the personal responsibility and obligation of the consumer to have it replaced with a properly grounded three-prong outlet.

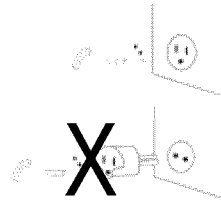

Extension Cords:

We do not recommend that you use an extension cord.



Power Interruptions

Occasionally there may be power interruptions due to thunderstorms or other causes. Remove the power cord from AC outlet when a power outage occurs. When power has been restored re-plug power cord to AC outlet. If outage is for a prolonged period, clean washer before using it again.

TABLE OF CONTENTS

SAFETY INSTRUCTIONS	1
GROUNDING INSTRUCTIONS	2
ELECTRICAL CONNECTING	3
PARTS AND FEATURES	5
Front.....	5
Back.....	6
INSTALLATION INSTRUCTIONS	7
Tools and Materials Required	7
Unpacking Your Washer	8
Installation.....	10
OPERATIONAL INSTRUCTIONS	12
Control Panel	12
Program Selection	14
Loading	16
Proper Use of Dispenser	16
Washing Methods.....	17
Normal Operating Sounds.....	18
CARE AND CLEANING GUIDE	19
Cleaning and Maintenance	19
Moving and Vacationing	20
Storage of Your Washer	20
Troubleshooting	21
Technical Specification	23
Warranty	24

PARTS AND FEATURES

Front

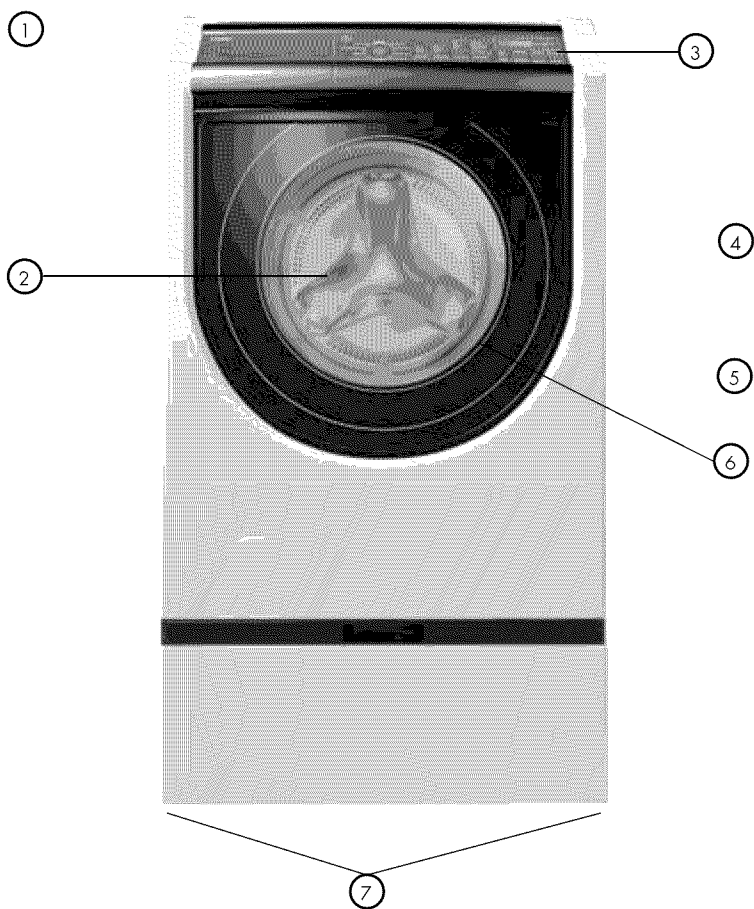

- 1. Detergent / Softener Dispenser
- 2. See-through Glass Door
- 3. Control Panel
- 4. Cabinet

- 5. Coin/Button Trap
- 6. Wash Tub
- 7. Adjustable Leveling Legs
(Not Shown)

PARTS AND FEATURES

Back

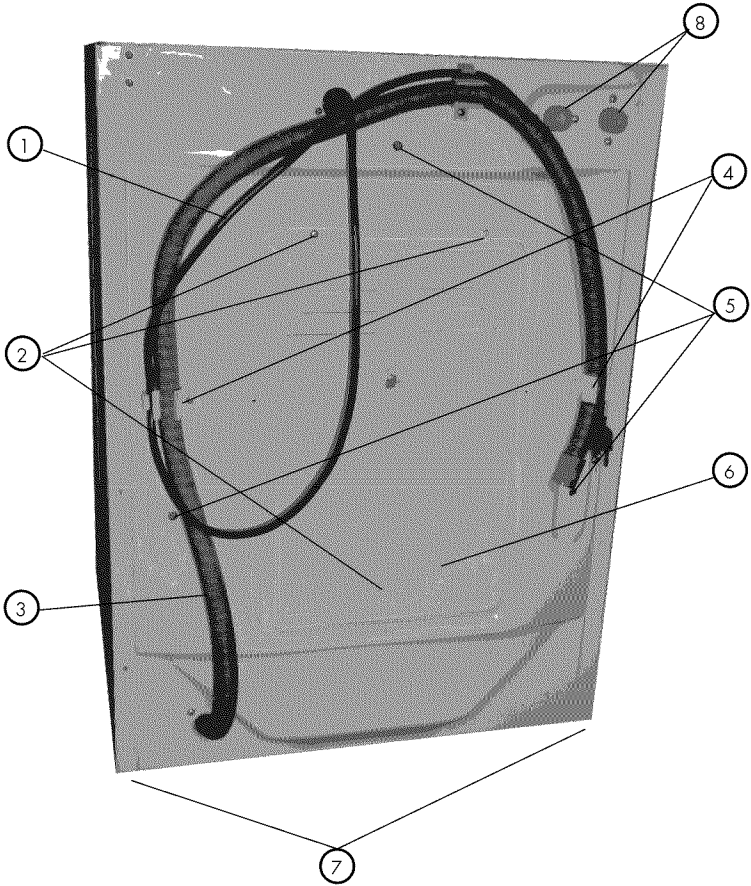

1. Power Supply Cord
2. Back Plate Screw (3)
3. Drainage Hose
4. Drainage Hose Clip (3)
5. Transportation Bolt (4)

6. Back Plate
7. Adjustable Leveling Legs
(Not Shown)
8. Valve (Hot and Cold)
9. Vent

INSTALLATION INSTRUCTIONS

Tools and Materials Required

You will need to have the following tools to help you in the installation of your washer:

- Scissors
- Standard Screwdriver
- Pliers
- Wrench
- Tape Measure
- Gloves
- Level

Accessories Supplied	Quantity
1. Hot & Cold Water Inlet Hoses	2
2. Pressure Regulator (Attached to Hot & Cold Water Inlet Hoses)	2
3. Flat Water Inlet Hose Washers (Installed in each end of water inlet hoses)	4
4. Use & Care Guide (Not Shown)	1
5. Plastic Plugs to cover transportation bolt holes	3
6. Goose Neck	1

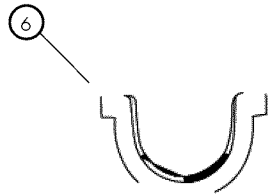
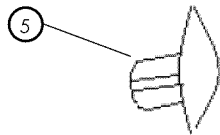
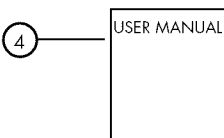
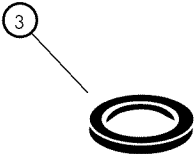
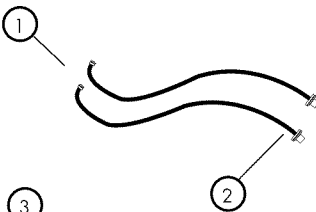

Unpacking Your Appliance

- Remove all packing materials including transportation bolts.
- Inspect and remove any remains of packing, tape or printed materials before using the washer.
- Transportation Bolts must be removed before using the machine. Once removed, save them so when moving you can reinstall to protect the machine from damage during shipping.
- Water inlet hoses and other accessories are packed and placed in the drum.

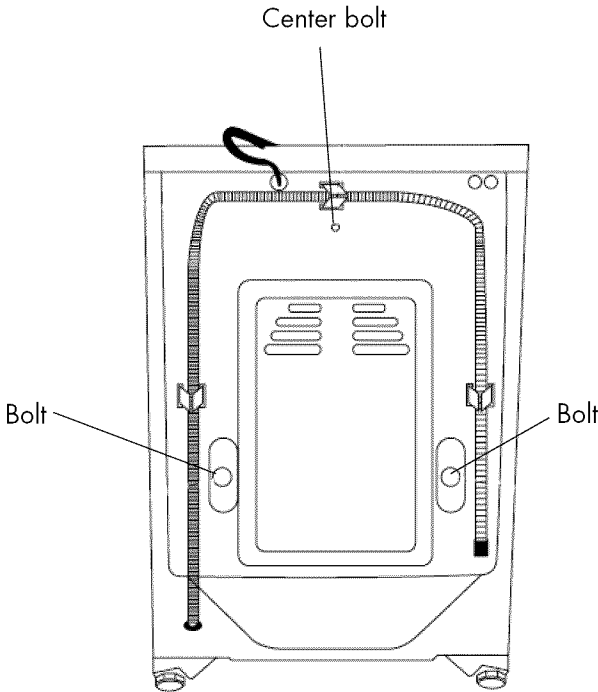

- As shown in figure 1, remove all the packing materials (including the foam base).

Upon opening of the package, water drops may be seen on the plastic bag and the porthole. This is a normal phenomenon resulting from water tests in the factory.

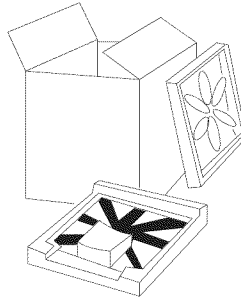

Fig. 1



- Remove three transportation bolts as shown in figure 2A. The bolts protect the appliance from shock during transportation. The steps below should be followed before using the appliance:

- Remove the back plate of the washing machine. To remove this you must remove three screws holding the panel.
- Remove the three bolts from the rear of the washing machine. Then remove the rubber hose which are behind the transportation bolts inside the unit.
- Reinstall the back plate.
- Fill the holes left by the bolts with plastic plugs. (Attention: The bolts and rubber hose should be kept in a safe place for later use.) (Fig. 2B)

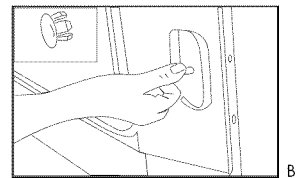
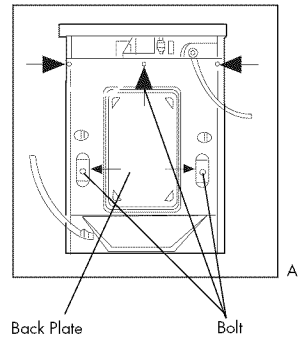

Fig. 2

- Leveling the washing machine: There are adjustable feet under the bottom of the washing machine. Before use, the washing machine should be adjusted, as shown in figure 3, so that it is level.
- Leveling legs can be adjusted by turning them counterclockwise to raise your washer or clockwise to lower your washer.

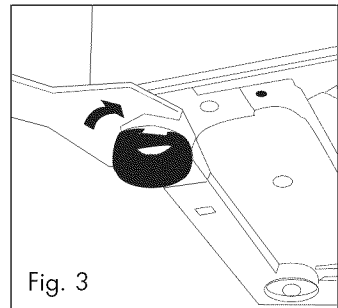
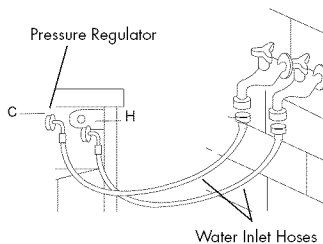

Fig. 3

INSTALLATION

Connection of Water Inlet Hose and Washing Machine

- Connect the straight coupling of the inlet hose to the water tap and make sure to tighten it.
- Install the pressure regulator to each inlet valves of the unit. Make sure the flat rubber washer is placed in the pressure regulator.
- Connect the elbow coupling of the inlet hose to the valve and make sure to tighten it.



- Note:**
- Please be sure that the COLD inlet hose is connected with the valve for cold water (marked with "C").
 - Please be sure that the HOT inlet hose is connected with the valve for hot water (marked with "H").

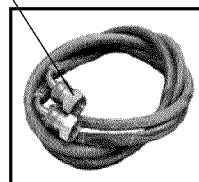

- Note:** A flat rubber washer must be present inside each end of the inlet hoses. Over tightening may cause damage to the valve.

Water Drainage Hose

- The height of the pipe for the water drainage hose should be between 2'6" to 3'3". The water drain hose must be securely placed on the clip on the back of the washing machine.
- Use the water drainage support (gooseneck) supplied as an accessory for proper installation. If the water drain hose needs to be extended, it should not be extended more than 8'2". (Longer extension will result in concurrent water inflow and outflow.) The diameter of the extension hose should be the same as the original hose.

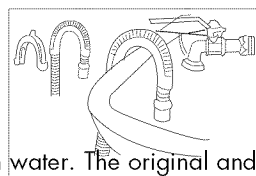
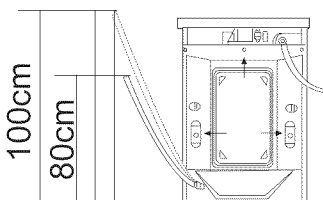

- Caution:** Water drainage hose must not be immersed in water. The original and extension hoses should be tightly connected.

Power Supply

- Unit should be connected to a regular 120V~60 Hz 15A grounded outlet. Make sure local city codes are followed.

Y Adapter Connection

Note: "Y Adapter" shown in below figure is only for illustration. It is not provided in the box as an accessory. If you need to utilize this type of hookup, you can purchase a "Y Adapter" from your nearest hardware store.

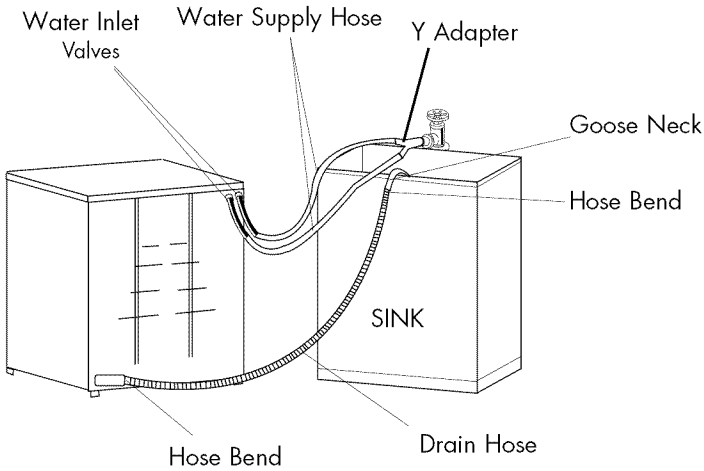

Unit Dimensions

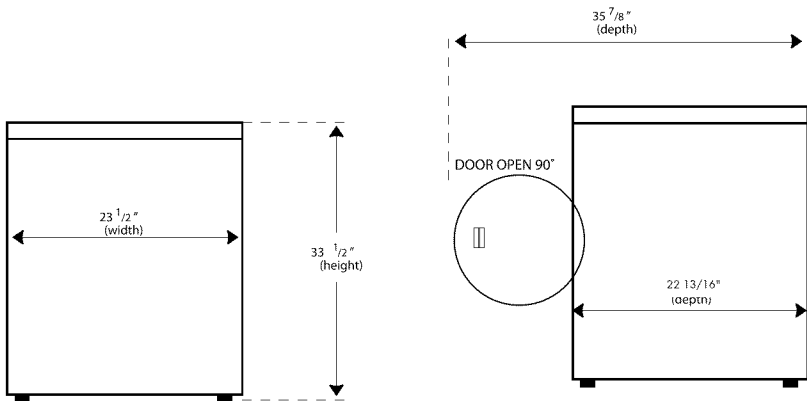

FRONT VIEW

SIDE VIEW

OPERATIONAL INSTRUCTIONS

HWF5300

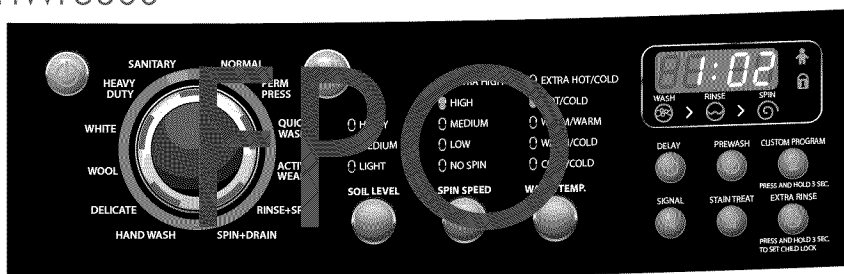

Power ON/OFF button (1)

- Press button to power ON or turn OFF the washer.
- Heavy Duty - Use this cycle for heavily soiled durable garments. Also this cycle could be used for towels, sports gear, childrens clothes, etc.
- Normal - Use this cycle for normally soiled cottons and mixed fabric loads.
- Whites - Use this cycle for white and light colored clothing.
- Colors - Use this cycle for lightly soiled, dark or highly dyed natural fabrics such as cotton that may be susceptible to dye loss.
- Bulky - Use this cycle to wash large items such as comforters, sleeping bags and blankets
- Press Free - Use this cycle to wash loads of no-iron fabrics such as sports shirts, blouses, casual business clothes, permanent press and blends.
- Delicate - Use this cycle to wash lightly soiled garments and delicate clothes that need gentle washing.
- Quick - Use this cycle to wash small, lightly soiled loads that are needed in a hurry.
- Custom Cycle - Here you could customize your wash. This cycle maintains prior settings in memory.

Select (2)

Here in certain cycles the wash process could be changed per your needs. This also shows the cycle process of the wash load.

Start/Pause Button (3)

- Press the button to turn the dryer ON. Press this button once to start the dry process. Press this button once again to pause the activity during the dry cycle.

Wash Speed / Spin Speed (4)

- By pressing this button you could select wash or spin speed. For delicate and laced fabrics a slower spin speed may be chosen.

Spin Speed (5)

- Enables the selection of spin speed during the wash cycle. Press this button if you want to change the preprogrammed selection. Selection here may vary per

the cycle chosen. All selections are not available in all cycles.

Water Level (6)

- Water levels may be set at the beginning of the wash or in pause mode.
- During Soak, Wash or Rinse, press this button to manually replenish water. Release for the water to stop. Function automatically is inactive when water reaches the overflow protection level.

Signal (7)

- Signal volume can be adjusted soft-loud or off.

Soil Level (8)

- Select clothes soil level. There are 4 levels to choose from, Extra Heavy, Heavy, Medium and Light.
- Wash cycle increases 2 minutes for each level increased. Selection should be based on the soil level in clothes. The dirtier the clothes the heavier the level.

Temperature Wash / Rinse (9)

- To select inlet water temperature for wash and rinse. Selection here may vary per the cycle chosen. All selections are not available in all cycles.

Off (10)

- If washer is ON push button once to shut off the power.

Start / Pause (11)

- Once washer is powered and selections are chosen, push this button once to start the wash.
- While unit is working, push this button once to pause it.
- If unit is in pause mode, push this button once to resume operation.
- If "Start/Pause" button is pressed to start the wash, the washer will display the last cycle set. If any button except "Off" is pressed to start, the washer will no start in the Normal cycle mode.
- If Start/Pause button isn't pressed within 5 minutes after powering "On" the unit will automatically switch off and return to stand by mode.

HWF5300 Preset Cycle Settings			
Cycles	Time (in minutes)	Wash/Rinse Temperature	If Soil Level is:
Normal	40	Warm/Cold	medium
Heavy Duty	50	Hot/Cold	heavy
Whites	51	Hot/Cold	heavy
Colors	40	Cold/Cold	medium
Delicates	31	Cold/Cold	light
Quick Wash	27	Warm/Warm	ight
Bulky	45	Warm/Cold	medium
Press Free	33	Warm/Cold	light
Custom Cycle	Depends	Depends	Depends

HWF5200, 5000

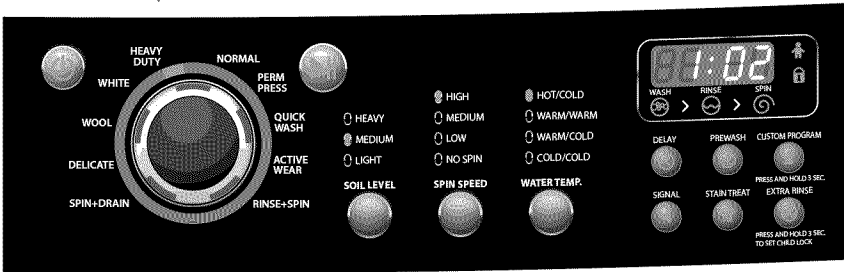

Cycles (2)

- Heavy Duty - Use this cycle for heavily soiled durable garments. Also this cycle could be used for towels, sports gear, childrens clothes, etc.
- Normal - Use this cycle for normally soiled cottons and mixed fabric loads.
- Whites - Use this cycle for white and light colored clothing.
- Colors - Use this cycle for lightly soiled, dark or highly dyed natural fabrics such as cotton that may be susceptible to dye loss.
- Bulky - Use this cycle to wash large items such as comforters, sleeping bags and blankets
- Delicate - Use this cycle to wash lightly soiled garments and delicate clothes that need gentle washing.
- Quick - Use this cycle to wash small, lightly soiled loads that are needed in a hurry.

Soil Level (4)

- Select clothes soil level. There are 3 levels to choose from Heavy, Medium and Light.
- Wash cycle increases 2 minutes for each level increased. Selection should be based on the soil level in clothes. The dirtier the clothes the heavier the level.

Temperature Wash / Rinse (6)

- To select inlet water temperature for wash and rinse. Selection here may vary per the cycle chosen. All selections are not available in all cycles.

HWF5200, 5000 Preset Cycle Settings			
Cycles	Time (in minutes)	Wash/Rinse Temperature	If Soil Level is:
Normal	40	Warm/Cold	medium
Heavy Duty	50	Hot/Cold	heavy
Whites	51	Hot/Cold	heavy
Colors	40	Cold/Cold	medium
Delicates	31	Cold/Cold	light
Quick Wash	27	Warm/Warm	light
Bulky	45	Warm/Cold	medium
Press Free	33	Warm/Cold	light
Custom Cycle	Depends	Depends	Depends

Signal (7)

- Select clothes soil level. There are 3 levels to choose from Heavy, Medium and Light.
- Wash cycle increases 2 minutes for each level increased. Selection should be based on the soil level in clothes. The dirtier the clothes the heavier the level.

Delay (8)

- Select clothes soil level. There are 3 levels to choose from Heavy, Medium and Light.
- Wash cycle increases 2 minutes for each level increased. Selection should be based on the soil level in clothes. The dirtier the clothes the heavier the level.

Stain Treat (9)

- Select clothes soil level. There are 3 levels to choose from Heavy, Medium and Light.
- Wash cycle increases 2 minutes for each level increased. Selection should be based on the soil level in clothes. The dirtier the clothes the heavier the level.

Prewash (10)

- Select clothes soil level. There are 3 levels to choose from Heavy, Medium and Light.
- Wash cycle increases 2 minutes for each level increased. Selection should be based on the soil level in clothes. The dirtier the clothes the heavier the level.

Extra Rinse (11)

- Select clothes soil level. There are 3 levels to choose from Heavy, Medium and Light.
- Wash cycle increases 2 minutes for each level increased. Selection should be based on the soil level in clothes. The dirtier the clothes the heavier the level.

Custom Program (12)

- Select clothes soil level. There are 3 levels to choose from Heavy, Medium and Light.
- Wash cycle increases 2 minutes for each level increased. Selection should be based on the soil level in clothes. The dirtier the clothes the heavier the level.

Digital Display (13)

- Select clothes soil level. There are 3 levels to choose from Heavy, Medium and Light.
- Wash cycle increases 2 minutes for each level increased. Selection should be based on the soil level in clothes. The dirtier the clothes the heavier the level.

Function Indicator Light (14)

- Select clothes soil level. There are 3 levels to choose from Heavy, Medium and Light.

Child Lock (15)

- Select clothes soil level. There are 3 levels to choose from Heavy, Medium and Light.

Wash-Rinse-Spin (16)

- Select clothes soil level. There are 3 levels to choose from Heavy, Medium and Light.
- Wash cycle increases 2 minutes for each level increased.

Loading the Washer

- Load each item loosely.
- Separate the white and colored clothes. Separate heavy clothes from light clothes.
- Carefully check all pockets and cuffs for small items. They can easily slide into the tub and may damage the tub.
- Pre-treat all stains and heavily soiled areas for best results.
- Do not overload your washer.
- When loading wet items, keep water level high enough so items can float easily in the water.
- Close the door properly after loading the clothes. If you keep the lid up, the washer will not start.

Proper Use of Detergent

Program descriptions are printed on the handle of the detergent distributor. There are three detergent compartments numbered 1, 2, 3.

- 1: Pre-washing detergent
- 2: Detergent
- 3: Softening agent

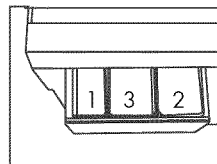

Note: Use only liquid bleach in dispenser.

- Warning:**
- Be careful not to spill undiluted bleach on the washer cabinet or your clothes. As it is a strong chemical, it may damage clothes or finish of the washer if not properly diluted.
 - Use the manufacturer's chart, on product container for recommended use of liquid or powder bleach.

Fabric Softener Dispenser

- Please follow softener instructions for dose usage.
- Pour in liquid fabric softener into dispenser as recommended by the manufacturer.
- Do not overfill.
- The fabric softener is dispensed in the final rinse. If Extra Rinse is selected (not available in all models) the fabric softener will be dispensed during the Extra Rinse Cycle.
- At the end of the cycle, a small amount of water may be left in the dispenser. This is normal.

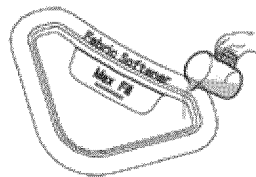

Note: Use only liquid fabric softener in this dispenser

Warning: Never pour fabric softener directly onto clothes because it will stain your clothes or you may get spots on your clothes.

Operating Procedure - GWT950AW

1. Press any button except "Off" button

- If you press the "Start/Pause" button to start the washer, the washer will run in the last cycle used. If you press any button except "Off" to start, the washer will run the Normal cycle.
- If "Start/Pause" button isn't pressed within 5 minutes after powering "On" the unit will automatically switch off and return to stand-by mode.
- The washer will also return to stand-by mode immediately after completion of the wash process.
- Regardless of settings, by pressing the Power Off button all programs will stop and the unit will enter stand-by mode.
- The washer has intelligent wash resumption (Cycle Reset). When power is interrupted at the power source, the washer will resume running where it left off when power is returned.

2. Selection of Cycles

- When the washer is powered on the Heavy Duty cycle is the default cycle. If another cycle is desired press the cycle button for the desired program.

3. Select

- Once the power is switched on the washing machine will automatically set the Heavy Duty cycle, which will Wash, Rinse and Spin. If other selection combinations are desired, press the Select button to choose.

Note: Spin shall begin after some time even if there is no water in the tub.

Do not use Pre-wash process for woolen articles. Clothes prone to fade and other clothes should be washed separately.

Times of pressing Functions (Normal, Heavy Duty and White)	Selected Functions	Applications	Operation (the "On" indicator represent the processes to run)	Times of pressing Process (Quick Wash, Delicate Casual or Hand Wash)
0	Wash, Rinse, Spin	Common clothes needing wash, rinse & spin	<input checked="" type="checkbox"/> Pre-wash <input type="checkbox"/> Wash <input type="checkbox"/> Rinse <input checked="" type="checkbox"/> Extra Rinse <input type="checkbox"/> Spin	0
1	Wash (Wash water remains in the tub)	Repeatedly use the wash water	<input checked="" type="checkbox"/> Pre-wash <input type="checkbox"/> Wash <input type="checkbox"/> Rinse <input checked="" type="checkbox"/> Extra Rinse <input checked="" type="checkbox"/> Spin	1
2	Wash, rinse (Rinse Water remains in the tub)	Repeatedly use the rinse water	<input checked="" type="checkbox"/> Pre-wash <input type="checkbox"/> Wash <input type="checkbox"/> Rinse <input checked="" type="checkbox"/> Extra Rinse <input checked="" type="checkbox"/> Spin	2
3	Rinse, Spin	When rinse and spin are needed after hand wash	<input checked="" type="checkbox"/> Pre-wash <input type="checkbox"/> Wash <input type="checkbox"/> Rinse <input type="checkbox"/> Extra Rinse <input type="checkbox"/> Spin	3
4	Pre-wash, Wash, Rinse, Extra Rinse, Spin	When clothes need an Extra Rinse	<input type="checkbox"/> Pre-wash <input type="checkbox"/> Wash <input type="checkbox"/> Rinse <input type="checkbox"/> Extra Rinse <input type="checkbox"/> Spin	/
5	Wash, Rinse, Extra Rinse / Spin	When clothes need an Extra Rinse	<input checked="" type="checkbox"/> Pre-wash <input type="checkbox"/> Wash <input type="checkbox"/> Rinse <input type="checkbox"/> Extra Rinse <input type="checkbox"/> Spin	4
6	Spin (to spin after drain)	When only spin is needed after hand wash (first drain and then spin)	<input checked="" type="checkbox"/> Pre-wash <input checked="" type="checkbox"/> Wash <input checked="" type="checkbox"/> Rinse <input checked="" type="checkbox"/> Extra Rinse <input type="checkbox"/> Spin	5
7	Pre-wash, Wash, Rinse, Spin	For heavily soiled clothes shirt cuffs and collars, first Pre-wash and then wash	<input type="checkbox"/> Pre-wash <input type="checkbox"/> Wash <input type="checkbox"/> Rinse <input checked="" type="checkbox"/> Extra Rinse <input type="checkbox"/> Spin	/

4. Water Level

- After Wash Cycle Selection, Press the water level button to Select the proper water level for wash.

Note: See chart on next page for Load Size selection.

Capacity of
Wash (lbs.)

Detergent

Operating Procedure - HWF5200, 5000

1. Press Power ON/OFF

- If you press the "Start/Pause" button to start, the washer will run in the last cycle used.
- If "Start/Pause" button isn't pressed within 5 minutes after powering "On" the unit will automatically switch off and return to stand-by mode.
- The washer will also return to stand-by mode immediately after completion of the wash process.
- Regardless of settings, by pressing the Power Off button all programs will stop and the unit will enter stand-by mode.
- The washer has intelligent wash resumption. When power is interrupted at the power source, the washer will resume running where it left off when power is returned.

2. Selection of Cycles

- When the washer is powered on the Normal cycle is the default cycle. If another cycle is desired press the cycle button for the desired program.
Note: Spin shall begin after some time even if there is no water in the tub. Do not use Pre-wash process for woolen articles. Clothes prone to fade and other clothes should be washed separately.

3. Soil Level

- When the washer is powered on, the machine will automatically set at Normal. Select different soil levels by pressing this button.

4. Spin Speed

- When the washer is powered on, the machine will automatically set at Normal. Select different soil levels by pressing this button.

5. Temperature Wash/Rinse

- Initial setting is Warm/Cold when washer is powered on. Press this button to change selection based on clothes put in the washer.

6. Start/Pause

- Press this button when you want the machine to start.
- During operation, press this button to pause and press it again to resume operation.
Note: Opening the top lid will stop the machine except during water filling or draining.
Note: Total time may be affected by water inlet and drain time. It may also be affected by the water pressure. Normal, Heavy Duty and White programs could combine the process of Pre-wash during which the washing machine first Pre-wash for about 20-30 minutes, with slight pulsation after water filling and then begins to wash.

Loading

- Load each item loosely.
- Separate the white and colored clothes. Separate heavy clothes from light clothes.
- Carefully check all pockets and cuffs for small items. They can easily slide into the tub and damage the tub.
- Pre-treat all stains and heavily soiled areas for best results.
- Do not overload your washer.
- Close the door properly after loading clothes.

Proper Use of Dispenser

The detergent/softener dispenser is located on the upper left corner of the washer. Open the dispenser by pulling it out. You will see that there are three compartments.

1. Prewashing Detergent
2. Detergent
3. Softening Agent

Proper Use of Fabric Softener:

- Pour liquid fabric softener into compartment as recommended by the manufacturer.
- Do not exceed the level in the compartment to avoid overflow.

Warning: • Never pour fabric softener directly onto clothes because it will stain your clothes or you may get spots on your clothes.

- Do not use powder form of softener into dispenser, or it will clog up the dispenser. This dispenser is only designed for liquid form.

Proper Use of Detergent:

When pre-wash cycle is selected do not use liquid detergent.

Low-Sudsing detergent is recommended for front load style washers. This type of detergent prevents damage to your washing machine, which may be caused by excess amount of suds entering the condensing compartment.

Note: You can use less or more detergent depending on the size of the load, water type in your area whether it is soft or hard and whether the clothes are heavily soiled or lightly soiled. Besides the performance of the washing machine, the quality of the detergent also effects the washing result.

WASHING METHODS

Washing Program Setting

To set the desired wash program, turn the knob to "0" first. This will reset the timer. Then select a program from the list on the detergent dispenser. Now press the "Pause/Start" button to start operation.

Caution: If you want to choose another program, first turn project knob to "0", then turn off the power. Now set the program knob to the desired setting.

End

Wait 2-3 minutes after the washing process is finished. Open the door to take out the laundry.

Caution: When the washing program finishes, the door lock light will blink. Only then can the door be opened.

Additional Information

Energy and Water Saving During Wash Process

1. Collect clothes for one full wash load.
2. Do not overload the washing machine.
3. Prewash heavily soiled clothes.
4. Choose fast or minimal washing programs for lightly soiled clothes.
5. Choose a proper spin speed.
6. Do not use more detergent than required.
7. Softening agent makes clothes feel softer and easier to iron.

Other Functions

Power-off memory function:

This machine has a power-off memory function. In case of abrupt power failure or if the power must be cut off during a program cycle, the present settings will be saved, and operation will resume when the power is switched on again.

Normal Operating Sounds

The following sounds are normally heard during the operation of the washer:

- Tumbling sounds: This is normal as the heavy wet clothes in the washer are continuously being tossed around.
- Air rushing noise: This happens when the washer tub spins at a very high RPM.
- Wash and rinse cycles going on and off will also make clicking sounds.

CARE AND CLEANING GUIDE

Warning: Always unplug your appliance to avoid electric shock before cleaning. Ignoring this warning may result in death or injury. Before using cleaning products, always read and follow manufacturer's instructions and warnings to avoid personal injury or product damage.

Cleaning and Maintenance

Use a damp or sudsy cloth for cleaning control panel.

- To avoid any kind of damage to cabinet finish, wipe appliance cabinet as needed. If you spill liquid/powdered softener, bleach or detergent on the cabinet, wipe cabinet immediately because it can damage the finish.
- Do not use any abrasive, harsh chemicals, ammonia, chlorine bleach, concentrated detergent, solvents or metal scouring pads. Some of these chemicals may dissolve, damage and/or discolor your appliance.
- Remove pins or other sharp objects from clothes to prevent scratching interior parts.
- The Detergent Dispenser Compartment has a removable insert. Over time, this compartment may accumulate dried detergent, dirt and debris. You must remove the insert, then rinse in a sink or remove debris with a soft brush.

Cleaning the Filter (once a quarter)

This filter is used to trap buttons, coins, or other loose objects that may be forgotten in pockets of clothing.

Press the lower edge of the filter compartment cover to open; Remove the filter by turning counterclockwise; clean for any foreign objects. To replace reverse of removal process.

Caution: Attention must be paid to ensure that the filter is replaced correctly to avoid possible leakage.

Note: It is recommend to use a shallow pan or place a towel below the filter when cleaning as there will be water being dispensed.

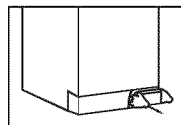
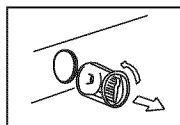
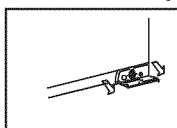

Moving & Vacationing

- Turn off water supply faucets and disconnect hoses. Drain water from all hoses. This will prevent from damaging due to water leakage if the hoses accidentally get ruptured or they become loose.
- Unplug the electrical cord from the wall outlet.
- Dry inner wash tub. If moving washer, disconnect drain hose.
- Turn the leveling legs clockwise all the way in.
- To prevent mold or mildew, leave door open so moisture inside machine can evaporate.
- Reinstall the transportation bolts and the rubber hoses in the back to prevent internal parts from shaking when appliance is moved to another location.
- If the machine is to be moved to a distant location, replace the transportation bolts and the rubber hoses which were removed during installation as shown below.

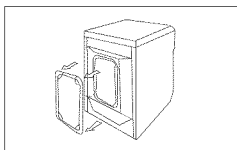

Remove the back cover.

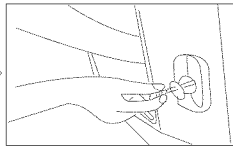

Replace the rubber hoses.

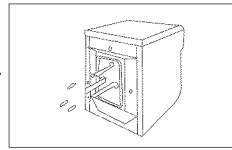

Insert the bolts.

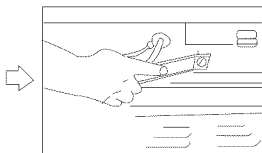

Tighten the bolt
with a spanner.

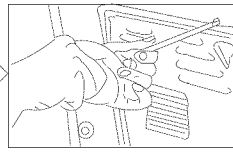

Replace the back cover.

Storage of Your Appliance in Cold Environment

- This appliance must be stored at room temperature.
- If you just got delivery of this appliance when outside temperature is below freezing, do not operate until this appliance has warmed to room temperature.
- Do not install or operate this appliance in the area where room temperature is below freezing.

TROUBLESHOOTING

Washer does not operate:

- Check if unit is plugged in. The plug may have come loose.
- Check if the electrical wall outlet is of proper voltage.
- Check if the circuit breaker needs to be reset or if the fuse needs to be replaced.
- Check if the unit is in "Off" or "Pause" mode.
- Check if the washer is overloaded: load may need to be re-balanced and clothes may need to be redistributed.
- Check if the door is open. You may have to close the door properly.
- Check if the control knob is set properly. You may have to adjust the control knob.
- The washer pauses in some cycles. This is normal in delicate or hand-washable cycle, which has short soak period where your clothes are being soaked for very short period of time. You will not hear washer operation for a short period of time. When the soak time is over, it will start automatically.

Problems with water:

- Not enough water coming out: Water faucet may need to be turned on fully. Water hoses may be tangled up or wrinkled up. Straighten up hoses.
- Water temperature is incorrect: Check your water heater temperature. Hot water needs to be at a temperature at least 120°F -140°F (49°C – 60°C). Check to make sure the inlet hoses are properly connected. (e.g. hot to hot & cold to cold)
- Water leaks: This is due to not properly installing drain hose or fill hoses. Your home drain may be clogged or having constant water pressure. You may need to tighten hoses; check the plumbing or call a plumber.
- Water will not drain: This is due to not installing your drain hose properly. You may need to connect the drain hose properly. Check the position of the drain hose. In order to drain properly, make sure that top of drain outlet is less than 2'6" above the floor.

Washer is making noise:

- Washer may need to be reinstalled. (Check washer installation section.)
- Washer load may need to be re-balanced, as the load may be uneven.
- Coins, loose change, buttons or other heavy objects could make noise (read Operating Guide – Normal Operating Sounds).
- Squealing Sound: Due to overloaded wash tub.
- Vibration Noise: Due to not leveling washer properly on the floor and uneven distribution of clothes in the tub.

Problems with clothes:

- Clothes are too wrinkled: This is due to improper sorting, overloading and washing in too hot water repeatedly. Avoid overloading and resort your load. Do not mix heavy clothes such as work clothes with light clothes such as blouses, light shirts and delicate items. You may need to wash in warm or cold water.
- Soap residue: Detergent may not be dissolving in water. Check water temperature. Use less detergent.
- Spots or stains on your clothes: This is due to incorrect use of fabric softener. You may need to read proper instructions on the detergent container and follow proper directions for using the softener.
- Clothes are grayed or yellowed: This is due to not pouring enough detergent for large loads. You may have to add more detergent to the load.
- Clothes are ripped & have holes/excessive wear & tear: This is due to sharp objects such as pins and belt buckles left in pockets. You will need to remove small loose sharp objects. Fasten belts, zippers, metal snaps etc.

Trouble messages: Judge the malfunctions from the door lock light.

Error 1: The door lock light does not illuminate.

Cause: Door is not properly shut.

Correction: Shut the door properly.

Error 2: The door lock light flashes 2 times and stops for 4 seconds repeatedly

Cause: Drainage error, water not emptied within 4 minutes.

Correction: Clean the filter and check the drain hose for blockage. If error still exists, please contact an authorized service personnel.

Error 3: The door lock light flashes 5 times and stops for 4 seconds repeatedly.

Cause: Water level not met in 8 minutes.

Correction: Make sure that tap is turned on, and water pressure is normal. If problem still exists, please contact an authorized service personnel.

Error 4: The door lock light flashes 6 times and stops for 4 seconds repeatedly.

Cause: Timing control damage.

Correction: Contact an authorized service personnel.

Error 5: The door lock light flashes 7 times and stops for 4 seconds repeatedly.

Cause: Motor overheat protection or damage.

Correction: Contact an authorized service personnel.

Error 6: The door lock light flashes 8 times and stops for 4 seconds repeatedly.

Cause: Water exceeds protective level.

Correction: Contact an authorized service personnel.

TECHNICAL SPECIFICATION



9900178

ETL LISTED
CONFORMS TO UL STD. UL2157
CERTIFIED TO CSA STD.
CSA - C22.2 NO. 169

LIMITED WARRANTY

In Home Service

Full ONE Year Warranty

For 12 months from the date of original retail purchase, Haier will repair or replace any part free of charge including labor that fails due to a defect in materials or workmanship.

Limited Warranty

After one year from the original retail purchase date, Haier will provide a part at no cost, as indicated below, to replace said part as a result of a defect in materials or workmanship. Haier is solely responsible for the cost of the part. All other costs such as labor, trip charge, etc are the responsibility of the owner.

Second through Fifth Year

Haier will provide the cabinet assembly should the cabinet rust through.

Second through Tenth Year

Haier will provide the inner stainless steel wash tub.

NOTE: This warranty commences on the date the item was purchased and the original purchase receipt must be presented to the authorized service representative before warranty repairs are rendered.

Exceptions: Commercial or Rental Use Warranty

90 days labor from date of original purchase

90 days parts from date of original purchase

No other warranty applies

For Warranty Service

Contact your nearest authorized service center. All service must be performed by a Haier authorized service center. For the name and telephone number of the nearest authorized service center please call 1-877-337-3639.

Before calling please have available the following information:

Model number and serial number of your appliance. The name and address of the dealer you purchased the unit from and the date of purchase. A clear description of the problem. A proof of purchase (sales receipt).

This warranty covers appliances within the continental United States, Puerto Rico and Canada. What is not covered by this warranty:

Replacement or repair of household fuses, circuit breakers, wiring or plumbing.

A product whose original serial number has been removed or altered.

Any service charges not specifically identified as normal such as normal service area or hours.

Damage to clothing.

Damage incurred in shipping.

Damage caused by improper installation or maintenance.

Damage from misuse, abuse accident, fire, flood, or acts of nature.

Damage from service other than an authorized Haier dealer or service center.

Damage from incorrect electrical current, voltage or supply.

Damage resulting from any product modification, alteration or adjustment not authorized by Haier.

Adjustment of consumer operated controls as identified in the owners manual.

Hoses, knobs, lint trays and all attachments, accessories and disposable parts.

Labor, service transportation, and shipping charges for the removal and replacement of defective parts beyond the initial 12-month period.

Damage from other than normal household use.

Any transportation and shipping charges.

THIS LIMITED WARRANTY IS GIVEN IN LIEU OF ALL OTHER WARRANTIES, EXPRESSED OR, INCLUDING THE WARRANTIES OF MERCHANTABILITY AND FITNESS FOR A PARTICULAR PURPOSE

The remedy provided in this warranty is exclusive and is granted in lieu of all other remedies.

This warranty does not cover incidental or consequential damages, so the above limitations may not apply to you. Some states do not allow limitations on how long an implied warranty lasts, so the above limitations may not apply to you.

This warranty gives you specific legal rights, and you may have other rights, which vary, from state to state.

Haier America
New York, NY 10018

IMPORTANT

Do Not Return This Product To The Store

If you have a problem with this product, please contact the "Haier Customer Satisfaction Center" at 1-877-337-3639.

DATED PROOF OF PURCHASE REQUIRED FOR WARRANTY SERVICE

IMPORTANT

Ne pas Réexpédier ce Produit au Magasin

Pour tout problème concernant ce produit, veuillez contacter le service des consommateurs 'Haier Customer Satisfaction Center' au 1-877-337-3639.

UNE PREUVE D'ACHAT DATEE EST REQUISE POUR BENEFICIER DE LA GARANTIE.

IMPORTANTE

No regrese este producto a la tienda

Si tiene algún problema con este producto, por favor contacte el "Centro de Servicio al Consumidor de Haier" al 1-877-337-3639 (Válido solo en E.U.A).

NECESITA UNA PRUEBA DE COMPRA FECHADA PARA EL SERVICIO DE LA GARANTIA

120V~60Hz

**Made in China
Fabriqué en Chine
Hecho en China**

Haier®

**Haier America
New York, NY 10018**

Printed in China

HWF5300A; HWF5200A; HWF5000A

PART # WD-9999-59

Issued: March 2008

©2008 Haier America Trading, LLC. All Rights Reserved. 100686 0608