



**LG**

Life's Good

# OWNER'S MANUAL PLASMA TV

Please read this manual carefully before operating your set and retain it for future reference.

42PT200	50PV400	42PT250U	42PT350C
50PT200	60PV400	50PT250U	50PT350C
42PT330	50PV430	50PV550U	50PV450C
50PT330	60PV430	60PV550U	60PV450C
42PT350	50PV450		
50PT350	60PV450		

# WARNING / CAUTION



**WARNING / CAUTION**  
RISK OF ELECTRIC SHOCK  
DO NOT OPEN



**TO REDUCE THE RISK OF ELECTRIC SHOCK  
DO NOT REMOVE COVER (OR BACK). NO  
USER SERVICEABLE PARTS INSIDE. REFER TO  
QUALIFIED SERVICE PERSONNEL.**

---

 The lightning flash with arrowhead symbol, within an equilateral triangle, is intended to alert the user to the presence of uninsulated “dangerous voltage” within the product’s enclosure that may be of sufficient magnitude to constitute a risk of electric shock to persons.

---

 The exclamation point within an equilateral triangle is intended to alert the user to the presence of important operating and maintenance (servicing) instructions in the literature accompanying the appliance.

## WARNING/CAUTION

**TO REDUCE THE RISK OF FIRE AND ELECTRIC SHOCK, DO NOT EXPOSE THIS PRODUCT TO RAIN OR MOISTURE.**

## NOTE TO CABLE/TV INSTALLER

This reminder is provided to call the CATV system installer’s attention to Article 820-40 of the National Electric Code (U.S.A.). The code provides guidelines for proper grounding and, in particular, specifies that the cable ground shall be connected to the grounding system of the building, as close to the point of the cable entry as practical.

# WARNING / CAUTION

To prevent fire or shock hazards, do not expose this product to rain or moisture.

## FCC NOTICE

### Class B digital device

This equipment has been tested and found to comply with the limits for a Class B digital device, pursuant to Part 15 of the FCC Rules. These limits are designed to provide reasonable protection against harmful interference in a residential installation. This equipment generates, uses and can radiate radio frequency energy and, if not installed and used in accordance with the instructions, may cause harmful interference to radio communications. However, there is no guarantee that interference will not occur in a particular installation. If this equipment does cause harmful interference to radio or television reception, which can be determined by turning the equipment off and on, the user is encouraged to try to correct the interference by one or more of the following measures:

- Reorient or relocate the receiving antenna.
- Increase the separation between the equipment and receiver.
- Connect the equipment to an outlet on a circuit different from that to which the receiver is connected.
- Consult the dealer or an experienced radio/TV technician for help.

This device complies with part 15 of the FCC Rules.

Operation is subject to the following two conditions: (1) This device may not cause (harmful) interference, and (2) this device must accept any interference received, including interference that may cause undesired operation (of the device).

**Any changes or modifications not expressly approved by the party responsible for compliance could void the user’s authority to operate the equipment.**

## CAUTION

Do not attempt to modify this product in any way without written authorization from LG Electronics. Unauthorized modification could void the user’s authority to operate this product

# SAFETY INSTRUCTIONS

## IMPORTANT SAFETY INSTRUCTIONS

Read these instructions.

Keep these instructions.

Heed all warnings.

Follow all instructions.

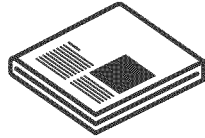

- 1** Do not use this apparatus near water.

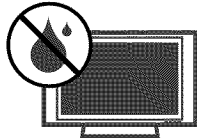

- 2** Clean only with soft dry cloth.



- 3** Do not block any ventilation openings. Install in accordance with the manufacturer's instructions.

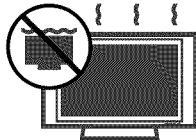

- 4** Do not install near any heat sources such as radiators, heat registers, stoves, or other apparatus (including amplifiers) that produce heat.



- 5** Do not defeat the safety purpose of the polarized or grounding-type plug. A polarized plug has two blades with one wider than the other. A grounding type plug has two blades and a third grounding prong. The wide blade or the third prong are provided for your safety. If the provided plug does not fit into your outlet, consult an electrician for replacement of the obsolete outlet. (Can differ by country)

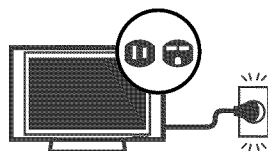

- 6** Protect the power cord from being walked on or pinched particularly at plugs, convenience receptacles, and the point where they exit from the apparatus.

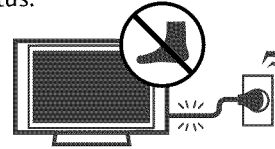

- 7** Only use attachments/accessories specified by the manufacturer.

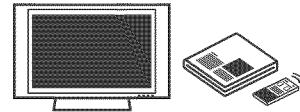

- 8** Use only with the cart, stand, tripod, bracket, or table specified by the manufacturer, or sold with the apparatus. When a cart is used, use caution when moving the cart/apparatus combination to avoid injury from tip-over.

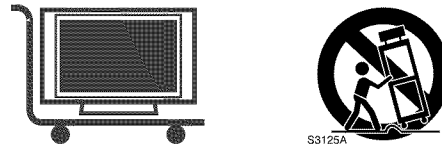

- 9** Unplug this apparatus during lightning storms or when unused for long periods of time.

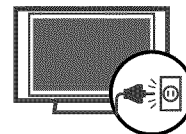

- 10** Refer all servicing to qualified service personnel. Servicing is required when the apparatus has been damaged in any way, such as power-supply cord or plug is damaged, liquid has been spilled or objects have fallen into the apparatus, the apparatus has been exposed to rain or moisture, does not operate normally, or has been dropped.

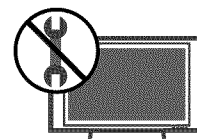

# SAFETY INSTRUCTIONS

- 11** Never touch this apparatus or antenna during a thunder or lightning storm.

- 12** When mounting a TV on the wall, make sure not to install the TV by the hanging power and signal cables on the back of the TV.

- 13** Do not allow an impact shock or any objects to fall into the product, and do not drop onto the screen with something.

- 14** **CAUTION** concerning the Power Cord:  
It is recommend that appliances be placed upon a dedicated circuit; that is, a single outlet circuit which powers only that appliance and has no additional outlets or branch circuits. Check the specification page of this owner's manual to be certain.

Do not connect too many appliances to the same AC power outlet as this could result in fire or electric shock.

Do not overload wall outlets. Overloaded wall outlets, loose or damaged wall outlets, extension cords, frayed power cords, or damaged or cracked wire insulation are dangerous. Any of these conditions could result in electric shock or fire. Periodically examine the cord of your appliance, and if its appearance indicates damage or deterioration, unplug it, discontinue use of the appliance, and have the cord replaced with an exact replacement part by an authorized servicer. Protect the power cord from physical or mechanical abuse, such as being twisted, kinked, pinched, closed in a door, or walked upon. Pay particular attention to plugs, wall outlets, and the point where the cord exits the appliance.

Do not make the TV with the power cord plugged in. Do not use a damaged or loose power cord. Be sure do grasp the plug when unplugging the power cord. Do not pull on the power cord to unplug the TV.

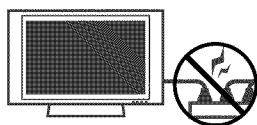

- 15** **WARNING** - To reduce the risk of fire or electrical shock, do not expose this product to rain, moisture or other liquids. Do not touch the TV with wet hands. Do not install this product near flammable objects such as gasoline or candles or expose the TV to direct air conditioning.

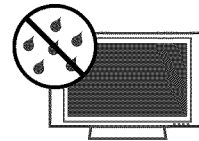

- 16** Do not expose to dripping or splashing and do not place objects filled with liquids, such as vases, cups, etc. on or over the apparatus (e.g. on shelves above the unit).



- 17** **GROUNDING**  
Ensure that you connect the earth ground wire to prevent possible electric shock (i.e. a TV with a three-prong grounded AC plug must be connected to a three-prong grounded AC outlet). If grounding methods are not possible, have a qualified electrician install a separate circuit breaker.

Do not try to ground the unit by connecting it to telephone wires, lightning rods, or gas pipes.

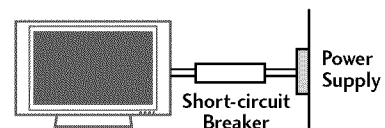

- 18** **DISCONNECTING DEVICE FROM MAINS**  
Mains plug is the disconnecting device. The plug must remain readily operable.

- 19** "As long as this unit is connected to the AC wall outlet, it is not disconnected from the AC power source even if you turn off this unit by SWITCH"

## 20 ANTENNAS

### Outdoor antenna grounding

(can differ by country) If an outdoor antenna is installed, follow the precautions below. An outdoor antenna system should not be located in the vicinity of overhead power lines or other electric light or power circuits, or where it can come in contact with such power lines or circuits as death or serious injury can occur.

Be sure the antenna system is grounded so as to provide some protection against voltage surges and built-up static charges.

Section 810 of the National Electrical Code (NEC) in the U.S.A. provides information with respect to proper grounding of the mast and supporting structure, grounding of the lead-in wire to an antenna discharge unit, size of grounding conductors, location of antenna discharge unit, connection to grounding electrodes and requirements for the grounding electrode.

### Antenna grounding according to the National Electrical Code, ANSI/NFPA 70

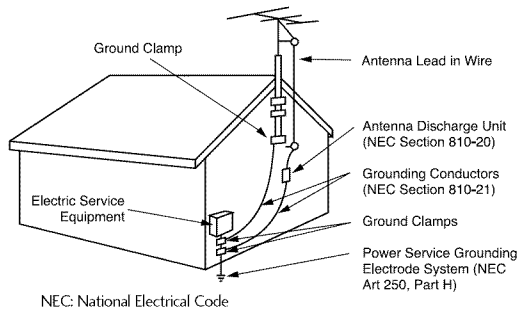

## 21 Cleaning

When cleaning, unplug the power cord and scrub gently with a soft cloth to prevent scratching. Do not spray water or other liquids directly on the TV as electric shock may occur. Do not clean with chemicals such as alcohol, thinners or benzene.

## 22 Moving

Make sure the product is turned off, unplugged and all cables have been removed. It may take 2 or more people to carry larger TVs. Do not press against or put stress on the front panel of the TV.

## 23 Ventilation

Install your TV where there is proper ventilation. Do not install in a confined space such as a bookcase. Do not cover the product with cloth or other materials (e.g.) plastic while plugged in. Do not install in excessively dusty places.

24 Take care not to touch the ventilation openings. When watching the TV for a long period, the ventilation openings may become hot. This does not affect the performance of the product or cause defects in the product.

25 If you smell smoke or other odors coming from the TV or hear strange sounds, unplug the power cord contact an authorized service center.

26 Do not press strongly upon the panel with hand or sharp object such as nail, pencil or pen, or make a scratch on it. Do not allow a impact shock onto the panel.

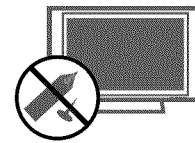

27 Keep the product away from direct sunlight.

## 28 Dot Defect

The Plasma or LCD panel is a high technology product with resolution of two million to six million pixels. In a very few cases, you could see fine dots on the screen while you're reviewing the TV. Those dots are deactivated pixels and do not affect the performance and reliability of the TV.

## 29 Generated Sound

“Cracking” noise: A cracking noise that occurs when watching or turning off the TV is generated by plastic thermal contraction due to temperature and humidity. This noise is common for products where thermal deformation is required.

Electrical circuit humming/panel buzzing: A low level noise is generated from a high-speed switching circuit, which supplies a large amount of current to operate a product. It varies depending on the product. This generated sound does not affect the performance and reliability of the product.

# CONTENTS

<b>WARNING / CAUTION</b> .....	2
<b>SAFETY INSTRUCTIONS</b> .....	3
<b>FEATURE OF THIS TV</b> .....	8

## PREPARATION

Accessories .....	9
Front Panel Information .....	10
Back Panel Information .....	11
Stand Instruction .....	13
Cable Management .....	15
Desktop Pedestal Installation .....	16
Swivel Stand .....	16
VESA Wall Mounting .....	17
Securing the TV to the wall to prevent falling when the TV is used on a stand .....	18
Antenna or Cable Connection .....	19

## EXTERNAL EQUIPMENT SETUP

HD Receiver Setup .....	20
DVD Setup .....	23
VCR Setup .....	25
Other A/V Source Setup .....	26
USB Connection .....	26
Audio Out Connection .....	27
PC Setup .....	28

## WATCHING TV / CHANNEL CONTROL

Remote Control Functions .....	34
Turning On TV .....	36
Channel Selection .....	36
Volume Adjustment .....	36
Initial Setting .....	37
On-Screen Menus Selection .....	38
Quick Menu .....	39
Channel Setup	
- Auto Scan (Auto Tuning) .....	40

- Add / Delete Channel (Manual Tuning) .....	41
- Channel Editing .....	42
Channel List .....	43
Favorite Channel Setup .....	44
Favorite Channel List .....	45
Brief Information .....	46
Input List .....	47
Input Label .....	48
AV Mode .....	49
SIMPLINK .....	50

## USB

Entry Modes .....	52
Photo List .....	53
Music List .....	59
Movie List .....	62
DivX Registration Code .....	68
Deactivation .....	69

## PICTURE CONTROL

Picture Size (Aspect Ratio) Control .....	70
Picture Wizard .....	72
 Energy Saving .....	74
Preset Picture Settings (Picture Mode) .....	75
Manual Picture Adjustment - User Mode .....	76
Picture Improvement Technology .....	77
Expert Picture Control .....	78
Picture Reset .....	80
Demo Mode .....	80
Image Sticking Minimization (ISM) Method .....	81

## SOUND & LANGUAGE CONTROL

Auto Volume Leveler (Auto Volume) .....	82
Clear Voice II .....	83
Preset Sound Settings (Sound Mode) .....	84
Sound Setting Adjustment - User Mode .....	85
Infinite Surround .....	86
Balance .....	87
TV Speakers On/Off Setup .....	88
Audio Reset .....	89
Stereo/SAP Broadcast Setup .....	90
Audio Language .....	91
On-Screen Menus Language Selection .....	92
Caption Mode	
- Analog Broadcasting System Captions .....	93
- Digital Broadcasting System Captions .....	94
- Caption Option .....	95

## TIME SETTING

Clock Setting	
- Auto Clock Setup .....	96
- Manual Clock Setup .....	97
Auto On/Off Time Setting .....	98
Sleep Timer Setting .....	99

## PARENTAL CONTROL / RATINGS

Set Password & Lock System .....	100
Channel Blocking .....	103
Movie & TV Rating .....	104
Downloadable Rating .....	109
External Input Blocking .....	110
Key lock .....	111

## APPENDIX

Troubleshooting .....	112
Maintenance .....	114
Product Specifications .....	114
IR Codes .....	116
External Control Through RS-232C .....	118

# FEATURE OF THIS TV

- This feature is not available for all models.



High-definition television. High-resolution digital television broadcast and playback system composed of roughly a million or more pixels, 16:9 aspect-ratio screens, and AC3 digital audio. A subset of digital television, HDTV formats include 1080i and 720p resolutions.



This TV contains the detailed calibrations necessary for professional certification by the Imaging Science Foundation. The resulting ISF "day" and "night" modes will then be accessible by the user to experience the best their LG HDTV has to offer. Sophisticated and detailed calibrations can be made through the ISFccc mode. Detailed calibration requires a licensed technician. Please contact your local dealer to inquire about an ISF certified technician.



AV Mode is three preset picture and audio settings. It allows the viewer to quickly switch between common settings. It includes Cinema, Sports, and Game Modes.



Automatically enhances and amplifies the sound of human voice frequency range to help keep dialogue audible when background noise swells.



Displays HDTV programs in full 1920 x 1080p resolution for a more detailed picture.



View videos and photos and listen to music on your TV through USB 2.0 ('videos' dependent on model).



Manufactured under license from Dolby Laboratories. "Dolby" and the double-D symbol are trademarks of Dolby Laboratories.



HDMI, the HDMI logo and High-Definition Multimedia Interface are trademarks or registered trademarks of HDMI Licensing LLC."



Unlike other sensors which can only sense brightness of ambient light, LG's "Intelligent Sensor" uses 4,096 sensing steps to evaluate its surroundings. Using a sophisticated algorithm, the LG processes picture quality elements including brightness, contrast, color, sharpness and white balance. The result is a picture optimized for it's surroundings, more pleasing to watch and which can also save up to 50% in power consumption.



ABOUT DIVX VIDEO: DivX® is a digital video format created by DivX, Inc. This is an official DivX Certified® device that plays DivX video. Visit [www.divx.com](http://www.divx.com) for more information and software tools to convert your files into DivX video.

ABOUT DIVX VIDEO-ON-DEMAND: This DivX Certified® device must be registered in order to play purchased DivX Video-on-Demand (VOD) movies. To obtain your registration code, locate the DivX VOD section in your device setup menu. Go to [vod.divx.com](http://vod.divx.com) for more information on how to complete your registration.

"DivX Certified® to play DivX® video, including premium content"

DivX®, DivX Certified® and associated logos are trademarks of DivX, Inc. and are used under license.

Covered by one or more of the following U.S. patents :  
7,295,673; 7,460,668; 7,515,710; 7,519,274



## IMPORTANT INFORMATION TO PREVENT "IMAGE BURN / BURN-IN" ON YOUR TV SCREEN

- When a fixed image (e.g. logos, screen menus, video game, and computer display) is displayed on the TV for an extended period, it can become permanently imprinted on the screen. This phenomenon is known as "image burn" or "burn-in." Image burn is not covered under the manufacturer's warranty.
- In order to prevent image burn, avoid displaying a fixed image on your TV screen for a prolonged period (2 or more hours for LCD, 1 or more hours for Plasma).
- Image burn can also occur on the letterboxed areas of your TV if you use the 4:3 aspect ratio setting for an extended period.

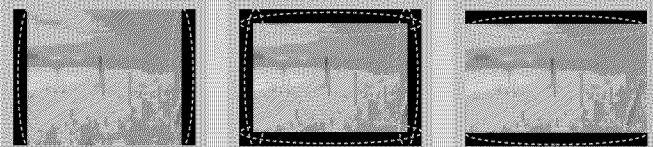



# PREPARATION

## ACCESSORIES

Ensure that the following accessories are included with your TV. If an accessory is missing, please contact the dealer where you purchased the TV.

The accessories included may differ from the images below.

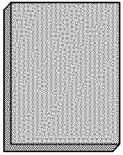

Owner's Manual

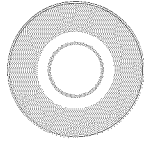

CD Manual

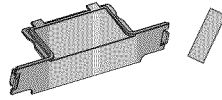

Protection Cover and Tape  
(Refer to P.14)

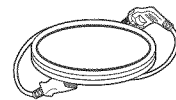

Power Cord



Ferrite Core  
(Depending on model)

(For 42/50PT200, 42/50PT330, 42/50PT350,  
42/50PT350C, 42/50PT250U, 50PV400,  
50PV430, 50PV450, 50PV450C, 50PV550U)



x 4

M4x26



x 3

M5x14.5

Screws for stand assembly  
(Refer to P.13, 14)



x 4

M4x28



x 3

M5x24

Screws for stand assembly  
(Refer to P.13, 14)

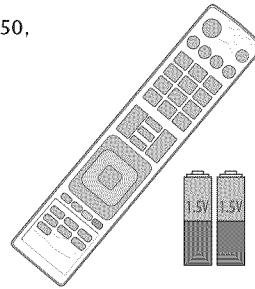

Remote Control,  
Batteries (AAA)

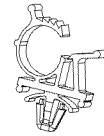

Power Cord Holder



Cable Holder

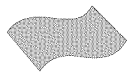

Polishing Cloth

(Not included with all models)

\* Wipe spots on the exterior only with the polishing cloth.

\* Do not wipe roughly when removing spots. Excessive pressure may cause scratch or discoloration.

### Option Extras

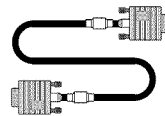

D-sub 15 pin Cable

When using the VGA (D-sub 15 pin cable) PC connection, the user must use shielded signal interface cables with ferrite cores to maintain standards compliance.

### ■ How to use the Ferrite Core

1. Use the ferrite core to reduce the electromagnetic interference in the PC audio cable.  
Wind the PC audio cable on the ferrite core thrice. Place the ferrite core close to the TV.



2. Use the ferrite core to reduce the electromagnetic interference in the power cable.  
Wind the power cable on the ferrite core once. Place the ferrite core close to the TV.

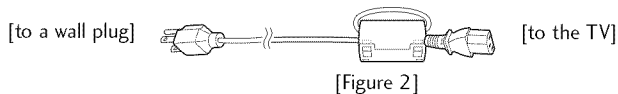

3. Use the ferrite core to reduce the electromagnetic interference in the power cable.  
Wind the power cable on the ferrite core once. Place the ferrite core close to the TV and a wall plug.

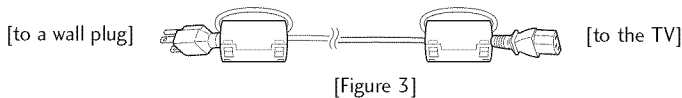

- If there is one ferrite core, follow as shown in Figure 1.
- If there are two ferrite cores, follow as shown in Figures 1 and 2.
- If there are three ferrite cores, follow as shown in Figures 1 and 3.

# PREPARATION

## FRONT PANEL INFORMATION

■ Image shown may differ from your TV.

PREPARATION

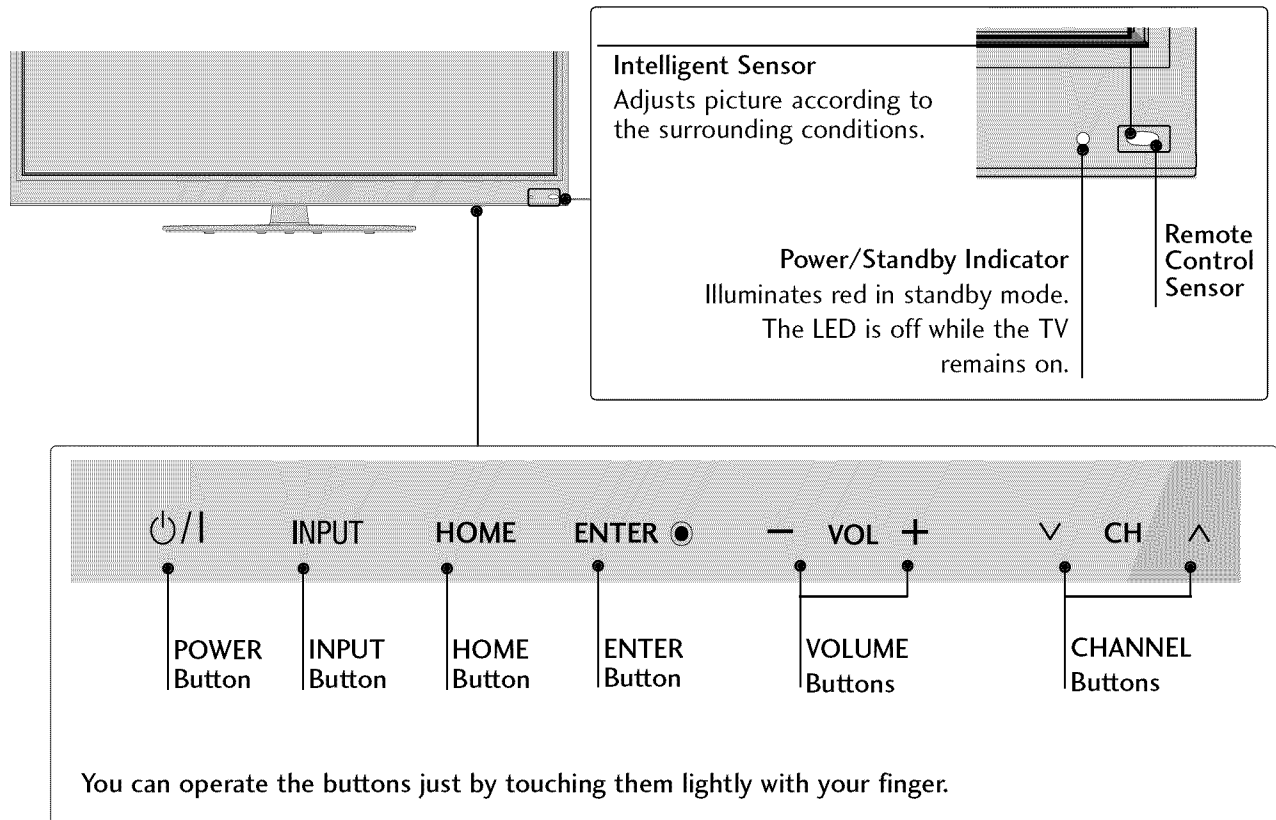

- ▶ Do not step on the glass stand or subject it to any impact. It may break, causing possible injury from fragments of glass, or the TV may fall.
- ▶ Do not drag the TV. The floor or the product may be damaged.

# BACK PANEL INFORMATION

■ Image shown may differ from your TV.

(For 42/50PT250U, 42/50PT350,  
42/50PT350C, 50/60PV450,  
50/60PV450C, 50/60PV550U)

(For 42/50PT200, 42/50PT330,  
50/60PV400, 50/60PV430)

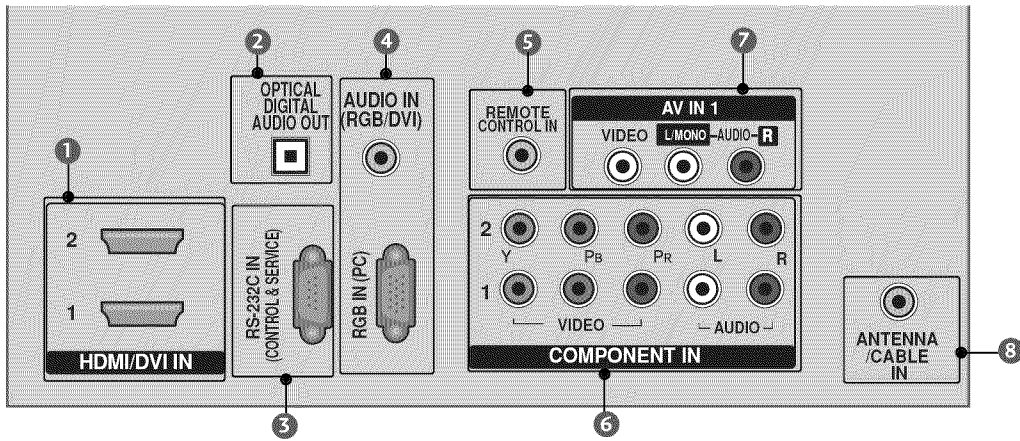
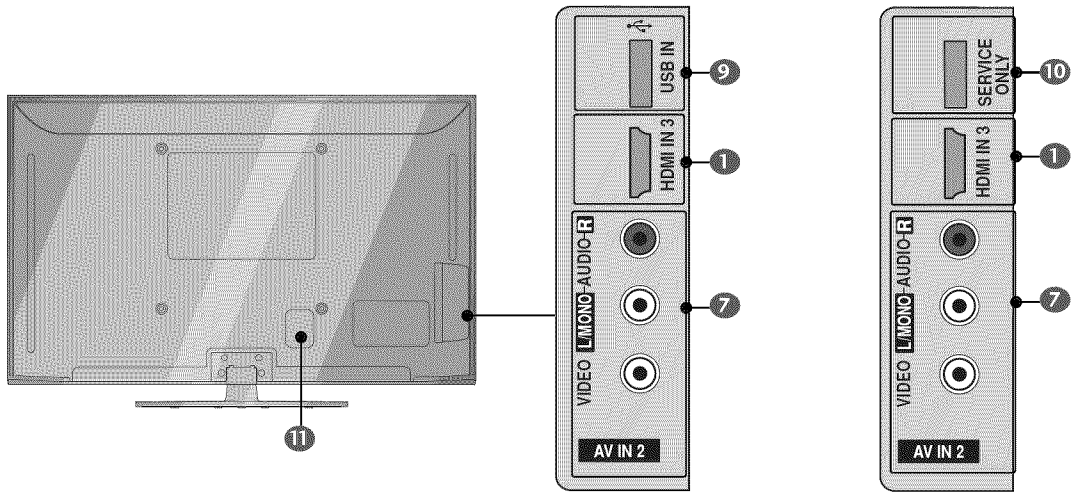

# PREPARATION

- 1 HDMI/DVI IN**  
Digital Connection. Supports HD video and Digital audio. Doesn't support 480i.  
Accepts DVI video using an adapter or HDMI to DVI cable (not included)
- 2 OPTICAL DIGITAL AUDIO OUT**  
Optical digital audio output for use with amps and home theater systems.  
Note: In standby mode, this port doesn't work.
- 3 RS-232C IN (CONTROL & SERVICE) PORT**  
Used by third party devices.
- 4 AUDIO IN (RGB/DVI)**  
1/8" headphone jack for analog PC audio input.  
**RGB IN (PC)**  
Analog PC Connection. Uses a D-sub 15 pin cable (VGA cable).
- 5 REMOTE CONTROL IN PORT**  
For a wired remote control.
- 6 COMPONENT IN**  
Analog Connection. Supports HD.  
Uses a red, green, and blue cable for video & red and white for audio.
- 7 AV (Audio/Video) IN**  
Analog composite connection. Supports standard definition video only (480i).
- 8 ANTENNA/CABLE IN**  
Connect over-the air signals to this jack.  
Connect cable signals to this jack.
- 9 USB IN**  
Used for viewing photos, watching movies and listening to MP3s.
- 10 SERVICE ONLY**  
Used for software updates.
- 11 Power Cord Socket**  
For operation with AC power.  
Caution: Never attempt to operate the TV on DC power.

# STAND INSTRUCTION

■ Image shown may differ from your TV.

## Installation

- 1 Carefully place the TV screen side down on a cushioned surface to protect the screen from damage.

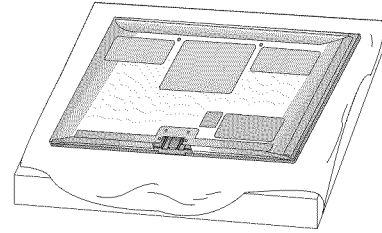

- 2 Assemble the parts of the Stand Body with the Stand Base of the TV.

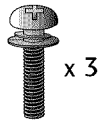

M5x24

(For 60PV400, 60PV430, 60PV450, 60PV450C, 60PV550U)

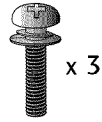

M5x14.5

(For 42/50PT200, 42/50PT330, 42/50PT350, 42/50PT350C, 42/50PT250U, 50PV400, 50PV430, 50PV450, 50PV450C, 50PV550U)

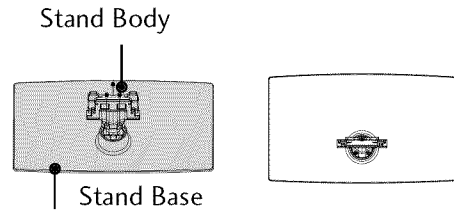

- 3 Assemble the TV as shown.

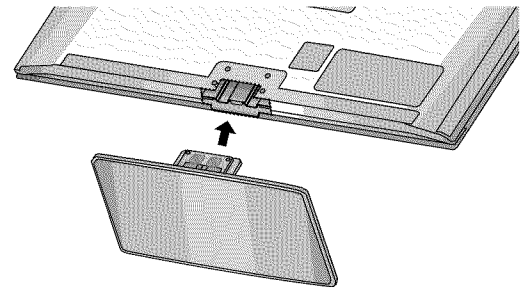

- 4 Fix the 4 screws securely using the holes in the back of the TV.



M4x28

(For 60PV400, 60PV430, 60PV450, 60PV450C, 60PV550U)



M4x26

(For 42/50PT200, 42/50PT330, 42/50PT350, 42/50PT350C, 42/50PT250U, 50PV400, 50PV430, 50PV450, 50PV450C, 50PV550U)

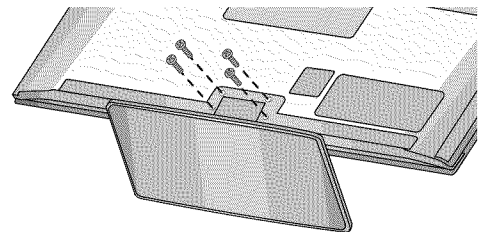

# PREPARATION

## Detachment

- 1 Carefully place the TV screen side down on a cushioned surface to protect the screen from damage.

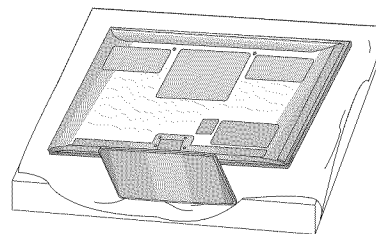

- 2 Loosen the screws from TV.

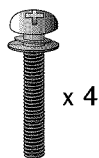

M4x28

(For 60PV400, 60PV430, 60PV450, 60PV450C, 60PV550U)



M4x26

(For 42/50PT200, 42/50PT330, 42/50PT350, 42/50PT350C, 42/50PT250U, 50PV400, 50PV430, 50PV450, 50PV450C, 50PV550U)

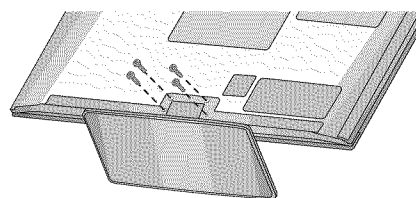

- 3 Detach the stand from TV.

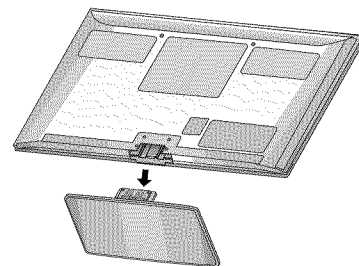

- 4 After removing the stand, install the included **PROTECTION COVER** over the hole for the stand.  
Attach the protection cover tape.  
When installing the wall mounting bracket, use the **PROTECTION COVER**.

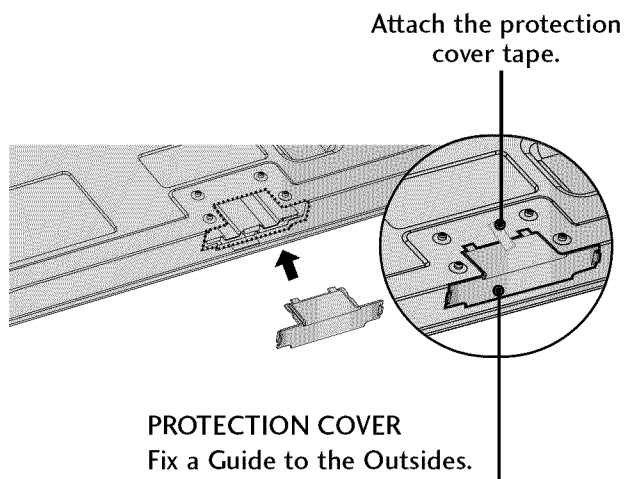

# CABLE MANAGEMENT

■ Image shown may differ from your TV.

**1** Install the power cord holder and power cord.  
It will help prevent the power cable from being removed by accident.

**2** Gather and bind the cables with the cable holder.

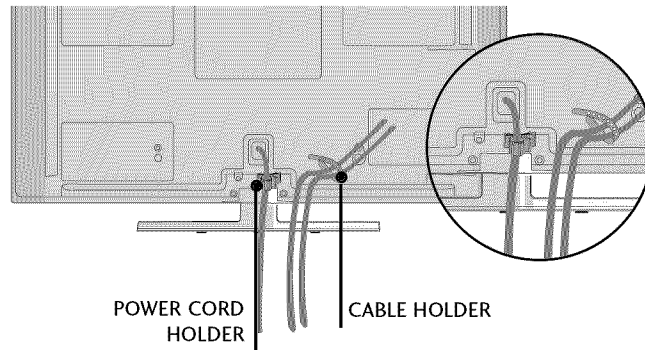

## ⚠ CAUTION

▶ Do not move the TV by holding the cable holder and power cord holder, as the cable holders may break, and injuries and damage to the TV may occur.

# PREPARATION

## DESKTOP PEDESTAL INSTALLATION

- Image shown may differ from your TV.

For proper ventilation, allow a clearance of 4 inches on all four sides from the wall.

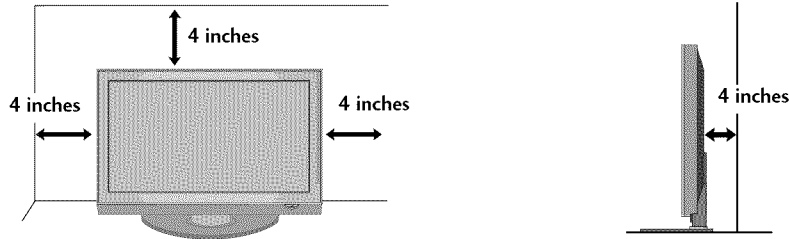

### ⚠ CAUTION

- ▶ Ensure adequate ventilation by following the clearance recommendations.
- ▶ Do not mount near or above any type of heat source.

## SWIVEL STAND

- This feature is not available for all models.

After installing the TV, you can adjust the TV manually to the left or right direction by 20 degrees to suit your viewing position.

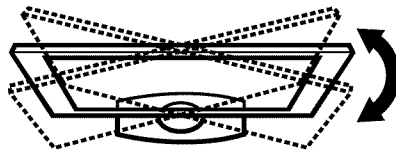



# VESA WALL MOUNTING

Install your wall mount on a solid wall perpendicular to the floor. When attaching to other building materials, please contact your nearest installer.

If installed on a ceiling or slanted wall, it may fall and result in severe personal injury.

We recommend that you use an LG brand wall mount when mounting the TV to a wall.

LG recommends that wall mounting be performed by a qualified professional installer.

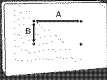
Model	VESA (A * B) 	Standard Screw	Quantity	Wall Mounting bracket (sold separately)
42/50PT200, 42/50PT330, 42/50PT350, 42/50PT350C, 50PV400, 50PV430, 50PV450, 50PV450C, 42/50PT250U, 50PV550U	400 * 400	M6	4	PSW400B, PSW400BG, DSW400BG
60PV400, 60PV430, 60PV450, 60PV450C, 60PV550U	600 * 400	M8	4	PSW600B, PSW600BG

## NOTE

- ▶ Screw length needed depends on the wall mount used. For further information, refer to the instructions included with the mount.
- ▶ Standard dimensions for wall mount kits are shown in the table.
- ▶ When purchasing our wall mount kit, a detailed installation manual and all parts necessary for assembly are provided.
- ▶ Do not use screws longer than the standard dimension, as they may cause damage to the inside of the TV.
- ▶ For wall mounts that do not comply with the VESA standard screw specifications, the length of the screws may differ depending on their specifications.
- ▶ Do not use screws that do not comply with the VESA standard screw specifications. Do not use fasten the screws too strongly, this may damage the TV or cause the TV to a fall, leading to personal injury. LG is not liable for these kinds of accidents.
- ▶ LG is not liable for TV damage or personal injury when a non-VESA or non specified wall mount is used or the consumer fails to follow the TV installation instructions.

## CAUTION

- ▶ Do not install your wall mount kit while your TV is turned on. It may result in personal injury due to electric shock.

# PREPARATION

## SECURING THE TV TO THE WALL TO PREVENT FALLING WHEN THE TV IS USED ON A STAND

- You should purchase necessary components to prevent the TV from tipping over (when not using a wall mount).
- Image shown may differ from your TV.

We recommend that you set up the TV close to a wall so it cannot fall over if pushed backwards.

Additionally, we recommend that the TV be attached to a wall so it cannot be pulled in a forward direction, potentially causing injury or damaging the product.

Caution: Please make sure that children don't climb on or hang from the TV.

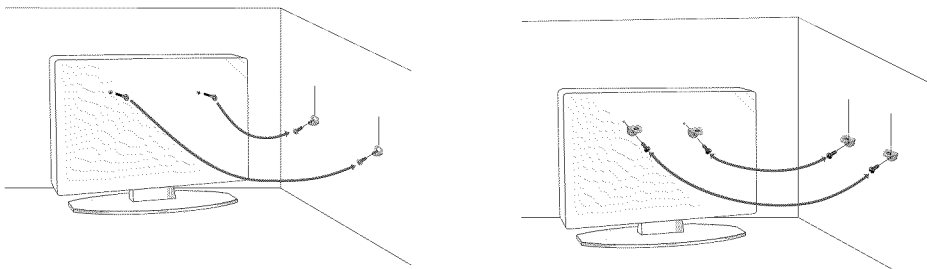

- Insert the eye-bolts (or TV brackets and bolts) to tighten the product to the wall as shown in the picture.

\* If your product has the bolts in the eye-bolts position before inserting the eye-bolts, loosen the bolts.

\* Insert the eye-bolts or TV brackets/bolts and tighten them securely in the upper holes.

Secure the wall brackets with the bolts (sold separately) to the wall. Match the height of the bracket that is mounted on the wall to the holes in the product.

Ensure the eye-bolts or brackets are tightened securely.

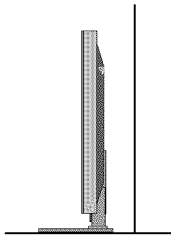

- Use a sturdy rope (sold separately) to tie the product. It is safer to tie the rope so it becomes horizontal between the wall and the product.

### NOTE

- ▶ Use a platform or cabinet strong enough and large enough to support the size and weight of the TV.
- ▶ To use the TV safely, make sure that the height of the bracket on the wall and the one on the TV are the same.

- To prevent damage do not connect to the power outlet until all connections are made between the devices.

# ANTENNA OR CABLE CONNECTION

## 1. Antenna (Analog or Digital)

Wall Antenna Socket or Outdoor Antenna without a Cable Box Connection.

For optimum picture quality, adjust antenna direction if needed.

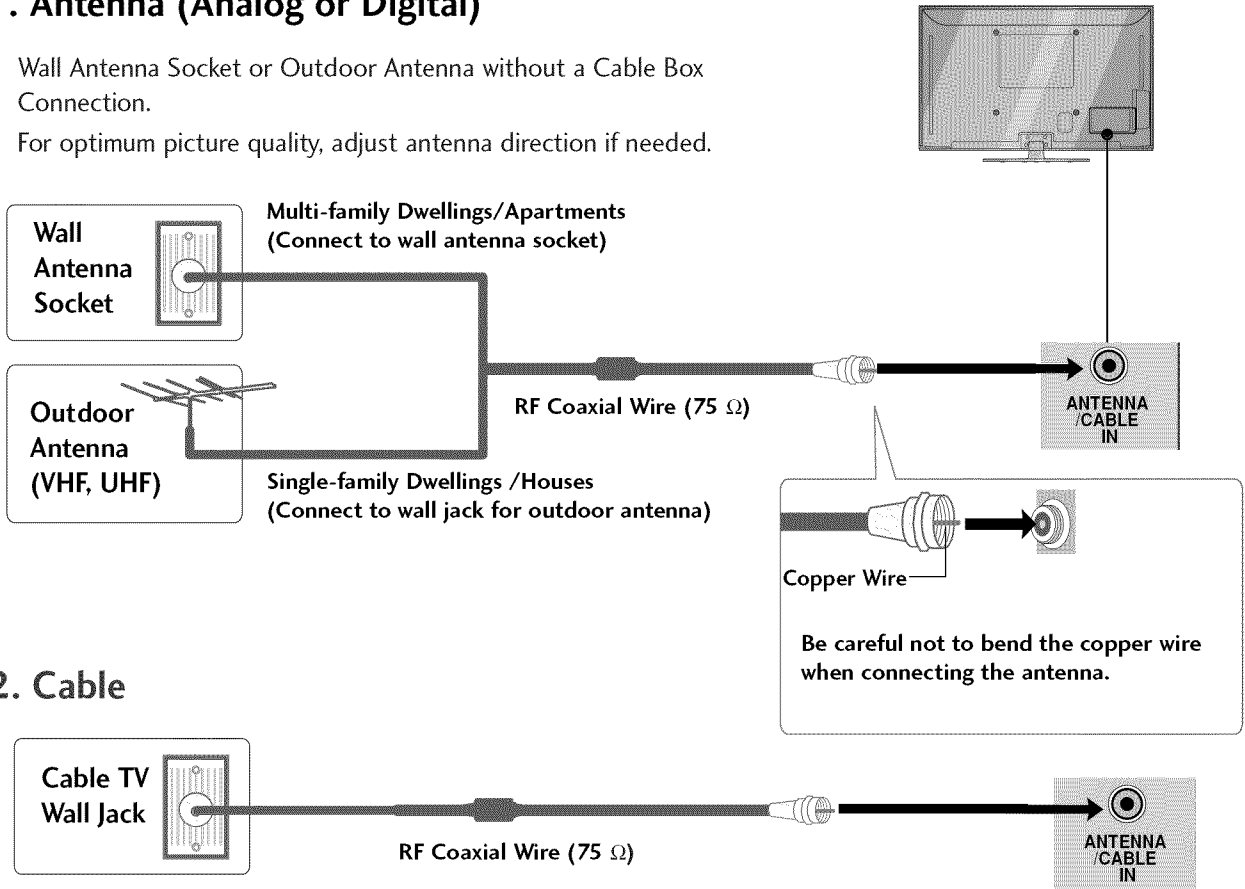

## 2. Cable

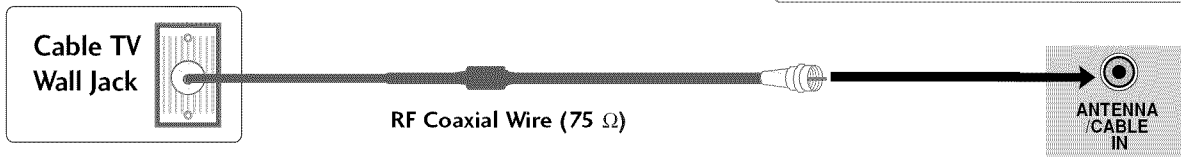

- To improve the picture quality in a poor signal area, please purchase a signal amplifier and install properly.
- If the antenna needs to be split for two TV's, install a 2-Way Signal Splitter.
- If the antenna is not installed properly, contact your dealer for assistance.

# EXTERNAL EQUIPMENT SETUP

- To prevent the equipment damage, never plug in any power cords until you have finished connecting all equipment.
- Image shown may differ from your TV.

## HD RECEIVER SETUP

This TV can receive Digital Over-the-air/Cable signals without an external digital set-top box. However, if you do receive digital signals from a digital set-top box or other digital external device, refer to the figure as shown below.

### Component Connection

#### 1. How to connect

- 1 Connect the video outputs (Y, PB, PR) of the digital set-top box to the **COMPONENT IN VIDEO 1** jacks on the TV. Match the jack colors (Y = green, PB = blue, and PR = red).
- 2 Connect the audio output of the digital set-top box to the **COMPONENT IN AUDIO 1** jacks on the TV.

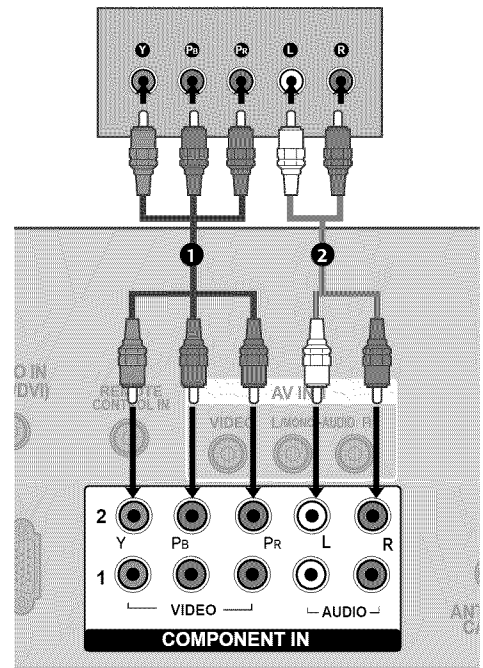

#### 2. How to use

- Turn on the digital set-top box.  
(Refer to the owner's manual for the digital set-top box. operation)
- Select the **Component1** input source on the TV using the **INPUT** button on the remote control.
- If connected to **COMPONENT IN 2** input, select the **Component2** input source on the TV.

#### Supported Resolutions

Signal	Component	HDMI
480i	Yes	No
480p	Yes	Yes
720p	Yes	Yes
1080i	Yes	Yes
1080p	Yes	Yes

#### Y, CB/PB, CR/PR

Resolution	Horizontal Frequency(KHz)	Vertical Frequency(Hz)
720x480i	15.73	59.94
	15.73	60.00
720x480p	31.47	59.94
	31.47	60.00
1280x720p	44.96	59.94
	45.00	60.00
1920x1080i	33.72	59.94
	33.75	60.00
1920x1080p	27.00	24.00
	33.75	30.00
	67.432	59.939
	67.50	60.00
	26.97	23.94
	33.71	29.97

## HDMI Connection

### 1. How to connect

- 1 Connect the digital set-top box to HDMI/DVI IN 1, 2, or HDMI IN 3 jack on the TV.
- 2 No separate audio connection is necessary. HDMI supports both audio and video.

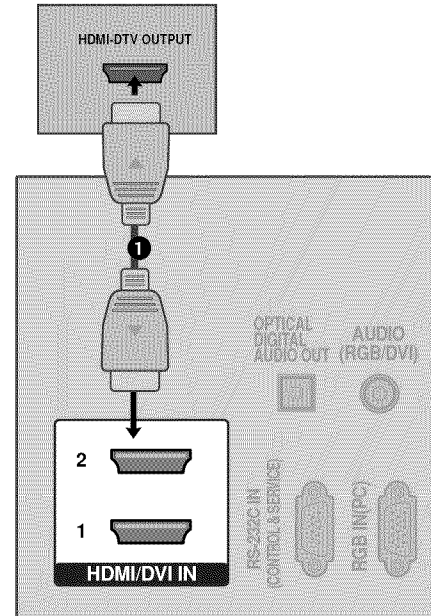

### 2. How to use

- Turn on the digital set-top box.  
(Refer to the owner's manual for the digital set-top box.)
- Select the HDMI1, 2, or 3 input source on the TV using the INPUT button on the remote control.

#### NOTE

- ▶ If an HDMI cable doesn't support High Speed HDMI, it can cause flickers or no screen display. In this case use the latest cables that support High Speed HDMI.
- ▶ HDMI mode supports PCM, AC-3 (Dolby Digital) audio format.

#### HDMI-DTV

Resolution	Horizontal Frequency(KHz)	Vertical Frequency(Hz)
720x480p	31.47	59.94
	31.47	60.00
1280x720p	44.96	59.94
	45.00	60.00
1920x1080i	33.72	59.94
	33.75	60.00
1920x1080p	27.00	24.00
	33.75	30.00
	67.432	59.939
	67.50	60.00
	26.97	23.94
	33.71	29.97

# EXTERNAL EQUIPMENT SETUP

## DVI to HDMI Connection

### 1. How to connect

- 1 Connect the DVI output of the digital set-top box to the HDMI/DVI IN 1 or 2 jack on the TV.
- 2 Connect the audio output of the digital set-top box to the AUDIO IN (RGB/DVI) jack on the TV.

### 2. How to use

- Turn on the digital set-top box. (Refer to the owner's manual for the digital set-top box.)
- Select the HDMI1 or 2 input source on the TV using the INPUT button on the remote control.

#### NOTE

- ▶ A DVI to HDMI cable or adapter is required for this connection. DVI doesn't support audio, so a separate audio connection is necessary.

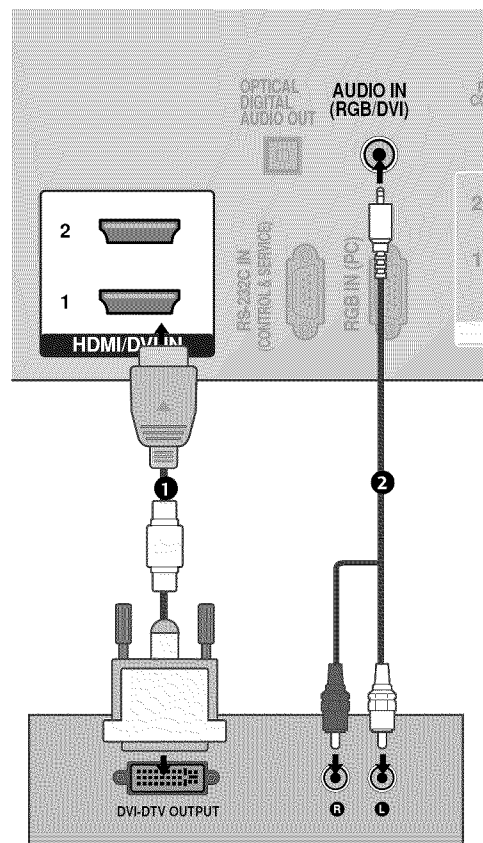

# DVD SETUP

## Component Connection

### 1. How to connect

- 1 Connect the video outputs (Y, PB, PR) of the DVD to the **COMPONENT IN VIDEO 1** jacks on the TV.  
Match the jack colors (Y = green, PB = blue, and PR = red).
- 2 Connect the audio outputs of the DVD to the **COMPONENT IN AUDIO 1** jacks on the TV.

### 2. How to use

- Turn on the DVD player; insert a DVD.
- Select the **Component1** input source on the TV using the **INPUT** button on the remote control.
- If connected to **COMPONENT IN 2** input, select the **Component2** input source on the TV.
- Refer to the DVD player's manual for operating instructions.

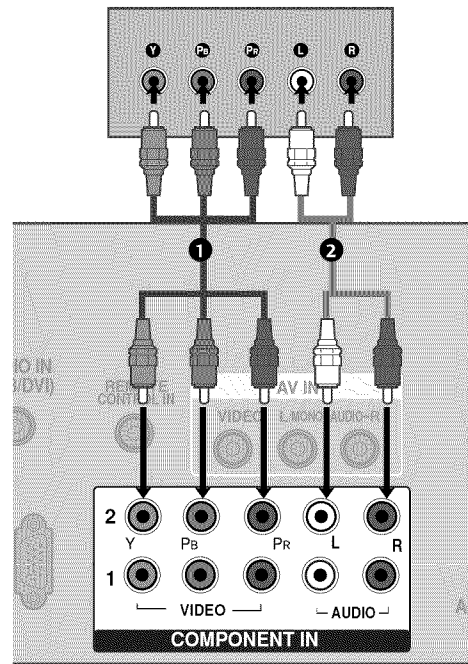

### Component Input ports

To get better picture quality, connect a DVD player to the component input ports as shown below.

Component ports on the TV	Y	P <sub>B</sub>	P <sub>R</sub>
Video output ports on DVD player	Y	P <sub>B</sub>	P <sub>R</sub>
	Y	B-Y	R-Y
	Y	C <sub>b</sub>	C <sub>r</sub>
	Y	P <sub>b</sub>	P <sub>r</sub>

# EXTERNAL EQUIPMENT SETUP

## HDMI Connection

### 1. How to connect

- 1 Connect the HDMI output of the DVD to the HDMI/DVI IN 1, 2, or HDMI IN 3 jack on the TV.
- 2 No separate audio connection is necessary. HDMI supports both audio and video.

### 2. How to use

- Select the HDMI1, 2, or 3 input source on the TV using the INPUT button on the remote control.
- Refer to the DVD player's manual for operating instructions.

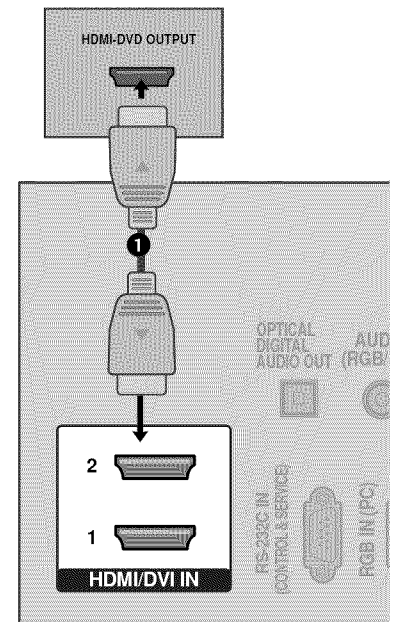



# VCR SETUP

## Antenna Connection

### 1. How to connect

- 1 Connect the RF antenna out socket of the VCR to the **ANTENNA/CABLE IN** socket on the TV.
- 2 Connect the antenna cable to the RF antenna in socket of the VCR.

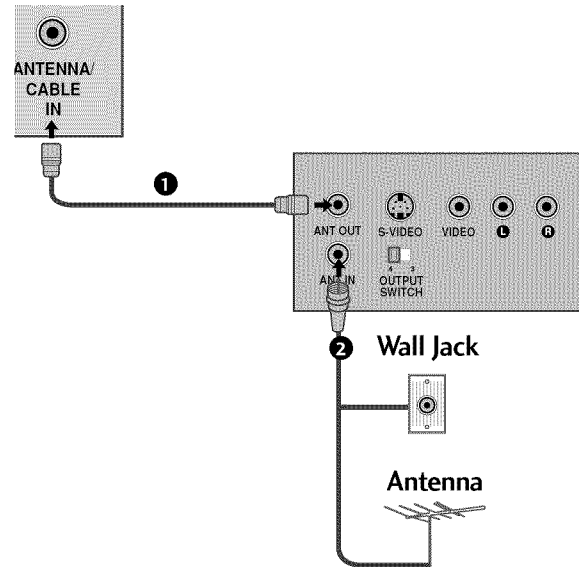

### 2. How to use

- Set VCR output switch to 3 or 4 and then tune TV to the same channel number.
- Insert a video tape into the VCR and press PLAY on the VCR. (Refer to the VCR owner's manual.)

## Composite (RCA) Connection

### 1. How to connect

- 1 Connect the **AUDIO/VIDEO** jacks between TV and VCR. Match the jack colors (Video = yellow, Audio Left = white, and Audio Right = red)

### 2. How to use

- Insert a video tape into the VCR and press PLAY on the VCR. (Refer to the VCR owner's manual.)
- Select the **AV 1** input source on the TV using the **INPUT** button on the remote control.
- If connected to **AV IN 2**, select **AV 2** input source on the TV.

#### NOTE

- ▶ If you have a mono VCR, connect the audio cable from the VCR to the **AUDIO L/MONO** jack of the TV.

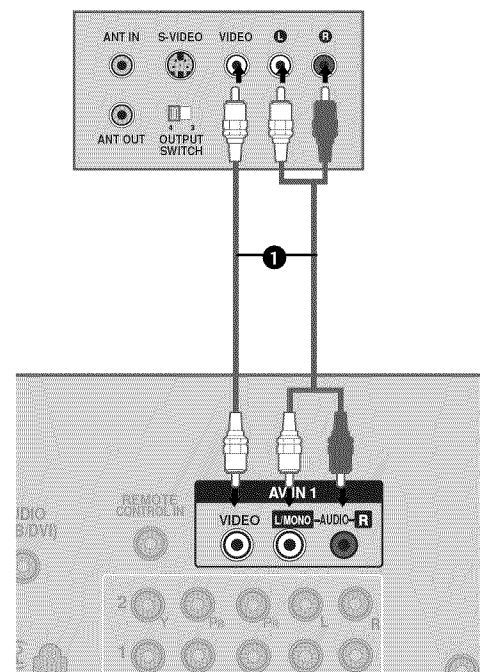

# EXTERNAL EQUIPMENT SETUP

## OTHER A/V SOURCE SETUP

### 1. How to connect

- 1 Connect the AUDIO/VIDEO jacks between TV and external equipment. Match the jack colors. (Video = yellow, Audio Left = white, and Audio Right = red)

### 2. How to use

- Select the AV2 input source on the TV using the INPUT button on the remote control.
- If connected to AV IN 1 input, select the AV1 input source on the TV.
- Operate the corresponding external equipment.

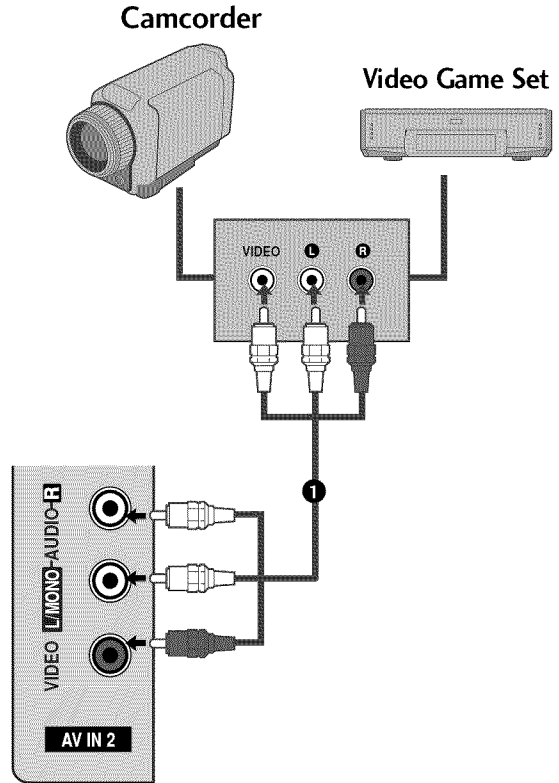

## USB CONNECTION - For 42/50PT350, 42/50PT350C, 50/60PV450, 50/60PV450C, 42/50PT250U, 50/60PV550U

### 1. How to connect

- 1 Connect the USB device to the USB IN jack on the side of TV.

### 2. How to use

- After connecting the USB IN jack, you use the USB function. (▶ p.52)

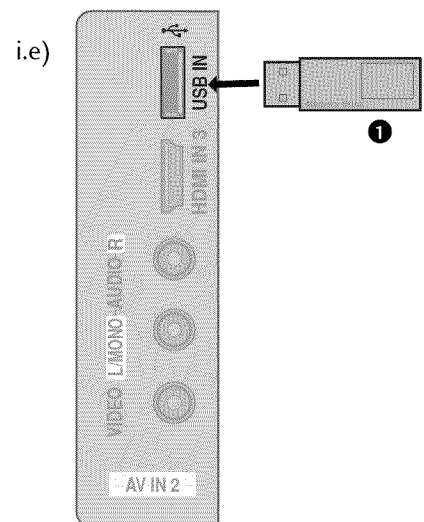

# AUDIO OUT CONNECTION

Send the TV's audio to external audio equipment via the Audio Output port.

## 1. How to connect

- 1 Connect one end of the optical cable to the TV's **OPTICAL** port of **DIGITAL AUDIO OUT**.
- 2 Connect the other end of the optical cable to the digital audio input on the audio equipment.
- 3 Set the "TV Speaker option - Off" in the **AUDIO** menu. (▶ p.88)  
See the external audio equipment instruction manual for operation.

### NOTE

- ▶ When connecting with external audio equipment, such as amplifiers or speakers, you can turn the TV speakers off in the menu. (▶ p.88)

### CAUTION

- ▶ Do not look into the optical output port. Looking at the laser beam may damage your vision.
- ▶ Audio with ACP (Audio Copy Protection) function may block digital audio output.

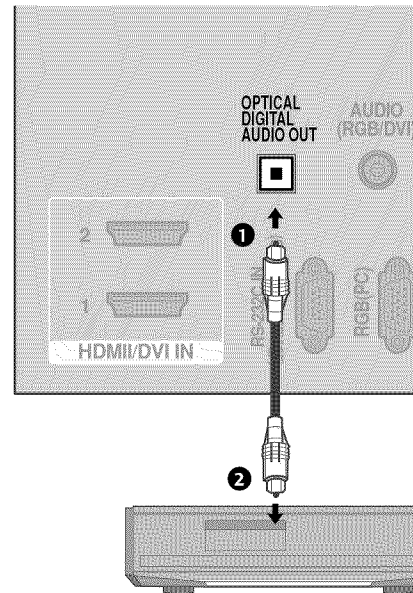

# EXTERNAL EQUIPMENT SETUP

## PC SETUP

### VGA (D-Sub 15 pin) Connection

#### 1. How to connect

- 1 Connect the VGA output of the PC to the **RGB IN (PC)** jack on the TV.
- 2 Connect the PC audio output to the **AUDIO IN (RGB/DVI)** jack on the TV.

#### 2. How to use

- Turn on the PC and the TV.
- Select the RGB-PC input source on the TV using the **INPUT** button on the remote control.

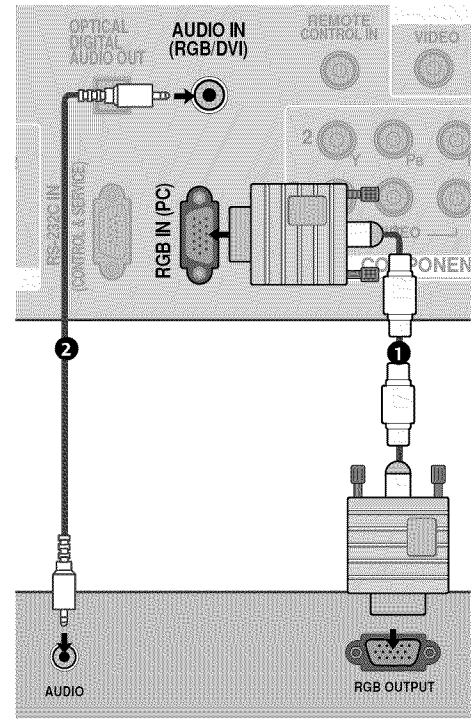

### DVI to HDMI Connection

#### 1. How to connect

- 1 Connect the DVI output of the PC to the **HDMI/DVI IN 1 or 2** jack on the TV.
- 2 Connect the PC audio output to the **AUDIO IN (RGB/DVI)** jack on the TV.

#### 2. How to use

- Turn on the PC and the TV.
- Select the **HDMI1** or **2** input source on the TV using the **INPUT** button on the remote control.

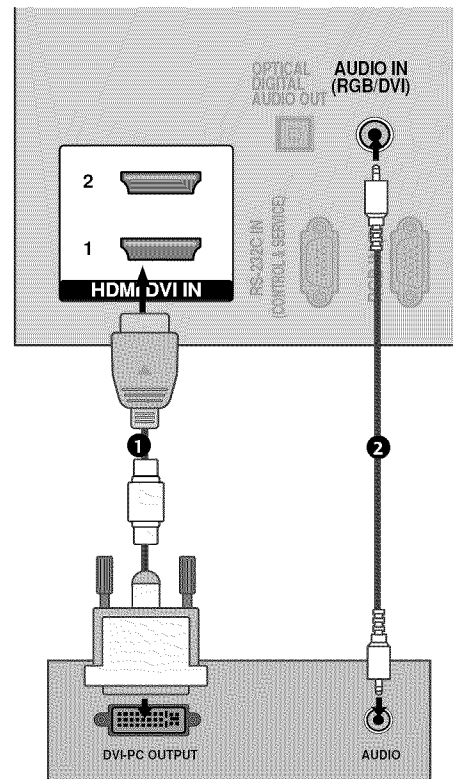

**NOTE**

- ▶ Depending on the graphics card, DOS mode may not work if a HDMI to DVI Cable is in use.
- ▶ In PC mode, there may be noise associated with the resolution, vertical pattern, contrast or brightness. If noise is present, change the PC output to another resolution, change the refresh rate to another rate or adjust the brightness and contrast on the PICTURE menu until the picture is clear.
- ▶ Avoid keeping a fixed image on the screen for a long period of time. The fixed image could become permanently imprinted on the screen.
- ▶ The synchronization input form for Horizontal and Vertical frequencies is separate.
- ▶ Depending on the graphics card, some resolution settings may not allow the image to be positioned on the screen properly.

## Supported Display Specifications (RGB-PC, HDMI-PC)

Resolution	Horizontal Frequency(KHz)	Vertical Frequency(Hz)
640x350	31.468	70.09
720x400	31.469	70.08
640x480	31.469	59.94
800x600	35.156	56.25
	37.879	60.31
1024x768	48.363	60.00
1280x768	47.776	59.87
1360x768	47.712	60.015
1280x1024	63.981	60.020
1600x1200	74.537	59.869
1920x1080	66.587	59.934

For 50/60PV400,  
50/60PV430, 50/60PV450,  
50/60PV450C, 50/60PV550U







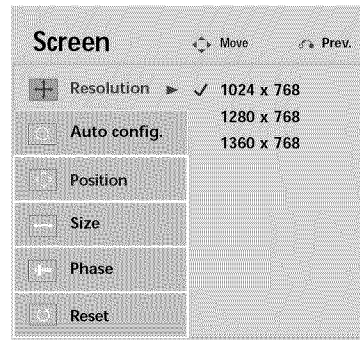
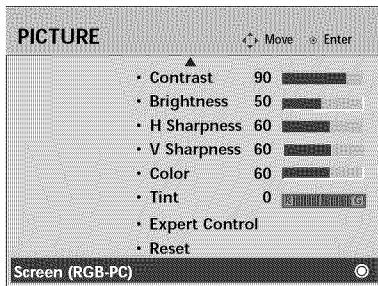

# EXTERNAL EQUIPMENT SETUP

## Screen Setup for PC mode

### Selecting Resolution

You can choose the resolution in RGB-PC mode.  
The **Position**, **Phase**, and **Size** can also be adjusted.









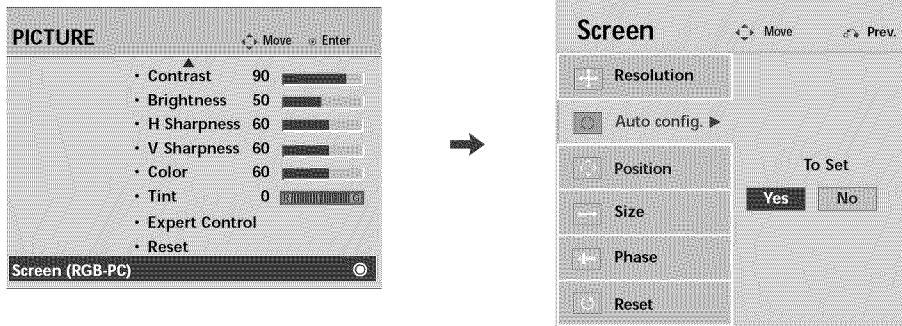

-   Select **PICTURE**.
-   Select **Screen (RGB-PC)**.
-   Select **Resolution**.
-   Select the desired resolution.
- 

## Auto Configure

Automatically adjusts picture position and minimizes image instability. After adjustment, if the image is still not correct, try using the manual settings or a different resolution or refresh rate on the PC.



- 1   Select **PICTURE**.
- 2   Select **Screen (RGB-PC)**.
- 3   Select **Auto config.**
- 4   Select **Yes**.
- 5  Start Auto Configuration.

- If the position of the image is still not correct, try Auto adjustment again.
- If picture needs to be adjusted again after Auto adjustment in RGB-PC, you can adjust the **Position**, **Size**, or **Phase**.



# EXTERNAL EQUIPMENT SETUP

## Adjustment for screen Position, Size, and Phase

If the picture is not clear after auto adjustment and especially if characters are still trembling, adjust the picture phase manually.

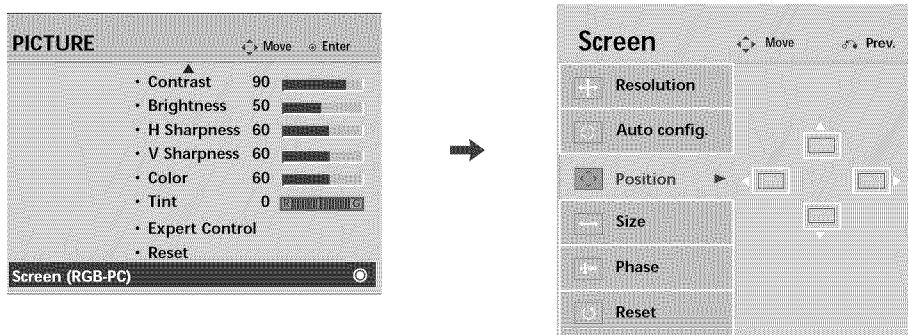
This feature operates only in RGB-PC mode.

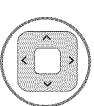
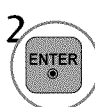
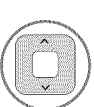
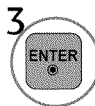
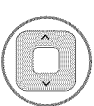

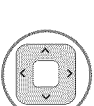
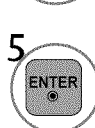
-   Select **PICTURE**.
-   Select **Screen (RGB-PC)**.
-   Select **Position, Size, or Phase**.
-   Make appropriate adjustments.
- 







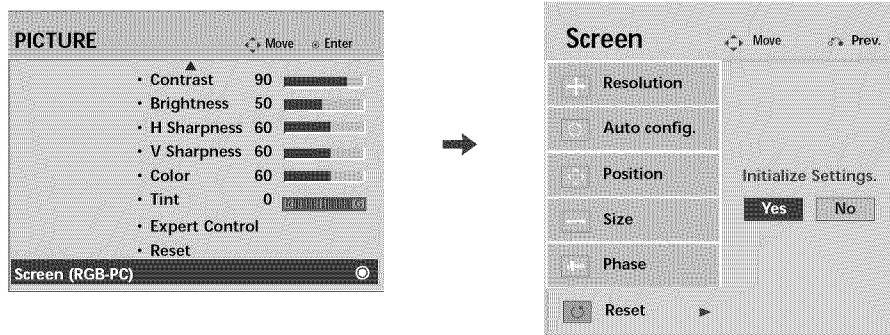

- **Position:** This function is to adjust picture to left/right and up/down as you prefer.
- **Size:** This function is to minimize any vertical bars or stripes visible on the screen background. And the horizontal screen size will also change.
- **Phase:** This function allows you to remove any horizontal noise and clear or sharpen the image of characters.



## Screen Reset (Reset to original factory values)

Returns **Position**, **Size**, and **Phase** to the default factory settings.  
This feature operates only in RGB-PC mode.



- 1   Select PICTURE.
- 2   Select Screen (RGB-PC).
- 3   Select Reset.
- 4   Select Yes.
- 5 

# WATCHING TV / CHANNEL CONTROL

## REMOTE CONTROL FUNCTIONS

When using the remote control, aim it at the remote control sensor on the TV.  
The remote control may differ from the images below.

**POWER** Turns the TV on from standby or off to standby.

**LIGHT** Illuminates the remote control buttons.  
(Depending on Model)

**ENERGY SAVING** Adjusts the Energy Saving.

**AV MODE** Toggles through preset Video and Audio modes. ▶ p.49

**INPUT** Rotates through inputs.  
Also switches the TV on from standby. ▶ p.47

**TV** Select the remote operating mode: TV

**NUMBER button**

**— (DASH)** Used to enter a program number for multiple program channels such as 2-1, 2-2, etc.

**LIST** Displays the channel list.

**FLASHBK** Tunes to the last channel viewed.

**Color button** Access special functions in some menus.

**USB, SIMPLINK Control buttons** ◦ Controls USB (List photo, List music, List movie) menu.  
◦ Controls the SIMPLINK compatible devices.

**FREEZE** Freezes the current frame.

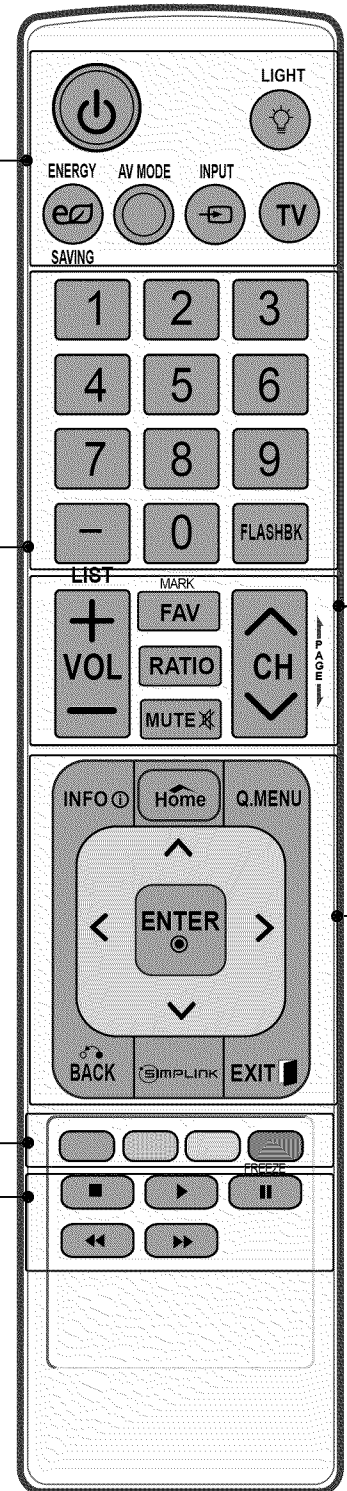

**VOLUME UP /DOWN** Adjusts the volume.

**FAV/MARK** Scroll through the programmed Favorite channels. ► p.45  
Select the input to apply the Picture Wizard setting.  
Use to mark or unmark a photo/music/movie.

**RATIO** Changes the aspect ratio.

**MUTE** Switches the sound on or off. ► p.36

**CHANNEL UP/DOWN** Changes the channel.

**PAGE UP/DOWN** Moves from one full set of screen information to the next one.

**INFO** Displays channel information at the top of the screen.

**Home** Displays the main menu or clears all on-screen displays and returns to TV viewing.

**Q.MENU** Opens the list of Quick Menu options.

**THUMBSTICK** Navigates the on-screen menus and adjusts the system settings to your preference.  
(Up/Down/Left Right/ENTER)

**BACK** Allows the user to move return one step in an interactive application or other user interaction function.

**SIMPLINK** Accesses the AV devices connected to the TV; Opens the SIMPLINK menu.

**EXIT** Clears all on-screen displays and return to TV viewing from any menu.

## Installing Batteries

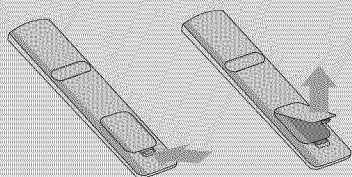

- Open the battery compartment cover on the back side and install the batteries matching correct polarity.
- Install two 1.5V AAA batteries. Don't mix old or used batteries with new ones.
- Close cover.

# WATCHING TV / CHANNEL CONTROL

## TURNING ON TV

---

- 1** First, connect power cord correctly.  
At this moment, TV is in standby mode.
  - In standby mode to turn TV on, press the  $\phi/I$ , **INPUT, CH** ( ^ or v ) button on the TV or press the **POWER, INPUT, CH** ( ^ or v ), **Number (0~9)** button on the remote control.

---
- 2** Select the viewing source by using the **INPUT** button on the remote control.

---
- 3** When finished using the TV, press the **POWER** button on the remote control. The TV reverts to standby mode.

---

### **NOTE**

- ▶ If you intend to be away on vacation, disconnect the power plug from the wall power outlet.

## CHANNEL SELECTION

---

- 1** Press the **CH** ( ^ or v ) or **NUMBER** buttons to select a channel number.

---

## VOLUME ADJUSTMENT

Adjust the volume to suit your personal preference.

---

- 1** Press the **VOL** (+ or -) button to adjust the volume.

---
- 2** If you want to switch the sound off, press the **MUTE** button.

---
- 3** You can cancel the Mute function by pressing the **MUTE** or **VOL** (+ or -) button.

---

# INITIAL SETTING

This Function guides the user to easily set the essential items for viewing the TV for the first time when purchasing the TV. It will be displayed on the screen when turning the TV on for the first time. It can also be activated from the user menus.

- Default selection is “Home Use”. We recommend setting the TV to “Home Use” mode for the best picture in your home environment.
- “Store Demo” Mode is only intended for use in retail environments. Customers can adjust the “Picture menu - Picture mode” manually while inspecting the TV, but the TV will automatically return to preset in-store mode after 5 minutes.
- You can also adjust Initial Setting in the OPTION menu. Factory defaults are set when you choose “Home Use”.
- If you do not complete the Initial setting, it will appear whenever the TV is switched on until the Initial setting procedure is completed.

## Step1. Welcome

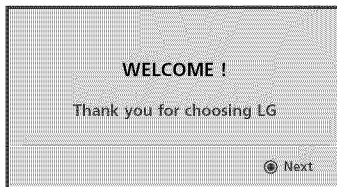

## Step2. Language Selecting

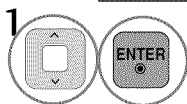

Select menu Language.

## Step3. Mode setting

Except  
42/50PT250U,  
50/60PV550U

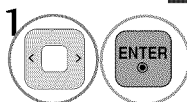

Select Home Use mode.

## Step4. Time setting

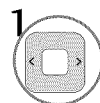
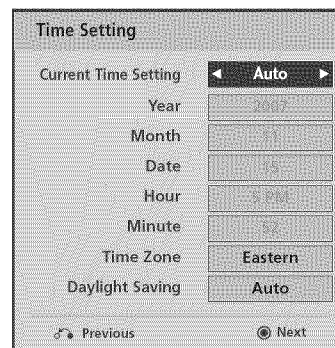

Select Auto or Manual.

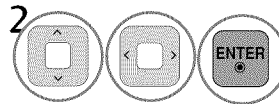

Select desired time option.

## Step5. Auto Tuning

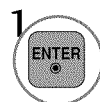
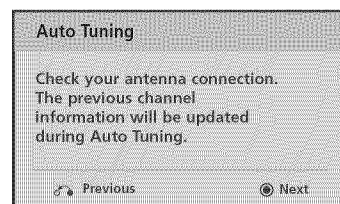

Start Auto Tuning.

# WATCHING TV / CHANNEL CONTROL

## ON-SCREEN MENUS SELECTION

Your TV's OSD (On Screen Display) may differ slightly from that shown in this manual.

Except 42/50PT250U, 50/60PV550U

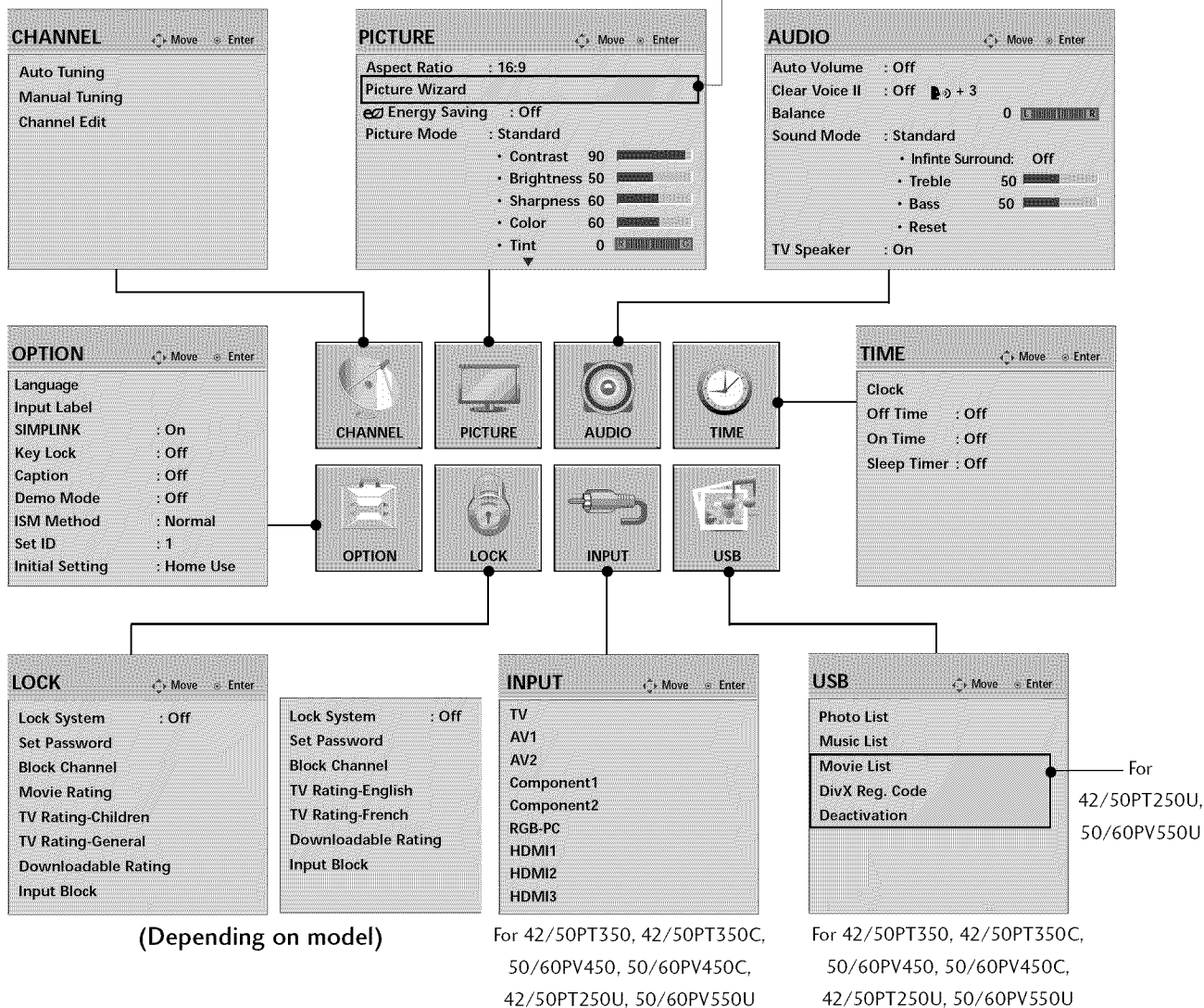

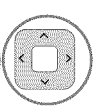
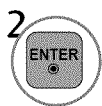
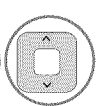
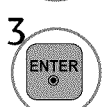
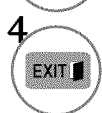
- 1   Display each menu.
- 2   Select a menu item.
- 3  Accept the current selection.
- 4  Return to TV viewing.

## QUICK MENU

Your TV's OSD (On Screen Display) may differ slightly from what is shown in this manual.

Q.Menu (Quick Menu) is a menu of features which users might use frequently.

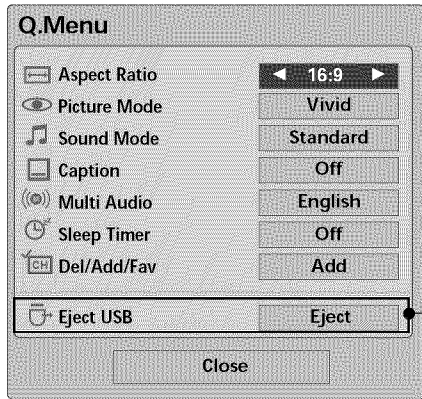

For 42/50PT350, 42/50PT350C,  
50/60PV450, 50/60PV450C,  
42/50PT250U, 50/60PV550U

- ☰ **Aspect Ratio:** Selects your desired picture format.
- 👁️ **Picture Mode:** Selects the factory preset picture depend on the viewing environment.
- 🎵 **Sound Mode:** Selects the factory preset sound for type of program.
- ☑️ **Caption:** Select on or off.
- 🗣️ **Multi Audio:** Changes the audio language (Digital signal).
- 🗣️ **SAP:** Selects MTS sound (Analog signal).
- 🕒 **Sleep Timer:** Select the amount of time before your TV turns off automatically.
- 📺 **Del/Add/Fav:** Select channel you want to add/delete or add the channel to the Favorite List.
- 🗑️ **Eject USB:** Select "Eject" in order to eject a USB device.

1   Display each menu.

2  Make appropriate adjustments.

3  Return to TV viewing.

# WATCHING TV / CHANNEL CONTROL

## CHANNEL SETUP





### Auto Scan (Auto Tuning)

Automatically finds all channels available through antenna or cable inputs, and stores them in memory on the channel list.

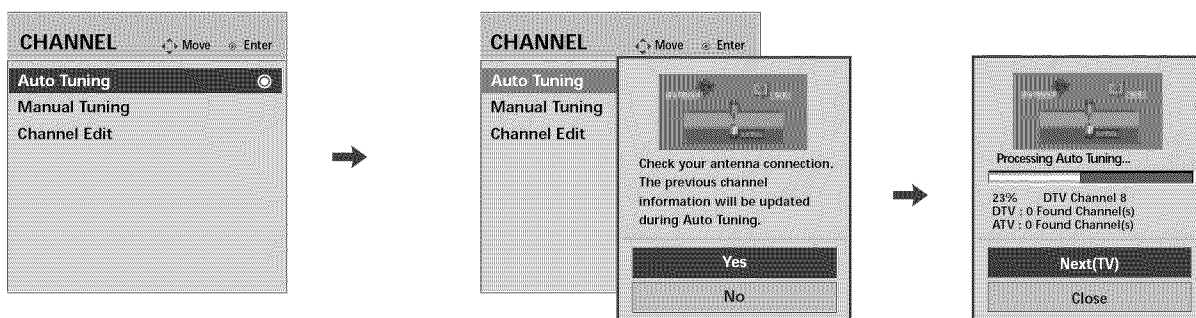
Run this function if you change your residence or move the TV. Also, make sure to run this function with the antenna connected during TV broadcasting hours.

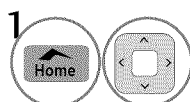
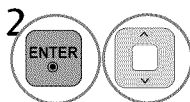
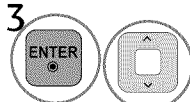
Auto Tuning memorizes only the channels available at the time.

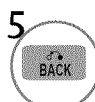

-  Select **CHANNEL**.
-  Select **Auto Tuning**.
-  Select **Yes**.
-  Run **Auto Tuning**.
-  Return to the previous menu.
-  Return to TV viewing.

- The TV will ask for a password if parental control has been activated (LOCK Menu).  
Use the password you set up in the LOCK Menu to allow a channel search.
- When setting the Auto tuning or Manual tuning, the number of maximum channel you can store is 900.  
It is subject to change depending on the broadcasting signal environment.
- Memorizes all the available channels in the order of DTV, TV, CADTV, and CATV.



## Add/Delete Channel (Manual Tuning)

If you select DTV or CADTV input signal, you can view the on-screen signal strength monitor to see the quality of the signal being received.

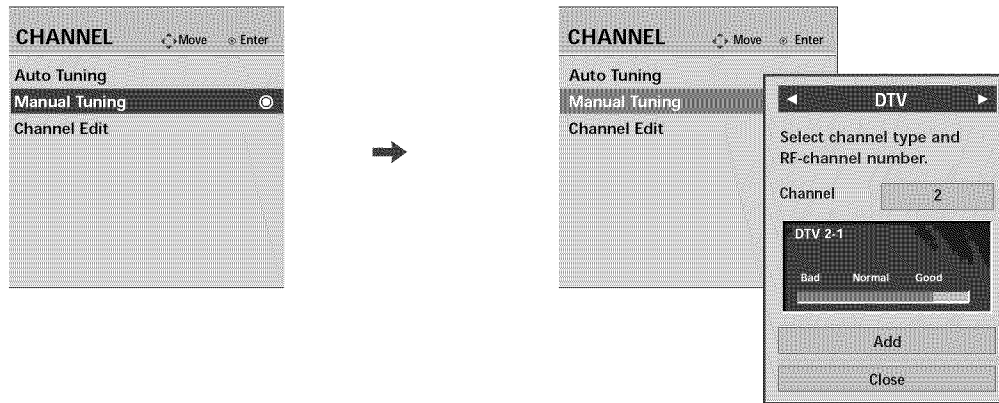

- 1   Select **CHANNEL**.
  - 2   Select **Manual Tuning**.
  - 3   Select **DTV, TV, CADTV, or CATV**.
  - 4   Select channel you want to add or delete.
  - 5   Select **Add** or **Delete**.
  - 6  Return to the previous menu.
-  Return to TV viewing.

- The TV will ask for a password if parental control has been activated (LOCK Menu).  
Use the password you set up in the LOCK Menu to allow a channel search.
- When setting the Auto tuning or Manual tuning, the number of maximum channel you can store is 900.  
It is subject to change depending on the broadcasting signal environment.







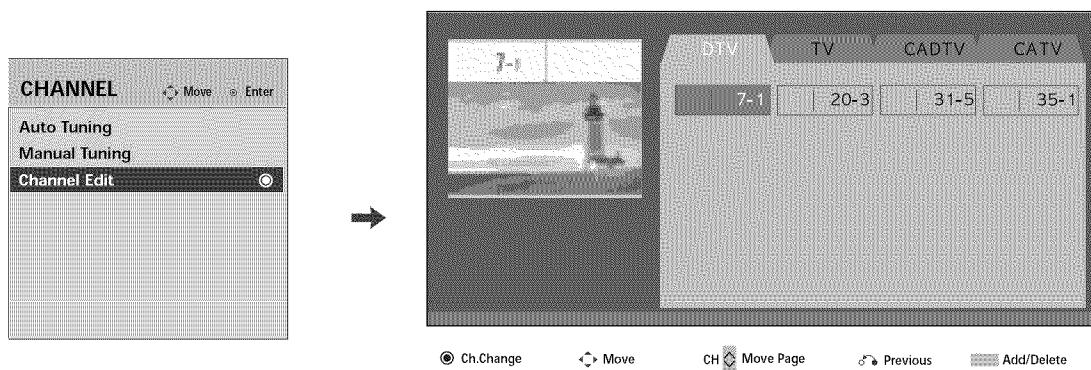

# WATCHING TV / CHANNEL CONTROL

## Channel Editing

When a channel number is deleted, it means that you will be unable to select it using CH ^, v button during TV viewing.

If you wish to select the deleted channel, directly enter the channel number with the NUMBER buttons or select it in the Channel Edit menu.



-   Select **CHANNEL**.
-   Select **Channel Edit**.
-   Select a channel.
-  Add or delete the channel.
-  Return to the previous menu.
-  Return to TV viewing.

- Keep pressing the ^ button and use the < or > buttons to move between DTV, TV, CADTV and CATV.
- If the channel list is too long, use the CH ^ or v button to move between pages.

# CHANNEL LIST

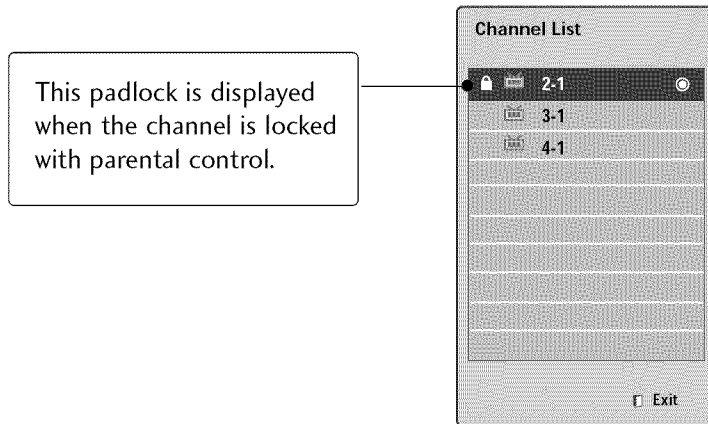

You can check channels which are stored in the memory by displaying the channel list.





## Displaying Channel List

- 1  Display the Channel List.

## Selecting a channel in the channel list

- 1  Select a channel.
- 2  Switch to the chosen channel number.

## Paging through a channel list

- 1  Turn the pages.
- 2  Return to TV viewing.





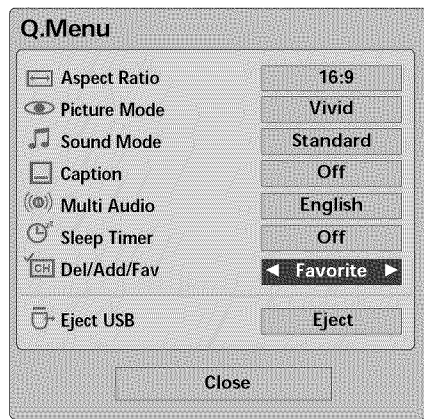

# WATCHING TV / CHANNEL CONTROL

## FAVORITE CHANNEL SETUP

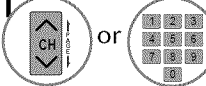
Your TV's OSD (On Screen Display) may differ slightly from what is shown in this manual.

Favorite Channels are a convenient feature that lets you quickly select channels of your choice without waiting for the TV to select through all the in-between channels.



- 1  or  Select your desired channel.
- 2   Select Del/Add/Fav.
- 3  Select Favorite.
- 4  Return to TV viewing.

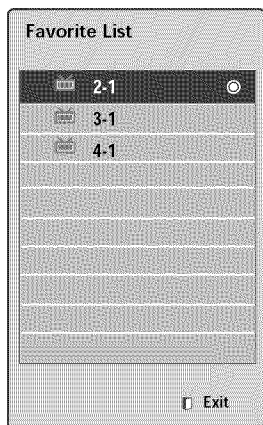

# FAVORITE CHANNEL LIST





## Displaying the favorite channel list

- 1  Display the Favorite channel list.

## Selecting a channel in the favorite channel list

- 1  Select a channel.
- 2  Switch to the chosen channel number.



## Paging through a favorite channel list

- 1  Turn the pages.
- 2  Return to TV viewing.

# WATCHING TV / CHANNEL CONTROL









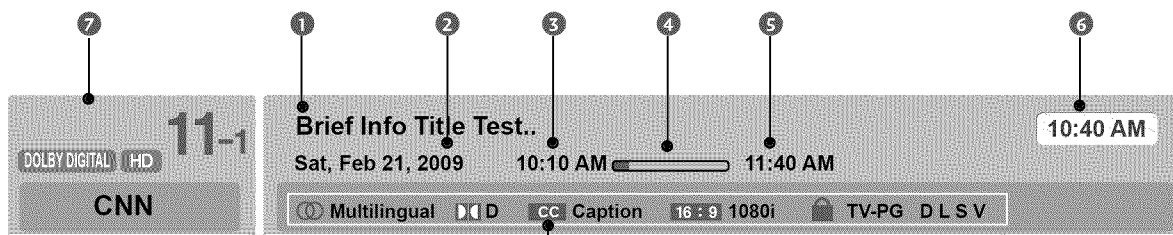

## BRIEF INFORMATION

Brief Info shows the present screen information.

1  or  Show the Brief Info on the screen.

2  Return to TV viewing



	<b>Multilingual</b> : The program contains two or more audio services. Use the Q.MENU menu to select wanted Audio.
	<b>Caption</b> : The program contains one or more caption services. Use the Q.MENU menu to select wanted Closed caption.
	<b>Dolby Digital</b> : The program contains a Dolby Digital audio signal in TV and HDMI input source.
	The original aspect ratio of the video is 4:3
	The original aspect ratio of the video is 16:9 (wide)
	The video resolution is 720x480i
	The video resolution is 720x480p
	The video resolution is 1280x720p
	The video resolution is 1920x1080i
	The video resolution is 1920x1080p
	<b>V-Chip</b> : The program contains V-Chip information. Refer to the LOCK menu: A (Age), D (Dialogue), L (Language), S (Sex), V (Violence), FV (Fantasy Violence)

- 1 Program title
- 2 Day, Month, Year
- 3 Program start time
- 4 Program progress bar
- 5 Program finish time
- 6 Present time
- 7 Banner information

# INPUT LIST

Only these input signals which are connected to a TV can be activated and selected.

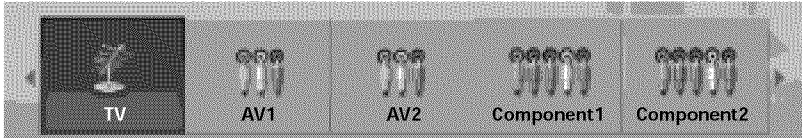

1  Select the desired input source.

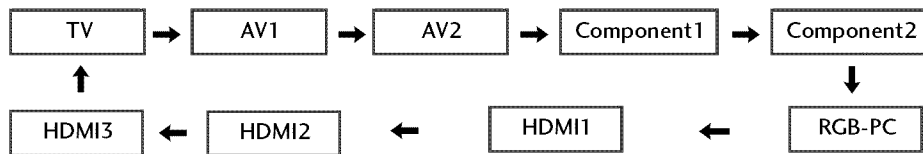

ie)

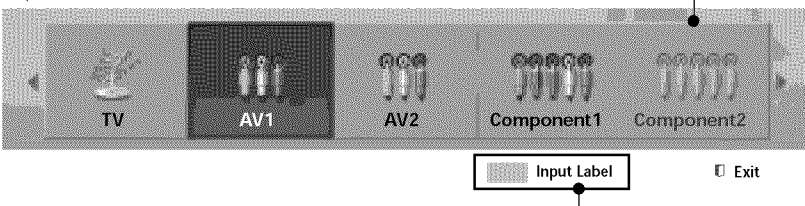

Disconnected inputs are inactive (grayed out)

Select a desired input source (except TV). Then, you can select your desired **Input Label** with using Blue button. ► p.48

ie) In case of changing the input label with using Blue button

- When new external device is connected, this popup menu is displayed automatically. If selecting **Yes**, you can select input source that you want to appreciate.
- But, when selecting “**SIMPLINK - On**”, popup menu for HDMI input will not be displayed.

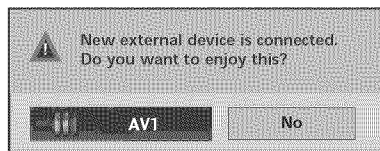

- |   |  |
|---|--|
| <ul style="list-style-type: none"> <li>■ <b>TV</b>: Select it to watch over-the-air, cable and digital cable broadcasts.</li> <li>■ <b>AV</b>: Select them to watch a VCR or other external equipment.</li> <li>■ <b>Component</b>: Select them to watch DVD or a Digital set-top box.</li> </ul> | <ul style="list-style-type: none"> <li>■ <b>RGB-PC</b>: Select it to view PC input.</li> <li>■ <b>HDMI</b>: Select them to watch high definition devices.</li> </ul> |
|---|--|



# WATCHING TV / CHANNEL CONTROL

## INPUT LABEL

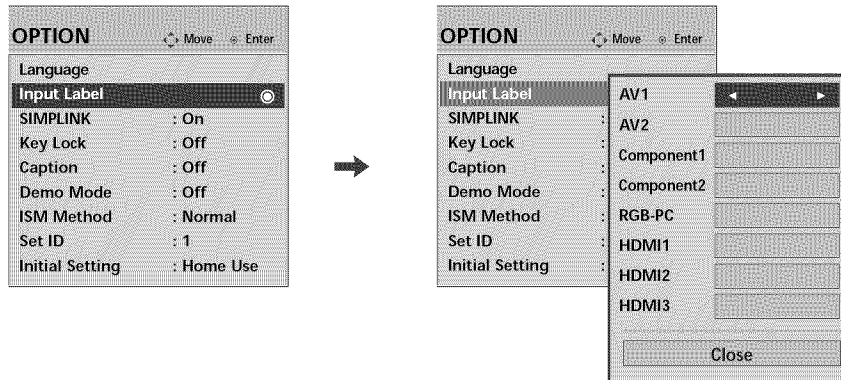
This indicates which device is connected to which input port.

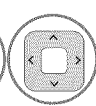
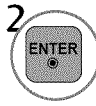
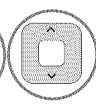
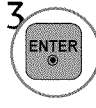
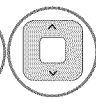
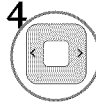

### With using OPTION menu

-   Select **OPTION**.
-   Select **Input Label**.
-   Select the source.
-  Select the label.
-  Return to the previous menu.
-  Return to TV viewing.

### With using INPUT button

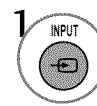
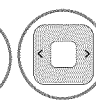
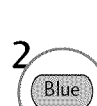
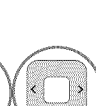
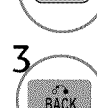
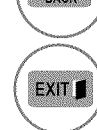
-   Select the source (except TV).
-   Select the label.
-  Return to the previous menu.
-  Return to TV viewing.



# AV MODE

AV Mode toggles through preset Video and Audio settings.

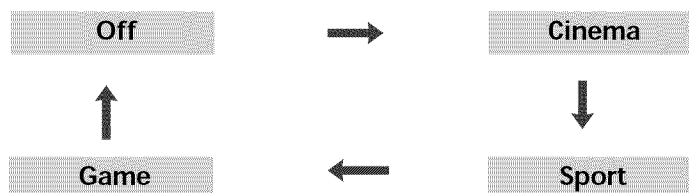

Press the **AV MODE** button repeatedly to select the desired source.

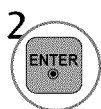

- If you select “**Cinema**” in AV mode, **Cinema** will be selected both for “**PICTURE** menu - Picture Mode” and “**AUDIO** menu - Sound Mode” respectively.
- If you select “**Off**” in AV mode, the “**Picture Mode**” and “**Sound Mode**” return to previous selected value.
- **Off**: Disables the AV MODE.
- **Cinema**: Optimizes video and audio for watching movies.
- **Sport**: Optimizes video and audio for watching sports events.
- **Game**: Optimizes video and audio for playing games.
- When playing a video game using PlayStation or Xbox, it is recommended to use the Game Mode.
- When in Game Mode, functions related to picture quality will be optimized for playing games.







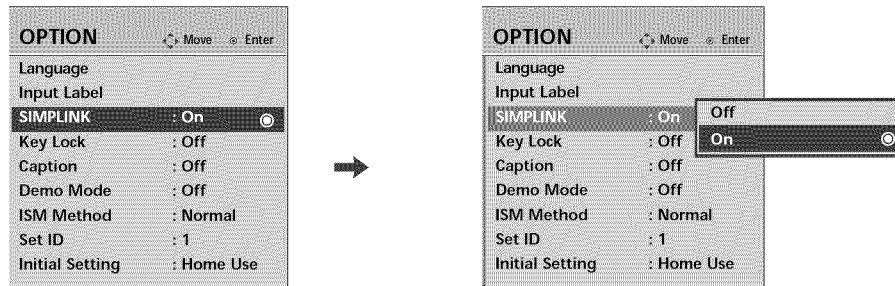

# WATCHING TV / CHANNEL CONTROL



Simplink allows you to control and play other AV devices connected with HDMI cable without additional cables and settings. This TV may work with devices with HDMI-CEC support, but only devices with the SIMPLINK logo are fully supported.

SIMPLINK can be turned on and off in the user menus.



-   Select **OPTION**.
-   Select **SIMPLINK**.
-   Select **On** or **Off**.
-  Return to the previous menu.
-  Return to TV viewing.

## NOTE

- ▶ Connect the HDMI/DVI IN or HDMI IN terminal of the TV to the rear terminal (HDMI terminal) of the SIMPLINK device with the HDMI cable.
- ▶ When you switch the Input source with the INPUT button on the remote control, the SIMPLINK device will stop.
- ▶ When you select a device with home theater functionality, the sound output automatically switches to the home theater speakers and the TV speakers are turned off.
- ▶ If a connected SIMPLINK home theater system doesn't play the audio from the TV, connect the DIGITAL AUDIO OUT terminal on the back of the TV to the DIGITAL AUDIO IN terminal on the back of the SIMPLINK device with an OPTICAL cable.

## SIMPLINK Functions

- **Direct Play:** After connecting AV devices to the TV, you can directly control the devices and play media without additional settings.
- **Select AV device:** Enables you to select one of the AV devices connected to TV.
- **Disc playback:** Control connected AV devices by pressing the  $\wedge$   $\vee$   $\lt$   $\gt$ , ENTER,  $\blacktriangleright$ ,  $\blacksquare$ ,  $\text{II}$ ,  $\blacktriangleleft$  and  $\blacktriangleright$  buttons.
- **Power off all devices:** When you power off the TV, all connected devices are turned off.
- **Switch audio-out:** Offers an easy way to switch audio-out.
- **Sync Power on:** When the equipment with Simplink function connected HDMI terminal starts to play, The TV will change automatically to turn on mode.

(A device, which is connected to the TV through a HDMI cable but does not support SIMPLINK, does not provide this function)

Note: To operate SIMPLINK, High Speed HDMI cable with \*CEC function should be used. (\*CEC: Consumer Electronics Control)

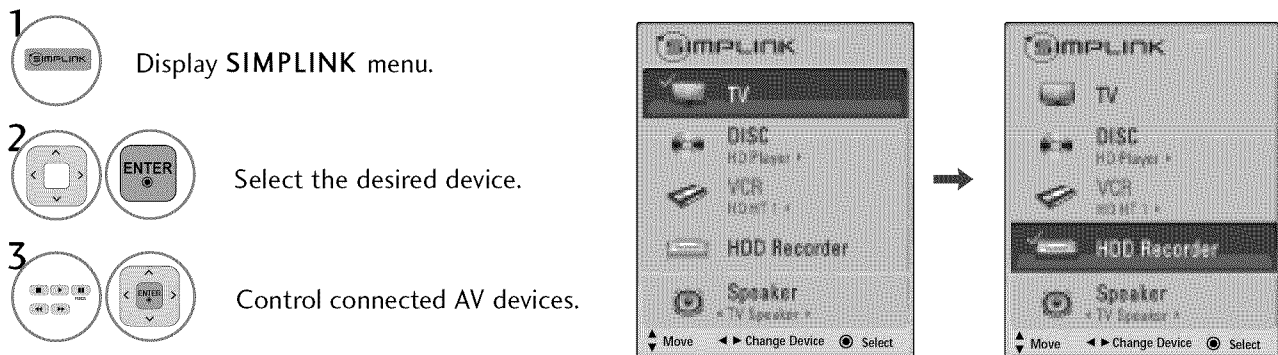

## SIMPLINK Menu

- 1 **TV viewing:** Switch to the previous TV channel regardless of the current mode.
- 2 **DISC playback:** Select and play discs. When multiple discs are available, the titles of discs are conveniently displayed at the bottom of the screen.
- 3 **VCR playback:** Control the connected VCR.
- 4 **HDD Recordings playback:** Control recordings stored in HDD.
- 5 **Audio Out to Home Theater speaker/Audio Out to TV:** Select Home Theater speaker or TV speaker for Audio Out.

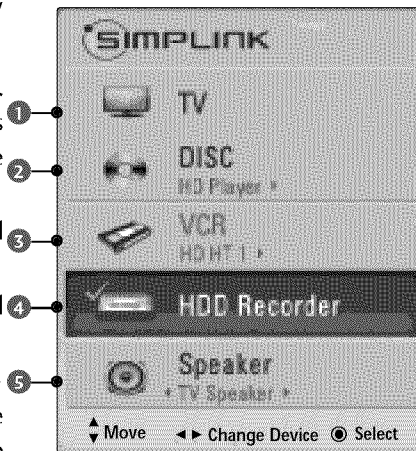

- ▶ When no device is connected (displayed in gray)
- ▶ Selected Device
- ▶ When a device is connected (displayed in bright color)

## ENTRY MODES

When you connect a USB device, this screen is displayed automatically.

In USB device, you can not add a new folder or delete the existing folder.

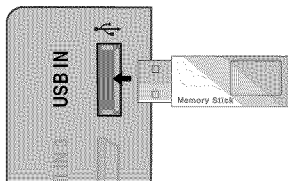

**1** Connect the USB device to the **USB IN** jacks on the side of TV.

- It doesn't support USB HDD.
- This TV supports JPG and MP3 files.



### When removing the USB device

Select the **Eject USB** menu before removing the USB device.

- 1**   Select Eject USB.      **2**  Select Eject.

**2**  Select **Photo List**, **Music List**, or **Movie List**.  
(Movie List: For 42/50PT250U, 50/60PV550U)

**3** 

### Precautions when using the USB device

- ▶ Only a USB storage device is recognizable.
- ▶ If the USB storage device is connected through a USB hub, the device is not recognizable.
- ▶ A USB storage device using an automatic recognition program may not be recognized.
- ▶ A USB storage device which uses its own driver may not be recognized.
- ▶ In case of a card reader, up to four memory cards are concurrently recognizable but the device may not operate normally.
- ▶ The recognition speed of a USB storage device may depend on each device.
- ▶ Please do not turn off the TV or unplug the USB device when the connected USB storage device is working. When such device is suddenly separated or unplugged, the stored files or the USB storage device may be damaged.
- ▶ Only use a USB storage device which has normal music files or image files.
- ▶ Please use only a USB storage device which was formatted as a FAT16, FAT32 or NTFS file system provided with the Windows operating system. In case of a storage device formatted as a different utility program which is not supported by Windows, it may not be recognized.
- ▶ Please connect power to a USB storage device which requires an external power supply. If not, the device may not be recognized.
- ▶ Please connect a USB storage device with cable is offered by USB maker. If connected with cable is not offered by USB maker or an excessively long cable, the device may not be recognized.
- ▶ Some USB storage devices may not be supported or operate properly.
- ▶ The TV will display up to 128 characters of a files name.
- ▶ Please backup important files because data on USB device may be damaged. Data management is consumer's responsibility and as a result, the manufacturer does not cover data damage.
- ▶ The recommended capacity is 1TB or less for a USB external hard disk and 32GB or less for USB memory.
- ▶ Any device with more than the recommended capacity may not work properly.

# PHOTO LIST

You can view (\*.JPG) files from USB storage devices.  
The On Screen Display on your model may be slightly different.

**Supported photo file: \*.JPG**

- You can play JPG files only.
- Only baseline scan is supported among JPG.

USB

## Screen Components

**1**

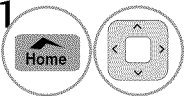

Select USB.

**2**

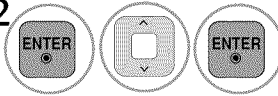

Select Photo List.

① Moves to upper level folder.

② Preview: Display the thumbnail/folder name of the photo in the selected folder.

③ Current page/Total pages.

④ Total number of marked photo files.

⑤ Usable USB memory.

⑥ Corresponding buttons on the remote control.

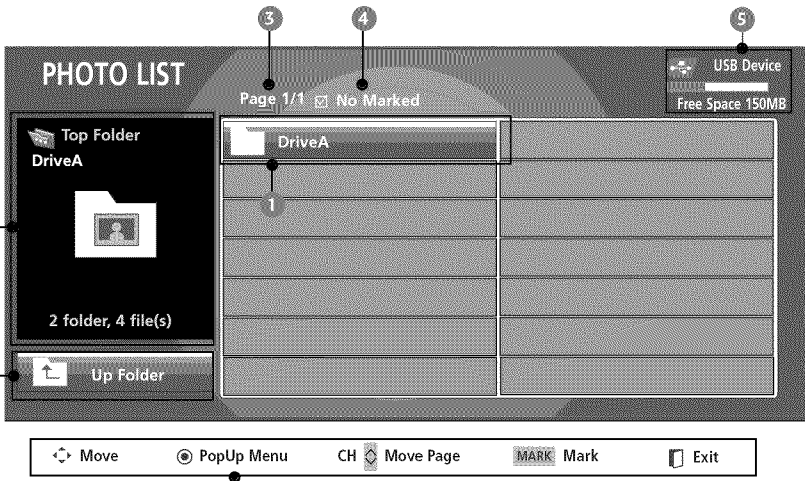





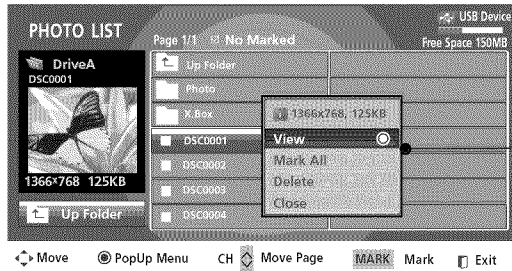
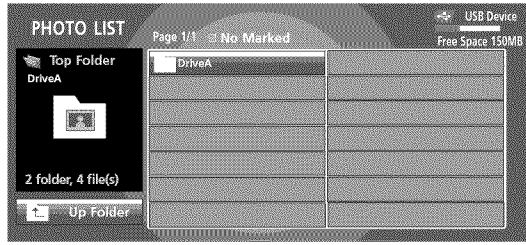

The screenshot shows a 'PHOTO LIST' interface. At the top, it says 'Page 1/1' and 'No Marked'. On the right, it shows 'USB Device' and 'Free Space 150MB'. The main area is divided into a left preview pane and a right list pane. The preview pane shows a folder icon for 'DriveA' with a sub-label '2 folder, 4 file(s)' and an 'Up Folder' button. The list pane shows a table with columns for folder names and file counts. At the bottom, a remote control interface is shown with buttons for 'Move', 'PopUp Menu', 'CH', 'Move Page', 'MARK Mark', and 'Exit'.

## Photo Selection and Popup Menu



When you select a file (not folder), this Popup menu is displayed.

- ▶ **View:** Display the selected item.
- ▶ **Mark All:** Mark all photo files on the screen.
- ▶ **Unmark All:** Deselect all marked photo files.
- ▶ **Delete:** Delete the selected photo item.
- ▶ **Close:** Close the popup menu.

- 1  Select the target folder or drive.
- 2   Select the desired photo files.
- 3  Show the Popup menu.
- 4   Select the desired Popup menu.





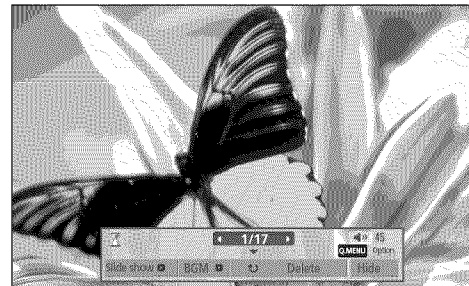
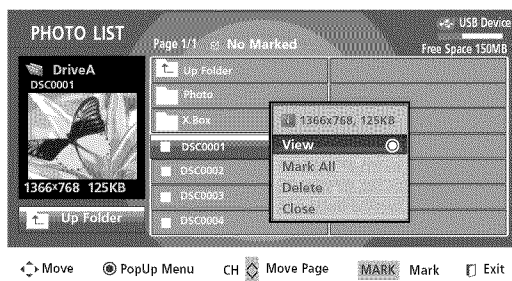
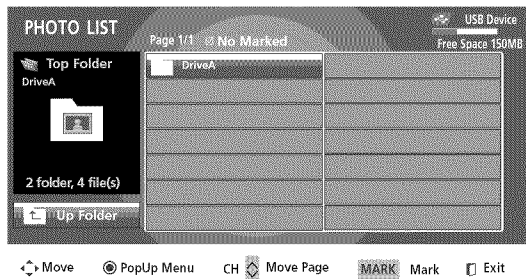

- Use the CH ^ v button to navigation in the photo page.
- Use the MARK button to mark or unmark a photo. When one or more photos are marked, you can view individual photos or a slide show of the marked photos. If no photos are marked, you can view all photos individually or all photos in the folder in a slide show.

## Full Screen Menu

You can change the Photo List view so that it fills the screen. More operations are available in full screen mode.



The aspect ratio of a photo may change the size of the photo displayed on the screen in full size.

-  Select the target folder or drive.
-   Select the desired photo files.
-  Show the PopUp menu.
-  Select View.
-  The selected photo is displayed in full size.

Use the CH   button to navigation in the photo page.

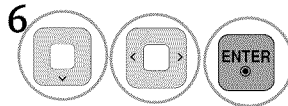
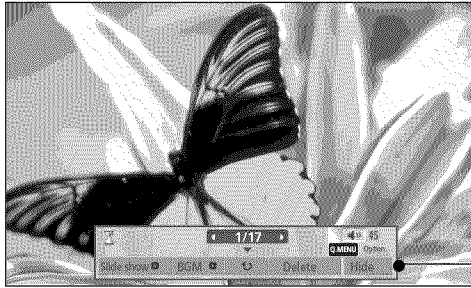

6 Select the **Slide show**, **BGM**, **Rotate**, **Delete**, or **Hide**.

- Use < > button to select the previous or next photo.
- Use ^ v < > button to select and control the menu on the full-sized screen.

- ▶ **Slide show:** Selected photos are displayed during the slide show. If no photo is selected, all photos in the current folder are displayed during slide show.
  - Set the time interval of the slide show in **Option**.
- ▶ **BGM:** Listen to music while viewing photos in full size.
  - Set the BGM device and album in **Option**.
- ▶ **Rotate:** Rotate photos.
  - Rotates the photo 90°, 180°, 270°, 360° clockwise.
- ▶ **Delete:** Delete photos.
- ▶ **Hide:** Hide the menu on the full-sized screen.
  - To see the menu again on the full-sized screen, press **ENTER** button to display.

## NOTE

- ▶ This TV will not be able to decode most JPEG images saved using the Progressive option.



## Using the Photo List Option

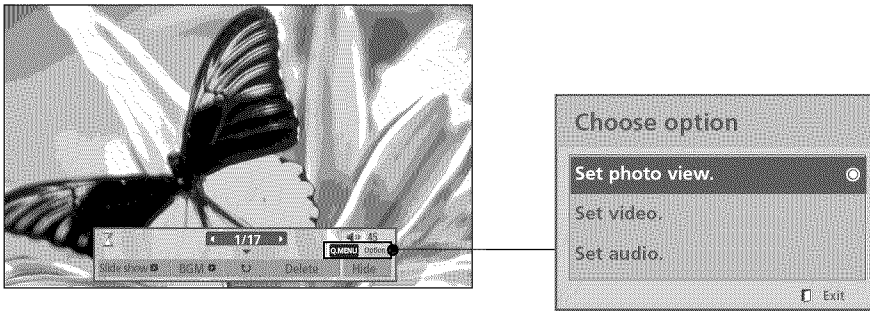

1  Show the Popup menu.

2  Select **Set Photo View**, **Set Video**, or **Set Audio**.

► When you select the **Set Photo View**.

■ You cannot change **Music Folder** while BGM is playing.

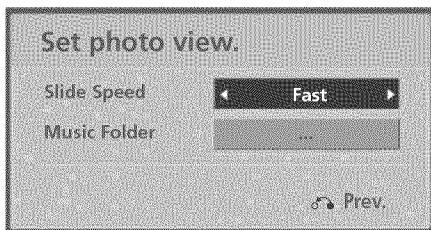

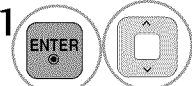

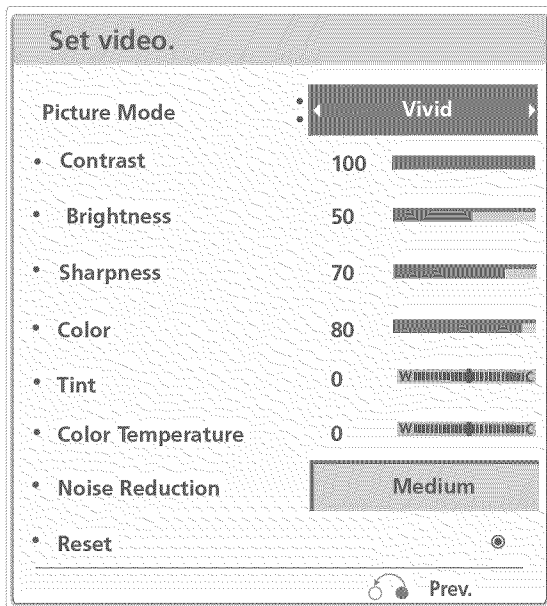

1  Show the **Slide Speed** or **Music Folder**.

2  Make appropriate adjustments.

► When you select the **Set Video**.



1   Show the **Picture Mode**.



2   Make appropriate adjustments.

■ APS mode is not supported in Set Video function.

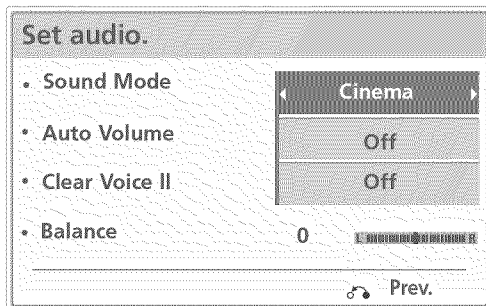
► When you select the **Set Audio**.



1   Show the **Sound Mode**, **Auto Volume**, **Clear Voice II** and **Balance**.

2   Make appropriate adjustments.

# MUSIC LIST

You can use the Music List menu to play MP3 files from a USB storage device.

This TV cannot play back copy-protected files.

The On Screen Display on your model may be slightly different.



Supported music file: \*.MP3



Bit rate range 8Kbps - 320Kbps

- Sampling rate (Sampling Frequency)  
MPEG1 Layer 3: 8KHz - 48KHz
- Music Max Length: 999.59 Sec.

USB

## Screen Components

**1**   Select USB.

**2**    Select Music List.

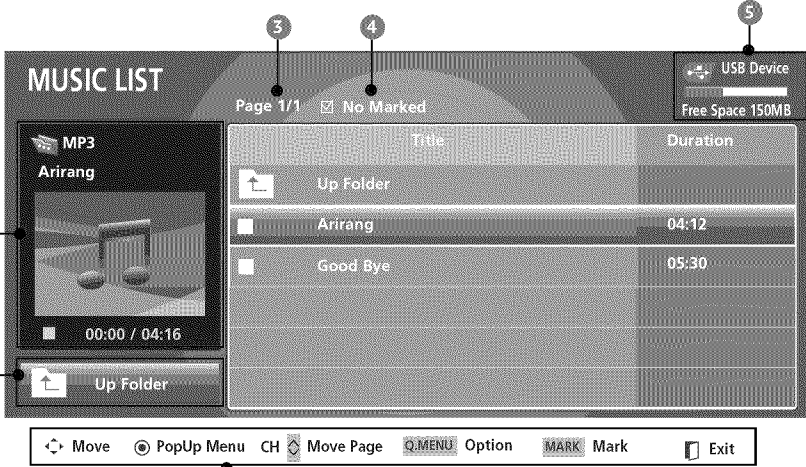

The screenshot shows the 'MUSIC LIST' interface. At the top, it displays 'Page 1/1' and 'No Marked'. A table lists music files with columns for 'Title' and 'Duration'. The table includes an 'Up Folder' entry and two music files: 'Arirang' (04:12) and 'Good Bye' (05:30). A preview window on the left shows a music player interface with a play button and a progress bar. At the bottom, a navigation bar contains buttons for 'Move', 'PopUp Menu', 'CH', 'Move Page', 'Q.MENU', 'Option', 'MARK', 'Mark', and 'Exit'.

① Moves to upper level folder.

② Preview: Display the title/folder name of the music in the selected folder.

③ Current page/Total pages.

④ Total number of marked music files.

⑤ Usable USB memory.





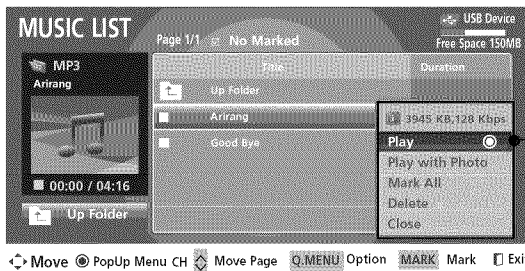
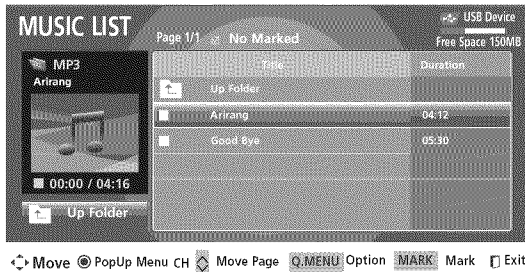

⑥ Corresponding buttons on the remote control.



## Music Selection and Popup Menu

Up to 6 music titles are listed per page.





- ▶ **Play (During stop):** Play the selected music file.  
Once a song finishes playing, the next selected one will be played. When there are no selected music file to play, the next one in the current folder will be played. If you go to a different folder and press the **ENTER** button, the current music file in playback will stop.
- ▶ **Play Marked:** Play the selected music file. Once a music file finishes playing, the next selected one will be played automatically.
- ▶ **Stop Play (During playback):** Stop the music file from playing.
- ▶ **Play with Photo:** Start playing the selected music file and then move to the Photo List.
- ▶ **Mark All:** Mark all music files in the folder.
- ▶ **Unmark All:** Deselect all marked music files.
- ▶ **Delete:** Delete the selected music file.
- ▶ **Close:** Close the popup menu.

- 1  Select the target folder or drive.
- 2   Select the desired music files.
- 3  Show the Popup menu.
- 4   Select the desired Popup menu.
- 5  Return to TV viewing.

- Use the **CH**   button to navigation in the music page.
- Use **MARK** button to mark or unmark a music file. If no music file is marked, all the music file in the folder will be played in sequence. When one or more music files are marked, the marked music files will be played in sequence. If you want to listen to only one song repeatedly, just mark that one file and play.

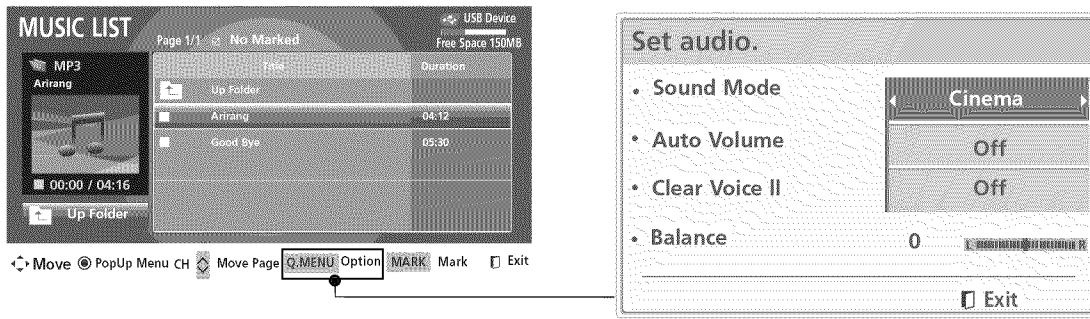
## Using the Music List Option





1  Show the **Sound Mode**.

2  Make appropriate adjustments.

- The play information box (as shown below) will automatically move across the screen when there is no user input to prevent a fixed image remaining on the screen for an extended period of time.



### NOTE

- ▶ When music is playing,  is displayed in front of the music play time.
- ▶ A damaged or corrupted music file that does not play displays 00:00 as the play time.
- ▶ Music files with copy-protection will not play.
- ▶ Press ENTER, , Home, Q.MENU, BACK, EXIT, or ENERGY SAVING button to stop the screen saver.
- ▶ This TV can not play music files less than 16 Kbytes.
- ▶ If you select "Off" for TV speaker, Set Audio features in choose options will not work.

## MOVIE LIST - For 42/50PT250U, 50/60PV550U

The movie list is activated once a USB drive is detected. It is used when playing movie files on the TV. Displays the video files in the USB folder that it recognizes as a video file. Editing such as delete and add is not allowed.

Movie (\*.AVI/ \*.mp4/ \*.DivX/ \*.DAT/ \*.MPG/ \*.MPEG/ \*.MPE/ \*.VOB) supporting file  
 Bit rate : within 32 - 320kbps (MP3)  
 Subtitle format : \*.ass/ \*.smi/ \*.srt/ \*.ssa

### Supported Movie File

Extension name	Video Codec	Maximum Resolution Supported	Frame	Audio Codec	Explanation
AVI mp4 DivX	MPEG4	720X480	25P	AC3 • Bit rate range 32Kbps - 640Kbps • Sampling rate 32KHz, 44.1KHz, 48KHz	Microsoft MPEG4 is not supported.
	DivX 3.XX				
	DivX 4.XX				
	DivX 5.XX				
	Xvid 1.00	800X432	30P	MPEG • Bit rate range 32Kbps - 448Kbps • Sampling rate 32KHz - 48KHz	WMV series are not supported.
	Xvid 1.01				
	Xvid 1.02				
	Xvid 1.03				
DAT	Xvid 1.10 Beta 1/2			LPCM	Playing a video only support the Playback.
MPG	MPEG1			MP3 • Bit rate range 32Kbps - 320Kbps • Sampling rate 32KHz - 48KHz	
MPEG					
MPE	MPEG2				
VOB					

### Precautions when playing the movie files

- ▶ Some user-created subtitles may not work properly.
- ▶ Some special characters are not supported in subtitles.
- ▶ HTML tags are not supported in subtitles.
- ▶ Subtitles in languages other than the supported languages are not available.
- ▶ Time information in an external subtitle file should be arranged in ascending order to be played.
- ▶ The screen may suffer temporary interruptions (image stoppage, faster playback, etc.) when the audio language is changed.
- ▶ A damaged video file may not play correctly, or some player functions may not be usable.
- ▶ Video files other than the specified types and formats may not work properly.
- ▶ The video file encoded by the GMC (Global Motion Compensation) is not supported.
- ▶ Only the files saved in ASCII CODE is supported in subtitles.
- ▶ DTS Audio codec is not supported.
- ▶ Playing a video via a USB connection that doesn't support high speed may not work properly.
- ▶ USB storage devices below USB 2.0 are supported as well. But they may not work properly with videos.

## Screen Components

**1**

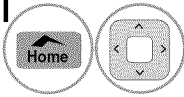

Select USB.

**2**

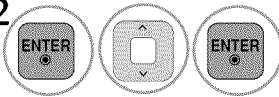

Select Movie List.

- ① Moves to upper level folder.
- ② Preview: Display the title/folder name of the movie in the selected folder.
- ③ Current page/Total pages.
- ④ Total number of marked movie files.
- ⑤ Usable USB memory.
- ⑥ Corresponding buttons on the remote control.

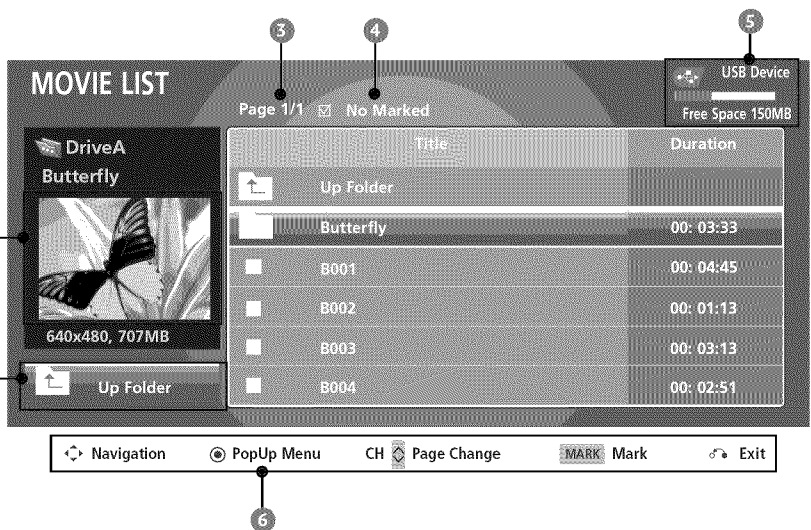

The screenshot shows a 'MOVIE LIST' interface. At the top, it displays 'Page 1/1' and 'No Marked'. On the right, there's a 'USB Device' section with a progress bar and 'Free Space 150MB'. The main area is divided into a preview pane on the left and a list on the right. The preview pane shows 'DriveA Butterfly' with a butterfly image and '640x480, 707MB'. Below it is an 'Up Folder' button. The list has columns for 'Title' and 'Duration'. It includes an 'Up Folder' entry, a 'Butterfly' entry (00: 03:33), and four entries labeled 'B001' through 'B004' with durations of 00: 04:45, 00: 01:13, 00: 03:13, and 00: 02:51 respectively. At the bottom, a navigation bar contains buttons for 'Navigation', 'PopUp Menu', 'CH', 'Page Change', 'MARK Mark', and 'Exit'.

USB





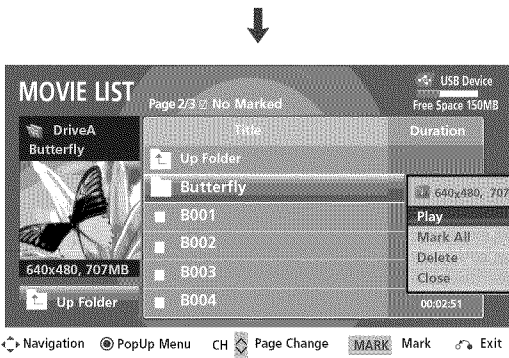
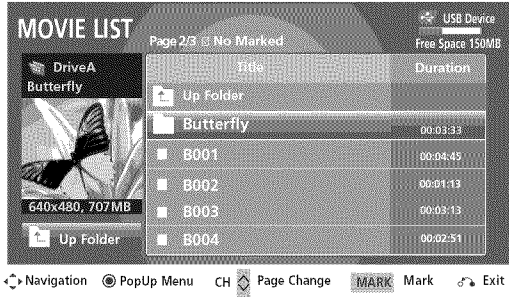

### NOTE

- ▶ The video file and the subtitle file must be located in the same folder.
- ▶ The name of the video file and the subtitle file must be the same to view the subtitles normally

## Movie Selection and Popup Menu



- ▶ **Play:** Play the selected movie. DivX Play is executed while screen changes.
- ▶ **Play Marked:** Play the selected movie titles. Once a movie finishes playing, the next selected one will be played automatically.
- ▶ **Mark All:** Mark all movie in the folder.
- ▶ **Unmark All:** Deselect all marked movie.
- ▶ **Delete:** Delete the selected movie.
- ▶ **Close:** Close the pop-up menu.





- 1  Select the target folder or drive.
- 2   Select the desired movie file.
- 3  Show the PopUp menu.
- 4   Select the desired PopUp menu.
- 5  Return to TV viewing

- Use the CH ^ v button to navigation in the movie page.
- Use MARK button to mark or unmark a movie file. When one or more movie files are marked, the marked movie files will be played in sequence.



## Using the remote control

You can adjust various method during movie play.

	<p>When playing, repeatedly press the <b>REW</b>(◀◀) button to speed up ◀◀ -&gt; ◀◀◀◀ -&gt; ◀◀◀◀◀◀ -&gt; ◀◀◀◀◀◀◀◀ .</p> <p>repeatedly press the <b>FF</b>(▶▶) button to speed up ▶▶ -&gt; ▶▶▶▶ -&gt; ▶▶▶▶▶▶ -&gt; ▶▶▶▶▶▶▶▶ .</p> <ul style="list-style-type: none"><li>■ Pressing these buttons repeatedly increases the fast forward/reverse speed.</li></ul>
	<p>During playback, press the <b>Pause</b>(II) button</p> <ul style="list-style-type: none"><li>■ Still screen is displayed.</li></ul>
	<ul style="list-style-type: none"><li>■ When using the &lt; or &gt; buttons during playback a cursor indicating the position can be viewed on the screen.</li></ul>
	<p>Press the <b>PLAY</b>(▶) button to return to normal playback.</p>

### NOTE

- ▶ Use the (< / >) buttons to move to a specific frame forward or backward while playing a movie. (The (< / >) buttons may not work properly for some files while playing a movie.)

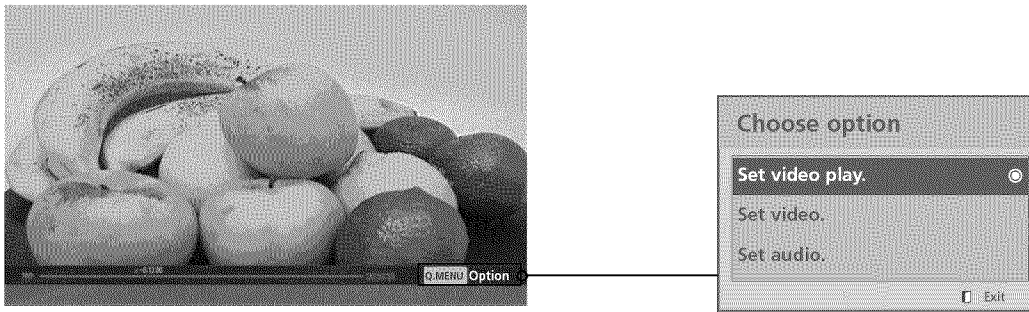

## Using The Movie List Option



### NOTE

► If you select "Off" for TV speaker, **Set Audio** features in choose options will not work.



USB

- 1  Show the Popup menu.
- 2  Select **Set Video Play**, **Set Video**, or **Set Audio**.

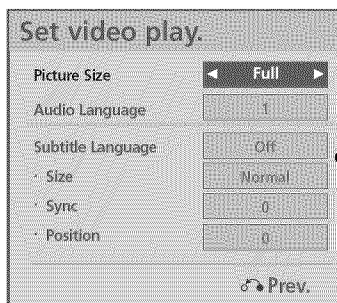
► When you select the **Set Video Play**.





- **Picture size:** Selects your desired picture format for videos.
- **Audio Language:** Changes the Language Group of the audio for video files. Files with a single audio track cannot be selected.
- **Subtitle Language:** The subtitles can be turned on or off.
- **Size:** Changes the subtitle font size.
- **Sync:** the video is not synchronized with the captions, it can be adjusted by 0.5 second.
- **Position:** Move the location of the subtitles.

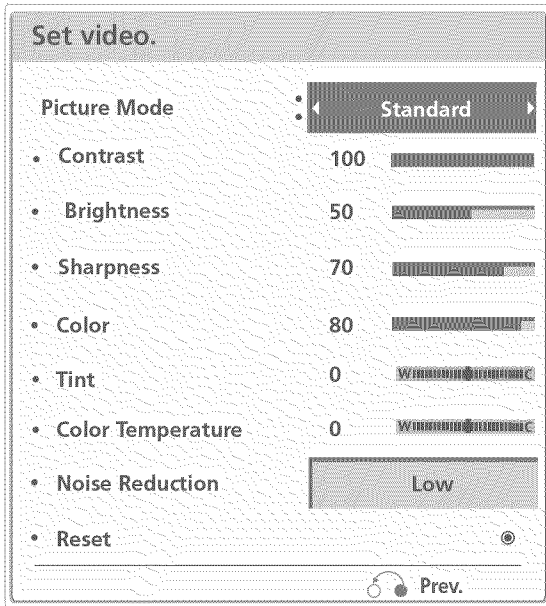

- 1  Show the **Picture size**, **audio Language**, or **Subtitle Language**.
- 2  Make appropriate adjustments.

Subtitle Language Group	Supported Language
Latin1	English, Spanish, French

► When you select the **Set Video**.





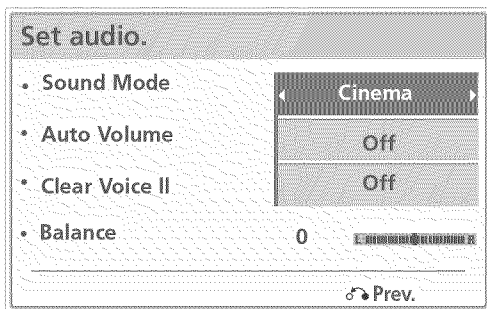

1   Show the **Picture Mode**.

2   Make appropriate adjustments.

► When you select the **Set Audio**.



1   Show the **Sound Mode, Auto Volume, Clear Voice II and Balance**.





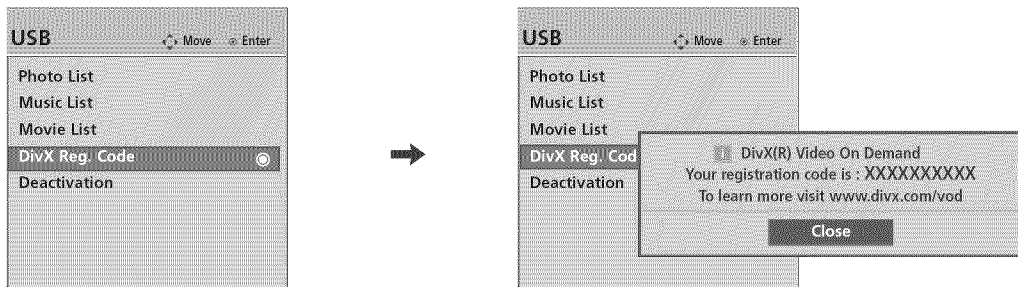

2   Make appropriate adjustments.

## DIVX REGISTRATION CODE - For 42/50PT250U, 50/60PV550U

Confirm the DivX registration code number of the TV. Using the registration number, movies can be rented or purchased at [www.divx.com/vod](http://www.divx.com/vod).

DRM protected DivX files must be matched with the registration code of this TV are playable. DivX files registered for another TV will not play.



- 1   Select USB.
- 2   Select DivX Reg. Code.
- 3  Display DivX Reg. Code.
- 4  Return to the previous menu.
-  Return to TV viewing.









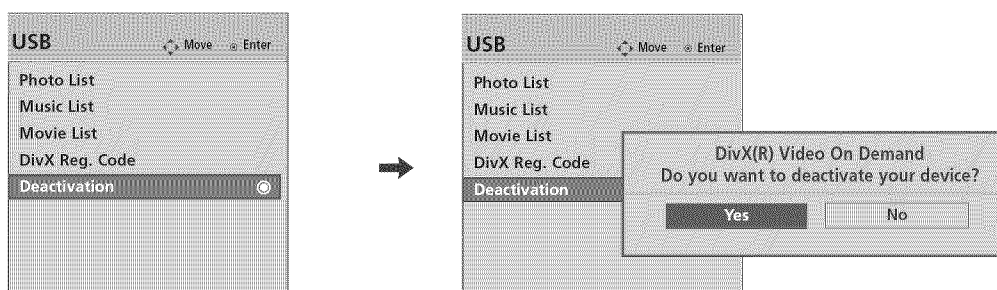

### NOTE

- ▶ When loading, some buttons may not work.
- ▶ If you use the DivX registration code of another device, the rented or purchased DivX file cannot be played. Therefore always use the DivX registration code assigned to this product.
- ▶ The video or audio of a file converted based on a standard other than the DivX codec standard may be corrupted or unable to be played.

## DEACTIVATION - For 42/50PT250U, 50/60PV550U

Delete the existing authentication information to receive a new DivX user authentication for TV. Once this function is executed, a DivX user authentication is required again to see DivX DRM files.



- 1   Select USB.
- 2   Select Deactivation.
- 3    Select Yes.
- 4  Display Deactivation.
- 5  Return to the previous menu.
-  Return to TV viewing.





# PICTURE CONTROL

## PICTURE SIZE (ASPECT RATIO) CONTROL

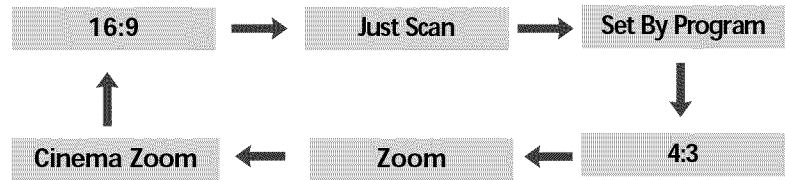
This feature lets you choose the way an analog picture with a 4:3 aspect ratio is displayed on your TV.

- RGB-PC input only supports 4:3 and 16:9 aspect ratio.



- 1   Select the **Aspect Ratio**.
- 2  Select the desired picture format.
- 3  Return to TV viewing.

- You can also press the **RATIO** button repeatedly on the remote control.

## 16:9

Adjust the picture horizontally, in a linear proportion to fill the entire screen.

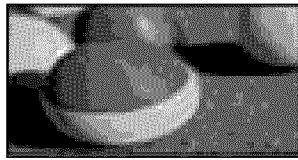

## Just Scan

Normally the edges of video signals are cropped 1-2%. Just Scan turns off this cropping and shows the complete video.

Notes: If there is noise on the edges of the original signal, it will be visible when Just Scan is activated.

Just Scan operates only in DTV/CADTV/Component/HDMI-DTV/DVI-DTV (720p/1080i/1080p) input source.



## Set By Program

Selects the proper picture proportion to match the source's image.

(4:3 → 4:3)

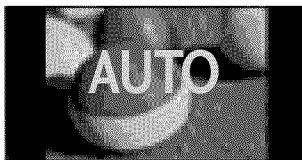

(16:9 → 16:9)

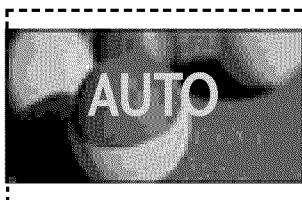

## 4:3

Choose 4:3 when you want to view a picture with an original 4:3 aspect ratio.



## Zoom

Choose Zoom when you want to view the picture without any alteration. However, the top and bottom portions of the picture will be cropped.

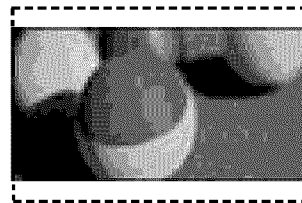

## Cinema Zoom

Choose Cinema Zoom when you want to enlarge the picture in correct proportion. Note: When enlarging or reducing the picture, the image may become distorted.

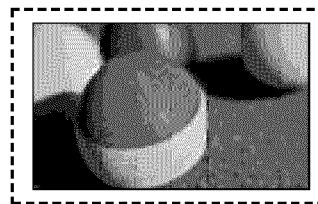

■ The adjustment range is 1-16.

# PICTURE CONTROL

## PICTURE WIZARD - Except 42/50PT250U, 50/60PV550U

This feature lets you adjust the picture quality of the original image.

Use this to calibrate the screen quality by adjusting the Black and White Level etc. You can calibrate the screen quality by easily following each step.

When you adjust the image to **Low**, **Recommended**, or **High** you can see the example of the changes you made.

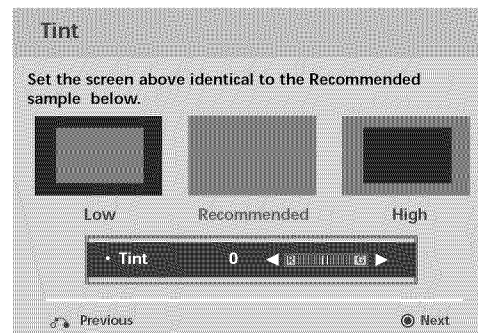
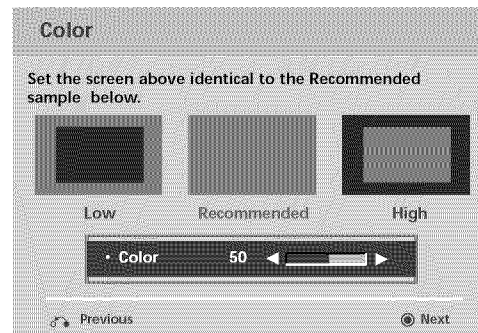
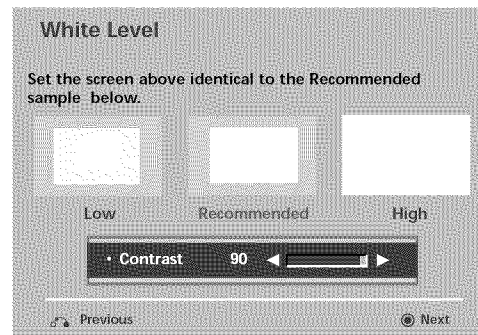
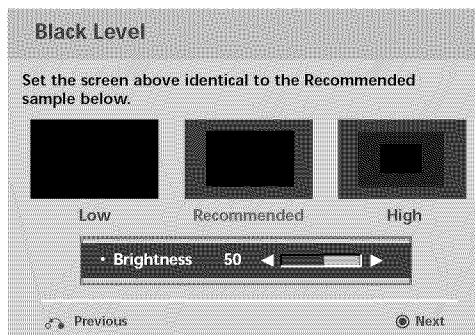
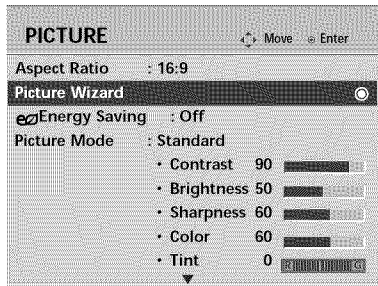



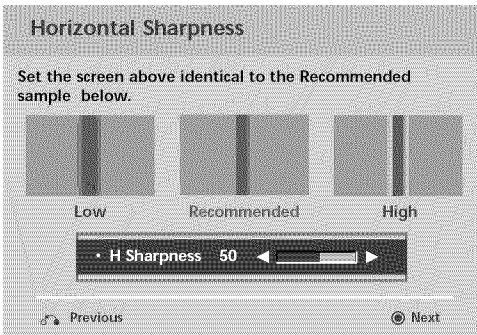

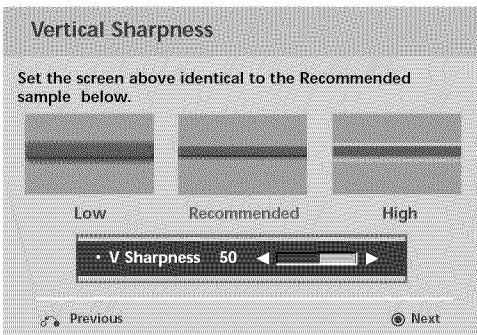

8   Adjust Horizontal Sharpness.



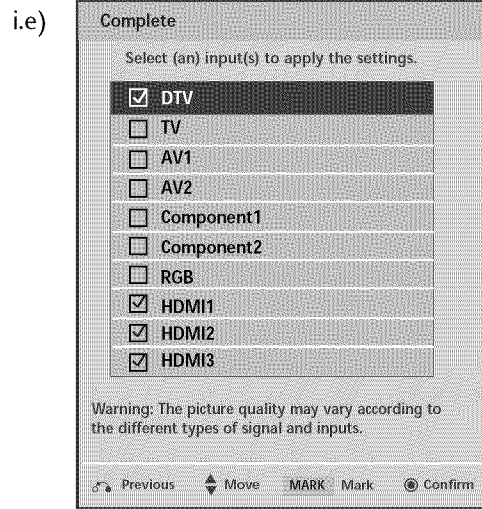

9   Adjust Vertical Sharpness.

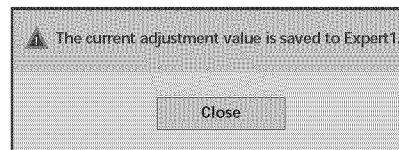

10   Select input source to apply the settings.

11  Save.



12  Finish the Picture Wizard.

■ If you stop the setting before the final step, the changes will not be saved to the TV.







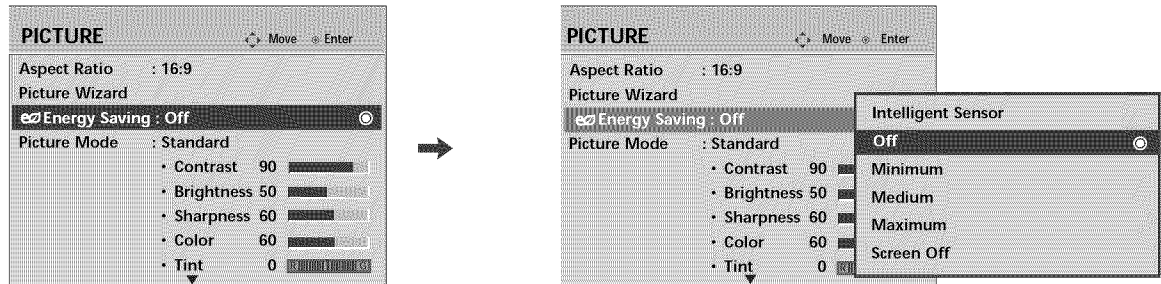

# PICTURE CONTROL

## e ENERGY SAVING

It reduces the TV's power consumption.

You can increase the brightness of your screen by adjusting the Energy Saving level or by setting the Picture Mode. This feature is disabled in "Picture Mode-Cinema".



-   Select PICTURE.
-   Select **e** Energy Saving.
-   Select Intelligent Sensor, Off, Minimum, Medium, or Maximum.
-  Return to the previous menu.
-  Return to TV viewing.

- You can also adjust the **ENERGY SAVING** button on the remote control.
- **Intelligent Sensor?**  
This function automatically adjusts the brightness of screen to the most suitable picture according to the surrounding conditions.

# PRESET PICTURE SETTINGS (PICTURE MODE)

There are factory presets for picture settings available in the user menus. You can use a preset, change each setting manually.

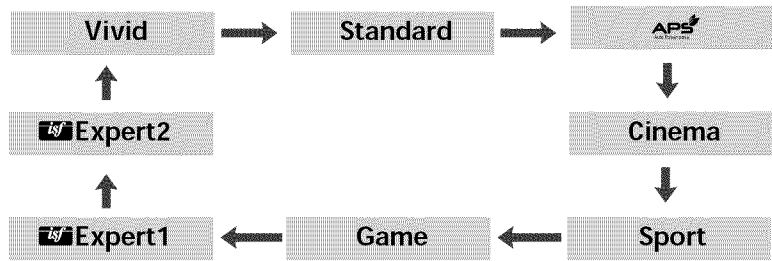
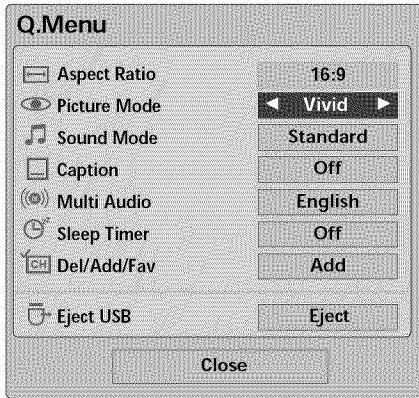

- 1 Select Picture Mode.
- 2 Select Vivid, Standard, APS, Cinema, Sport, Game, Expert1, or Expert2.
- 3 Return to TV viewing.









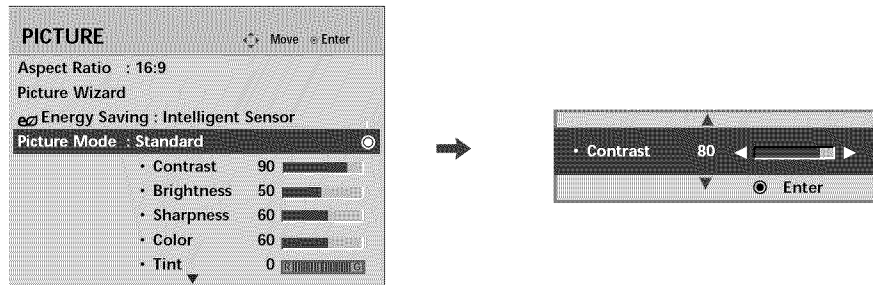



- Vivid, Standard, APS, Cinema, Sport, and Game Settings are preset for the optimum picture quality at the factory.
- You can also adjust Picture Mode in the PICTURE menu.
- Vivid: This is the mode to maximize the effect of the video in the retail store. Strengthen the contrast, brightness, color and sharpness for vivid picture.
- APS: This mode maximizes reducing the power consumption without hurting the picture quality.
- Standard: This is the mode to realize optimum viewing condition for the general user.
- Cinema: This mode optimizes video for watching movies.
- Sport: This is the video mode to emphasize dynamic video and primary color (Ex, white, uniform, grass, sky blue etc.) by realizing the optimal screen for sports.
- Game: This is the mode to realize fast response speed in a fast gaming screen.
- Expert: This is the mode to adjust the video in detail for video quality expert and general user.

# PICTURE CONTROL

## MANUAL PICTURE ADJUSTMENT-USER MODE

Adjust the picture appearance to suit your preference and viewing situations.



-   Select **PICTURE**.
-   Select **Picture Mode**.
-   Select **Vivid, Standard, Cinema, Sport, or Game**.
-   Select **Contrast, Brightness, Sharpness, Color, Tint, or Color Temperature**.
-   Make appropriate adjustments.
-  Return to the previous menu.
-  Return to TV viewing.







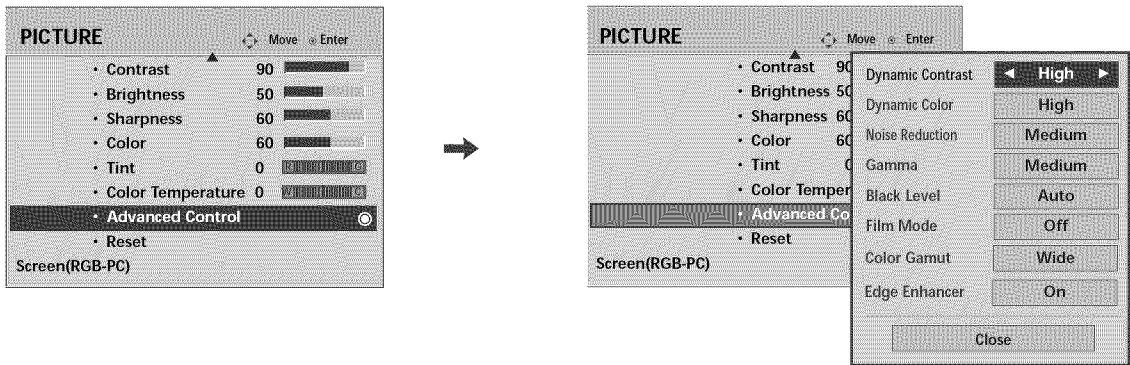

- **Contrast:** Increase or decrease the gradient of the video signal. You may use Contrast when the bright part of picture is saturated.
- **Brightness:** Adjusts the base level of the signal in the picture. You may use brightness when the dark part of the picture is saturated.
- **Sharpness:** Adjusts the level of crispness in the edges between the light and dark areas of the picture. The lower the level, the softer the image.
- **Color:** Adjusts intensity of all colors.
- **Tint:** Adjusts the balance between red and green levels.
- **Color Temperature:** Set to warm to enhance hotter colors such as red, or set to cool to make picture bluish.

# PICTURE IMPROVEMENT TECHNOLOGY

You can calibrate the screen for each Picture Mode or set the video value according to the special video screen. You can set the video options differently for each input.

To reset to the factory default screen after making adjustments to each video mode, execute the “Reset” function for each Picture Mode.



- 1   Select PICTURE.
- 2   Select Advanced Control.
- 3   Select your desired options.
- 4  Make appropriate adjustments.
- 5  Return to the previous menu.
-  Return to TV viewing.

# PICTURE CONTROL

## EXPERT PICTURE CONTROL

Expert1 and Expert2 provide even more advanced picture settings for users.

This may also be used by a professional to help optimize the TV performance in the environment the TV is in.

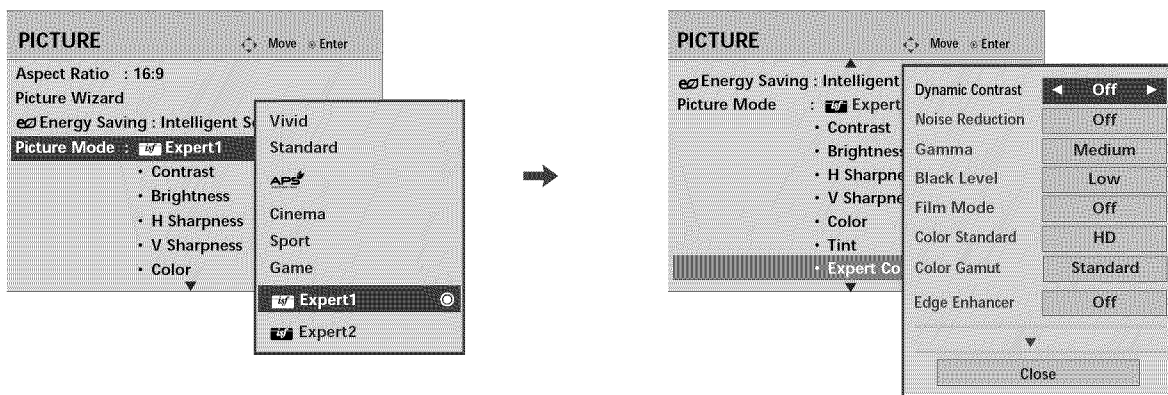

- Select PICTURE.
- Select Picture Mode.
- Select Expert1 or Expert2.
- Select Expert Control.
- Select your desired menu option.
- Make appropriate adjustments.
- Return to the previous menu.
- Return to TV viewing.

Dynamic Contrast	<ul style="list-style-type: none"> <li>Adjusts the contrast to keep it at the best level according to the brightness of the screen. The picture is improved by making bright parts brighter and dark parts darker.</li> </ul>
Dynamic Color	<ul style="list-style-type: none"> <li>Adjusts screen colors so that they look livelier, richer and clearer. This feature enhances hue, saturation and luminance so that red, blue, green and white look more vivid.</li> </ul>
Noise Reduction	<ul style="list-style-type: none"> <li>Reduces screen noise without compromising video quality.</li> </ul>
Gamma	<p><i>Low</i> : Make dark and middle gray level area of the picture brighter.  <i>Medium</i>: Express original picture levels.  <i>High</i>: Make dark and middle gray level area of the picture darker.</p> <ul style="list-style-type: none"> <li>You can adjust brightness of dark area and middle gray level area of the picture.</li> </ul>
Black Level	<p><i>Low</i>: The reflection of the screen gets darker.  <i>High</i>: The reflection of the screen gets brighter.  <i>Auto</i>: Realizing the black level of the screen and set it to High or Low automatically.</p> <ul style="list-style-type: none"> <li>Set black level of the screen to proper level.</li> <li>This function enables to select 'Low' or 'High' in the following mode: AV (NTSC-M), HDMI or Component. Otherwise, 'Black level' is set to 'Auto'.</li> </ul>
Film Mode	<ul style="list-style-type: none"> <li>Makes video clips recorded in film look more natural by eliminating judder effect.</li> <li>DVD and Blu-ray movies are filmed at 24 frames per second.</li> </ul>
Color Gamut	<p><i>Standard</i>: Displays standard color area.  <i>Wide</i>: Mode to use and set the rich color area of the display.</p> <ul style="list-style-type: none"> <li>Maximize the utilization of color to increase color quality.</li> </ul>
Edge Enhancer	<ul style="list-style-type: none"> <li>Show clearer and distinctive yet natural corners of the video.</li> </ul>
Color Standard	<ul style="list-style-type: none"> <li>Convert the color of a different video to HD color.</li> </ul>
White Balance	<ul style="list-style-type: none"> <li>This is the function to adjust the overall color of the screen to the feeling you want.             <ol style="list-style-type: none"> <li>Method : 2 Points                 <ul style="list-style-type: none"> <li>Pattern: Inner, Outer</li> <li>Red/Green/Blue Contrast, Red/Green/Blue Brightness: The adjustment range is -50 - +50.</li> </ul> </li> <li>Method : 20 Point IRE                 <ul style="list-style-type: none"> <li>Pattern: Inner, Outer</li> <li>IRE (Institute of Radio Engineers) is the unit to display the size of the video signal and can be set among 5, 10, 15 - 95, 100. You can adjust Red, Green or Blue according to each setting.</li> <li>Red/Green/Blue: The adjustment range is -50 - +50.</li> </ul> </li> </ol> </li> </ul>
Color Management System	<ul style="list-style-type: none"> <li>As the tool used by the experts to make adjustments by using the test patterns, this does not affect other colors but can be used to selectively adjust the 6 color areas (Red/Green/Blue/Cyan/Mgt/Yellow). Color difference may not be distinctive even when you make the adjustments for the general video. Adjusts Red/Green/Blue/Yellow/Cyan, Magenta.             <ul style="list-style-type: none"> <li>Red/Green/Blue/Yellow/Cyan, Magenta Color: The adjustment range is -30 - +30.</li> <li>Red/Green/Blue/Yellow/Cyan, Magenta Tint: The adjustment range is -30 - +30.</li> <li>This feature is disable in RGB-PC and HDMI (PC) mode.</li> </ul> </li> </ul>

# PICTURE CONTROL

## PICTURE RESET

Settings of the selected picture modes return to the default factory settings.

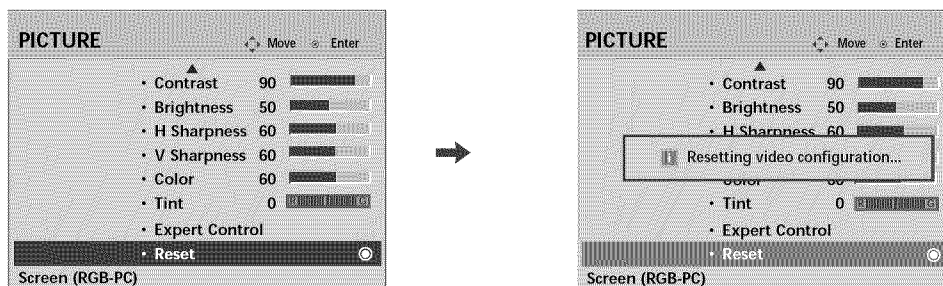

1   Select PICTURE.

2   Select Reset.

3  Initialize the adjusted value.

4  Return to TV viewing.

## DEMO MODE

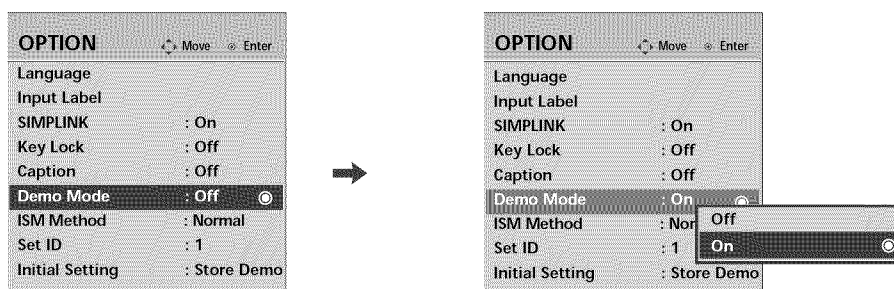

Displays a slide show to explain the various features of this TV.

This feature is disabled in "Initial Setting-Home Use".



1   Select OPTION.

2   Select Demo Mode.

3   Select On.

4  Return to TV viewing.

After a while, **Demo Mode** starts.  
If you want to stop the demo, press any button.  
(except VOL or MUTE)

5 Show the various features of the TV.







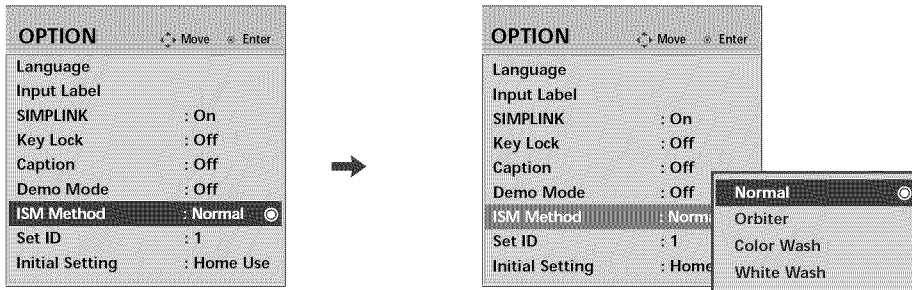

6 Show the difference XD Engine features.



# IMAGE STICKING MINIMIZATION (ISM) METHOD

A frozen still picture displayed on the screen for prolonged periods can result in a ghost image. You can use Orbiter to help prevent image sticking. The other two functions are for removing a ghost image.



- 1   Select **OPTION**.
- 2   Select **ISM Method**.
- 3   Select **Normal, Orbiter, Color Wash, or White Wash**.
- 4  Return to the previous menu.
-  Return to TV viewing.

- **Normal:** If image sticking is never a problem, ISM is not necessary - set to Normal.
- **Orbiter:** Orbiter may help prevent ghost images. However, it is best not to allow any fixed image to remain on the screen. To avoid a ghost image on the screen, the image will move every 2 minutes.
- **Color Wash:** The color block with the screen moved a little and the white pattern are alternately displayed. It is difficult to see the after image on all colors. Once it has been corrected it will not be visible in any color.
- **White Wash:** White Wash removes ghost images from the screen. Use sparingly. Watch the TV normally for a while before using this feature to see if the ghost image disappears on its own.

**NOTE**

▶ An excessive ghosted image may be impossible to clear entirely with White Wash. To return to normal viewing, press the any button.







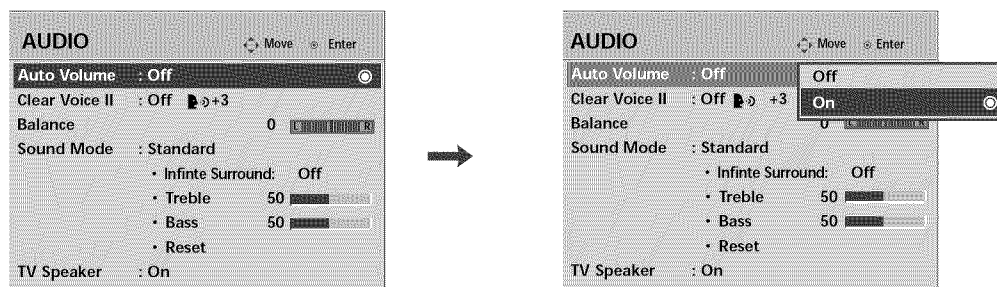

# SOUND & LANGUAGE CONTROL

## AUTO VOLUME LEVELER (AUTO VOLUME)

Auto Volume makes sure that the volume level remains consistent whether you are watching a commercial or a regular TV program.

Because each broadcasting station has its own signal conditions, volume adjustment may be needed every time the channel is changed. This feature allows users to enjoy stable volume levels by making automatic adjustments for each program.



-   Select **AUDIO**.
-   Select **Auto Volume**.
-   Select **On** or **Off**.
-  Return to the previous menu.
-  Return to TV viewing.

# CLEAR VOICE II

By differentiating the human sound range from others, it improves the sound quality of voices.

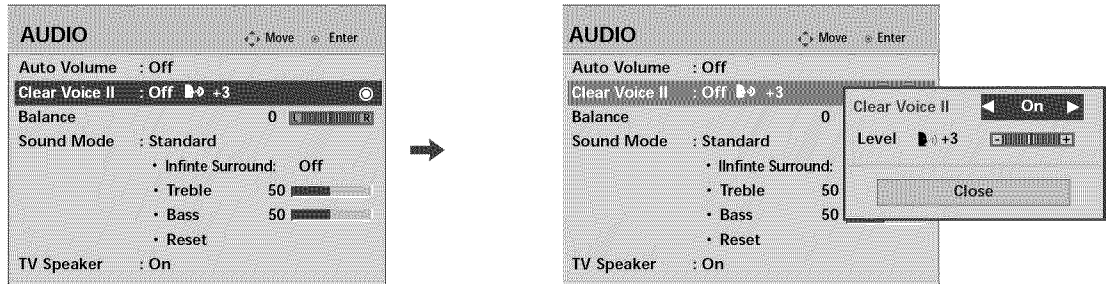

1   Select **AUDIO**.



2   Select **Clear Voice II**.

3   Select **On** or **Off**.

## Adjustment for Clear Voice II Level With selecting On

4   Select **Clear Voice II**.

5   Select **Level**.

6   Make appropriate adjustments.

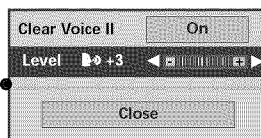

7  Return to the previous menu.





 Return to TV viewing.

# SOUND & LANGUAGE CONTROL

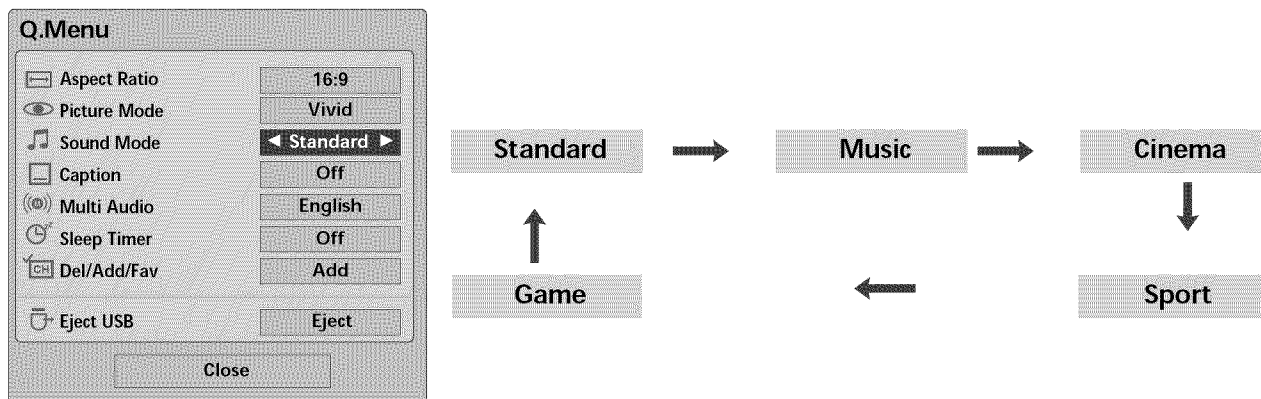
## PRESET SOUND SETTINGS (SOUND MODE)

Sound Mode lets you enjoy the best sound without any special adjustment as the TV sets the appropriate sound options based on the program content.



- 1   Select **Sound Mode**.
- 2  Select **Standard, Music, Cinema, Sport, or Game**.
- 3  Return to TV viewing.

- **Standard, Music, Cinema, Sport, and Game** are preset for optimum sound quality at the factory.
- You can also adjust **Sound Mode** in the **AUDIO** menu.
- **Standard**: Offers standard-quality sound.
- **Music**: Optimizes sound for listening to music.
- **Cinema**: Optimizes sound for watching movies.
- **Sport**: Optimizes sound for watching sports events.
- **Game**: Optimizes sound for playing games.

# SOUND SETTING ADJUSTMENT - USER MODE

Adjust the sound to suit your taste and room situations.

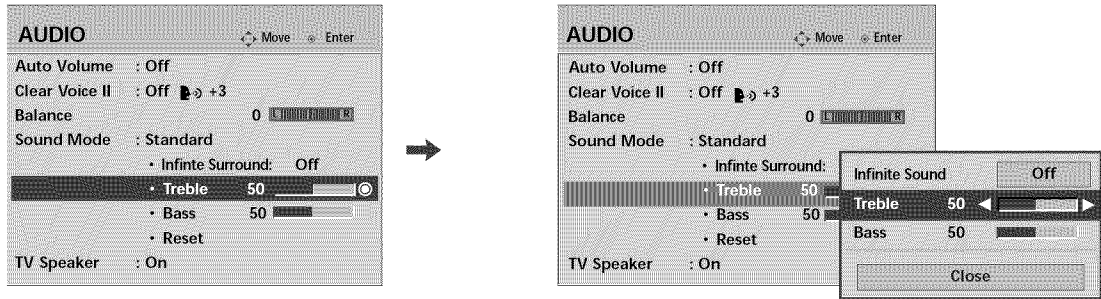







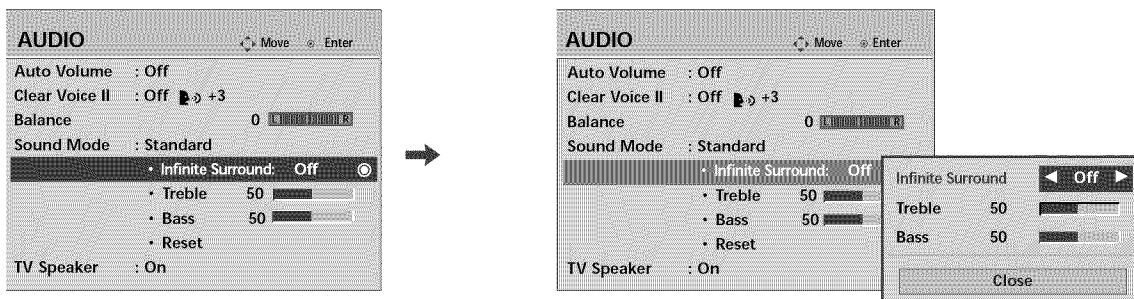

- 1   Select **AUDIO**.
- 2   Select **Sound Mode**.
- 3   Select **Standard, Music, Cinema, Sport, or Game**.
- 4   Select **Treble or Bass**.
- 5   Make appropriate adjustments.
- 6  Return to the previous menu.
-  Return to TV viewing.

# SOUND & LANGUAGE CONTROL

## INFINITE SURROUND

Select this option to sound realistic.









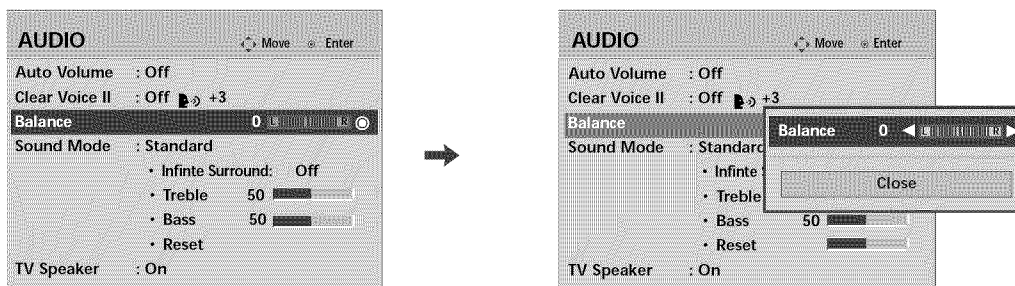

-   Select **AUDIO**.
-   Select **Infinite Surround**.
-   Select **On** or **Off**.
-  Return to the previous menu.
-  Return to TV viewing.

- If sound quality or volume is not at the level you want, it is recommended to use a separate home theater system or amp to cope with different user environments.
- If you select “Clear Voice II-On”, Infinite Surround feature will not work.

# BALANCE

Adjust the left/right sound of speaker to suit your taste and room situations.



-   Select **AUDIO**.
-   Select **Balance**.
-   Make appropriate adjustments.
-  Return to the previous menu.
-  Return to TV viewing.

# SOUND & LANGUAGE CONTROL

## TV SPEAKERS ON/OFF SETUP

Turn the TV speakers off if using external audio equipment.

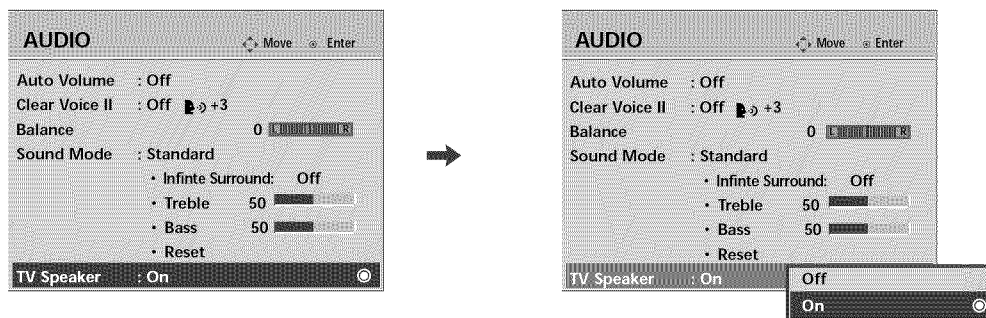







-   Select **AUDIO**.
-   Select **TV Speaker**.
-   Select **On** or **Off**.
-  Return to the previous menu.
-  Return to TV viewing.

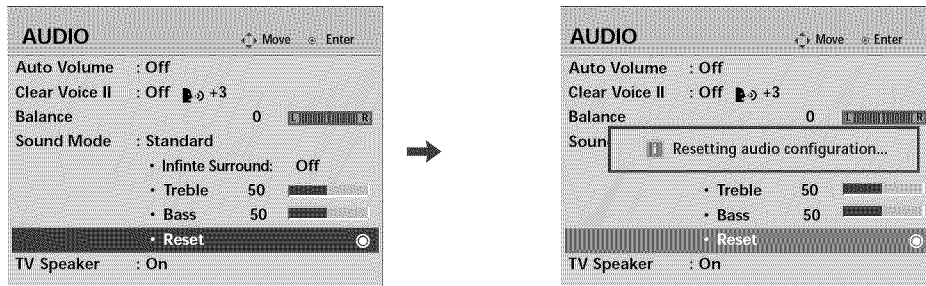

# AUDIO RESET

Settings of the selected Sound Mode return to the default factory settings.



-   Select **AUDIO**.
-   Select **Reset**.
-  Initialize the adjusted value.
-  Return to TV viewing.



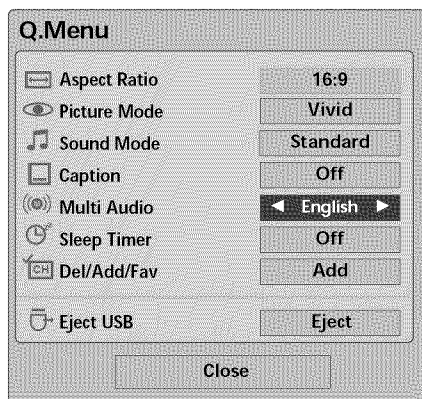

# SOUND & LANGUAGE CONTROL

## STEREO/SAP BROADCAST SETUP





For Analog only: This TV can receive MTS stereo programs and any SAP (Secondary Audio Program) that accompanies the stereo program if the station transmits an additional sound signal. Mono sound is automatically used if the broadcast is only in Mono.



### Analog TV

- 1   Select SAP.
- 2  Select Mono, Stereo, or SAP.
- 3  Return to TV viewing.





### Digital TV

- 1   Select Multi Audio.
- 2  Select other languages.
- 3  Return to TV viewing.

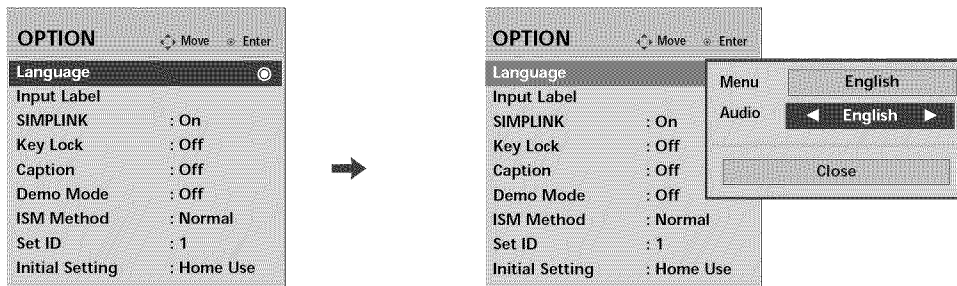
# AUDIO LANGUAGE

Other languages may be available if a digital signal is provided by the broadcasting station.  
This feature operates only in DTV/CADTV mode.





-   Select **OPTION**.
-   Select **Language**.
-   Select **Audio**.
-   Select your desired language.
-  Return to the previous menu.
-  Return to TV viewing.

# SOUND & LANGUAGE CONTROL

## ON-SCREEN MENUS LANGUAGE SELECTION

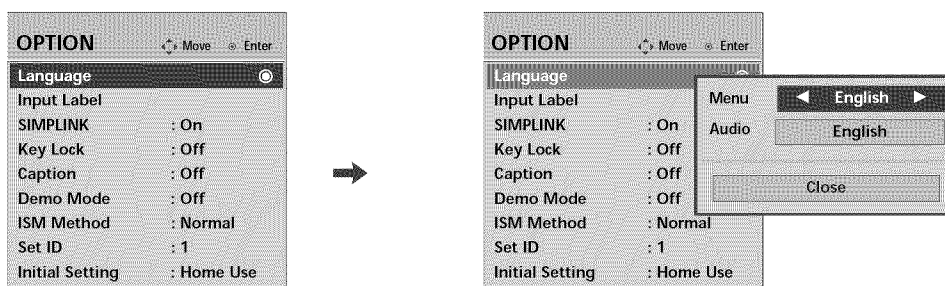
The menus can be shown on the screen in the selected language.

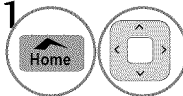
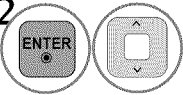
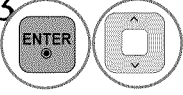
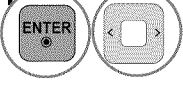



-  Select **OPTION**.
-  Select **Language**.
-  Select **Menu**.
-  Select your desired language.  
From this point on, the on-screen menus will be shown in the selected language.
-  Return to the previous menu.
-  Return to TV viewing.

# CAPTION MODE

## Analog Broadcasting System Captions

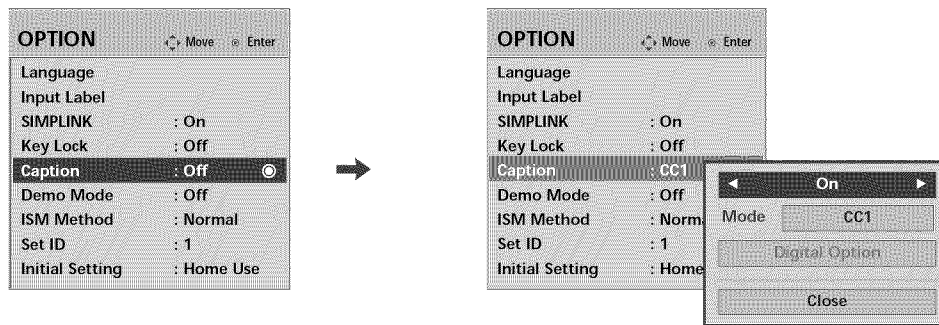
Captions are provided to help people with hearing loss watch TV. Select a caption mode for displaying captioning information if provided on a program. Analog caption displays information at any position on the screen and is usually the program's dialog. Caption/Text, if provided by the broadcaster, would be available for both digital and analog channels on the Antenna/Cable. This TV is programmed to memorize the caption/text mode which was last set when you turned the power off. This function is only available when **Caption Mode** is set **On**.

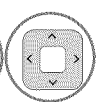
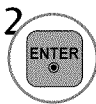
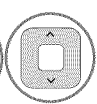
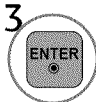
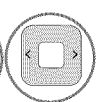
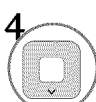
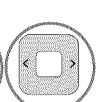
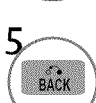
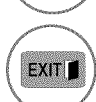

- 1   Select **OPTION**.
- 2   Select **Caption**.
- 3   Select **On**.
- 4   Select **CC1-4** or **Text1-4**.
- 5  Return to the previous menu.
-  Return to TV viewing.

- When selecting **Off**, Sub-menus for Analog, DTV, and Digital Option become disabled.
- **CAPTION**  
The term for the words that scroll across the bottom of the TV screen; usually the audio portion of the program provided for the hearing impaired.
- **TEXT**  
The term for the words that appear in a large black frame and almost cover the entire screen; usually messages provided by the broadcaster.

# SOUND & LANGUAGE CONTROL



## Digital Broadcasting System Captions

Choose the language you want the DTV/CADTV Captions to appear in.

Other Languages can be chosen for digital sources only if they are included on the program.

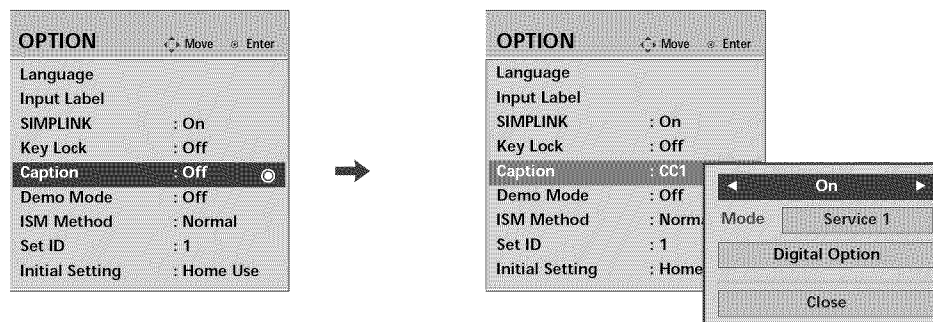
This function is only available when **Caption Mode** is set **On**.

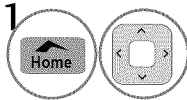
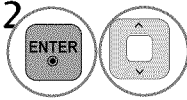
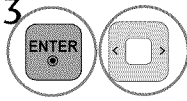
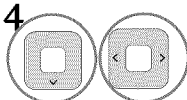

-  Select **OPTION**.
-  Select **Caption**.
-  Select **On**.
-  Select **CC1-4, Text1-4, or Service1-6**.
-  Return to the previous menu.
-  Return to TV viewing.

## Caption Option

Customize the DTV/CADTV captions that appear on your screen.  
This function is only available when Caption Mode is turned On.

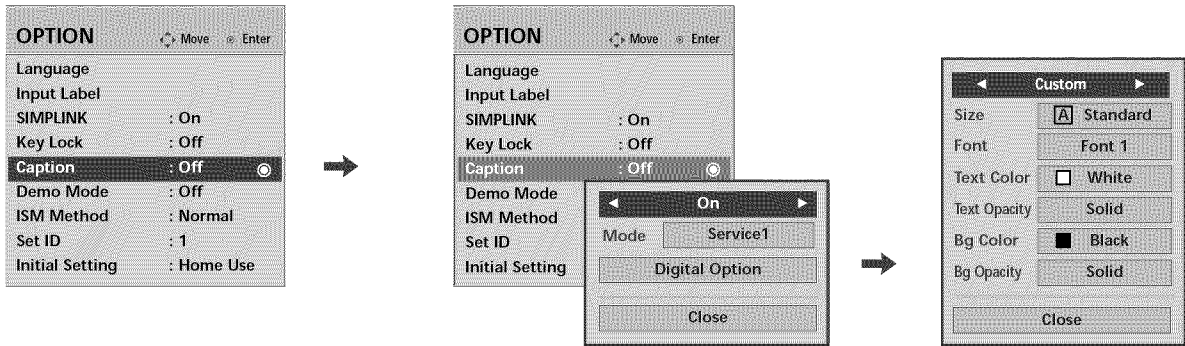



1   Select **OPTION**.

2   Select **Caption**

3   Select **On**.

4  Select **Digital Option**.

5   Select **Custom**.

6   Customize the **Style, Font**, etc., to your preference. A preview icon is provided at the bottom of the screen, use it to see the caption language.

7  Return to the previous menu.

 Return to TV viewing.

- **Size:** Set the word size.
- **Font:** Select a typeface for the text.
- **Text Color:** Choose a color for the text.
- **Text Opacity:** Specify the opacity for the text color.
- **Bg (Background) Color:** Select a background color.
- **Bg (Background) Opacity:** Select the opacity for the background color.

# TIME SETTING

## CLOCK SETTING





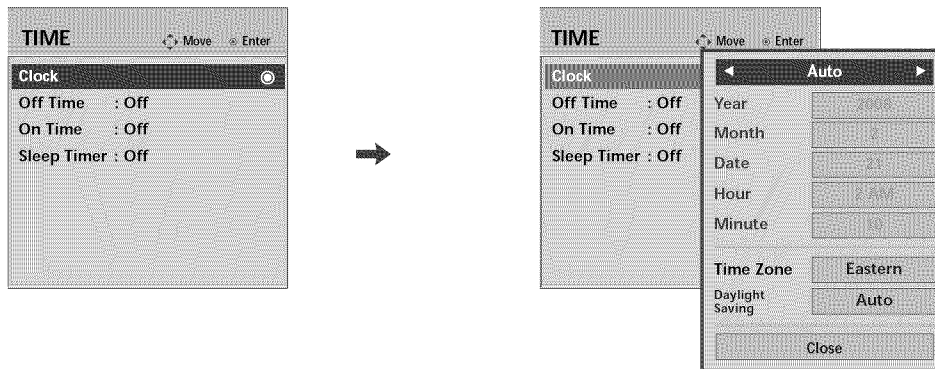

### Auto Clock Setup

The time is set automatically from a digital channel signal.

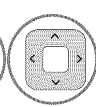
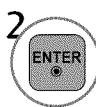
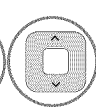
The digital channel signal includes information for the current time provided by the broadcasting station.

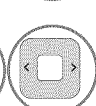
Set the clock manually if the current time is set incorrectly by the auto clock function.

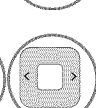
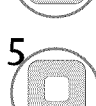
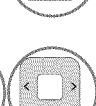









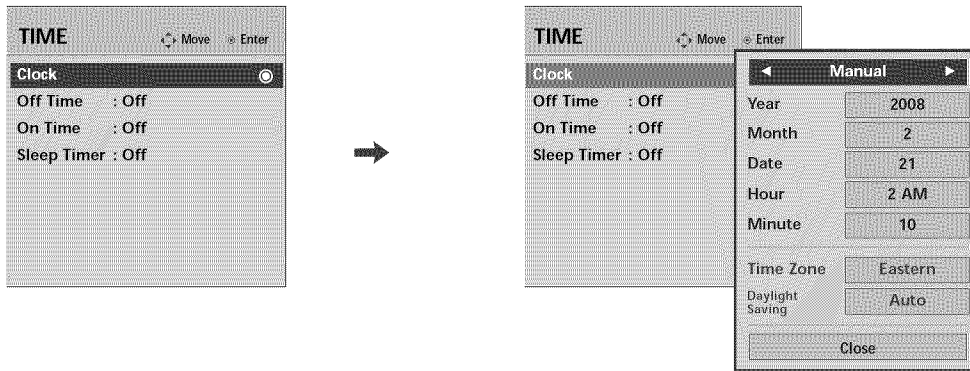

-   Select **TIME**.
-   Select **Clock**.
-   Select **Auto**.
-   Select your viewing area time zone.
-   Select **Auto**, **On**, or **Off** (depending on whether or not your viewing area observes Daylight Saving time).
-  Return to the previous menu.
-  Return to TV viewing.



## Manual Clock Setup

If the current time setting is wrong, set the clock manually.



-   Select **TIME**.
-   Select **Clock**.
-   Select **Manual**.
-  Select the Year, Month, Date, Hour, or Minutes option.
-  Set the Year, Month, Date, Hour, or Minutes option.
-  Return to the previous menu.
-  Return to TV viewing.

► If you unplug the TV once or turn the main power off, the clock function reset.

# TIME SETTING

## AUTO ON/OFF TIME SETTING

This function operates only if the current time has been set.

The **Off Time** function overrides the **On Time** function if they are both set to the same time.





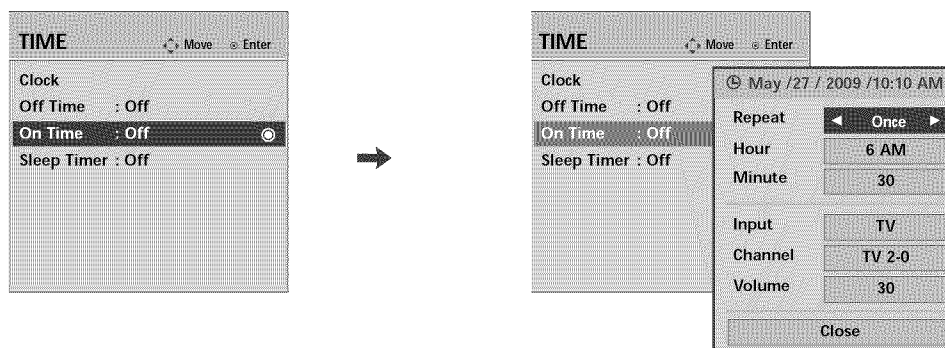

The TV must be in standby mode for the **On Time** to work.

If you do not press any button within 2 hours after the TV turns on with the **On Time** function, the TV will automatically revert to standby mode.



- 1   Select **TIME**.
- 2   Select **Off time** or **On time**.
- 3   Select **Repeat**.
- 4  Select **Off, Once, Daily, Mon.~Fri., Mon.~Sat., Weekend, or Sunday**.
- 5   Select and set **Hour** or **Minute**.
- 6  Return to the previous menu.
-  Return to TV viewing.

- To cancel **On/Off Time** function, select **Off**.
- Only for **On Time** function

- 1   Select **Input**.
- 2  Select the desired input source.
- 3   When Selecting **TV**: set the channel at turn-on.
- 4   Adjust to sound level at turn-on.

# SLEEP TIMER SETTING

The Sleep Time turns the TV off at the preset time.

Note that this setting is cleared when the TV is turned off.

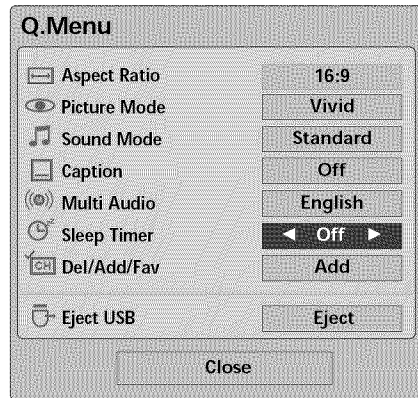

1   Select Sleep Timer.

2  Select Off, 10, 20, 30, 60, 90, 120, 180, or 240 minutes.

3  Return to TV viewing.

■ You can also adjust Sleep Timer in the TIME menu.

# PARENTAL CONTROL / RATINGS

Parental Control can be used to block specific channels, ratings and other viewing sources.

The Parental Control Function (V-Chip) is used to block program viewing based on the ratings sent by the broadcasting station. The default setting is to allow all programs to be viewed. Viewing can be blocked by choosing the type of the program and the categories. It is also possible to block all program viewing for a time period. To use this function, the following must be done :

1. Set ratings and categories to be blocked.
2. Specify a password
3. Enable the lock

## V-Chip rating and categories

Rating guidelines are provided by broadcasting stations. Most television programs and television movies can be blocked by TV Rating and/or Individual Categories. Movies that have been shown at the theaters or direct-to-video movies use the Movie Rating System (MPAA) only.

## Ratings for Television programs including made-for-TV movies :

- TV-G (General audience)
- TV-PG (Parental guidance suggested)
- TV-14 (Parents strongly cautioned)
- TV-MA (Mature audience only)
- TV-Y (All children)
- TV-Y7 (Children 7 years older)

## SET PASSWORD & LOCK SYSTEM

### Setting up Your Password

Set up blocking schemes to block specific channels, ratings, and external viewing sources. A password is required to gain access to this menu.

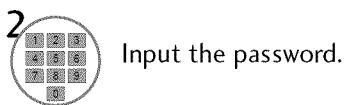
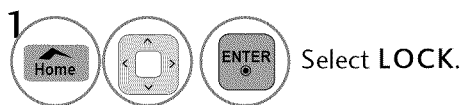
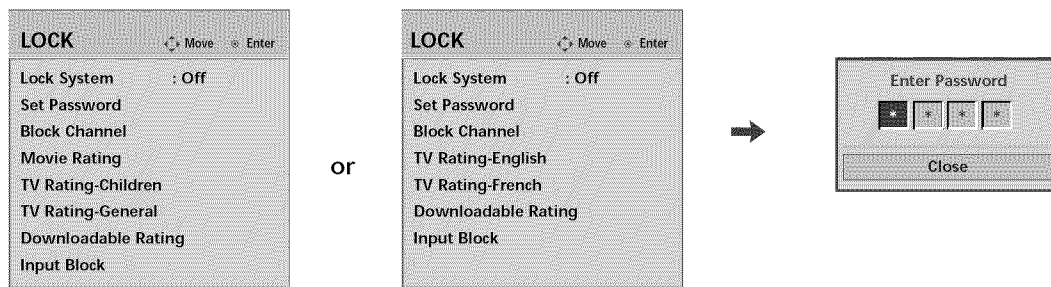



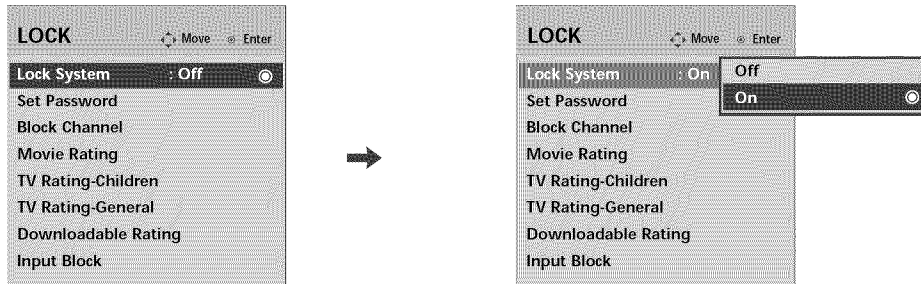

- Enter the password as requested.
- If you forgot your password, press "0-3-2-5" on the remote control.

# Lock System

Enables or disables the blocking scheme you set up previously.





1    Select **LOCK**.

2  Input the password.

3  Select **Lock System**.

4   Select **On** or **Off**.

5  Return to the previous menu.

 Return to TV viewing.



■ When you select **On**, the Lock System is enable.

# PARENTAL CONTROL / RATINGS

## Set Password

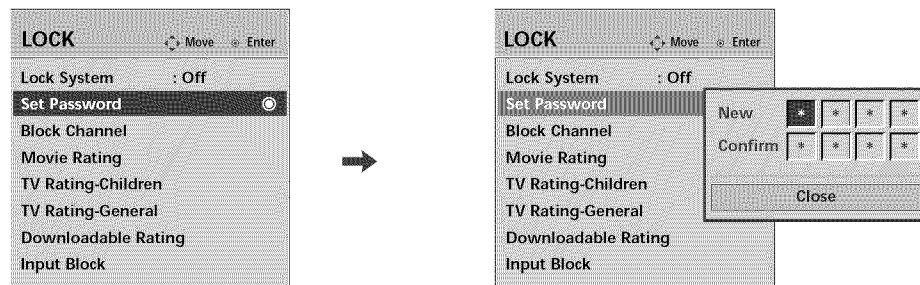
Change the password by inputting a new password twice.

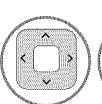

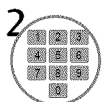

1    Select LOCK.

2  Input the password.

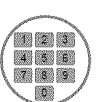
3  Select Set password.

4   Choose any 4 digits for your new password.  
As soon as the 4 digits are entered, re-enter the same 4 digits on the **Confirm**.



5  Return to the previous menu.

 Return to TV viewing.

# CHANNEL BLOCKING

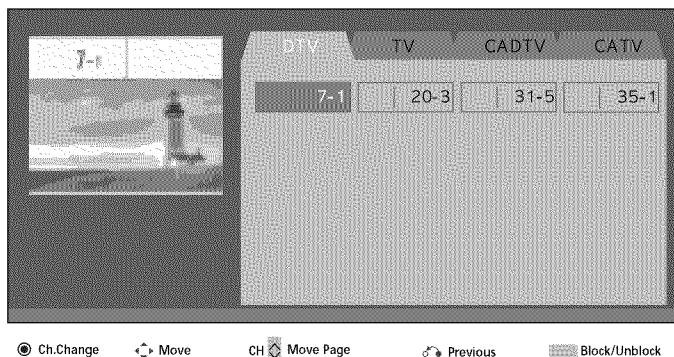

Blocks any channels that you do not want to watch or that you do not want your children to watch.





1    Select **LOCK**.

2  Input the password.

3  Select **Block Channel**.

4   Select a channel to block or unblock.

5  Block or unblock a channel.

6  Return to the previous menu.

 Return to TV viewing.

# PARENTAL CONTROL / RATINGS

## MOVIE & TV RATING

### Movie Rating (MPAA) - *Depending on model*

Blocks movies according to the movie ratings limits specified, so children cannot view certain movies. You can set the ratings limit by blocking out all the movies with the ratings above a specified level. Keep in mind that the movie ratings limit only applies to movies shown on TV, not TV programs, such as soap operas.

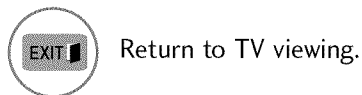
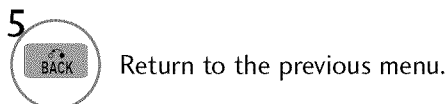
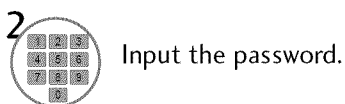
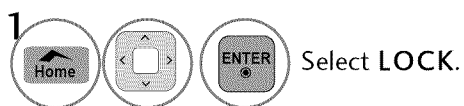
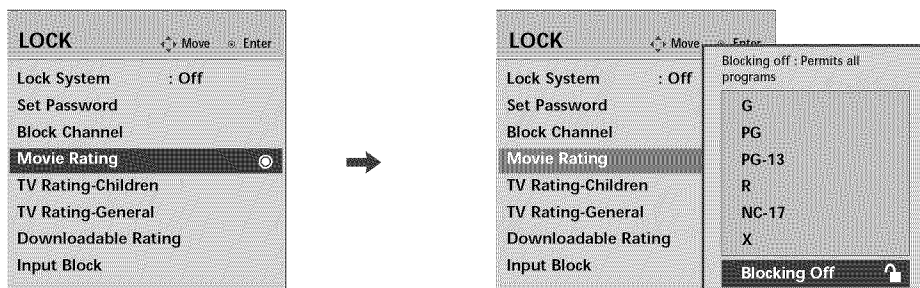









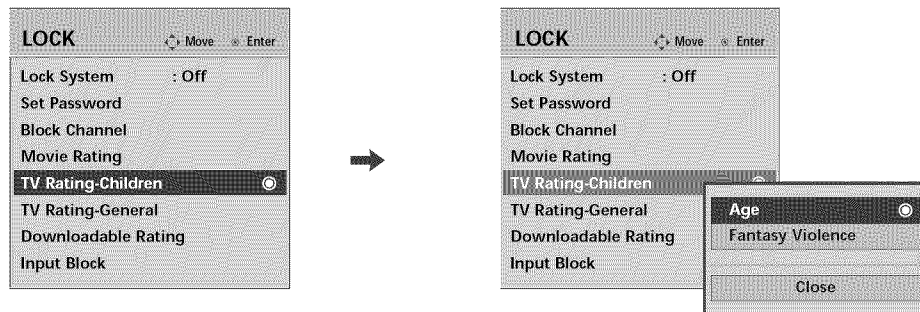



- G (General audience)
- PG (Parental guidance suggested)
- PG-13 (Parents strongly cautioned)
- R (Restricted)
- NC-17 (No one 17 and under admitted)
- X (Adult only)
- Blocking Off (Permits all programs)
- ▶ If you set PG-13: G and PG movies will be available, PG-13, R, NC-17 and X will be blocked.



## TV Rating Children - *Depending on model*

Prevents children from watching certain children's TV programs, according to the ratings limit set. The children rating does not apply to other TV programs. Unless you block certain TV programs intended for mature audiences in the TV Rating - sub menu, your children can view those programs.



- 1    Select **LOCK**.
- 2  Input the password.
- 3  Select **TV Rating-Children**.
- 4   Select **Age** or **Fantasy Violence**.
- 5   Select block options.
- 6  Return to the previous menu.
-  Return to TV viewing.









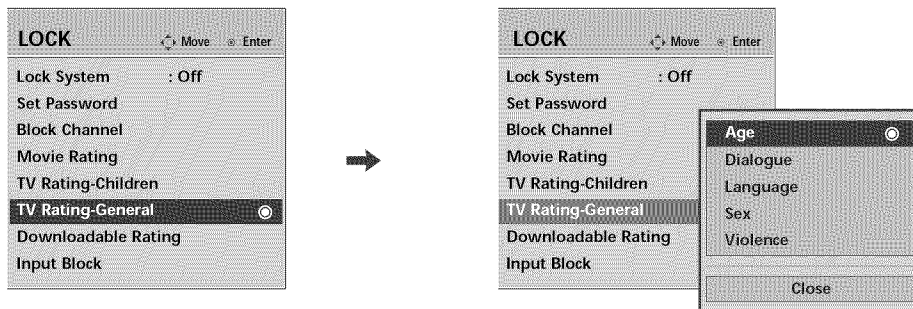

- Age (applies to TV-Y, TV-Y7)
- Fantasy Violence (applies to TV-Y7)

# PARENTAL CONTROL / RATINGS

## TV Rating General - Depending on model

Based on the ratings, blocks certain TV programs that you and your family do not want to view.







-    Select LOCK.
-  Input the password.
-  Select TV Rating-General.
-   Select Age, Dialogue, Language, Sex, or Violence.
-   Select block options.
-  Return to the previous menu.
-  Return to TV viewing.

- Age (applies to TV-G,TV-PG,TV-14,TV-MA).
- Dialogue-sexual dialogue (applies to TV-PG,TV-14).
- Language-adult language (applies to TV-PG, TV-14, TV-MA).
- Sex-sexual situations (applies to TV-PG, TV-14, TV-MA).
- Violence (applies to TV-PG, TV-14, TV-MA).

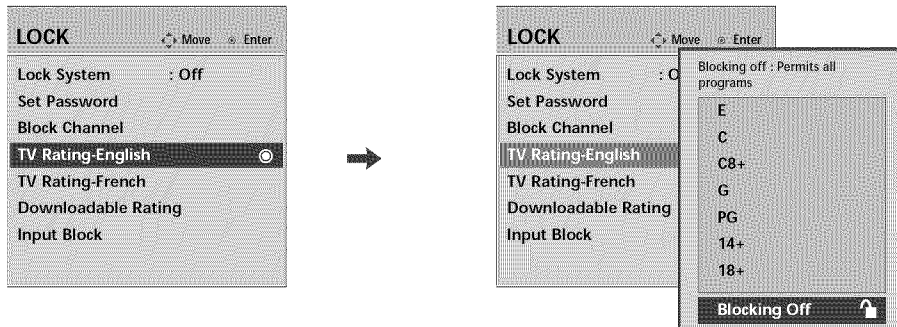
## TV Rating English - Depending on model



Selecting the English rating system.





1    Select LOCK.

2  Input the password.

3  Select TV Rating-English.

4   Select E, C, C8+, G, PG, 14+, 18+, or Blocking Off.

5  Return to the previous menu.

 Return to TV viewing.





- E (Exempt)
- C (Children)
- C8+ (Children eight years and older)
- G (General programming, suitable for all audiences)
- PG (Parental Guidance)
- 14+ (Viewers 14 years and older)
- 18+ (Adult programming)
- Blocking Off (Permits all programs)

# PARENTAL CONTROL / RATINGS

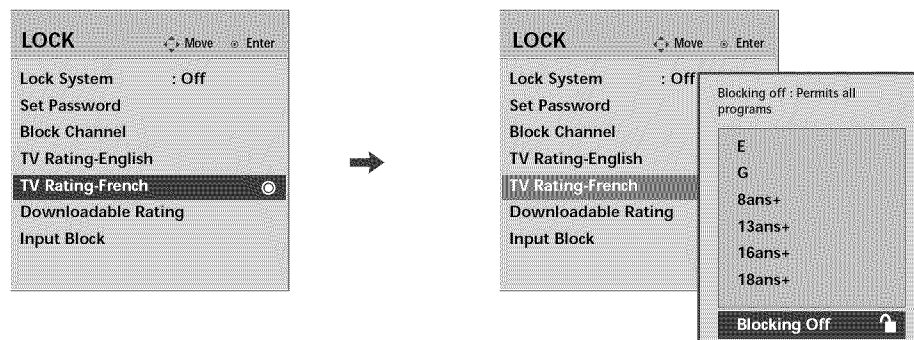
## TV Rating French - *Depending on model*

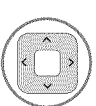
Selecting the Canadian French rating system.

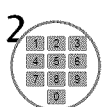
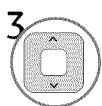

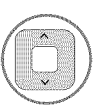
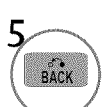
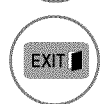
-    Select LOCK.
-  Input the password.
-  Select TV Rating-French.
-   Select E, G, 8ans+, 13ans+, 16ans+, 18ans+, or Blocking off.
-  Return to the previous menu.
-  Return to TV viewing.

- E (Exempt)
- G (General)
- 8ans+ (General-Not convenient for little children)
- 13ans+ (Not convenient for children of 13 years and younger)
- 16ans+ (Not convenient for children of 16 years and younger)
- 18ans+ (This programs is only for adults)
- Blocking off (Permits all programs)







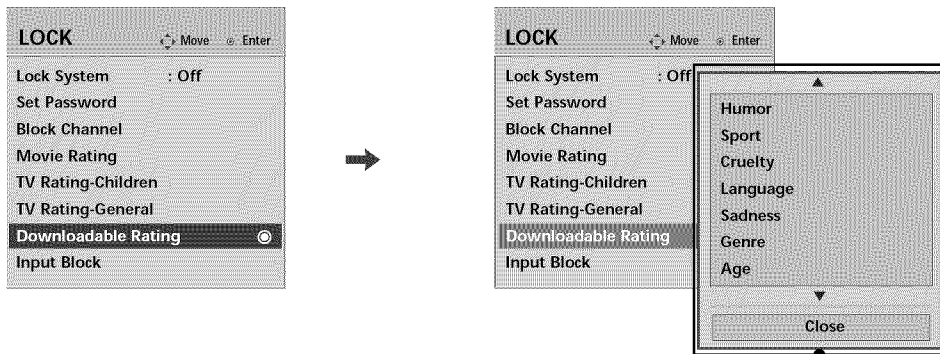



# DOWNLOADABLE RATING

This function is available only for digital channels.

This function operates only when TV has received Region5 Rating data.



■ Based on rating table, your TV's OSD (On Screen Display) may differ slightly from what is shown in this manual.









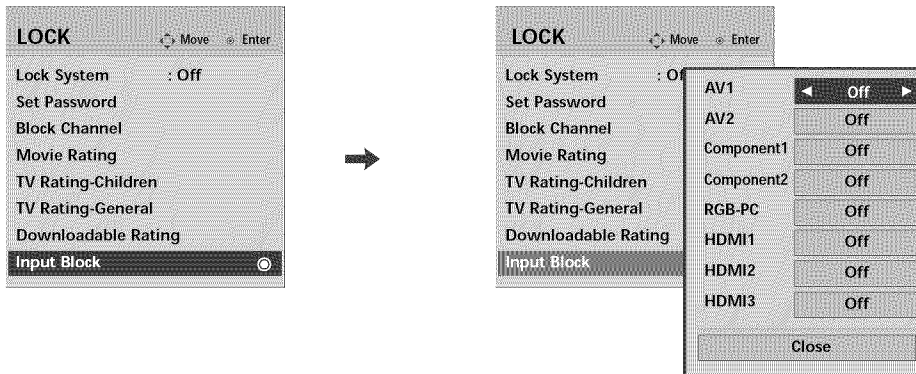

- 1    Select **LOCK**.
- 2  Input the password.
- 3  Select **Downloadable Rating**.
- 4   Select desired **Downloadable Rating** option.
- 5   Select desired option and block it.
- 6  Return to the previous menu.
-  Return to TV viewing.

# PARENTAL CONTROL / RATINGS

## EXTERNAL INPUT BLOCKING

Enables you to block an input.



-    Select **LOCK**.
-  Input the password.
-  Select **Input Block**.
-   Select input source.
-  Select **On** or **Off**.
-  Return to the previous menu.
-  Return to TV viewing.







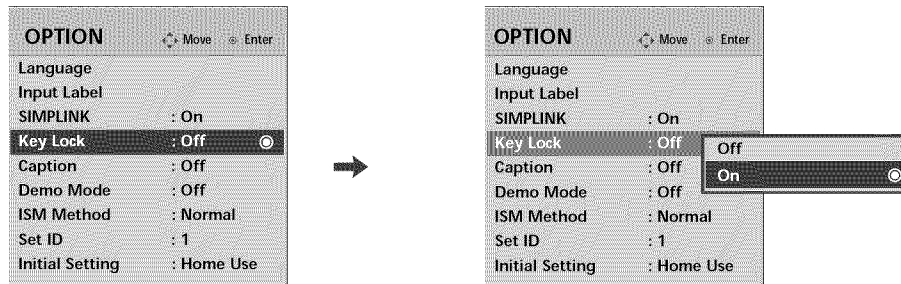

# KEY LOCK

The TV can be set up so that it can only be used with the remote control.

This feature can be used to prevent unauthorized viewing by locking out the front panel controls.

This TV is programmed to remember which option it was last set to even if you turn the TV off.



- 1   Select **OPTION**.
- 2   Select **Key Lock**.
- 3   Select **On** or **Off**.
- 4  Return to the previous menu.
-  Return to TV viewing.

- In **Key Lock 'On'**, if the TV is turned off, press the  $\phi/|$  (power), **INPUT**, **CH ^**, **CH v** button on the TV or **POWER**, **INPUT**, **CH ^**, **CH v** or **NUMBER** buttons on the remote control.
- With the **Key Lock On**, the display **'▲ Key Lock'** appears on the screen if any button (Except  $\phi/|$  (power) button) on the front panel is pressed while viewing the TV.

# APPENDIX

## TROUBLESHOOTING

Abnormal Operation	
The remote control doesn't work	<ul style="list-style-type: none"> <li>■ Check to see if there is any object between the product and the remote control causing obstruction. Ensure you are pointing the remote control directly at the TV.</li> <li>■ Ensure that the batteries are installed with correct polarity (+ to +, - to -).</li> <li>■ Ensure that the correct remote operating mode is set: TV, VCR etc.</li> <li>■ Install new batteries.</li> </ul> <p style="text-align: right;">*This feature is not available for all models.</p>
Power is suddenly turned off	<ul style="list-style-type: none"> <li>■ Is the sleep timer set?</li> <li>■ Check the power control settings. Power interrupted.</li> <li>■ TV will be automatically turned off, in case of no signal for 15 minutes.</li> </ul>

Video Problems	
No picture & No sound	<ul style="list-style-type: none"> <li>■ Check whether the product is turned on.</li> <li>■ Try another channel. The problem may be with the broadcast.</li> <li>■ Is the power cord inserted into wall power outlet?</li> <li>■ Check your antenna direction and/or location.</li> <li>■ Test the wall power outlet, plug another product's power cord into the outlet where the product's power cord was plugged in.</li> </ul>
Picture appears slowly after switching on	<ul style="list-style-type: none"> <li>■ This is normal, the image is muted during the product startup process. Please contact your service center, if the picture has not appeared after five minutes.</li> </ul>
No or poor color or poor picture	<ul style="list-style-type: none"> <li>■ Adjust Color in menu option.</li> <li>■ Keep a sufficient distance between the product and the VCR.</li> <li>■ Try another channel. The problem may be with the broadcast.</li> <li>■ Are the video cables installed properly?</li> <li>■ Activate any function to restore the brightness of the picture.</li> </ul>
Horizontal/vertical bars or picture shaking	<ul style="list-style-type: none"> <li>■ Check for local interference such as an electrical appliance or power tool.</li> </ul>
Poor reception on some channels	<ul style="list-style-type: none"> <li>■ Station or cable product experiencing problems, tune to another station.</li> <li>■ Station signal is weak, reorient antenna to receive weaker station.</li> <li>■ Check for sources of possible interference.</li> </ul>
Lines or streaks in pictures	<ul style="list-style-type: none"> <li>■ Check antenna (Change the direction of the antenna).</li> </ul>
No picture when connecting HDMI	<ul style="list-style-type: none"> <li>■ If an HDMI cable doesn't support High Speed HDM, it can cause flickers or no screen display. In this case use the latest cables that support High Speed HDMI.</li> </ul>



## Audio Problems

Picture OK & No sound	<ul style="list-style-type: none"><li>■ Press the VOL or VOLUME button.</li><li>■ Sound muted? Press MUTE button.</li><li>■ Try another channel. The problem may be with the broadcast.</li><li>■ Are the audio cables installed properly?</li></ul>
No output from one of the speakers	<ul style="list-style-type: none"><li>■ Adjust Balance in menu option.</li></ul>
Unusual sound from inside the product	<ul style="list-style-type: none"><li>■ A change in ambient humidity or temperature may result in an unusual noise when the product is turned on or off and does not indicate a fault with the product.</li></ul>
No sound when connecting HDMI/USB	<ul style="list-style-type: none"><li>■ Check High Speed HDMI cable.</li><li>■ Check USB cable over version 2.0.</li><li>■ Use normal MP3 file.</li></ul> <p style="text-align: right;">*This feature is not available for all models.</p>

## PC Mode Problems

The signal is out of range	<ul style="list-style-type: none"><li>■ Adjust resolution, horizontal frequency, or vertical frequency.</li><li>■ Check the input source.</li></ul>
Vertical bar or stripe on background & Horizontal Noise & Incorrect position	<ul style="list-style-type: none"><li>■ Work the Auto configure or adjust clock, phase, or H/V position. (Option)</li></ul>
Screen color is unstable or single color	<ul style="list-style-type: none"><li>■ Check the signal cable.</li><li>■ Reinstall the PC video card.</li></ul>

## Movie List Problems

The file does not appear on the Movie List.	<ul style="list-style-type: none"><li>■ Check whether the file extension is supported.</li></ul>
Message is displayed saying "This file is invalid" or the audio is working normally but the video is not working normally.	<ul style="list-style-type: none"><li>■ Check whether the file is playing normally on a PC. (Check whether the file is damaged.)</li><li>■ Check whether the resolution is supported.</li><li>■ Check whether the video/audio codec is supported.</li><li>■ Check whether the frame rate is supported.</li></ul>
Message is displayed saying "Unsupported Audio" or the video is working normally but the audio is not working normally.	<ul style="list-style-type: none"><li>■ Check whether the file is playing normally on a PC. (Check whether the file is damaged.)</li><li>■ Check whether the audio codec is supported.</li><li>■ Check whether the bit rate is supported.</li><li>■ Check whether the sample rate is supported.</li></ul>
Subtitle is not working.	<ul style="list-style-type: none"><li>■ Check whether the file is playing normally on a PC. (Check whether the file is damaged.)</li><li>■ Check whether the video file and subtitle file name are the same.</li><li>■ Check whether the video file and subtitle file are located in the same folder.</li><li>■ Check whether the subtitle file is supported.</li><li>■ Check whether the language is supported. (When you open the subtitle file on a PC, you can check the language of the subtitle file.)</li></ul>

## MAINTENANCE

Early malfunctions can be prevented. Careful and regular cleaning can extend the amount of time you can enjoy your new TV.

**Caution:** Be sure to turn the power off and unplug the power cord before you begin any cleaning.

### Cleaning the Screen

- 1 Here's a great way to keep the dust off your screen for a while. Wet a soft cloth in a mixture of lukewarm water and a little fabric softener or dish washing detergent. Wring the cloth until it's almost dry, and then use it to wipe the screen.
- 2 Make sure the excess water is off the screen, and then let it air-dry before you turn on your TV.

### Cleaning the Cabinet

- To remove dirt or dust, wipe the cabinet with a soft, dry, lint-free cloth.
- Please be sure not to use a wet cloth.

### Extended Absence

#### ⚠ CAUTION

- ▶ If you expect to leave your TV dormant for a long time (such as a vacation), it's a good idea to unplug the power cord to protect against possible damage from lightning or power surges.

## PRODUCT SPECIFICATIONS

MODEL		42PT200 (42PT200-UB) 42PT250U (42PT250U-UA)	50PT200 (50PT200-UB) 50PT250U (50PT250U-UA)
Dimensions (Width x Height x Depth)	With stand	9876 mm x 662.8 mm x 230.5 mm (38.8 inch x 26 inch x 9 inch)	1171.9mm x 770.9 mm x 289.8 mm (46.1 inch x 30.3 inch x 11.4 inch)
	Without stand	9876 mm x 608.9 mm x 52.5 mm (38.8 inch x 23.9 inch x 2 inch)	1171.9 mm x 712.2 mm x 52.5 mm (46.1 inch x 28 inch x 2 inch)
Weight	With stand	21.4 kg (471 lb)	29.5 kg (65 lb)
	Without stand	19.9 kg (43.8 lb)	272 kg (59.6 lb)
Current Value / Power consumption		2.1 A / 210 W	3.0 A / 300 W

MODEL		42PT330 (42PT330-UB) 42PT350 (42PT350-UD) 42PT350C (42PT350C-UD)	50PT330 (50PT330-UB) 50PT350 (50PT350-UD) 50PT350C (50PT350C-UD)
Dimensions (Width x Height x Depth)	With stand	991.8 mm x 667 mm x 230.5 mm (39 inch x 26.2 inch x 9 inch)	1176.1 mm x 774.7 mm x 289.8 mm (46.3 inch x 30.5 inch x 11.4 inch)
	Without stand	991.8 mm x 613.8 mm x 52.5 mm (39 inch x 24.1 inch x 2 inch)	1176.1 mm x 716.5 mm x 52.5 mm (46.3 inch x 28.2 inch x 2 inch)
Weight	With stand	21.5 kg (47.3 lb)	29.6 kg (65.2 lb)
	Without stand	20 kg (44 lb)	27.3 kg (60.1 lb)
Current Value / Power consumption		2.1 A / 210 W	3.0 A / 300 W
MODEL		50PV400 (50PV400-UB) 50PV430 (50PV430-UC) 50PV450 (50PV450-UA) 50PV450C (50PV450C-UA)	60PV400 (60PV400-UB) 60PV430 (60PV430-UC) 60PV450 (60PV450-UA) 60PV450C (60PV450C-UA)
Dimensions (Width x Height x Depth)	With stand	1168.4 mm x 770.9 mm x 289.8 mm (46 inch x 30.3 inch x 11.4 inch)	1387.4 mm x 905.2 mm x 334.7 mm (54.6 inch x 35.6 inch x 13.1 inch)
	Without stand	1168.4 mm x 712.2 mm x 52.5 mm (46 inch x 28 inch x 2 inch)	1387.4 mm x 834.7 mm x 52.5 mm (54.6 inch x 32.8 inch x 2.6 inch)
Weight	With stand	29.6 kg (65.2 lb)	42.6 kg (93.9 lb)
	Without stand	27.3 kg (60.1 lb)	38.5 kg (84.8 lb)
Current Value / Power consumption		3.3 A / 300 W	4.6 A / 460 W
MODEL		50PV550U (50PV550U-UC)	60PV550U (60PV550U-UC)
Dimensions (Width x Height x Depth)	With stand	1172.3 mm x 770.9 mm x 289.8 mm (46.1 inch x 30.3 inch x 11.4 inch)	1390.4 mm x 905.2 mm x 334.7 mm (54.7 inch x 35.6 inch x 13.1 inch)
	Without stand	1172.3 mm x 712.2 mm x 52.5 mm (46.1 inch x 28 inch x 2 inch)	1390.4 mm x 835.5 mm x 52.5 mm (54.7 inch x 32.8 inch x 2 inch)
Weight	With stand	29.8 kg (65.6 lb)	42.6 kg (93.9 lb)
	Without stand	27.5 kg (60.6 lb)	38.5 kg (84.8 lb)
Current Value / Power consumption		3.3 A / 300 W	4.6 A / 460 W
Power requirement Television System Program Coverage External Antenna Impedance		AC 100-240 V ~ 50/60 Hz NTSC-M, ATSC, 64 & 256 QAM VHF 2-13, UHF 14-69, CATV 1-135, DTV 2-69, CADTV 1-135 75 Ω	
Environment condition	Operating Temperature Operating Humidity	32 - 104 °F (0 - 40 °C) Less than 80%	
	Storage Temperature Storage Humidity	-4 - 140 °F (-20 - 60 °C) Less than 85%	

■ The specifications shown above may be changed without prior notice for quality improvement.

# APPENDIX

## IR CODES

(This feature is not available for all models.)

### 1. How to Connect

- Connect your wired remote control to the Remote Control port on the TV.

### 2. Remote Control IR Codes

#### Output waveform

Single pulse, modulated with 37.917KHz signal at 455KHz

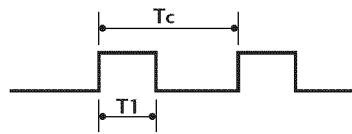

Carrier frequency  
 $FCAR = 1/TC = fOSC/12$   
 Duty ratio =  $T1/TC = 1/3$

#### Configuration of frame

1st frame

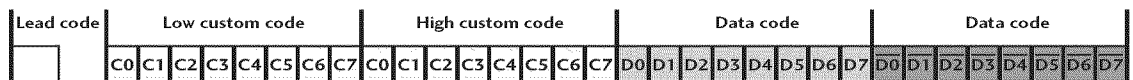

Repeat frame

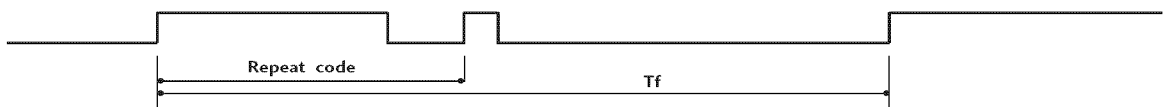

#### Lead code

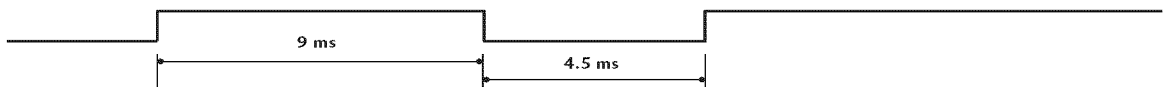

#### Repeat code

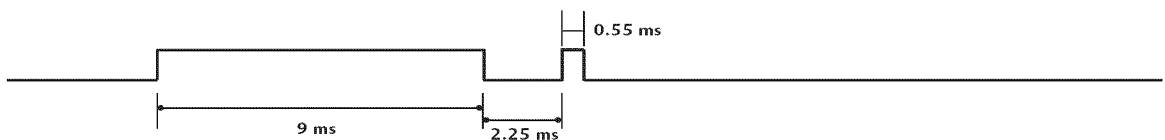

#### Bit description

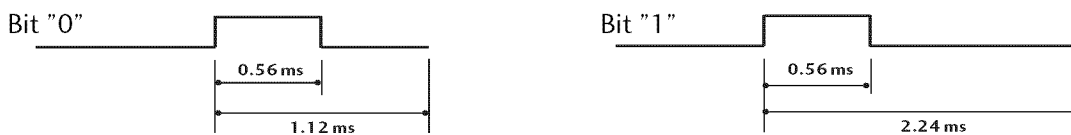

#### Frame interval: Tf

The waveform is transmitted as long as a key is depressed.

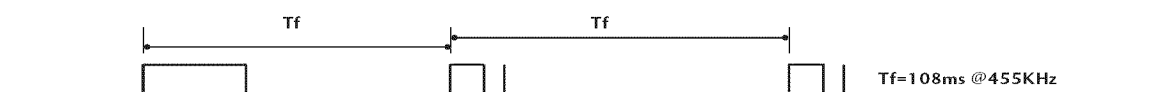

Code (Hexa)	Function	Note	Code (Hexa)	Function	Note
08	POWER	Remote control Button (Power On/Off)	D6	TV	Discrete IR Code
45	Q.MENU	Remote control Button			(TV Input Selection)
43	HOME	Remote control Button	C4	POWER ON	Discrete IR Code
0B	INPUT	Remote control Button			(Only Power On)
10-19	Number Key 0-9	Remote control Button	C5	POWER OFF	Discrete IR Code
4C	- LIST	Remote control Button			(Only Power Off)
1A	FLASHBK	Remote control Button	5A	AV1	Discrete IR Code
09	MUTE	Remote control Button			(AV1 Input Selection)
02	VOL +	Remote control Button	D0	AV2	Discrete IR Code
03	VOL -	Remote control Button			(AV2 Input Selection)
00	CH ^	Remote control Button	BF	COMPONENT1	Discrete IR Code
01	CH v	Remote control Button			(Component1 Input Selection)
1E	FAV/MARK	Remote control Button	D4	COMPONENT2	Discrete IR Code
40	^	Remote control Button			(Component2 Input Selection)
41	v	Remote control Button	D5	RGB-PC	Discrete IR Code
07	<	Remote control Button			(RGB-PC Input Selection)
06	>	Remote control Button	CE	HDMI1	Discrete IR Code
44	ENTER	Remote control Button			(HDMI1 Input Selection)
28	BACK	Remote control Button	CC	HDMI2	Discrete IR Code
7E	SIMPLINK	Remote control Button			(HDMI2 Input Selection)
30	AV MODE	Remote control Button	E9	HDMI3	Discrete IR Code
79	RATIO	Remote control Button			(HDMI3 Input Selection)
BA	Pause <b>II</b> (FREEZE)	Remote control Button	76	Ratio 4:3	Discrete IR Code
95	ENERGY SAVING	Remote control Button			(Only 4:3 Mode)
AA	INFO	Remote control Button	77	Ratio 16:9	Discrete IR Code
72	RED	Remote control Button			(Only 16:9 Mode)
71	GREEN	Remote control Button	AF	Ratio Zoom	Discrete IR Code
63	YELLOW	Remote control Button			(Only Zoom1 Mode)
61	BLUE	Remote control Button			
8E	FF <b>▶▶</b>	Remote control Button			
8F	Rew <b>◀◀</b>	Remote control Button			
0F	TV	Remote control Button			
5B	EXIT	Remote control Button			
B1	Stop <b>■</b>	Remote control Button			
B0	Play <b>▶</b>	Remote control Button			

## EXTERNAL CONTROL THROUGH RS-232C

The RS-232C port allows you connect the RS-232C input jack to an external control device (such as a computer or an A/V control system) to control the TV's functions externally.

- Note: RS-232C on this unit is intended to be used with third party RS-232C control hardware and software. The instructions below are provided to help with programming software or to test functionality using telenet software.

### RS-232C Setup

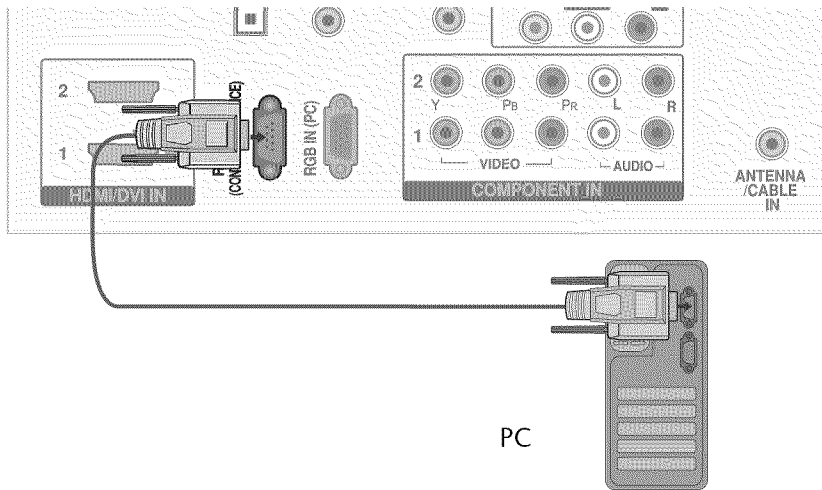

### Type of Connector; D-Sub 9-Pin Male

No.	Pin Name
1	No connection
2	RXD (Receive data)
3	TXD (Transmit data)
4	DTR (DTE side ready)
5	GND
6	DSR (DCE side ready)
7	RTS (Ready to send)
8	CTS (Clear to send)
9	No Connection

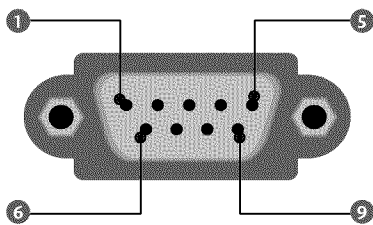

### Communication Parameters

- Baud rate : 9600 bps (UART)
- Data length : 8 bits
- Parity : None
- Stop bit : 1 bit
- Communication code : ASCII code
- Use a crossed (reverse) cable.

## RS-232C Configurations

Either cable below can be used.

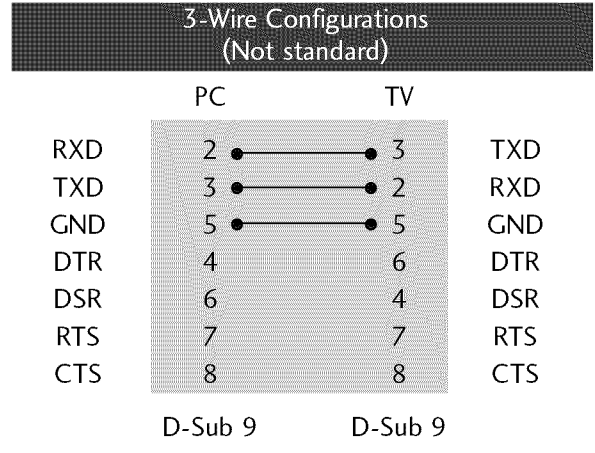
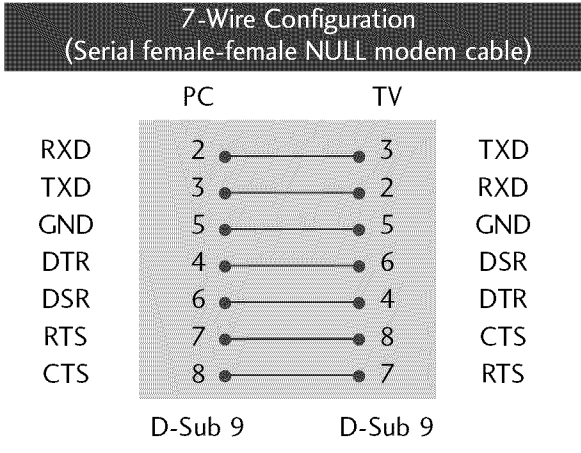

## Set ID

Use this function to specify a TV ID number.  
Refer to 'Real Data Mapping'.

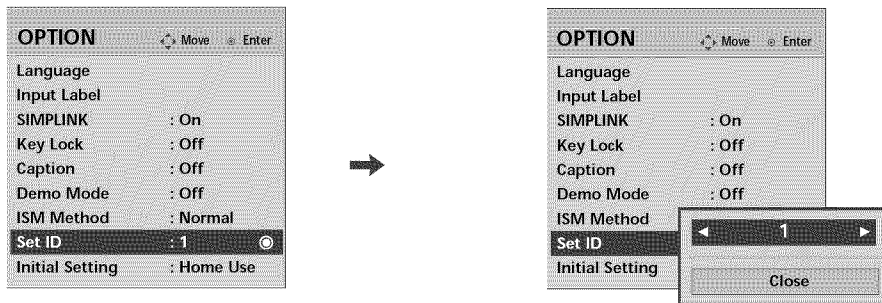

- 1 Select **OPTION**.
- 2 Select **Set ID**.
- 3 Choose the desired TV ID number.  
The adjustment range of Set ID is 1~99.
- 4 Return to the previous menu.
- Return to TV viewing.

\*Real data mapping

0 : Step 0  
⋮  
A : Step 10 (SET ID 10)  
⋮  
F : Step 15 (SET ID 15)  
10 : Step 16 (SET ID 16)  
⋮  
63 : Step 99 (SET ID 99)  
64 : Step 100

## Command Reference List

	COMMAND1	COMMAND2	DATA (Hexadecimal)		COMMAND1	COMMAND2	DATA (Hexadecimal)
01. Power	k	a	00 - 01	13. Remote Control Lock Mode	k	m	00 - 01
02. Input Select	x	b	(▶ p.121)	14. Treble	k	r	00 - 64
03. Aspect Ratio	k	c	(▶ p.121)	15. Bass	k	s	00 - 64
04. Screen Mute	k	d	00 - 01	16. Balance	k	t	00 - 64
05. Volume Mute	k	e	00 - 01	17. Color Temperature	x	u	00 - 64
06. Volume Control	k	f	00 - 64	18. ISM Method	j	p	(▶ p.122)
07. Contrast	k	g	00 - 64	19. Power Saving	j	q	00 - 01
08. Brightness	k	h	00 - 64	20. Auto Configuration	j	u	(▶ p.122)
09. Color	k	i	00 - 64	22. Channel Add/Del	m	b	00 - 01
10. Tint	k	j	00 - 64	23. Key	m	c	(▶ p.123)
11. Sharpness	k	k	00 - 64				
12. OSD Select	k	l	00 - 01				

	COMMAND1	COMMAND2	DATA00 (Hexadecimal)	DATA01 (Hexadecimal)	DATA02 (Hexadecimal)	DATA03 (Hexadecimal)	DATA04 (Hexadecimal)	DATA05 (Hexadecimal)
21. Channel Tuning	m	a	physical program high	major program low	major low	minor high	minor low	attribute

## Transmission / Receiving Protocol

### Transmission

**[Command1][Command2][ ][Set ID][ ][Data][Cr]**

[Command 1] : First command to control the set.(j, k, m or x)

[Command 2] : Second command to control the set.

[Set ID] : You can adjust the set ID to choose desired TV ID number in Setup menu. Adjustment range is 1~99. When selecting Set ID '0', every connected the TV is controlled. Set ID is indicated as decimal (1~99) on menu and as Hexa decimal (0x0~0x63) on transmission /receiving protocol.

[DATA] : To transmit the command data.

Transmit the 'FF' data to read status of command.

[Cr] : Carriage Return

ASCII code '0x0D'

[ ] : ASCII code 'space (0x20)'

\* In this model, TV will not send the status during the standby mode.

### OK Acknowledgement

**[Command2][ ][Set ID][ ][OK][Data][x]**

The TV transmits ACK (acknowledgement) based on this format when receiving normal data. At this time, if the data is data read mode, it indicates present status data. If the data is data write mode, it returns the data of the PC computer.

\* In this model, TV will not send the status during the standby mode.

\* Data Format

[Command 2] : Use as command.

[Set ID] : Use the small character, if set ID is 10, it will send the '0', 'a'.

[DATA] : Use the small character, if data is 0 x ab, it will send the 'a', 'b'.

[OK] : Use the large character.

### Error Acknowledgement

**[Command2][ ][Set ID][ ][NG][Data][x]**

The TV transmits ACK (acknowledgement) based on this format when receiving abnormal data from non-viable functions or communication errors.

Data1: Illegal Code

Data2: Not supported function

Data3: Wait more time

\* In this model, TV will not send the status during the standby mode.

\* Data Format

[Command 2] : Use as command.

[Set ID] : Use the small character, if set ID is 10, it will send the '0', 'a'.

[DATA] : Use the small character, if data is 0 x ab, it will send the 'a', 'b'.

[NG] : Use the large character



**01. Power (Command: k a)**

To control Power On/Off of the TV.

*Transmission* [k][a][ ][Set ID][ ][Data][Cr]

Data 00: Power Off      Data 01: Power On

*Acknowledgement* [a][ ][Set ID][ ][OK/NG][Data][x]

\* In a like manner, if other functions transmit 'FF' data based on this format, Acknowledgement data feedback presents status about each function.

\* Note: In this model, TV will send the Acknowledge after power on processing completion.

There might be a time delay between command and acknowledge.

**02. Input Select (Command: x b)**

To select input source for TV.

*Transmission* [x][b][ ][Set ID][ ][Data][Cr]

Data 00: DTV (Antenna)      Data 01: DTV (Cable)

Data 10: Analog (Antenna)      Data 11: Analog (Cable)

Data 20: AV1      Data 21: AV2

Data 40: Component 1      Data 41: Component 2

Data 60: RGB-PC      Data 90: HDMI1

Data 91: HDMI2      Data 92: HDMI3

*Acknowledgement* [b][ ][Set ID][ ][OK/NG][Data][x]

**03. Aspect Ratio (Command: k c)**

To adjust the screen format.

*Transmission* [k][c][ ][Set ID][ ][Data][Cr]

Data 01: 4:3      09: Just scan  
02: 16:9      10: Cinema Zoom (1)  
04: Zoom  
06: Set by program      1f: Cinema Zoom (16)

*Acknowledgement* [c][ ][Set ID][ ][OK/NG][Data][x]

**04. Screen Mute (Command: k d)**

To select screen mute on/off.

*Transmission* [k][d][ ][Set ID][ ][Data][Cr]

Data 00: Screen mute off (Picture on), Video-Out Mute Off

Data 01: Screen mute on (Picture off)

Data 10: Video-Out Mute On

*Acknowledgement* [d][ ][Set ID][ ][OK/NG][Data][x]

\* In case of Video-Out mute on only, TV will display On Screen Display(OSD). But, In case of Screen Mute On, TV will not display OSD.

**05. Volume Mute (Command: k e)**

To control volume mute on/off.

You can also adjust mute using the MUTE button on remote control.

*Transmission* [k][e][ ][Set ID][ ][Data][Cr]

Data 00: Volume mute on (Volume off)

Data 01: Volume mute off (Volume on)

*Acknowledgement* [e][ ][Set ID][ ][OK/NG][Data][x]

**06. Volume Control (Command: k f)**

To adjust volume.

You can also adjust volume with the volume buttons on remote control.

*Transmission* [k][f][ ][Set ID][ ][Data][Cr]

Data Min: 00 ~ Max: 64 (\*transmit by Hexadecimal code)

\*Refer to 'Real data mapping'.

*Acknowledgement* [f][ ][Set ID][ ][OK/NG][Data][x]

**07. Contrast (Command: k g)**

To adjust screen contrast.

You can also adjust contrast in the PICTURE menu.

*Transmission* [k][g][ ][Set ID][ ][Data][Cr]

Data Min: 00 ~ Max: 64 (\*transmit by Hexadecimal code)

\*Refer to 'Real data mapping'.

*Acknowledgement* [g][ ][Set ID][ ][OK/NG][Data][x]

**08. Brightness (Command: k h)**

To adjust screen brightness.

You can also adjust brightness in the PICTURE menu.

*Transmission* [k][h][ ][Set ID][ ][Data][Cr]

Data Min: 00 ~ Max: 64 (\*transmit by Hexadecimal code)

\*Refer to 'Real data mapping'.

*Acknowledgement* [h][ ][Set ID][ ][OK/NG][Data][x]

**09. Color (Command: k i)**

To adjust screen color.

You can also adjust color in the PICTURE menu.

*Transmission* [k][i][ ][Set ID][ ][Data][Cr]

Data Min: 00 ~ Max: 64 (\*transmit by Hexadecimal code)

\*Refer to 'Real data mapping'.

*Acknowledgement* [i][ ][Set ID][ ][OK/NG][Data][x]

**10. Tint (Command: k j)**

To adjust screen tint.

You can also adjust tint in the PICTURE menu.

*Transmission* [k][j][ ][Set ID][ ][Data][Cr]

Data Red: 00 ~ Green: 64 (\*transmit by Hexadecimal code)

\*Refer to 'Real data mapping'.

*Acknowledgement* [j][ ][Set ID][ ][OK/NG][Data][x]

**11. Sharpness (Command: k k)**

To adjust screen sharpness.

You can also adjust sharpness in the PICTURE menu.

*Transmission* [k][k][ ][Set ID][ ][Data][Cr]

Data Min: 00 ~ Max: 64 (\*transmit by Hexadecimal code)

\*Refer to 'Real data mapping'.

*Acknowledgement* [k][ ][Set ID][ ][OK/NG][Data][x]

## 12. OSD Select (Command: k l)

To select OSD (On Screen Display) on/off.

*Transmission* [k][l][ ][Set ID][ ][Data][Cr]

Data 00: OSD off                      Data 01: OSD on

*Acknowledgement* [l][ ][Set ID][ ][OK/NG][Data][x]

## 13. Remote Control Lock Mode (Command: k m)

To lock the remote control and the front panel controls on the TV.

*Transmission* [k][m][ ][Set ID][ ][Data][Cr]

Data 00: Lock off                      Data 01: Lock on

*Acknowledgement* [m][ ][Set ID][ ][OK/NG][Data][x]

If you're not using the remote control and front panel controls on the TV, use this mode. When main power is on/off, remote control lock is released.

## 14. Treble (Command: k r)

To adjust treble.

You can also adjust treble in the AUDIO menu.

*Transmission* [k][r][ ][Set ID][ ][Data][Cr]

Data Min: 00 ~ Max: 64 (\*transmit by Hexadecimal code)

\*Refer to 'Real data mapping'.

*Acknowledgement* [r][ ][Set ID][ ][OK/NG][Data][x]

## 15. Bass (Command: k s)

To adjust bass.

You can also adjust bass in the AUDIO menu.

*Transmission* [k][s][ ][Set ID][ ][Data][Cr]

Data Min: 00 ~ Max: 64 (\*transmit by Hexadecimal code)

\*Refer to 'Real data mapping'.

*Acknowledgement* [s][ ][Set ID][ ][OK/NG][Data][x]

## 16. Balance (Command: k t)

To adjust balance.

You can also adjust balance in the AUDIO menu.

*Transmission* [k][t][ ][Set ID][ ][Data][Cr]

Data Min: 00 ~ Max: 64 (\*transmit by Hexadecimal code)

\*Refer to 'Real data mapping'.

*Acknowledgement* [t][ ][Set ID][ ][OK/NG][Data][x]

## 17. Color Temperature (Command: x u)

To adjust color temperature.

You can also adjust color temperature in the PICTURE menu.

*Transmission* [x][u][ ][Set ID][ ][Data][Cr]

Data Min: 00 ~ Max: 64 (\*transmit by Hexadecimal code)

\*Refer to 'Real data mapping'.

*Acknowledgement* [u][ ][Set ID][ ][OK/NG][Data][x]

## 18. ISM Method (Command: j p)

To avoid having a fixed image remain on screen.

*Transmission* [j][p][ ][Set ID][ ][Data][Cr]

Data 02: Orbiter                      04: White Wash

08: Normal                              20: Color Wash

*Acknowledgement* [p][ ][Set ID][ ][OK/NG][Data][x]

## 19. Energy saving (Command: j q)

To control the low energy function on/off.

*Transmission* [j][q][ ][Set ID][ ][Data][Cr]

Data 00: Energy Saving off

01: Energy Saving: Minimum

02: Energy Saving: Medium

03: Energy Saving: Maximum

05: Screen Off

10: Intelligent Sensor

*Acknowledgement* [q][ ][Set ID][ ][OK/NG][Data][x]

## 20. Auto Configuration (Command: j u)

To adjust picture position and minimize image shaking automatically. Auto configuration only works in RGB-PC mode.

*Transmission* [j][u][ ][Set ID][ ][Data][Cr]

Data 1: To set

*Acknowledgement* [u][ ][Set ID][ ][OK/NG][Data][x]

## 21. Channel Tuning (Command: m a)

To tune channel to following physical/major/minor number.

*Transmission* [m][a][ ][Set ID][ ][Data00][ ][Data01]

[ ][Data02][ ][Data03][ ][Data04][ ][Data05][Cr]

Digital channels have a Physical, Major, and Minor channel number. The Physical number is the actual digital channel number, the Major is the number that the channel should be mapped to, and the Minor is the sub-channel. Since the ATSC tuner automatically maps the channel to the Major number, the Physical number is not required when sending a command.

Data 00: Physical Channel Number

NTSC air: 02~45, NTSC cable: 01, 0E~7D

ATSC air: 01~45, ATSC cable: 01~87

Data 01 & 02: Major Channel Number

Data 01: High byte                      Data 02: Low byte

Two bytes are available for the Major and Minor, normally only the second byte is used.

Data 03 & 04: Minor Channel Number

Not needed for NTSC.

Data 05:

7	Main/Sub Picture	6	Two/One Part Channel	5	Using Physical Channel	4	Reserved	3	2	1	0	Step
0	Main	0	Two	0	Use	x		0	0	0	0	NTSC Air
1	Sub	1	One	1	No Use	x		0	0	0	1	NTSC Cable
						x		0	0	1	0	ATSC Air
						x		0	0	1	1	ATSC Cable_std
						x		0	1	0	0	ATSC Cable_hrc
						x		0	1	0	1	ATSC Cable_irc
						x		0	1	1	0	ATSC cable_auto
						x		0	1	1	1	Reserved
						x		x	x	x	x	...
						x		1	1	1	1	Reserved

The table above lists the binary code which must be converted to Hexadecimal before sending. For example: The binary code to tune the sub source to an NTSC cable channel is "1000 0001", which translates to "81" in Hex.

- \* 7th bit : For which source do you want to change the channel.
- \* 6th bit: Use a two part or one part channel. Most cases just use 0 since it's ignored when using NTSC.
- \* 5th bit: Use 0 with NTSC since it can only use the physical channel number. Normally use 1 for ATSC since most times it doesn't matter what the physical number is.
- \* 4th bit: Set to 0.
- \* 3-0 bits: Choose signal type.

\* Tune Command Examples:

1. Tune to the analog (NTSC) cable channel 35.

Data 00 = Physical of 35 = 23  
 Data 01 & 02 = No Major = 00 00  
 Data 03 & 04 = No Minor = 00 00  
 Data 05 = 0000 0001 in binary = 01  
 Total = ma 00 23 00 00 00 00 01

2. Tune to the digital (ATSC) local channel 30-3.

Data 00 = Don't know Physical = 00  
 Data 01 & 02 = Major is 30 = 00 1E  
 Data 03 & 04 = Minor is 3 = 00 03  
 Data 05 = 0010 0010 in binary = 22  
 Total = ma 00 00 00 1E 00 03 22

```
Acknowledgement[a][ ][Set ID][ ][OK][Data00][Data01]
[Data02][Data03][Data04][x][a][ ][Set ID]
[ ][NG][Data00][x]
```

22. Channel Add/Del (Command: m b)

To add and delete the channels.

Transmission [m][b][ ][Set ID][ ][Data][Cr]

Data 00: Channel Delete    Data 01: Channel Add

Acknowledgement [b][ ][Set ID][ ][OK/NG][Data][x]

23. Key (Command: m c)

To send IR remote key code.

Transmission [m][c][ ][Set ID][ ][Data][Cr]

► p.117.

Acknowledgement [c][ ][Set ID][ ][OK/NG][Data][x]



The model and serial number of the TV is located on the back and one side of the TV.  
Record it below should you ever need service.

MODEL \_\_\_\_\_

SERIAL \_\_\_\_\_