

DISHWASHER USE AND CARE MANUAL

For use with models: ED24, ID24, MDH24, MDV24, PD24

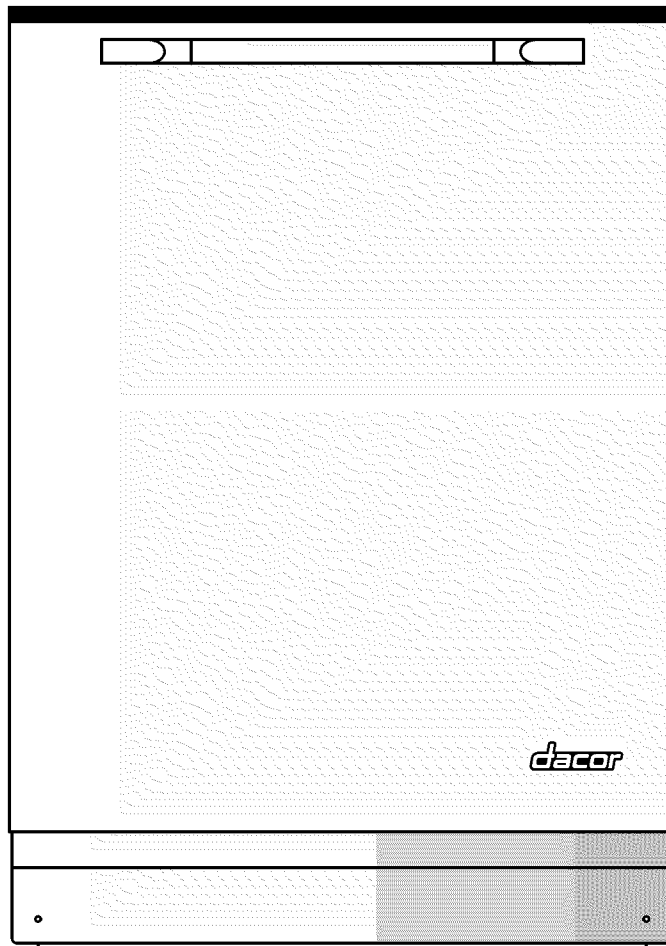

Style varies, model ED24 shown.

READ AND SAVE THESE INSTRUCTIONS



To Our Valued Customer:

Congratulations on your purchase of the very latest in Dacor® products! Our unique combination of features, style and performance make us The Life of the Kitchen™, and a great addition to your home.

In order to familiarize yourself with the controls, functions, and full potential of your new Distinctive Appliance, we suggest that you thoroughly read this use and care manual, beginning with the **Important Safety Instructions** section.

All Dacor appliances are designed and manufactured with quality and pride, while working within the framework of our company value. Should you ever experience a problem with your product, please first check the **Before You Call for Service** section of this manual for guidance. It provides useful suggestions and remedies prior to calling for service.

Valuable customer input helps us to continuously improve our products and services, so please feel free to contact our Customer Service Team for assistance with any of your product support needs.

Dacor Customer Service Team
1440 Bridge Gate Drive
Diamond Bar, CA 91765

Telephone: (800) 793-0093

Fax: (626) 403-3130

Hours of Operation: Monday through Friday
6:00 A.M. to 5:00 P.M. Pacific Time

Web Site: www.Dacor.com

Thank you for choosing Dacor for your home. We are a company built by families for families and we are dedicated to serving yours. We are confident that your new Dacor product will deliver a high level of performance and enjoyment for many years to come.

Sincerely,

The Dacor Customer Service Team

Table of Contents

Important Safety Instructions	1	Operating Your Dishwasher	12
Important Information About Safety Instructions	1	Filling the Detergent Dispenser	12
General Safety Precautions	2	Filling the Rinse Aid Dispenser	13
Getting to Know Your Dishwasher	3	Starting Your Dishwasher	14
Model Information	3	Care and Cleaning	18
Parts of Your Appliance	4	Cleaning the Interior Surfaces	18
Parts of the Control Panel	6	Cleaning the Exterior Surfaces	18
Other Features	7	Before You Call for Service	20
Specifications	7	Problem Solution Guide	20
Loading Your Dishwasher	8	Warranty and Service	25
What Can Be Washed	8	Getting Help	25
What Should Not Be Washed	8	Warranty	25
Loading the Silverware Basket	9	Notes	26
Loading the Racks	10		

Important Safety Instructions

Installer: Leave these instructions with the appliance.

Consumer: Read this use and care manual completely before using this appliance. Save it for future reference. It contains important use and care information. Keep your sales receipt or canceled check in a safe place. Proof of original purchase date is required for warranty service.

For warranty and service information, see page 25.

If you have any questions (other than warranty questions), call:

Dacor Customer Service

(800) 793-0093 (U.S.A. and Canada)

Monday - Friday 6:00 A.M. to 5:00 P.M. Pacific Time

Web site: www.Dacor.com

Have the complete model and serial number identification of your appliance ready. Record these numbers below for easy access. The model and serial number label is located inside the dishwasher's left door jam. Open the door to expose it.

Model Number _____

Serial Number _____

Date of Purchase _____

Since Dacor continuously improves the quality and performance of our products, we may make changes to the appliance without updating this manual.

Important Information About Safety Instructions

The Important Safety Instructions and warnings in this manual are not meant to cover all possible problems and situations that can occur. Use common sense and caution when installing, maintaining or operating this or any other appliance.

Always contact the Dacor Customer Service Team about problems or situations that you do not understand.

DANGER

Immediate hazards that **WILL** result in severe personal injury or death.

WARNING

Hazards or unsafe actions that **COULD** result in severe personal injury or death.

CAUTION

Hazards or unsafe actions that **COULD** result in minor personal injury or property damage.

IMPORTANT

Tips that help you to get the most out of the dishwasher.

Important Safety Instructions

General Safety Precautions

To reduce the risk of fire, electric shock, serious injury or death when using your appliance, follow basic safety precautions, including the following:

WARNING

- Read all instructions before using the dishwasher. Use and care for the dishwasher only as instructed in this manual.
- Keep this manual for future reference.
- If you receive a damaged product, immediately contact your dealer or builder. Do not install or use a damaged appliance.
- To avoid an electrical shock hazard, make sure that the dishwasher has been properly installed and grounded by a qualified installer according to the accompanying installation instructions. Have the installer show you where the fuse or circuit breaker panel is located so that you know where and how to turn off the power.
- The dishwasher must be mounted in a completely enclosed cabinet.
- Do not repair or replace any part of the dishwasher unless specifically recommended in the literature accompanying it. A qualified service technician should perform all other service.
- Make sure individuals who use the dishwasher are able to operate it properly.
- Do not leave children alone or unattended in the area around the dishwasher. Do not allow children to play with the controls or other parts of the dishwasher.
- Never allow anyone, including children, to sit or stand on any part of the dishwasher. Stepping or sitting on any part of it may result in tipping, damage and serious injury.
- Many surfaces within the dishwasher achieve high temperatures. Do not touch interior surfaces or items inside the dishwasher during or immediately after use. Exercise caution when opening the door. Let hot air and steam escape before looking or reaching inside.
- Do not operate the dishwasher without the door completely closed and the toe kick panel in place.
- Do not store or use combustible materials, liquids or gases near this or any other appliance.
- Clean only those parts of the dishwasher listed in this manual. Clean them only in the manner specified in the **Care and Cleaning** section.

WARNING

- Use only the cleaning solutions specified in this manual to clean the dishwasher. Other cleaning solutions could produce dangerous fumes, cause corrosion of the metal parts and could permanently damage the finishes.
- Use only detergents and rinse aids designed for use with a residential dishwasher.
- Store all detergents and rinse aids out of the reach of children.
- Do not tamper with the controls.
- Under certain conditions hydrogen gas may be produced in a hot water system that has not been used for two weeks or more. Hydrogen gas is explosive. If the hot water system has not been used for a period of time, turn on all hot water faucets and let the water flow for several minutes to release any accumulated hydrogen gas. Do not smoke or use an open flame during this process.
- To prevent child entrapment, always remove the door from an old dishwasher when removing it from service.
- This dishwasher is not intended for commercial use.

CAUTION

- Use the dishwasher to wash flatware and cookware **ONLY**. Washing other items may damage or discolor the dishwasher. Wash only the types of dishes and cooking utensils indicated in this manual.
- To prevent household mold and mildew damage, periodically check the inlet and drain hoses for leaks.

Getting to Know Your Dishwasher

Model Information

All models covered by this manual have the same features. The difference between models is the style of door.

Model Number	Door Style	Model Number	Door Style
ED24	Stainless steel finish with Epicure [®] style handle	PD24BK	Door covered with black colored glass and Preference style handle
ID24	Custom, customer provided door panel and handle	PD24BU	Door covered with blue water colored glass and Preference style handle
MDV24	Black glass covered door with vertical stainless steel trim and Millennia [®] style handle	PD24GN	Door covered with slate green colored glass and Preference style handle
MDH24	Black glass covered door with horizontal stainless steel trim and Millennia style handle	PD24SG	Door covered with sterling gray colored glass and Preference style handle
PD24AG	Door covered with anthracite gray colored glass and Preference [®] style handle	PD24TS	Door covered with titanium silver colored glass and Preference style handle

Getting to Know Your Dishwasher

Parts of Your Appliance

- ❖ **Control Panel:** Located on top of the door. The buttons control your dishwasher.
- ❖ **Detergent Dispenser:** Automatically releases the detergent during the wash part of the cycle (see page 12).
- ❖ **Dish Washing Compartment:** The compartment where tableware and cookware are loaded for washing.
- ❖ **Door Switch:** Located in the door. Automatically pauses dish washing when the door is opened.
- ❖ **In-Process Light:** The blue in-process light shines on the floor below the dishwasher. It flashes when the dishwasher is operating. It turns solid when the selected cycle is complete. It turns off when the selected cycle is complete and the door is opened and closed.
- ❖ **Filter System:** Traps food and debris that could damage or plug up the mechanical parts of your dishwasher. See page 18 for cleaning instructions.
- ❖ **Racks:** The racks are coated with a durable coating that protects the finish of tableware and cookware. They each have rows of adjustable tines that allow you to make room for large items (see page 11).
- ❖ **Rinse Aid Dispenser:** Automatically releases rinse aid during the rinse part of the cycle. Rinse aid is a fluid that helps the dishes dry properly and helps prevent water spots. The amount of rinse aid dispensed is adjustable (see page 13).
- ❖ **Silverware Basket:** Use the silverware basket to hold silverware and kitchen utensils. It has two compartments that snap closed to hold small items (see page 9).
- ❖ **Spray Arms:** The spray arms spray water on the dishes at high pressure to remove soil.
- ❖ **Toe Kick Panel:** Covers the internal mechanics of the dishwasher located below the door. It must always be in place during operation.

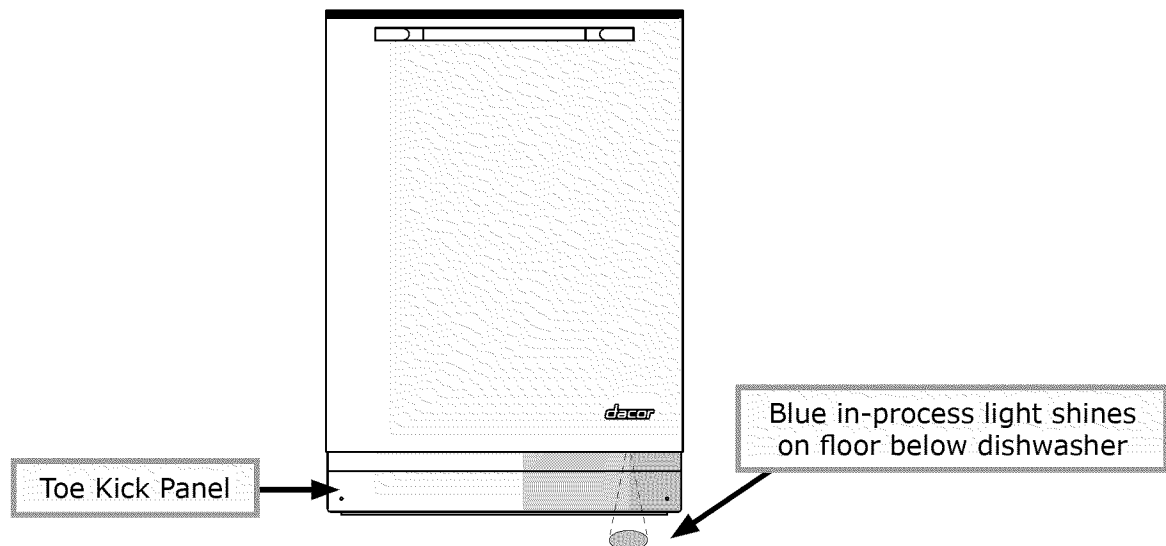

Getting to Know Your Dishwasher

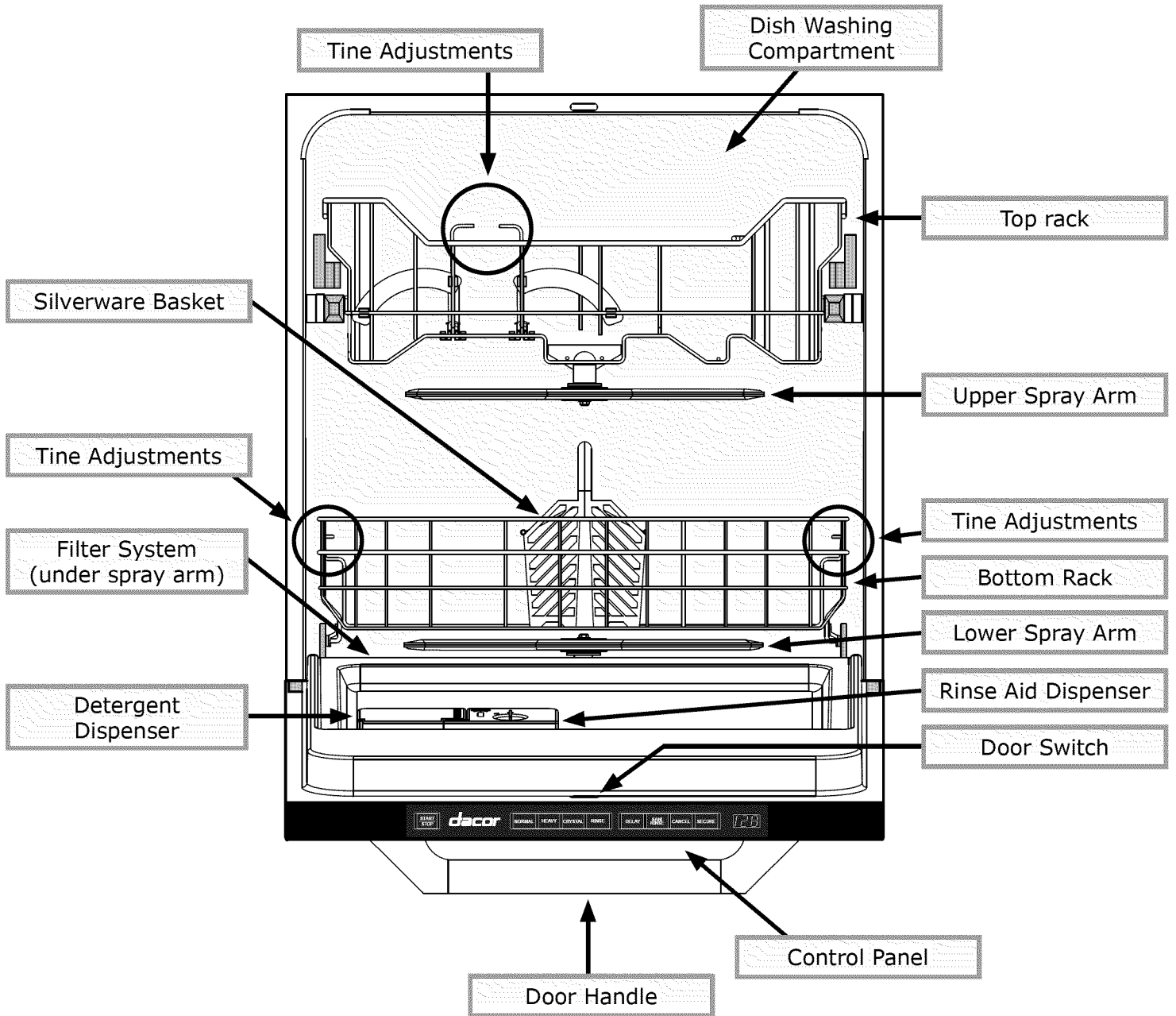

Getting to Know Your Dishwasher

Parts of the Control Panel

❖ Buttons:

**START
STOP**

Use this button to start the dishwasher after selecting a wash cycle or the rinse cycle (see page 14). It can also be used to pause the dishwasher in the middle of a wash or rinse cycle (see page 15).

NORMAL

This wash setting is best for normal soil.

HEAVY

This wash setting is best for very dirty tableware and cookware.

CRYSTAL

This wash setting is best for china, crystal or glass. It is also good for lightly soiled items that have been pre-rinsed.

RINSE

Press this button if you want to run the rinse portion of the cycle only. The dry cycle will not run. Also, use this setting to rinse tableware that you do not want to wash right away.

DELAY

This feature allows you to set the dishwasher to start at a later time (see page 16).

**SANI
RINSE**

This feature rinses the dishware with rinse water that is 5°F (3°C) hotter than the regular cycle rinse water for maximum sanitization and drying (see page 15). It can be used with the normal wash cycle only.

CANCEL

Use this button to stop the dishwasher in the middle of a cycle (see page 15).

SECURE

A safety feature. This button locks the control panel to prevent children from tampering with the appliance (see page 17).

❖ Numeric Display:

Displays the estimated time the cycle will run when the dishwasher is first started and the remaining dry time during the dry cycle. See **Turbidity Sensor** on the facing page for a complete description.

Numeric Display

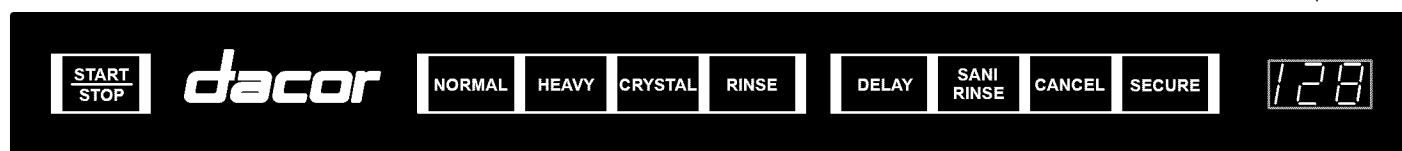

Getting to Know Your Dishwasher

Other Features

- **Turbidity Sensor:** Dacor's advanced soil measurement system decreases or increases the wash and rinse time, as well as water usage, for more consistent cleaning and energy savings. Your dishwasher's advanced on-board computer system measures the soil in the water and the water temperature to determine when the dishes are clean.
PLEASE NOTE: The display time should not be used to determine the amount of time a cycle will run. The dishwasher constantly monitors the soil level in the water and adjusts the cycle time accordingly to deliver best performance. The display indicates the estimated run time when the cycle is first selected, and later during the dry cycle, the amount of time left in the drying process.
- **Pressure Sensor System:** Senses the water level for consistent and complete draining of the dish washing compartment.
- **Digital Temperature Sensor:** Continuously monitors and controls water temperature.
- **In-line Water Heater:** The dual thermal safety in-line water heater is located safely out of the touch of hands or plastic dish-ware in the water circulation system. It is monitored by an automatically resetting thermostat and element, which protect the heating element against burnout due to operation without water in the appliance.

Specifications

- **Operating temperature range:** 50° to 158°F (10° to 70°C)
- **Storage temperature range:** -4° to 185°F (-20° to 85°C)
- **Line voltage and tolerance:** 120 Vac (60 Hz), +10% -15%

Loading Your Dishwasher

WARNING

During loading, insert all sharp or pointed objects with the handles up. Locate these items where they will not damage the door seal or cause personal injury.

CAUTION

- Place sharp objects in the silverware basket to prevent damage to the rack coating.
- Do not wash plastic items unless they are marked "dishwasher safe." Always check the manufacturer's recommendation before washing plastic items that are not marked.

IMPORTANT

If the load will sit for a while before washing, run the rinse cycle to reduce the chance of food hardening. Doing so will also reduce the risk of acidic foods damaging metal surfaces.

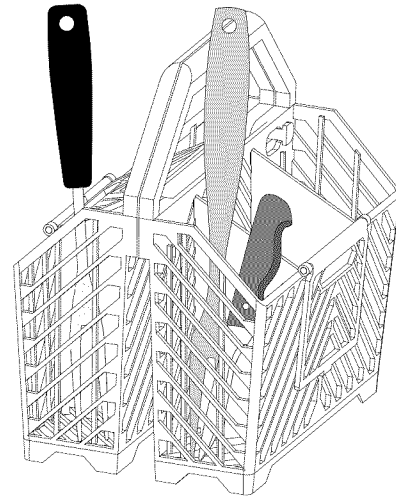

Load sharp objects with handles up

What Can Be Washed

Items that you can safely wash in your dishwasher:

- Aluminum (except for disposables)
- China (except delicate china)
- Cookware with non-stick coatings
- Crystal (except antique crystal)
- Glass
- Plastic (dishwasher safe only)
- Silver and silver plate
- Stainless steel
- Stoneware

What Should Not Be Washed

For safety reasons, and to prevent damage, do not wash the following items in your dishwasher:

- Antique crystal
- Brass
- Bronze
- Cast iron
- Delicate china
- Disposable aluminum
- Disposable plastic items
- Flatware with bonded handles
- Gold
- Pewter
- Sharp kitchen carving knives
- Tin
- Wood

Loading Your Dishwasher

Loading the Silverware Basket



IMPORTANT

- For the best results do not nest utensils in the silverware basket.
- Do not load silver next to stainless steel. Damage to the silver may result.
- Make sure the tines around the silverware basket are in the up position to prevent it from falling over.

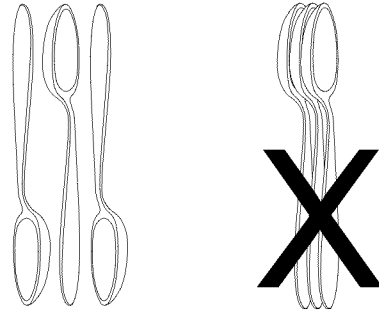

To prevent small, light items from falling out of the rack when sprayed with water:

1. Put small items into a compartment with a hinged cover.
2. Snap the cover shut.

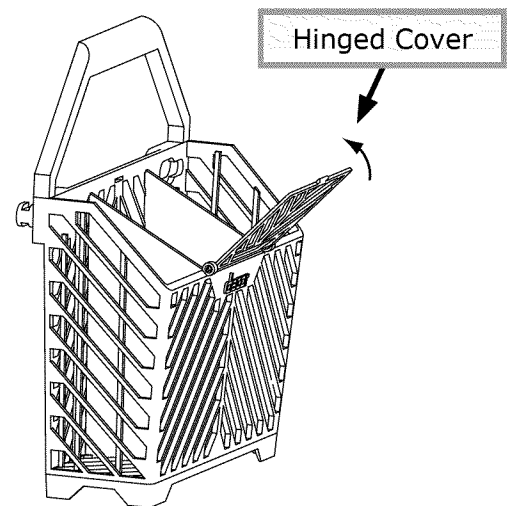

Silverware Basket Placement

- Put the silverware basket in the bottom rack near the front, in the space between the tines.
- Or you may put the basket anywhere it will fit on the lower rack. The silverware basket may be split into two parts for a better fit. To reattach, insert the tabs into the holes and snap into place.

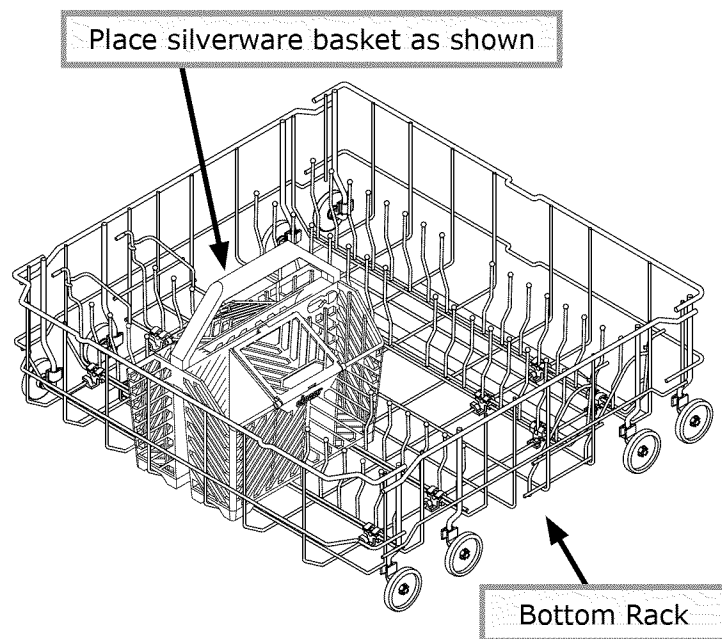
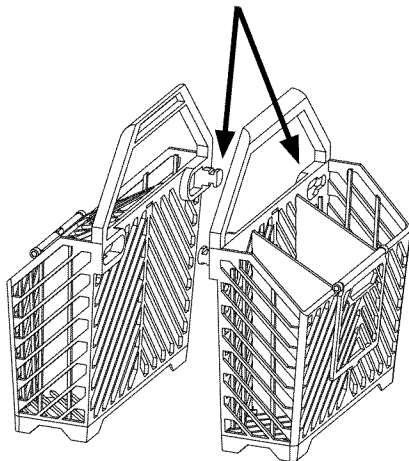

Loading Your Dishwasher

Loading the Racks

CAUTION

- Always place large or heavy items (such as pots, pans, and large dish-ware) in the bottom rack.
- To avoid damage to the racks, do not let sharp edges come into contact with them.
- To minimize breakage and chipping, secure all glassware and china by adjusting the tines. Do not allow fragile items to touch each other.

IMPORTANT

- The spray arms must spin freely. Do not allow items sticking out of the racks to block them. Raise the top rack to prevent objects on the bottom rack from blocking the upper spray arm (see *Adjusting the Top Rack*, below). The dishwasher will not operate properly unless both sides of the top rack are set to the same height.
- Do not load cookie sheets and large platters in the front of the bottom rack. Doing so will prevent water from dissolving the detergent in the detergent dispenser. See diagram below.
- Put items that could fall through the rack into the silverware basket or on the silverware tray (see diagram, bottom right).

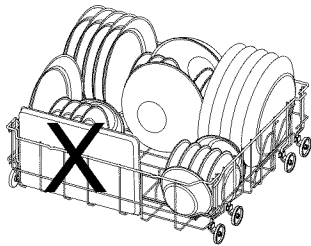

Adjusting the Top Rack

If there are large items in the bottom rack that could interfere with the upper spray arm, move the top rack to the high position. Otherwise, put the top rack in the low position.

To change the top rack position:

1. Pull up on both sides of the rack to move it to the upper position.
2. To lower, gently pull up on both sides of the rack and push in on the large part of both handles.
3. Move the rack down to the lower position.

Do not block spray arms

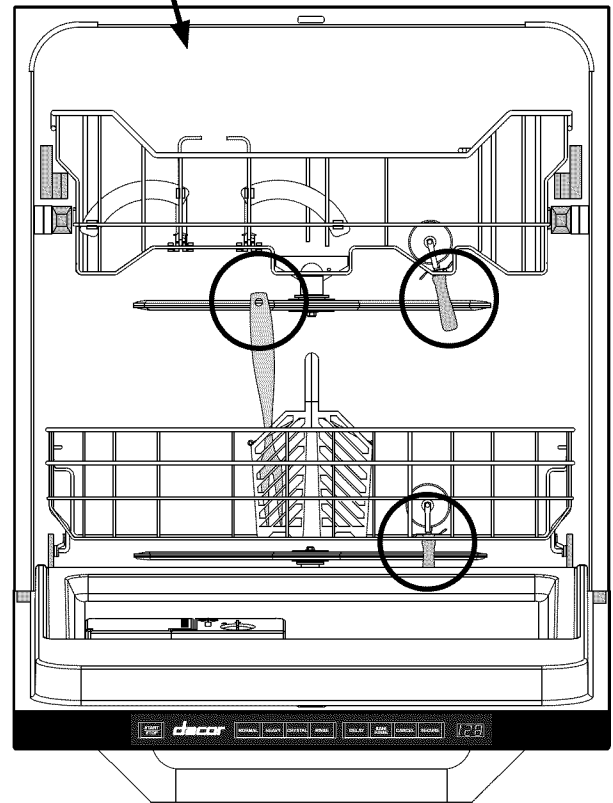

Silverware Tray

Handle

Put hooks on both ends over edges of top rack

Handle

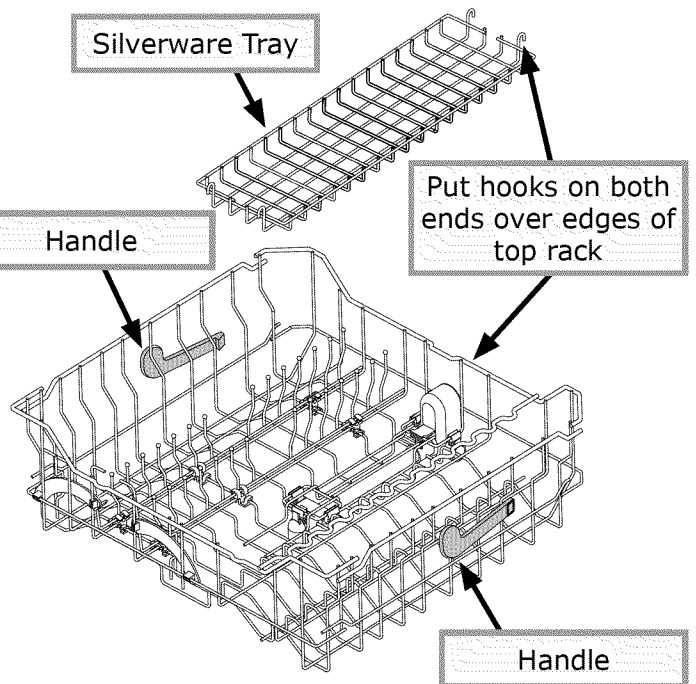

Loading Your Dishwasher

Loading the Racks



IMPORTANT

After loading, push in firmly on the top rack for proper dishwasher operation.

- Always use the top rack for delicate items.
- Scrape off leftover food items and non-food items, like toothpicks and napkins, before loading.
- Do not stack dishes, glasses or pots and pans. Stacking will prevent water from getting to soiled surfaces.
- Load all items so that the open ends face down as much as possible. Good drainage provides the best drying. It is not necessary to rinse objects before loading them.
- To adjust the tines, push the tine adjustment lever away from the edge of the rack and swivel the tines to the desired position.
- To minimize noise, do not allow pots and pans to touch and keep large items from touching the sides of your dishwasher.
- Load glasses and cups on the top rack.

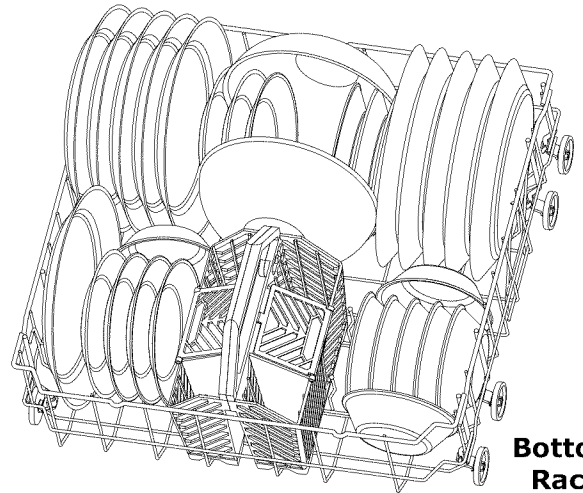

Bottom Rack

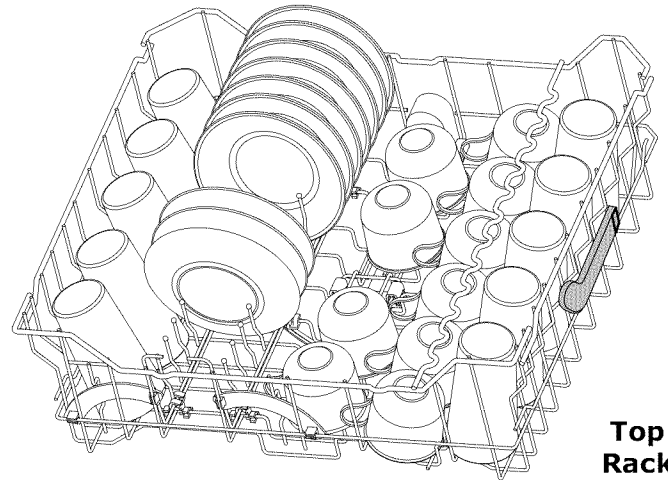

Top Rack

Front of Top Rack

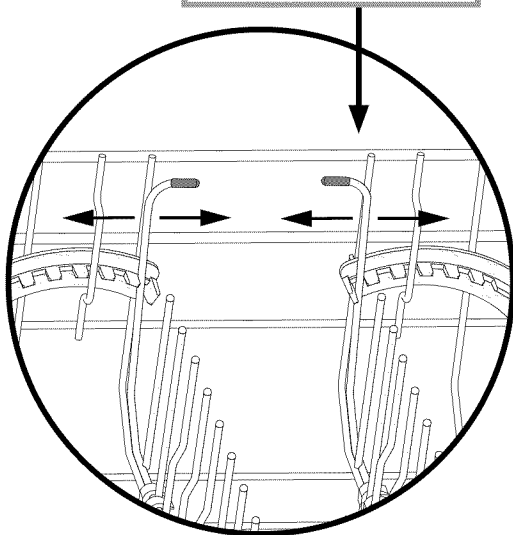

Top Rack Tine Adjustment

Sides of Bottom Rack

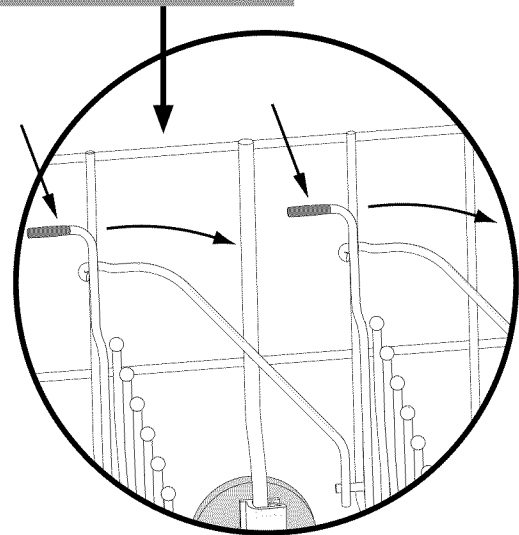

Bottom Rack Tine Adjustment

Operating Your Dishwasher

Filling the Detergent Dispenser



IMPORTANT

- Do not use hand dish washing detergents. They will create excessive foaming that interferes with proper operation.
- To make sure the detergent dissolves properly, fill the detergent dispenser just prior to starting your dishwasher. Detergent will harden if it sits too long.
- Store dry detergent in a cool dry place to prevent caking.
- Use a liquid rinse aid for best results (See page 13).

- If the detergent dispenser lid is closed, press the release button to open it.
- The detergent dispenser has two compartments: The smaller pre-wash compartment, and the main wash compartment.
- The pre-wash compartment empties into the dishwasher when the door is closed. The main wash compartment releases detergent automatically during the main wash cycle.
- Fill the pre-wash cup to the top.
- See the table below for the amount of detergent to use in the main wash cup. The amount of detergent required depends on the hardness of the water in your area. Harder water requires more detergent. Water hardness is measured in grains per gallon (gpg). Do not use too little detergent for your water hardness. Doing so can cause poorly cleaned dishes, filming or spotting. If you use too much detergent, you can cause a permanent film called etching. To find out the water hardness in your area, contact your water company.
- After loading both compartments, close the dispenser lid.
- Detergent alone may not be enough for water hardness above 12. For maximum cleanliness you may need to use a water softener. Or you may add additional detergent about 20 minutes after starting your dishwasher. As a rule, add 1 teaspoon for each grain above 12. **To add additional detergent:**
 1. Open the door. The dishwasher will stop operating.
 2. Wait a moment for the steam to clear.
 3. Without touching any of the hot surfaces or racks, pour additional dish washing detergent into the bottom of the dish washing compartment.
 4. Close the door. Push on the door handle to make sure that the door is completely shut. After a short pause, operation will resume.

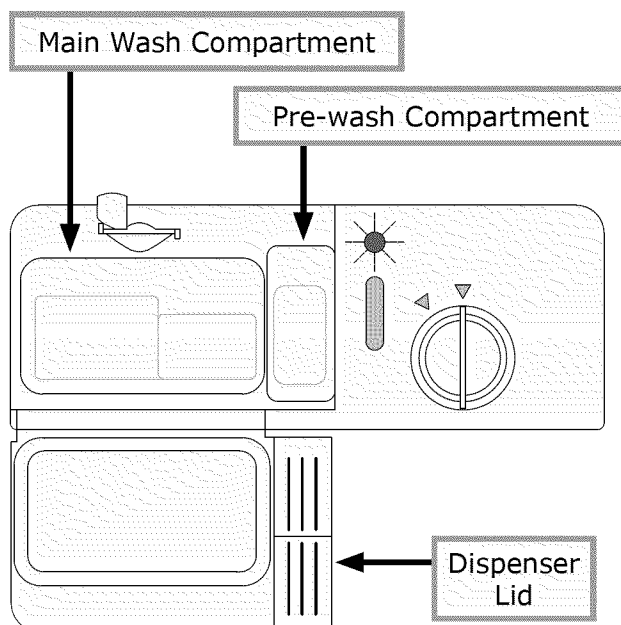
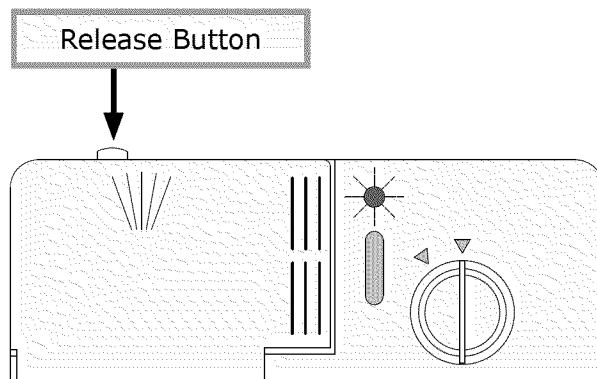

Water Hardness (gpg)	Amount of Detergent
Soft (0-3)	3 tsp.
Medium (4-9)	4 - 9 tsp.
Hard (10-12)	10 -12 tsp.

Operating Your Dishwasher

Filling the Rinse Aid Dispenser



IMPORTANT

- Rinse aid is important to the drying process of the dishware. It also reduces spotting. Dacor recommends that you keep the rinse aid dispenser full at all times.
- The rinse aid indicator on the dispenser turns “clear” when it is empty.

- The rinse aid dispenser must be properly adjusted. Too little rinse aid will allow spotting and drying problems. Too much rinse aid will cause foaming and streaking.
- A rinse aid containing citric acid may be used to remove the white or gray film caused by very hard water.

To refill the rinse aid dispenser:

1. Turn the rinse aid cap counterclockwise to the open position and lift it out.
2. Carefully pour the rinse aid into the filler hole until the rinse aid level is even with the bottom of the hole. Do not overfill.
3. Wipe up any spillage.
4. Replace the rinse aid cap and turn it clockwise to the closed position.

Adjusting the Rinse Aid Dispenser

The rinse aid setting is located under the rinse aid cap. It is set at the factory to 4.

To change the setting:

1. Remove the rinse aid cap.
2. If you have spotty or improperly dried dishes, move the rinse aid setting to the next higher number. If you have streaks on your dishes, move the rinse aid setting to the next lower number. The harder the water, the more rinse aid required for acceptable results.
3. Replace the cap.
4. Check the dishes after the next wash load. Continue adjusting the rinse aid dispenser up or down according to the guidelines above until you have spot free, streak free, dry dishes.

If you have very soft water and still experience streaking when the dispenser is set to 1, you can dilute the rinse aid with water before pouring it into the dispenser to get acceptable results.

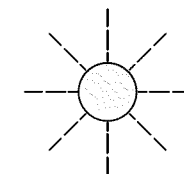

Empty

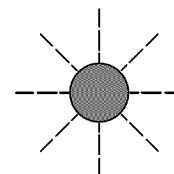

Not Empty

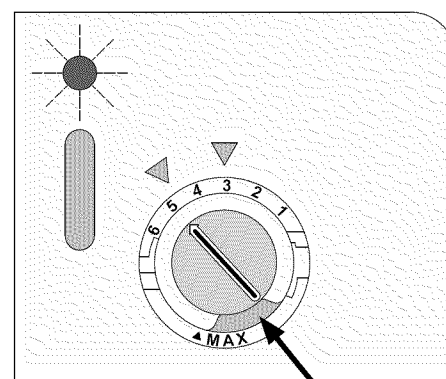
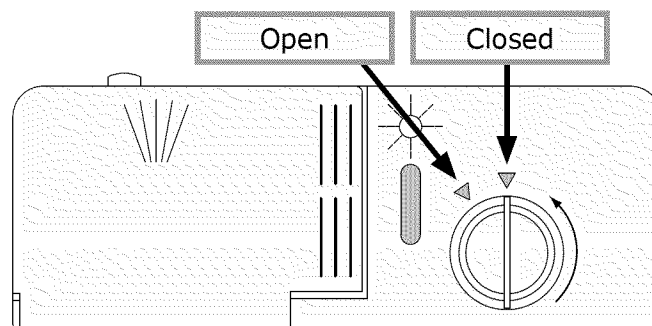

Filler Hole

Operating Your Dishwasher

Starting Your Dishwasher



IMPORTANT

- See the **Getting to Know Your Dishwasher** section for a description of the various wash settings.
- If the dishwasher drain line is connected to a garbage disposal, run the disposal before operating the dishwasher for proper drainage.

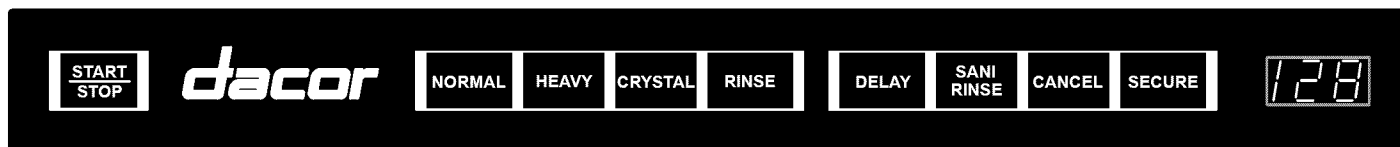

To wash or rinse the dishes:

1. For best performance, turn on the hot water at a nearby faucet until the running water is hot. Doing so clears cold water from the pipes.
2. Press one of the wash cycle buttons or the rinse button on the control panel.
3. Press **START/STOP**. The numeric display will show the estimated length of the cycle in minutes. (Please see **Turbidity Sensor** on the page 7 for a complete description).
4. Close the door.
5. Push on the door handle to make sure that the door is completely shut. After a brief pause, the dishwasher will start.



Adding a Dish After You Start:

You can add a dish, if needed, after starting your dishwasher. Dacor recommends that you only add items during the first five minutes of operation to make sure they get clean.

To add a dish:

1. Open the door. The dishwasher will stop operating.
2. Wait a moment for the steam to clear.
3. Without touching any of the hot surfaces or racks, insert the item into one of the racks, following normal loading instructions.
4. Close the door.
5. Push on the door handle to make sure that the door is completely shut. After a short pause, operation will resume.

Operating Your Dishwasher

Stopping Your Dishwasher During Operation

CANCEL

To stop the current cycle and drain your dishwasher:

1. Open the door. The dishwasher will stop operating.
2. Press **CANCEL**.
3. Close the door. After a short pause, you will hear the water in the dishwasher begin to drain. Once the water is drained, the dishwasher will stop.



IMPORTANT

If you press the **CANCEL** button twice, the dishwasher will stop completely. The water inside the dishwasher will not drain.

Pausing Dishwasher Operation

STOP

To temporarily pause dishwasher operation:

1. Open the door. The dishwasher will stop operating.
2. Press the **START/STOP** button.
3. The door may be closed and the dishwasher will not start.



To resume the dishwasher cycle:

1. Open the door.
2. Press the **START/STOP** button.
3. After a brief pause, the dishwasher will resume the previous cycle.



Sanitizing the Dishes

SANI-RINSE

If you want a high temperature rinse after the wash cycle for maximum sanitization:

1. Press the **NORMAL** button to select the normal wash cycle.
2. Press **SANI-RINSE**. (Pressing **SANI-RINSE** a second time will turn sani-rinse off again.)
3. Press **START/STOP**.
4. Close the door. After a short pause, the dishwasher will start.



IMPORTANT

SANI-RINSE can only be selected when the **NORMAL** wash cycle is selected.

Operating Your Dishwasher

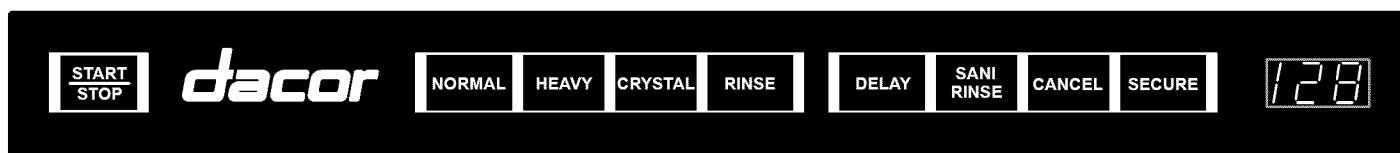

The DELAY Feature

To set your dishwasher to start automatically at a later time:

1. Press one of the wash cycle buttons or the rinse button.
2. If you have selected **NORMAL**, you may press the **SANI-RINSE** button for maximum sanitization.
3. Repeatedly press the **DELAY** button until the number of hours you want to delay operation appears on the numeric display. You can delay the start of your dishwasher up to 12 hours.
4. After you select the delay time, press **START/STOP**.
5. Close the door completely. The dishwasher will start after the selected number of hours.



To cancel the delay function, open the door and press **CANCEL**.

Changing the Cycle After You Start

You can change the cycle and option selections after you start your dishwasher.

To change the cycle:

1. Open the door. The dishwasher stops operating.
2. Press the **CANCEL** button twice.
3. Press the button for the desired wash or rinse cycle (**NORMAL**, **HEAVY**, **CRYSTAL** or **RINSE**).
4. If you have selected **NORMAL**, you may press the **SANI-RINSE** button for maximum sanitization.
5. Press the **START/STOP** button.
6. Close the door.
7. After a short pause, operation will resume.



Operating Your Dishwasher

The Cycle Memory Feature

Your dishwasher remembers the settings for the last cycle it ran.

If you want your dishwasher to run the same cycle as it ran the previous time:

1. Press the **START/STOP** button once. The **START/STOP** button light will flash and the lights on the buttons for the last cycle and options run will be lit.
2. Press the **START/STOP** button again to run the previous cycle (or you may press a different cycle and press **START/STOP**).
3. Close the door. After a short pause, the dishwasher will begin to operate.

A black rectangular button with the words "START" and "STOP" stacked vertically in white, bold, sans-serif font.A black rectangular button with the words "START" and "STOP" stacked vertically in white, bold, sans-serif font.

If the delay feature was used during the previous cycle, your dishwasher will start after the number of hours originally selected.

Draining Standing Water

To drain standing water from the bottom of your dishwasher:

1. Press **NORMAL**.

A black rectangular button with the word "NORMAL" in white, bold, sans-serif font.

2. Press **START/STOP**.

A black rectangular button with the words "START" and "STOP" stacked vertically in white, bold, sans-serif font.

3. Press **CANCEL**.

A black rectangular button with the word "CANCEL" in white, bold, sans-serif font.

4. Close the door. After a short pause, you will hear the water in the dishwasher begin to drain. Once the water is drained, the dishwasher will stop.



IMPORTANT

Your dishwasher also drains the water in the bottom at the start of each wash and rinse cycle.

The SECURE Feature

To secure the control panel:

1. Press and hold the **SECURE** button for three seconds. All control panel lights are deactivated and none of the buttons operate.
2. To turn off the secure feature, press and hold the **SECURE** button for three seconds.

A black rectangular button with the word "SECURE" in white, bold, sans-serif font.

The control panel beeps when you turn this feature on and off.

Care and Cleaning

Cleaning the Interior Surfaces

CAUTION

- Do not operate the dishwasher without the strainer and the two filters in place. The strainer and filter system is designed to keep large food particles out of the mechanical parts.
- Exercise caution when cleaning around the control panel area. Do not use spray cleaners of any kind on this area.

- The dish washing compartment of your Dacor dishwasher is constructed of high quality stainless steel. It remains clean during normal use.
- The control panel and the racks may be wiped clean, if necessary, with a soft damp rag.
- Food particles on the silverware basket can be rinsed clean under a faucet with warm water.

Filters and Strainer Baskets

When you observe food in the strainer basket or filters, clean them as follows:

1. Remove the strainer by turning it counterclockwise and lifting it straight up (see facing page).
2. Remove the small particle filter by turning it counterclockwise and lifting it straight up.
3. Lift out the medium particle filter.
4. Clean the filters in the kitchen sink with a soft sponge and mild kitchen detergent under warm water.
5. Replace the filters. Tighten the small particle filter and the strainer snugly.

Cleaning the Exterior Surfaces

IMPORTANT

Always wipe stainless steel surfaces with the grain.

- Clean exterior surfaces with a solution of mild detergent and warm water. Rinse and dry with a soft, lint-free cloth.
- You may also use Dacor Stainless Steel Cleaner (Part No. A-302) on stainless steel surfaces. Use it according to the directions on the package.

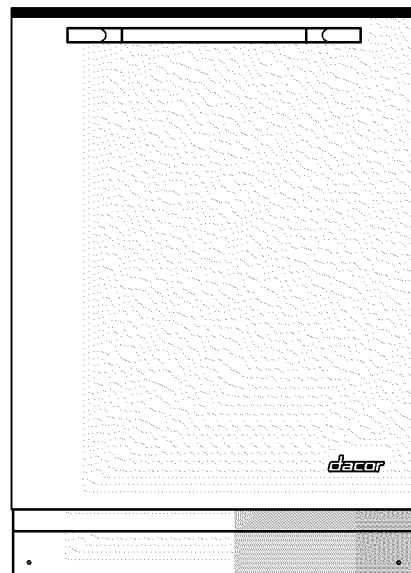

Care and Cleaning

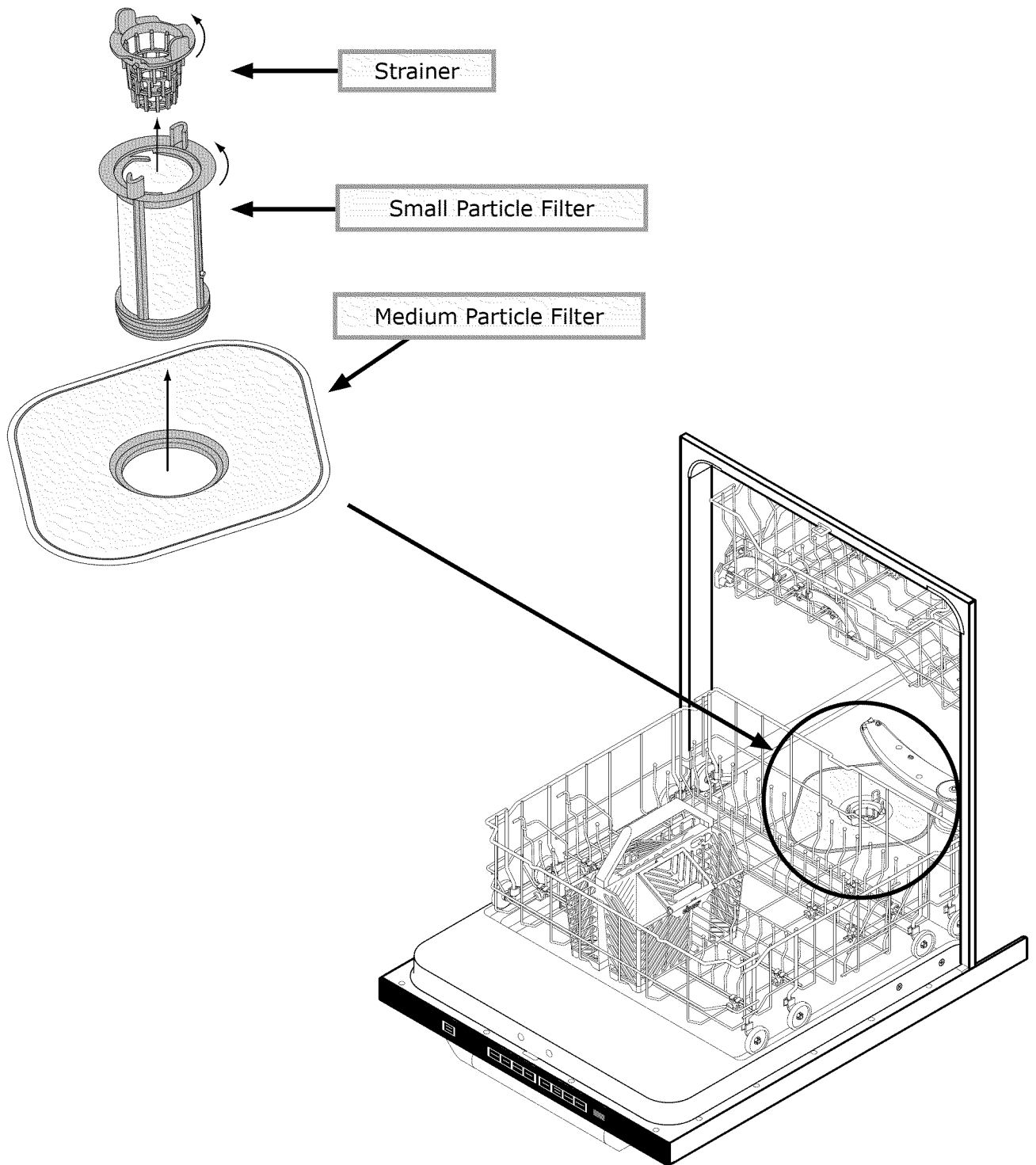

Removing the Strainer and Filters

Before You Call for Service

Problem Solution Guide

Unnecessary service calls may be expensive, frustrating and time-consuming. Before you call for service, please review the **Problem Solution Guide** below.

Problem	May Be Caused By	What to Do
Spotting and filming	Hard water	Use maximum recommended amount of dishwasher detergent.
		You may need a home water softener.
		To remove hard water spots, try a vinegar rinse: <ul style="list-style-type: none"> • Wash and rinse load as usual. • Remove all metal items from dishwasher. Do not add detergent. • Pour 2 cups of vinegar into a bowl and set it on bottom rack. • Run dishes through an entire wash program. If the vinegar rinse does not work, repeat process substituting ¼ cup of citric acid crystals (available at most drug stores) for the vinegar.
		Wiping metal items with a damp cloth should remove spots. For sterling and silver plated flatware, rub with a towel or use a good cream silver polish.
	Garbage disposal or sink trap full	Run garbage disposal to eliminate food and obstructions in sink. Make sure sink drains properly.
	No rinse aid	Make sure rinse aid dispenser is full.
	Water not hot enough	Check hot water supply temperature. Minimum recommended incoming temperature to the dishwasher is 120°F.
Too little water	Make sure water valve is fully open. Make sure that water pressure is between 20 and 120psi and flow rate is a minimum of 1.0 gpm.	
Incorrect use of dishwasher detergent	Use only correct amount of dishwasher detergent according to water hardness (see page 12) and the wash program selected. Fill dispenser only when ready to start the dishwasher. Do not use old or caked detergent. Store dishwasher detergent in dry place and in a closed container. Change the dishwasher detergent if results are still poor.	
Items not loaded properly	Make sure dishwasher is loaded according to instructions starting on page 8. Do not overload. Make sure spray can reach all soiled surfaces.	

Before You Call for Service

Problem	May Be Caused By	What to Do
Spotting and filming (cont.)	Spray arms do not rotate properly	<p>Make sure that both spray arms rotate freely. Make sure that items do not obstruct movement of spray arms. If necessary, clear any obstructions.</p> <p>Make sure holes in spray arms are not blocked. If necessary, clear holes with a pointed object and rinse under water.</p>
	Strainer blocked	Check strainer. Clean if necessary.
	Excessive foam in the machine	<p>Use only "dishwasher" detergent.</p> <p>Too much rinse aid in final rinse cycle. Adjust rinse aid dispenser (see page 13).</p>
	Flatware incorrectly loaded	Make sure items are not nested (see page 9).
Clean-ability (Small particles deposited on items)	Spray arms do not rotate properly	<p>Make sure that both spray arms rotate freely. Make sure that items do not obstruct movement of spray arms. If necessary, clear any obstructions.</p> <p>Make sure holes in spray arms are not blocked. If necessary, clear holes with a pointed object and rinse under water.</p>
	Incorrect detergent use	Use only correct amount of dishwasher detergent according to water hardness (see page 12) and the wash program selected. Fill dispenser only when ready to start the dishwasher. Do not use old or caked detergent. Store dishwasher detergent in dry place and in a closed container. Change the dishwasher detergent if results are still poor.
	Filter system	Make sure filter system is clean and properly installed.
	Low water pressure	Check that water valve is fully open. Make sure water pressure is between 20 and 120psi and flow rate is 1.0 gpm minimum.
Detergent left in detergent compartment (Detergent compartment will not open)	Dispenser lid blocked	The lid may not be opening. Check for items blocking it.
	Old detergent	Do not use detergent that is hard or caked in the box. Use only fresh detergent. Add detergent to dishwasher just before starting it.
	Spray arms do not rotate properly	<p>Make sure that both spray arms rotate freely. Make sure that items do not obstruct movement of spray arms. If necessary, clear any obstructions.</p> <p>Make sure holes in spray arms are not blocked. If necessary, clear holes with a pointed object and rinse under water.</p>

Before You Call for Service

Problem Solution Guide (Continued)

Problem	May Be Caused By	What to Do
Chipping or breaking of glassware	Improper loading	Do not overload. Load between rack prongs, not over them. Glasses loaded over prongs will not be supported and may chip or break. Make sure glassware is secure and can't come loose. Always use the top rack for delicate items. Use the crystal cycle for china.
Unusual noise	Improper loading	Utensils may not be secure or something small may have dropped from the rack. Water may cause utensils to rattle. Make sure dishware is secure.
Water left in bottom of dishwasher near filters	Dish washing cycle not complete	Allow dishwasher to complete cycle.
	CANCEL button pressed twice in middle of cycle.	Restart (page 15) or drain (page 17) dishwasher.
	Some water is normal	Water left in strainer is normal.
Dishwasher will not drain	Air gap plugged	Be sure the air gap is not blocked or plugged. The air gap is a vent located on top of the sink. It is connected to the dishwasher. It is required by some local codes.
	Drain hose	Check for kink in drain hose.
	Filter system	Be sure there is no blockage in filter system.
Dishwasher will not start	Blown fuse or tripped circuit breaker	Replace fuse or reset circuit breaker. Remove other appliances from the circuit.
	Door not completely closed	Push in on door handle until you hear a click.
	Not plugged in incorrectly	Make sure plug is inserted in the wall socket or dishwasher is wired correctly.
Dishwasher will not fill	Door not completely closed	Push in on door handle until you hear a click.
	Controls not set	Make sure dishwasher is on (see Page 14).
	Water feed line blocked	Make sure water feed line to dishwasher is not kinked.
	No water supply	Make sure water valve is turned on.
Water backs up in sink when dishwasher drains	Garbage disposal or sink trap full	Run garbage disposal to eliminate food and obstructions in sink. Make sure sink drains properly.
Marks and discoloration	Aluminum utensils rubbing against items during wash cycle	Be sure aluminum utensils, especially light weight, foil-type pans, do not touch dishes.
Yellow or brown marks	Iron or manganese in water	To remove spots, use a non-abrasive cleaner.
		Temporary solution: Pour teaspoon to tablespoon of citric acid crystals in place of the pre-wash detergent in the detergent dispenser. Follow this pre-wash with a full detergent wash. Use the heavy wash program.
		Permanent solution: Install an iron removal system in the water supply.

Before You Call for Service

Problem	May Be Caused By	What to Do
Yellow or brown marks (cont.)	Washing copper with sterling silver	Yellow film on sterling silver results when you wash copper utensils in same load. Silver polish will usually remove this type of stain.
	Tea or coffee (tannic acid) stains	Remove tea or coffee stains by hand using a solution of ½ cup bleach and 3 cups warm water. (Do not use on sterling silver or silver plate.)
Discoloration of stainless steel, silver plate	Allowing salty or acidic foods to remain on flatware	Rinse flatware that is to stand several hours before washing.
	Stainless steel contacting silver	Do not put stainless steel and silver flatware in the same silverware basket compartment. Direct contact to stainless steel can cause permanent damage to silver.
		Clean stained items with silver polish. Do not use abrasives on stainless steel or silver.
Distortion of plastics	Plastic item not dishwasher safe	Do not wash plastic items in dishwasher that are not "dishwasher safe."
Marks on melamine and plastics	Porous material	Use a special cleaner for plastic.
Cloudy film on glassware - etching of glass	Too much detergent, especially in soft water	Do not use bleach or scouring powder on these materials.
		To remove cloudy film, try a vinegar rinse: <ul style="list-style-type: none"> • Wash and rinse load as usual. • Remove all metal items from dishwasher. Do not add detergent. • Pour 2 cups of vinegar into a bowl and set it on bottom rack. • Run dishes through an entire wash program. If the vinegar rinse does not work, repeat process substituting ¼ cup of citric acid crystals (available at most drug stores) for the vinegar.
		If vinegar or citric acid rinse does not remove film, the cloudiness is "etching". This is permanent. To prevent etching, if you have soft water, try using only 1 teaspoon of recommended dishwasher detergent.
	Use a good quality dishwasher detergent and rinse aid. Do not overload dishwasher. Water should circulate freely to assure adequate rinsing and draining.	
	Rinse aid used with soft water	Set rinse aid levels to minimum.

Before You Call for Service

Problem Solution Guide (Continued)

Problem	May Be Caused By	What to Do
Dishes not dry	No rinse aid	Fill rinse aid dispenser. Rinse aid helps dishes to dry faster.
	Plastic items	Certain plastic materials are difficult to dry. Plastics may need to be towel dried.
	Improper loading or unloading	Do not overload or nest items. Make sure dishwasher is loaded according to instructions starting on page 8.
	Water not hot enough	Dishes washed with the sani-rinse setting will dry the fastest.
	Dry cycle interrupted	Door opened too soon. Make sure dry portion of cycle is complete before opening door.
Delay will not work	Door not closed completely	Push firmly on door until it clicks into place.

Warranty and Service

Getting Help

Before you request service, please review the **Problem Solution Guide** starting on page 20. If you have performed the checks in the **Problem Solution Guide** and the problem has not been remedied, please contact us at one of the numbers below. Prior to requesting service, it is helpful to be familiar with the warranty terms and conditions listed in the **Warranty** section on this page.

For warranty repairs, call:

Dacor Distinctive Service:

Phone: (877) 337-3226 (U.S.A. and Canada)
Business Hours: 6:00 A.M. - 4:00 P.M. Pacific Time

For a list of Dacor service agents for non-warranty repairs:

Dacor Customer Service:

Phone: (800) 793-0093 (U.S.A. and Canada)
Business Hours: 6:00 A.M. - 5:00 P.M. Pacific Time

Contact us through our web site at:

www.Dacor.com

You may also write us at:

Dacor Customer Service
1440 Bridge Gate Drive
Diamond Bar, CA 91765

At Dacor, we believe that our quality of service equals that of our product. Should your experience with our service network or product be different, please contact our Customer Service Team and share your encounter with us. We will do our utmost to resolve the situation for you and deliver on our Dacor promise. If you need anything clarified, just let us know.

Warranty

What is Covered:

CERTIFICATE OF WARRANTIES: DACOR DISHWASHERS

WITHIN THE FIFTY STATES OF THE U.S.A., THE DISTRICT OF COLUMBIA AND CANADA*: FULL ONE-YEAR WARRANTY

If your DACOR product fails to function within one year of the original date of purchase, due to a defect in material or workman-ship, DACOR will remedy the defect without charge to you or subsequent users. The owner must provide proof of purchase upon request and have the appliance accessible for service.

TWENTY-FIVE YEAR WARRANTY

On rust-through of stainless steel tank and door.

Warranty is null and void if non-CUL approved product is transported from the U.S.

OUTSIDE THE FIFTY STATES OF THE U.S.A., THE DISTRICT OF COLUMBIA AND CANADA: LIMITED FIRST-YEAR WARRANTY

If your DACOR product fails to function within one year of the original date of purchase, due to a defect in material or workmanship, DACOR will furnish a new part, F.O.B. factory, to replace the defective part. All delivery, installation, and labor costs are the responsibility of the purchaser. The owner must provide proof of purchase upon request and have the appliance accessible for service.

What is Not Covered:

- Failure of the product caused by faulty installation, improper usage, or neglect of required maintenance.
- Service calls to educate the customer in the proper use and care of the product.
- Failure of the product when used for commercial, business, rental or any application other than for residential consumer use.
- Replacement of house fuses or fuse boxes, or resetting of circuit breakers.
- Damage to the product caused by accident, fire, flood or other acts of God.
- Breakage, discoloration or damage to glass, metal surfaces, plastic components, trim, paint, porcelain or other cosmetic finish, caused by improper usage or care, abuse, or neglect.

THE REMEDIES PROVIDED FOR THE ABOVE EXPRESS WARRANTIES ARE THE SOLE AND EXCLUSIVE REMEDIES. THEREFORE, NO OTHER EXPRESS WARRANTIES ARE MADE, AND OUTSIDE THE FIFTY STATES OF THE UNITED STATES AND THE DISTRICT OF COLUMBIA, ALL IMPLIED WARRANTIES, INCLUDING BUT NOT LIMITED TO, ANY IMPLIED WARRANTY OF MERCHANTABILITY OR FITNESS FOR A PARTICULAR USE OR PURPOSE ARE LIMITED IN DURATION TO ONE YEAR FROM THE DATE OF ORIGINAL PURCHASE. IN NO EVENT SHALL DACOR BE LIABLE FOR INCIDENTAL EXPENSE OR CONSEQUENTIAL DAMAGES. NO WARRANTIES, EXPRESSED OR IMPLIED, ARE MADE TO ANY BUYER FOR RESALE.

Some states do not allow limitations on how long an implied warranty lasts or do not allow the exclusion or limitation of incidental or consequential damages, so the above limitations or exclusions may not apply to you. This warranty gives you specific legal rights, and you may also have other rights that vary from state to state.

Notes

Notes

Notes

fold here



NO POSTAGE
NECESSARY
IF MAILED
IN THE
UNITED STATES

BUSINESS REPLY MAIL
FIRST-CLASS MAIL PERMIT NO. 4507 DIAMOND BAR CA

POSTAGE WILL BE PAID BY ADDRESSEE

DACOR INC.
ATTN: WARRANTY PROCESSING DEPT
1440 BRIDGE GATE DR STE 200
PO BOX 6532
DIAMOND BAR CA 91765-9861

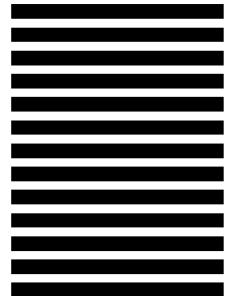



Please visit www.Dacor.com to activate your warranty online.

WARRANTY INFORMATION

**IMPORTANT:**

Your warranty will not be activated until you activate it online or return this form to Dacor. If you have purchased more than one Dacor product, please return all forms in one envelope or activate the warranty for each product online.

Please rest assured that under no conditions will Dacor sell your name or any of the information on this form for mailing list purposes. We are very grateful that you have chosen Dacor products for your home and do not consider the sale of such information to be a proper way of expressing our gratitude!

Owner's Name: _____
Last (Please Print or Type) First Middle

Street: _____

City: _____ State: _____ Zip: _____

Purchase Date: _____ Email: _____ Telephone: _____

Dealer: _____

City: _____ State: _____ Zip: _____

Your willingness to take a few seconds to fill in the section below will be sincerely appreciated. Thank you.

1. How were you **first** exposed to Dacor products? (Please check one only.)

- A. T.V. Cooking Show
- B. Magazine
- C. Appliance Dealer Showroom
- D. Kitchen Dealer Showroom
- E. Home Show
- F. Builder
- G. Architect/Designer
- H. Another Dacor Owner
- I. Model Home
- J. Other _____

2. Where did you buy your Dacor appliances?

- A. Appliance Dealer
- B. Kitchen Dealer
- C. Builder Supplier
- D. Builder
- E. Other _____

3. For what purpose was the product purchased?

- A. Replacement **only**
- B. Part of a Remodel
- C. New Home
- D. Other _____

4. What is your household income?

- A. Under \$75,000
- B. \$75,000 – \$100,000
- C. \$100,000 – \$150,000
- D. \$150,000 – \$200,000
- E. \$200,000 – \$250,000
- F. Over \$250,000

5. What other brands of appliances do you have in your kitchen?

- A. Cooktop _____
- B. Oven _____
- C. Dishwasher _____
- D. Refrigerator _____

6. Would you buy or recommend another Dacor product?

- Yes
- No

Comments: _____

Thank you very much for your assistance. The information you have provided will be extremely valuable in helping us plan for the future and giving you the support you deserve.

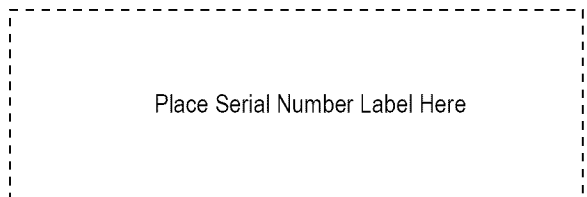

Place Serial Number Label Here

cut here