

# DISCOVERY WALL OVEN USE AND CARE MANUAL

Models EO/MO/PO



Style varies. Model EO230SCH shown.

## Table of Contents

|  |            |
|--|------------|
| Important Safety Instructions .....    | 1          |
| Getting to Know Your Oven .....        | 3          |
| Oven Setup .....                       | 6          |
| Operating Your Oven - The Basics ..... | 10         |
| Deluxe Features .....                  | 12         |
| Cooking Tips .....                     | 27         |
| Care and Cleaning .....                | 28         |
| Before You Call for Service .....      | 33         |
| Warranty and Service .....             | 34         |
| Notes .....                            | 35         |
| Warranty Card .....                    | Back Cover |





To Our Valued Customer:

Congratulations on your purchase of the very latest in Dacor® products! Our unique combination of features, style and performance make us The Life of the Kitchen™, and a great addition to your home.

In order to familiarize yourself with the controls, functions and full potential of your new Distinctive Appliance, read this use and care manual thoroughly, beginning with the **Important Safety Instructions** section.

All Dacor appliances are designed and manufactured with quality and pride, while working within the framework of our company value. Should you ever experience a problem with your product, please first check the **Before You Call for Service** section of this manual for guidance. It provides useful suggestions and remedies prior to calling for service.

Valuable customer input helps us to continuously improve our products and services, so please feel free to contact our Customer Service Team for assistance with any of your product support needs.

Dacor Customer Service Team  
600 Anton Blvd. Suite 1000  
Costa Mesa, CA 92626

Telephone: (800) 793-0093  
Fax: (626) 403-3130  
Hours of Operation: Monday through Friday  
6:00 A.M. to 5:00 P.M. Pacific Time  
Web Site: [www.Dacor.com](http://www.Dacor.com)

Thank you for choosing Dacor for your home. We are a company built by families for families and we are dedicated to serving yours. We are confident that your new Dacor product will deliver a high level of performance and enjoyment for many years to come.

Sincerely,

*The Dacor Customer Service Team*

# Important Safety Instructions

**INSTALLER:** LEAVE THESE INSTRUCTIONS WITH THE APPLIANCE.

**CUSTOMER:** READ THIS USE AND CARE MANUAL COMPLETELY BEFORE USING THIS APPLIANCE. SAVE IT FOR FUTURE REFERENCE. IT CONTAINS IMPORTANT USE AND CARE INFORMATION. KEEP YOUR SALES RECEIPT OR CANCELED CHECK IN A SAFE PLACE. PROOF OF ORIGINAL PURCHASE DATE IS REQUIRED FOR WARRANTY SERVICE.

**For service and warranty information see page 34.**

If you have any questions (other than warranty questions), call:

Dacor Customer Service  
Phone: (800) 793-0093 (U.S.A. and Canada)  
Monday — Friday 6:00 A.M. to 5:00 P.M. Pacific Time

Web site: [www.Dacor.com](http://www.Dacor.com)

Have the complete model and serial number for your appliance available. The numbers are found on the product data plate, see below. Write these numbers below for future reference.

## Exposing the Product Data Plate

The plate is inside the oven door, in the slot, above the left hinge (inside the lower door on a double oven).

To read the model and serial number...

- Push the data plate tab with your finger.
- Pull the data plate up.
- Push plate back into place before closing door.

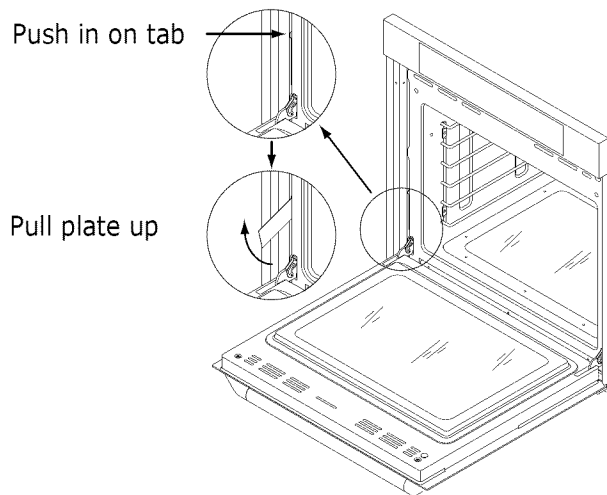

### Model/Serial Number Plate Location

Model number \_\_\_\_\_

Serial number \_\_\_\_\_

Date of purchase \_\_\_\_\_

Since we continuously improve the quality and performance of our products, we may need to make changes to the appliance without updating this manual.

Visit [www.Dacor.com](http://www.Dacor.com) to download the latest version of this manual.

## Important Information About Safety Instructions

The **Important Safety Instructions** and warnings in this manual can not cover all possible problems and conditions that can occur. Use common sense and caution when installing, maintaining or operating this appliance.

Always contact the Dacor Customer Service Team about problems or conditions that you don't understand.

## Safety Symbols and Labels

### **DANGER**

Immediate hazards that **WILL** result in severe personal injury or death.

### **WARNING**

Hazards or unsafe actions that **COULD** result in severe personal injury or death.

### **CAUTION**

Hazards or unsafe actions that **COULD** result in minor personal injury or property damage.

### **WARNING**

**NEVER** use this appliance as a space heater to heat or warm the room. Doing so may result in carbon monoxide poisoning and overheating of the appliance.

### **WARNING**

To prevent a fire hazard or damage to the oven, do not allow slots or vents inside or outside the oven to become obstructed at any time.

# Important Safety Instructions

## General Safety Precautions

To reduce risk of fire, electric shock, serious injury or death when using your appliance, follow basic precautions, including the following:



### WARNING

- Only use the oven for cooking tasks expected of a home appliance as outlined in this manual.
- If you receive a damaged product, immediately contact your dealer or builder. Do not install or use a damaged appliance.
- Do not repair or replace any part of the oven unless specifically recommended in the literature accompanying this appliance. A qualified service technician should perform all other service.
- Make sure that the appliance has been properly installed and grounded by a qualified installer according to the accompanying installation instructions. Have the installer show you where the fuse or junction box is located so that you know where and how to turn off the power.
- Always make sure food is cooked thoroughly before eating.
- Make sure that only those individuals that use the oven are able to operate it properly.
- Do not leave children alone or unattended in the area around the oven. Do not allow children to play with the oven. Children must be taught that the oven is not a toy. Do not allow children to play with the controls or other parts of the oven.
- Never allow anyone, including children to sit or stand on any part of the oven. Stepping or sitting on the oven may result in tipping, door breakage, and serious injury.
- Do not store items of interest to children above the oven. Children could be burned or injured while climbing on the appliance.
- Do not wear loose or hanging apparel while using the oven.
- Position oven racks in desired locations only when the oven is cool. If you need to reposition a rack after the oven is already hot, use a pot holder.
- **DO NOT TOUCH INTERIOR SURFACES OF THE OVEN DURING OR AFTER USE.** Do not allow clothing or other flammable materials to contact interior surfaces of the oven until they have had sufficient time to cool.
- Use only dry pot holders when removing food and cookware from the oven. Wet pot holders can cause steam burns.
- Exercise caution when opening the oven door. Let hot air or steam escape before looking or reaching into the oven.
- Do not store combustible, flammable or explosive materials in the oven or in adjacent cabinets.
- Do not use water on grease fires. A violent steam explosion may result. Smother any flames with a lid, cookie sheet or flat tray. Use baking soda or a foam extinguisher to extinguish flaming grease.
- Do not use towels or bulky cloth as pot holders.
- Use extreme caution if adding water to food in a hot oven. The steam can cause serious burns or scalds.
- Do not heat unopened food containers such as baby food jars and cans. Pressure build up may cause the container to burst and cause injury.



### WARNING

- To prevent the possibility of burns, connect and unplug the meat probe using hot pads.
- To avoid electrical shock or burns, turn off the oven and be sure that the oven is cool before cleaning.
- For your safety, do not use the oven to cook without the convection filter(s) installed. When the filter is not installed, the spinning fan blades at the back of the oven are exposed.
- Do not leave the oven unattended when cooking with oils or fats. They can be a fire hazard if overheated.
- Do not touch the outside surfaces of the oven during the self-clean cycle. They will be hot.
- The oven automatically locks the oven door during self-cleaning. Do not try to force the door open after it is locked. Damage to the door and door latch may result.
- Before self-cleaning the oven, remove the broiler pan grill and pan, oven racks, convection filter, meat probe, and any other utensils.
- Do not line the oven with aluminum foil or other materials. These items can melt or burn up during self-cleaning and cause permanent damage to the oven.
- Properly clean and maintain the oven as recommended in this manual.
- Clean only those parts listed in this manual.
- Use only the cleaning solutions specified in this manual to clean your oven. Do not use any cleaners that are not specified to clean the inside or outside of the oven. Other cleaning solutions could produce hazardous fumes, cause corrosion of the metal parts, and could permanently damage the finishes.
- Take extreme caution when cleaning the door gasket. Rubbing, moving or in any way damaging the door gasket may eliminate the required tight door seal. Clean only as specified in this manual.
- Do not allow acids (citrus juices, tomato sauces, etc.) to remain on the oven surfaces inside or outside the oven. The porcelain finish may stain.
- Do not use a steam cleaner to clean the oven. Steam could penetrate electrical components and cause a short circuit.
- Do not leave metal objects, such as aluminum foil, the meat probe, cookie sheets, etc. on the floor of the oven. Objects left on the bottom of the oven could trap heat in the bottom, damaging the bake element. In addition, the objects themselves could be damaged.
- Do not allow the glass panels in the top and bottom of the oven to become covered up by cookie sheets, aluminum foil, pots, pans, etc. Some of the ovens heating elements are behind the glass panels. Covering them could cause the heating elements behind them to over-heat, damaging the oven.
- To prevent damage, remove the meat probe from the oven when it is not being used.



# Getting to Know Your Oven

## Control Panel Layout

- **Control panel display:** The control panel display provides various types of information about your oven, including the current time (once the clock is set), the current cook settings, and the available cooking modes. The diagram below shows the display, as it appears when the oven is not in use. The information shown is referred to as the home screen.
- **Variable function keys:** The variable function keys are right below the display. The name of each key appears above it on the display and changes based on the screen. These keys are used to select the many different operating modes of your oven.
- **Number keypad:** When you want to make temperature and time adjustments or adjustments to some of your oven's deluxe features, use the number keypad.



**Light key:** If you need to turn the oven lights on or off when the oven door is closed, touch the light key.

## Permanent Function Keys



**Oven selection keys:** If you have a double oven, use these keys to turn the upper and lower ovens ON and OFF.



**CANCEL/SECURE key:** If you have a single oven, use this key to turn the oven off. If you have a double oven, use this key to turn both ovens off at the same time. This key sets all temperature settings back to zero and it turns off any features (except the timer) that are currently in use. It also activates the lock-out feature.



**TIMER key:** Use this key to time an event. Your oven has 2 timers. They operate separately from each other. They do not turn the oven on or off. You can use them even if the oven is not in use. See page 12 for instructions.



**START key:** When you use the various features (or modes) on your oven, set the controls first, then touch the **START** key.



**BACK/RECALL key:** Use this key to return to the previous screen on the display, or to view time settings once the oven is set.

**IMPORTANT:** When the oven is not in use, the display will go into "sleep" mode about five minutes after the last time any of the keys were touched or the door was opened. In sleep mode, the display lights go off to extend bulb life. To wake the display (make it reappear), touch one of the keys on the control panel or open the oven door.

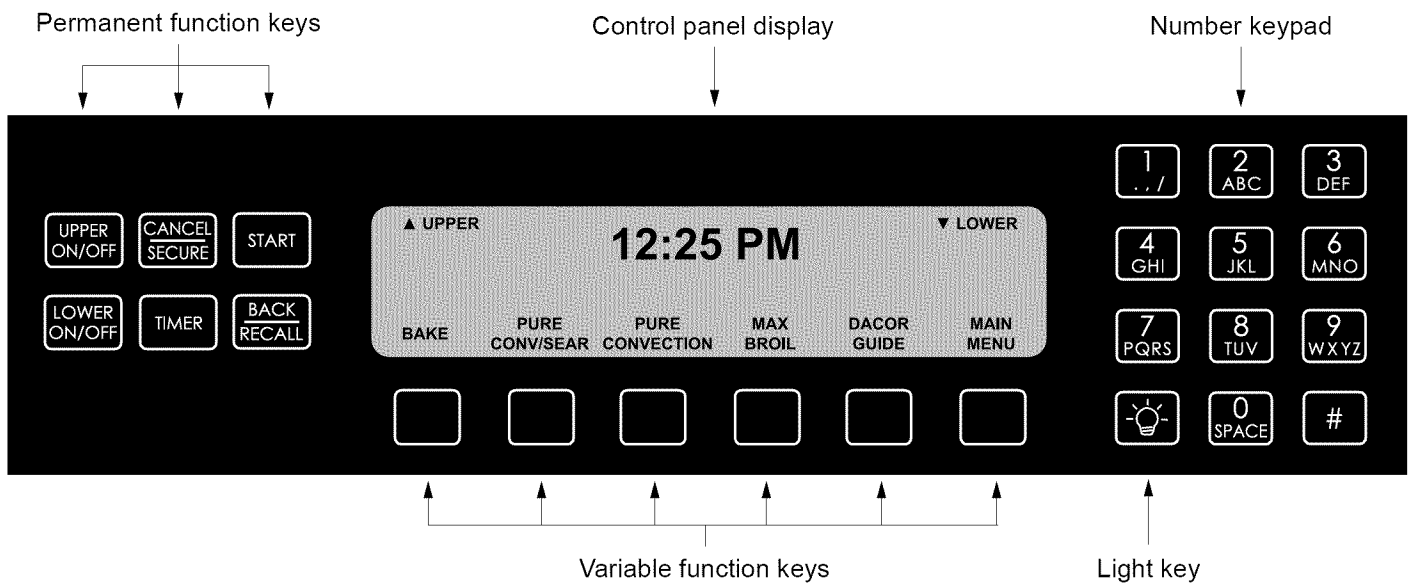

**The Wall Oven Control Panel**

# Getting to Know Your Oven

---

## Before Getting Started, Get Familiar With Your Oven

---

### Parts of the Oven:

- **Control panel:** Your oven's control panel consists of keys and a display. You use the control panel to control all the oven's features (sometimes called modes).
- **Oven racks:** Your oven comes with three adjustable oven racks. It comes with six if you have a double oven.
- **Rack supports:** There are six sets of rack supports inside each oven chamber. They support the adjustable oven racks.
- **Meat probe connector:** When you use the meat probe, insert the skewer into the meat and plug the other end into this connector. See the **Meat Probe** section on page 25 for proper operation.
- **Oven lights:** There are two oven lights inside the oven chamber so that you can easily see the food inside the oven when the door is open and through the oven window when the door is closed. The lights come on automatically when you open the oven door or you may touch the light key on the control panel to keep the lights on. The bulbs are 12 volt, 10 watt, halogen.
- **Bake elements:** Hidden below the glass panel on the floor of the oven chamber are the bake elements. They are the source of bottom heat.
- **Broil elements:** Hidden above the glass panel in the roof of the oven chamber are the broil elements. They are the source of top heat.
- **Convection fan:** The convection fan blows hot air into the oven chamber during the convection cooking process. The convection filter covers it.
- **Convection element:** The convection element creates the hot air that is blown into the oven chamber by the convection fan during the convection cooking process. The convection filter covers it.
- **Convection filter:** The convection filter covers the convection fan. It helps prevent the transfer of taste from one food to another when you are cooking a whole meal. It also keeps the oven cleaner, especially when roasting or broiling. In addition, it covers the moving fan blades for safety purposes.
- **Self-clean latch:** The self-clean latch automatically locks the oven door during the self-clean cycle. The door latches for your safety. There are very high temperatures inside the oven during the self-clean cycle.
- **Door gasket:** The door gasket prevents heat from escaping when the door is closed.

# Getting to Know Your Oven

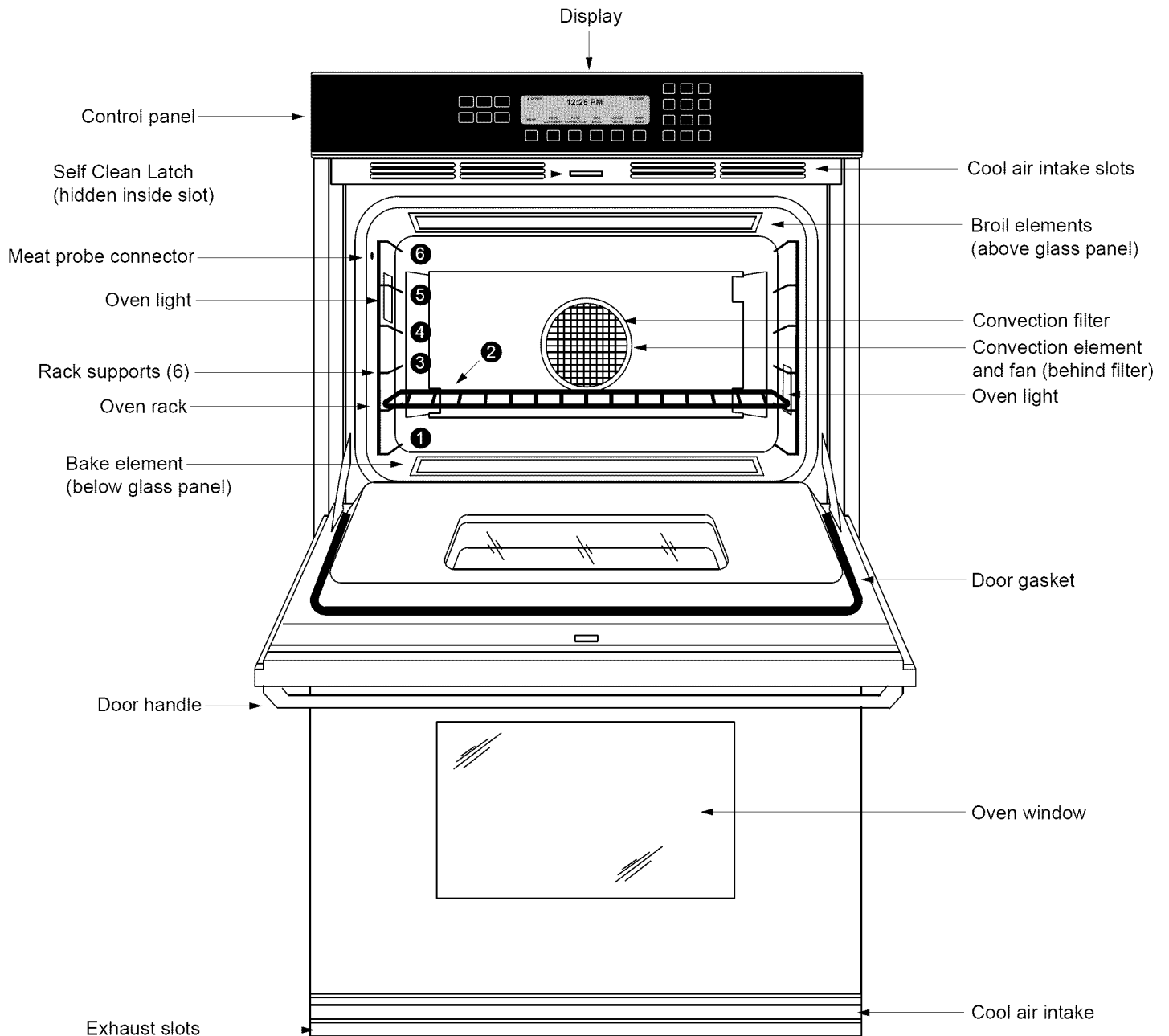

**The Parts of Your Wall Oven (Double Oven Shown)**

# Oven Setup

**NOTE:** If you have a single oven, you cannot set the clock, temperature scale, display colors, keypad tones or disable the oven lights while the oven is in use. If you have a a double oven, it is best not to change these settings while the oven is in use.

## Clock

### Setting the Time:

- Touch the **CANCEL/SECURE** key on the control panel to return to the home screen.
- Touch the **MAIN MENU** key.

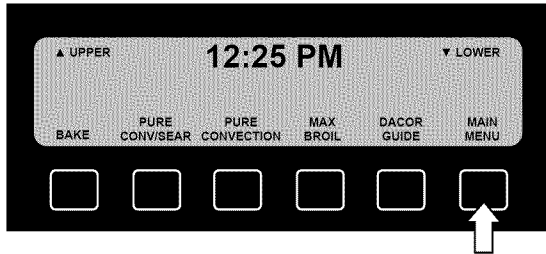

- Touch **ADDITIONAL SETTINGS**.

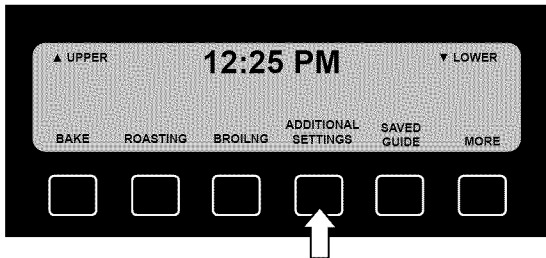

- Touch **CLOCK**.

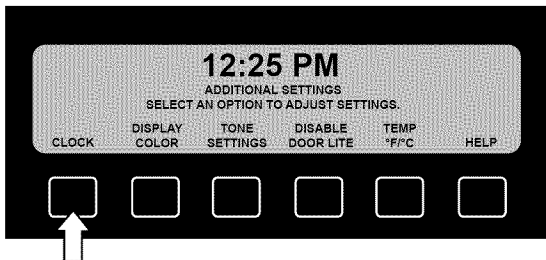

- The clock menu will appear. Touch **SET CLOCK**.

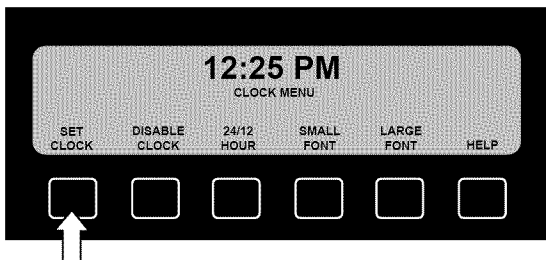

- Using the number keypad, enter the current time. For example: For 12:43 Touch **1**, then **2**, then **4**, then **3**.

- Touch the **AM - PM** key to change AM to PM or change PM to AM as needed.

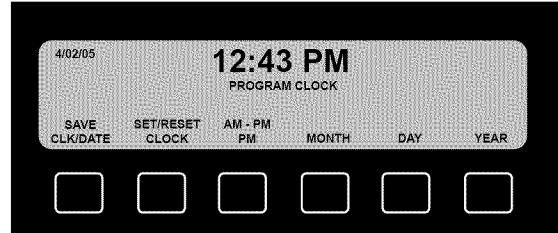

- Touch **MONTH**. Enter the current month on the keypad (for example: for June, touch **0**, then **6**).
- Touch **DAY**. Enter the current day of the month on the number keypad (for example: enter 0, then 8 for the 8th day of the month).
- Touch **YEAR**. Enter the current year (all 4 numbers) on the number keypad.
- Touch the **SAVE CLK/DATE** key.

THE CLOCK IS NOW SET. THE CURRENT TIME SHOULD APPEAR ON THE DISPLAY.

### Turning the AM/PM Indicator On or Off:

**NOTE:** The time display is larger when the AM/PM indicator is off and smaller when it is on. There is no AM/PM indicator when the display is set to military time.

- Touch the **CANCEL/SECURE** key on the control panel to return to the home screen.
- Touch the **MAIN MENU** key.

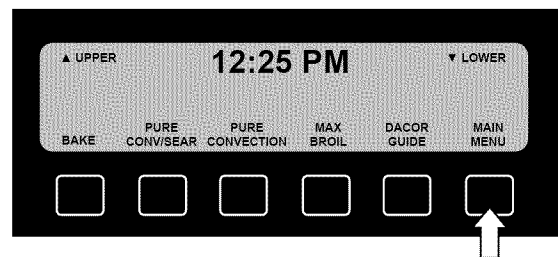

- Touch **ADDITIONAL SETTINGS**.

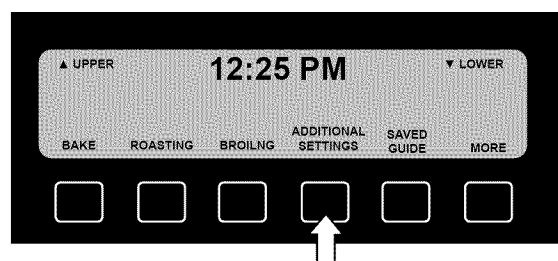

# Oven Setup

- Touch **CLOCK**.

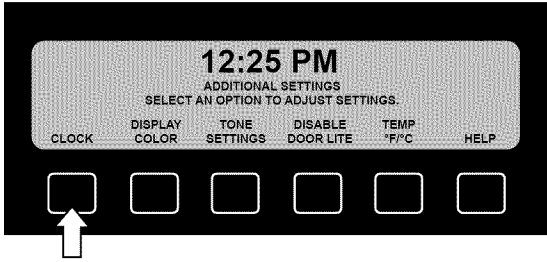

- Touch **SMALL FONT** to select the AM/PM indicator.
- Touch **LARGE FONT** to deselect the AM/PM indicator.

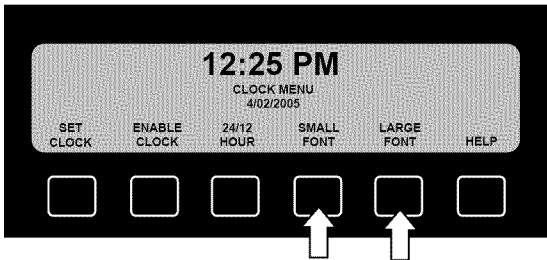

- Touch **CANCEL/SECURE** to return to the home screen.

## Changing the Size of the Numbers on the Clock (Fonts)

**NOTE:** If you switch the clock to large fonts, the AM/PM portion (if the clock is not set to military time) will disappear.

You have a choice of 2 different sizes of numbers for the clock, large and small. To change the size of the clock numbers:

- With the clock menu displayed (see **Setting the Clock**), touch **LARGE FONT** or **SMALL FONT**.

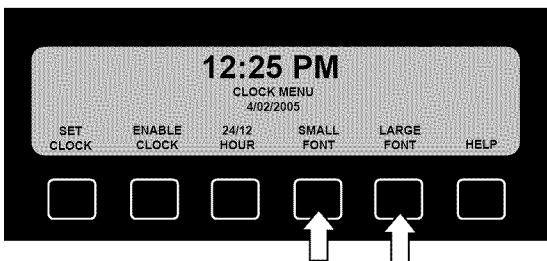

- Touch **CANCEL/SECURE** to return to the home screen.

## 24/12 Clock (Military Time)

**NOTE:** There is no AM/PM indicator when the display is set to military time.

If you want to switch the clock to military time or switch from military back to regular time (for example: 1:36 PM = 13:36 military time):

- With the clock menu displayed, touch the **24/12 HOUR** key.

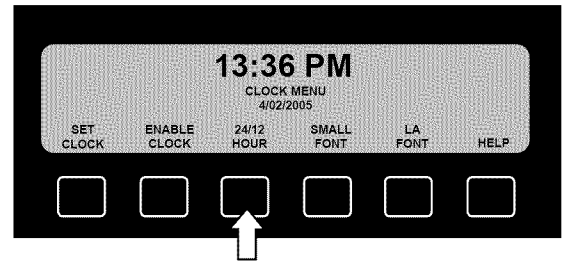

- Touch **CANCEL/SECURE** to return to the home screen.

## Enable/Disable the Clock

Disabling the **CLOCK** allows you to make the clock disappear from the control panel display. The clock will remain set to the correct time if you decide to enable it later. If you want to make the clock disappear from the control panel display (or make it reappear if it is not currently showing):

- With the clock menu displayed (see **Setting the Clock**), touch the **DISABLE CLOCK** or **ENABLE CLOCK** key.

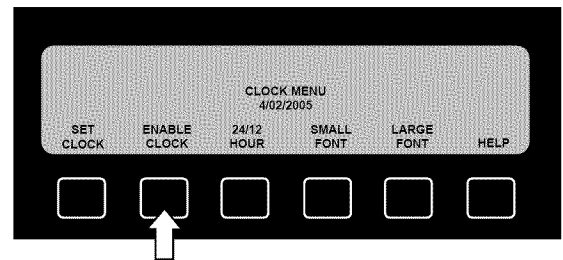

- Touch **CANCEL/SECURE** to return to the home screen.

# Oven Setup

## Fahrenheit (°F)/Celsius (°C)

- Your oven allows you to select the type of temperature scale that it uses to show the cooking temperature. The oven is preset at the factory to Fahrenheit.

To change the temperature scale:

- Touch the **CANCEL/SECURE** key on the control panel to return to the home screen.
- Touch the **MAIN MENU** key.

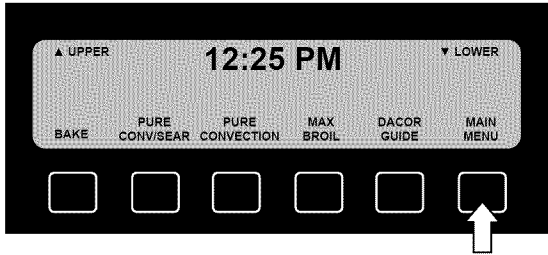

- Touch **ADDITIONAL SETTINGS**.

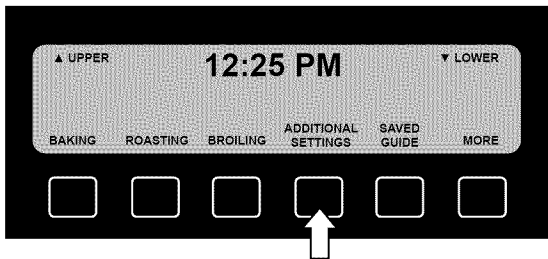

- Touch **TEMP °F/°C**. Touch **CELSIUS** or **FAHRENHEIT**, then touch **OK**.

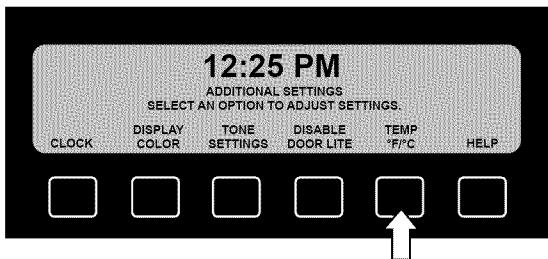

- Touch **CANCEL/SECURE** to return to the home screen.

## Display Colors

- The colors for the display are preset to **SILVER/GRAY** at the factory. If you want to change the display colors:
- Touch the **CANCEL/SECURE** key on the control panel to return to the home screen.
- Touch the **MAIN MENU** key.

- Touch **ADDITIONAL SETTINGS**.

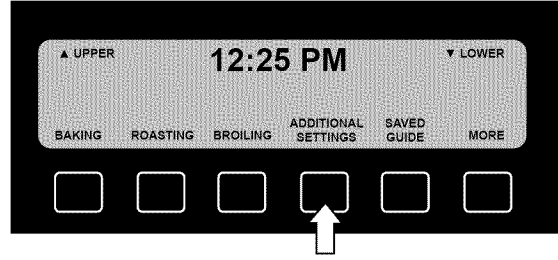

- Touch **DISPLAY COLOR**.

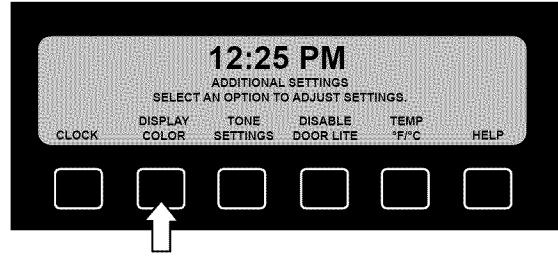

- Touch the **AMBER**, **BLUE/GREEN** or **SILVER/GRAY** key. You may also touch **REVERSE COLOR** to switch the background color with the text color.

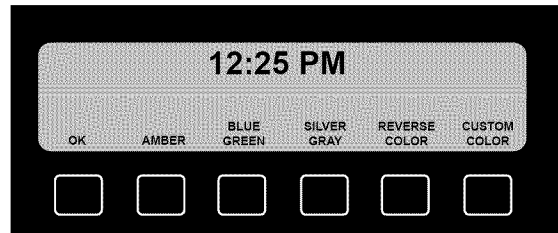

## Custom Color Display Settings

If you want a color other than standard display color settings available on your oven, you can create a special color scheme. To do so:

- Touch **CUSTOM COLOR**.

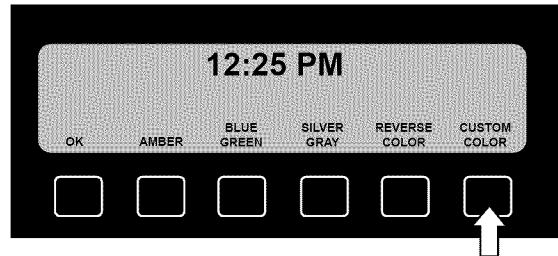

# Oven Setup

- Touch the **RED, GREEN** or **BLUE** key.

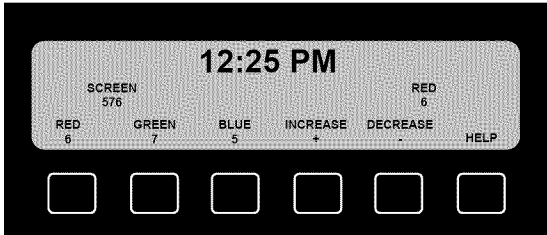

- Touch **INCREASE** or **DECREASE** to change the hue of the color selected.
- You can select each of the three colors and **INCREASE** or **DECREASE** each color until you find the display color you like best. There are ten settings for each of the three colors. Sometimes it may take a few seconds for the colors to settle on the screen, after **INCREASE** or **DECREASE** are touched.
- Touch **CANCEL/SECURE** to return to the home screen.

## Oven Tones

- If you want to change the tone or volume of the beeps that are heard when operating the oven control panel and when the timer expires:
- Touch the **CANCEL/SECURE** key to return to the home screen.
- Touch the **MAIN MENU** key.

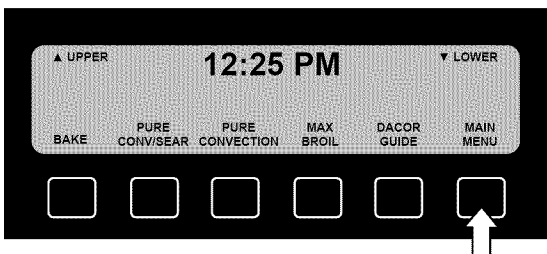

- Touch **ADDITIONAL SETTINGS**.

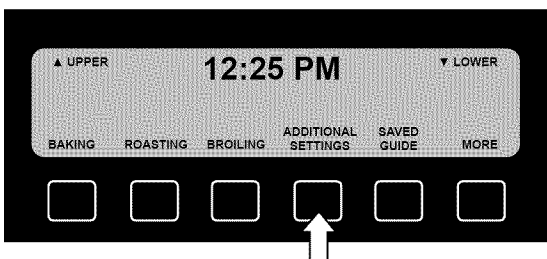

- Touch **TONE SETTINGS**.

If you want to change the volume:

- Touch the **VOLUME (LO/HI)** key. The display will indicate the volume level, **LOW, MEDIUM** or **HIGH**.

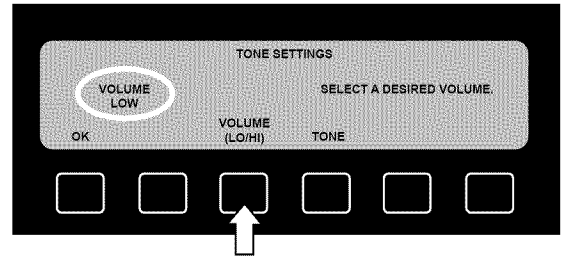

- Repeatedly touch **VOLUME (LO/HI)** until the volume level you want is displayed. You can test each volume level by touching the key just to the left of the **VOLUME (LO/HI)** key.

If you want to change the tone:

- Touch **TONE**.
- The **TONE (LO/HI)** option will appear.
- Touch the **TONE (LO/HI)** key. The display will indicate the pitch of the tone, **LOW, MEDIUM** or **HIGH**.

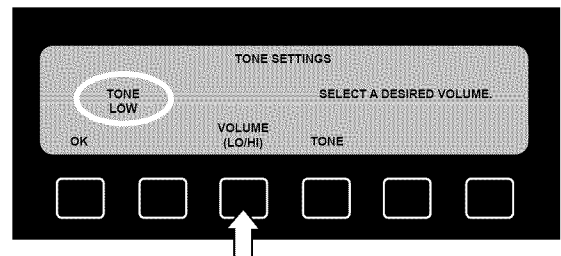

- Repeatedly touch **TONE (LO/HI)** until you hear the tone you want. You can test each tone by touching the key just to the left of the **TONE (LO/HI)** key.
- Touch **CANCEL/SECURE** to return to the home screen.

## Oven Lights

If you don't want the oven lights to come on when the oven door is open or the door lights are not currently set to come on when the door is open:

- Touch the **CANCEL/SECURE** key on the control panel to return to the home screen.
- Touch the **MAIN MENU** key.
- Touch **ADDITIONAL SETTINGS**.
- Touch **ENABLE/DISABLE DOOR LITE**.
- Touch **CANCEL/SECURE** to return to the home screen.

**NOTE:** The lights will continue to come on when the light key is touched, unless the oven is in Sabbath mode.



# Operating Your Oven - The Basics

## Before You Cook

- When the oven is not in use and none of the keys on the control panel have been touched for about five minutes, the display will go to "sleep." When the display is sleeping, it is not lit. To wake the display (make it reappear), touch one of the keys on the control panel or open the oven door.
- When you use your oven to bake or roast, it preheats automatically. The preheat cycle rapidly brings the oven chamber up to the proper cooking temperature. It usually takes 7 to 14 minutes to preheat the oven, depending on the temperature settings. Pre-heat times may be longer depending on the type of electrical supply in your community. There is no preheat cycle for any of the broil modes.
- After you pull food out of the oven, it will continue to cook. This is called carry-over. The larger the portion of food, the longer it will carry-over. It is best to let the meat rest after it comes out of the oven for 10 to 15 minutes before carving. Doing so will allow the meat to retain its juices and make it easier to carve.

## Standard Racks

### **WARNING**

Rearrange the oven racks only when the oven is cool.

## How to Insert Standard Oven Racks

- Insert the end of the rack with the safety notches into the oven first.
- Attach both sides of the rack to the rack supports in the oven as shown in the diagram below.
- Begin to slide the rack in, and then, lift up so that the safety notches clear the ends of the rack supports.

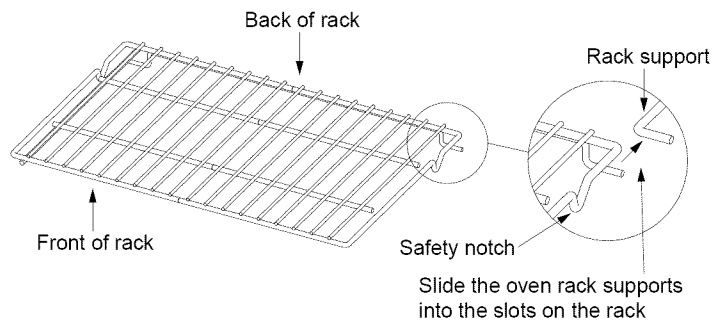

### **Inserting a Standard Oven Rack**

- Push the rack all the way in with both hands.

## How to Remove Standard Oven Racks

- If you want to remove an oven rack, grasp it with both hands and pull gently straight out toward you until it stops.
- To remove the rack completely, lift the front of the rack up about six inches and continue to pull out. Lifting the rack releases the safety notches. The safety notches prevent the rack from coming out of the oven accidentally.

## Glide Rack™ Oven Racks

Your oven comes with a Dacor GlideRack oven rack. You can pull this type of rack out further than the standard racks and still support heavy pots and pans full of food. It is great for heavier foods and the baking stone.

### **WARNING**

Rearrange the oven racks only when the oven is cool.

## How to Insert Your GlideRack Oven Rack

- Hold the rack with the guides fully extended away from you (see diagram below).
- Align both sets of safety clips (right and left) on the back of the guides with the oven rack supports as shown in the diagram below.
- Begin to slide the rack in, lifting the front safety clips over the front of the oven rack supports.

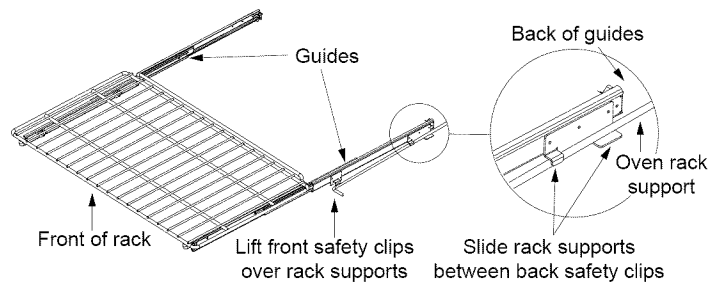

### **Inserting a GlideRack™ Oven Rack**

- Push the rack all the way to the back.
- Grasp the rack in the center of the front and pull. The rack should come forward while the guides remain in place.

## How to Remove Your GlideRack Oven Rack

- If you want to remove rack, grasp it with both hands and pull gently straight out toward you until it stops.
- To remove the rack completely, lift the front up about six inches and continue to pull out. Lifting the rack releases the safety clips. The safety clips prevent it from coming out of the oven accidentally.



# Operating Your Oven - The Basics

## Quick Start Guide

The four most commonly used modes are on the home screen for instant access.

### Bake

- Bottom heat source, mode commonly used for basic recipes.

### Pure Convection™/Sear

- Same as Pure Convection™, but runs 75°F hotter than the set temperature for the first 15 minutes to sear in the juices. Excellent for roasting.

### Pure Convection™

- Rear heat source with fan to even the heat in the oven. Excellent for baked goods and multiple rack cooking.

### Max Broil

- Top heat source. Used for grilling meats or toasting breads.

**NOTE:** For a description of all oven modes, please see the **Main Menu** section on page 14.

## Starting the Oven(s)

- Position the racks to the appropriate level.
- For double ovens: Touch the **UPPER ON/OFF** or **LOWER ON/OFF** key ❶ to select the oven you wish to use. For single ovens, go to next step.
- If you will be using **PURE CONVECTION™ SEAR** or **MAX BROIL**, carefully place the food in the oven before proceeding to the next step.
- Touch the appropriate key ❷ (for example: **BAKE**). The display will show the "jump-in" temperature (350°F for **BAKE**). If acceptable, touch **START** ❸. If you want to cook at a different temperature, enter the temperature on the number keypad ❹, then touch **START** ❸.

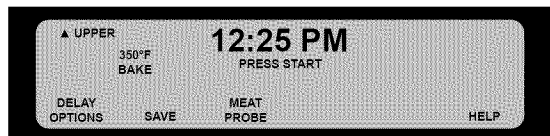

Display Showing Jump-In Temperature

- If you are using the **BAKE** or **PURE CONVECTION™** modes, "**PREHEATING**" will appear in the display until the oven reaches the set temperature. Once the set temperature is reached, the oven will beep and "**PREHEATING**" will disappear from the display. Carefully place your food into the oven.

## Turning Off The Oven(s)

- To turn the oven off, for double ovens, touch the **UPPER ON/OFF** or **LOWER ON/OFF** key ❶. For single ovens, touch the **CANCEL/SECURE** key ❺.
- For double ovens, touch the **CANCEL/SECURE** key ❺ to turn off both oven chambers at once.
- Changing The Temperature
- Touch **EDIT** (for double ovens, touch the **EDIT** key below the appropriate oven).
- Enter the temperature on the number keypad, then touch **START**.

## Locking The Control Panel

- If you want to disable the keys on the control panel when the oven is not in use, touch and hold the **CANCEL/SECURE** key for 5 seconds. The control panel will lock. Only the **CANCEL/SECURE** key will remain functional. To reactivate the control panel, touch and hold the **CANCEL/SECURE** key for 5 seconds.



Display Showing Preheating

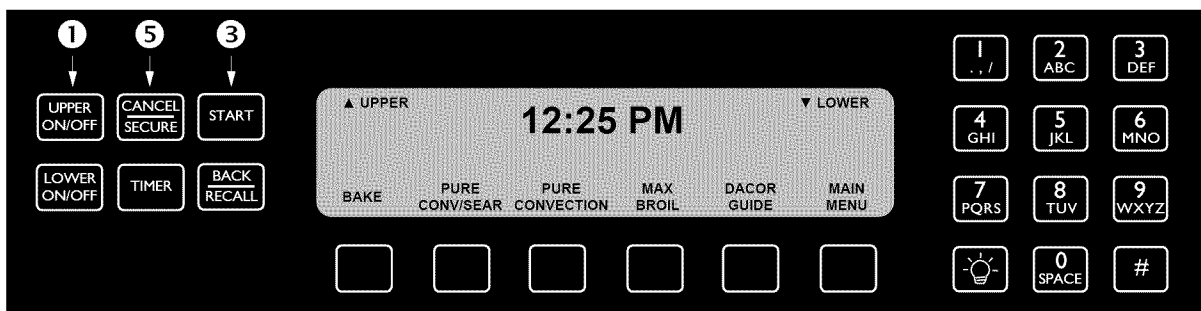

Key Locations

# Deluxe Features

## Help Menu

The **HELP** key on your oven can help you to better understand how your oven works. The **HELP** key appears on the control panel display most of the time after you have selected one of your oven's features. If you want to find out more about the various choices available to you, touch the **HELP** key.

Here is an example:

- If you have a double oven, touch the **UPPER ON/OFF** or **LOWER ON/OFF** key to select the oven you want to use.
- Touch the **BAKE** key.

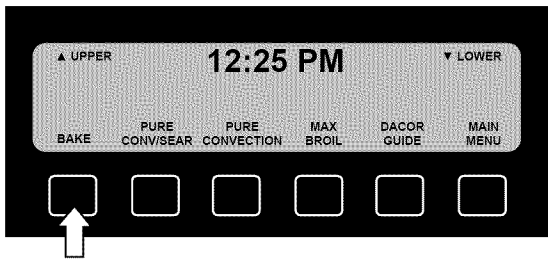

- The **BAKE** screen appears.
- Touch **HELP**.

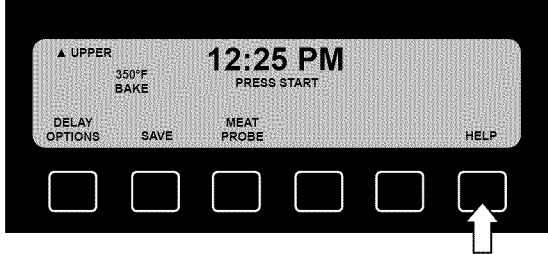

- The **HELP** screen appears with a description of how to use the bake mode (setting).

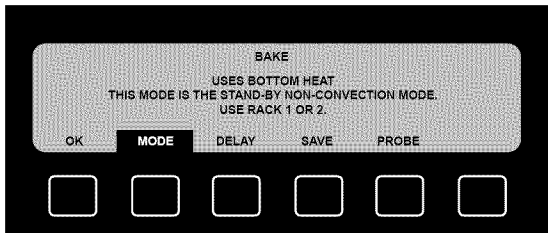

- To find out what each of the keys on the bake screen does, touch that key. For example, if you touch the **DELAY** key, the display tells you about what the **DELAY OPTIONS** mode does.
- Touch **OK** to return to the **BAKE** screen or **CANCEL/SECURE** to return to the home screen.

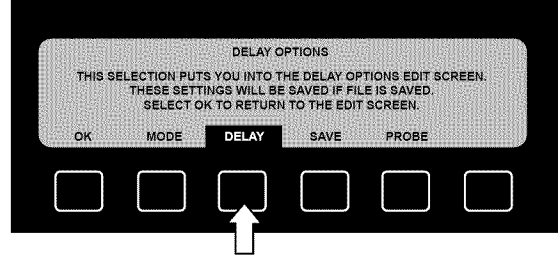

## Timers

### WARNING

The timers on your oven do not turn the oven on or off. They are only for timing purposes. When you want to turn the oven on or off automatically, use the delay options (see page 23)

**NOTE:** Touching the **CANCEL/SECURE** key does NOT turn off the timers.

Your wall oven is equipped with two built-in timers:

- You can use both of them at the same time.
- They have distinctive alarm tones so that once time runs out, you can tell which one has beeped.
- You may want to set each timer for a few seconds and let time run out so that you can hear the difference between the 2 tones.

**To Use the Timers on Your Oven:**

- Touch the **TIMER** key.
- The timer screen appears.
- Touch the **TIMER 1** or **TIMER 2** key. For example, touch **TIMER 1**.

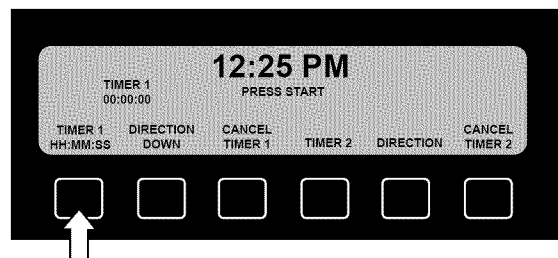

# Deluxe Features

- Enter the hours, minutes and seconds to be timed on the keypad. For example: to enter 1 hour, 2 minutes and 30 seconds (1:02:30), touch **1-0-2-3-0**. You need to enter the number of seconds being timed even if it is zero. For example: You must enter 5 minutes and no seconds as **5-0-0** to get 00:05:00 on the timer. If you don't enter **0-0**, after **5**, then the timer will only run for 5 seconds (you will have entered 00:00:05).
- The time entered appears just above the **TIMER 1** (or **TIMER 2**) key.

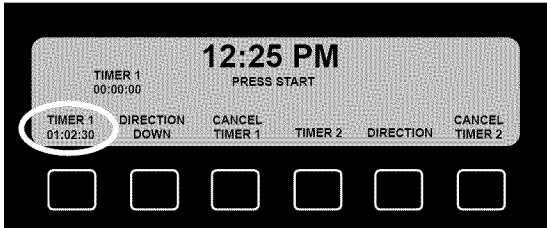

- Determine if you want the timer to count up or count down. For example: if you set the timer for 01:30:00 counting down, the timer will start at 01:30:00, count down to 00:00:00, then beep. If you set the timer for 01:30:00 counting up, the timer will start at 00:00:00, count up to 01:30:00, then beep. Touch the **DIRECTION** key until the desired direction is displayed.
- To make the timer start counting, touch **START**. The amount of time the timer is set for will continue to appear just above the **TIMER 1** (or **TIMER 2**) key. The amount of time left on the timer will appear above the **DIRECTION** key.

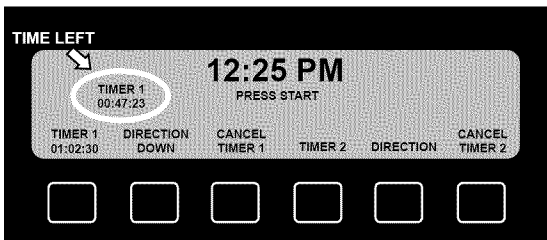

- If the oven is on when the timer is set, the display will return to the oven mode screen a few moments after the timer is started.
- If the oven is not on, touch **BACK/RECALL** to return to the regular cooking display.
- If you want to stop a timer before it has beeped, touch the **TIMER** key, then touch **CANCEL TIMER 1** or **CANCEL TIMER 2**.

## Dacor Guide: Cook By Food

Your oven is equipped with a great convenience: the Dacor Guide Cooking System. Dacor Guide takes a lot of the guesswork out of cooking. You select the type of food, and the oven will set the temperature and mode and show you the amount of time required to cook it.

### How to Use Dacor Guide:

- Before you turn on the oven, position the racks.
- If you have a double oven, touch the **UPPER ON/OFF** or **LOWER ON/OFF** key to select the oven you want to use.

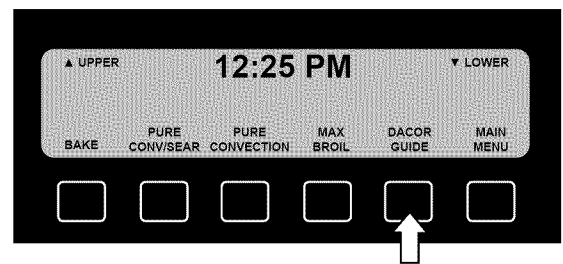

- Touch the **DACOR GUIDE** key.

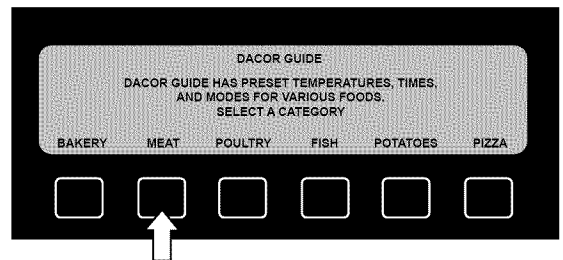

- Select the category of food you want to cook. For example, **MEAT**.
- If you select **BAKERY** or **MEAT**, the oven will ask you to pick a bakery or meat category. For example, **BEEF/VEAL**. If you did not select **BAKERY** or **MEAT**, go to the next step.

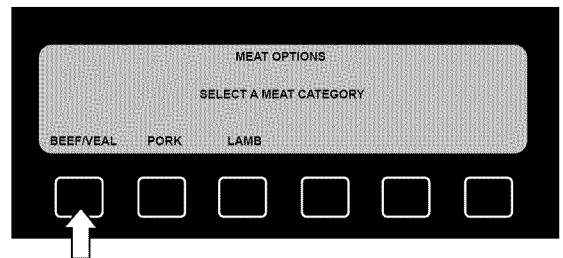

# Deluxe Features

- To select the specific type of food, touch the correct number on the number keypad.

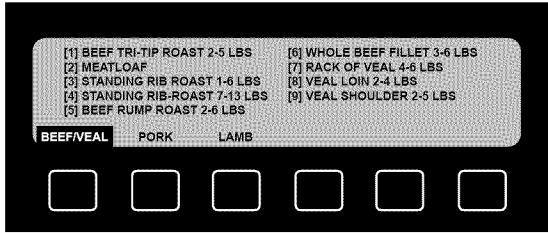

- The Dacor Guide instructions were tested to give you the optimal mode and temperature by food. Touch the **HELP** key for detailed instructions on how to prepare the food.

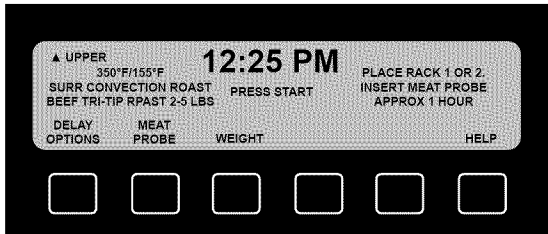

- If you are cooking meat or poultry, touch the **WEIGHT** key and enter the weight of the meat you are cooking on the number keypad.

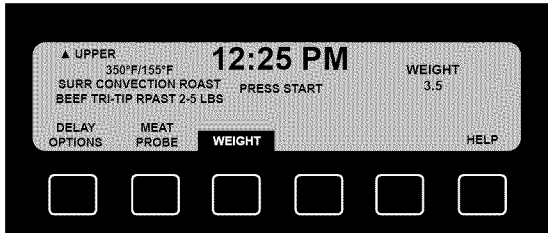

- If you want, you can change the meat probe temperature by touching the appropriate key and entering the changes on the number keypad.
- Touch the **START** key.

## Important Tips for Using Dacor Guide

- In some cases the display may instruct you to place the food in the oven and then touch **START**. In other cases the oven will preheat when you touch **START** and instruct you to place the food in the oven when you hear the preheat tone ("**WAIT FOR PRE-HEAT TONE**").
- If the display instructs you to "**INSERT MEAT PROBE**", insert the probe into the meat prior to putting the food into the oven. See pages 25 and 26 for complete instructions on how to use the meat probe. **NOTE:** It is not necessary to use the meat probe, but it is a very convenient, safe feature. Touch the **PROBE** key twice to disable it. "**NO PROBE**" will appear on the display, which is normal.

- If you are using the timer, start it when you place the food in the oven.
- If the Dacor® Guide instructions read "**COOK UNTIL...**" or "**SET TIMER FOR...**" you will need to check the food for doneness yourself.
- If you use the meat probe, the oven will automatically stop cooking when the meat has reached the desired temperature. The oven will then reduce the temperature to a level that will keep the meat warm for up to 2 hours ("**HOLD**" will appear on the display).
- In all other instances, the oven will cook the food for the amount of time shown on the Dacor® Guide display. When the oven is through cooking for the amount of time indicated, it will beep and reduce the temperature to a level that will keep the food warm for up to 2 hours ("**HOLD**" appears on the display). At the end of the hold cycle, the oven will turn off and "**CYCLE COMPLETE**" will appear on the display. Touch **CANCEL/SECURE** to clear the control panel.
- To turn off your oven during **DACOR GUIDE** mode:
  - Double oven: Touch **UPPER ON/OFF** or **LOWER ON/OFF**. To turn off both ovens at the same time, touch **CANCEL/SECURE**.
  - Single oven: Touch **CANCEL/SECURE**.

## Main Menu

The main menu allows you to access your oven's deluxe features and cooking modes.

- To access the main menu, touch the **MAIN MENU** key on the home screen.

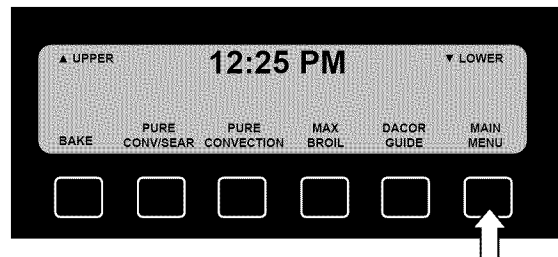

- The main menu will appear.

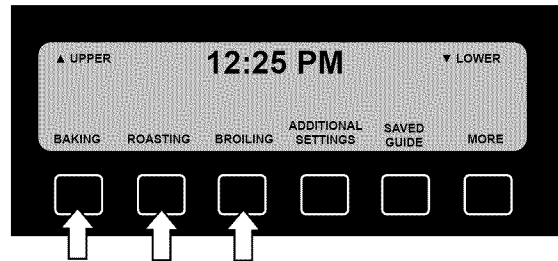

The three basic styles of cooking in an oven are:

- Baking:** Cooking dry goods such as cookies, cakes, soufflés, etc.
- Roasting:** Cooking of meats over a period of time.
- Broiling:** Cooking with an intense heat for a short amount of time.

# Deluxe Features

As seen on the main menu diagram on the facing page, there are 3 options available. When one of these three keys is touched, the mode options available for that style of cooking appear on the screen. When you select a mode option for a particular cooking style the "jump-in" temperature is shown for that mode. This is the temperature that will automatically come up when you select the mode. To change the temperature, just enter the desired temperature on the number keypad and touch **START**.

## Baking

When you touch the **BAKING** key on the main menu, the **BAKING** menu appears.

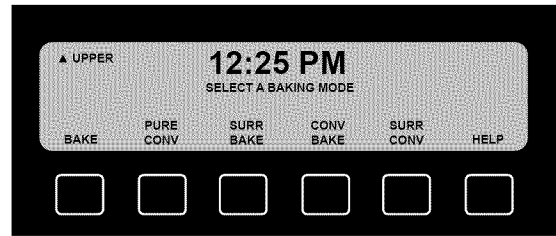

## Baking Modes

| Baking Modes:            | Description:   | Jump-In Temperature and Cooking Suggestions:  |
|--------------------------|--|---|
| BAKE                     | Uses only a heat source from below the food. This mode is the stand-by, non-convection mode. All baked items will turn out nicely in this mode.  | Jump-in temperature: 350°F. Follow original times and temperatures.   |
| PURE CONVECTION™         | Uses only convection heat. Best for multiple rack items, cakes, tarts, puff pastries, cookies, free form yeast breads, scones, muffins, and yeast rolls. This mode is best for light colored and delicate baked goods.   | Jump-in temperature: 325°F. Lower standard recipes by 25°F. For baking time, use the lowest stated time in the recipe and add more time if necessary. If multiple-rack baking with 3 or more racks, increase time by 5-15 minutes on average.             |
| SURROUND BAKE            | Uses heat sources that are above and below the food. This mode is best for angel-food cake, fruit cobblers, quick breads, soufflés, and cheesecakes baked in a water bath. Egg-leavened items turn out best in this mode because they still get a nice rise without over-browning or curdling. Thick battered breads, such as banana bread, bake well in this mode because they cook through while providing the correct amount of browning. | Jump-in temperature: 350°F. No temperature or time adjustments are necessary in this mode.  |
| CONVECTION BAKE          | Uses a combination of convection cooking and a heat source below the food. This mode is best for fruit crisps, custard pies, double-crusted fruit pies, quiches, yeast breads in a loaf pan, and popovers. Also, items baked in a deep ceramic dish or earthenware clay pots are best in this mode. These are items in a deep pan that require browning on the top and bottom.   | Jump-in temperature: 325°F. Lower standard recipes by 25°F. Since these items require a longer cook time, convection bake time is on average about 25% shorter. Set timer 15 minutes before the lowest stated temperature and add more time if necessary. |
| SURROUND CONVECTION BAKE | Uses a combination convection cooking and heat sources above and below the food. This mode is best for bagels, biscuits, and pretzels. These thin items are often in a shallow pan and require dark browning on the top and bottom. This mode will provide the quickest cook time and the darkest overall browning for baked goods.  | Jump-in temperature: 325°F. Lower standard recipes by 25°F. Since these items cook for a very short period of time, there are no time adjustments.  |

# Deluxe Features

## About Pure Convection Baking

- The uniform air circulation provided by Pure Convection allows you to use the full capacity of your oven. You can successfully prepare food, like cakes, cookies, muffins, and rolls on 2 or 3 racks at the same time. You can also prepare complete meals using multiple racks.

 AIR FLOW

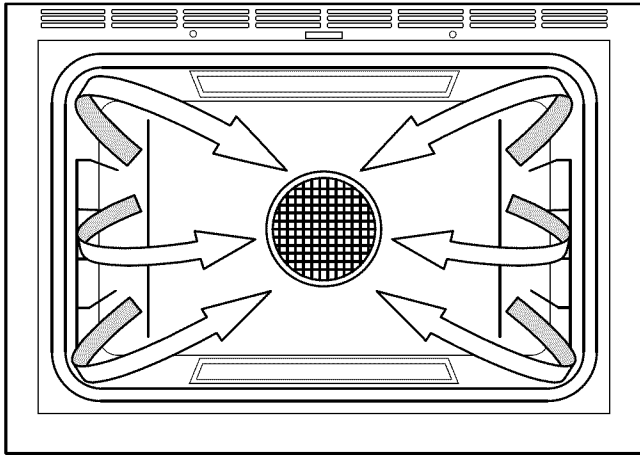

**Pure Convection - Direction of Airflow**

- Some recipes, especially those that are homemade, may require adjustment and testing when converting from standard baking to convection baking. If you are unsure how to convert a recipe, begin by preparing the recipe using the standard bake settings. After achieving acceptable results, follow the convection guidelines below. If the food is not cooked to your satisfaction during this first convection trial, adjust one recipe variable at a time (such as cooking time, rack position or temperature) and repeat the convection test. If necessary, continue adjusting one recipe variable at a time until you get satisfactory results.
- As a general rule, to convert conventional standard bake recipes to convection recipes, reduce the temperature by 25°F and the cook time by approximately 10%.

### Baking Tips

- Do not open the oven door frequently during baking. Look through the oven door window to check the progress of baking whenever possible.
- Use the oven timers to determine baking time.
- Wait until the shortest recommended baking time before checking food. For most baked goods, a wooden pick placed in the center should come clean when the food is done.

| <b>Problem:</b>                                       | <b>May Be Caused By:</b>                                    | <b>What To Do:</b>  |
|---|---|---|
| Cookies burn on the bottom                            | Oven door opened too often                                  | Set timer to shortest recommended cooking time and check food when timer beeps. Use door window to check food |
|   | Incorrect rack position used. Pan too close to bake element | Change rack position  |
|   | Incorrect baking mode being used                            | See chart on page 15 to select correct baking mode  |
|   | Dark, heat absorbing cookie sheets used                     | Use shiny, reflective cookie sheets   |
| Cookies are too brown on top                          | Rack position being used is too high                        | Change rack position  |
|   | Food placed in oven during preheat                          | Wait until oven is preheated  |
|   | Incorrect baking mode being used                            | See chart on page 15 to select correct baking mode  |
| Cakes burn on the sides or are not done in the center | Oven temperature too high                                   | Reduce oven temperature   |
|   | Dark, heat absorbing cake pans used                         | Use shiny, reflective cake pans   |
| Cakes crack on top                                    | Oven temperature too high                                   | Reduce oven temperature   |
| Cakes are not level                                   | Oven and/or oven rack not level                             | Level oven and rack as needed   |
| Pies burn around edges or are not done in the center  | Oven temperature too high                                   | Reduce oven temperature   |
|   | Dark, heat absorbing pans used                              | Use shiny, reflective pans  |
|   | Oven and/or rack over-crowded                               | Reduce number of pans   |

### Solutions to Common Baking Problems

# Deluxe Features

## Roasting

- When you touch the **ROASTING** key on the main menu, the **ROASTING** menu appears. See the table below for roasting guidelines.

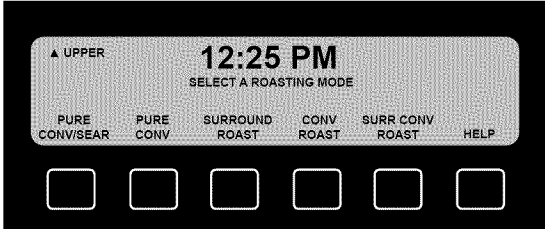

## Broiling

- When you touch the **BROILING** key on the main menu, the **BROILING** menu appears. See the table below for broiling guidelines.

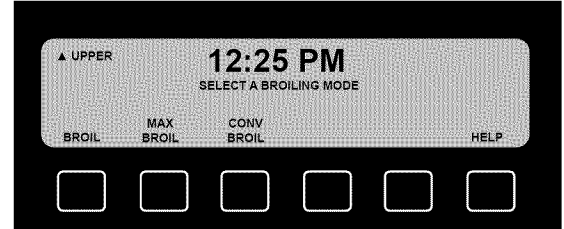

## Roasting Modes

| Roasting Modes:           | Description:   | Jump-In Temperature:        |
|---------------------------|--|-----------------------------|
| PURE CONVECTION™ SEAR     | The browning process sears the surface of the meat to keep the natural juices from escaping. In Pure Convection™ Sear mode, the oven cooks the meat 75°F higher than set temperature for the first 15 minutes. This mode is best for game hens, chickens, stuffed and un-stuffed turkeys, turkey breasts, pork tenderloin, and pork loins. | Jump-in temperature: 350°F. |
| PURE CONVECTION™          | Uses only convection heat. No other heat sources are used. Best for whole roasted duck, lamb shoulder, and short leg of lamb.  | Jump-in temperature: 325°F  |
| SURROUND ROAST            | Uses heat sources that are above and below the food. Best for half and whole cooked hams, rack of veal, and rack of lamb. When braising in the oven, cover foods with foil if necessary.   | Jump-in temperature: 375°F. |
| CONVECTION ROAST          | Uses a combination of convection cooking and a heat source below the food at the same time. Best for rib roasts, boned and rolled loins, and oven-braised meat and poultry that are covered.   | Jump-in temperature: 350°F. |
| SURROUND CONVECTION ROAST | Uses a combination of convection cooking and heat sources above and below the food. Best for meatloaf and fish fillets. This mode provides the quickest sear and is best for individual, portion cut items that need browning on the top and to cook quickly.  | Jump-in temperature: 350°F. |

## Broiling Modes

| Broiling Modes:  | Description:   | Jump-In Temperature: |
|------------------|--|----------------------|
| BROIL            | Uses a heat source from above the food. Best for smaller amounts broiling, i.e. 2-4 hamburger patties.   | 555°F                |
| MAX BROIL        | Uses 2 heat sources from above the food. Best for larger quantities of food to be broiled.   | 555°F                |
| CONVECTION BROIL | Uses a combination convection cooking and a heat source from above the food. Best for items that do not need to be flipped such as, thinner cuts of meat, fish and garlic bread. | 555°F                |

# Deluxe Features

## Broiling Tips

- Broiling is a quick and flavorful way to prepare many foods, including steaks, chicken, chops, hamburgers, and fish.
- Broiling in the oven is done with the oven door completely shut.

**NOTE:** The heating elements are disabled when the door is open.

- It is normal and necessary for some smoke to be present to give the food a broiled flavor. You can adjust the broil temperature in 5°F increments from a minimum of 135°F up to the maximum setting of "HI". The "HI" setting is the equivalent to 555°F.
- Setting the timer is recommended to time the broiling process.
- The cooling fan may continue to run for 30 to 45 minutes depending upon the length and temperature of the broiling process.
- Always use a broiler pan and grill to provide drainage for excess fat and grease. Doing so will reduce spatter, smoke, and flare-ups.
- Start with a room temperature broiler pan for even cooking.
- Use tongs or a spatula to turn and remove meats. Never pierce meat with a fork because the natural juices will escape.
- Broil food on the first side for a little more than half of the recommended time, then season and turn. Season the second side just before removing the food from the oven.
- To prevent sticking, lightly grease the broiler grill. Excess grease will result in heavy smoke. For easier cleaning, remove the broiler pan and grill when the food is removed.

## Additional Settings

See **Oven Setup** starting on Page 6.

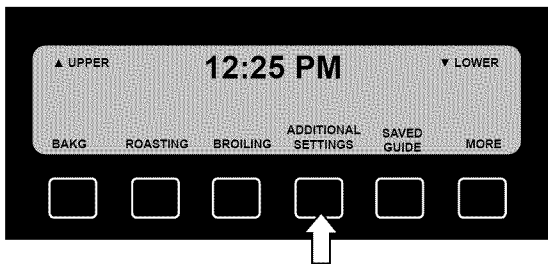

## Saved Guide

The save feature allows you to save the oven settings for up to 100 of your favorite recipes. Once you save the settings, your oven remembers them and can use them to automatically set the temperature, meat probe, and cooking time so that you don't have to look them up.

### To save the oven settings for your favorite recipe:

- You save the settings after you select the feature you want to use, but just before touching the **START** key.
- If you want to use the save feature, start by setting up your oven the way you normally would according to the cooking, dehydrate, defrost, and proof sections of this manual.
- Before you touch the **START** key, touch the **SAVE** key.

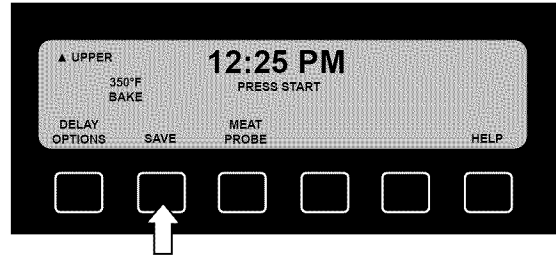

- Touch **CLEAR** if you want to remove the letters already on the display.
- Use the keys below the display and on the number keypad to enter the name of the recipe. To enter letters, touch the key with the letter you want on it repeatedly until that letter appears on the display. Pause for five seconds before entering a new letter or number.

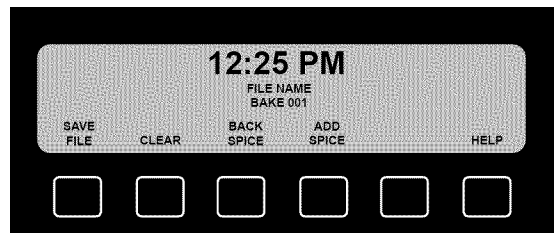

- Touch the **SAVE FILE** key.

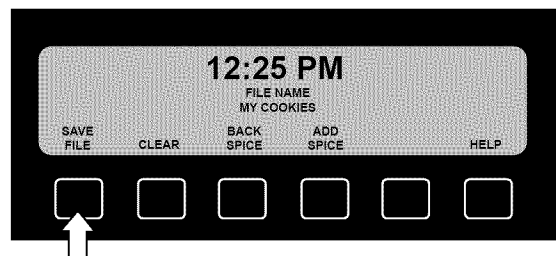



# Deluxe Features

**NOTE:** Saved recipes will NOT be lost in the event of a power outage.

- The display will tell you that you have successfully saved the file for your recipe.
- Touch the **OK** key.

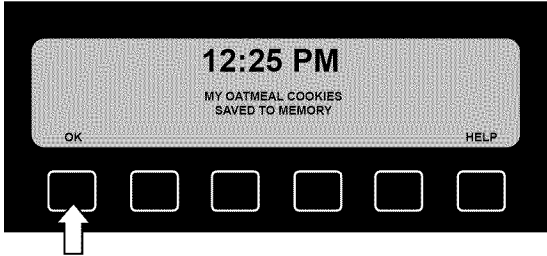

- Touch **START** to start cooking, or touch **BACK/RECALL** three times to return to the home screen.

## How to Use the Oven Recipe Settings You Have Saved

- Touch the **MAIN MENU** key.

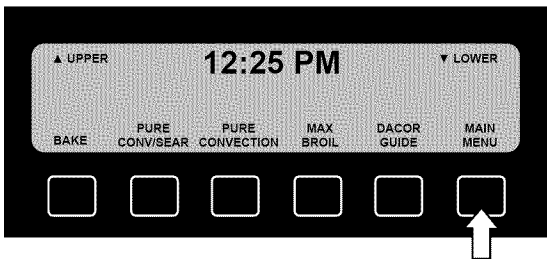

- Touch **SAVED GUIDE**.

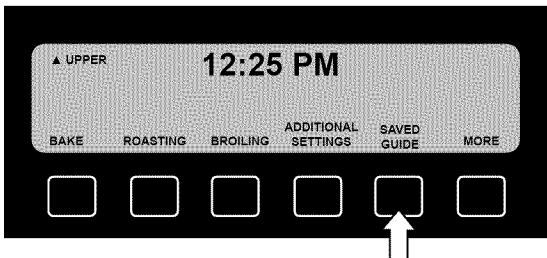

- Touch the number on the keypad of the recipe setting you want to use. If you have more than ten recipe settings saved, you will need to touch the **NEXT** key until you see the recipe you want to use appear on the display.

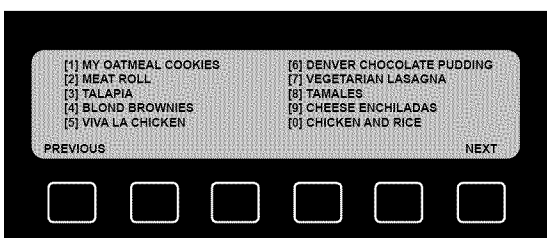

- Touch **START**.

## More

- From the main menu, touch the **MORE** key to access the following deluxe features and modes.

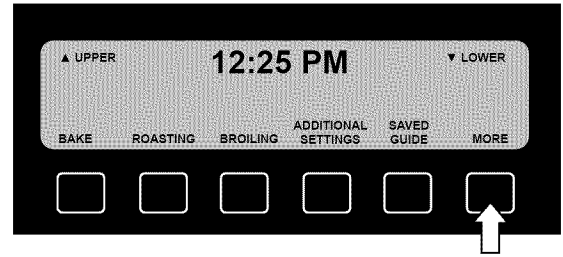

## Sabbath

The Sabbath mode on your oven complies with Jewish laws for use on the Sabbath and Holy Days. This feature allows the oven to perform two types of cooking, **BAKE** and **PURE CONVECTION**. The settings the oven will run during the Sabbath or Holy Day can be set in advance using the **DELAY OPTIONS** feature.

When the oven is set to Sabbath, it disables the following features:

- The oven lights
- The meat probe
- The number keypad, including the light switch
- The **TIMER** key
- The **BACK/RECALL** key
- The **START** key
- The keys
- The sleep feature is turned off so that the display is always visible.

**NOTE:** In the event of a power outage, the oven will return to Sabbath mode when power is restored.

## Setting Up the Sabbath Feature

**NOTE:** You may want to use a rack thermometer to keep track of the oven temperature.

- If you have a double oven, touch the **UPPER ON/OFF** or **LOWER ON/OFF** key to select the oven you want to use.
- From the main menu, touch the **MORE** key.

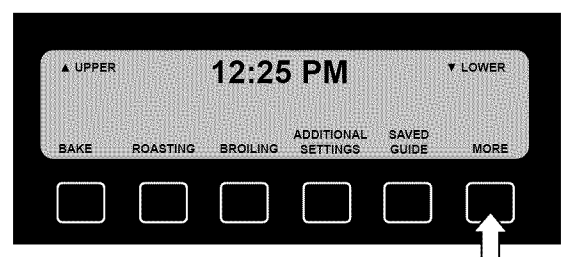

Continued...

# Deluxe Features

- Touch **SABBATH**.

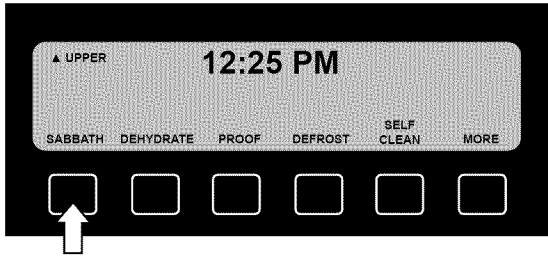

- Touch **BAKE** or **PURE CONVECTION**.

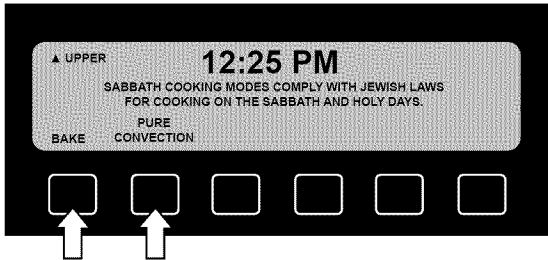

- You will see the preset (jump-in) temperature of **350°F** (in bake mode) or **325°F** (in Pure Convection™ mode) appear on the display. If you want to cook at a different temperature, enter the temperature on the number keypad (for example: to cook at 375°F, touch **3**, then **7**, then **5**).
- If you want the oven to start or stop at a later time, touch the **DELAY OPTIONS** key and set the oven according to the **Delay/Timed Cooking** section on page 23.

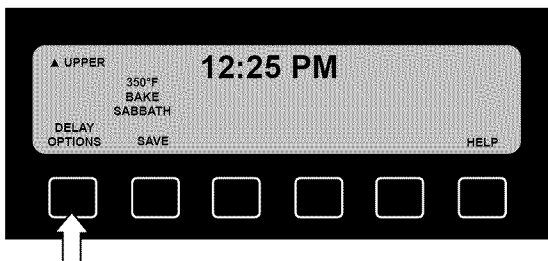

- Touch the **START** key.
- The oven will start at the time entered.
- The **CANCEL/SECURE** key on your oven remains active so that you can turn off the Sabbath feature or turn off the oven(s) if there are problems.

- When the oven is cooking, the **25° HOTTER** and **25° COOLER** keys tell the oven to raise or lower the temperature by 25°F (If your oven is set to Celsius, the oven will raise or lower the temperature by 15°C). In compliance with Jewish law, the bake elements will be adjusted randomly when these keys are touched and no changes will be seen on the display.

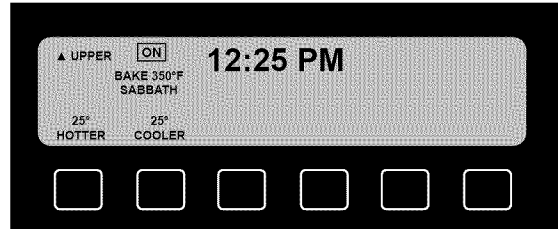

If you have a *double oven*, the **UPPER ON/OFF** and **LOWER ON/OFF** keys remain active so you can turn off the ovens if there are problems or set up the second oven for use prior to the beginning of the Sabbath or Holy Day.

## For Double Ovens: Setting Up the Second Oven Chamber to Cook on the Sabbath

Touch the **ON/OFF** key for the oven that is not already set to cook on the Sabbath.

- The **BAKE/PURE CONVECTION** display will appear.
- Touch **BAKE** or **PURE CONVECTION**.

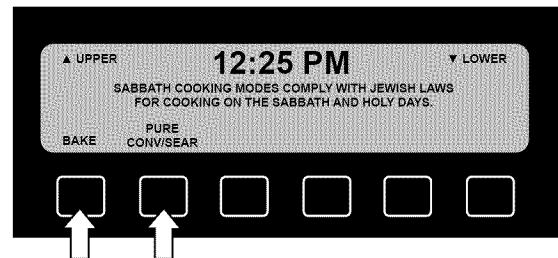

- You will see the preset (jump-in) temperature for the cooking mode you have selected appear on the display. If you want to cook at a different temperature, enter the temperature on the number keypad.
- If you want the oven to start or stop at a later time, touch the **DELAY OPTIONS** key and set the oven according to the **Delay/Timed Cooking** section on page 23.

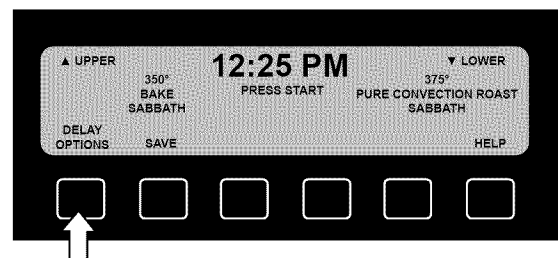

- Touch the **START** key.

# Deluxe Features

## Dehydrate



Dehydration is the process of preserving food by removing water. If you would like to dehydrate fruits, vegetables or meats, your oven is equipped with special settings to allow you to

do so easily.

- Before you turn on the oven, position the racks at the levels you need them.
- Place the food you want to dehydrate into the oven.
- If you have a double oven, touch the **UPPER ON/OFF** or **LOWER ON/OFF** key to select the oven you want to use.
- From the main menu, touch **MORE**.

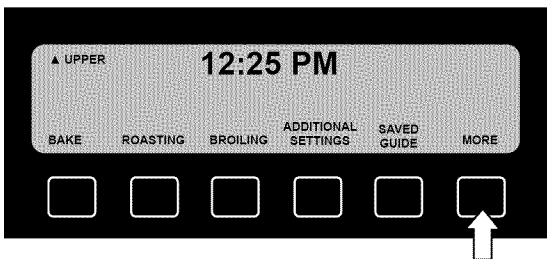

- Touch **DEHYDRATE**.

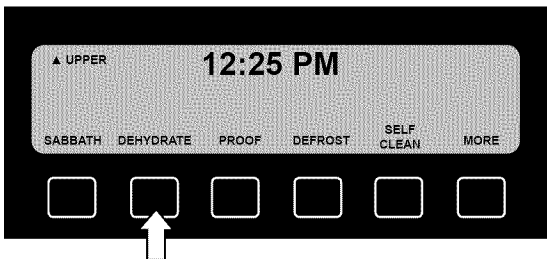

- Select the type of food you are dehydrating. For example, touch **FRUITS**. The oven will set itself to the best combination of settings for that type of food.

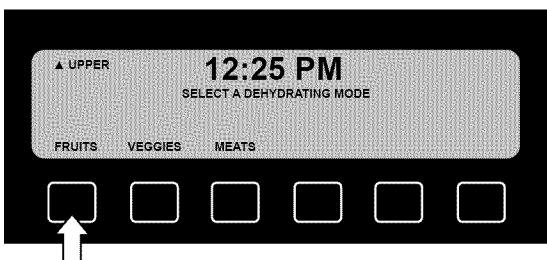

- You will see the jump-in temperature appear on the display (100°F for fruits, 125°F for veggies or 150°F for meats). To dehydrate at that temperature, simply touch **START**. If you want to dehydrate at a different temperature, enter the temperature on the number keypad (for example: to dehydrate at 165°F, touch 1, then touch 6, then touch 5), then touch **START**.

## Tips For Dehydrating

### Equipment Required for Dehydrating Foods

- Half sheet pan or jelly roll pan with ½" rim all the way around it
- Baking rack that fits inside the half sheet pan
- Cheesecloth
- Four quart sauce-pot with lid
- Steamer basket that fits inside 4 quart saucepan. One that is perforated and opens up will work well.
- Slotted spoon
- Paper towels
- A sharp knife

### Notes for dehydrating fruits:

- Place the food onto the center of the oven rack. (For dehydrating, prepare food as recommended then place food onto a drying rack.)
- You can add honey, spices, lime juice or orange juice to give the fruit a different flavor.
- To prevent darkening during dehydration and storage, you should steam blanch apples, apricots, peaches, nectarines, pears or foods that will oxidize. To steam blanch:
  - Add 1 inch of water to a four quart sauce-pot. Insert the steam basket and place the fruit in it.
  - Cover the pot and steam for one to two minutes.
  - Remove with a slotted spoon and dab with a paper towel to remove excess moisture before dehydrating.
- Apples, pears, pineapples, and some other fruits will brown or darken during dehydration. To prevent discoloration, dip fruits in pineapple juice or lemon juice after steam blanching.
- To give the fruit a candied effect and to help retain color, blanch them in simple syrup\*. You can candy the fruits mentioned above as well as figs and plums.
  - The basic ratio for simple syrup is one cup of sugar to one cup of water. Add these ingredients to a four quart stock-pot and bring to a boil. Stir until all the sugar dissolves. Remove the saucepan from the stove and allow it to cool. Dip fruit into the simple syrup after it has cooled. Proceed to dehydrate.

# Deluxe Features

## Notes for dehydrating fruits (continued):

- You should water blanch items with tough skins such as grapes, prunes, dark plums, cherries, figs, and some types of berries. Water blanching these types of fruit will crack the skins so that moisture can escape and dehydration can be done more effectively. To water blanch:
  - Bring 2 quarts of water to boil in 4 quart pot.
  - Drop the fruit in the water for 1 to 2 minutes, or until the skin begins to crack.
  - Remove the fruit with a slotted spoon and dab dry with a paper towel before dehydrating. The pit can be left inside or removed half way through the dehydrating process.
- Always wash and remove excess moisture from all fruits and vegetables before dehydrating.
- It is best to dehydrate on a baking rack with a pan underneath to catch any juices. If the fruit is small, use cheesecloth over the rack. If you use a rack, it will allow for maximum air circulation around the fruit. The cheesecloth will prevent the fruit from sticking to the rack.
- Always cut fruits and vegetables into uniform pieces.

## Proof

 Proofing is the process of allowing dough to rise. Your oven's proof mode is best for yeast breads that require rise time in a warm, draft-free environment. Your oven maintains the ideal temperature for best dough fermentation.

- Before you turn on the oven, position the racks at the levels you need them.
- After you prepare the yeast dough, place it in a clean bowl, place a damp towel over the top, and put it in the oven.
- If you have a double oven, touch the **UPPER ON/OFF** or **LOWER ON/OFF** key to select the oven you want to use.
- From the main menu, touch the **MORE** key.

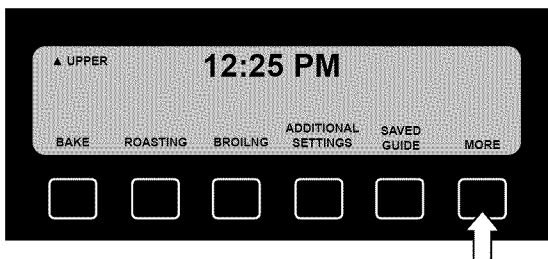

- Touch **PROOF**.

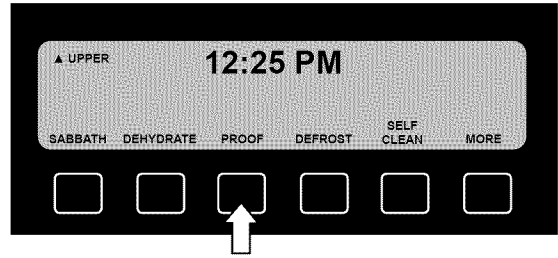

- You will see the preset temperature of 100°F appear on the display. To proof at that temperature, simply touch **START**. If you want to proof at a different temperature, enter the temperature on the number keypad (for example: to proof at 120°F, touch **1**, then **2**, then **0**), then touch **START**.

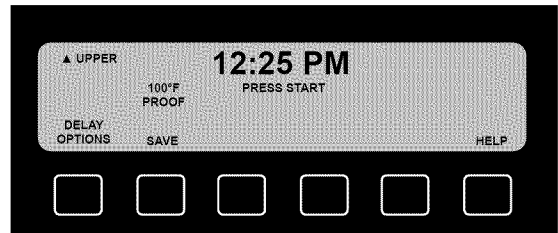

- Leave the dough in the oven for about 1-2 hours (different yeasts require different rise times, so follow your original recipe). It should double in size. Some recipes require a second proof after you shape the dough.

## Defrost

### CAUTION

You run the risk of cooking the food if the defrost temperature is too high. Do not defrost above 120°F.

## Things to Keep in Mind

- Food that takes an exceptional amount of time to defrost will not defrost well in a convection oven. 
- You should not defrost anything that would normally take over 2 hours to thaw. The food would begin to spoil at the oven's defrost temperature of 110°F.
- If you have a partially defrosted turkey, rib roast or other large cut of meat, you may continue to defrost it in your convection oven. If wing tips and legs begin to dry out when you defrost poultry, you may wrap the tips with aluminum foil.
- If you are defrosting a small cut of meat, lay it on a flat cookie sheet with a one inch rim to catch juices as the meat thaws.

# Deluxe Features

- Thick, frozen casseroles such as lasagna will not defrost well in your oven. Instead, defrost according to the food manufacturer's suggestions. You may also defrost casseroles in the refrigerator overnight. You should leave the food in its original container and keep it covered.
- You can bake some foods from frozen. Some examples are: pizza, frozen pastries, croissants, cookies, etc. Before baking frozen food, allow the oven to finish preheating.

## How to Use the Defrost Feature

- Before you turn on the oven, position the racks.
- Place the food you want to defrost in an appropriate size bowl or roasting pan to catch juices and water. You can also place food on an aluminum surface such as a Dacor griddle to speed the process. This mode can also be used for defrosting breads.
- Place the food in the oven on rack #3 (counting from the bottom).
- If you have a double oven, touch the **UPPER ON/OFF** or **LOWER ON/OFF** key to select the oven you want to use.
- From the main menu, touch **MORE**.

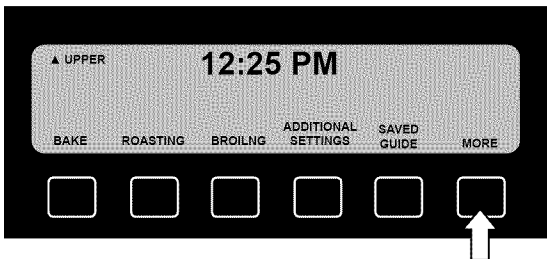

- Touch **DEFROST**.

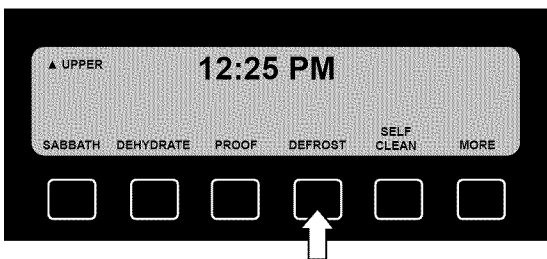

- You will see the preset (jump-in) temperature of 110°F appear on the display. To defrost at the preset temperature, simply touch **START**. To defrost at a different temperature, enter the temperature on the number keypad (for example: to defrost at 120°F, touch **1**, then **2**, then **0**), then touch **START**.
- The oven will turn on and the display will indicate the defrosting temperature.
- Periodically check the food to see how well it is defrosting.

## Self-Clean

See **Care and Cleaning** on Page 28.

## Delay/Timed Cooking

If you want to set the oven to automatically turn itself on or off at a later time or day, you can use the delay options feature. The delay options work for all of the various cook modes (except broil) and special features, including Dacor Guide and self-clean. You can set the oven to turn on up to a week later.

## Delay/Timed Cooking Options

You can set the delay/timed cooking options to:

- Start the oven immediately and turn it off at a certain time of day (stop time).
- Start the oven immediately and turn it off after a set amount of time (duration time).
- Start the oven at a later time (delay start) and turn it off at a certain time of day (stop time).
- Start the oven at a later time (delay start) and turn it off after a set amount of time (duration time).
- Start the oven at a later time (delay start) with no turn off time.

**For the self-clean feature only:** You may only use the delay options feature to set the start time and day for the self-clean feature. You cannot change the stop time or duration of the self-clean cycle. The duration time for self-cleaning is set automatically when you pick light, medium or heavy cleaning.

## WARNING

Food safety is an important consideration when using the delay options feature. To avoid potential sickness and the spoiling of food, take the following steps:

- Avoid using foods that will spoil while waiting for the oven to start. Typical foods to avoid include: those containing eggs and dairy products, cream soups and cooked or uncooked meats, poultry and fish.
- If cooking will not begin immediately, place only very cold or frozen food into the oven. Most unfrozen foods should never stand in the oven for more than two hours before cooking begins.
- Do not allow foods to remain in the oven after completion of the hold cycle. The hold cycle automatically starts at the conclusion of timed cooking and keeps food at 150°F for two hours ("HOLD" appears on the screen). When the temperature drops below 140°F, bacteria can develop.

# Deluxe Features

## Delay/Timed Cooking (continued)

**NOTE:** You may use the timers while using the delay options feature. The timers do not have an effect on any of the delay options settings.

### Setting Up the Delay Options

- The delay options are set after you select the feature you want to use, but just before you touch the **START** key.
- If you want to use the delay options feature, start by setting up your oven the way you normally would according to the cooking, dehydrate, defrost, proof, and self-clean sections of this manual. If you will be using the meat probe, you need to make sure you have entered the meat probe settings the way you want them before you set the delay options.
- Touch the **DELAY OPTIONS** key.

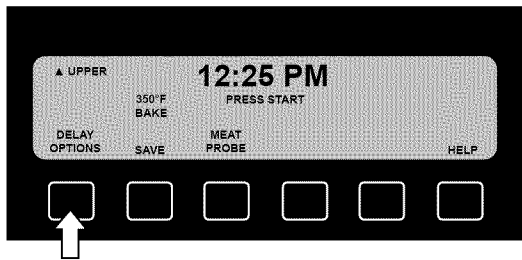

- The **DELAY OPTIONS** screen will appear on the display. There are 3 settings available:
  - **DELAY START**
  - **DURATION TIME**
  - **STOP TIME**

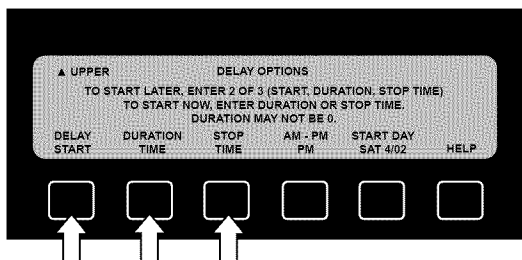

- When you set 2 of the 3, the control panel automatically calculates the third.
- If you want the oven to start immediately and only control the time at which it turns off, skip to [Setting the Amount of Time the Oven is ON](#).

### How to Set the Start Time and Start Day

- Touch the **DELAY START** key.

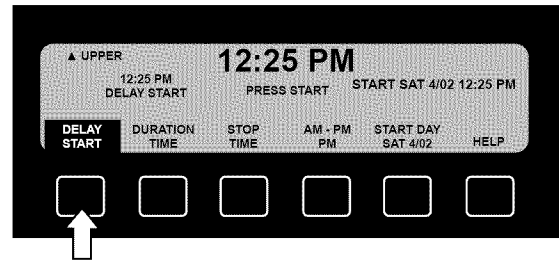

- Enter the time you want to start cooking on the number keypad. You may need to touch the **AM - PM** key to get the correct time of day. The new start time will appear on the display.

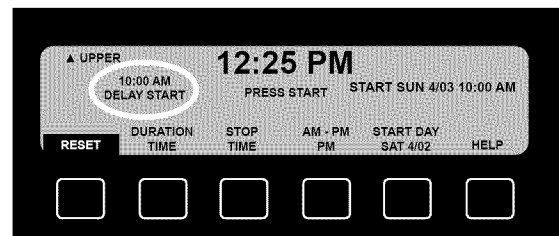

- If you want to start cooking on a different day, touch the **START DAY** key repeatedly until the correct day appears just above the key itself.

**NOTE:** You may touch **START** after you set up the start time and start day without setting the stop time or duration time. If you do so, the oven will start at the specified time and continue to run until you turn it off.

### Setting the Amount of Time the Oven is ON, Turning the Oven Off Using Duration Time

- Touch **DURATION TIME** (cook time).

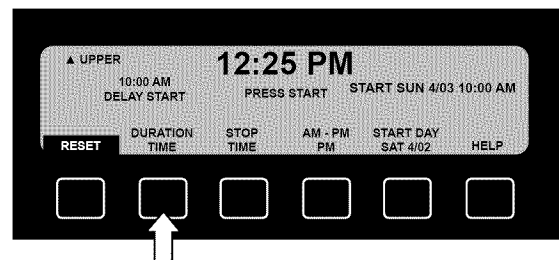

- Enter the amount of time you want the oven to be on using the keypad. For example, if you want the oven on for 1 hour and 35 minutes, touch **1**, then **3**, then **5**.

# Deluxe Features

- The duration time will appear on the display.

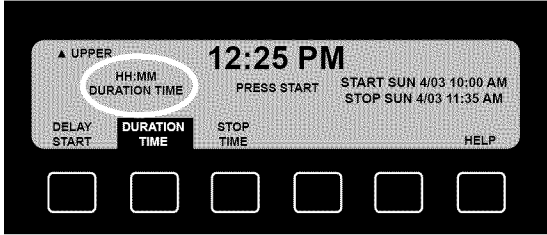

- Touch the **START** key.
- If you did not enter a start time, the oven will start immediately and stop after the amount of duration time entered has elapsed. If you entered a start time "**WAITING TO START**" will appear on the display. The oven will turn on at the start time that was entered and stop cooking after the amount of duration time entered has elapsed.
- If you are using one of the cook settings, when the duration time expires, the oven will go into "**HOLD**" mode for 2 hours. The oven will reduce the temperature to about 150°F to keep the food warm and safe for serving.

## Turning the Oven Off Using Stop Time

- After you have set the start time, touch the **STOP TIME** key.

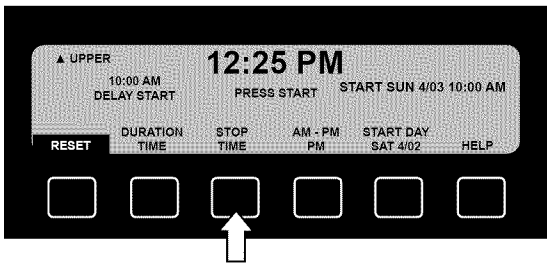

- Enter the time of day you want the oven turn off using the keypad. For example, to turn off the oven at 1:10PM, touch **1**, then **1**, then **0**, then **AM - PM** if necessary.
- If you want to turn off the oven on a different day, touch the **STOP DAY** key repeatedly until the correct day appears just above the key itself.

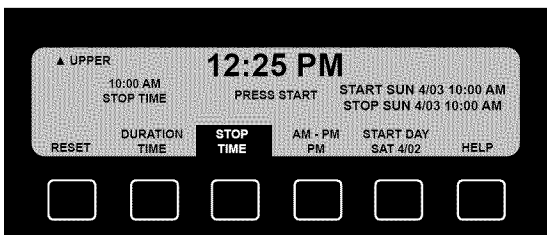

- The stop time and day will appear on the display.

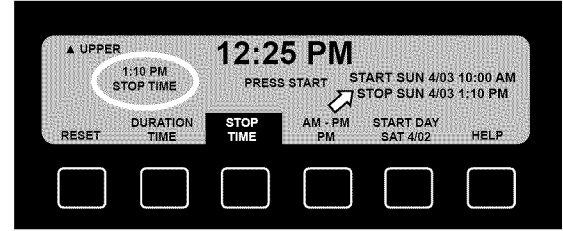

- Touch the **START** key. If you did not enter a start time, the oven will start immediately and stop at the stop time entered. If you entered a start time "**WAITING TO START**" will appear on the display. The oven will turn on at the start time that was entered and stop cooking at the stop time entered.
- If you are using one of the cook settings, when the stop time is reached, the oven will go into "**HOLD**" mode for 2 hours. The oven will reduce the temperature to about 150°F to keep the food warm and safe for serving. At the end of the hold cycle, the oven will turn off and "**CYCLE COMPLETE**" will appear on the display. Touch **CANCEL/SECURE** to clear the control panel.

## Making Changes or Canceling While the Oven is "WAITING TO START"

- If you want to change the temperature, meat probe or delay settings while the oven is waiting to start:
  - Touch **EDIT** (if you have a double oven touch the **EDIT** key below the word **UPPER** or **LOWER** on the display).
  - Change the settings that need to be changed, then touch **START**.
- If you want to cancel the delayed start, touch the **UPPER ON/OFF** or **LOWER ON/OFF** key, for double ovens. For single ovens, touch **CANCEL/SECURE**.

## Meat Probe

 When you cook foods like roasts and poultry, the internal temperature is the best way to tell when the food is properly cooked. Your oven's meat probe takes the guesswork out of roasting. You can use it to cook food to the exact temperature you desire. You can select meat probe settings from 100°F to 200°F.

### WARNING

To prevent the possible of burns, connect and unplug the meat probe using hot pads.

### IMPORTANT:

- Use the handle to insert and remove the meat probe skewer. Also, use the handle on the meat probe plug to insert and disconnect it. Pushing or pulling on either end of the cable could damage the meat probe.

**Continued...**

# Deluxe Features

## Meat Probe (continued)

### IMPORTANT:

- To avoid breaking the meat probe, make sure the food is completely defrosted before inserting the skewer.
- Never leave the meat probe inside the oven, especially during the self-clean cycle.
- Use of meat probes other than the one provided with your oven may result in damage to the meat probe and/or your oven.

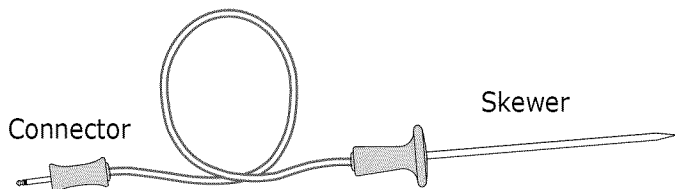

**Meat Probe**

### How to Use Your Meat Probe

- Prepare the meat for cooking prior to setting the oven. Insert the skewer of the meat probe into the center of the meat. Make sure that the skewer is not inside any fatty portions of the meat and does not touch any bones. The point should rest in the thickest part of the meat. When you are cooking fowl, the tip of the skewer should rest toward the center of the bird.

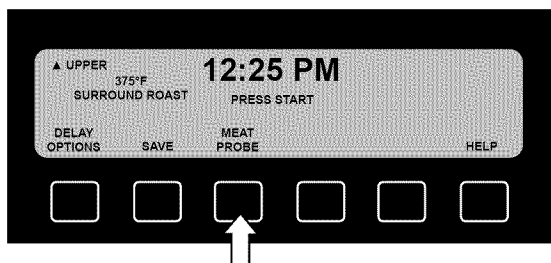

- Select one of the roasting modes on page 17.
- Before touching **START**, touch the **MEAT PROBE** key.
- You will see the preset meat probe temperature of 170°F appear on the display. Consult the Internal Cooking Temperatures Chart to see the recommended meat probe temperatures for a variety of foods. If the correct meat probe temperature already appears on the display, touch **START**. Otherwise, enter the correct meat probe temperature on the number keypad (for example: touch 1, then 6, then 0 for 160°F), then touch **START**.

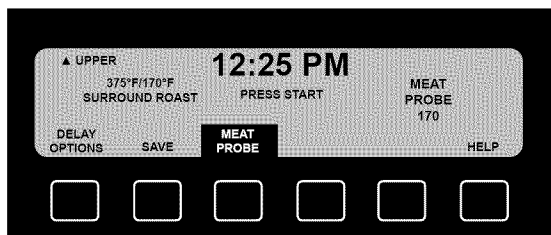

- **"INSERT MEAT PROBE"** will flash on the display when it is time to put the food in the oven and connect the meat probe. To keep from getting burned, use an oven mitt to connect the plug on the end of the meat probe to the meat probe connector inside the oven. See page 5 for the location of the connector.
- Close the oven door.
- The oven will automatically cook the meat until it is done. When the meat is done, the oven will beep and reduce the temperature to a level that will keep it warm and safe for serving for up to 2 hours (**"HOLD"** will appear on the display). At the end of the hold cycle, the oven will turn off and **"CYCLE COMPLETE"** will appear on the display. Touch **CANCEL/SECURE** to clear the control panel.

**NOTE:** If you connect the meat probe before the display indicates it is time to connect it, the display will flash **"REMOVE MEAT PROBE"**.

### Minimum Safe Internal Cooking Temperatures for Various Foods

| Ground Meat & Meat Mixtures                          |       |
|--|-------|
| Beef, Pork, Veal, Lamb                               | 160°F |
| Turkey, Chicken                                      | 165°F |
| Fresh Beef, Veal, Lamb                               |       |
| Medium Rare  | 145°F |
| Medium   | 160°F |
| Well Done  | 170°F |
| Poultry  |       |
| Chicken & Turkey, whole (temperature taken in thigh) | 180°F |
| Poultry breasts, roast                               | 170°F |
| Poultry thighs, wings, legs                          | 180°F |
| Duck & Goose   | 180°F |
| Stuffing (cooked alone or in bird)                   | 165°F |
| Fresh Pork   |       |
| Medium   | 160°F |
| Well Done  | 170°F |
| Ham  |       |
| Fresh (raw)  | 160°F |
| Pre-cooked (to reheat)                               | 140°F |

**NOTE:** The minimum safe internal cooking temperatures are subject to change. There are changes in bacteria and the temperatures required to eradicate them. For the most current information, please contact the USDA.

USDA Meat and Poultry Hot Line:

Phone: (800) 535-4355  
www.fsis.usda.gov



# Cooking Tips

## Additional Accessories

Optional cookie sheets: The Dacor full sized cookie sheets maximize oven rack baking capabilities by utilizing the total usable rack space.

- 27 inch cookie sheet (3 per carton)  
Order Dacor Part No. AO273CS
- 30 inch cookie sheet (3 per carton)  
Order Dacor Part No. AO303CS
- Pizza baking stone.  
Order Dacor Part No. ABS20
- Large capacity roast/broil pan with V shaped rack.  
Order Dacor Part No. AORPVR
- Additional 27 inch standard oven rack.  
Order Dacor Part No. 72747
- Additional 30 inch standard oven racks.  
Order Dacor Part No. 72713
- Additional 27 inch GlideRack oven rack.  
Order Dacor Part No. AO27RG
- Additional 30 inch GlideRack oven rack.  
Order Dacor Part No. AO30RG
- Additional meat probe.  
Order Dacor Part No. 72723

Order accessories through your Dacor dealer or at [www.everythingdacor.com](http://www.everythingdacor.com).

## Food Placement

**NOTE:** The rack positions mentioned are counting from the bottom up.

- Typically, when baking on 2 racks, use rack positions #2 and #4 or #1 and #4. When baking on 3 racks, use rack positions #1, #3 and #5.
- When you are cooking a food item that is very heavy, use the Dacor GlideRack oven rack. You can pull it out further than a conventional rack, making it easier to check the food, stir or add ingredients.
- Heavier roasting pans and dishes will cook better on rack position #1.
- When using a baking stone, use rack position #1 for best results.
- If you put a baking stone on the GlideRack oven rack, instead of one of the standard oven racks, you can pull the stone out of the oven further, making pizza easier to remove.

## The Best Use of Bake Ware

- You should bake cakes, quick breads, muffins, and cookies in shiny, reflective pans for light, golden crusts.
- Use medium gauge aluminum sheets with low sides when preparing cookies, biscuits, and cream puffs. Dacor® cookie sheets, with their low profiles, will give you the best results.
- Bake most frozen foods in their original foil containers, placed flat on a cookie sheet. Follow the package recommendations. When using glass bake ware, reduce the recipe temperature by 25°F, except when baking pies or yeast breads. Follow the standard recipe baking time for pies and yeast breads.
- Place pans carefully on the oven racks. Turn pans on the racks so that the long sides run left to right, parallel to the door.
- For roasting, a V shaped rack in a roasting pan works best to allow air circulation around the food. Dacor's roasting pan works particularly well and 2 of them will fit side by side in a 30 inch oven chamber.

## High Altitude Cooking

Due to the lower atmospheric pressure at higher altitudes, foods tend to take longer to cook. Therefore, recipe adjustments should be made in some cases. In general, no recipe adjustment is necessary for yeast-risen baked goods, although allowing the dough or batter to rise twice before the final pan rising develops a better flavor. Try making the following adjustments for successful recipes. Take note of the changes that work best and mark your recipes accordingly.

| Altitude:  | Baking Powder, for each teaspoon, decrease by: | Sugar, for each teaspoon, decrease by: | Liquid, for each cup add: |
|------------|--|--|---------------------------|
| 3,000 feet | 10%  | 5 - 10%                                | 5 - 10%                   |
| 5,000 feet | 10 - 25%                                       | 10%                                    | 20%                       |
| 7,000 feet | 25%  | 20%                                    | 20 -25%                   |

### High Altitude Cooking

# Care and Cleaning

## Self-Cleaning

### **WARNING**

- Do not leave the racks, the meat probe, pots, pans, utensils or any other items in the oven in during self-cleaning. The convection filter must also be removed. Items left in the oven during self-cleaning may be damaged.
- The control panel automatically locks the oven door during self-cleaning. Do not try to force the door open after it is locked. Damage to the door latch may result.
- Do not touch the outside surfaces of the oven during the self-clean cycle. They will be hot.
- Do not line the oven with aluminum foil or other materials. These items can melt or burn during self-cleaning and cause permanent damage to the oven.
- Take extreme caution when cleaning the door gasket. Rubbing, moving or in any way damaging the door gasket may eliminate the required tight door seal. See page 30 for cleaning instructions.

**IMPORTANT:** Always remove excess grease and soil from the oven interior and door prior to using the self-clean cycle.

### About the Self-Clean Cycle



- The oven will run better and produce better baked goods if it is clean.
- During self-cleaning, the oven is heated to very high temperatures which burns off any deposits on the surfaces of the oven. Self-cleaning eliminates the need for manual scrubbing of interior surfaces. You can set the length of time for self-cleaning based on the amount of soil. The 3 settings are light (2 hours), medium (3 hours), and heavy (4 hours).
- If you only use your oven to bake cookies occasionally, it may require only a light cleaning. If you use your oven to broil or roast on a frequent basis, it may require heavy cleaning.
- It is normal for the oven to emit smoke during the first few self-clean cycles.
- It is normal for the oven to emit popping sounds during self-cleaning. These sounds are caused by the expansion and contraction of metal surfaces when the oven heats up and cools down.
- When you self-clean your oven, it will automatically activate the electric door latch. The latch prevents the oven door from being opened while the interior oven temperatures can easily cause injury.

- You may notice a powder ash residue in the bottom of the oven after self-cleaning. This is normal. Sponge the residue up after the oven completely cools.
- If you have a double oven, the control panel will only allow one oven chamber to be self-cleaned at a time due to the amount of power consumed. For the same reason, the oven will not allow you to cook in one oven chamber while the other is being self-cleaned.
- If you want to stop the self-clean cycle, touch the **CANCEL/SECURE** key. Please keep in mind that the oven door will remain locked until it is safe enough to open. You will still need to exercise caution when the door lock is released because the inside of the oven will still be hot.

### How to Use the Self-Cleaning Feature

**IMPORTANT:** Remove the racks and broiler pan, convection filter, tray, and all utensils from the oven chamber. See page 30 for instructions on how to remove and clean the filter.

- Clean soil from the oven front frame area and the oven door outside of the door gasket. You may clean heavily soiled areas with a non-scratching scouring pad.
- Rinse all exterior surfaces according the **Cleaning the Surfaces of the Oven** section on page 30.
- Wipe up excess grease and other food spills with a damp cloth. Doing so will minimize smoke and increase the efficiency of the self-clean cycle.
- Turn on kitchen fans or vents to help remove odors during the self-clean cycle.
- If you have a double oven, use the **UPPER ON/OFF** and **LOWER ON/OFF** keys to select the oven to be cleaned. You may only self-clean one oven chamber at a time.
- Touch the **MAIN MENU** key.

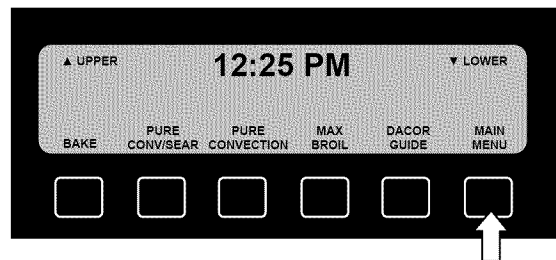

# Care and Cleaning

- Touch **MORE**.

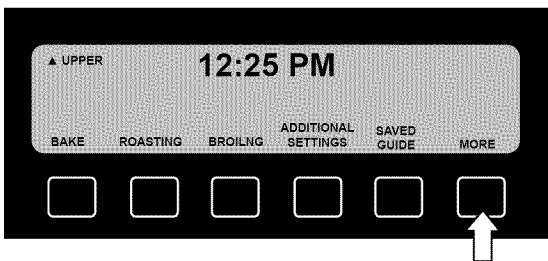

- Touch **SELF CLEAN**.

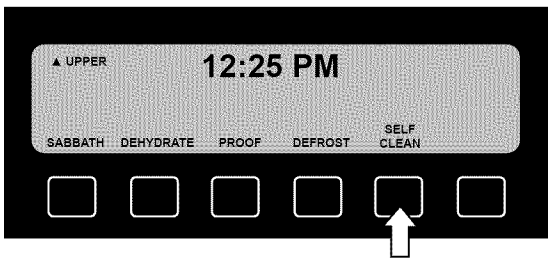

- The oven will display a warning message:

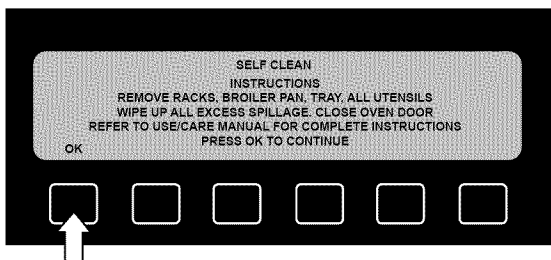

- Remove all utensils, racks, and the convection filter, then touch **OK**.
- You will see the three self-clean selections on the display.

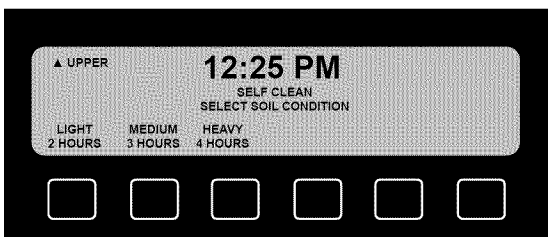

- Select the amount of time you want the oven to self-clean and touch **START**.
- Shortly after you touch **START**, the oven door will automatically lock. The oven will keep the door locked until it has cooled down enough to open.

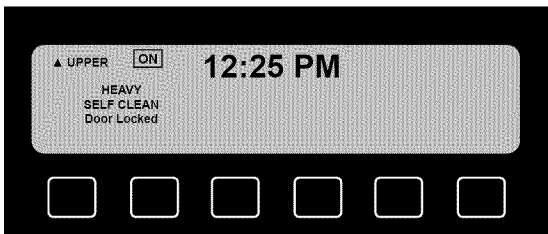

**IMPORTANT:** If you do not shut the oven door completely, the automatic door latch will not lock. The phrase "CLOSE OVEN DOOR" will flash on the display if the door is ajar. To correct the problem, touch the **CANCEL/SECURE** key twice and wait approximately 1 minute. When the door is properly closed, start the self-clean process again.

- When the oven has completed the self-clean cycle and has finished cooling down, it will release the door latch. The display will indicate that the self-clean cycle is complete. You will need to exercise caution because the oven will still be hot at the time the door lock is released.

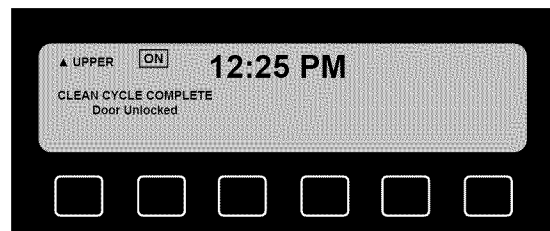

- Touch **CANCEL/SECURE** to return to the home screen.
- Once you are sure that the oven chamber has **COMPLETELY** cooled down, use a damp cloth or sponge to wipe out the powder residue found in the bottom of the oven.
- You must reinstall the convection filter and oven racks before using your oven.
- If you want to stop the self-clean, cycle touch **CANCEL/SECURE**.

# Care and Cleaning

## Cleaning the Surfaces of the Oven

### WARNING

- To avoid electrical shock or burns, turn off the oven and be sure that it is cool before cleaning.
- Use only the cleaning solutions specified in this manual to clean your oven. Do not use ANY cleaners that are not specified to clean the inside or outside of the oven. Use of other cleaners could produce hazardous fumes, cause corrosion of the metal parts, and could permanently damage the finishes.
- Take extreme caution when cleaning the door gasket. Rubbing, moving or in any way damaging the door gasket may eliminate the required tight door seal for self-cleaning.

**IMPORTANT:** Always wipe stainless steel (silver colored) surfaces with the grain.

**NOTE:** If you want to avoid accidentally turning the oven on while cleaning the control panel, activate the lock-out feature on your oven. Touch the **CANCEL/SECURE** key for 5 seconds. The lock-out feature will disable the control panel on your oven so that you can clean the keys and display.

When you want to re-activate the control panel on your oven, touch the **CANCEL/SECURE** key for 5 seconds. The word "LOCKED" will disappear from the display.

**NOTE:** Your oven's self-clean feature eliminates the need for manual scrubbing of interior surfaces. The steps below are for cleaning surfaces and items that are not covered by the self-clean process. To use the self-clean feature, see page 28.

## Glass and Porcelain Surfaces

- When you want to clean the glass and porcelain surfaces on your oven, use a non-abrasive, sponge with warm, soapy water. Dry the surfaces of your oven completely with a soft, lint-free cloth. You may scrub the oven light lens with the rough side of a sponge and warm, soapy water. Be careful not to scratch the lens.
- Glass surfaces may also be cleaned with Dacor Cook Top Cleaning Creme (Part No. A-300). Use it according to the directions on the package.

## Stainless Steel Surfaces

- If your oven has stainless steel surfaces on the outside, clean them with a solution of mild detergent, and warm water. Rinse and dry with a soft, lint-free cloth.
- You may also use Dacor Stainless Steel Cleaner (Part No. A-302) on the stainless steel surfaces. Use it according to the directions on the package.

## Door Gasket (Seal)

- Clean the door seal by dabbing it with a solution of water and mild soap. Do not scrub it, as it will become damaged.

## Cleaning the Convection Filter

The convection filter is located in the back of the oven chamber. If you have a double oven, it has 2 convection filters, one in the back of each oven chamber. The control panel will remind you to clean the filter based on the amount of use the oven receives. You also need to remove the filter during the self-clean cycle.

### WARNING

- Remove the filter(s) only when the oven is cool.
- For your safety, re-install the filter(s) before using the oven to cook. If you don't, the spinning fan blades at the back of the oven will be exposed.

## Removing your oven's filter(s):

- Put your fingers around the edges of the filter and gently push up.

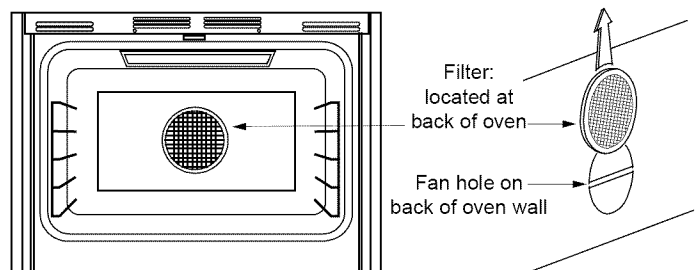

### Removing The Convection Filter

## To clean the filter(s):

- Soak the filter in hot, soapy water. Rinse well. You may also place it in a dishwasher on the top rack. Dry the filter before re-installing it.

# Care and Cleaning

## Installing your oven's filter(s):

- The metal clips on the back of the filter hook over the metal bar across the fan hole. Place the filter flat against the back of oven above the hole with the clips on the back of the filter pointing down. Be careful not to push the filter too hard against the back wall because the clips can scratch the surface. Gently push the filter straight down over the hole until the clips catch on the metal bar.

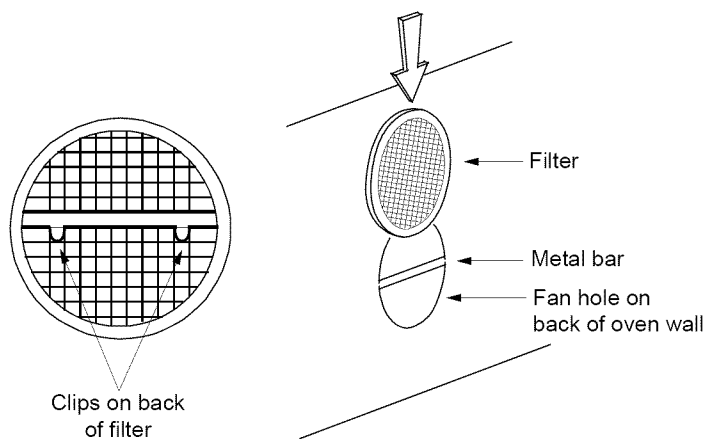

### Replacing The Convection Filter

## Clearing the "Clean Convection Fan Filter" Message:

**NOTE:** The "Clean Convection Fan Filter" is a reminder that you should clean the convection filter(s).

- Following the steps below, you may either choose to ignore the message and continue baking, or reset the reminder function. You will have approximately 15 hours of use in this mode before you receive this message again.
- When the "Clean Convection Fan Filter" message appears on the screen, the variable function keys will be labeled **OK**, **RESET UPR**, and/ or **RESET LWR**.
- Touch **OK** to clear the screen and continue using oven. Doing so does not clear the warning. Next time the home screen is displayed, the message will reappear. Touching **OK** allows you to leave the message as a reminder if you are not ready to clean the filter, but still want to cook.
- If you clean the filter(s) and/or you want to reset the message and counter, touch the variable function key with the appropriate **RESET** label. **RESET UPR** will reset the upper or a single oven, **RESET LWR** will reset the lower oven on units equipped with two ovens.

## Cleaning the Accessories

**IMPORTANT:** You must remove all accessories from the oven during the self-clean cycle. If you leave accessories in the oven during self-cleaning, they will permanently discolor and/or become permanently damaged. Racks will become difficult to slide.

### Oven Racks

- To clean the oven racks, apply a solution of detergent and hot water. When you need to clean heavy soil, use a scouring pad such as steel wool with plenty of water. You may also use a solution of 1 cup of ammonia to 2 gallons of water.

### Meat Probe

**IMPORTANT:** Do not immerse the meat probe in water. It will become damaged.

- The meat probe is constructed of vinyl handles, a wire, a plug, and a stainless steel skewer. To clean the skewer, use a scouring pad and hot, soapy water. When you clean the handles, wipe with soft sponge soaked with a solution of detergent and warm water.

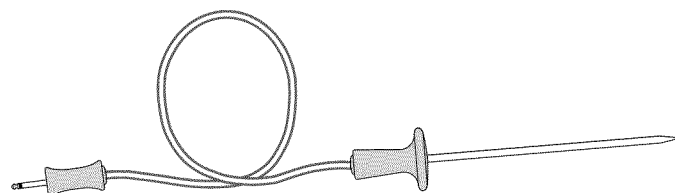

Meat Probe

### Broil Pan

- Your broil pan has a porcelain enamel finish. When you clean it, use a solution of detergent and hot water. If your broil pan is heavily soiled, use a scouring pad with plenty of water. Rinse it well after cleaning.

### Optional Roast/Broil Pan with V Shaped Rack

- Your roast/broil pan has a porcelain enamel finish. When you clean it, use a solution of detergent and hot water. If your roast/broil pan is heavily soiled, use a scouring pad and plenty of water. Rinse it well after cleaning.
- The optional V shaped rack is finished with an Excalibur® non-stick coating. When you clean it, use a solution of mild detergent and warm water. Use the side of a sponge to scrub it and dry it with a lint-free cloth.

# Care and Cleaning

## Optional Baking Stone

- Wash the optional baking stone with hot water and scrub it clean before you use it for the first time. Do not use any soap or detergents to wash the stone. The stone is porous and soap will get trapped inside. The trapped soap will affect the flavor of the food cooked on it. Don't be alarmed if the stone gets stains on it after it is used for a while. Stains do not affect the stone's ability to bake properly.
- When you need to remove large food particles from the baking stone, use warm water and a scrub brush. If there is a lot of oil build-up, it may smoke and create odors. If you need to remove the oily build up, use a scouring pad or brush to remove it. You may also use a paste of baking soda and water to scrub small stained spots off.

## Optional Cookie Sheets

- Clean aluminum cookie sheets with a solution of detergent and warm water. Since aluminum can scratch, you need to use the soft side of a sponge. A way for you to keep cookie sheets cleaner is to use parchment paper over the cooking surface during baking. The parchment paper will also prevent food from sticking.

## Replacing the Light Bulbs

### **WARNING**

- To prevent electrical shock and/or personal injury, make certain that the oven and light bulb(s) are cool and that power to the oven has been turned off at the circuit breaker panel or fuse box before replacing the light bulb(s).
- Always ensure that the lens cover is in place when using the oven. The lens cover protects the bulbs from breakage that can be caused by high temperatures or being bumped.
- Replacing the lens cover without lining up the cutout with the light socket will damage the light fixture.
- Do not use a screwdriver to remove the lens.

Light bulb replacement is considered a homeowner maintenance operation. If the lights do not work, before replacing them, please consult the **Before You Call for Service** section.

**IMPORTANT:** Do not touch the replacement halogen light bulb with your fingers. Halogen bulbs are sensitive to the oils from your hand. The oils from your hand will stick to the bulb and may cause it to burn out faster than normal.

### To Replace the Light Bulb(s):

1. Replace the bulb only with Dacor Part No. 92317, available from any authorized Dacor parts dealer.
2. Turn off power to the oven at the circuit breaker panel or fuse box.
3. Hold your hand under the lens for support and gently pry it loose using a spatula or table knife. Pull the lens cover straight out.

4. Grasp the old bulb and pull it straight out of the socket.
5. Using a glove, insert the new bulb into the socket.
6. As you reinstall the lens cover, line up the cutout on the inside rim with the light socket. Gently press it into its original position.
7. Turn the power to the oven back on at the main power supply. Reset the clock.

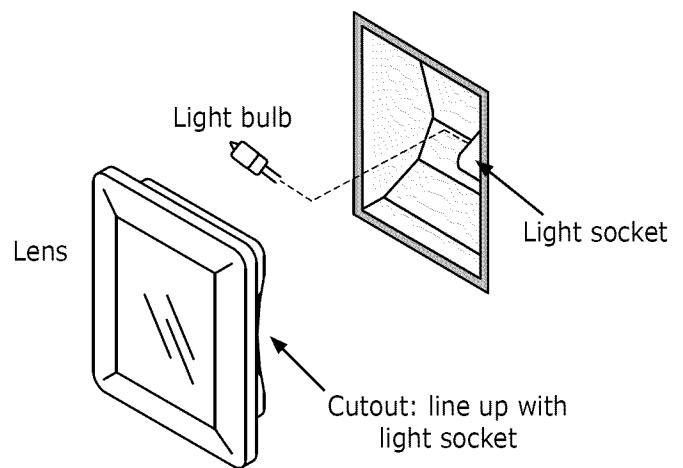

**Light Bulb Replacement**

# Before You Call for Service

Unnecessary service calls may be expensive, frustrating, and time-consuming. Before you call for service, please review the **Problem Solution Guide** below.

**NOTE:** See **Solutions to Common Baking Problems** on page 16 for problems with cooking food.

## Problem Solution Guide

| <b>Problem:</b>   | <b>May be caused by:</b>                                 | <b>What to do:</b>  |
|---|--|---|
| Nothing works   | Oven not connected to electrical power                   | Have an electrician connect the oven to a properly wired electrical connection  |
|   | Lock-out feature is on ("LOCKED" appears on the display) | Touch and hold <b>CANCEL/SECURE</b> key for 5 seconds   |
|   | Oven's sleep feature is on                               | Touch any control panel key or open the oven door to cause the display to light up  |
|   | Oven's Sabbath feature turned on                         | Touch <b>CANCEL/SECURE</b>  |
| Oven will not heat  | Oven settings not correct                                | Touch <b>CANCEL/SECURE</b> , then follow the <b>Operating Your Oven – The Basics</b> section on page 10                       |
|   | Oven set for delay timed cooking                         | Oven will turn on automatically at preset time. Touch " <b>CANCEL/SECURE</b> " to return to normal operation                  |
| No time is displayed or the time is incorrect   | Time of day not set                                      | See <b>Clock</b> section on page 6  |
|   | Oven's sleep feature is on                               | Touch any control panel key or open the oven door to cause the display to light up  |
|   | Clock disabled   | See <b>Enable/Disable the Clock</b> on page 7   |
| Oven does not self-clean  | Door not shut tight                                      | Check for obstructions. Close door tightly  |
|   | Oven set for delay timed cleaning                        | Oven will start to self-clean at preset time. Touch <b>CANCEL/SECURE</b> to return to normal operation                        |
|   | Double ovens only: Other oven is on.                     | Turn off other oven.  |
| Both oven lights will not work. ( <b>NOTE:</b> if only one light is not working, the bulb is probably burned out) | Oven light disabled                                      | See <b>Oven Lights</b> section on page 9  |
|   | Oven is in the self-clean cycle                          | Wait for completion of self-clean cycle   |
|   | Ovens Sabbath feature is enabled                         | Touch <b>CANCEL/SECURE</b>  |
|   | Light bulbs burned out                                   | See <b>Replacing the Light Bulbs</b> on page 32   |
| Door will not open.   | Oven is in the self-clean cycle                          | Check display. If display indicates " <b>SELF-CLEAN</b> ", wait for display to indicate " <b>Door Unlocked</b> " to open door |

# Warranty and Service

## Getting Help

Before obtaining service, please review the **Problem Solution Guide** starting on page 33. If you have performed the checks in the **Problem Solution Guide** and the problem has not been remedied, please contact us at one of the numbers below. Prior to requesting service, it is helpful to be familiar with the terms and conditions in the **Warranty** section on this page.

**For warranty repairs, call:**

### Dacor Distinctive Service

Phone: (877) 337-3226 (U.S.A. and Canada)  
Business Hours: 6:00 A.M. - 4:00 P.M. Pacific Time

**For non-warranty repairs, call:**

### Dacor Customer Service

Phone: (800) 793-0093 (U.S.A. and Canada)  
Business Hours: 6:00 A.M. - 5:00 P.M. Pacific Time

**Contact us through our web site at:**

[www.Dacor.com](http://www.Dacor.com)

*At Dacor, we believe that our quality of service equals that of our product. Should your experience with our service network or product be different, please contact our Customer Service Team and share your encounter with us. We will do our utmost to resolve the situation for you and deliver on our Dacor promise.*

*If you need anything clarified, just let us know.*

## Warranty

### What Is Covered

#### **CERTIFICATE OF WARRANTIES: DACOR WALL OVENS**

**WITHIN THE FIFTY STATES OF THE U.S.A., THE DISTRICT OF COLUMBIA, AND CANADA\*:**

#### **FULL ONE-YEAR WARRANTY**

If your DACOR product fails to function within one year of the original date of purchase, due to a defect in material or workmanship, DACOR will remedy the defect without charge to you or subsequent users. The owner must provide proof of purchase upon request, and have the appliance accessible for service.

Warranty is null and void if non-CSA approved product is transported from the U.S.

**OUTSIDE THE FIFTY STATES OF THE U.S.A., THE DISTRICT OF COLUMBIA, AND CANADA:**

#### **LIMITED FIRST YEAR WARRANTY**

If your DACOR product fails to function within one year of the original date of purchase, due to a defect in material or workmanship, DACOR will furnish a new part, F.O.B. factory, to replace the defective part. All delivery, installation, and labor costs are the responsibility of the purchaser. The owner must provide proof of purchase, upon request, and have the appliance accessible for service.

### What Is Not Covered

- Service calls to educate the customer in the proper use and care of the product.
- Failure of the product when used for commercial, business, rental or any application other than for residential consumer use.
- Replacement of house fuses or fuse boxes or resetting of circuit breakers.
- Damage to the product caused by accident, fire, flood or other acts of God.
- Breakage, discoloration or damage to glass, metal surfaces, plastic components, trim, paint or other cosmetic finish, caused by improper usage or care, abuse or neglect.

THE REMEDIES PROVIDED FOR IN THE ABOVE EXPRESS WARRANTIES ARE THE SOLE AND EXCLUSIVE REMEDIES. THEREFORE, NO OTHER EXPRESS WARRANTIES ARE MADE, AND OUTSIDE THE FIFTY STATES OF THE UNITED STATES, THE DISTRICT OF COLUMBIA, AND CANADA, ALL IMPLIED WARRANTIES, INCLUDING BUT NOT LIMITED TO, ANY IMPLIED WARRANTY OF MERCHANTABILITY OR FITNESS FOR A PARTICULAR USE OR PURPOSE, ARE LIMITED IN DURATION TO ONE YEAR FROM THE DATE OF ORIGINAL PURCHASE. IN NO EVENT SHALL DACOR BE LIABLE FOR INCIDENTAL EXPENSE OR CONSEQUENTIAL DAMAGES. NO WARRANTIES, EXPRESS OR IMPLIED, ARE MADE TO ANY BUYER FOR RESALE.

Some states do not allow limitations on how long an implied warranty lasts, or do not allow the exclusion or limitation of inconsequential damages, so the above limitations or exclusions may not apply to you. This warranty gives you specific legal rights, and you may also have other rights that vary from state to state.



# Notes

# Notes

fold here



NO POSTAGE  
NECESSARY  
IF MAILED  
IN THE  
UNITED STATES

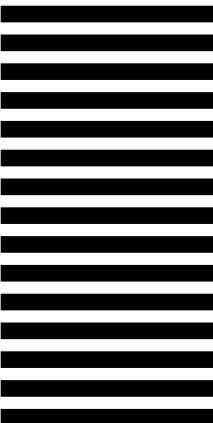

**BUSINESS REPLY MAIL**  
FIRST-CLASS MAIL PERMIT NO 1600 CITY OF INDUSTRY CA

POSTAGE WILL BE PAID BY ADDRESSEE

**DACOR  
ATTN WARRANTY PROCESSING DEPT  
PO BOX 90070  
CITY OF INDUSTRY CA 91715-9907**



# WARRANTY INFORMATION



**IMPORTANT:**

Your warranty will not be activated until you activate it online or return this form to Dacor. If you have purchased more than one Dacor product, please return all forms in one envelope or activate the warranty for each product online.

Please rest assured that under no conditions will Dacor sell your name or any of the information on this form for mailing list purposes. We are very grateful that you have chosen Dacor products for your home and do not consider the sale of such information to be a proper way of expressing our gratitude!

Owner's Name: \_\_\_\_\_  
Last (Please Print or Type) First Middle

Street: \_\_\_\_\_

City: \_\_\_\_\_ State: \_\_\_\_\_ Zip: \_\_\_\_\_

Purchase Date: \_\_\_\_\_ Email: \_\_\_\_\_ Telephone: \_\_\_\_\_

Dealer: \_\_\_\_\_

City: \_\_\_\_\_ State: \_\_\_\_\_ Zip: \_\_\_\_\_

Your willingness to take a few seconds to fill in the section below will be sincerely appreciated. Thank you.

1. How were you **first** exposed to Dacor products? (Please check one only.)

- A. T.V. Cooking Show
- B. Magazine
- C. Appliance Dealer Showroom
- D. Kitchen Dealer Showroom
- E. Home Show
- F. Builder
- G. Architect/Designer
- H. Another Dacor Owner
- I. Model Home
- J. Other \_\_\_\_\_

2. Where did you buy your Dacor appliances?

- A. Appliance Dealer
- B. Kitchen Dealer
- C. Builder Supplier
- D. Builder
- E. Other \_\_\_\_\_

3. For what purpose was the product purchased?

- A. Replacement **only**
- B. Part of a Remodel
- C. New Home
- D. Other \_\_\_\_\_

4. What is your household income?

- A. Under \$75,000
- B. \$75,000 – \$100,000
- C. \$100,000 – \$150,000
- D. \$150,000 – \$200,000
- E. \$200,000 – \$250,000
- F. Over \$250,000

5. What other brands of appliances do you have in your kitchen?

- A. Cooktop \_\_\_\_\_
- B. Oven \_\_\_\_\_
- C. Dishwasher \_\_\_\_\_
- D. Refrigerator \_\_\_\_\_

6. Would you buy or recommend another Dacor product?

- Yes
- No

Comments: \_\_\_\_\_

Thank you very much for your assistance. The information you have provided will be extremely valuable in helping us plan for the future and giving you the support you deserve.



cut here

cut here