

DMT800 Series  
DMT700 Series  
DMT400 Series

# Dishwasher installation guide



**These installation instructions are intended for use by qualified installers.**

If you are having problems installing this dishwasher  
Please call : **1-800-SAMSUNG (726-7864)**  
for assistance : [www.samsung.com](http://www.samsung.com)

imagine the possibilities

Thank you for purchasing this Samsung product. To receive more complete service, please register your product at

[www.samsung.com/register](http://www.samsung.com/register)







**SAMSUNG**

# safety instructions

Throughout this manual, you'll see Warning and Caution notes. These warnings, cautions, and the important safety instructions that follow do not cover all possible conditions and situations that may occur. It's your responsibility to use common sense, caution, and care when installing, maintaining, and operating the dishwasher. Samsung is not liable for damages resulting from improper use.

## IMPORTANT SAFETY INSTRUCTIONS

### What the icons and signs in this installation guide mean:

 <b>WARNING</b>	Hazards or unsafe practices that may result in <b>severe personal injury or death</b> .
 <b>CAUTION</b>	Hazards or unsafe practices that may result in <b>personal injury or property damage</b> .
 <b>CAUTION</b>	To reduce the risk of fire, explosion, electric shock, or personal injury when using the dishwasher, follow these basic safety precautions:
	Follow directions explicitly.
	Make sure the machine is grounded to prevent electric shock.
	Call the service center for help.

**These warning signs are here to prevent injury to you and others.**

**Please follow them explicitly.**

**After reading this section, keep it in a safe place for future reference.**

 Read all instructions before using the appliance.

Install and store the dishwasher inside, away from exposure to weather.

  
**CAUTION** Do not install the dishwasher near electrical components. Keep the dishwasher away from open flames.

Do NOT install the dishwasher on a carpet as this is a fire hazard.

Do NOT install the dishwasher in a location where the water may freeze (where the temperature falls below 32 °F (0 °C)). Frozen water in the hoses or pipes may damage the dishwasher.

As with all any equipment using electricity, water and moving parts, potential hazards exist. To safely operate this appliance, become familiar with its operation and exercise care when using it.

 The dishwasher must be properly grounded. Never connect it to an ungrounded outlet.

Prior to removal of original dishwasher and the installation of your new unit, make sure to switch off your circuit breaker. Do not connect the dishwasher until you have completed the installation. Connecting the power cable is the last step when installing the dishwasher.

All wiring and grounding must be done in accordance with the electrical code applicable to the region.

## GROUNDING INSTRUCTIONS

### For a permanently connected appliance:

This appliance must be connected to grounded metal, a permanent wiring system, or an equipment-grounding conductor must be run with the circuit conductors and connected to the equipment-grounding terminal or lead on the appliance.

The dishwasher is very heavy. Do not attempt to move or carry a dishwasher alone. Two or more people are needed to move a dishwasher and avoid potential injuries.



If the power cable is damaged, it must be replaced by the manufacturer, a service agent or similarly qualified person in order to avoid a hazard.



Do not touch the power cable with wet hands.



Do not connect another appliance to the same power outlet as the dishwasher.

Make sure to use a new water supply line. Old lines are susceptible to breakage because they become hardened and may cause property damage due to a water leakage.

The dishwasher must be connected to a hot water supply between 120 °F(49 °C)~ 149 °F (65 °C). This temperature range provides the best washing result and shortest cycle time. Temperature should not exceed 149 °F (65 °C), to prevent damage to dishes.

Ensure that the water supplied to the dishwasher does not freeze. Frozen water can damage the hoses, valves, pump, or other components.

Certified residential dishwashers are not intended for licensed food establishments. (NSF/ANSI Standard 184 for Residential Dishwashers)

For a full list of safety information, please refer to the User Manual.

## BEFORE INSTALLING THE DISHWASHER

---



### WARNING



#### Tip-Over Hazard

- Do not use the dishwasher until it is correctly installed.
- Do not push down on an open door.
- Do not place excessive weight on the open door.



#### Electric Shock Hazard

Failure to follow these instructions can result in death, fire, or electric shock:

- Electrically ground the dishwasher
- Connect the ground wire to the green ground connector in the junction box.
- Do not use an extension cord.

To reduce the risk of electric shock, fire, or injury to persons, the installer must ensure that the dishwasher is completely enclosed at the time of installation.

# contents

---

## **PREPARING THE DISHWASHER ENCLOSURE**

5

- 5 Product dimensions
- 5 Cutout dimensions

## **INSTALLING THE DISHWASHER**

6

- 6 STEP 1 Checking the parts and tools
- 8 STEP 2 Selecting the best location for the dishwasher
- 9 STEP 3 Water supply requirements
- 10 STEP 4 Electrical requirements
- 11 STEP 5 Preparing the dishwasher
- 12 STEP 6 Placing the dishwasher and connecting water supply line
- 13 STEP 7 Leveling the dishwasher
- 14 STEP 8 Securing the dishwasher
- 15 STEP 9 Connecting the drain hose
- 17 STEP 10 Wiring connections
- 18 STEP 11 Completing the installation

## **SPECIFICATIONS**

19

# preparing the dishwasher enclosure

## PRODUCT DIMENSIONS

**Side view**  
(DMT800 series/  
DMT400 series)

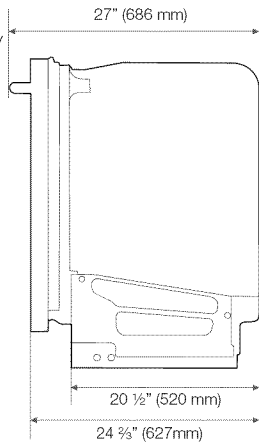

**Rear view**

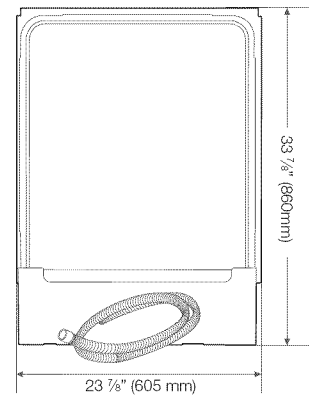

**Side view**  
(DMT700 series)

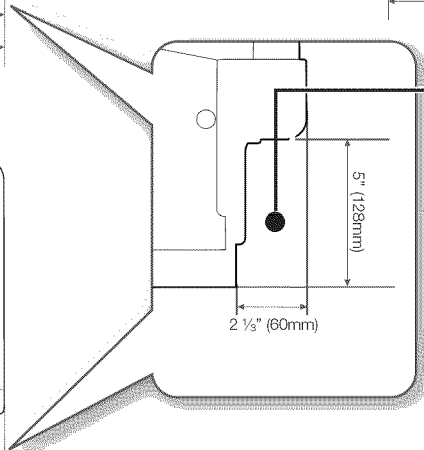
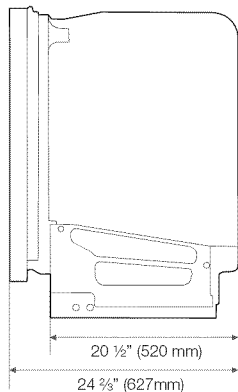

The water supply line, power cable and drain hose should go through this space.

## CUTOUT DIMENSIONS

 This dishwasher is designed to be enclosed on top and on both sides by a standard residential kitchen unit.

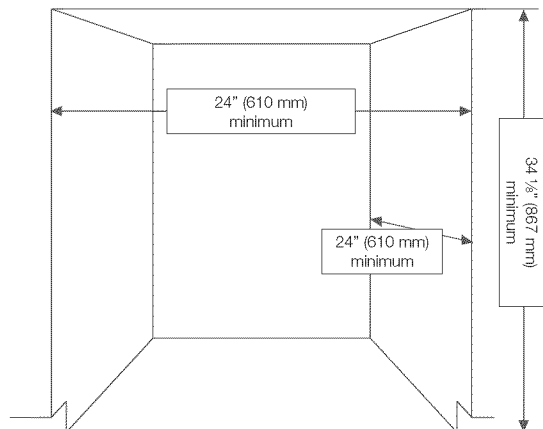

# installing the dishwasher





Be sure that you or your installer follow these instructions closely so that the new dishwasher works properly and that you're not at risk of injury when washing dishes.

## STEP 1 CHECKING THE PARTS AND TOOLS







Before starting on the installation, prepare all the necessary tools and parts required to install the dishwasher. This will save installation time and simplify the installation process.

### Parts required

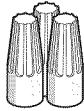
#### Provided

			
2 Installation Brackets	2 Flat Head Screws (For the installation bracket)	2 Screws (for the side walls)	2 Screws (for the kick plate)

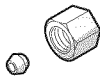
#### Not provided

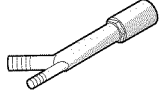
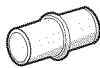
			
Power cable	Twist on wire connector	Strain relief	Electrical tape & Standard duct tape
			
Water supply line	90° Elbow(3/8")	Tube fittings	Teflon® tape or sealing compound
			
Hose clamp	Air gap	Rubber connector	

 For the water supply line - Flexible stainless steel braided supply line or Minimum 3/8" O.D. copper tubing with compression fitting. (Plastic tubing is not recommended)

A 90° elbow with 3/8" N.P.T. external pipe threads on one end, and sized to fit your water supply line (copper tubing/compression fitting, or braided hose) on the other

## Tools required

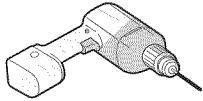

Electric drill

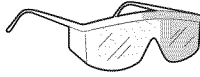

Safety glasses



Gloves

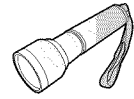

Flashlight



Adjustable wrench

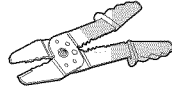

Wire stripper

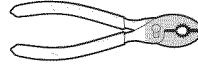

Pliers

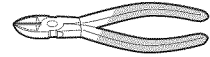

Nipper

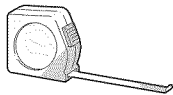

Tape measure



Pencil



Phillips screwdriver



Flat screwdriver

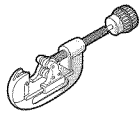

Tubing cutter

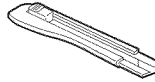

Cutting knife

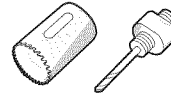

Hole cutter

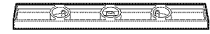

Level



Torx t20

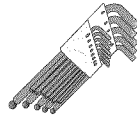

Hex L-wrench

# installing the dishwasher



## **New installation**

If the dishwasher is a new installation, most of the installation work must be done before the dishwasher is moved into place.





## **Replacement**

If the dishwasher is replacing an old dishwasher, the connections for the dishwasher being replaced must be checked for compatibility with the new dishwasher and replaced as necessary.

## **STEP 2 SELECTING THE BEST LOCATION FOR THE DISHWASHER**

The following criteria are important to ensure the best location for the dishwasher.

1. Select a location with a solid floor that is able to support the weight of the dishwasher.
2. Select a location near a sink with easy access to the water supply, drain, and electrical outlet.
  -  For the drain to operate properly, the dishwasher should be installed within 9.8 ft (3 m) of the sink.
3. Select a location that allows you to easily load your dishes into the dishwasher.
4. Select a location with sufficient space for the dishwasher door to open easily and with enough space between the dishwasher and the wall (at least 0.1 in (2 mm)).
-  If the dishwasher is installed in a corner, ensure that there is a clearance of more than 2 in. (50 mm) from the wall.
5. Cut a hole into the side of the wall where the sink is as shown in Figure 1 below.
6. If there is an additional level in the sink cabinet and it is higher than the connections on the dishwasher, make two holes as shown in Figure 1-2.
7. The wall at the back must be free of obstructions.

<Figure 1-1>

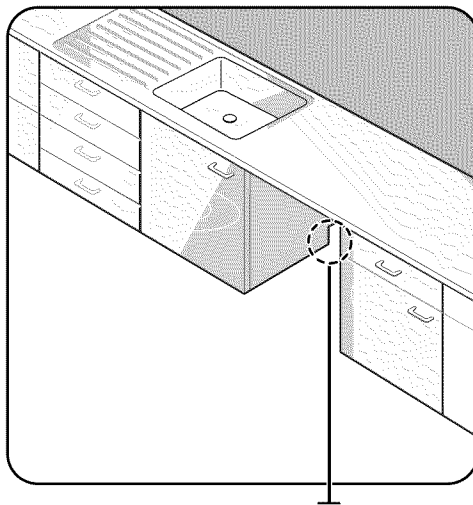

The hole for the water supply line, drain hose and power cables.

<Figure 1-2>

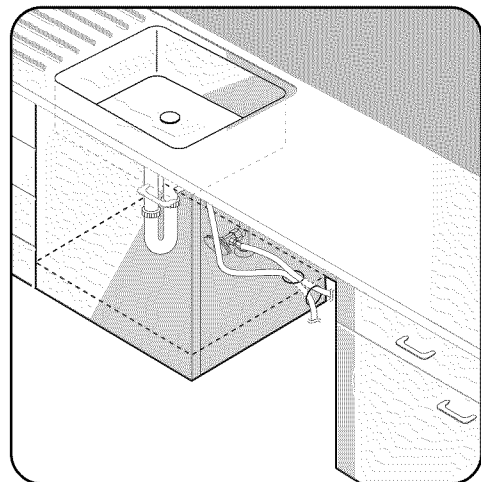

## STEP 3 WATER SUPPLY REQUIREMENTS

- The hot water supply line pressure must be between 20~120 psi (140~830 kPa).
- Adjust the water heater to deliver water between 120 °F(49 °C)~ 149 °F (65 °C).
  1. The dishwasher must be connected to a hot water supply between 120 °F(49 °C)~ 149 °F (65 °C). This temperature range provides the best washing result and shortest cycle time. Temperature should not exceed 149 °F (65 °C), to prevent damage to dishes.
  2. Ensure that the water supply valve is turned off before connecting the water supply line to the dishwasher.
  3. Seal the water supply line connections using teflon tape or sealing compound to stop any water leakage.
  4. The water supply line should be placed in the channels at the base of the dishwasher as shown in Figure 2. Do not place the dishwasher on the water supply line.
  5. The drain hose connected to the dishwasher must be run through the hole in the side wall so it can be connected to the drain outlet of the sink. Ensure that there is nothing on the drain hose and be careful not to tear it during the installation process.

<Figure 2>

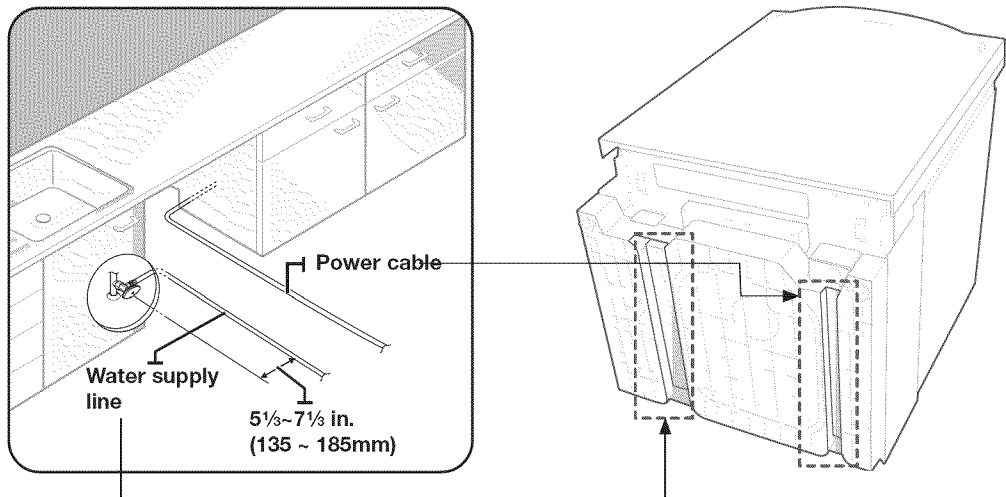

# installing the dishwasher

## STEP 4 ELECTRICAL REQUIREMENTS

The electrical requirements for the dishwasher are as follows:

- In the United States, in accordance with the National Electric Code/State and Municipal codes and/or local codes.
- In Canada, in accordance with the Canadian Electric Code C22.1-latest edition/Provincial and Municipal codes and/or local codes.
- For cable direct connections.
  - Use flexible, armored or non-metallic sheathed, copper wire with grounding wire that meets the wiring requirements for your local codes and ordinances.
  - Use strain relief method provided with wiring junction box or install a U.L.-listed/CSA-certified clamp connector to the wiring junction box. If using conduit, use a U.L.-listed/CSA-certified conduit connector.
- For power cord connections
  - Power supply cord must plug into a mating three prong, grounded outlet, located in the cabinet next to the dishwasher opening. Outlet must meet your local codes and ordinances. Use a U.L.-listed/CSA-certified power cord kit.
    1. The dishwasher must be connected with the correct rated voltage supply marked on the rating plate of the unit.
    2. Ensure that the Circuit Breaker connected to the dishwasher is off.
    3. The power cable must not extend more than 4 ft (1.2 m) from the side of the dishwasher.
    4. Check with a qualified electrician or serviceman if you are unsure whether the dishwasher is properly connected.
    5. Do not connect another appliance to the same power outlet as the dishwasher.
    6. Before connecting the power cable to the dishwasher, ensure that there are no electrical hazards (which may result in fire, explosion, electric shock, or personal injury).
    7. The power cable should go through the channels at the base of the dishwasher as shown in Figure 3.

<Figure 3>

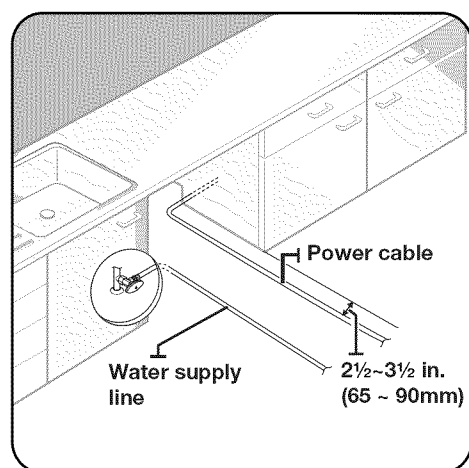

## STEP 5 PREPARING THE DISHWASHER

1. Ensure that the circuit breaker and water supply valve are turned off before proceeding with the following steps.
2. Ensure that the kick plate is placed on the cushion front, and make sure to keep it.

**CAUTION** When pull in/out or lay down the dishwasher for installing, make sure to adjust bottom legs's height. It should be small to block the leg's breakage.

3. Install the 90° elbow at the Inlet valve. When inserting the elbow into the Inlet valve, use Teflon tape or sealing compound to prevent water leakage. To prevent blocking the inlet valve, make sure that the Teflon tape or sealing compound does not enter the valve.
4. Remove the junction box cover located at the bottom right at the front of the dishwasher using a screwdriver and then install the strain relief. Make sure to keep the junction box cover you removed as it is used in STEP 10.
5. When the countertop is made of wood or a material that is not damaged by drilling, locate the two (2) installation brackets that were supplied with the dishwasher. (Refer to the figures in STEP 8.)

<Figure 4>

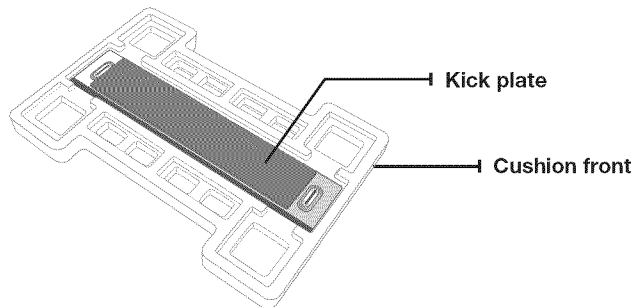

<Figure 5>

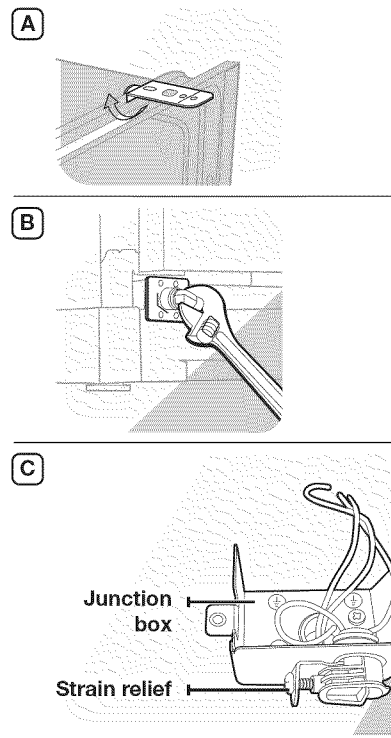
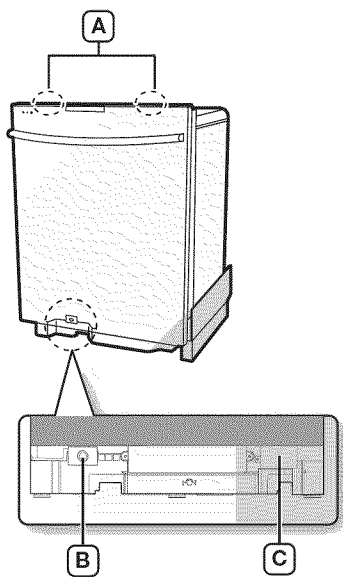

# installing the dishwasher

## STEP 6 PLACING THE DISHWASHER AND CONNECTING WATER SUPPLY LINE

1. Adjust the three leveling legs at the bottom of the dishwasher after measuring the height of the cabinet opening from under the countertop to the floor. (Refer to the figures in STEP 7.)
2. Locate the water supply line for connecting the inlet valve on the left and the power cable for connecting the junction box on the right.
3. Place the dishwasher so that the water supply line and the power cable are located in the channels at the base of the dishwasher. Use standard duct tape or cable tie to secure the water line and electrical cable to their adjacent channels in the base. It can prevent the squeeze of the water line and electrical cable when placing the dishwasher.
4. Pull the drain hose through the hole in the side wall to the sink.
5. Slide the dishwasher carefully into the installation space.
6. Connect the water supply line into the elbow joint.

**CAUTION** Do not place the dishwasher on the water supply line, drain hose or power cable. Also, make sure they are not folded or twisted.

<Figure 6>

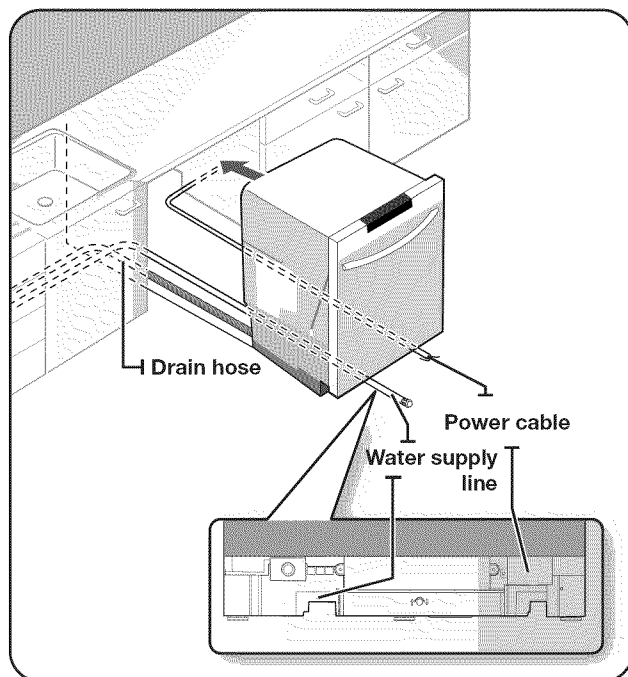

<Figure 7>

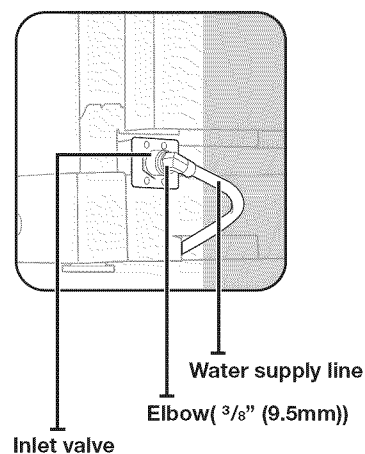

## STEP 7 LEVELING THE DISHWASHER

1. Open the door and place the level against the top of the tub from inside and check whether the dishwasher is level. If it is not level, rotate the leveling legs at the bottom front of the dishwasher until the dishwasher is level.

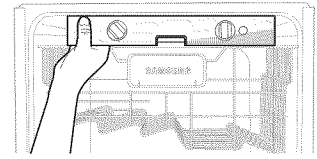

2. Check whether the dishwasher is upright (perpendicular), as shown in the figure to the right.

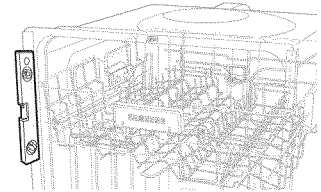

3. Open the door of the dishwasher and check whether both the tub and door clearances are correct. If not, rotate the leveling legs at the bottom front of the dishwasher.

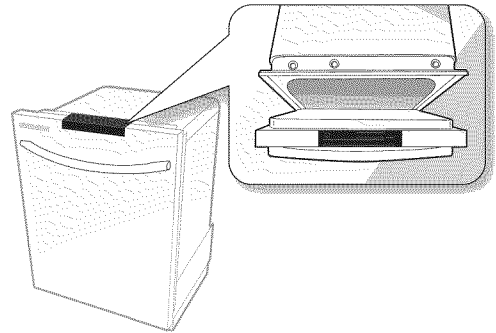

- ⚠ If the leveling legs are rotated to the left (counter clockwise), they are loosened and the front of the dishwasher is raised. If they are rotated to the right (clockwise), they are tightened and the front of the dishwasher is lowered.

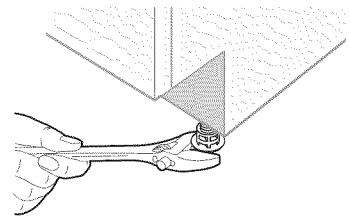

- ⚠ To adjust the height of a rear leg, turn the Hexbolt (at the front of the base) to the left to raise the back of the dishwasher using the proper tool (Hex L-wrench or similar tool).

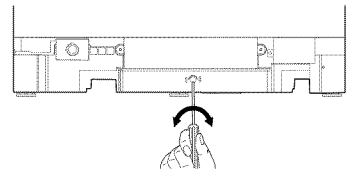

- ⚠ **CAUTION** When pull out or lay down the dishwasher for installing, make sure to adjust bottom leg's height. It should be tightened to block the leg's breakage.

# installing the dishwasher

## STEP 8 SECURING THE DISHWASHER

The dishwasher should be fixed to the countertop or side walls for additional stability and safety.

1. When the countertop is made of wood or the material will not be damaged by drilling, follow the instructions in **2-1** below.

When the countertop is made of granite, marble or any other kind of material that can be damaged by drilling, follow the instructions in **2-2** below.

- 2-1.** Check to connect the Installation brackets to the front top of the dishwasher as shown in Figure 8. (If the Brackets are exposed under the countertop, cut them using a tool as shown in Figure 8. Be careful that you are not hurt by the cutting plane.) Attach the dishwasher to the countertop by fastening the screw through the hole.
- 2-2.** Open the door and remove the tub spacer caps on both sides of the tub. Insert the screws into both sides of the tub except for the tub spacer cap and secure the dishwasher to the side walls by fastening them as shown in Figure 9. At this time, fasten the screws and ensure that the tub is not distorted. After fastening the screws, place the tub spacer caps into original location of the dishwasher.

- The screws or tub spacer cap may fall into the dishwasher while you are working with the door open. Cover the interior of the dishwasher with a towel to prevent any screws from falling into the dishwasher. If any foreign items such as a screw get into the dishwasher, it may cause noise, an abnormal operation, damage, or a product malfunction.
- Use a magnetic screwdriver to help prevent screws from falling into the dishwasher.
- If a foreign item such as a screw gets into the dishwasher and you are unable to remove it, it needs to be disassembled. Contact a qualified service technician for this.

<Figure 8>

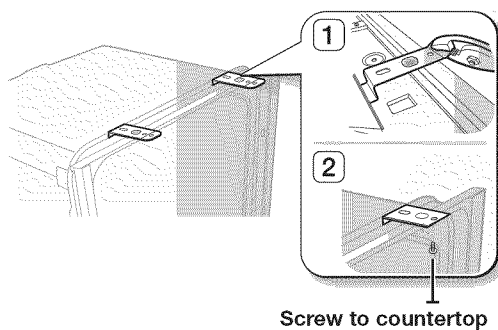

<Figure 9>

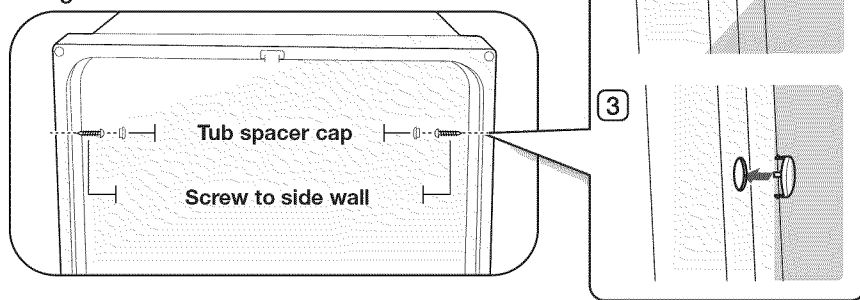

## STEP 9 CONNECTING THE DRAIN HOSE

1. Check the parts on the sink to which the drain hose is connected.
2. There are several ways to insert the drain hose into the drain hose connector of the sink, as shown in the following figures. Connecting the drain outlet must be done in accordance with the water pipe installation regulations in your region.

<Figure 10>

Case 1. Without disposal

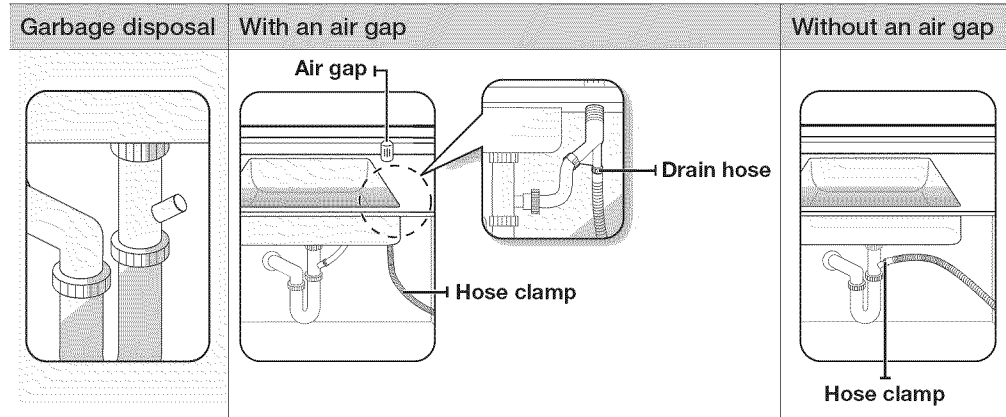

Case 2. With disposal

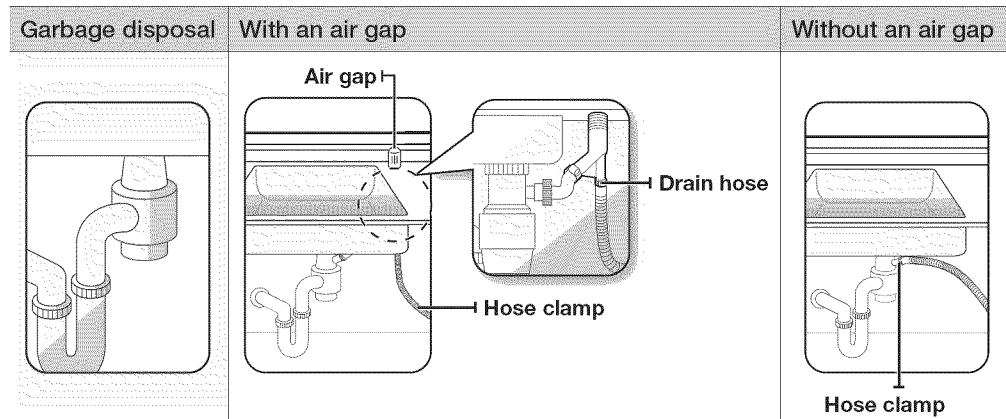

# installing the dishwasher

3. Check the size of the sink's drain hose connector. If needed, cut the drain hose so its end fits into the sink connector (1/2 in., 3/4 in. or 1 in. - as shown in the Figure below). If the end of the drain hose does not fit into the drain hose connector of the sink, use an adaptor purchasable at a plumbing/hardware supply store.
4. When connecting the drain hose, make sure to fasten it using a hose clamp. Failing to do so may cause water leakage.
5. If there is no air gap, make sure to hang the middle of the drain hose in a high location to prevent backflow (see the figure below).

**CAUTION** Be careful when cutting off the end of the drain hose as there is a risk of injury. Clean around the sink's drain connection so that it does not damage the hose. Check for any foreign items in the drain hose and remove them.

<Figure 11>

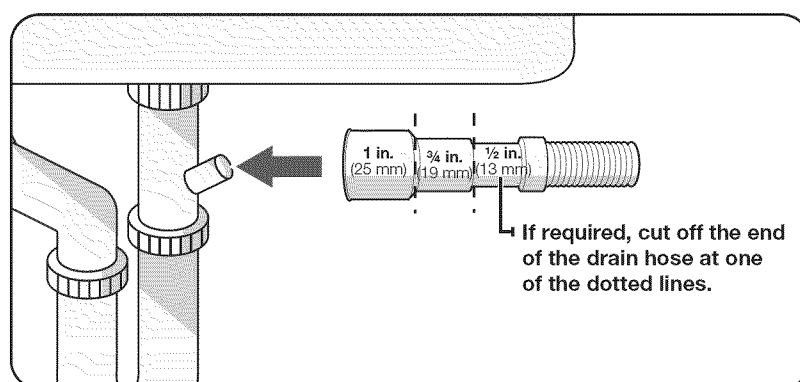

<Figure 12>

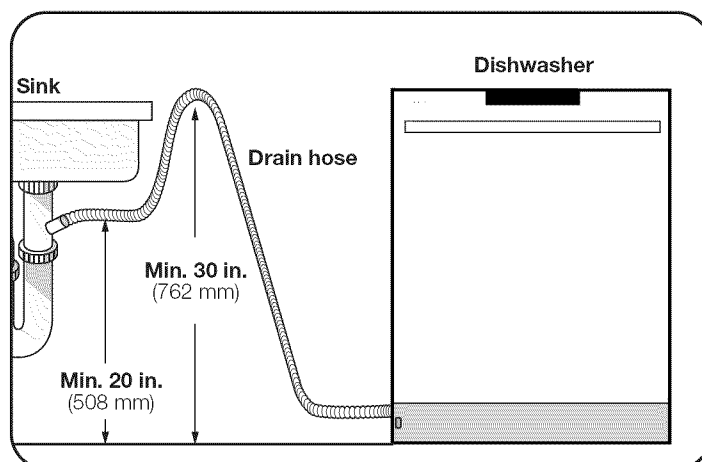

## STEP 10 WIRING CONNECTIONS

1. Before connecting the power cable to the dishwasher, make sure to turn off the circuit breaker.
2. Check to remove the junction box cover located at the bottom right at the front of the dishwasher. You will find three power wires from the dishwasher including the grounding line.
3. Connect the power cable to the dishwasher.  
Twist and connect each wire using wire connectors. When using wire connectors, insert each wire as shown in Figure 14 and rotate the wire connector.
4. Recheck whether the power cable is connected correctly.  
(Each colored wire should be connected to its opposite wire of the same color. White should be connected to white, black to black, and green to green.)
5. Replace the junction box cover on the dishwasher.

<Figure 13>

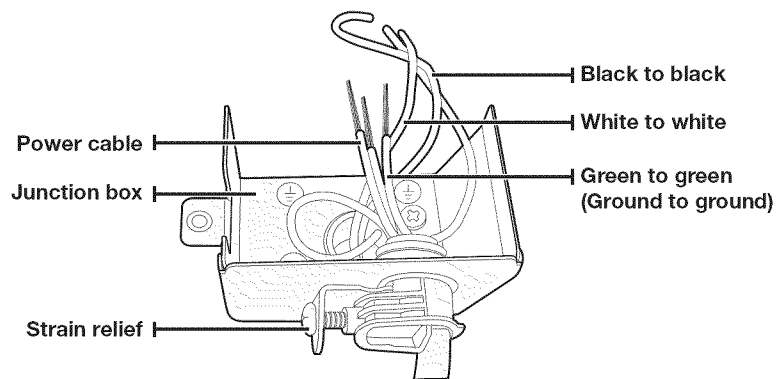

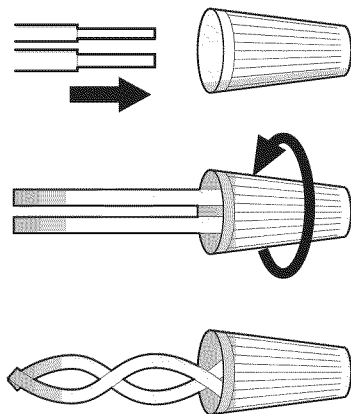

<Figure 14>



# installing the dishwasher

## STEP 11 COMPLETING THE INSTALLATION

1. Open the door and remove all foam, paper packaging and unnecessary parts.
  2. Turn on the circuit breaker turned off before beginning the installation.
  3. Open the water supply valve to supply water to the dishwasher.
  4. Turn on the dishwasher, and select and run a cycle.
-  Check whether the power turns on correctly or whether there is any water leakage while the dishwasher is operating. If no errors occur while it is operating, turn off the dishwasher and proceed with the following. If an error has occurred, turn off the dishwasher, close the water supply valve and refer to the user manual or contact a service center 1-800-SAMSUNG (726-7864).
-  **CAUTION** Make sure to check water leakage from both ends of water supply line and drain hose connector.
5. Check that the kick plate gasket is on the bottom of the kick plate where is placed on the cushion front. To install the kick plate, refer to the figure below.

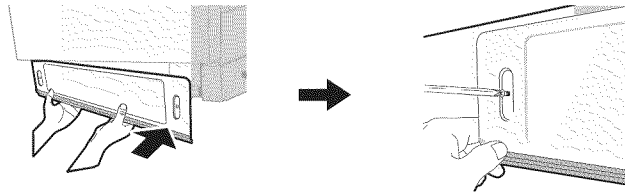

# specifications

<b>Power supply</b>	120 V, 60 Hz AC only
<b>Water pressure</b>	20 ~ 120 psi (140 ~ 830 kPa)
<b>Dimensions (Width×Depth×Height)</b>	23 <sup>7</sup> / <sub>8</sub> x 24 <sup>3</sup> / <sub>4</sub> x 33 <sup>7</sup> / <sub>8</sub> in. (605 x 627 x 860 mm)
<b>Nominal inlet water temperature</b>	120 °F (49 °C)

-  Specifications are subject to change without notice for quality improvement purposes.  
The actual appearance of the dishwasher may differ from the illustrations in this manual.



QUESTIONS OR COMMENTS?

COUNTRY	CALL	OR VISIT US ONLINE AT
USA	1-800-SAMSUNG (726-7864)	<a href="http://www.samsung.com">www.samsung.com</a>
CANADA	1-800-SAMSUNG (726-7864)	<a href="http://www.samsung.com">www.samsung.com</a>

Code No.: DD68-00046A\_EN